

# Walker Grove Landscape Plan Preliminary Review Package

Matthews Road,  
Neill's Creek Township, NC 27546

\*Bid Review Set - 4.20.2021\*

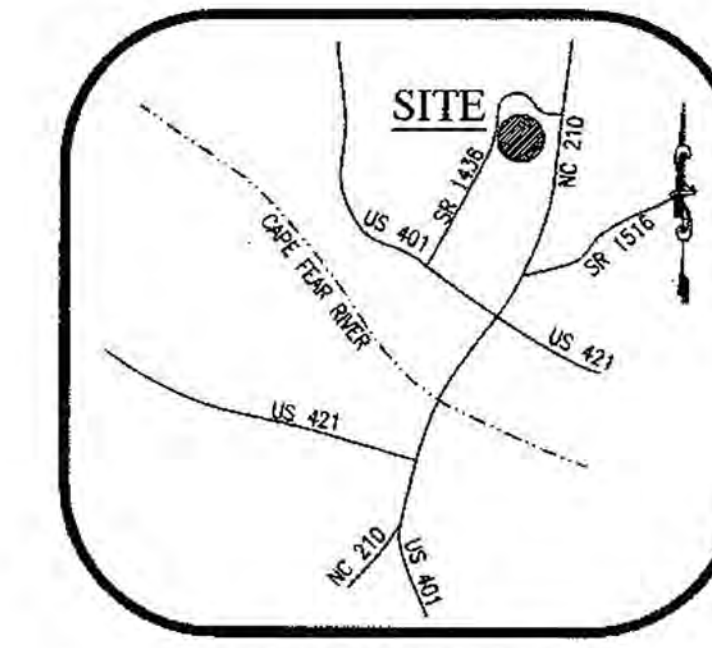

VICINITY MAP

PROJECT NAME: 0100  
PROJECT NUMBER: 0100  
FILE: \*DWG  
ISSUED DATE: 2.5.2021  
REVISIONS: 2.8.2021

NOTATIONS:  
Contractor(s) to verify all site conditions, layouts, dimensions, grades, specifications and material selections. Drawings for conceptual design and layout purposes. Adjustments may be needed in regards to grades and exact layout.



inspire. enhance. create.

wilburn | associates

landscape | design  
golf | build  
manage

T: 1.704.942.5667  
E: office@warchitectural.com  
W: www.warchitectural.com  
M: PO Box 1509, Cornelius, NC 28031

TrueHomes  
IT'S ALL ABOUT U

T: 1.704.238.1229  
M: 2656 Brekonridge Centre Dr. Suite 104,  
Monroe, NC 28110

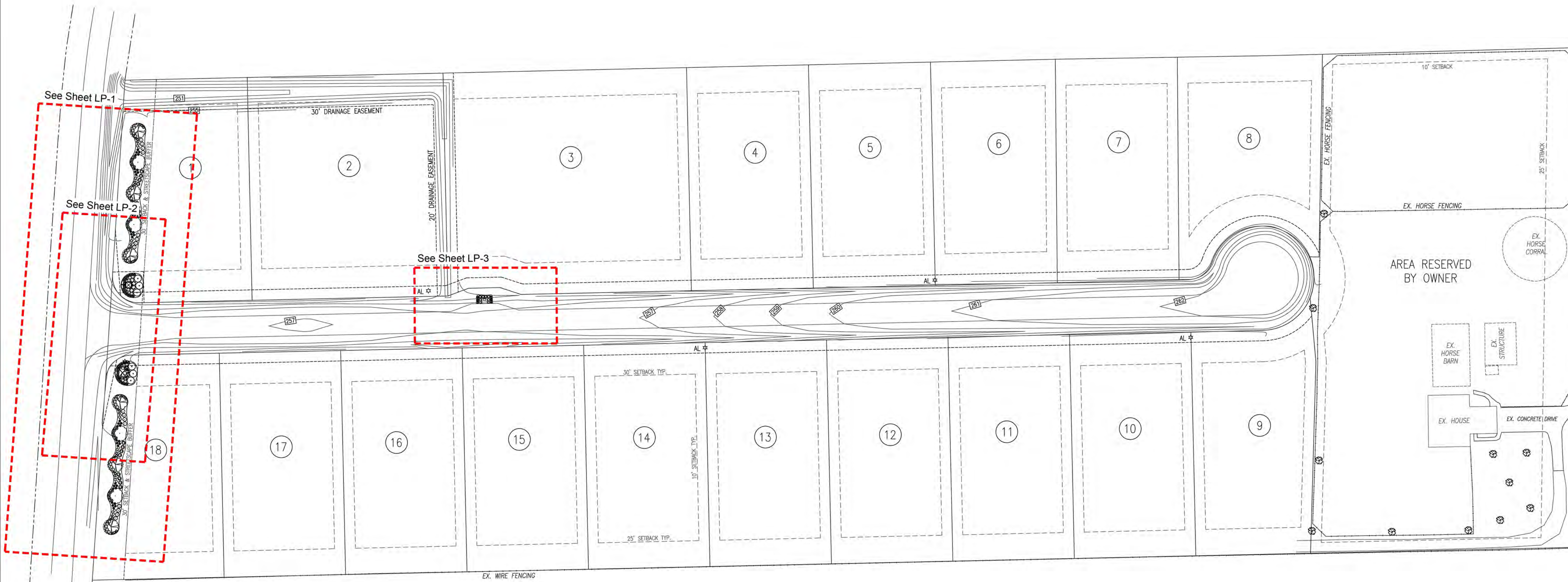

### INDEX OF DRAWINGS

- CS-1 COVER SHEET
- EX-1 COMMUNITY ANALYSIS PLAN
- LP-1 COMMUNITY ROAD FRONTAGE PLAN
- LP-2 COMMUNITY ENTRANCE PLAN + ELEVATION
- LP-3 CBU LANDSCAPE PLAN
- LP-4 SEED/SOD PLAN
- DS-3 MONUMENT DETAIL
- DS-4 MONUMENT DETAIL

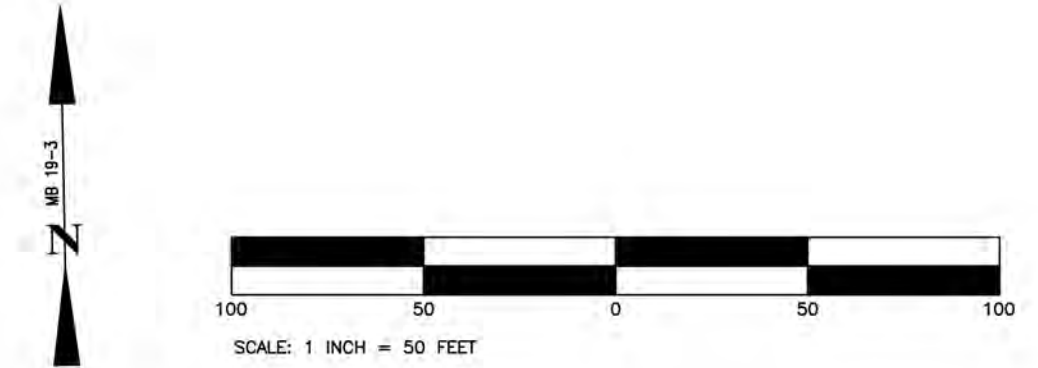

SCALE: 1" = 50' - 0"

SHEET TITLE:  
Cover Sheet

SHEET No: 1 OF

CS-1

Walker Grove  
Matthew's Road  
Neill's Creek Township, NC.



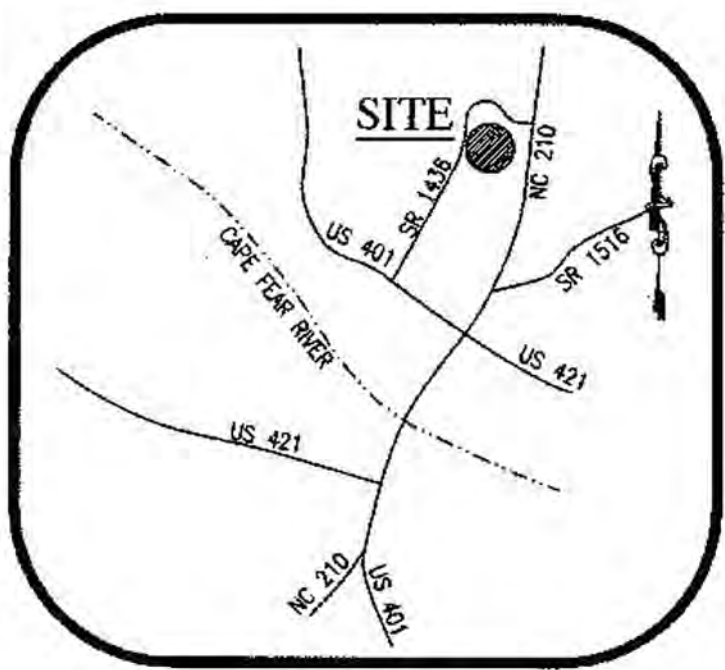

VICINITY  
NTS

Road Buffer (Per Municipal Code)

30'x30' Sign Easement

CBU Location

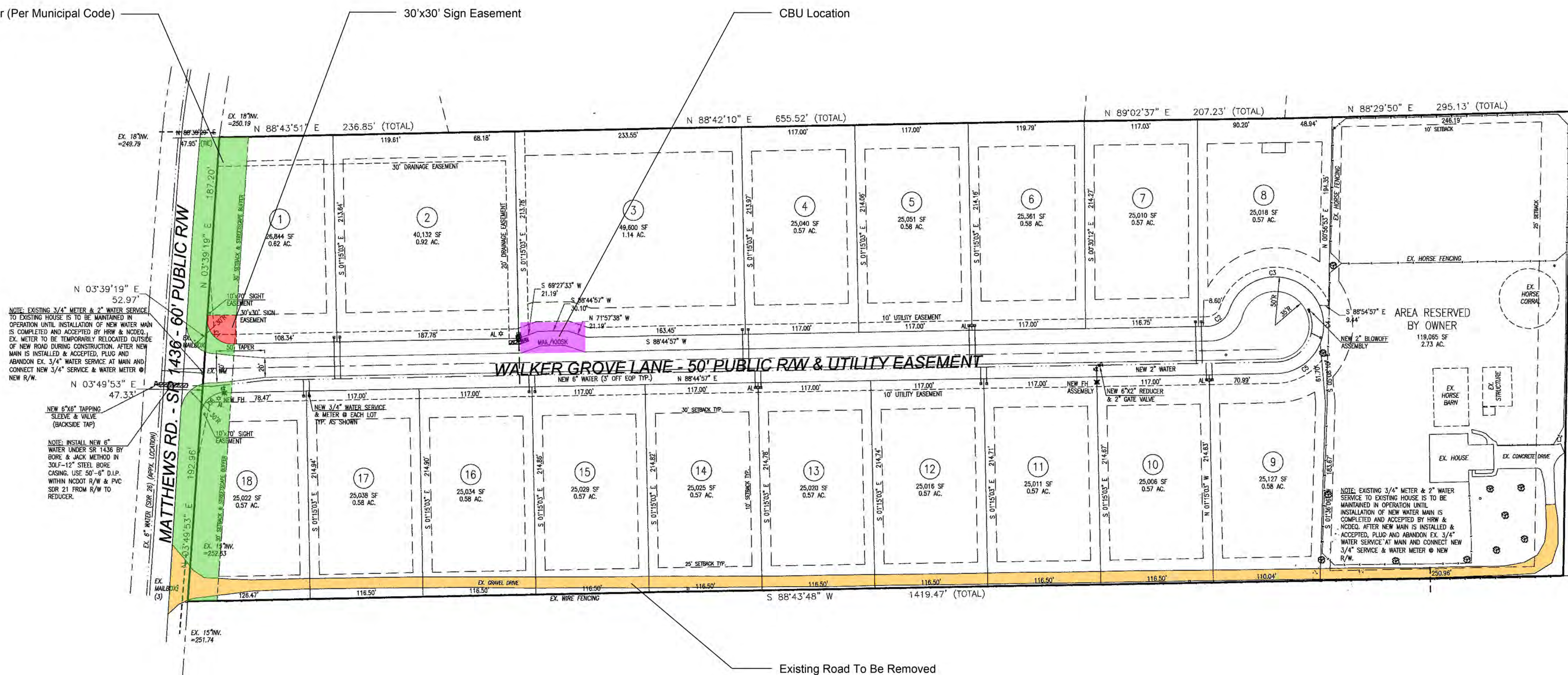

NOTE: EXISTING 3/4" METER & 2" WATER SERVICE TO EXISTING HOUSE IS TO BE MAINTAINED IN OPERATION UNTIL INSTALLATION OF NEW WATER MAIN IS COMPLETED AND ACCEPTED BY HW & NCDOT. EX. METER TO BE TEMPORARILY RELOCATED OUTSIDE OF NEW ROAD DURING CONSTRUCTION. AFTER NEW MAIN IS INSTALLED & ACCEPTED, PLUG AND ABANDON EX. 3/4" WATER SERVICE AT MAIN AND CONNECT NEW 3/4" SERVICE & WATER METER @ NEW R/W.

NOTE: INSTALL NEW 6" WATER UNDER SR 1436 BY BORE & JACK METHOD IN 30'-12" STEEL BORE CASING. USE 50'-8" O.D.P. WITHIN NCDOT R/W & PVC SR 21 FROM R/W TO REDUCER.

NOTE: EXISTING 3/4" METER & 2" WATER SERVICE TO EXISTING HOUSE IS TO BE MAINTAINED IN OPERATION UNTIL INSTALLATION OF NEW WATER MAIN IS COMPLETED AND ACCEPTED BY HW & NCDOT. AFTER NEW MAIN IS INSTALLED & ACCEPTED, PLUG AND ABANDON EX. 3/4" WATER SERVICE AT MAIN AND CONNECT NEW 3/4" SERVICE & WATER METER @ NEW R/W.

**Notation:**

\* No Sales Corridor, community to utilize Arlie Meadows Sale Corridor.

PROJECT NAME: 0100  
PROJECT NUMBER: 0100  
FILE: \*DWG  
ISSUED DATE: 2.5.2021  
REVISIONS:  
△

NOTATIONS:  
Contractor(s) to verify all site conditions, layouts, dimensions, grades, specifications and material selections. Drawings for conceptual design and layout purposes. Adjustments may be needed in regards to grades and exact layout.



inspire. enhance. create.

wilburn | associates

landscape design  
golf build  
manage

T: 1.704.942.5667  
E: office@warchitectural.com  
W: www.warchitectural.com  
M: PO Box 1509, Cornelius, NC 28031



T: 1.704.238.1229  
M: 2656 Brekonridge Centre Dr. Suite 104,  
Monroe, NC 28110

**Walker Grove**  
Matthew's Road  
Neill's Creek Township, NC.

SCALE: 1" = 60' - 0"

SHEET TITLE:  
**Community  
Analysis  
Plan**

SHEET No: 1 OF

**EX-1**

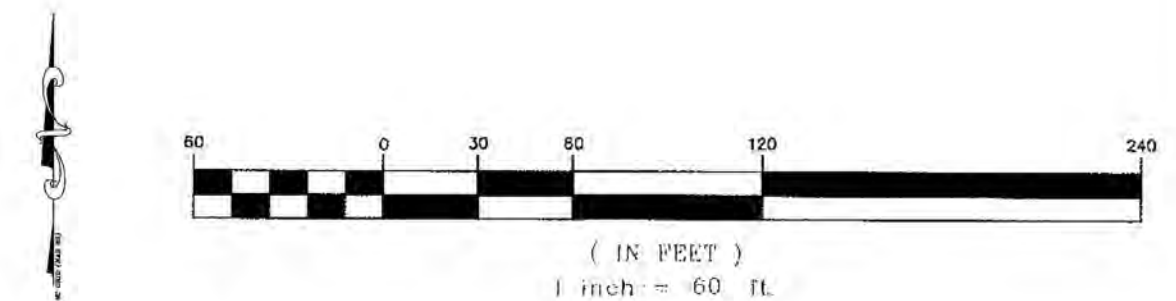



# PLANT SCHEDULE - Entrance Monument

To Be Reviewed Onsite With Architect

SYB	QTY	PLANT TYPE	SIZE
○	6	Alta Magnolia	12'-14', B+B
⊗	1	Chinese Fringe Tree: ALT Plum Tree	3" Cal, 12'-14' Ht. Min.
⊙	8	Loropetalum	7 Gal
○	12	Aureo Marginata Euonymus	5 Gal
⊙	30	Variegated Jazz Hand Loropetalum	3 Gal
⊙	16	Dwarf Ornamental Grass	3 Gal
	24 SF	Seasonal Color	24 SF
	7.5 CY	Mulch	820 SQFT

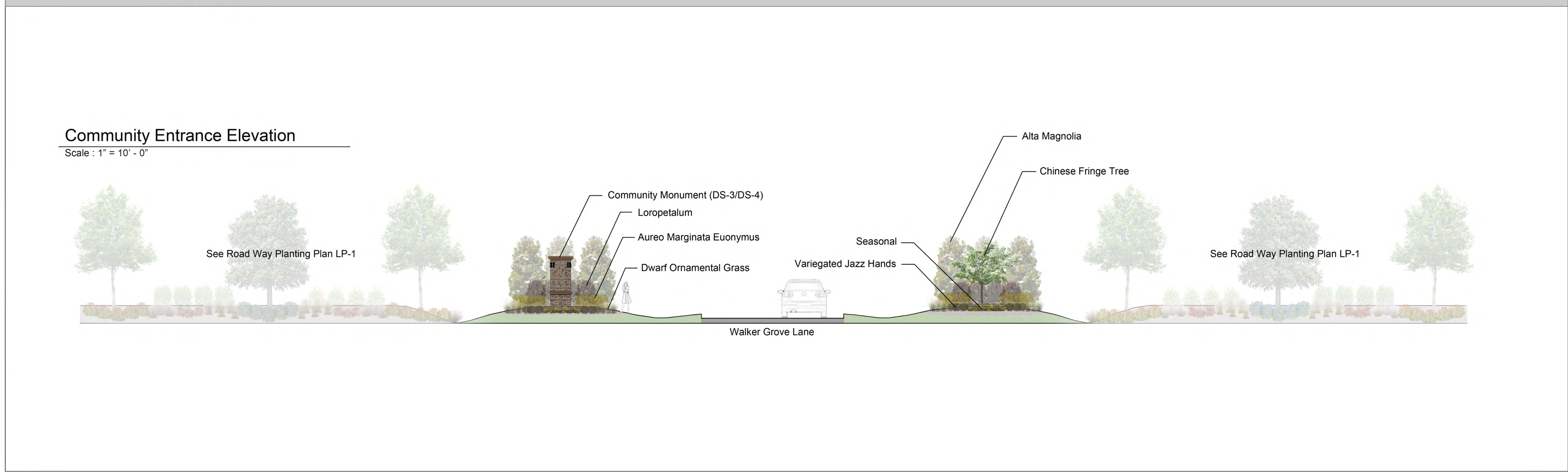
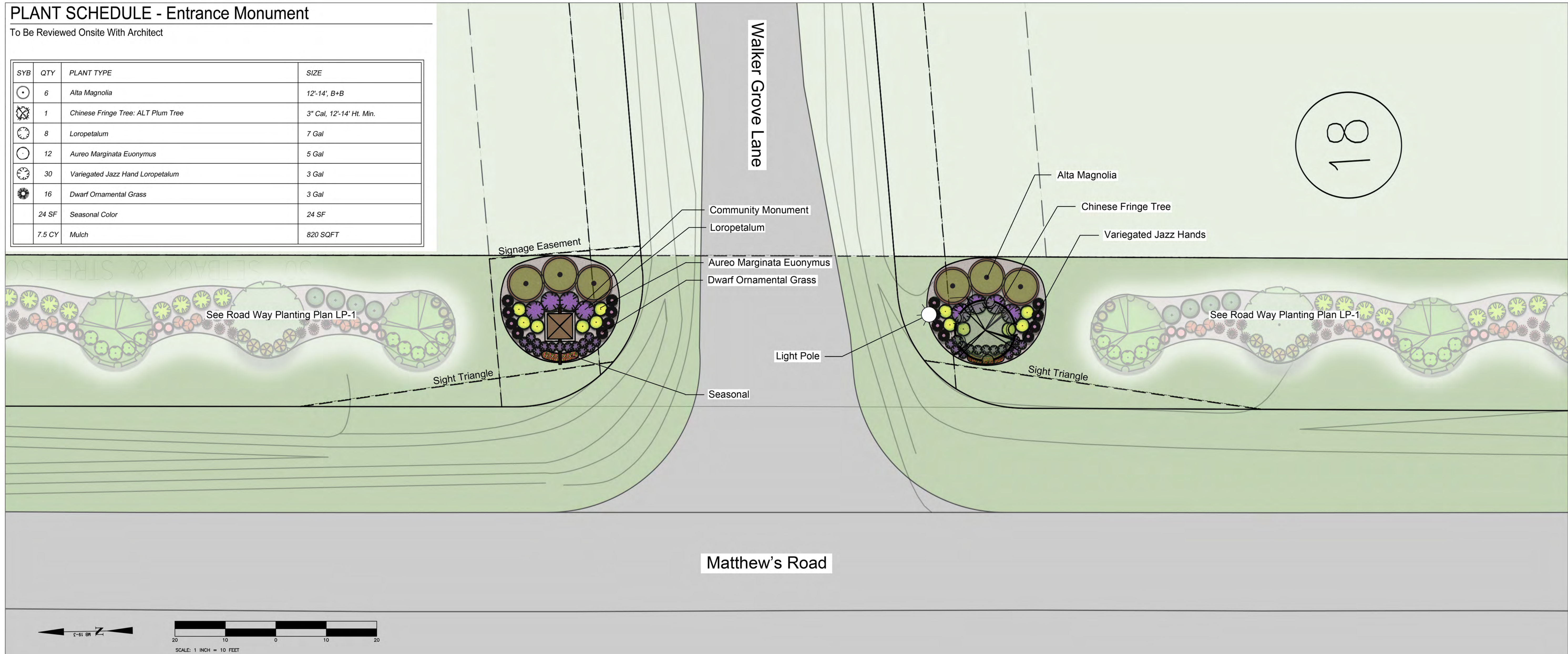

PROJECT NAME: 0100  
 PROJECT NUMBER: 0100  
 FILE: \*DWG  
 ISSUED DATE: 2.5.2021  
 REVISIONS:  
 △

NOTATIONS:  
 Contractor(s) to verify all site conditions, layouts, dimensions, grades, specifications and material selections. Drawings for conceptual design and layout purposes. Adjustments may be needed in regards to grades and exact layout.



wilburn | associates  
 landscape | design  
 golf | build  
 manage  
 T: 1.704.942.5667  
 E: office@warchitectural.com  
 W: www.warchitectural.com  
 M: PO Box 1509, Cornelius, NC 28031



T: 1.704.238.1229  
 M: 2656 Brekonridge Centre Dr. Suite 104,  
 Monroe, NC 28110

Walker Grove  
 Matthew's Road  
 Neill's Creek Township, NC.

SCALE: 1" = 10' - 0"

SHEET TITLE:  
 Community Entrance Plan + Elevation

SHEET No: 1 OF

LP-2



**MATERIALS**



**COLUMN MATERIAL**

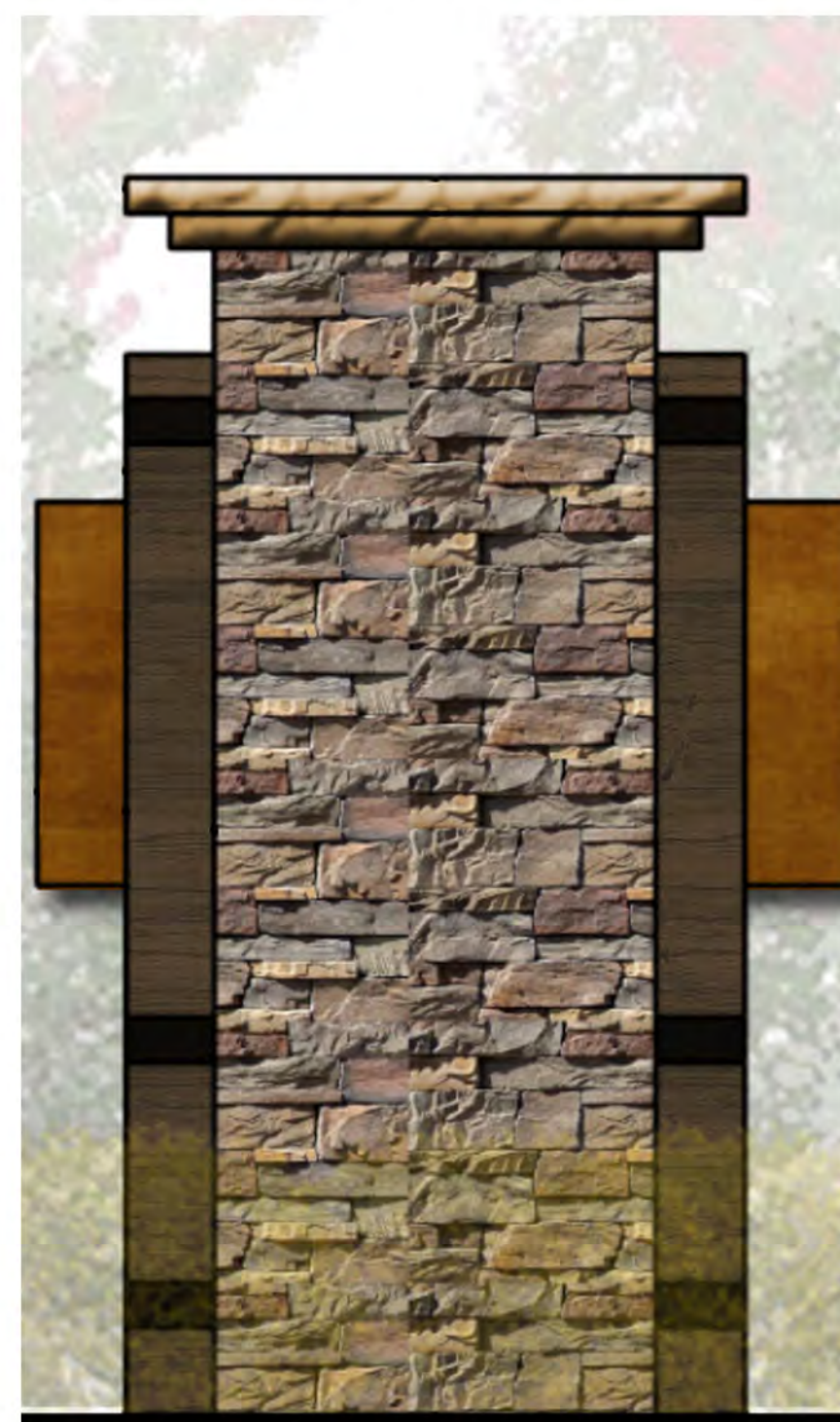

**WOOD ACCENT**



BLACK



RUSTIC



BROWN



FLAGSTONE



PRECAST 1



PRECAST 2



KENTUCKY RUBBLE



BROWN RUSTIC



APPALACHIAN LEDGE

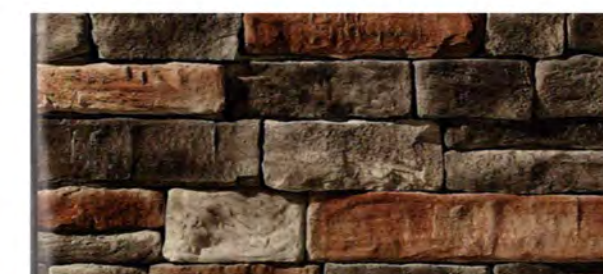

KENTUCKY STACK



KENTUCKY RUSTIC



PENNSYLVANIA STACK

**SIGN DETAIL**



**SIGN/PLACARD MATERIALS**



**LOGO OPTIONS**

**Walker Grove**

Century 731 BT

Walker Grove

CastleTLig

**Walker Grove**

Benguiaat Bk BT

PROJECT NAME: 0100  
 PROJECT NUMBER: 0100  
 FILE: \*DWG  
 ISSUED DATE: 2.5.2021  
 REVISIONS: 2.8.2021  
 △

NOTATIONS:  
 Contractor(s) to verify all site conditions, layouts, dimensions, grades, specifications and material selections. Drawings for conceptual design and layout purposes. Adjustments may be needed in regards to grades and exact layout.



inspire. enhance. create.

**wilburn | associates**

landscape | design  
 golf | build  
 manage

T: 1.704.942.5667  
 E: office@warchitectural.com  
 W: www.warchitectural.com  
 M: PO Box 1509, Cornelius, NC 28031

**TrueHomes**  
 IT'S ALL ABOUT U

T: 1.704.238.1229  
 M: 2656 Brekonridge Centre Dr. Suite 104,  
 Monroe, NC 28110

**Walker Grove**  
 Matthew's Road  
 Neill's Creek Township, NC.

SCALE: NA

SHEET TITLE:

Elements Monument  
 Material Selection  
 Option 2  
 Modification 2

SHEET No: 1 OF

**DS-3**



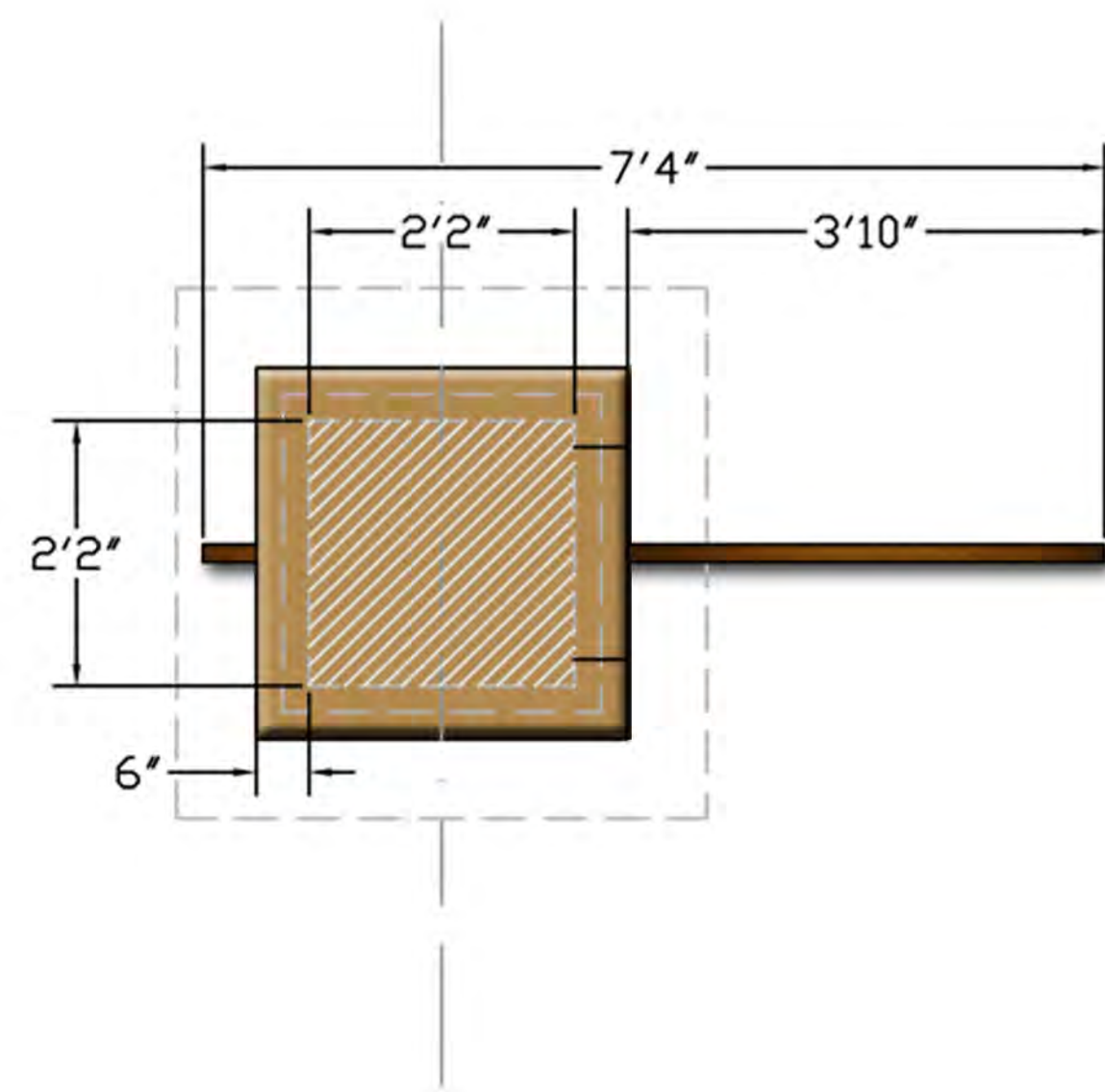

1 Monument Detail  
DET Plan View - Detail

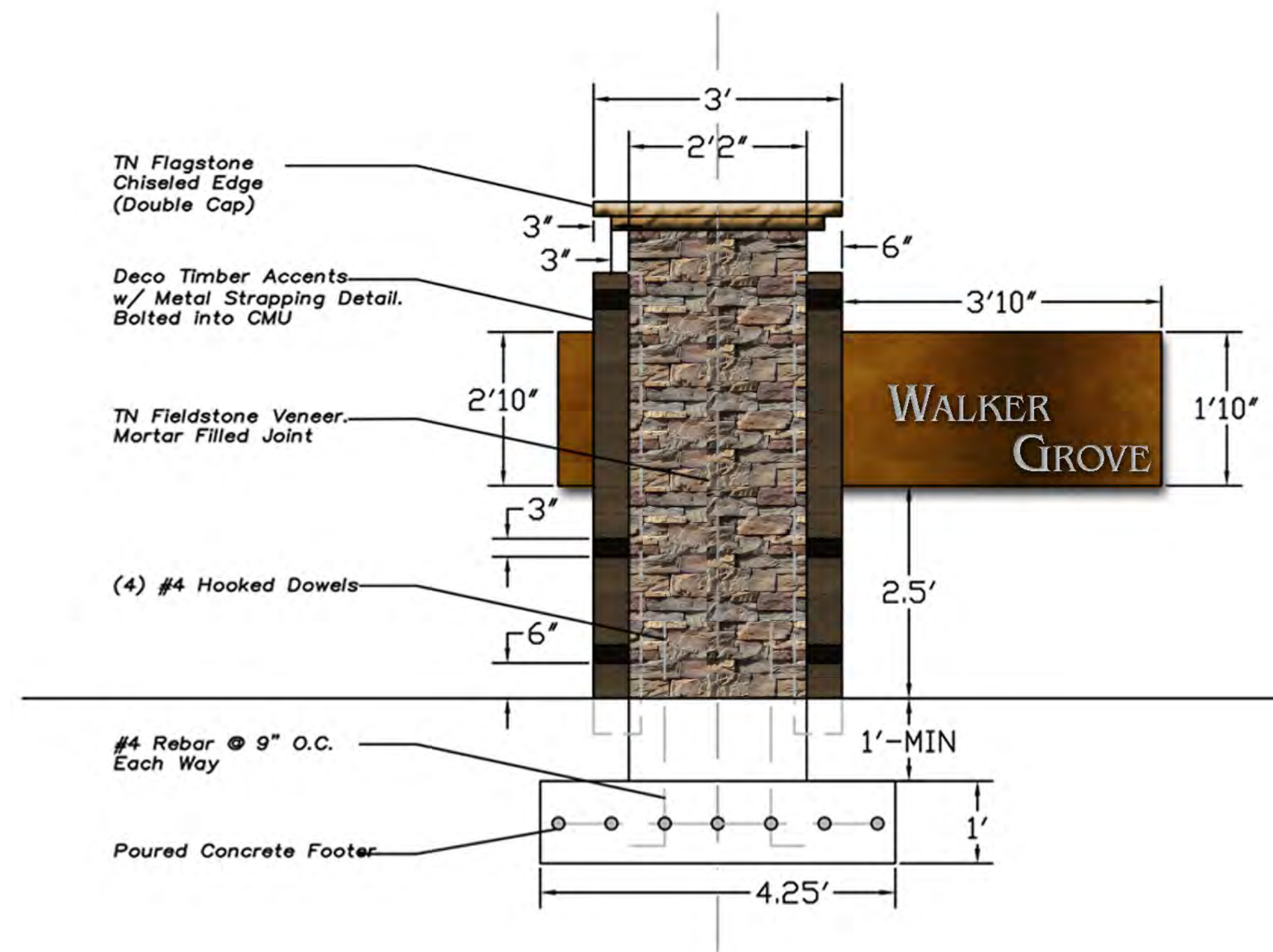

2 Monument Detail  
DET Side Profile - Visualization

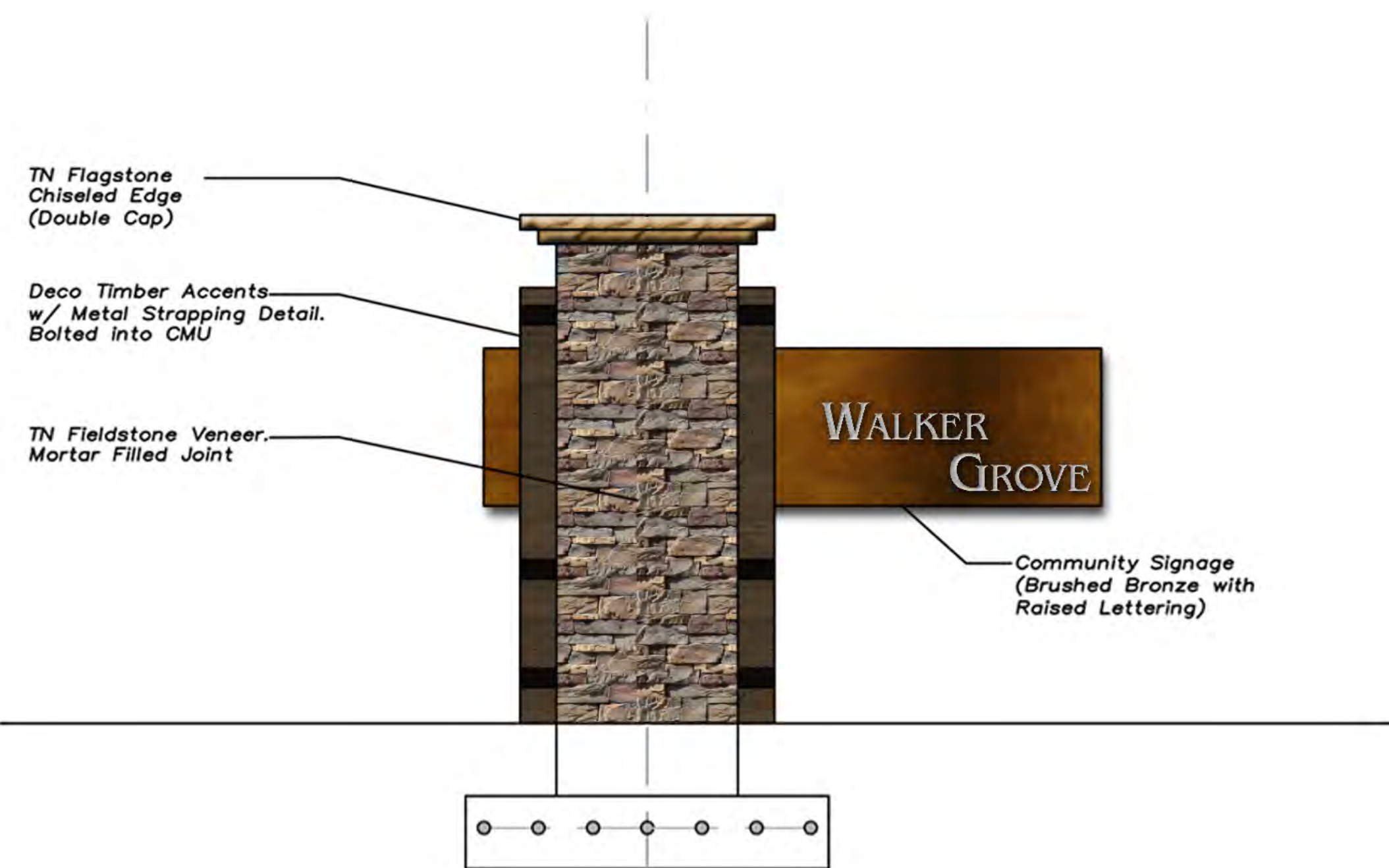

3 Monument Detail  
DET Side Profile - Detail

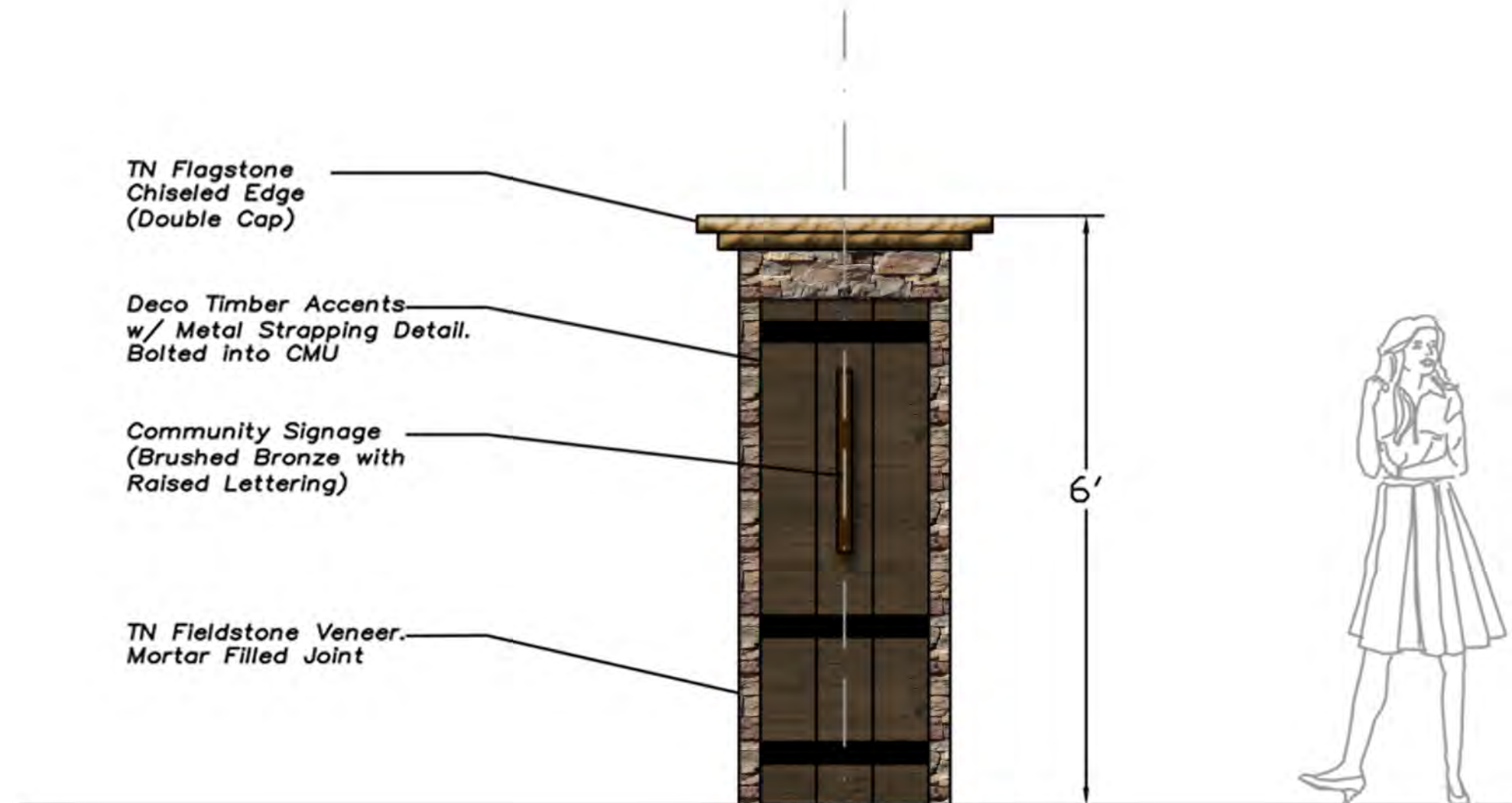

4 Monument Detail  
DET Front Profile - Detail

PROJECT NAME: 0100  
PROJECT NUMBER: 0100  
FILE: \*DWG  
ISSUED DATE: 2.5.2021  
REVISIONS: 2.8.2021  
△

NOTATIONS:  
Contractor(s) to verify all site conditions, layouts, dimensions, grades, specifications and material selections. Drawings for conceptual design and layout purposes. Adjustments may be needed in regards to grades and exact layout.



wilburn | associates

landscape | design  
golf | build  
manage

T: 1.704.942.5667  
E: office@warchitectural.com  
W: www.warchitectural.com  
M: PO Box 1509, Cornelius, NC 28031

TrueHomes  
IT'S ALL ABOUT U

T: 1.704.238.1229  
M: 2656 Brekonridge Centre Dr. Suite 104,  
Monroe, NC 28110

Walker Grove  
Matthew's Road  
Neill's Creek Township, NC.

SCALE: NA

SHEET TITLE:

Elements  
Monument  
Details Option 2  
Modification 2

SHEET No: 1 OF

DS-4