



## Subsurface Wastewater Disposal System Design Packet

**PIN:**

# Table of Contents

## **Project Details**

Contact Information .....	1
Table of contents page .....	2
Introduction Letter .....	3-4
Common Form .....	5-13

## **Site Specifications**

Soils Evaluation .....	14-15
Site Plans .....	16-19

## **Design Specifications**

Initial and Repair System .....	20
---------------------------------	----

## **System Components**

Septic Tank .....	21
Filter Specs .....	22
Nitrification Trench Detail .....	23
Quick 4 Chamber Product Specifications .....	24-25

## **Miscellaneous**

Information for the Contractor .....	26
Insurance Information .....	27-33

# **PAC-ONE, PLLC**

---

## **Subsurface Wastewater Disposal System Design Packet**

Date:

Proposed for a:

-bedroom residential dwelling

Located at:

DESIGNED BY:

Steve Bristow

920 Garner Rd, Selma NC 27576

Email: [stevebristow57@gmail.com](mailto:stevebristow57@gmail.com)

Phone: (919)906-4737





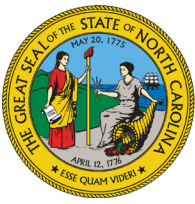

NC DEPARTMENT OF  
**HEALTH AND  
HUMAN SERVICES**

ROY COOPER • Governor

KODY H. KINSLEY • Secretary

MARK BENTON • Chief Deputy Secretary for Health

SUSAN KANSAGRA • Assistant Secretary for Public Health

Division of Public Health

### Application for Services

This application, in conjunction with the common form established in G.S. 130A-335(a3) and (a5), is optional for local health departments to be used for applications submitted in accordance with G.S. 130A-335(a2), (a3), and (a5).  
[hereinafter, G.S. 130A-335(a3) and (a5) permits referred to as (a2) Improvement Permit and (a2) Construction Authorization]

Applying for:

- (a2) Improvement Permit       (a2) Construction Authorization       (a2) Repair/Construction Authorization

If applying for a Construction Authorization, please indicate desired system type(s):

- Accepted     Conventional     Innovative     Other \_\_\_\_\_     Any

- New Construction     Expansion     System Relocation     Change of Use     Repair  
 5-Year Expiration Requested (site plan provided)     Non-Expiring Permit Requested (plat provided, defined in G.S.130A-334(7a))  
 Requesting DHHS review? (systems >3000 GPD or IPWW)     Yes     No

Applicant: \_\_\_\_\_  
 Mailing Address: \_\_\_\_\_  
 \_\_\_\_\_  
 City: \_\_\_\_\_  
 State: \_\_\_\_\_ Zip: \_\_\_\_\_  
 Phone #: \_\_\_\_\_  
 Email: \_\_\_\_\_

Owner: \_\_\_\_\_  
 Mailing Address: \_\_\_\_\_  
 \_\_\_\_\_  
 City: \_\_\_\_\_  
 State: \_\_\_\_\_ Zip: \_\_\_\_\_  
 Phone #: \_\_\_\_\_  
 Email: \_\_\_\_\_

If the answer to any of the following questions is "yes", applicant must attach supporting documentation.

Yes     No      Does the site contain any jurisdictional wetlands?  
 Yes     No      Is any wastewater going to be generated on the site other than domestic sewage?  
 Yes     No      Is the site subject to approval by any other public agency?  
 Yes     No      Are there any easements or right of ways on this property?

I understand that the documentation and fees, as required in G.S. 130A-335(a2), (a3), (a5), and (a6), attached to this application are to be used to issue an Improvement Permit and/or Construction Authorization pursuant to G.S. 130A-335(a2),(a3), and (a5). I understand that authorized county and state officials are granted right of entry to the property indicated on this application to conduct necessary inspections to determine compliance with applicable laws and rules. ***I understand that if the information in the application for an Improvements Permit and/or Construction Authorization is falsified, changed, or the site is altered, then the Improvement Permit and Construction Authorization shall become invalid.***

Applicant Signature: \_\_\_\_\_ Date: \_\_\_\_\_  
 Owner's Signature: \_\_\_\_\_ Date: \_\_\_\_\_

Permit/File #: \_\_\_\_\_

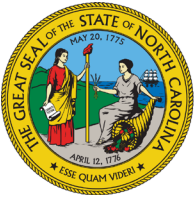

NC DEPARTMENT OF HEALTH AND HUMAN SERVICES

ROY COOPER • Governor
KODY H. KINSLEY • Secretary
MARK BENTON • Chief Deputy Secretary for Health
SUSAN KANSAGRA • Assistant Secretary for Public Health
Division of Public Health

Submittal Includes: [ ] (a2) Improvement Permit [ ] (a2) Construction Authorization [ ] Fee \$ \_\_\_\_\_

IMPROVEMENT PERMIT FOR G.S. 130A-335(a2)

County: \_\_\_\_\_

PIN/Lot Identifier: \_\_\_\_\_

Issued To: \_\_\_\_\_

Property Location: \_\_\_\_\_

Subdivision (if applicable) \_\_\_\_\_ Lot #: \_\_\_\_\_ Block: \_\_\_\_\_ Section: \_\_\_\_\_

LSS Report Provided: Yes [ ] No [ ]

If yes, name and license number of LSS: \_\_\_\_\_

New [ ] Expansion [ ] System Relocation [ ] Change of Use [ ]

Facility Type: \_\_\_\_\_

Number of bedrooms: \_\_\_\_\_ Number of Occupants: \_\_\_\_\_ Other: \_\_\_\_\_

Design Wastewater Strength: [ ] Domestic [ ] High Strength [ ] Industrial Process Wastewater

Proposed Design Daily Flow: \_\_\_\_\_ GPD Proposed LTAR (Initial): \_\_\_\_\_ Proposed LTAR (Repair): \_\_\_\_\_

Proposed Wastewater System Type\*: \_\_\_\_\_ (Initial) Pump Required: [ ] Yes [ ] No [ ] May be required

Proposed Wastewater System Type\*: \_\_\_\_\_ (Repair) Pump Required: [ ] Yes [ ] No [ ] May be required

\*Please include system classification for proposed wastewater system types in accordance with Rule .1301 Table XXXII

Effluent Standard: [ ] DSE [ ] HSE [ ] NSF/ANSI 40 [ ] TS-I [ ] TS-II [ ] RCW

Saprolite System (Initial): [ ] Yes [ ] No Saprolite System (Repair): [ ] Yes [ ] No

Fill System (Initial): [ ] Yes [ ] No If yes, specify: [ ] New [ ] Existing (when adding more than 6 inches of fill to system area provide a fill plan)

Fill System (Repair): [ ] Yes [ ] No If yes, specify: [ ] New [ ] Existing (when adding more than 6 inches of fill to system area provide a fill plan)

Usable Depth to LC (Initial)\*: \_\_\_\_\_ Usable Depth to LC (Repair)\*: \_\_\_\_\_ \* Limiting Condition

Max. Trench Depth (Initial)†: \_\_\_\_\_ Max. Trench Depth (Repair)†: \_\_\_\_\_ † Measured on the downhill side of the trench

Artificial Drainage Required: [ ] Yes [ ] No If yes, please specify details: \_\_\_\_\_

Type of Water Supply: [ ] Private well [ ] Public well [ ] Shared well [ ] Municipal Supply [ ] Spring [ ] Other: \_\_\_\_\_

Drainfield location meets requirements of Rule .0508: Yes [ ] No [ ] Drainfield location meets requirements of Rule .0601: Yes [ ] No [ ]

Permit valid for: [ ] Five years [site plan submitted pursuant to GS 130A-334(13a)] [ ] No expiration [plat submitted pursuant to GS 130A-334(7a)]

Permit conditions:
\_\_\_\_\_
\_\_\_\_\_
\_\_\_\_\_
\_\_\_\_\_

Licensed Soil Scientist Print Name: \_\_\_\_\_

Licensed Soil Scientist Signature: [Signature] \_\_\_\_\_ Date: \_\_\_\_\_

The LSS evaluation is being submitted pursuant to and meets the requirements of G.S. 130A-335(a2).

\*See attached site sketch\*



***This Section for Local Health Department Use Only***

Initial submittal received: \_\_\_\_\_ by \_\_\_\_\_  
Date Initials

G.S. 130A-335(a3) states the following:

*When an applicant for an Improvement Permit submits to a local health department an Improvement Permit application, the permit fee charged by the local health department, the common form developed by the Department, and a soil evaluation pursuant to subsection (a2) of this section, the local health department shall, within five business days of receiving the application, conduct a completeness review of the submittal. A determination of completeness means that the Improvement Permit includes all of the required components. If the local health department determines that the Improvement Permit is incomplete, the local health department shall notify the applicant of the components needed to complete the Improvement Permit. The applicant may submit additional information to the local health department to cure the deficiencies in the Improvement Permit. The local health department shall make a final determination as to whether the Improvement Permit is complete within five business days after the local health department receives the additional information from the applicant. If the local health department fails to act within any period set out in this subsection, the applicant may treat the failure to act as a determination of completeness. The Department shall develop a common form for use as the Improvement Permit.*

The review for completeness of this Improvement Permit was conducted in accordance with G.S. 130A-335(a3). This Improvement Permit is determined to be:

Incomplete (If box is checked, information in this section is required.)

The following items are missing:

\_\_\_\_\_

\_\_\_\_\_

Copies of this were sent to the LSS and the Applicant on \_\_\_\_\_  
Date

State Authorized Agent: \_\_\_\_\_ Date: \_\_\_\_\_

Complete

State Authorized Agent: \_\_\_\_\_ Date: \_\_\_\_\_

**This Improvement Permit is issued pursuant to G.S. 130A-335 (a2) and (a3) using the signed and sealed LSS/LG evaluation(s) attached here. The issuance of this permit in no way guarantees the issuance of other permits. The permit holder is responsible for checking with appropriate governing bodies in meeting their requirements. *This permit is subject to revocation if the site plan, plat, or the intended use changes.* The Improvement Permit shall not be affected by a change in ownership of the site. This permit is subject to compliance with the provisions of 15A NCAC 18E and to the conditions of this permit.**

**The Department, the Department's authorized agents, and the local health departments shall be discharged and released from any liabilities, duties, and responsibilities imposed by statute or in common law from any claim arising out of or attributed to evaluations, submittals, or actions from a licensed soil scientist or licensed geologist pursuant to GS 130A-335(a2).**

Improvement Permit Expiration Date: \_\_\_\_\_

**\*See attached site sketch\***

## Re-submittal of Improvement Permit

LHD USE ONLY: This IP resubmittal received: \_\_\_\_\_ by \_\_\_\_\_  
*Date* *Initials*

The following items are being resubmitted pursuant to G.S. 130A-335(a3) for issuance of the Improvement Permit:

---



---



---



---

I, \_\_\_\_\_ hereby attest that the information required to be included with this re-submittal  
*Licensed Soil Scientist (Print Name)*  
 is accurate and complete to the best of my knowledge and that the proposed Improvement Permit meets all applicable federal, State, and local laws, regulations, rules, and ordinances.

\_\_\_\_\_  
*Signature of Licensed Soil Scientist* \_\_\_\_\_  
*Date*

*The section below is for Local Health Department use after submittal of items noted as missing above.*

### LHD Follow-up Completeness Review of Improvement Permit

The review for completeness of this Improvement Permit re-submittal was conducted in accordance with G.S. 130A-335(a3). This Improvement Permit is determined to be:

Incomplete (If box is checked, information in this section is required.)

The following items are missing:

---



---

Copies of this were sent to the LSS and the Applicant on \_\_\_\_\_  
*Date*

State Authorized Agent: \_\_\_\_\_ Date: \_\_\_\_\_

Complete

State Authorized Agent: \_\_\_\_\_ Date: \_\_\_\_\_

**CONSTRUCTION AUTHORIZATION FOR G.S. 130A-335(a2)**

County: \_\_\_\_\_

Pre-Construction Conference Required: Yes  No

PIN/Lot Identifier: \_\_\_\_\_

Issued To: \_\_\_\_\_

Property Location: \_\_\_\_\_

AOWE/PE Plans/Evaluations Provided: Yes  No  If yes, name and license number of AOWE/PE: \_\_\_\_\_

Facility Type: \_\_\_\_\_

Number of bedrooms: \_\_\_\_\_ Number of Occupants: \_\_\_\_\_ Other: \_\_\_\_\_

New  Expansion  Repair  System Relocation  Change of Use

Basement?  Yes  No Basement Fixtures?  Yes  No

Crawl Space?  Yes  No Slab Foundation?  Yes  No

Type of Wastewater System\* \_\_\_\_\_ (Initial) \_\_\_\_\_ (Repair)

*\*Please include system classification for proposed wastewater system types in accordance with Rule .1301 Table XXXII*

Design Daily Flow: \_\_\_\_\_ GPD Wastewater Strength:  Domestic  High Strength  Industrial Process WW

Session Law 2014-120 Section 53, Engineering Design Utilizing Low-flow Fixtures and Low-flow Technologies?  Yes  No  
*(if yes, please provide engineering documentation)*

Effluent Standard:  DSE  HSE  NSF/ANSI 40  TS-I  TS-II  RCW

Type of Water Supply:  Private well  Public well  Shared well  Municipal Supply  Spring  Other: \_\_\_\_\_

**Installation Requirements/Conditions**

Septic Tank Size: \_\_\_\_\_ gallons Total Trench/Bed Length: \_\_\_\_\_ feet Trench/Bed Spacing: \_\_\_\_\_ feet on center

Trench/Bed Width: \_\_\_\_\_ inches LTAR: \_\_\_\_\_ gpd/ft<sup>2</sup> Usable Depth to LC (Initial)\*: \_\_\_\_\_ <sup>x</sup>Limiting condition

Soil Cover: \_\_\_\_\_ inches Slope Corrected Maximum Trench/Bed Depth†: \_\_\_\_\_ inches <sup>\*</sup> Measured on the downhill side of the trench

Pump Tank Size (if applicable): \_\_\_\_\_ gallons Requires more than 1 pump?  Yes  No

Pump Requirements: \_\_\_\_\_ ft. TDH vs. \_\_\_\_\_ GPM Grease Trap Size (if applicable): \_\_\_\_\_ gallons

Distribution Method:  Serial  D-Box or Parallel  Pressure Manifold(s)  LPP  Other: \_\_\_\_\_

Artificial Drainage Required: Yes  No  If yes, please specify details: \_\_\_\_\_

**Legal Agreements** *(If the answer is "Yes" to any type of legal agreements, please attach a copy of the agreement.)*

Multi-party Agreement Required [.0204(g)]:  Yes  No Declaration of Restrictive Covenants:  Yes  No

Easement, Right-of-Way, or Encroachment Agreement Required [.0301(b)]:  Yes  No

Management Entity Required:  Yes  No Minimum O&M Requirements: \_\_\_\_\_

Permit conditions:

---



---



---



---



---

The requirements of 15A NCAC 18E are incorporated by reference into this permit and shall be met. Systems shall be installed in accordance with the attached site sketch. ***This Construction Authorization is subject to revocation if the site plan, plat, or the intended use changes.*** The Construction Authorization shall not be affected by a change in ownership of the site. This Construction Authorization is subject to compliance with the provisions of 15A NCAC 18E, or 15A NCAC 18A .1900, as applicable, and to the conditions of this permit.

AOWE/PE Print Name: \_\_\_\_\_

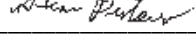
AOWE/PE Signature:  \_\_\_\_\_

Date: \_\_\_\_\_

**This AOWE/PE submittal is pursuant to and meets the requirements of G.S. 130A-335(a2) and (a5).**

**\*See attached site sketch\***



***This Section for Local Health Department Use Only***

Initial submittal received: \_\_\_\_\_ by \_\_\_\_\_  
Date Initials

G.S. 130A-335(a5) states the following:

*When an applicant for a Construction Authorization, or an Improvement Permit and Construction Authorization together, submits a Construction Authorization, or an Improvement Permit and Construction Authorization application together, the permit fee charged by the local health department, the common form developed by the Department, and any necessary signed and sealed plans or evaluations conducted by a person licensed pursuant to Chapter 89C of the General Statutes as a licensed engineer or a person certified pursuant to Article 5 of Chapter 90A of the General Statutes as an Authorized On-Site Wastewater Evaluator, the local health department shall, within five business days of receiving the application, conduct a completeness review of the submittal. A determination of completeness means that the Construction Authorization or Improvement Permit and Construction Authorization includes all of the required components. If the local health department determines that the Construction Authorization or Improvement Permit and Construction Authorization is incomplete, the local health department shall notify the applicant of the components needed to complete the Construction Authorization or Improvement Permit and Construction Authorization. The applicant may submit additional information to the local health department to cure the deficiencies in the Construction Authorization or Improvement Permit and Construction Authorization. The local health department shall make a final determination as to whether the Construction Authorization or Improvement Permit and Construction Authorization is complete within five business days after the local health department receives the additional information from the applicant. If the local health department fails to act within any period set out in this subsection, the applicant may treat the failure to act as a determination of completeness. The applicant may apply for the building permit for the project upon the decision of completeness of the Construction Authorization or Improvement Permit and Construction Authorization by the local health department or if the local health department fails to act within five business days. The Authorized On-Site Wastewater Evaluator or licensed engineer submitting the evaluation pursuant to this subsection may request that the local health department revoke or suspend the Construction Authorization or Improvement Permit and Construction Authorization for cause. Upon written request of the Authorized On-Site Wastewater Evaluator or licensed engineer, the local health department shall suspend or revoke the Construction Authorization or Improvement Permit and Construction Authorization pursuant to G.S. 130A-23. The Department shall develop a common form for use as the Construction Authorization.*

The review for completeness of this Construction Authorization was conducted in accordance with G.S. 130A-335(a5). This

Construction Authorization is determined to be:

Incomplete (If box is checked, information in this section is required.)

The following items are missing: \_\_\_\_\_  
\_\_\_\_\_

Copies of this were sent to the AOWE/PE and the Applicant on \_\_\_\_\_  
Date

State Authorized Agent: \_\_\_\_\_ Date: \_\_\_\_\_

Complete

State Authorized Agent: \_\_\_\_\_ Date of Issuance: \_\_\_\_\_

**This Construction Authorization is issued pursuant to G.S. 130A-335(a2) and (a5) using the signed and sealed plans or evaluations attached here. This Construction Authorization is subject to revocation if the site plan, plat, or the intended use changes. The Construction Authorization shall not be affected by a change in ownership of the site. This Construction Authorization is subject to compliance with the provisions of the Laws and Rules for Sewage Treatment and Disposal and to the conditions of this permit.**

**The Department, the Department's authorized agents, and the local health departments shall be discharged and released from any liabilities, duties, and responsibilities imposed by statute or in common law from any claim arising out of or attributed to plans, evaluations, preconstruction conference findings, submittals, or actions from a person licensed pursuant to Chapter 89C of the General Statutes as a licensed engineer or a person certified pursuant to Article 5 of Chapter 90A of the General Statutes as an Authorized On-Site Wastewater Evaluator in GS 130A-335(a2), (a5), and (a7). The Department, the Department's authorized agents, and the local health departments shall be responsible and bear liability for their actions and evaluations and other obligations under State law or rule, including the issuance of the operations permit pursuant to GS 130A-337.**

**Construction Authorization Expiration Date:** \_\_\_\_\_

**\*See attached site sketch\***



## Re-submittal of Construction Authorization

LHD USE ONLY: This CA resubmittal received: \_\_\_\_\_ by \_\_\_\_\_  
Date Initials

The following items are being resubmitted pursuant to G.S. 130A-335(a5) for issuance of the Construction Authorization:

---



---



---



---

I, \_\_\_\_\_ hereby attest that the information required to be included with this re-submittal  
Authorized Onsite Wastewater Evaluator (Print Name)  
 is accurate and complete to the best of my knowledge and that the proposed Construction Authorization meets all applicable federal, State, and local laws, regulations, rules, and ordinances.

---

*Signature of Authorized On-Site Wastewater Evaluator*

---

*Date*

***The section below is for Local Health Department use after submittal of items noted as missing above.***

### LHD Follow-up Completeness Review of Construction Authorization

The review for completeness of this Construction Authorization re-submittal was conducted in accordance with G.S. 130A-335(a5). This Construction Authorization is determined to be:

Incomplete (If box is checked, information in this section is required.)

The following items are missing:

---



---

Copies of this were sent to the AOWE/PE and the Applicant on \_\_\_\_\_  
Date

State Authorized Agent: \_\_\_\_\_ Date: \_\_\_\_\_

Complete

State Authorized Agent: \_\_\_\_\_ Date: \_\_\_\_\_





**Re-submittal of Construction Authorization**

LHD USE ONLY: This CA resubmittal received: \_\_\_\_\_ by \_\_\_\_\_  
Date Initials

The following items are being resubmitted pursuant to G.S. 130A-335(a5) for issuance of the Construction Authorization:

---



---



---



---

I, \_\_\_\_\_ hereby attest that the information required to be included with this re-submittal  
Authorized Onsite Wastewater Evaluator (Print Name)  
 is accurate and complete to the best of my knowledge and that the proposed Construction Authorization meets all applicable federal, State, and local laws, regulations, rules, and ordinances.

\_\_\_\_\_  
Signature of Authorized On-Site Wastewater Evaluator Date

*The section below is for Local Health Department use after submittal of items noted as missing above.*

**LHD Follow-up Completeness Review of Construction Authorization**

The review for completeness of this Construction Authorization re-submittal was conducted in accordance with G.S. 130A-335(a5). This Construction Authorization is determined to be:

Incomplete (If box is checked, information in this section is required.)

The following items are missing:

---



---

Copies of this were sent to the AOWE/PE and the Applicant on \_\_\_\_\_  
Date

State Authorized Agent: \_\_\_\_\_ Date: \_\_\_\_\_

Complete

State Authorized Agent: \_\_\_\_\_ Date: \_\_\_\_\_



# LEGEND

LANDSCAPE POSITION	SOIL GROUP	SOIL TEXTURE	CONVENTIONAL LTAR (gpd/ft <sup>2</sup> )	SAPROLITE LTAR (gpd/ft <sup>2</sup> )	LPP LTAR (gpd/ft <sup>2</sup> )	MINERALOGY/ CONSISTENCE		STRUCTURE		
						MOIST	WET			
CC (Concave slope)	I	S (Sand)	0.8 - 1.2	0.6 - 0.8	0.4 - 0.6	Moist	Wet	SG (Single grain)		
CV (Convex Slope)		LS (Loamy sand)		0.5 - 0.7		Lo (Loose)	NS (Non-sticky)	M (Massive)		
D (Drainage way)	II	SL (Sandy loam)	0.6 - 0.8	0.4 - 0.6	0.3 - 0.4	VFR (Very friable)	SS (Slightly sticky)	GR (Granular)		
FP (Flood plain)		L (Loam)		0.2 - 0.4		FR (Friable)	S (Sticky)	SBK (Subangular blocky)		
FS (Foot slope)	III	SiL (Silt loam)	0.3 - 0.6	0.1 - 0.3	0.15 - 0.3	FI (Firm)	VS (Very sticky)	ABK (Angular blocky)		
H (Head slope)		SCL (Sandy clay loam)		0.05 - 0.15**		VFI (Very firm)	NP (Non-plastic)	PR (Prismatic)		
L (Linear Slope)		CL (Clay loam)		None		0.15 - 0.3	EFI (Extremely firm)	SP (Slightly plastic)	PL (Platy)	
N (Nose slope)		SiCL (Silty clay loam)					P (Plastic)	None	0.15 - 0.3	None
R (Ridge/summit)		Si (Silt)								
S (Shoulder slope)	IV	SC (Sandy clay)	0.1 - 0.4	0.05 - 0.2	SEXP (Slightly expansive)		None			
T (Terrace)		SiC (Silty clay)			EXP (Expansive)					
TS (Toe Slope)		C (Clay)								
		O (Organic)	None							

\* Adjust LTAR due to depth, consistence, structure, soil wetness, landscape, position, wastewater flow and quality.

\*\*Sandy clay loam saprolite can only be used with advanced pretreatment in accordance with 15A NCAC 18E .1200.

*HORIZON DEPTH* In inches below natural soil surface

*DEPTH OF FILL* In inches from land surface

*RESTRICTIVE HORIZON* Thickness and depth from land surface

*SAPROLITE* S(suitable) or U(unsuitable); Evaluation of saprolite shall be by pits.

*SOIL WETNESS* Inches from land surface to free water or inches from land surface to soil colors with chroma 2 or less - record Munsell color chip designation

*CLASSIFICATION* S (Suitable) or U (Unsuitable)

**Show profile locations and other site features (dimensions, reference or benchmark, and North).**

# Briarwood Bluff Lot 32 System Detail

POUS = 3,103 SF  
 US = 13.53%

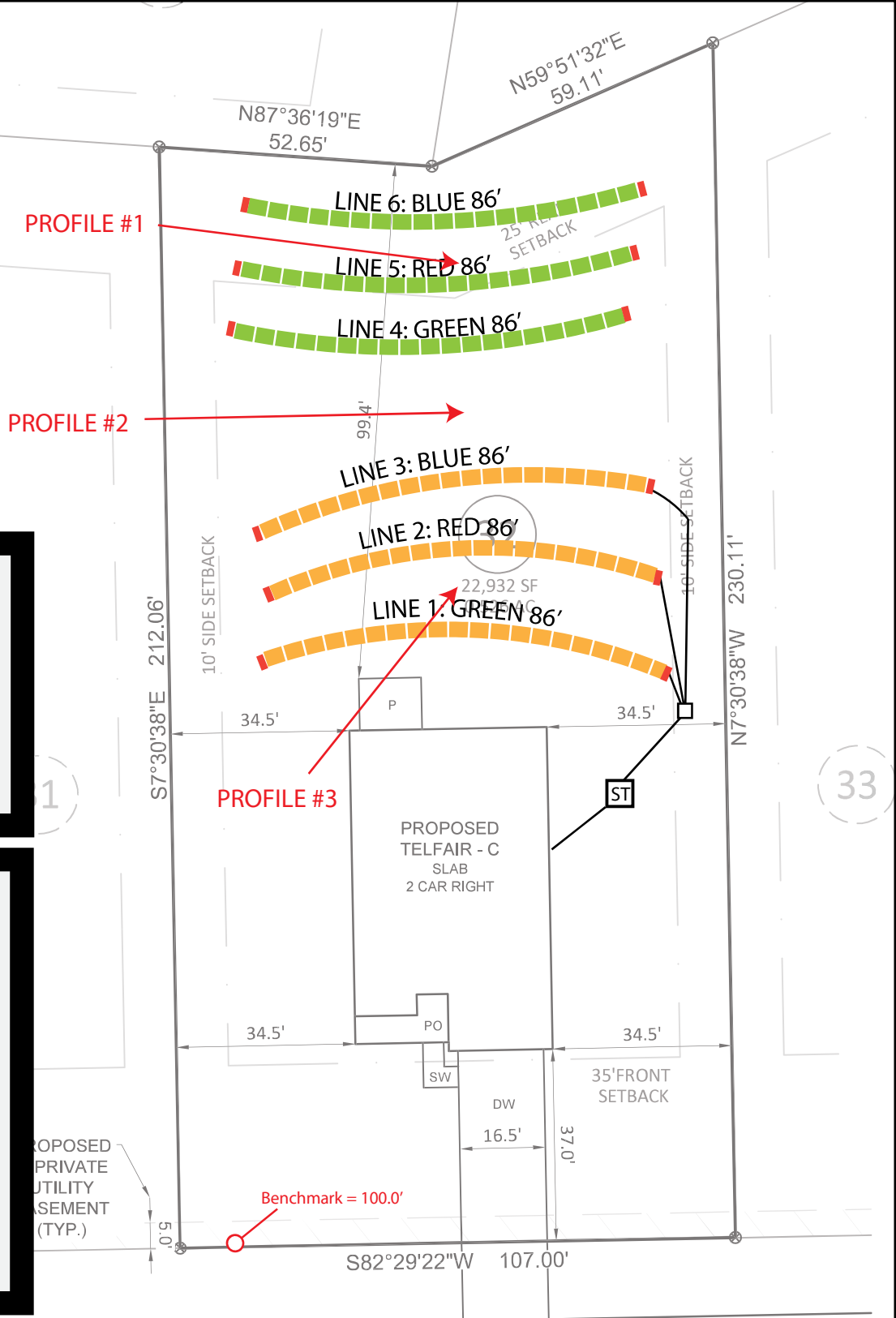

### Elevation Table

Benchmark = 100'  
 Line 1 = 96.5'  
 Line 2 = 96.3'  
 Line 3 = 95.9'  
 Line 4 = 95.7'  
 Line 5 = 95.2'  
 Line 6 = 95.2'

### System Details

**Initial:**  
 1000 gal Septic Tank  
 0.35 LTAR  
 Lines 1-3 (256')  
 Accepted - Gravity  
 Distribution - Parallel  
 Quick 4 Chamber  
 20" MTD

**Repair:**  
 1000 gal Septic Tank  
 0.35 LTAR  
 Lines 4-6 (256')  
 Accepted - Gravity  
 Distribution - Parallel  
 Quick 4 Chamber  
 20" MTD

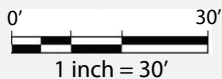

### Legend

Initial   
 Repair   
 End Cap 



# Briarwood Bluff Lot 32 System Detail

POUS = 3,103 SF  
 US = 13.53%

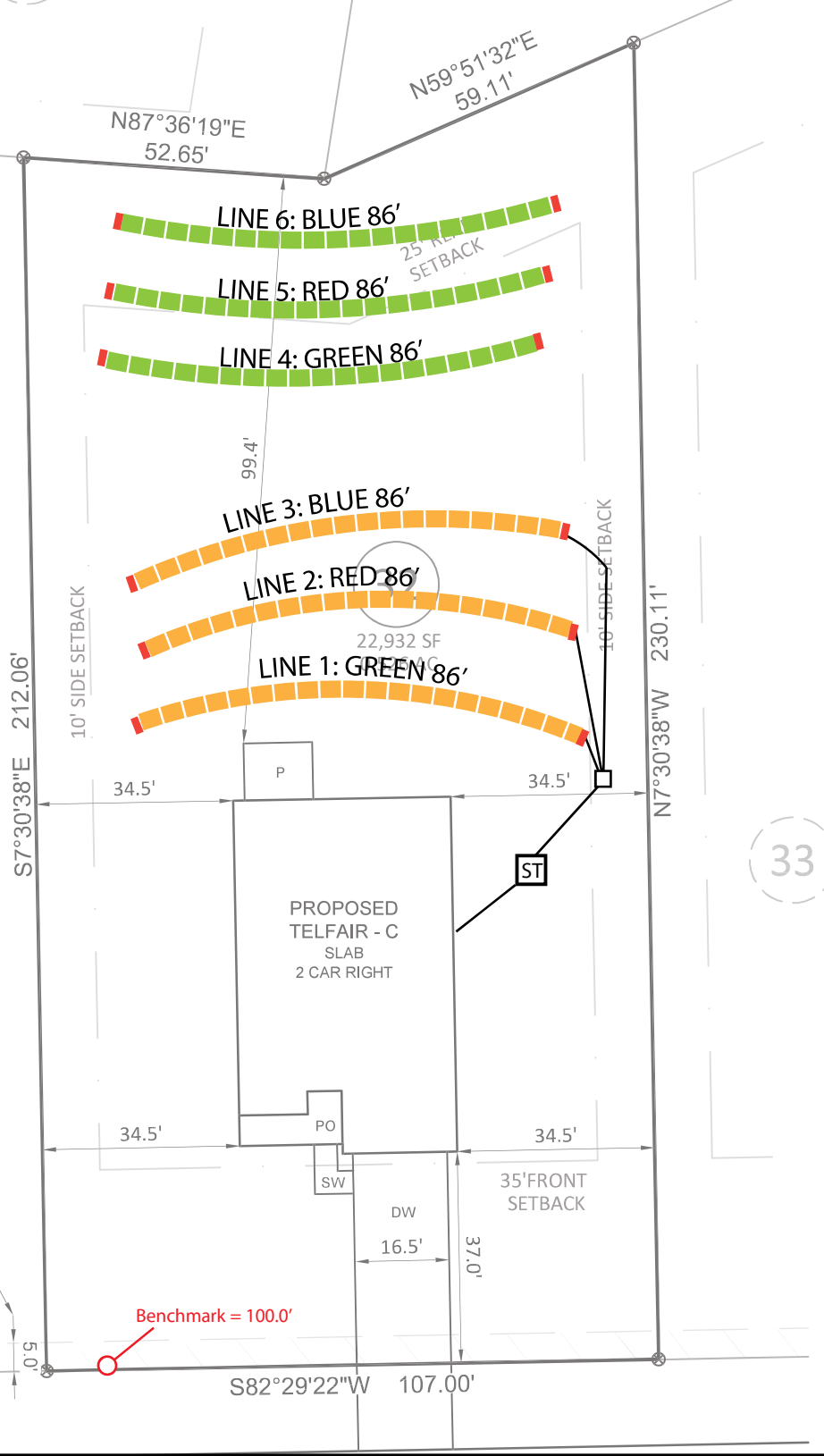

### Elevation Table

Benchmark = 100'  
 Line 1 = 96.5'  
 Line 2 = 96.3'  
 Line 3 = 95.9'  
 Line 4 = 95.7'  
 Line 5 = 95.2'  
 Line 6 = 95.2'

### System Details

**Initial:**  
 1000 gal Septic Tank  
 0.35 LTAR  
 Lines 1-3 (256')  
 Accepted - Gravity  
 Distribution - Parallel  
 Quick 4 Chamber  
 20" MTD

**Repair:**  
 1000 gal Septic Tank  
 0.35 LTAR  
 Lines 4-6 (256')  
 Accepted - Gravity  
 Distribution - Parallel  
 Quick 4 Chamber  
 20" MTD

PROPOSED PRIVATE UTILITY ASSESSMENT (TYP.)

Benchmark = 100.0'

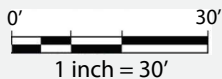

### Legend

- Initial
- Repair
- End Cap



# Briarwood Bluff Lot 32 System Detail

POUS = 3,103 SF  
 US = 13.53%

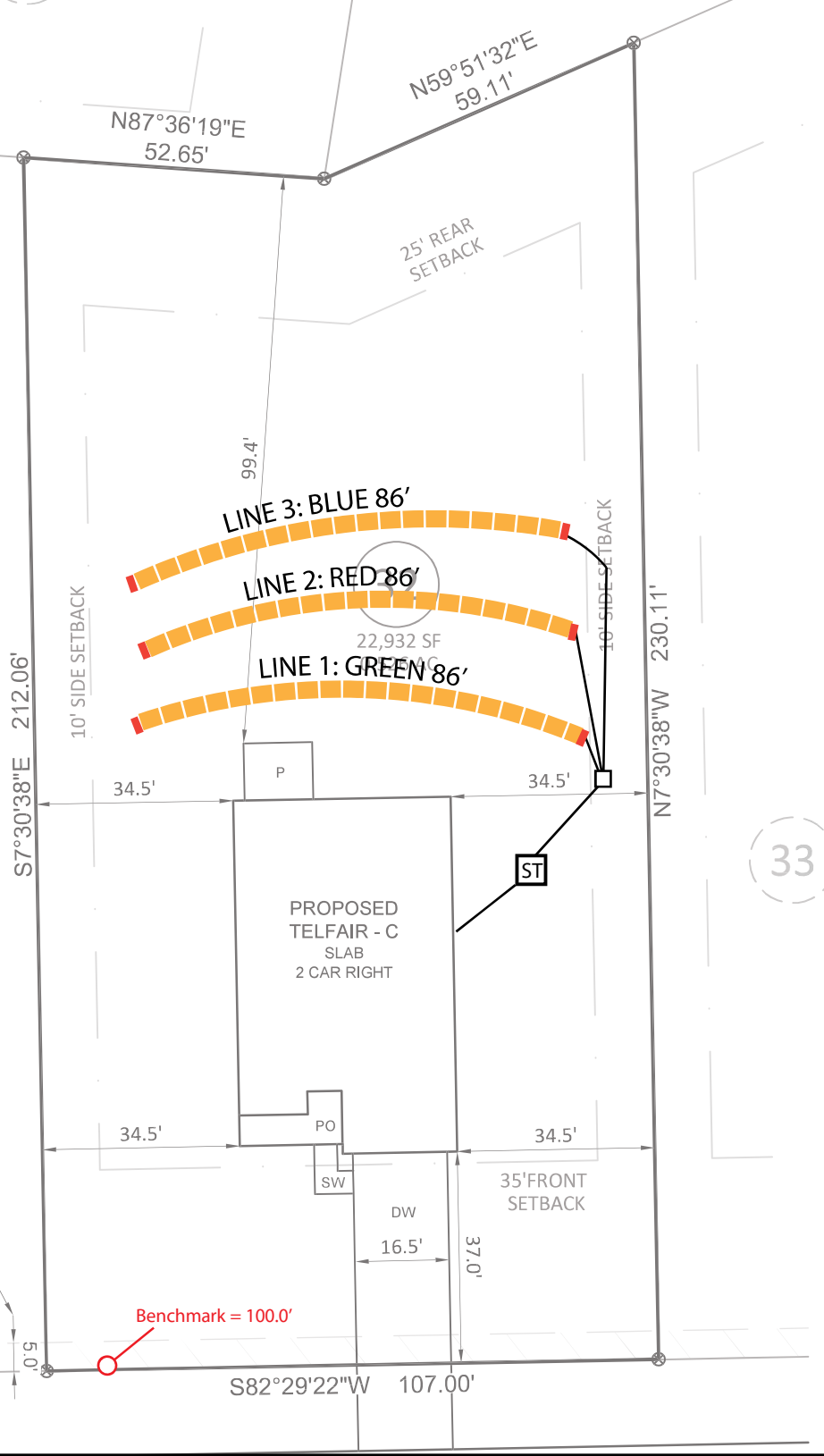

### Elevation Table

- Benchmark = 100'
- Line 1 = 96.5'
- Line 2 = 96.3'
- Line 3 = 95.9'
- Line 4 = 95.7'
- Line 5 = 95.2'
- Line 6 = 95.2'

### System Details

- Initial:**  
 1000 gal Septic Tank  
 0.35 LTAR  
 Lines 1-3 (256')  
 Accepted - Gravity  
 Distribution - Parallel  
 Quick 4 Chamber  
 20" MTD
- Repair:**  
 1000 gal Septic Tank  
 0.35 LTAR  
 Lines 4-6 (256')  
 Accepted - Gravity  
 Distribution - Parallel  
 Quick 4 Chamber  
 20" MTD

PROPOSED PRIVATE UTILITY ASSESSMENT (TYP.)

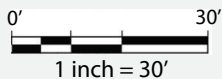

### Legend

- Initial
- Repair
- End Cap



# Briarwood Bluff Lot 32 System Detail

POUS = 3,103 SF  
 US = 13.53%

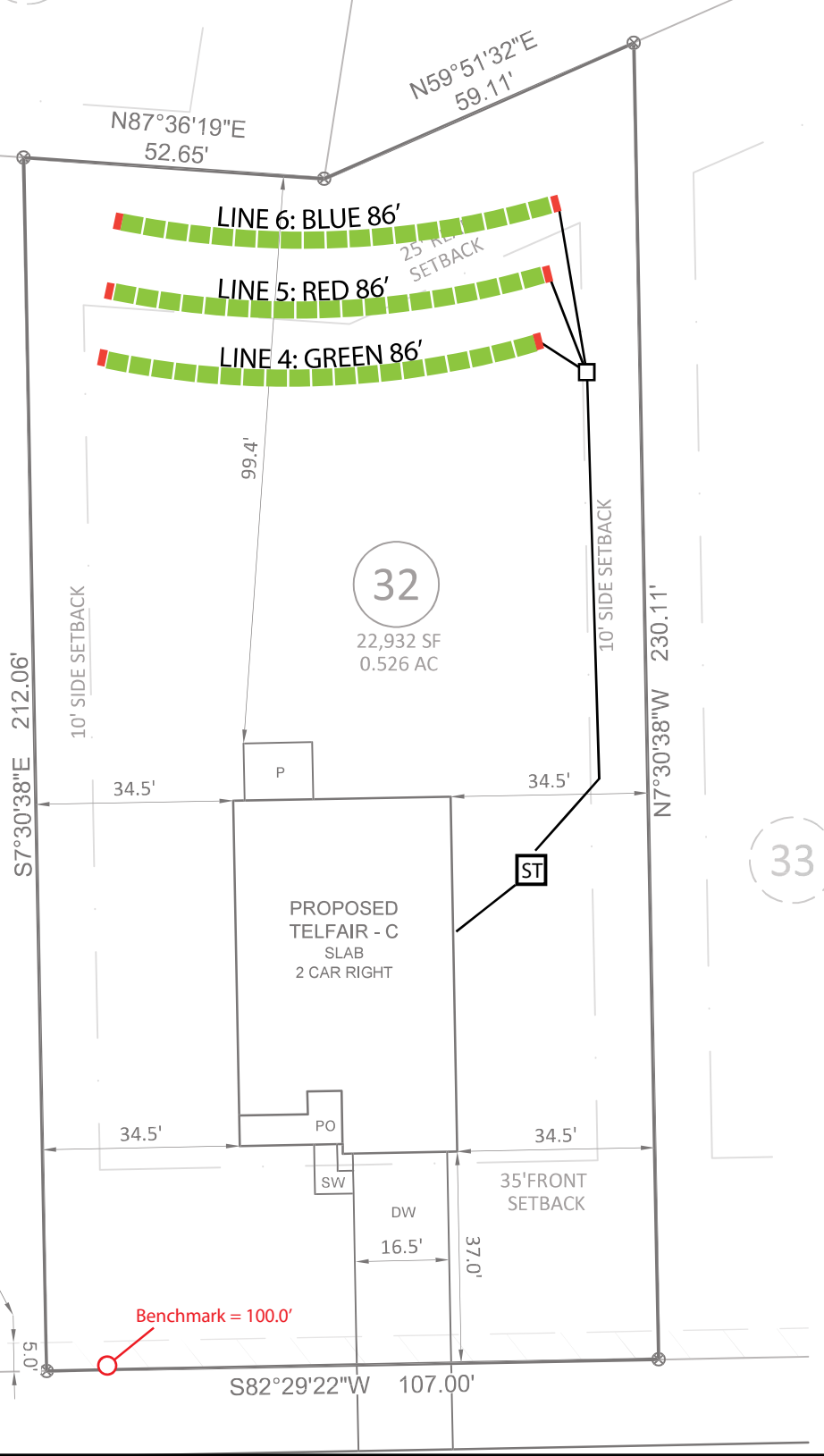

## Elevation Table

Benchmark = 100'  
 Line 1 = 96.5'  
 Line 2 = 96.3'  
 Line 3 = 95.9'  
 Line 4 = 95.7'  
 Line 5 = 95.2'  
 Line 6 = 95.2'

## System Details

**Initial:**  
 1000 gal Septic Tank  
 0.35 LTAR  
 Lines 1-3 (256')  
 Accepted - Gravity  
 Distribution - Parallel  
 Quick 4 Chamber  
 20" MTD

**Repair:**  
 1000 gal Septic Tank  
 0.35 LTAR  
 Lines 4-6 (256')  
 Accepted - Gravity  
 Distribution - Parallel  
 Quick 4 Chamber  
 20" MTD

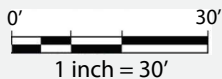

## Legend

Initial ■  
 Repair ■  
 End Cap ■



# SYSTEM DETAIL OVERVIEW

## Initial System

### Design Criteria

Number of bedrooms  
Design Flow  
Soil L.T.A.R.

---

---

---

### System Detail

Trench Depth  
Total Trench Length  
Distribution

---

---

---

### System Components

Trench Product  
Septic Tank  
Effluent Filter

---

---

---

## Repair System

### Design Criteria

Number of bedrooms  
Design Flow  
Soil L.T.A.R.

---

---

---

### System Detail

Trench Depth  
Total Trench Length  
Distribution

---

---

---

### System Components

Trench Product  
Septic Tank  
Effluent Filter

---

---

---



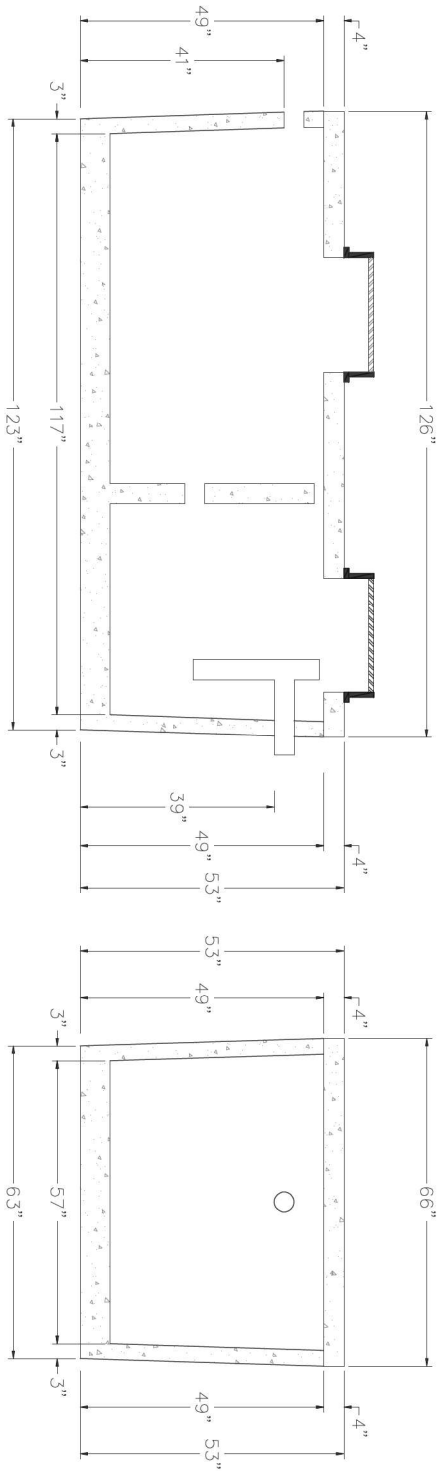

**1,000 ST 499**  
NTS

NON TRAFFIC BEARING

**DAVID BRANTLEY & SONS**

37 Pine Ridge Rd.  
Zebulon, NC 27597  
Office 252-478-3721  
Fax 919-573-0443

installer@gmail.com

PREPARED FOR : David Brantley & Sons  
37 Pine Ridge Rd.  
Zebulon, NC 27597

DATE : April 11, 2014

CONTACT:  
CORY BRANTLEY

REVISION NO.

Original Submittal

Revision 1

Revision 2

Revision 3

Master Set

DATE

April 11, 2014

BRANTLEY TANK MODEL

**1,000 ST 499**

SHEET NUMBER

**1 of 1**

**PL-68 Filter and Tee**

PL-68 is much more than just an effluent filter. The housing can also be used as an inlet baffle (tee) or an outlet baffle. The housing is designed to accept Polylok's snap in gas deflector to deflect gas bubbles away from the tee and to keep the solids in the tank.

**Features:**

- Offers 68 linear feet of 1/16" filter slots, which significantly extends time between cleaning.
- Accepts 3/4" PVC handle.
- Locks in any 360° position when used with PL-68 Tee.
- PL-68 Housing can be used as an inlet or outlet tee.
- Gasket prevents bypass.

**PL-68 Installation:**

Ideal for residential waste flows up to 800 gallons per day (GPD). Easily installs in any new or existing 4" outlet tee.

1. Locate the outlet of the septic tank.
2. Remove the tank cover and pump tank if necessary.
3. Glue the filter housing to the outlet pipe, or use a Polylok Extend & Lok if not enough pipe exists.
4. Insert the PL-68 filter into tee.
5. Replace and secure the septic tank cover.

**PL-68 Maintenance:**

The PL-68 Effluent Filter will operate efficiently for several years under normal conditions before requiring cleaning. It is recommended that the filter be cleaned every time the tank is pumped, or at least every three years.

1. Do not use plumbing when filter is removed.
2. Pull PL-68 out of the tee.
3. Hose off filter over the septic tank. Make sure all solids fall back into septic tank.
4. Insert filter back into tee/housing.

**Related Products:**

PL-68 Filter Concrete Baffle  
 Extend & Lok<sup>™</sup>

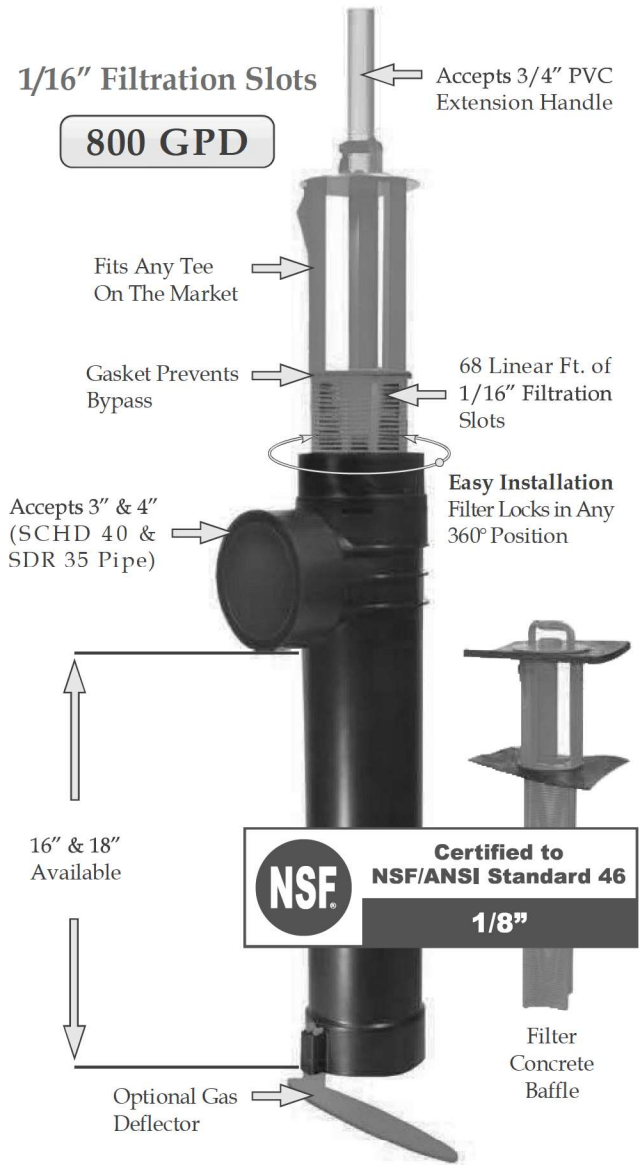

Extend & Lok<sup>™</sup>  
 Easily installs  
 into existing tanks.



Spacer Bushing  
 4" SCHD 40  
 to SDR 35



Spacer Bushing  
 4" SCHD 40  
 to 110mm Pipe



2" Extender

# NITRIFICATION TRENCH DETAIL FOR EZ-FLOW

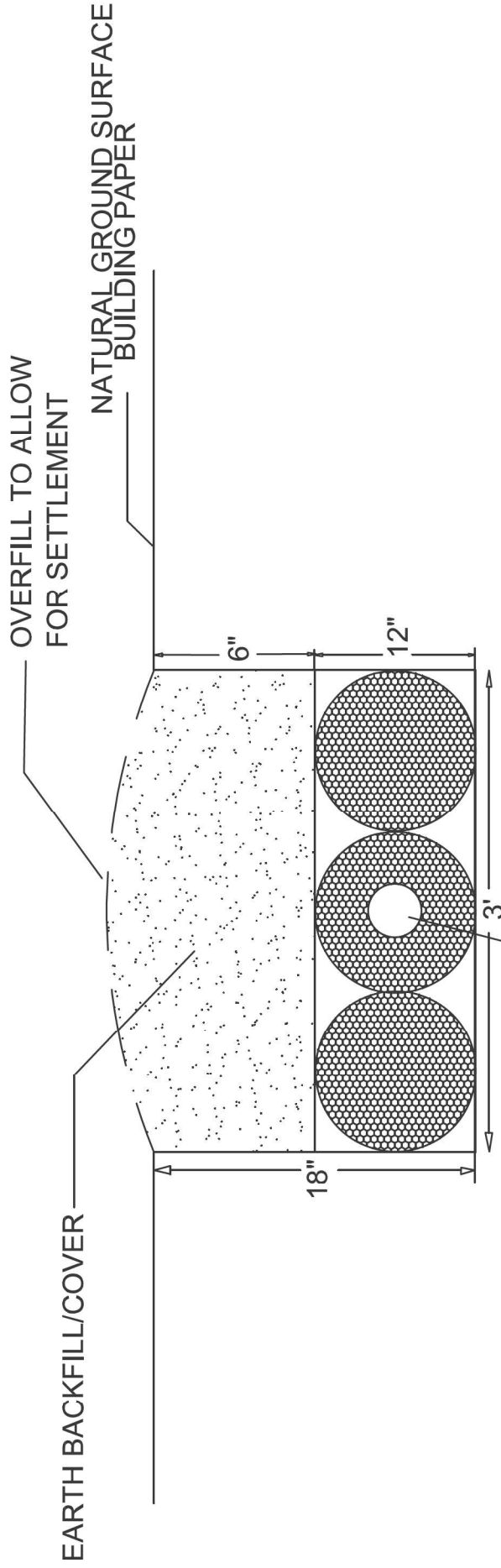

NOTE :

EZ-FLOW  
 4" DIAMETER CORRUGATED  
 PLASTIC DRAIN PIPE  
 SURROUNDED BY  
 POLYSTYRENE BLOCKS  
 WRAPPED W/PLASTIC MESH

1. PERFORATED CORRUGATED PLASTIC PIPE SHALL MEET REQUIREMENTS OF ASTM D 2729.
2. PIPE SHALL BE LEVEL.
3. END CAP SHALL BE PROVIDED AT END OF ALL CORRUGATED PLASTIC PIPE LINES.
4. TRENCH BOTTOM SHALL BE LEVEL.
4. SEE INFORMATION FOR INSTALLER.

JOB NO:

PROJECT MGR:

SCALE:  
 NTS

PROJECT NAME:

SHEET TITLE:

NOTES:

PAC-ONE PLLC

NITRIFICATION TRENCH



**INFILTRATOR**  
water technologies

**Quick4**<sup>™</sup>  
CHAMBER SYSTEMS

## The Quick4<sup>®</sup> Standard Chamber

### Quick4<sup>®</sup> Series

### Quick4 Standard with MultiPort EndCap



The Quick4<sup>®</sup> Standard Chamber fits in a 36" wide trench and is ideal for curved or straight systems. It features the patent-pending Contour Swivel Connection<sup>™</sup> which permits turns up to 10°, right or left. The MultiPort<sup>™</sup> endcap allows multiple piping options and eliminates pipe fittings. The chamber's four-foot length provides optimal installation flexibility.

#### Chamber Benefits:

- Advanced contouring connections swivel up to 10°, right or left
- Latching mechanism allows for quick installation
- Four-foot chambers are easy to handle and install
- The Quick4 Standard Chamber supports wheel loads of 16,000 lbs/axle with only 12" of cover
- Certified by the International Association of Plumbing and Mechanical Officials (IAPMO)



#### MultiPort Endcap Benefits:

- Tear-out seals on inlet ports provide a tight fit to the pipe
- Eight molded-in inlets/outlets allow for maximum piping flexibility
- Eliminates pipe fittings
- Fits on either end of the Quick4 Standard Chamber



### Quick4<sup>®</sup> Series

**Because installations are faster with Quick4 chambers, you save on heavy equipment operation and labor.**

APPROVED in \_\_\_\_\_



**Quick4 Standard Chamber**

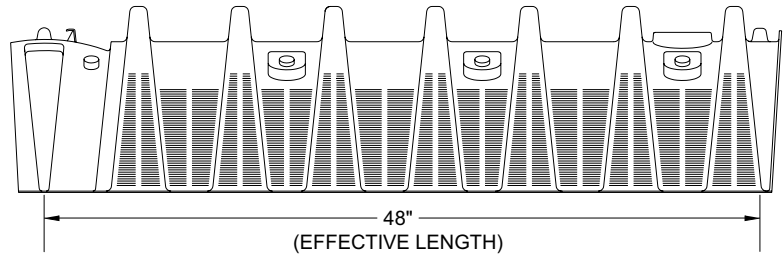
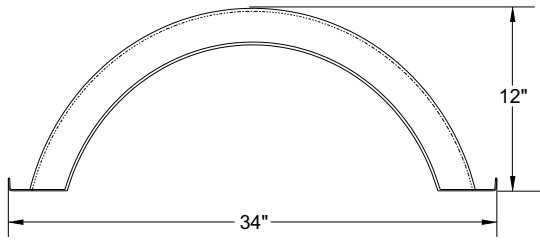

**MultiPort EndCap**

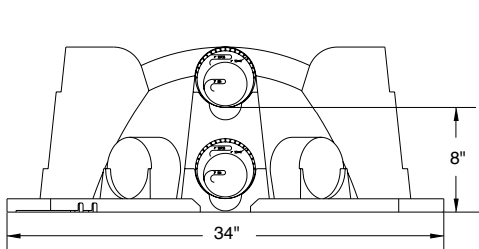

FRONT VIEW

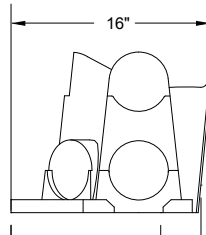

SIDE VIEW

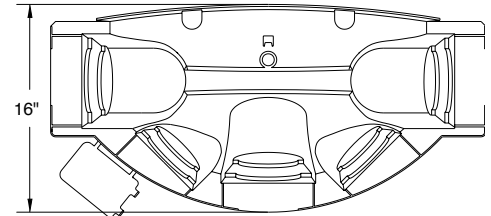

TOP VIEW

**Typical Trench View**

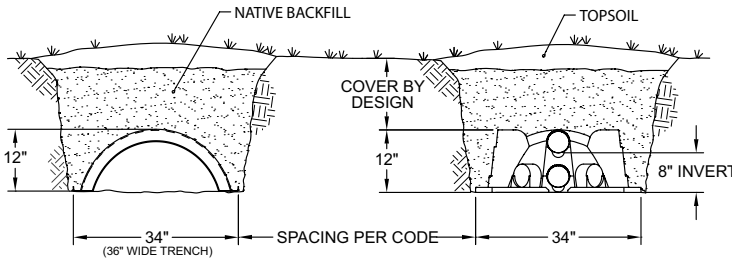

**INFILTRATOR WATER TECHNOLOGIES, LLC ("INFILTRATOR")**

**Infiltrator Water Technologies, LLC STANDARD LIMITED Drainfield WARRANTY**

(a) The structural integrity of each chamber, endcap, EZflow expanded polystyrene and/or other accessory manufactured by Infiltrator ("Units"), when installed and operated in a leachfield of an onsite septic system in accordance with Infiltrator's instructions, is warranted to the original purchaser ("Holder") against defective materials and workmanship for one year from the date that the septic permit is issued for the septic system containing the Units; provided, however, that if a septic permit is not required by applicable law, the warranty period will begin upon the date that installation of the septic system commences. To exercise its warranty rights, Holder must notify Infiltrator in writing at its Corporate Headquarters in Old Saybrook, Connecticut within fifteen (15) days of the alleged defect. Infiltrator will supply replacement Units for Units determined by Infiltrator to be covered by this Limited Warranty. Infiltrator's liability specifically excludes the cost of removal and/or installation of the Units.

(b) THE LIMITED WARRANTY AND REMEDIES IN SUBPARAGRAPH (a) ARE EXCLUSIVE. THERE ARE NO OTHER WARRANTIES WITH RESPECT TO THE UNITS, INCLUDING NO IMPLIED WARRANTIES OF MERCHANTABILITY OR FITNESS FOR A PARTICULAR PURPOSE

(c) This Limited Warranty shall be void if any part of the chamber system is manufactured by anyone other than Infiltrator. The Limited Warranty does not extend to incidental, consequential, special or indirect damages. Infiltrator shall not be liable for penalties or liquidated damages, including loss of production and profits, labor and materials, overhead costs, or other losses or expenses incurred by the Holder or any third party. Specifically excluded from Limited Warranty coverage are damage to the Units due to ordinary wear and tear, alteration, accident, misuse, abuse or neglect of the Units; the Units being subjected to vehicle traffic or other conditions which are not permitted by the installation instructions; failure to maintain the minimum ground covers set forth in the installation instructions; the placement of improper materials into the system containing the Units; failure of the Units or the septic system due to improper siting or improper sizing, excessive water usage, improper grease disposal, or improper operation; or any other event not caused by Infiltrator. This Limited Warranty shall be void if the Holder fails to comply with all of the terms set forth in this Limited Warranty. Further, in no event shall Infiltrator be responsible for any loss or damage to the Holder, the Units, or any third party resulting from installation or shipment, or from any product liability claims of Holder or any third party. For this Limited Warranty to apply, the Units must be installed in accordance with all site conditions required by state and local codes; all other applicable laws; and Infiltrator's installation instructions.

(d) No representative of Infiltrator has the authority to change or extend this Limited Warranty. No warranty applies to any party other than the original Holder. The above represents the Standard Limited Warranty offered by Infiltrator. A limited number of states and counties have different warranty requirements. Any purchaser of Units should contact Infiltrator's Corporate Headquarters in Old Saybrook, Connecticut, prior to such purchase, to obtain a copy of the applicable warranty, and should carefully read that warranty prior to the purchase of Units.

**Quick4® Standard Chamber Specifications**

<b>Size</b>	34"W x 53"L x 12"H (864 mm x 1346 mm x 305 mm)
<b>Effective Length</b>	48" (1219 mm)
<b>Louver Height</b>	8" (203 mm)
<b>Storage Capacity</b>	43 gal (163 L)
<b>Invert Height</b>	8" (203 mm)



**INFILTRATOR**  
water technologies

4 Business Park Road  
P.O. Box 768  
Old Saybrook, CT 06475  
860-577-7000 • Fax 860-577-7001  
**1-800-221-4436**  
[www.infiltratorwater.com](http://www.infiltratorwater.com)

U.S. Patents: 4,759,661; 5,017,041; 5,156,488; 5,336,017; 5,401,116; 5,401,459; 5,511,903; 5,716,163; 5,588,778; 5,839,844 Canadian Patents: 1,329,959; 2,004,564 Other patents pending. Infiltrator, Equalizer, Quick4, and SideWinder are registered trademarks of Infiltrator Water Technologies. Infiltrator is a registered trademark in France. Infiltrator Water Technologies is a registered trademark in Mexico. Contour, MicroLeaching, PolyTuff, ChamberSpacer, MultiPort, PosiLock, QuickCut, QuickPlay, SnapLock and StraightLock are trademarks of Infiltrator Water Technologies. PolyLok is a trademark of PolyLok, Inc. TUF-TITE is a registered trademark of TUF-TITE, INC. Ultra-Rib is a trademark of IPEX Inc.

© 2016 Infiltrator Water Technologies, LLC. All rights reserved. Printed in U.S.A.

Q25 0816

**Contact Infiltrator Water Technologies' Technical Services Department for assistance at 1-800-221-4436**

## INFORMATION FOR THE CONTRACTOR

The permit should be read very carefully prior to bidding. The following are details that must be considered by the contractor prior to and during installation:

- Tanks shall be approved by NCDHHS and certification supplied by the manufacturer.
- The installer shall be responsible to the owner for placement of the tanks and to ensure that final grades are returned to the original grade, with exception of added structural features.
- The supply trench shall be compacted to eliminate cavities left during initial fill placement without damage or displacement of pipe or fittings.
- Installation of the system shall be during dry conditions in order to protect the soil structure.
- All fittings shall be pressure rated fittings.
- All joints shall be cleaned with PVC pipe cleaner and a heavy-bodied PVC pipe glue applied to weld all joints.
- Where required by the regulating County Health Department, post installation inspections by the Designer or his representative must be scheduled 5 week days in advance.
- Trenches shall be carefully excavated so the bottom is level **for the entire length and width of the trench**. If the trench bottom level needs adjusting after excavation it **must** be done by removing high points rather than filling low points. It is extremely important to insure that trenches are not over-excavated during initial trenching. All fine grading within the trench will be done by hand with a shovel. No loose material will be left in the trench.
- All pipe openings in the tanks shall be properly filled with press boot seal. This also applies to the joints around the riser.
- All tanks shall be properly back filled and compacted to prevent settlement.
- Earth dams, constructed of relatively impervious material, shall be installed at the beginning and end of each lateral.
- No heavy equipment shall be used on the field during or after installation. The use of a small loader (i.e. Bobcat) or a trencher (i.e. Ditch Witch 2300/2310) may be used for installation.
- Elevations at pin flag locations should be checked by the contractor prior to beginning trench excavation.
- Pump tank riser shall be 6" above grade, control panel shall be 18" above grade.
- Septic tank shall have specified effluent filter or approved equivalent.

### System Specifics:

- System uses Quick 4 Chamber drain line.
- Repair uses Quick 4 Chamber drain line.

# Miscellaneous errors and omissions

Markel has over 35 years of experience providing miscellaneous errors and omissions insurance. Our leadership has a wealth of knowledge and expertise in protecting small business owners from litigation stemming from actual or perceived negligence. Our underwriting team has crafted policies that fit your specific needs, while our seasoned, in-house claims professionals will help you successfully navigate a loss or claim should you need their assistance.

## Reporting new professional liability claims

New Claims can be reported in writing by website, email, fax, or regular mail. Please refer to your specific policy for all relevant reporting requirements.

To report a new claim, visit [markelinsurance.com/file-a-claim](http://markelinsurance.com/file-a-claim) and select "BOP/Miscellaneous errors and omissions/Workers compensation" from the drop down. You can also email [newclaims@markelcorp.com](mailto:newclaims@markelcorp.com) and include the following:

- Policy number
- Insured and claimant names with contact details
- Date of loss
- Location and description of loss
- All pertinent documentation available (incident report, police report, witness information, photos, etc.)

## General claims questions

For information about an already reported Professional Liability claim, email: [markelclaims@markelcorp.com](mailto:markelclaims@markelcorp.com), or contact your assigned claim examiner directly.

Additional contact information:

(800) 362-7535 or (800) 3 MARKEL

(855) 662-7535 or (855) 6 MARKEL

Markel Claims Department, P.O. Box 2009,  
Glen Allen, VA 23058-2009

While your policy is primarily designed to protect against a variety of professional errors and omissions claims, it may also provide protection for other specific exposures such as pollution claims, disciplinary proceedings, third party discrimination claims, subpoena and public relations expenses, among others. Contact your agent for more information, or if you have reported a Claim, your assigned examiner.

For more information about our programs, risk management articles, and FAQs, please visit [markelinsurance.com](http://markelinsurance.com). To pay your bill or view policy documents, please visit [portal.markelinsurance.com](http://portal.markelinsurance.com).

Products and services are offered through Markel Specialty, a business division of Markel Service Incorporated. Policies are written by one or more Markel insurance companies. Terms and conditions for rate and coverage may vary. 201806

## Risk management and loss prevention

Policyholders have access to loss control and risk management resources that can assist in a better understanding of potential hazards within their operation and ways to reduce claims.

Here's a sample of the many services available:

- Exposure assessments
- Loss analysis tools
- Safety videos
- Safety training materials
- Regulatory program guidance

## Designed Protection® for professional service providers and associations – professional service providers hotline

Our panel of Risk Management experts is available to discuss general risk management related concerns and questions. Please visit [markelcorp.com/riskmanagement](http://markelcorp.com/riskmanagement) and under "Designed Protection®" click "Click here," enter your policy number, then select "Professional Service Providers Hotline" to access our panel of experts.

Visit our website at:

[markelinsurance.com/risk-management-home](http://markelinsurance.com/risk-management-home).

For more information about any of Markel's loss control services, contact us at (888) 500-3344 or email [losscontrol@markelcorp.com](mailto:losscontrol@markelcorp.com).





# CERTIFICATE OF LIABILITY INSURANCE

DATE (MM/DD/YYYY)

11/26/2024

THIS CERTIFICATE IS ISSUED AS A MATTER OF INFORMATION ONLY AND CONFERS NO RIGHTS UPON THE CERTIFICATE HOLDER. THIS CERTIFICATE DOES NOT AFFIRMATIVELY OR NEGATIVELY AMEND, EXTEND OR ALTER THE COVERAGE AFFORDED BY THE POLICIES BELOW. THIS CERTIFICATE OF INSURANCE DOES NOT CONSTITUTE A CONTRACT BETWEEN THE ISSUING INSURER(S), AUTHORIZED REPRESENTATIVE OR PRODUCER, AND THE CERTIFICATE HOLDER.

**IMPORTANT:** If the certificate holder is an ADDITIONAL INSURED, the policy(ies) must be endorsed. If SUBROGATION IS WAIVED, subject to the terms and conditions of the policy, certain policies may require an endorsement. A statement on this certificate does not confer rights to the certificate holder in lieu of such endorsement(s).

<b>PRODUCER</b> Wade Associates, LLC 250 Pollock St.  New Bern NC 28560	<b>CONTACT NAME:</b> Angela Sensenig <b>PHONE (A/C No. Ext):</b> (252)631-5269 <b>E-MAIL ADDRESS:</b> asensenig@wadeict.com	<b>FAX (A/C No):</b> (252)649-2443
	<b>INSURER(S) AFFORDING COVERAGE</b>	
<b>INSURED</b> Permit Acquisition Company One, PLLC 920 Garner Rd  Selma NC 27576	<b>INSURER A:</b> Starstone Specialty Insurance Company	<b>NAIC #</b> 44776
	<b>INSURER B:</b> Builders Mutual Insurance Company	<b>NAIC #</b> 10844
	<b>INSURER C:</b>	
	<b>INSURER D:</b>	
	<b>INSURER E:</b>	
	<b>INSURER F:</b>	

**COVERAGES**

CERTIFICATE NUMBER: 24-25

REVISION NUMBER:

THIS IS TO CERTIFY THAT THE POLICIES OF INSURANCE LISTED BELOW HAVE BEEN ISSUED TO THE INSURED NAMED ABOVE FOR THE POLICY PERIOD INDICATED. NOTWITHSTANDING ANY REQUIREMENT, TERM OR CONDITION OF ANY CONTRACT OR OTHER DOCUMENT WITH RESPECT TO WHICH THIS CERTIFICATE MAY BE ISSUED OR MAY PERTAIN, THE INSURANCE AFFORDED BY THE POLICIES DESCRIBED HEREIN IS SUBJECT TO ALL THE TERMS, EXCLUSIONS AND CONDITIONS OF SUCH POLICIES. LIMITS SHOWN MAY HAVE BEEN REDUCED BY PAID CLAIMS.

INSR LTR	TYPE OF INSURANCE	ADDL INSD	SUBR WVD	POLICY NUMBER	POLICY EFF (MM/DD/YYYY)	POLICY EXP (MM/DD/YYYY)	LIMITS		
A	<input checked="" type="checkbox"/> COMMERCIAL GENERAL LIABILITY <input type="checkbox"/> CLAIMS-MADE <input checked="" type="checkbox"/> OCCUR  GEN'L AGGREGATE LIMIT APPLIES PER: <input checked="" type="checkbox"/> POLICY <input type="checkbox"/> PRO-JECT <input type="checkbox"/> LOC OTHER:			SSEP0476240AEM	11/22/2024	11/22/2025	EACH OCCURRENCE	\$ 1,000,000	
								DAMAGE TO RENTED PREMISES (Ea occurrence)	\$ 100,000
							MED EXP (Any one person)	\$ 10,000	
							PERSONAL & ADV INJURY	\$ 1,000,000	
							GENERAL AGGREGATE	\$ 2,000,000	
							PRODUCTS - COMP/OP AGG	\$ 2,000,000	
								\$	
							COMBINED SINGLE LIMIT (Ea accident)	\$	
							BODILY INJURY (Per person)	\$	
							BODILY INJURY (Per accident)	\$	
							PROPERTY DAMAGE (Per accident)	\$	
								\$	
							EACH OCCURRENCE	\$	
							AGGREGATE	\$	
								\$	
B	<b>WORKERS COMPENSATION AND EMPLOYERS' LIABILITY</b> ANY PROPRIETOR/PARTNER/EXECUTIVE OFFICER/MEMBER EXCLUDED? (Mandatory in NH) If yes, describe under DESCRIPTION OF OPERATIONS below	Y/N	N/A	69K0UB-5N24039-7-24	11/14/2024	11/14/2025	<input checked="" type="checkbox"/> PER STATUTE <input type="checkbox"/> OTH-ER		
								E.L. EACH ACCIDENT	\$ 500,000
								E.L. DISEASE - EA EMPLOYEE	\$ 500,000
								E.L. DISEASE - POLICY LIMIT	\$ 500,000
A	<b>Errors &amp; Omissions</b>			SSEP0476240AEM	11/22/2024	11/22/2025	Each Occurrence	\$1,000,000	
							General Aggregate	\$2,000,000	

DESCRIPTION OF OPERATIONS / LOCATIONS / VEHICLES (ACORD 101, Additional Remarks Schedule, may be attached if more space is required)

**CERTIFICATE HOLDER****CANCELLATION**

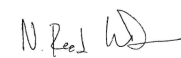
Smith Douglas Homes 3412 Apex Peakway Apex, NC 27502	SHOULD ANY OF THE ABOVE DESCRIBED POLICIES BE CANCELLED BEFORE THE EXPIRATION DATE THEREOF, NOTICE WILL BE DELIVERED IN ACCORDANCE WITH THE POLICY PROVISIONS.  AUTHORIZED REPRESENTATIVE  N Whitsett/RACHEL 
--	--

© 1988-2014 ACORD CORPORATION. All rights reserved.

ACORD 25 (2014/01)

The ACORD name and logo are registered marks of ACORD

INS025 (201401)



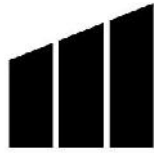

**MARKEL**

**MARKEL INSURANCE COMPANY**

10275 West Higgins Road, Suite 750  
Rosemont, IL 60018  
(800) 431-1270

**INSURANCE POLICY**

**Coverage afforded by this policy is provided by the Company (Insurer) and named in the Declarations.**

In **Witness Whereof**, the company (insurer) has caused this policy to be executed and attested and countersigned by a duly authorized representative of the company (insurer) identified in the Declarations.

*Kathleen Anne Sturgeon*

*Ray W. Sales*

\_\_\_\_\_  
**Secretary**

\_\_\_\_\_  
**President**



## **MARKEL INSURANCE COMPANY**

### **NOTICE TO POLICYHOLDERS CLAIM REPORTING**

Please immediately report a new claim under this policy to:

**[newclaims@markel.com](mailto:newclaims@markel.com)**

For general claims inquiries after a claim has been reported, please email:

**[markelclaims@markel.com](mailto:markelclaims@markel.com)**

In order for us to expedite the handling of your claim and quickly refer it to the appropriate party, please have the following information available:

- Claim number (or report as new)
- Your name, contact information and position with the Named Insured
- Date of loss
- Policy number and insured name
- Details of loss

Our address and additional contact information are as follows:

Markel Claims  
P.O. Box 2009  
Glen Allen, VA 23058-2009  
Phone: 800-362-7535 (800) 3MARKEL  
Fax: 855-662-7535 (855) 6MARKEL

Markel understands the importance of having knowledgeable claims professionals prepared to answer your questions with personal attention and expertise. With claims professionals located across four time zones, you are sure to find the claims assistance you need -- when you need it.

**PLEASE REFER TO THE POLICY FOR ANY NOTICE AND REPORTING PROVISIONS  
AND DUTIES IN THE EVENT OF LOSS OR DAMAGE TO COVERED PROPERTY.**



## MARKEL INSURANCE COMPANY

### U.S. TREASURY DEPARTMENT'S OFFICE OF FOREIGN ASSETS CONTROL ("OFAC") ADVISORY NOTICE TO POLICYHOLDERS

No coverage is provided by this Policyholder Notice nor can it be construed to replace any provisions of your policy. You should read your policy and review your Declarations page for complete information on the coverages you are provided.

This Notice provides information concerning possible impact on your insurance coverage due to directives issued by OFAC. **Please read this Notice carefully.**

The Office of Foreign Assets Control (OFAC) administers and enforces sanctions policy, based on Presidential declarations of "national emergency". OFAC has identified and listed numerous:

- Foreign agents;
- Front organizations;
- Terrorists;
- Terrorist organizations; and
- Narcotics traffickers;

as "Specially Designated Nationals and Blocked Persons". This list can be located on the United States Treasury's web site – <https://www.treasury.gov/ofac>.

In accordance with OFAC regulations, if it is determined that you or any other insured, or any person or entity claiming the benefits of this insurance has violated U.S. sanctions law or is a Specially Designated National and Blocked Person, as identified by OFAC, this insurance will be considered a blocked or frozen contract and all provisions of this insurance are immediately subject to OFAC. When an insurance policy is considered to be such a blocked or frozen contract, no payments nor premium refunds may be made without authorization from OFAC. Other limitations on the premiums and payments also apply.



PROFESSIONAL LIABILITY INSURANCE DECLARATIONS

Claims Made and Reported Coverage: The coverage afforded by this policy is limited to liability for only those Claims that are first made against the Insured during the Policy Period or the Extended Reporting Period, if exercised, and reported to Markel Insurance Company during the Policy Period or the Extended Reporting Period, if exercised, or within 60 days after the expiration of the Policy Period or the Extended Reporting Period, if exercised.

Notice: This policy contains provisions that reduce the Limits of Liability stated in the policy by the costs of legal defense and permit legal defense costs to be applied against the deductible, unless the policy is amended by endorsement. Please read the policy carefully.

POLICY NUMBER: MEO1642-05

RENEWAL OF POLICY: MEO1642-04

NAMED INSURED: Permit Acquisition Company-One LLC

BUSINESS ADDRESS: 920 Garner Road
Selma, NC 27576

POLICY PERIOD: From 11/22/2023 to 11/22/2024

12:01 A.M. Standard Time at address of Insured stated above.

IN RETURN FOR THE PAYMENT OF THE PREMIUM, AND SUBJECT TO ALL THE TERMS OF THIS POLICY, THE COMPANY AGREES WITH THE NAMED INSURED TO PROVIDE THE INSURANCE AS STATED IN THIS POLICY.

1. PROFESSIONAL SERVICES: soil science

2. LIMITS OF LIABILITY

Professional Liability Coverage

- A. Each Claim: \$2,000,000
B. Policy Aggregate: \$2,000,000

Additional Payments

- A. Contingent Bodily Injury And Property Damage \$100,000
B. Pollution \$10,000
C. Pre-Claim Assistance Expenses \$20,000
D. Sexual Abuse \$10,000
E. Third Party Discrimination \$25,000

Supplementary Payments

- A. Disciplinary Proceeding \$25,000 per Policy Period
B. Loss Of Earnings And Expense Reimbursement \$10,000
C. Public Relations Expenses \$5,000
D. Subpoena And Record Request Assistance \$5,000

Table with 1 column: Producer Number, Name and Mailing Address. Row 1: 98496, Wade Associates, LLC. - New Bern, PO Box 1209, Davidson, NC, 28036

**3. DEDUCTIBLE**

- A. Each Claim: \$1,000
- B. Aggregate: \$3,000

**4. RETROACTIVE DATE:** 11/22/2019

**5. PREMIUM RATE:** Flat

**PREMIUM BASE:** Flat

**6. PREMIUM FOR POLICY PERIOD**

- Minimum: \$560
- Deposit: \$560
- Adjusted Annual Premium: \$560

**7. PREMIUM PERCENTAGE FOR EXTENDED REPORTING PERIOD:  
ADDITIONAL PERIOD:**

**8. FORMS AND ENDORSEMENTS ATTACHED AT POLICY INCEPTION:**

See MDIL 1001 attached.

**These declarations, together with the Coverage Form and any Endorsement(s), complete the above numbered policy.**

Countersigned: 08/30/2023	<p>By: </p> <hr/> <p>Authorized Representative Signature</p>
(Date)	