

Typical Exterior Elevation
Fyre-Tec Series 950 Fixed Lite Window
 45- or 60-Minute UL Rated

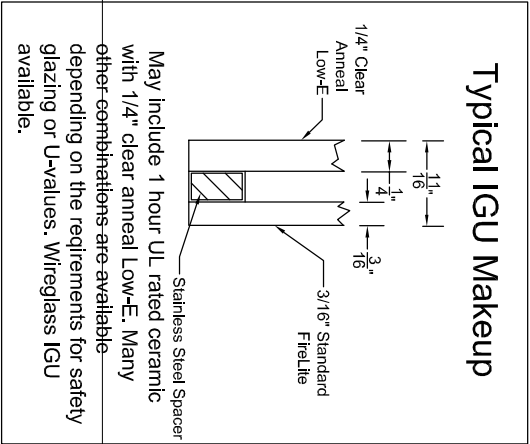

Series 950 Fixed Lite Window

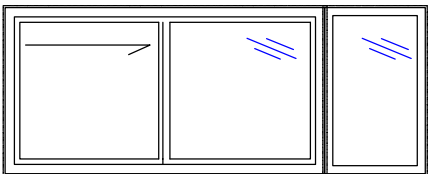
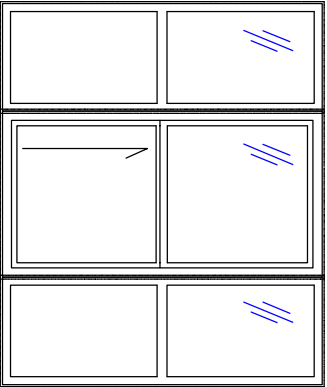
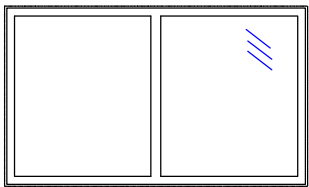
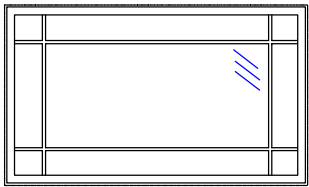
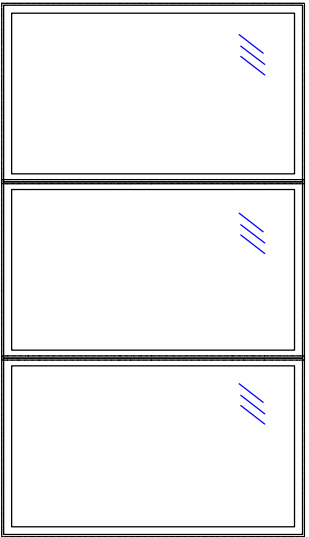

P.O. Box 278, 701 Centennial Road
 Wayne, NE 68787

DESIGN BY: JDD
 CHECKED BY: JDD
 DATE: 11-30-2015
 SCALE: 1/8"

TOLERANCE:
 1. FRACTIONS +/- 1/16
 2. DECIMALS +/- .0625
 3. ANGLES +/- 1/2 DEGREE
 EXCEPT AS NOTED

PAGE 1/3
 DWG No. MODEL 950

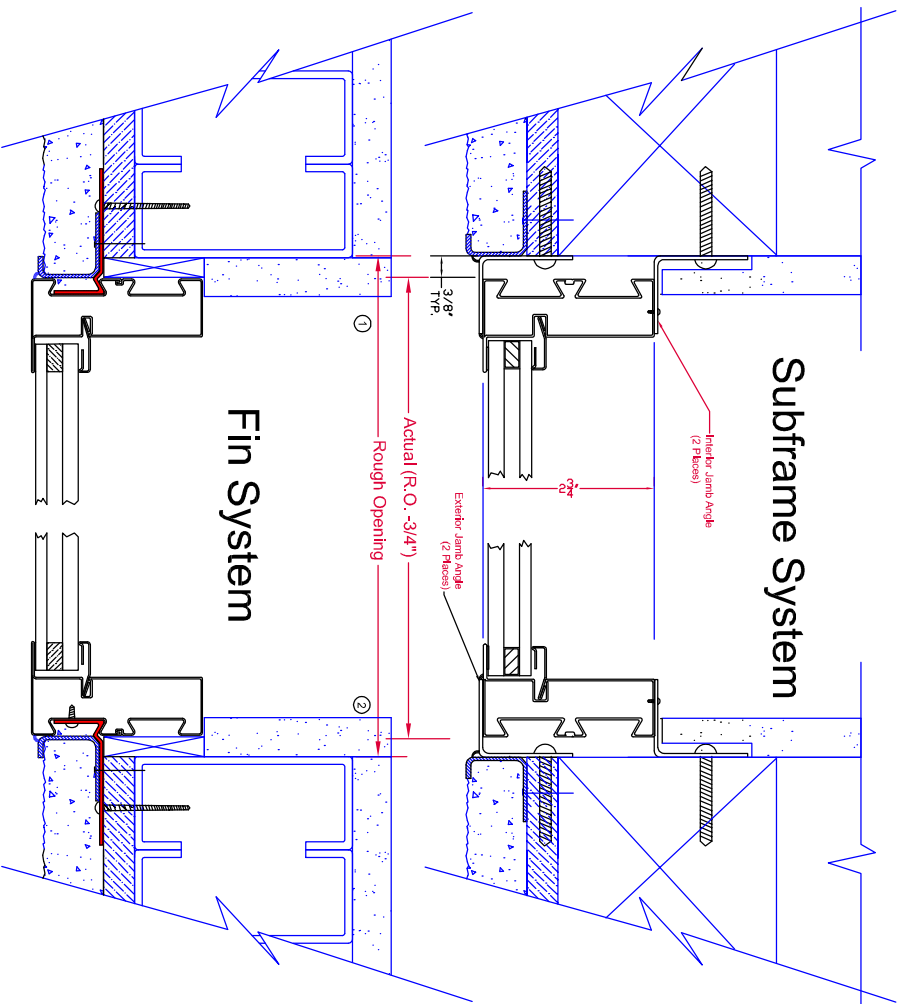

JAMB

DRAWN BY
JDD

CHK'D BY

DATE
11-30-2015

SCALE
1:2

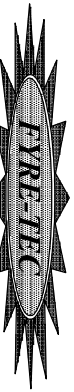

P.O. Box 278, 701 Centennial Road
Wayne, NE 68787

PAGE 3/3
DWG NO. MODEL 950

- TOLERANCE:
1. FRACTIONS ±1/16
 2. DECIMALS ±.0625
 3. ANGLES ± 1/2 DEGREE
- EXCEPT AS NOTED

MATERIAL

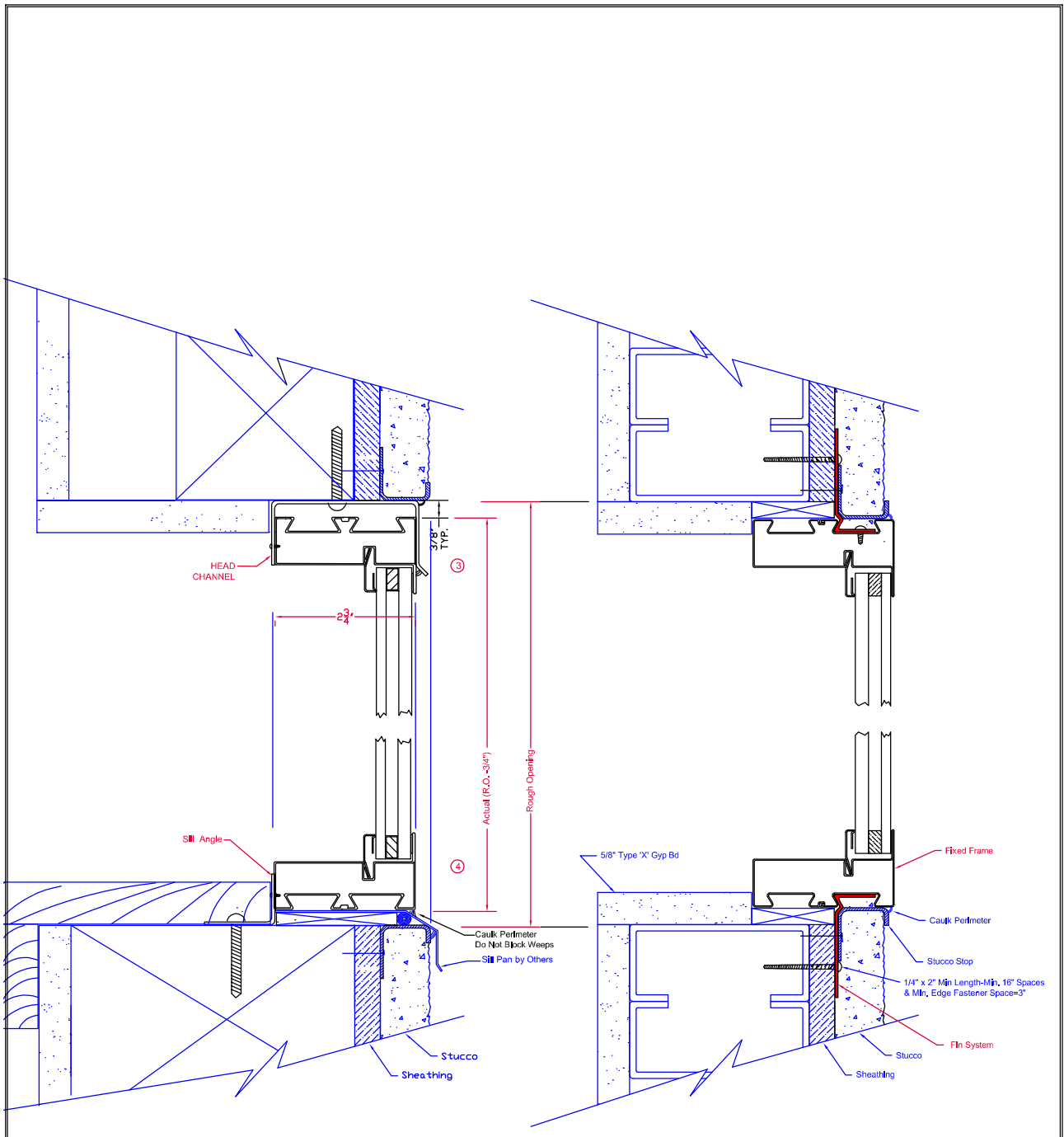

Subframe System

Fin System

HEAD/SILL

DWN BY
JDD
CK'D BY

DATE
11-30-2015

TOLERANCE:
1. FRACTIONS ±1/16
2. DECIMALS ±.0625
3. ANGLES ± 1/2 DEGREE
EXCEPT AS NOTED

MAT'L

SCALE
1:2

PAGE
2/3

DWG No. MODEL 950



P.O. Box 278, 701 Centennial Road
Wayne, NE 68787