

ALL NON-MASONRY RETURNS TO BE HORIZONTAL SIDING

SEE SHEET D3 OF SDH TYPICAL DETAILS FOR SOFFIT DETAILS PER SOFFIT MATERIAL

HARRINGTON PLACE LOT 44

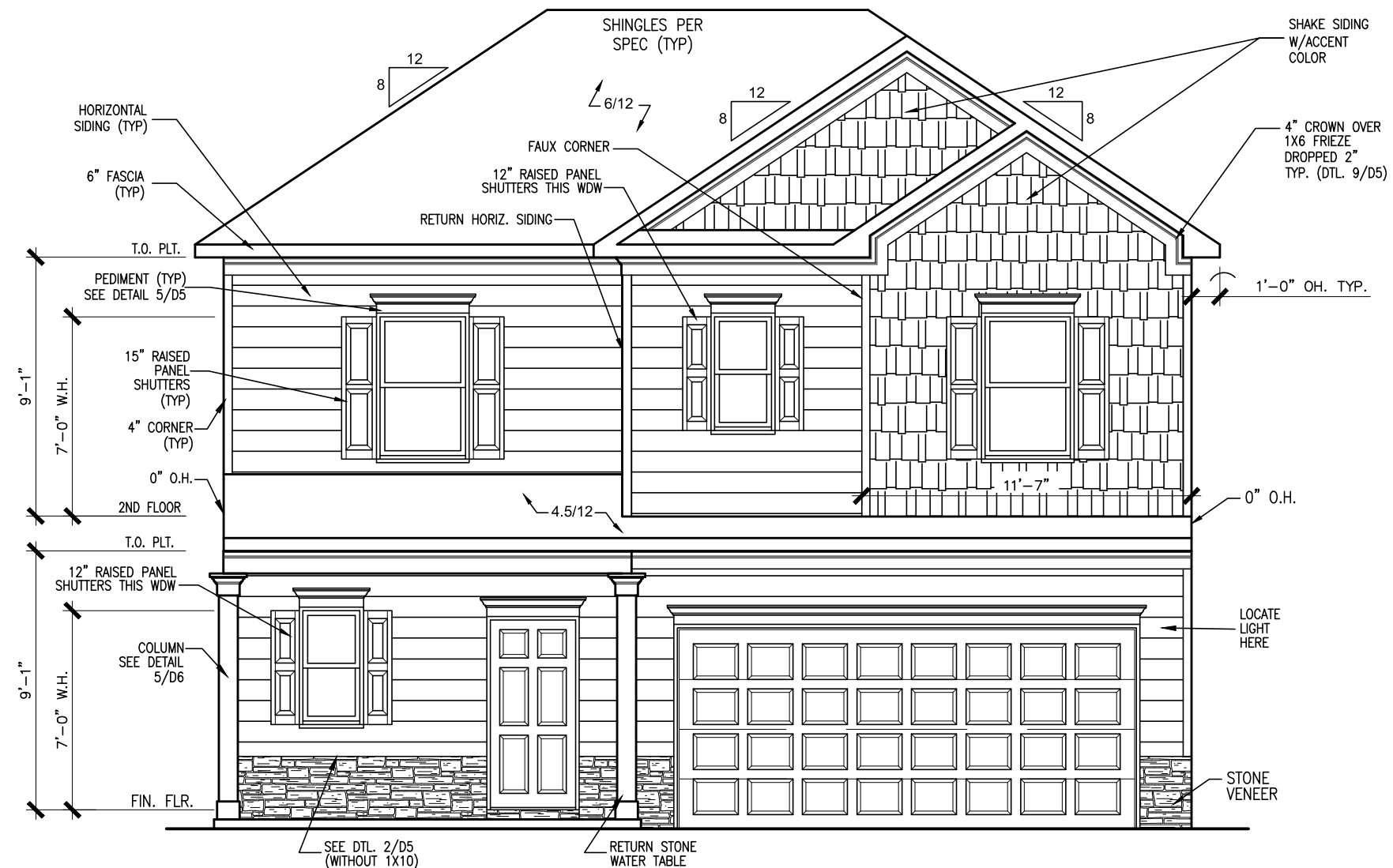

FRONT ELEVATION "C"
SCALE: 3/16"=1'-0"

BY	REVISION	DATE
#	#	#
#	#	#
#	#	#
#	#	#
#	#	#

SMITH DOUGLAS HOMES
QUALITY | INTEGRITY | VALUE

ELEVATIONS
FRONT ELEVATION
BENSON II

SMITH DOUGLAS HOMES
110 VILLAGE TRAIL
SUITE 115
WOODSTOCK, GA 30188
www.smithdouglas.com

SMITH DOUGLAS HOMES expressly reserves its property rights in these plans and drawings. These plans and related drawings are not to be reproduced without written consent from SMITH DOUGLAS HOMES.

BY: SL	CH: AW
DATE: 9/6/2024	
FACADE OPT: C	
PLAN ID:	
FND: ALL	ELEV: C
PAGE NO: A1.1	

HARRINGTON PLACE LOT 44

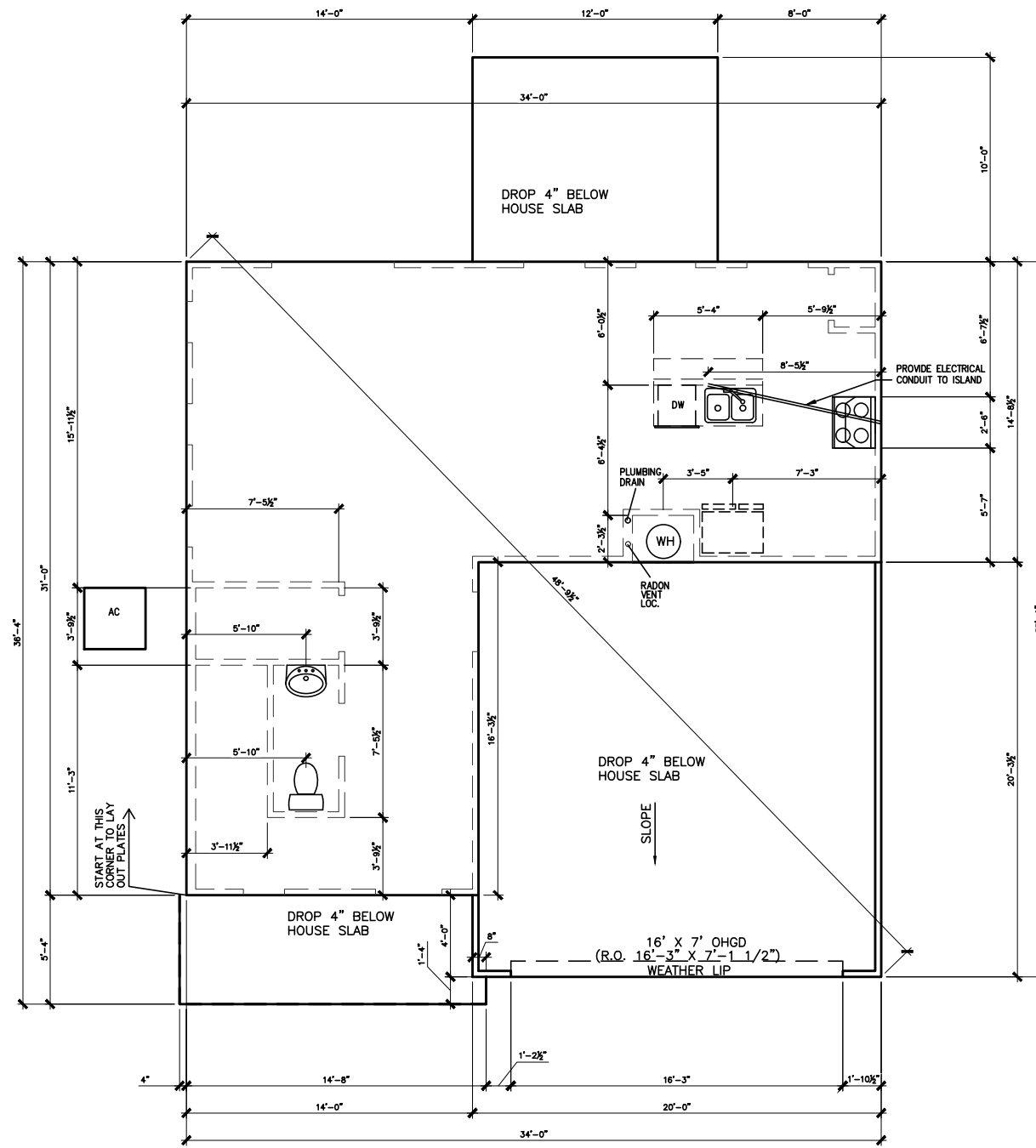

SLAB PLAN

SCALE: 1/8" = 1'-0"

*RADON VENT PROVIDED PER LOCAL CODE

REFER TO DETAIL 3/D1 FOR BRICK LEDGE DETAIL WHEN BRICK VENEER IS CHOSEN

DATE	REVISION	BY



FOUNDATION PLAN
SLAB PLAN
BENSON II

SMITH DOUGLAS HOMES
110 VILLAGE TRAIL
SUITE 115
WOODSTOCK, GA 30188
www.smithdouglas.com

SMITH DOUGLAS HOMES expressly reserves its property rights in these plans and drawings. These plans and related drawings are not to be reproduced without written consent from SMITH DOUGLAS HOMES.

BY: SL	CH: AW
DATE: 9/6/2024	
FACADE OPT: C	
PLAN ID:	
FND: ALL	ELEV: C
PAGE NO: A3.1	

HARRINGTON PLACE LOT 44

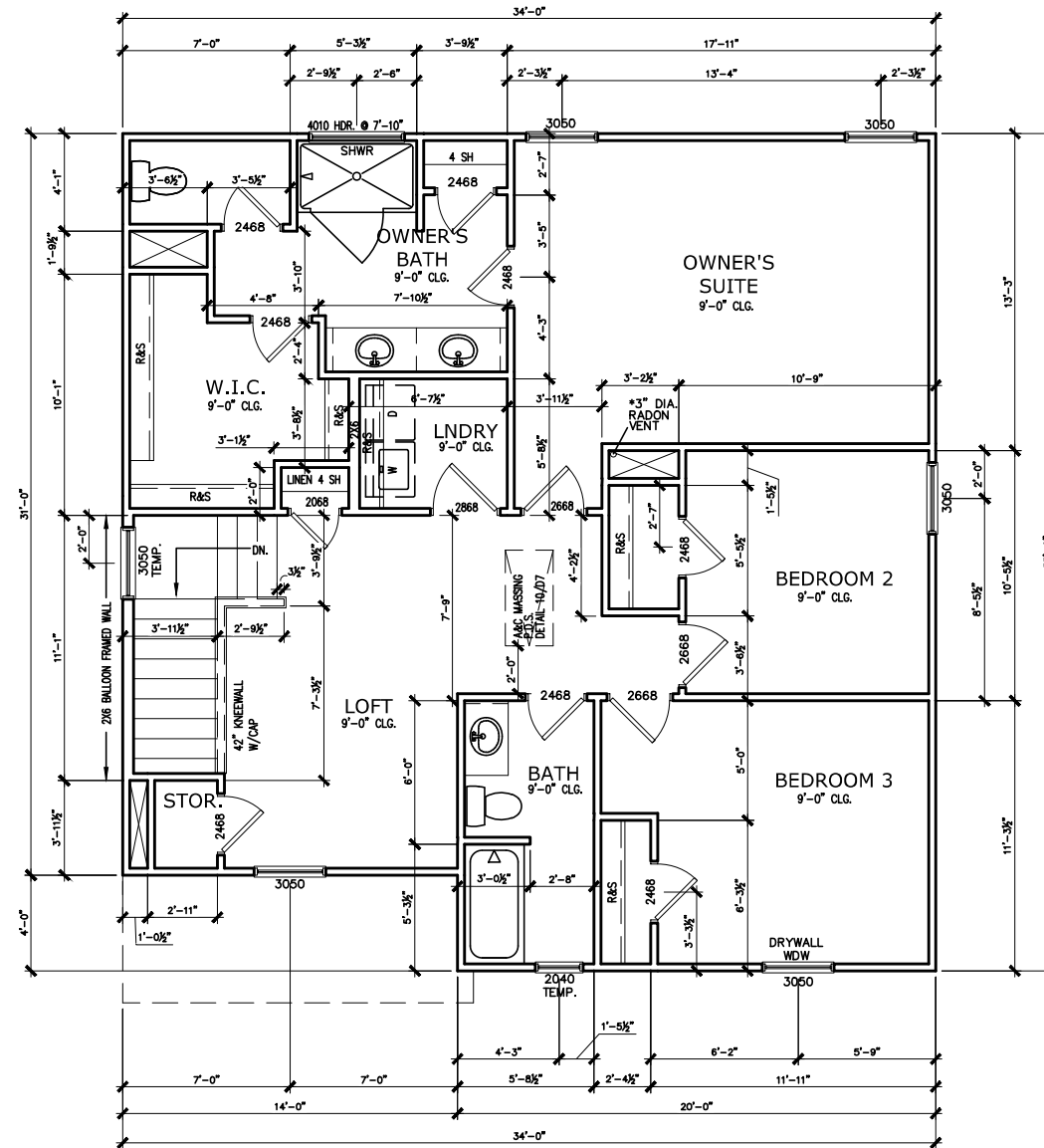

SECOND FLOOR PLAN

SCALE: 1/8" = 1'-0"

*RADON VENT PROVIDED
PER LOCAL CODE

REFER TO MANUFACTURER'S SPECS.
FOR DRAIN LOCATIONS ON DETAIL
SHEETS D12, D12.1, D12.2 & D12.3

DATE	REVISION	BY



FLOOR PLAN
SECOND FLOOR
BENSON II

SMITH DOUGLAS HOMES
110 VILLAGE TRAIL
SUITE 115
WOODSTOCK, GA 30188
www.smithdouglas.com

SMITH DOUGLAS HOMES
expressly reserves its
property rights in these
plans and drawings.
These plans and related
drawings are not to be
reproduced without written
consent from SMITH
DOUGLAS HOMES.

BY: SL	CH: AW
DATE: 9/6/2024	
FACADE OPT: C	
PLAN ID:	
FND: ALL	ELEV: C
PAGE NO: A5.2	

HARRINGTON PLACE LOT 44

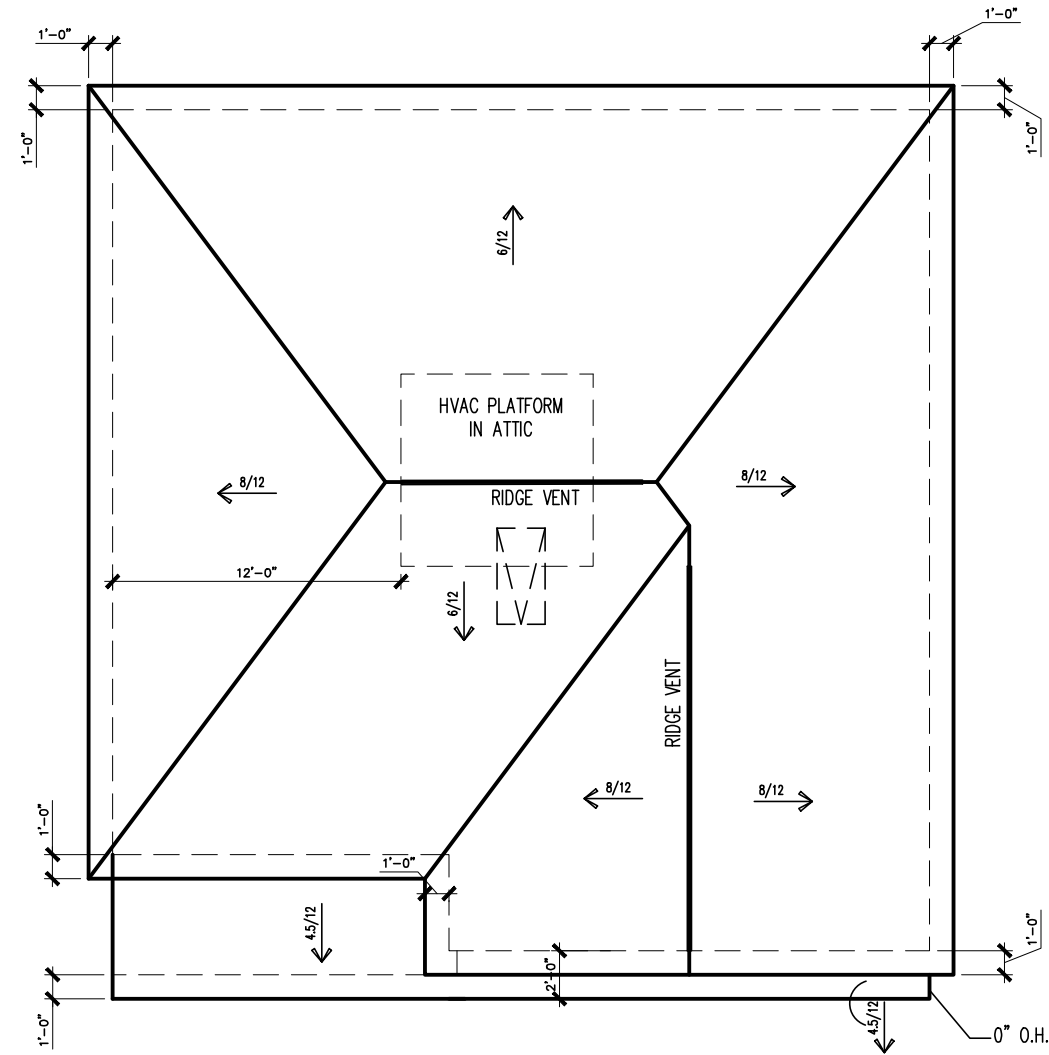

ROOF LAYOUT "C"
SCALE: 1/8" = 1'-0"

DATE	REVISION	BY
#	#	#
#	#	#
#	#	#
#	#	#
#	#	#



ROOF PLAN
ROOF PLAN
BENSON II

SMITH DOUGLAS HOMES
110 VILLAGE TRAIL
SUITE 115
WOODSTOCK, GA 30188
www.smithdouglas.com

SMITH DOUGLAS HOMES expressly reserves its property rights in these plans and drawings. These plans and related drawings are not to be reproduced without written consent from SMITH DOUGLAS HOMES.

BY: SL	CH: AW
DATE: 9/6/2024	
FACADE OPT: C	
PLAN ID:	
FND: ALL	ELEV: C
PAGE NO: A6.1	

HARRINGTON PLACE LOT 44

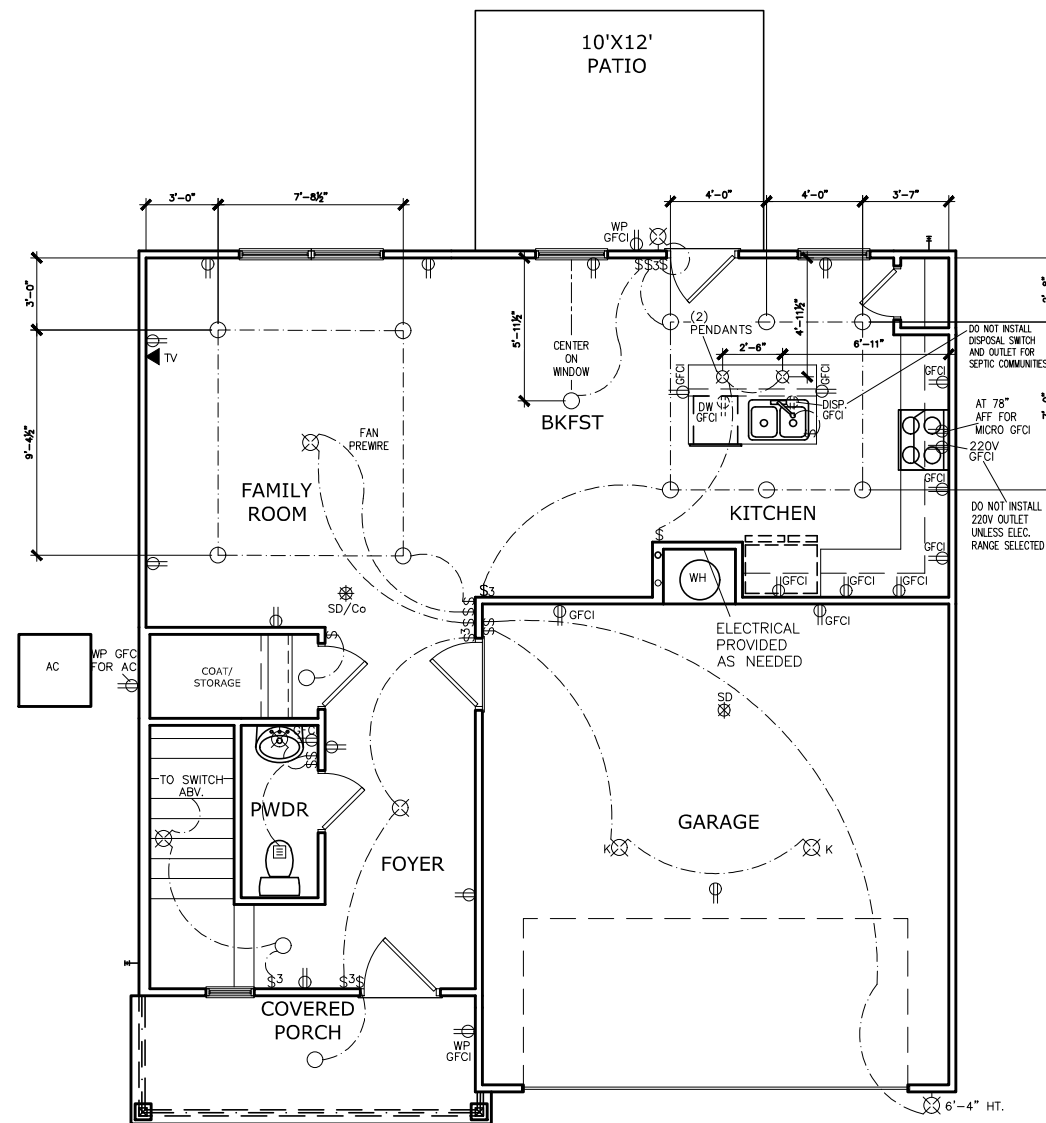

FIRST FLOOR ELECTRICAL PLAN

SCALE : 1/8" = 1'-0"

ELECTRICAL LEGEND			
\$	SWITCH	TV	TV
\$3	3 WAY SWITCH	⊕	120V RECEPTACLE
\$4	4 WAY SWITCH	⊕	120V SWITCHED RECEPTACLE
⊗	CEILING FIXTURE	⊕	220V RECEPTACLE
⊕	KEYLESS	⊕	GFCI OUTLET
⊕	WALL MOUNT FIXTURE	⊕	ARCH FAULT CIRCUIT INTERRUPTER
⊕	CEILING FIXTURE	†GL	GAS LINE
⊕	FLEX CONDUIT	†WL	WATER LINE
CH	CHIMES	⊥	HOSE BIBB
PH	TELEPHONE	⊕	FLOOD LIGHT
SD/Co	SMOKE DETECTOR & CARBON MONOXIDE	⊕	1x4 LUMINOUS FIXTURE
SO	SECURITY OUTLET	⊕	CEILING FAN
□	GARAGE DOOR OPENER	—	ELECTRICAL WIRING
⊕	EXHAUST FAN	⊕	CEILING FIXTURE
⊕	FAN/LIGHT		
ELECTRICAL PLANS TO FOLLOW ALL LOCAL CODES			
APPROX. FIXTURE HGTS (MEASURED FROM BOTTOM OF FIXTURE)			
BREAKFAST/DINING ROOM	63" ABOVE FINISHED FLOOR		
KITCHEN PENDANT LIGHTS	33" ABOVE COUNTER TOP		
TWO STORY FOYER FIXTURE	96" ABOVE FINISHED FLOOR		
CEILING FAN	96" ABOVE FINISHED FLOOR		
FLOOD LIGHT	10' MAX. ABOVE FIN. FLOOR		

NOTE: FINAL PLACEMENT OF PHONE/CABLE T.B.D. ON SITE BY THE BUILDER

BY	REVISION	#	#	#	#	#
DATE						



ELECTRICAL PLAN
FIRST FLOOR
BENSON II

SMITH DOUGLAS HOMES
110 VILLAGE TRAIL
SUITE 115
WOODSTOCK, GA 30188
www.smithdouglas.com

SMITH DOUGLAS HOMES expressly reserves its property rights in these plans and drawings. These plans and related drawings are not to be reproduced without written consent from SMITH DOUGLAS HOMES.

BY: SL	CH: AW
DATE: 9/6/2024	
FACADE OPT: C	
PLAN ID:	
FND: ALL	BLV: C
PAGE NO: A7.2	

HARRINGTON PLACE LOT 44

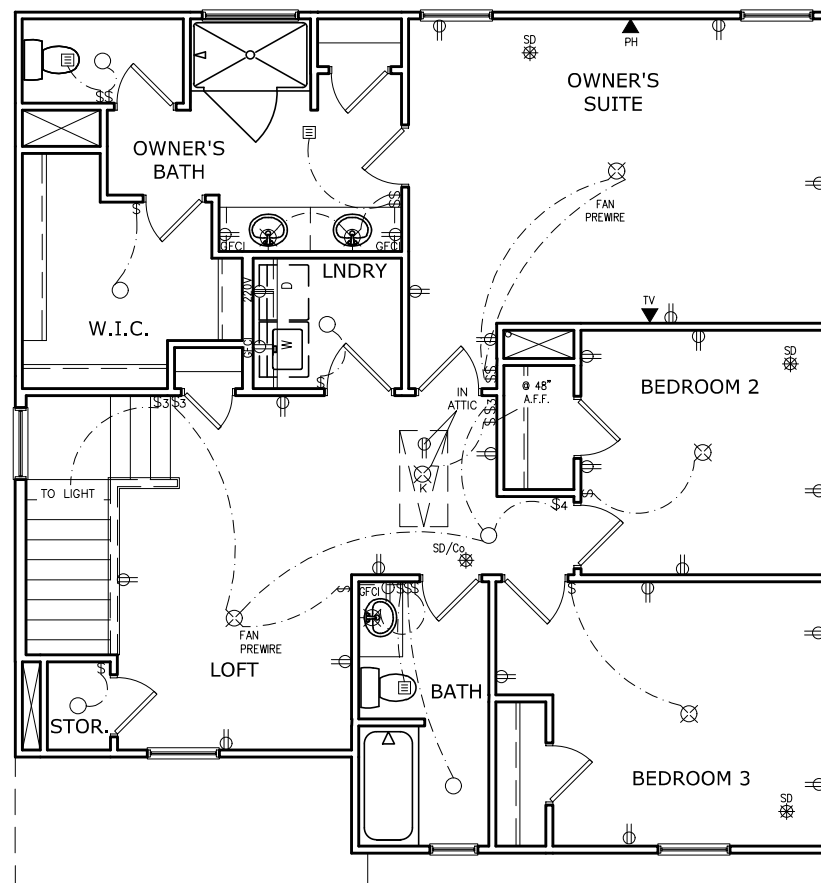

SECOND FLOOR ELECTRICAL PLAN

SCALE: 1/8" = 1'-0"

ELECTRICAL LEGEND			
§	SWITCH	TV	TV
§3	3 WAY SWITCH	⊕	120V RECEPTACLE
§4	4 WAY SWITCH	⊕	120V SWITCHED RECEPTACLE
⊗	CEILING FIXTURE	⊕	220V RECEPTACLE
⊕	KEYLESS	⊕	GFCI OUTLET
⊕	WALL MOUNT FIXTURE	⊕	ARCH FAULT CIRCUIT INTERRUPTER
○	CEILING FIXTURE	†	GAS LINE
●	FLEX CONDUIT	†	WATER LINE
CH	CHIMES	⊥	HOSE BIBB
PH	TELEPHONE	⊕	FLOOD LIGHT
SD/CO	SMOKE DETECTOR & CARBON MONOXIDE	⊕	1x4 LUMINOUS FIXTURE
SO	SECURITY OUTLET	⊕	CEILING FAN
□	GARAGE DOOR OPENER	⊕	ELECTRICAL WIRING
⊕	EXHAUST FAN	⊕	CEILING FIXTURE
⊕	FAN/LIGHT		
ELECTRICAL PLANS TO FOLLOW ALL LOCAL CODES			
APPROX. FIXTURE HGTS (MEASURED FROM BOTTOM OF FIXTURE)			
BREAKFAST/DINING ROOM	63" ABOVE FINISHED FLOOR		
KITCHEN PENDANT LIGHTS	33" ABOVE COUNTER TOP		
TWO STORY FOYER FIXTURE	96" ABOVE FINISHED FLOOR		
CEILING FAN	96" ABOVE FINISHED FLOOR		
FLOOD LIGHT	10' MAX. ABOVE FIN. FLOOR		

NOTE: FINAL PLACEMENT OF
PHONE/CABLE T.B.D. ON SITE
BY THE BUILDER

DATE	REVISION	BY
#	#	#
#	#	#
#	#	#
#	#	#
#	#	#



ELECTRICAL PLAN
SECOND FLOOR
BENSON II

SMITH DOUGLAS HOMES
110 VILLAGE TRAIL
SUITE 115
WOODSTOCK, GA 30188
www.smithdouglas.com

SMITH DOUGLAS HOMES expressly reserves its property rights in these plans and drawings. These plans and related drawings are not to be reproduced without written consent from SMITH DOUGLAS HOMES.

BY: SL	CH: AW
DATE: 9/6/2024	
FACADE OPT: C	
PLAN ID:	
FND: ALL	ELEV: C
PAGE NO: A7.3	

HARRINGTON PLACE LOT 44

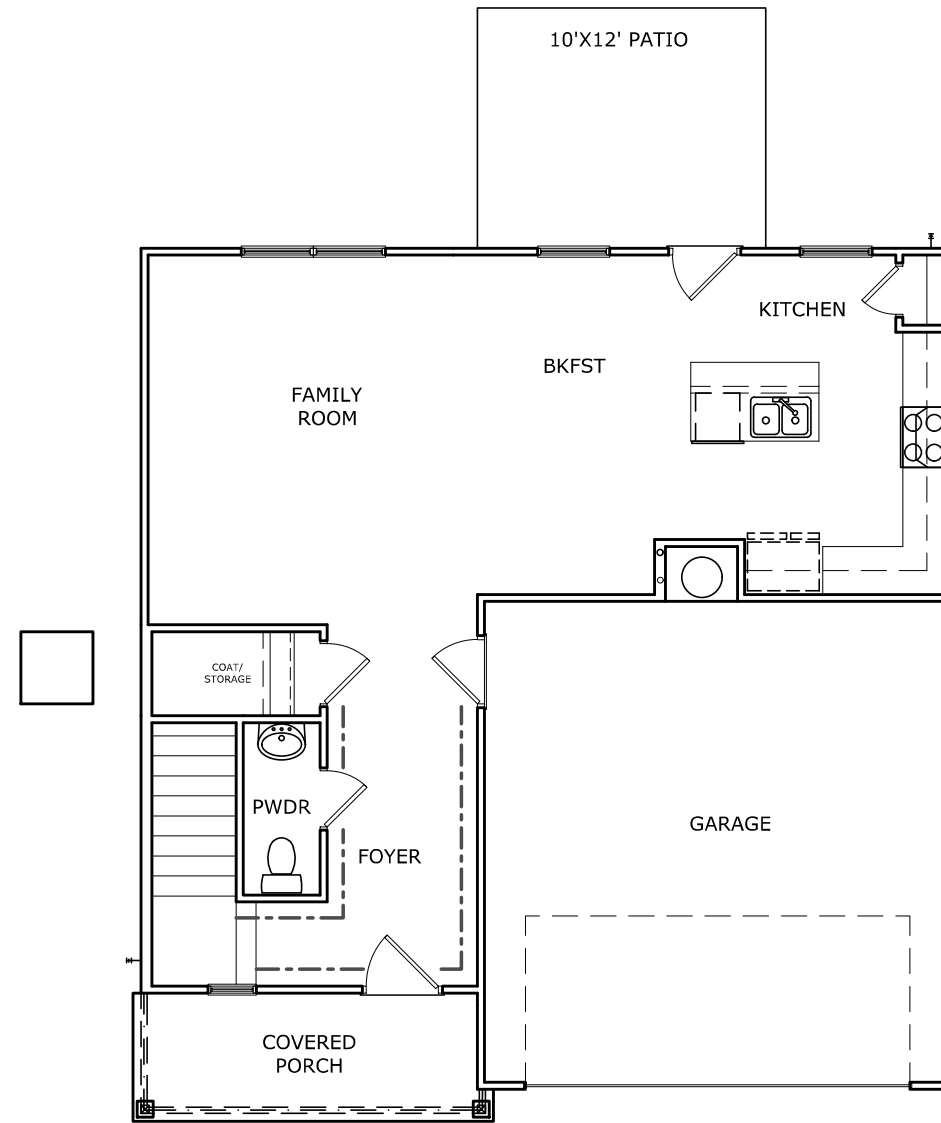

TRIM LAYOUT FIRST FLOOR PLAN

SCALE : 1/8" = 1'-0"

DATE	REVISION	BY
#	#	#
#	#	#
#	#	#
#	#	#
#	#	#



FLOOR PLAN
TRIM LAYOUT
BENSON II

SMITH DOUGLAS HOMES
110 VILLAGE TRAIL
SUITE 115
WOODSTOCK, GA 30188
www.smithdouglas.com

SMITH DOUGLAS HOMES expressly reserves its property rights in these plans and drawings. These plans and related drawings are not to be reproduced without written consent from SMITH DOUGLAS HOMES.

BY: SL	CH: AW
DATE: 9/6/2024	
FACADE OPT: C	
PLAN ID:	
FND: ALL	ELEV: C
PAGE NO: A8.1	

CONNECTION SPECIFICATIONS (TYP. U.N.O.)

DESCRIPTION OF BLDG. ELEMENT	3"x0.131" NAILS	3"x0.120" NAILS
JOIST TO SOLE PLATE	(3) TOENAILS NAILS @ 4" O.C.	(3) TOENAILS* NAILS @ 4" O.C.
SOLE PL. TO JOIST/RIM OR BLK'G STUD TO PLATE	(4) TOENAILS/ (3) END NAILS	(4) TOENAILS/ (4) END NAILS*
RIM TO TOP PLATE	TOENAILS @ 6" O.C.	TOENAILS @ 4" O.C.*
BLK'G. BTWN. JOISTS TO TOP PL.	(3) TOENAILS EA. END	(3) TOENAILS EA. END*
DOUBLE STUD	NAILS @ 16" O.C.	NAILS @ 16" O.C.
DOUBLE TOP PLATE	NAILS @ 12" O.C.	NAILS @ 8" O.C.
DOUBLE TOP PLATE LAP SPLICE	(12) NAILS IN LAPPED AREA (24" MIN.)	(15) NAILS IN LAPPED AREA (24" MIN.)
TOP PLATE LAP @ CORNERS & INTERSECTING WALLS	(3) NAILS	(3) NAILS
RAFTER/TRUSS TO TOP PLATE	(4) TOENAILS + (1) SIMPSON H25T TOENAILS @ 8" O.C.	(4) TOENAILS + (1) SIMPSON H25T TOENAILS @ 6" O.C.
GAB. END TRUSS TO DBL. TOP PL.	TOENAILS @ 8" O.C.	TOENAILS @ 6" O.C.
R.T. w/ HEEL HT. 9 1/4" TO 12"	2x10 BLK EVERY 3RD BAY FASTENED TO DBL. TOP PLATE w/ TOENAILS @ 6" O.C.	2x10 BLK EVERY 3RD BAY FASTENED TO DBL. TOP PLATE w/ TOENAILS @ 4" O.C.
R.T. w/ HEEL HT. 12" TO 16"	2x12 BLK EVERY 3RD BAY FASTENED TO DBL. TOP PLATE w/ TOENAILS @ 6" O.C.	2x12 BLK EVERY 3RD BAY FASTENED TO DBL. TOP PLATE w/ TOENAILS @ 4" O.C.
R.T. w/ HEEL HT. UP TO 24"	LAP WALL SHTG. w/ DBL. TOP PL. & INSTALL ON TRUSS VERT. - FASTEN w/ NAILS @ 6" O.C.	LAP WALL SHTG. w/ DBL. TOP PL. & INSTALL ON TRUSS VERT. - FASTEN w/ NAILS @ 6" O.C.*
R.T. w/ HEEL HT. 24" TO 48"	LAP WALL SHTG. w/ DBL. TOP PL. & INSTALL ON TRUSS VERT. - FASTEN w/ NAILS @ 6" O.C. PROVIDE 2x BLK @ EA. BAY AT TOP OF HEEL.	LAP WALL SHTG. w/ DBL. TOP PL. & INSTALL ON TRUSS VERT. - FASTEN w/ NAILS @ 6" O.C. PROVIDE 2x BLK @ EA. BAY AT TOP OF HEEL*
WALL TO FOUNDATION	WALL SHTG. LAP w/ SILL PL. & FASTENED PER SHEAR WALL FASTENING SPEC.	

* 2 5/8"x0.113 IS AN ACCEPTABLE ALTERNATIVE TO A 3"x0.120", SAME SPACING OR NUMBER OF NAILS. (ONLY ACCEPTABLE WHERE * ARE SHOWN)

ADDITIONAL NOTES FOR TRUSS & I-JOIST MANUFACTURER

ROOF TRUSS AND ENGINEERED JOISTS SHALL BE DESIGNED TO MEET THE DEFLECTION CRITERIA BELOW, UNLESS NOTED OTHERWISE ON PLAN. MULHERN & KULP CANNOT BE HELD RESPONSIBLE FOR ANY STRUCTURAL ISSUES RELATED TO ANY BUILDING COMPONENT IF COMPONENT SHOP DRAWINGS ARE NOT SUBMITTED TO MK FOR REVIEW PRIOR TO FABRICATION, DELIVERY, OR INSTALLATION.

TRUSSES/JOISTS SHALL BE DESIGNED SO THAT DIFFERENTIAL DEFLECTION BETWEEN ADJACENT PARALLEL TRUSSES/JOISTS OR GIRDER TRUSSES/FLUSH BEAMS DO NOT EXCEED THE FOLLOWING:

- A. ROOF TRUSSES:
 - 1/4" DEAD LOAD
 - B. ATTIC TRUSSES, & I-JOISTS:
 - 1/8" DEAD LOAD
- ABSOLUTE DEAD LOAD DEFLECTION OF ATTIC TRUSSES WHEN ADJACENT TO FLOOR FRAMING BY OTHERS SHALL BE LIMITED TO 3/16". (NOT DIFFERENTIAL DEFLECTION)

VENEER LINTEL SCHEDULE

SPAN (MAX)	HEIGHT OF VENEER ABOVE LINTEL	STEEL ANGLE SIZE
3'-0"	20 FT. MAX	L3"x3"x1/4"
	3 FT. MAX	L3"x3"x1/4"
6'-0"	12 FT. MAX	L4"x3"x1/4"
	20 FT. MAX	L5"x3"x3/8"
8'-0"	3 FT. MAX	L4"x4"x1/4" *
	12 FT. MAX	L5"x3"x3/8"
	16 FT. MAX	L6"x3"x3/8"
9'-6"	12 FT. MAX	L6"x3"x3/8"

ALL LINTELS:
 - SHALL SUPPORT 2 3/4" - 3 1/2" VENEER w/ 40 psf MAXIMUM WEIGHT.
 - 1/2" SHALL HAVE 4" MIN. BEARING
 - 1/4" SHALL HAVE 8" MIN. BEARING
 - 1/8" SHALL NOT BE FASTENED BACK TO HEADER
 - 1/2" SHALL BE FASTENED BACK TO WOOD HEADER IN WALL @ 48" O.C. w/ 1/2" DIA. x 3 1/2" LONG LAG SCREWS @ 2' LONG VERTICALLY SLOTTED HOLES
 - MAX. VENEER HT. APPLIES TO ANY PORTION OF BRICK OVER THE OPENING.
 - ALL LINTELS SHALL BE LONG LEG VERTICAL.
 - WHEN SUPPORTING VENEER & 9" WIDE THE EXTERIOR TOE OF THE HORIZONTAL LEG MAY BE CUT IN THE FIELD TO BE 3/4" WIDE OVER THE BEARING LENGTH ONLY. THIS IS TO ALLOW FOR HORIZONTAL JOINT FINISHING.
 - SEE STRUCTURAL PLANS FOR ANY LINTEL CONDITION NOT ENCOMPASSED BY THE ABOVE PARAMETERS.
 * FOR QUEEN VENEER USE L4"x3/4".

MK STD. - MAY 2016

GENERAL STRUCTURAL NOTES

FOUNDATION

- DESIGN IS BASED ON 2018 NCSBC-RESIDENTIAL CODE & 2018 IRC WITH SOUTH CAROLINA AMENDMENTS
- FOOTING DESIGN - 2,000 PSF NET ALLOWABLE SOIL BEARING PRESSURE IS ASSUMED. BUILDER/CONTRACTOR MUST VERIFY.
- FASTEN 2x4/6 SILL PLATES TO CONC FND WITH A MINIMUM OF 2 ANCHORS PER PLATE, 12" MAX. FROM PLATE ENDS - UTILIZING:
 - 1/2" DIA. ANCHOR BOLTS @ 6'-0" O.C., 7" MIN. EMBEDMENT
 - F44 ANCHOR STRAPS @ 6'-0" O.C.
- FASTEN 2x10 SILL PLATES TO PRECAST BSMT WALLS WITH A MINIMUM OF 2 ANCHORS PER PLATE, 12" MAX. FROM PLATE ENDS - UTILIZING:
 - 1/2" DIA. BOLTS @ 2'-0" O.C.
- ALL LUMBER EXPOSED TO WEATHER OR IN CONTACT w/ PERIMETER FOUNDATION SHALL BE PRESERVATIVE TREATED SOUTHERN PINE #2.
- BUILDER TO VERIFY CORROSION-RESISTANCE COMPATIBILITY OF HARDWARE & FASTENERS IN CONTACT w/ PRESERVATIVE-TREATED WOOD. CONTACT LUMBER & HARDWARE SUPPLIERS TO COORD.
- FOUNDATION WALLS & FOOTINGS SHALL BE PLAIN CONCRETE, U.N.O.
- CONCRETE DESIGN BASED ON ACI 318. CONCRETE SHALL ATTAIN THE FOLLOWING MIN. COMPRESSIVE STRENGTHS IN 28 DAYS, U.N.O.:
 - f'c = 4000 psi: FOUNDATION WALLS
 - 3000 psi: FOOTINGS & INTERIOR SLABS ON GRADE
 - 3500 psi: GARAGE & EXTERIOR SLABS ON GRADE
 - f'ty = 60,000 psi
- BASEMENT FOUNDATION WALL DESIGN BASED ON:
 - 8' OR 9' HEIGHT (AS NOTED ON PLANS)
 - TALLER WALLS MUST BE ENGINEERED.
- BASEMENT WALL DESIGN IS BASED ON 30 OR 45 PCF BACKFILL SOIL TYPE CLASSIFICATIONS:
 - 30 PCF TYPE (GM, GP, SM, SP)
 - 45 PCF TYPE (GM, GC, SM, SM-SC, ML)
 - IMPORTANT - IF 60 PCF SOIL TYPE (SC, ML-CL, OR CL) IS UTILIZED FOR BACKFILL, CONTACT MULHERN & KULP FOR FURTHER EVALUATION OF FOUNDATION DESIGN.
- BASEMENT WALLS SHALL BE BRACED, PRIOR TO BACKFILLING, BY ADEQUATE TEMPORARY BRACING OR INSTALL 1st FLOOR DECK.
- ALL CONCRETE EXPOSED TO THE WEATHER SHALL NOT HAVE LESS THAN 5% OR MORE THAN 1% AIR ENTRAINMENT.
- ALL FOOTINGS SHALL BEAR BELOW FROST LINE (TYP.) OR 12" MIN IN REGIONS WHERE CODE FROST DEPTH IS NOT APPLICABLE. CONSULT SOILS REPORT OR BUILDING DEPT. FOR MINIMUM DEPTH BELOW GRADE.
- FOOTINGS AND SLABS ON GRADE SHALL BEAR ON VIRGIN SOIL OR 95% COMPACTED FILL.
- PROVIDE CONTROL JOINTS AT ALL INSIDE CORNERS OF SLAB EDGES, AND OTHER LOCATIONS WHERE SLAB CRACKS ARE LIKELY TO DEVELOP.
 - JOINTS SHALL BE LOCATED @ 10'-0" O.C. (RECOMMENDED) OR 15'-0" O.C. (MAXIMUM)
 - JOINT GRID PATTERN SHALL BE AS CLOSE TO SQUARES AS POSSIBLE (1:1 RATIO), WITH A MAXIMUM OF 1:1.5 RATIO
 - CONTROL JOINTS SHALL NOT BE INSTALLED IN STRUCTURAL SLABS
- TYPICAL REINFORCEMENT DETAILS: PROVIDE 3" MIN. CLEAR COVER WHERE CAST AGAINST EARTH, 1 1/2" MIN. CLEAR COVER AGAINST FORMS. LAP ALL REBAR 48 BAR DIAMETERS MIN. (24" FOR #4 BARS) & BEND BARS AND LAP AT CORNERS. PROVIDE 6" HOOK INTO SUPPORTING FOOTINGS WHEN FOOTINGS INTERSECT.
- DIMENSIONS BY OTHERS, BUILDER TO VERIFY.

MK STD. - MAY 2012

LEGEND

- INDICATES ROOF TRUSSES @ 24" O.C. PER ROOF. MANUF. (TYP. U.N.O.)
- INDICATES TRUSS OVERFRAMING @ 24" O.C. (TYP. U.N.O.)
- INDICATES 14" DEEP FLOOR I-JOISTS @ 24" O.C. MAX. JOIST SERIES AND SPACING SHALL BE THE RESPONSIBILITY OF THE MANUFACTURER. NOTE: 14" FLOOR TRUSSES @ 24" O.C. MAX. IS AN ACCEPTABLE ALTERNATE FLOOR SYSTEM
- INDICATES LOCATIONS OF POTENTIAL TILE FLOOR. JOIST MANUFACTURER SHALL DESIGN FLOOR SYSTEM FOR ADDL. 10 PSF DEAD LOAD AT THESE LOCATIONS.
- INTERIOR BEARING WALL
- BEARING WALL ABOVE (B.W.A.)
- BEAM HEADER
- METAL HANGER
- INDICATES POST ABOVE (P.A.) PROVIDE SOLID BLOCKING UNDER POST OR JAMB ABOVE.

LATERAL/WALL BRACING & WALL SHEATHING SPECIFICATIONS

THIS MODEL HAS BEEN DESIGNED TO RESIST LATERAL FORCES RESULTING FROM:
120MPH WIND IN 2018 NCSBC:RC & 120MPH WIND IN 2018 IRC
 (120 MPH WIND SPEED IN ASCE 7 WIND MAP, PER IRC R301.2.1.1) EXP. B, RISK CAT. 2 & SEISMIC CAT. A/B.

THE DESIGN WAS COMPLETED PER 2015 & 2018 IBC (SECTION 1604) & ASCE 7, AS PERMITTED BY R301.3 OF THE 2018 NCSBC:RC & 2018 IRC. ACCORDINGLY, THIS MODEL, AS DOCUMENTED AND DETAILED HEREWITHIN, IS ADEQUATE TO RESIST THE CODE REQUIRED LATERAL FORCES.

DESIGN WIND UPLIFT LOADS HAVE BEEN CALCULATED UTILIZING ASCE 7 (ACCEPTED ENGINEERING PRACTICE) AS ALLOWED PER 2018 NCSBC:RC & 2018 IRC SECTION R802.11.1.1. THIS MODEL HAS BEEN DETAILED WHERE REQUIRED & ENGINEERED TO RESIST THE WIND UPLIFT LOAD PATH PER SECTIONS R602.3.54 R802.11.

EXT. WALL SHEATHING SPECIFICATION

- 7/16" OSB OR 15/32" PLYWOOD:
 - FASTEN SHEATHING w/ 2 3/8"x0.113 NAILS @ 6" O.C. AT EDGES & @ 12" O.C. IN THE PANEL FIELD. (TYP. U.N.O.)
- ALL SHEATHING PANELS SHALL BE ORIENTED VERTICALLY (LONG DIRECTION PARALLEL TO STUDS) AND INSTALLED FULL HEIGHT OF SHEAR WALL - OR - 2x HORIZONTAL BLOCKING SHALL BE PROVIDED TO SUPPORT ALL UNSUPPORTED PANEL EDGES & EDGE FASTENING.
- ALL EXT. WALLS SHALL BE CONTINUOUSLY SHEATHED AND ARE CONSIDERED SHEAR WALLS.
- ALT. STAPLE CONNECTION SPEC: 1 3/4" 16 GA STAPLES (1/6" CROWN) @ 3" O.C. AT EDGES & @ 6" O.C. IN FIELD.

3" O.C. EDGE NAILING

- AT DESIGNATED AREAS - FASTEN PANEL EDGES OF WOOD STRUCTURAL WALL SHEATHING TO FRAMING w/ 2 3/8" x 0.113" NAILS @ 3" O.C. AND 12" O.C. IN THE PANEL FIELD. NO STAPLE ALTERNATIVE AVAILABLE AT THIS SPEC. ALL SHEATHING PANELS SHALL BE ORIENTED VERTICALLY (LONG DIRECTION PARALLEL TO STUD) AND INSTALLED FULL HEIGHT OF SHEAR WALL - OR - 2x HORIZONTAL BLOCKING SHALL BE PROVIDED TO SUPPORT UNSUPPORTED PANEL EDGES AND 3" O.C. EDGE FASTENING.

NOTES

- SEE CONNECTION SPECIFICATIONS CHART FOR STANDARD SHEAR TRANSFER DETAILING. IF ADDITIONAL CAPACITY IS REQUIRED BY DESIGN, IT WILL BE SPECIFICALLY NOTED ON PLAN.
- DESIGN ASSUMES 16" O.C. MAX. STUD SPACING, U.N.O.
- ALL STRUCTURAL PANELS ARE TO BE DIRECTLY APPLIED TO STUD FRAMING.
- PRE-MANUFACTURED PANELIZED WALLS: FASTEN TOGETHER END STUDS OF WALL PANELS SHEATHED w/ OSB OR PLYWOOD w/ 3" x 0.120" NAILS @ 4" O.C. (THRU ONE SIDE ONLY)

- INDICATES EXTENT OF INT. OSB SHEAR WALL, AND/OR 3" O.C. EDGE NAILING
- INDICATES HOLDDOWN

MK STD. - MAR 2016

NON-BEARING HEADER SCHEDULE

SPAN	2x4 NON-BEARING PARTITION WALL	2x6 NON-BEARING PARTITION WALL
UP TO 3'-0"	(1)2x4 FLAT	(1)2x6 FLAT
UP TO 6'-0"	(2)2x4	(3)2x4
UP TO 8'-0"	(2)2x6	(3)2x6

- NOTES:
- ALL NON-BEARING INTERIOR STUD WALLS SHALL BE CONSTRUCTED WITH 2x 'STUD' GRADE MEMBERS SPACED @ 24" O.C. (MAX.)

FLOOR FRAMING

- I-JOISTS SHALL BE DESIGNED BY MANUF. TO MEET OR EXCEED L/480 LIVE LOAD DEFLECTION CRITERIA. (EXCLUDES STONE/MARBLE OR NET BED CONSTRUCTED FLOORS - CONTACT MK FOR EXCLUDED FLOOR DESIGNS)
- PER THE GUIDELINES OF THE TILE COUNCIL OF NORTH AMERICA (TCNA HANDBOOK), IT SHALL BE THE FLOOR FINISH INSTALLER'S RESPONSIBILITY TO VERIFY THAT THE FINISHES TO BE INSTALLED MATCH THE DESIGN CRITERIA NOTED ABOVE (UNDER "DESIGN LOADS").
- FLOOR SYSTEMS & SHEATHING HAVE BEEN DESIGNED TO SUPPORT ADDITIONAL DEAD LOAD FROM CERAMIC TILE (EXCLUDING MARBLE OR STONE). HOWEVER, IT SHALL BE THE FLOOR FINISH INSTALLER'S RESPONSIBILITY TO PROVIDE PROPER UNDERLAYMENT, UNCOUPLING MEMBRANE AND MORTAR/GROUT PER THE ASSEMBLY DESIGNATIONS IN THE TCNA HANDBOOK (TILE COUNCIL OF NORTH AMERICA).
- AT I-JOIST FLOORS, PROVIDE 1" MIN. OSB RIM BOARD.
- METAL HANGERS SHALL BE SPECIFIED BY MANUFACTURER, U.N.O.
- I-JOIST SHOP DWGS. SHALL BE SUBMITTED TO ARCH. & ENG. FOR REVIEW AND APPROVAL PRIOR TO FABRICATION OR DELIVERY.
- FLOOR SHEATHING SHALL BE 23/32" A.P.A. RATED 'STURD-I-FLOOR' 24" O.C. EXPOSURE 1 (OR APPROVED EQUAL) WITH TONGUE AND GROOVE EDGES. FASTEN TO FRAMING MEMBERS w/ GLUE AND:
 - 2 1/2" x 0.131" NAILS @ 6" O.C. @ PANEL EDGES & @ 12" O.C. FIELD.
 - 2 3/8" x 0.120" NAILS @ 4" O.C. @ PANEL EDGES & @ 8" O.C. FIELD.
 - 2 3/8" x 0.113" NAILS @ 3" O.C. @ PANEL EDGES & @ 6" O.C. IN FIELD.

ROOF FRAMING

- ROOF SHEATHING SHALL BE 7/16" A.P.A. RATED SHEATHING 24/16 EXPOSURE 1 (OR APPROVED EQUAL). FASTEN TO FRAMING MEMBERS:
 - w/ 2 1/2" x 0.131" NAILS @ 6" O.C. @ PANEL EDGES & @ 12" O.C. FIELD.
 - w/ 2 3/8" x 0.120" NAILS @ 4" O.C. @ PANEL EDGES & @ 8" O.C. FIELD.
 - w/ 2 3/8" x 0.113" NAILS @ 3" O.C. @ PANEL EDGES & @ 6" O.C. FIELD.
- WITHIN 48" OF ALL ROOF EDGES, RIDGES, & HIPS FASTEN ROOF SHEATHING FIELDS PER EDGE NAILING SPEC.
- FASTEN EACH ROOF TRUSS TO TOP PLATE w/ USP RTIA CLIP (OR APPROVED EQUAL) @ ALL BEARING POINTS. PROVIDE (2) RTIA CLIPS AT 2-PLY GIRDER TRUSSES, (3) RTIA CLIPS AT 3-PLY GIRDER TRUSSES & ROOF BEAMS - AT ALL BEARING POINTS.
- METAL HANGERS SHALL BE SPECIFIED BY THE MANUFACTURER, U.N.O.
- ROOF TRUSS SHOP DWGS. SHALL BE SUBMITTED TO ARCH. & ENG. FOR REVIEW AND APPROVAL PRIOR TO FABRICATION OR DELIVERY.
- ERECT AND INSTALL ROOF TRUSSES PER WTC & TPI'S BC51 "GUIDE TO GOOD PRACTICE FOR HANDLING, INSTALLING & BRACING OF METAL PLATE CONNECTED WOOD TRUSSES."
- SUPPORT SHORT SPAN ROOF TRUSSES w/ 2x4 LEDGER FASTENED TO FRAMING w/ (2) 3" x 0.120" NAILS @ 16" O.C. (UP TO 7' SPAN).

MK STD. - MAR 2016

MEANS & METHODS NOTES

THE STRUCTURE IS DESIGNED TO BE SELF SUPPORTING AND STABLE AFTER THE BUILDING IS FINISHED AND ALL PLAN, DETAIL, AND NOTE SPECIFICATIONS HAVE BEEN COMPLETED. IT IS THE CONTRACTOR'S SOLE RESPONSIBILITY TO DETERMINE THE ERECTION PROCEDURES AND SEQUENCE TO INSURE THE SAFETY OF THE BUILDING AND ITS COMPONENTS DURING CONSTRUCTION. THIS INCLUDES, BUT IS NOT LIMITED TO, THE ADDITION OF NECESSARY SHORING, SHEETING, TEMPORARY BRACING, GUY'S, AND TIE-DOWNS. CONTRACTOR SHALL BE RESPONSIBLE FOR ALL SHORING AND BRACING REQUIRED TO STABILIZE AND PROTECT EXISTING AND ADJACENT STRUCTURES AND SYSTEMS DURING COURSE OF DEMOLITION AND CONSTRUCTION OF THE PROJECT.

STRUCTURAL DESIGN AND SPECIFICATIONS ASSUME THAT ALL SUPPORTING AND NON-SUPPORTING ELEMENTS IN CONTACT WITH FLOOR FRAMING ARE LEVEL, INCLUDING, BUT NOT LIMITED TO; FOUNDATIONS, SLABS ON GRADE, BEAMS, WALLS, AND NON-BEARING ELEMENTS. IT IS THE CONTRACTOR'S RESPONSIBILITY TO VERIFY LEVELNESS AND MAKE ADJUSTMENTS AS NECESSARY, INCLUDING CONSIDERATION OF THOSE AREAS THAT MAY BE WITHIN CONTRACTUAL, INDUSTRY, OR WARRANTY TOLERANCES.

GENERAL STRUCTURAL NOTES

- DESIGN IS BASED ON 2018 NCSBC-RESIDENTIAL CODE & 2018 IRC WITH SOUTH CAROLINA AMENDMENTS
- WOOD FRAME ENGINEERING IS BASED ON NDS, "NATIONAL DESIGN SPECIFICATION FOR WOOD CONSTRUCTION" - LATEST EDITION.
- DESIGN LOADS:
 - ROOF: LIVE = 20 PSF
DEAD = 7 PSF T.C., 10 PSF B.C.
LOAD DURATION FACTOR = 1.25
 - FLOOR: LIVE = 40 PSF (30 PSF @ SLEEPING AREAS)
DEAD = 10 PSF (1-JOISTS)
 - ADD'L 10 PSF @ CERAMIC TILE IN BATHS & LAUND.
 - SOIL: 2,000 PSF ASSUMED ALLOWABLE BEARING PRESSURE (TO BE VERIFIED BY BUILDER)

GENERAL FRAMING

- ALL TYP. NAIL FASTENER REQUIREMENTS ARE NOTED IN STANDARD CONNECTIONS TABLE (IRC TABLE R602.3(1)) OR ON PLANS. ALL NAILS SPECIFIED ARE MIN DIAMETER AND LENGTH REQUIRED FOR CONNECTION. ALL HANGER NAILS SHALL BE INSTALLED PER MANUFACTURER'S REQUIREMENTS FOR MAX CHARTED CAPACITY. NOTE: HANGERS USE COMMON NAIL DIAMETERS NOT TYPICAL FRAMING GUN NAILS.
- EXT. & INT. BEARING WALLS SHALL BE 2x4 OR 2x6 (AS SHOWN ON PLANS) @ 16" O.C. SPF/SP 'STUD' GRADE LUMBER, OR BETTER, U.N.O.
 - WALLS OVER 12' TALL SHALL BE PER PLAN.
- ALL INTERIOR BEARING WALLS ARE ASSUMED TO BE SHEATHED w/ GYP WALL BOARD (ONE SIDE MIN.) OR PROVIDE MID HT. BLOCKING.
- ALL HEADERS, BEAMS & OTHER STRUCTURAL MEMBERS SHALL BE SPRUCE-PINE-FIR #2 (SPF) OR SOUTHERN PINE #2 (SP) LUMBER, OR BETTER. SUPPORT ALL HEADERS/ BEAMS w/ (1)2x JACK STUD @ (1)2x KING STUD, MINIMUM. - THE NUMBER OF STUDS SPECIFIED AT A SUPPORT INDICATES THE NUMBER OF JACK STUDS REQUIRED, U.N.O.
- ALL NON-BEARING INTERIOR STUD WALLS SHALL BE CONSTRUCTED WITH 2x 'STUD' GRADE MEMBERS SPACED @ 24" O.C. (MAX. U.N.O.)
 - HEADERS IN NON-LOAD BEARING WALLS SHALL BE: (1)2x4/6 FLAT @ OPENINGS UP TO 4'; (2)2x4/6 FLAT UP TO 8'.
- ALL FRAMING LUMBER SHALL BE DRIED TO 15% MC (KD-15).
- ENGINEERED LUMBER BEAMS TO MEET OR EXCEED THE FOLLOWING:
 - 'LVL' - Fb=2600 psi; Fv=285 psi; E=2.0x10¹⁰ psi
- ENGINEERED LUMBER POSTS TO MEET OR EXCEED THE FOLLOWING:
 - 'LVL' - Fb=2400 psi; FcII=2500 psi; E=1.8x10¹⁰ psi
- FOR 2 & 3 PLY BEAMS OF EQUAL 1 3/4" MAX. WIDTH, FASTEN PLIES TOGETHER WITH 3 ROWS OF 3"x0.120" NAILS @ 8" O.C. OR 2 ROWS USP #535 SCREWS (OR 3 1/2" TRUSSLOK SCREWS) @ 16" O.C. USE A MINIMUM OF 4 ROWS FOR BEAM DEPTHS OF 14" OR GREATER. APPLY FASTENING AT BOTH FACES FOR 3-PLY CONDITION. LOCATE TOP & BOTTOM NAILS/SCREWS 2" FROM EDGE. SOLID 3 1/2" OR 5 1/4" BEAMS ARE ACCEPTABLE. USE 2 ROWS OF NAILS FOR 2x6 & 2x8 MEMBERS.
- FOR 4 PLY BEAMS OF EQUAL 1 3/4" MAX. WIDTH, FASTEN PLIES TOGETHER WITH 3 ROWS OF USP #56 SCREWS (OR 6 3/4" TRUSSLOK SCREWS) @ 16" O.C. USE A MINIMUM OF 4 ROWS FOR BEAM DEPTHS OF 14" OR GREATER. APPLY FASTENING AT BOTH FACES (ONE SIDE ONLY FOR TRUSSLOK SCREWS). LOCATE TOP AND BOTTOM SCREWS 2" FROM EDGE. A SOLID 7" BEAM IS ACCEPTABLE.
- PROVIDE SOLID BLOCKING IN FLOOR SYSTEM UNDER ALL POSTS CONTINUOUS TO FND/BEARING. BLOCKING TO MATCH POST ABOVE.
- ALL EXTERIOR 4x4 WOOD POSTS SHALL HAVE USP BC522-4 CAP & PA44E BASE, U.N.O.
- CORROSION NOTES:
 - BUILDER RESPONSIBLE TO DETERMINE CORROSION-RESISTANCE REQUIREMENTS AND COMPATIBILITY OF HARDWARE, FASTENERS AND CONNECTORS FOR ENVIRONMENTAL EXPOSURE AND IN CONTACT w/ PRESERVATIVE-TREATED WOOD OF ACTUAL FINAL CONDITIONS AND SOURCED MATERIALS. CONTACT LUMBER & HARDWARE SUPPLIERS TO COORD.
 - ALL FASTENERS AND CONNECTORS EXPOSED TO SALT WATER (WITHIN 300' OF SALT WATER SHORELINE, INCLUDING VENTED SPACES) SHALL BE STAINLESS STEEL.

MK STD. - MAR 2016

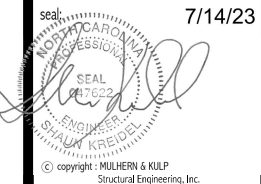

MULHERN+KULP
 RESIDENTIAL STRUCTURAL ENGINEERING
 3625 Remondino Parkway, Suite 105 - Alpharetta, GA 30022
 770-777-4874 - mulhern@mulhernkulp.com
 NC License # C-3825

Mulhern+Kulp project number:
256-22019
 project mgr: **SMK**
 drawn by: **RAP**
 issue date: **01.13.2023**

REVISIONS:
 date: _____ initial: _____

SMITH DOUGLAS
 HOMES

GENERAL STRUCTURAL NOTES
BENSON II MODEL
 120 MPH WIND ZONE
 NORTH CAROLINA

sheet:
SO.0

HARRINGTON
Lot 44

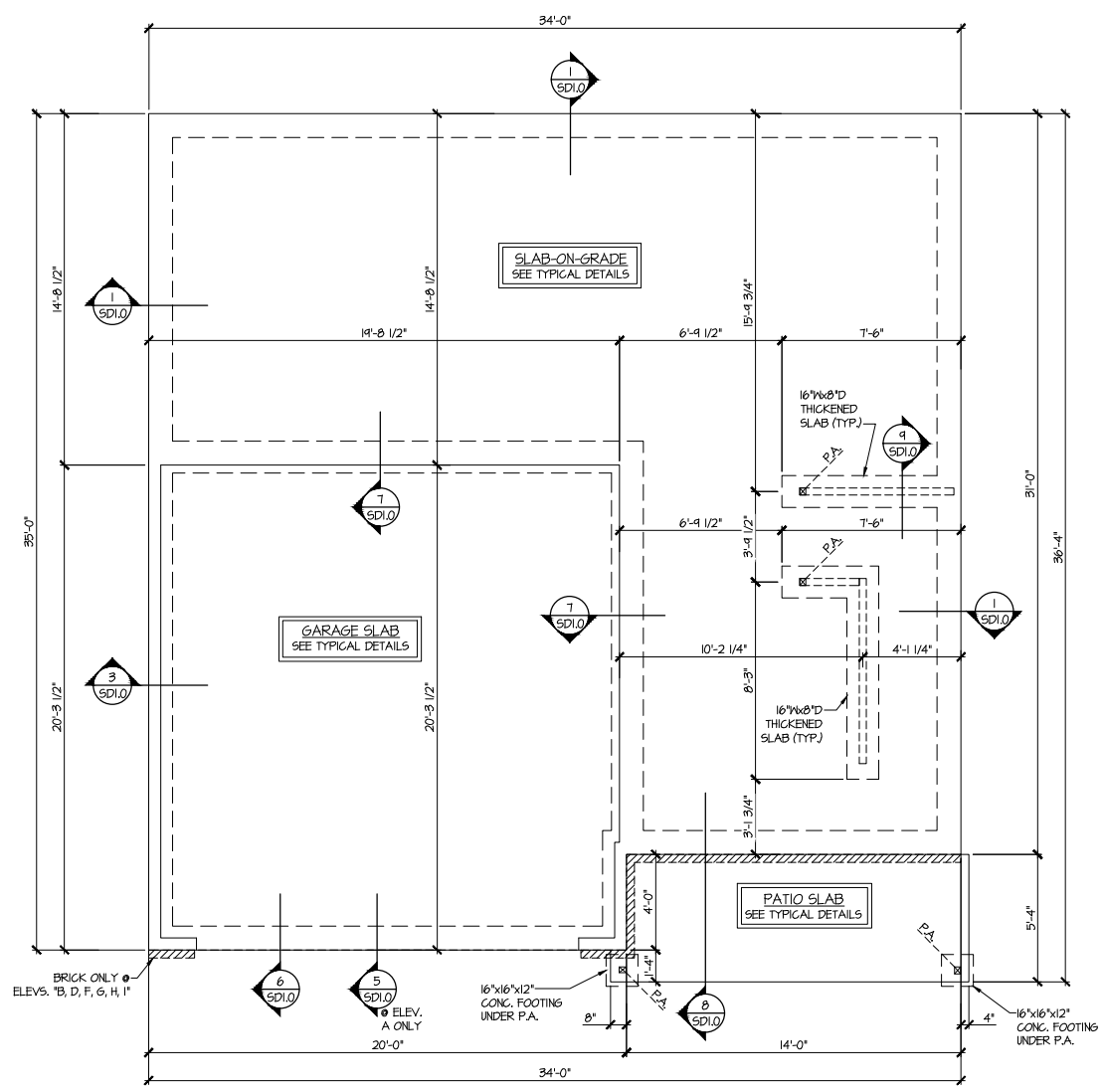

1 MONO-SLAB FOUNDATION PLAN
 SCALE: 1/4"=1'-0" ON 22x34
 1/8"=1'-0" ON 11x17
 ALL ELEV. SIM.

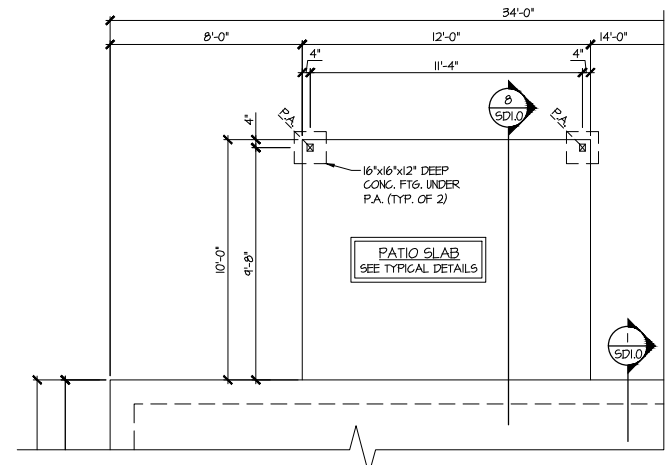

2 PARTIAL MONO-SLAB FOUNDATION PLAN
 SCALE: 1/4"=1'-0" ON 22x34
 1/8"=1'-0" ON 11x17
 OPT. COVERED PATIO
 ALL ELEV. SIM.
 SEE BASE ELEV. FOR ADD'L INFO.

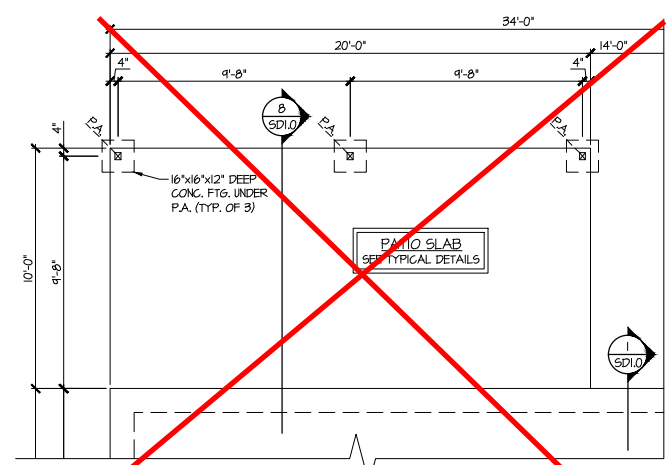

3 PARTIAL MONO-SLAB FOUNDATION PLAN
 SCALE: 1/4"=1'-0" ON 22x34
 1/8"=1'-0" ON 11x17
 OPT. LARGE COVERED PATIO
 ALL ELEV. SIM.
 SEE BASE ELEV. FOR ADD'L INFO.

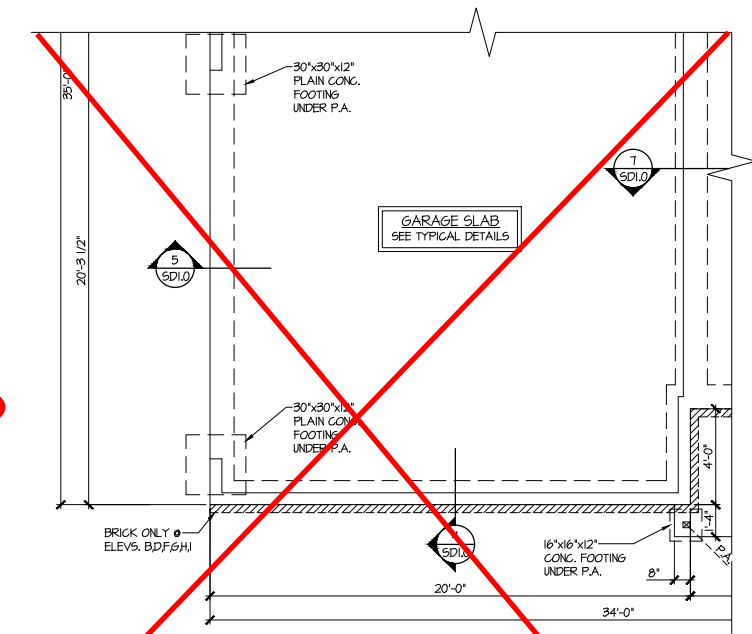

4 PARTIAL MONO-SLAB FOUNDATION PLAN
 SCALE: 1/4"=1'-0" ON 22x34
 1/8"=1'-0" ON 11x17
 OPT. SIDE ENTRY GARAGE
 ALL ELEV. SIM.
 SEE BASE ELEV. FOR ADD'L INFO.

**HARRINGTON
 Lot 44**

REFER TO S.O. FOR TYPICAL
 STRUCTURAL NOTES & SCHEDULES

LEGEND	
	INDICATES ROOF TRUSSES @ 24" O.C. PER ROOF. MANUF. (TYP. U.N.O.)
	INDICATES TRUSS OVERFRAMING @ 24" O.C. (TYP. U.N.O.)
	INDICATES 14" DEEP FLOOR I-JOISTS @ 24" O.C. MAX. JOIST SERIES AND SPACING SHALL BE THE RESPONSIBILITY OF THE MANUFACTURER. NOTE: 14" FLOOR TRUSSES @ 24" O.C. MAX. IS AN ACCEPTABLE ALTERNATE FLOOR SYSTEM.
	INDICATES LOCATIONS OF POTENTIAL TILE FLOOR. JOIST MANUFACTURER SHALL DESIGN FLOOR SYSTEM FOR ADD'L 10 PSF DEAD LOAD AT THESE LOCATIONS.
	INTERIOR BEARING WALL
	BEARING WALL ABOVE (B.M.A.)
	BEAM/HEADER
	METAL HANGER
	INDICATES POST ABOVE (P.A.) PROVIDE SOLID BLOCKING UNDER POST OR JAMB ABOVE.

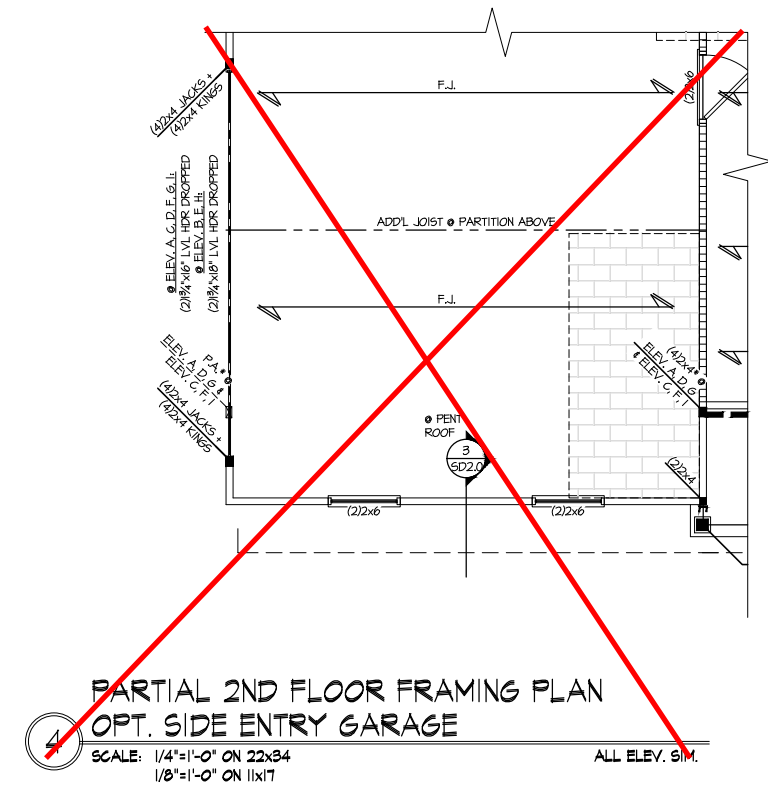
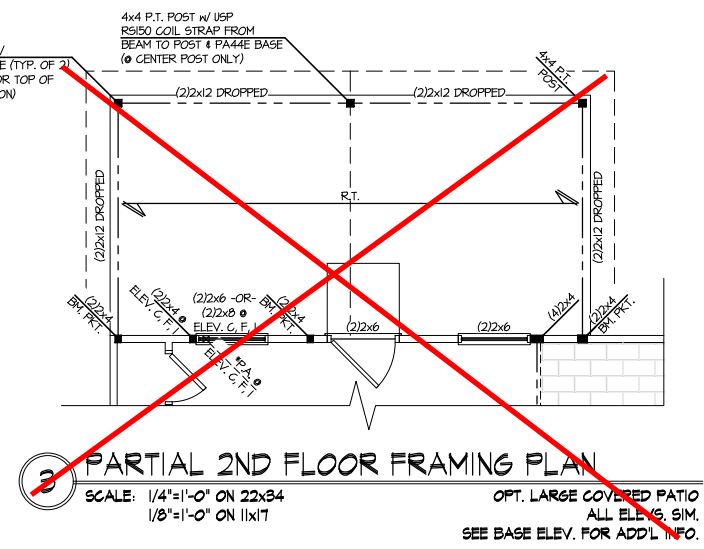
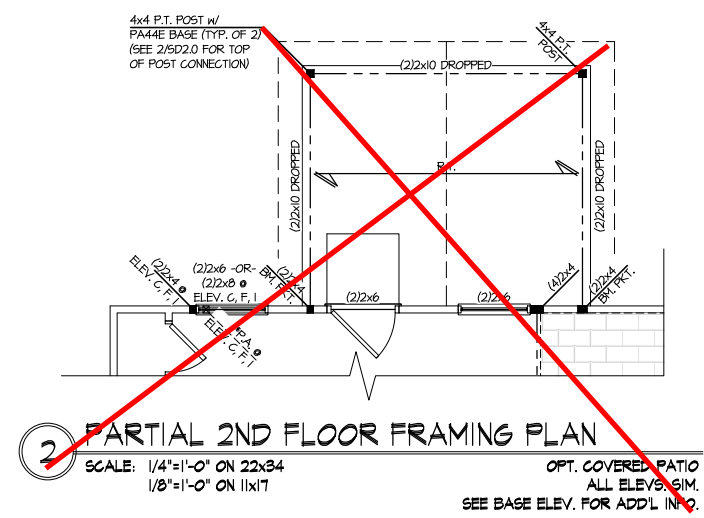
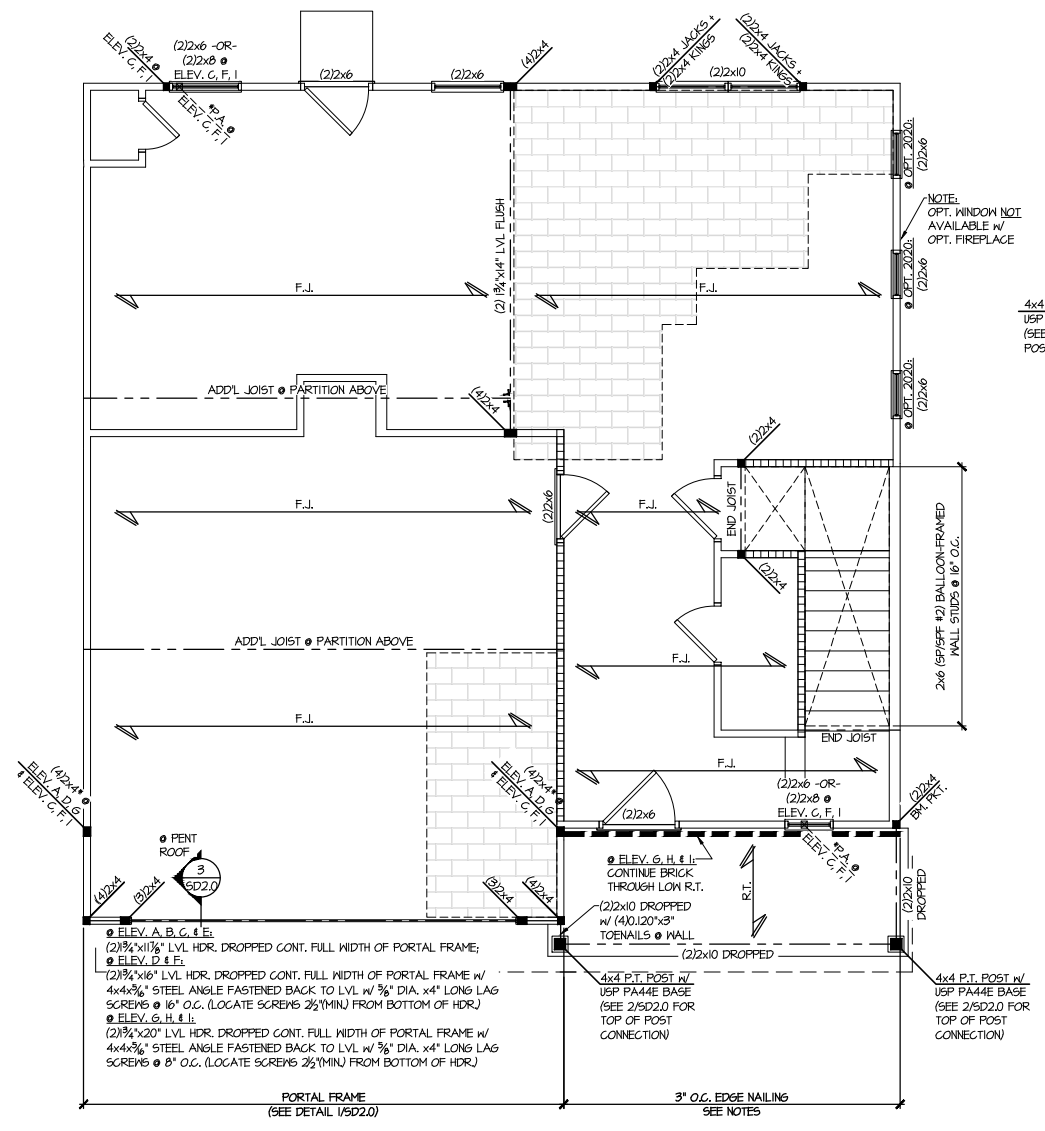

HARRINGTON
 Lot 44

LATERAL/WALL BRACING & WALL SHEATHING SPECIFICATIONS

THIS MODEL HAS BEEN DESIGNED TO RESIST LATERAL FORCES RESULTING FROM:
120MPH WIND IN 2018 NC5BC:RC & 120MPH WIND IN 2018 IRC
 (120 MPH WIND SPEED IN ASCE 7 WIND MAP, PER IRC R301.2.1.1) EXP. B, RISK CAT. 2 & SEISMIC CAT. A/B.

THE DESIGN WAS COMPLETED PER 2015 & 2018 IBC (SECTION 1609) & ASCE 7, AS PERMITTED BY R301.1.3 OF THE 2018 NC5BC:RC & 2018 IRC. ACCORDINGLY, THIS MODEL, AS DOCUMENTED AND DETAILED HEREWITHIN, IS ADEQUATE TO RESIST THE CODE REQUIRED LATERAL FORCES.

DESIGN WIND UPLIFT LOADS HAVE BEEN CALCULATED UTILIZING ASCE 7 (ACCEPTED ENGINEERING PRACTICE) AS ALLOWED PER 2018 NC5BC:RC & 2018 IRC SECTION R802.1.1.1.1. THIS MODEL HAS BEEN DETAILED WHERE REQUIRED & ENGINEERED TO RESIST THE WIND UPLIFT LOAD PATH PER SECTIONS R602.3.54 R802.11.

MHC STD. - MAR 2018

EXT. WALL SHEATHING SPECIFICATION

- 7/16" OSB OR 15/32" PLYWOOD:
 FASTEN SHEATHING w/ 2 3/8"x0.113 NAILS @ 6" O.C. AT EDGES & @ 12" O.C. IN THE PANEL FIELD. (TYP. UNO.)
- ALL SHEATHING PANELS SHALL BE ORIENTED VERTICALLY (LONG DIRECTION PARALLEL TO STUDS) AND INSTALLED FULL HEIGHT OF SHEAR WALL - OR - 2x HORIZONTAL BLOCKING SHALL BE PROVIDED TO SUPPORT ALL UNSUPPORTED PANEL EDGES & EDGE FASTENING.
- ALL EXT. WALLS SHALL BE CONTINUOUSLY SHEATHED AND ARE CONSIDERED SHEAR WALLS.
- ALT. STAPLE CONNECTION SPEC: 1 3/4" 16 GA STAPLES (1/16" CROWN) @ 3" O.C. AT EDGES & @ 6" O.C. IN FIELD.

3" O.C. EDGE NAILING

- AT DESIGNATED AREAS - FASTEN PANEL EDGES OF WOOD STRUCTURAL WALL SHEATHING TO FRAMING w/ 2 3/8" x 0.113" NAILS @ 3" O.C. AND 12" O.C. IN THE PANEL FIELD. NO STAPLE ALTERNATIVE AVAILABLE AT THIS SPEC. ALL SHEATHING PANELS SHALL BE ORIENTED VERTICALLY (LONG DIRECTION PARALLEL TO STUD) AND INSTALLED FULL HEIGHT OF SHEAR WALL - OR - 2x HORIZONTAL BLOCKING SHALL BE PROVIDED TO SUPPORT UNSUPPORTED PANEL EDGES AND 3" O.C. EDGE FASTENING.

NOTES

- SEE CONNECTION SPECIFICATIONS CHART FOR STANDARD SHEAR TRANSFER DETAILING. IF ADDITIONAL CAPACITY IS REQUIRED BY DESIGN, IT WILL BE SPECIFICALLY NOTED ON PLAN.
- DESIGN ASSUMES 16" O.C. MAX. STUD SPACING, UNO.
- ALL STRUCTURAL PANELS ARE TO BE DIRECTLY APPLIED TO STUD FRAMING.
- PRE-MANUFACTURED PANELIZED WALLS: FASTEN TOGETHER END STUDS OF WALL PANELS SHEATHED w/ OSB OR PLYWOOD w/ 3" x 0.120" NAILS @ 4" O.C. (THRU ONE SIDE ONLY)

--- INDICATES EXTENT OF INT. OSB SHEARWALL, AND/OR 3" O.C. EDGE NAILING
 ► INDICATES HOLDDOWN

MHC STD. - MAR 2018

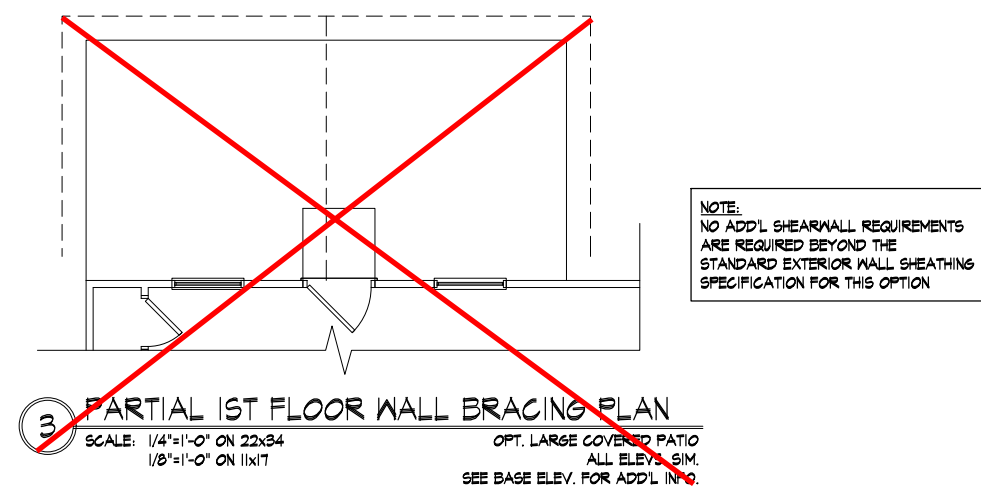
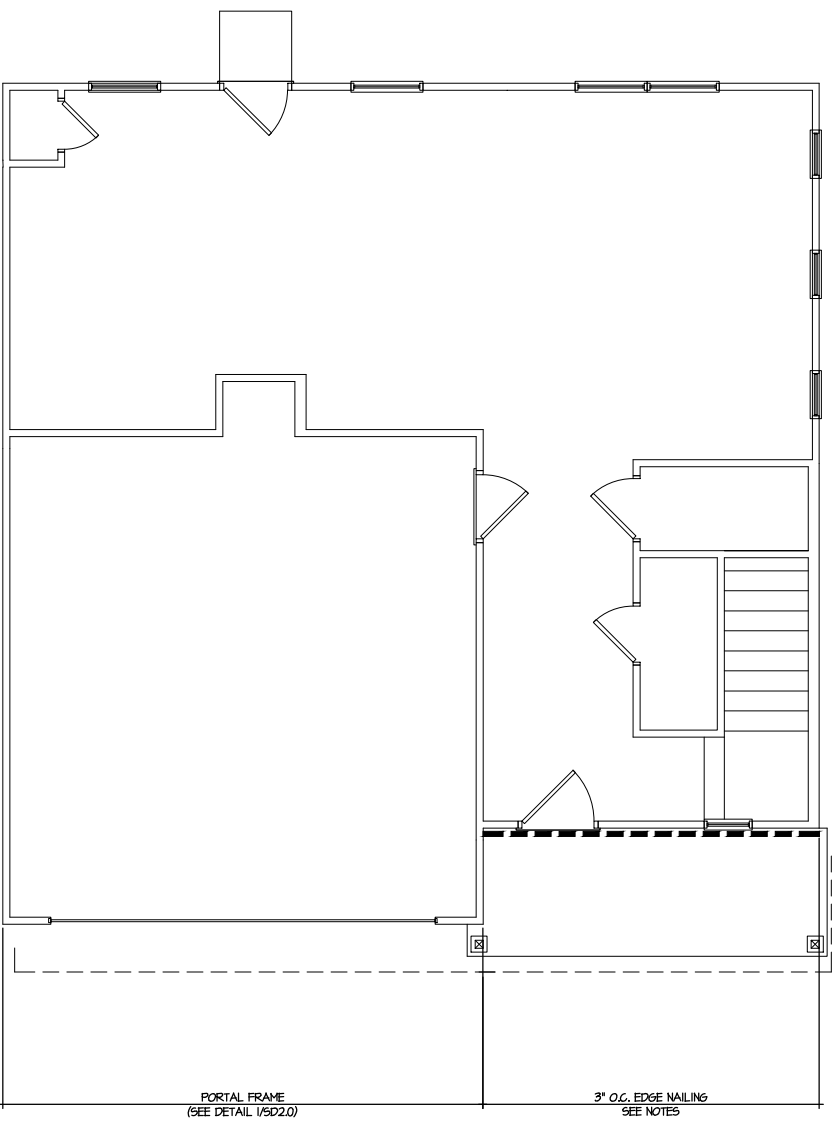
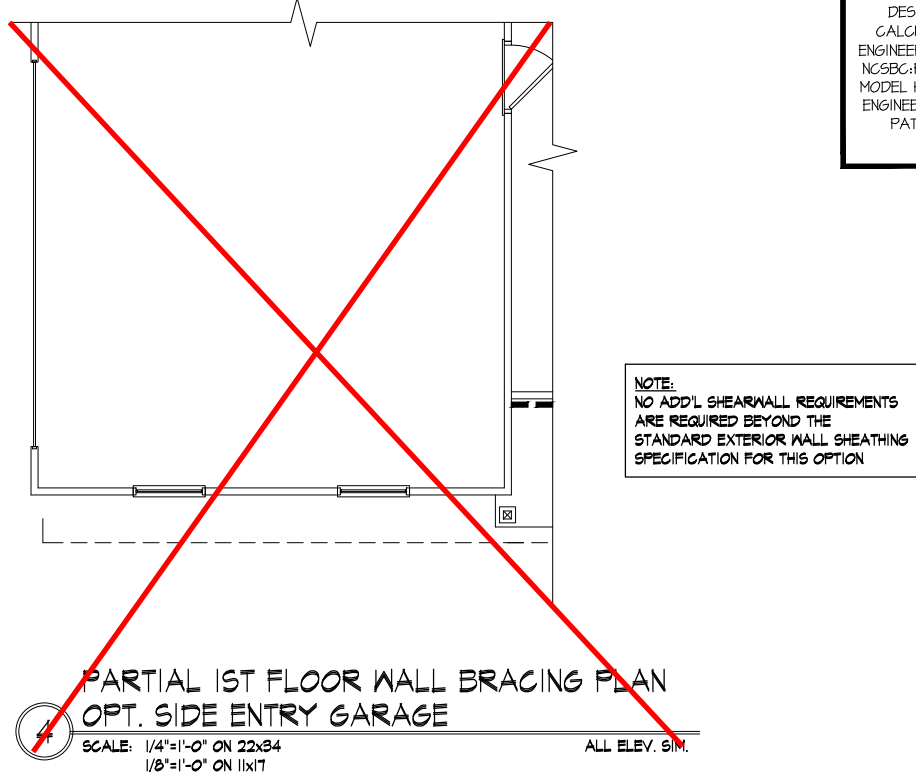
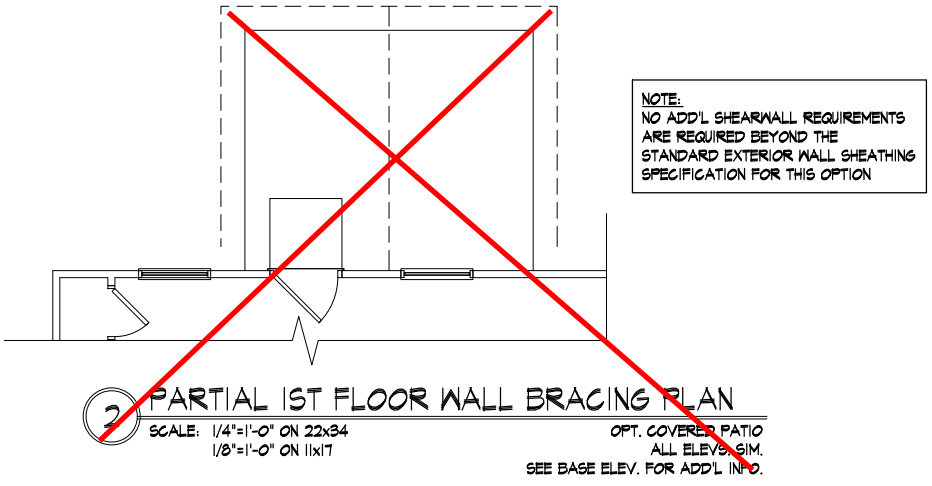

HARRINGTON Lot 44

THIS LEVEL HAS BEEN DESIGNED FOR 9'-1" PLATE HEIGHT

REFER TO S0.0 FOR TYPICAL STRUCTURAL NOTES & SCHEDULES

LEGEND

- R.T. INDICATES ROOF TRUSSES @ 24" O.C. PER ROOF. MANUF. (TYP. UNO.)
- O.F. INDICATES TRUSS OVERFRAMING @ 24" O.C. (TYP. UNO.)
- F.L. INDICATES 14" DEEP FLOOR I-JOISTS @ 24" O.C. MAX. JOIST SERIES AND SPACING SHALL BE THE RESPONSIBILITY OF THE MANUFACTURER. NOTE: 14" FLOOR TRUSSES @ 24" O.C. MAX. IS AN ACCEPTABLE ALTERNATE FLOOR SYSTEM
- INDICATES LOCATIONS OF POTENTIAL TILE FLOOR. JOIST MANUFACTURER SHALL DESIGN FLOOR SYSTEM FOR ADD'L 10 PSF DEAD LOAD AT THESE LOCATIONS.
- [Symbol] INTERIOR BEARING WALL
- [Symbol] BEARING WALL ABOVE (B.W.A.)
- [Symbol] BEAM/HEADER
- [Symbol] METAL HANGER
- * INDICATES POST ABOVE (P.A.) PROVIDE SOLID BLOCKING UNDER POST OR JAMB ABOVE.

**HARRINGTON
 Lot 44**

THIS LEVEL HAS BEEN DESIGNED FOR 9'-1" PLATE HEIGHT
 REFER TO S.O. FOR TYPICAL STRUCTURAL NOTES & SCHEDULES

LEGEND	
	INDICATES ROOF TRUSSES @ 24" O.C. PER ROOF. MANUF. (TYP. U.N.O.)
	INDICATES TRUSS OVERFRAMING @ 24" O.C. (TYP. U.N.O.)
	INDICATES 14" DEEP FLOOR I-JOISTS @ 24" O.C. MAX. JOIST SERIES AND SPACING SHALL BE THE RESPONSIBILITY OF THE MANUFACTURER. NOTE: 14" FLOOR TRUSSES @ 24" O.C. MAX. IS AN ACCEPTABLE ALTERNATE FLOOR SYSTEM.
	INDICATES LOCATIONS OF POTENTIAL TILE FLOOR. JOIST MANUFACTURER SHALL DESIGN FLOOR SYSTEM FOR ADDL. 10 PSF DEAD LOAD AT THESE LOCATIONS.
	INTERIOR BEARING WALL
	BEARING WALL ABOVE (B.W.A.)
	BEAM/HEADER
	METAL HANGER
	INDICATES POST ABOVE (P.A.) PROVIDE SOLID BLOCKING UNDER POST OR JAMB ABOVE.

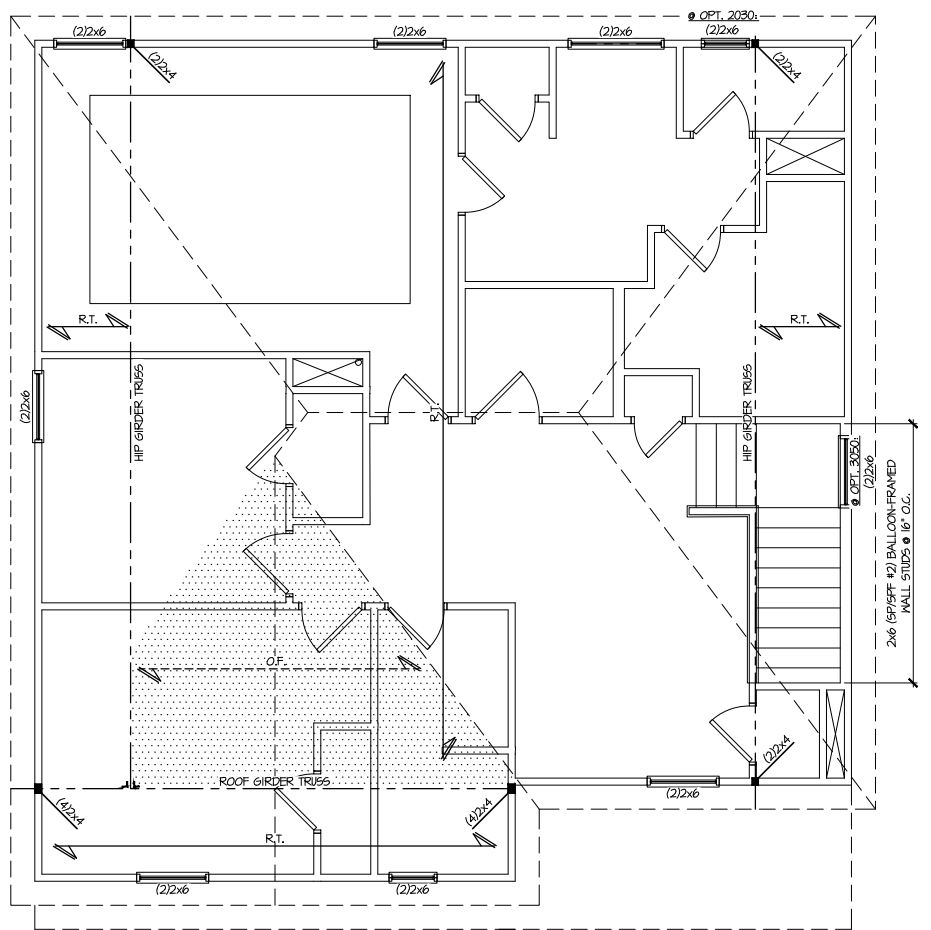

1 ROOF FRAMING PLAN
 SCALE: 1/4"=1'-0" ON 22x34
 1/8"=1'-0" ON 11x17
 ELEV. C
 ELEV. F & I SIM

LATERAL/WALL BRACING & WALL SHEATHING SPECIFICATIONS

THIS MODEL HAS BEEN DESIGNED TO RESIST LATERAL FORCES RESULTING FROM:
120MPH WIND IN 2018 NC5BC:RC & 120MPH WIND IN 2018 IRC
 (120 MPH WIND SPEED IN ASCE 7 WIND MAP, PER IRC R301.2.1.1) EXP. B, RISK CAT. 2 & SEISMIC CAT. A/B.

THE DESIGN WAS COMPLETED PER 2015 & 2018 IBC (SECTION 1609) & ASCE 7, AS PERMITTED BY R301.1.3 OF THE 2018 NC5BC:RC & 2018 IRC. ACCORDINGLY, THIS MODEL, AS DOCUMENTED AND DETAILED HEREINWITHIN, IS ADEQUATE TO RESIST THE CODE REQUIRED LATERAL FORCES.

DESIGN WIND UPLIFT LOADS HAVE BEEN CALCULATED UTILIZING ASCE 7 (ACCEPTED ENGINEERING PRACTICE) AS ALLOWED PER 2018 NC5BC:RC & 2018 IRC SECTION R802.11.1.1. THIS MODEL HAS BEEN DETAILED WHERE REQUIRED & ENGINEERED TO RESIST THE WIND UPLIFT LOAD PATH PER SECTIONS R602.3.54 R802.11.

EXT. WALL SHEATHING SPECIFICATION

- 1/16" OSB OR 15/32" PLYWOOD:
 FASTEN SHEATHING w/ 2 3/8"x0.113 NAILS @ 6" O.C. AT EDGES & @ 12" O.C. IN THE PANEL FIELD. (TYP. UNO.)
- ALL SHEATHING PANELS SHALL BE ORIENTED VERTICALLY (LONG DIRECTION PARALLEL TO STUDS) AND INSTALLED FULL HEIGHT OF SHEAR WALL - OR - 2x HORIZONTAL BLOCKING SHALL BE PROVIDED TO SUPPORT ALL UNSUPPORTED PANEL EDGES & EDGE FASTENING.
- ALL EXT. WALLS SHALL BE CONTINUOUSLY SHEATHED AND ARE CONSIDERED SHEAR WALLS.
- ALT. STAPLE CONNECTION SPEC: 1 3/4" 16 GA STAPLES (1/16" CROWN) @ 3" O.C. AT EDGES & @ 6" O.C. IN FIELD.

3" O.C. EDGE NAILING

- AT DESIGNATED AREAS - FASTEN PANEL EDGES OF WOOD STRUCTURAL WALL SHEATHING TO FRAMING w/ 2 3/8" x 0.113" NAILS @ 3" O.C. AND 12" O.C. IN THE PANEL FIELD. NO STAPLE ALTERNATIVE AVAILABLE AT THIS SPEC. ALL SHEATHING PANELS SHALL BE ORIENTED VERTICALLY (LONG DIRECTION PARALLEL TO STUD) AND INSTALLED FULL HEIGHT OF SHEAR WALL - OR - 2x HORIZONTAL BLOCKING SHALL BE PROVIDED TO SUPPORT UNSUPPORTED PANEL EDGES AND 3" O.C. EDGE FASTENING.

NOTES

- SEE CONNECTION SPECIFICATIONS CHART FOR STANDARD SHEAR TRANSFER DETAILING. IF ADDITIONAL CAPACITY IS REQUIRED BY DESIGN, IT WILL BE SPECIFICALLY NOTED ON PLAN.
- DESIGN ASSUMES 16" O.C. MAX. STUD SPACING, UNO.
- ALL STRUCTURAL PANELS ARE TO BE DIRECTLY APPLIED TO STUD FRAMING.
- PRE-MANUFACTURED PANELIZED WALLS:
 FASTEN TOGETHER END STUDS OF WALL PANELS SHEATHED w/ OSB OR PLYWOOD w/ 3" x 0.120" NAILS @ 4" O.C. (THRU ONE SIDE ONLY)

--- INDICATES EXTENT OF INT. OSB SHEARWALL, AND/OR 3" O.C. EDGE NAILING
 ► INDICATES HOLDDOWN

HARRINGTON Lot 44

THIS LEVEL HAS BEEN DESIGNED FOR 9'-1" PLATE HEIGHT
 REFER TO S0.0 FOR TYPICAL STRUCTURAL NOTES & SCHEDULES

LEGEND

- R.T. INDICATES ROOF TRUSSES @ 24" O.C. PER ROOF. MANUF. (TYP. UNO.)
- O.F. INDICATES TRUSS OVERFRAMING @ 24" O.C. (TYP. UNO.)
- F.L. INDICATES 14" DEEP FLOOR I-JOISTS @ 24" O.C. MAX. JOIST SERIES AND SPACING SHALL BE THE RESPONSIBILITY OF THE MANUFACTURER. NOTE: 14" FLOOR TRUSSES @ 24" O.C. MAX. IS AN ACCEPTABLE ALTERNATE FLOOR SYSTEM
- INDICATES LOCATIONS OF POTENTIAL TILE FLOOR. JOIST MANUFACTURER SHALL DESIGN FLOOR SYSTEM FOR ADDL. 10 PSF DEAD LOAD AT THESE LOCATIONS.
- [Symbol] INTERIOR BEARING WALL
- [Symbol] BEARING WALL ABOVE (B.W.A.)
- [Symbol] BEAM/HEADER
- JL METAL HANGER
- * INDICATES POST ABOVE (P.A.) PROVIDE SOLID BLOCKING UNDER POST OR JAMB ABOVE.

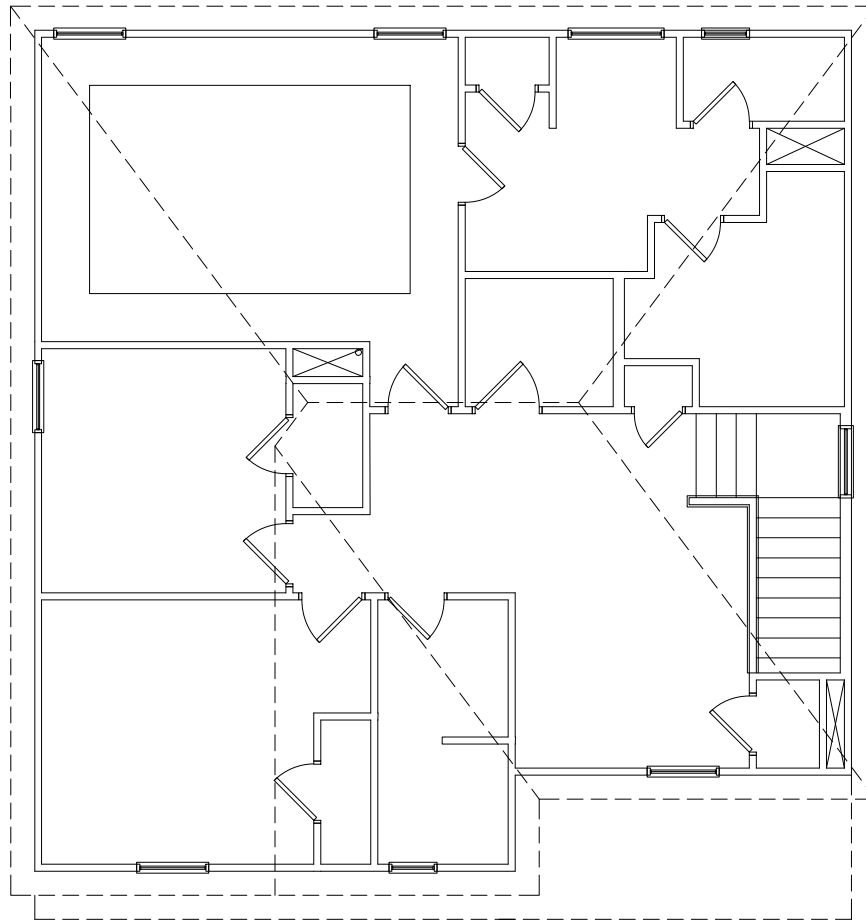

NOTE:
 NO ADD'L SHEARWALL REQUIREMENTS ARE REQUIRED BEYOND THE STANDARD EXTERIOR WALL SHEATHING SPECIFICATION FOR THIS ELEVATION

2ND FLOOR WALL BRACING PLAN
 SCALE: 1/4"=1'-0" ON 22x34 ELEV. C
 1/8"=1'-0" ON 11x17 ELEVS. F & I SIM.

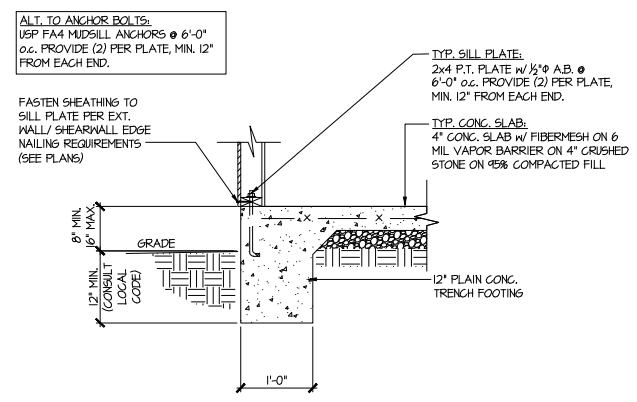

1 TYPICAL SLAB ON GRADE PERIMETER FOOTING

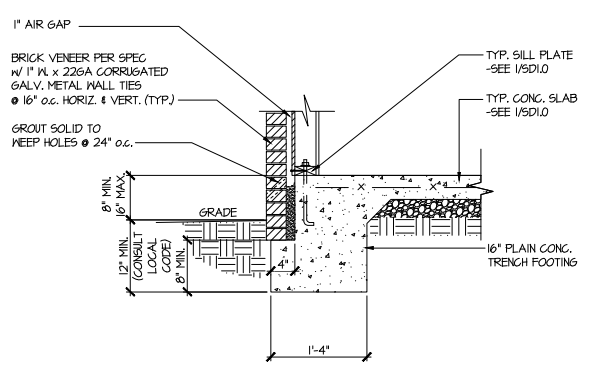

2 TYPICAL SLAB ON GRADE PERIMETER FOOTING w/ BRICK VENEER

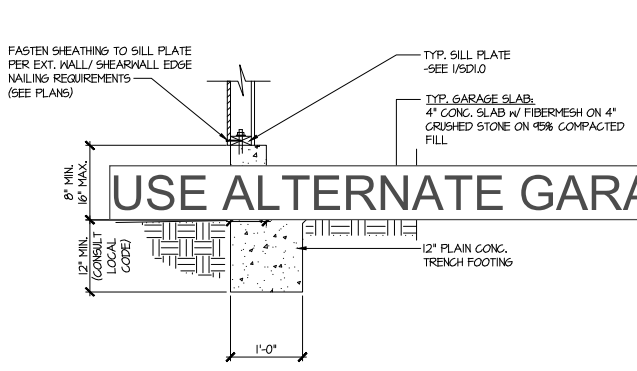

3 TYPICAL SLAB ON GRADE GARAGE PERIMETER FOOTING

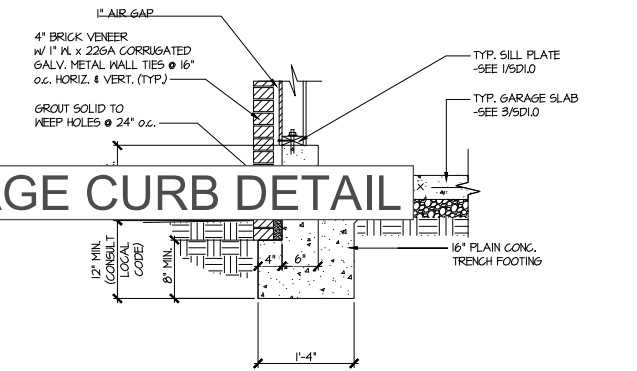

4 TYPICAL SLAB ON GRADE GARAGE PERIMETER FOOTING w/ BRICK VENEER

USE ALTERNATE GARAGE CURB DETAIL

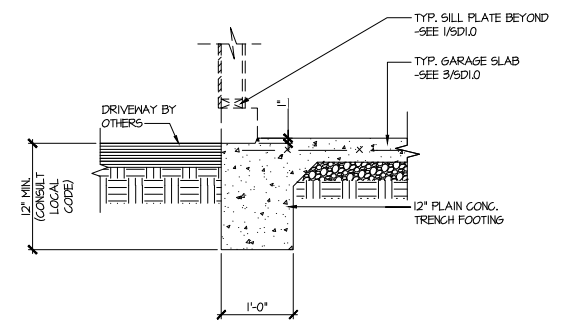

5 TYPICAL SLAB ON GRADE GARAGE ENTRY @ PERIMETER FOOTING

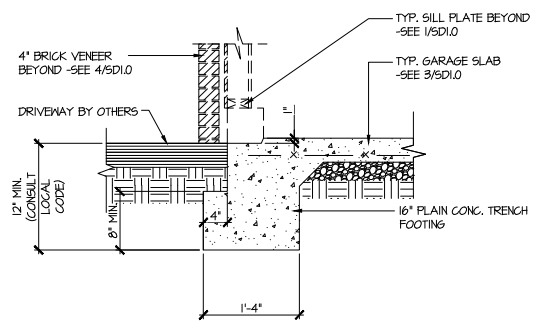

6 TYPICAL SLAB ON GRADE GARAGE ENTRY @ PERIMETER FOOTING w/ BRICK VENEER

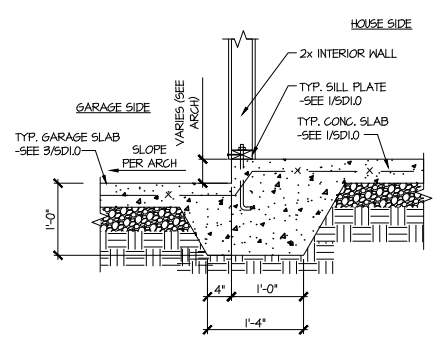

7 TYPICAL MONOLITHIC INTERIOR GARAGE FOOTING

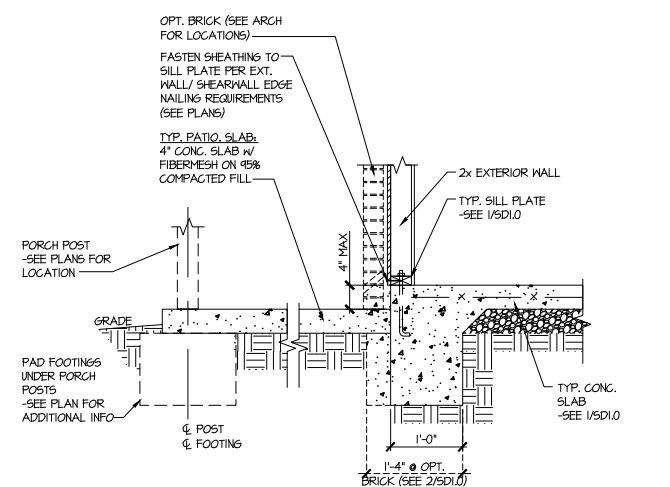

8 TYPICAL SLAB ON GRADE PERIMETER FOOTING @ PORCH/PATIO

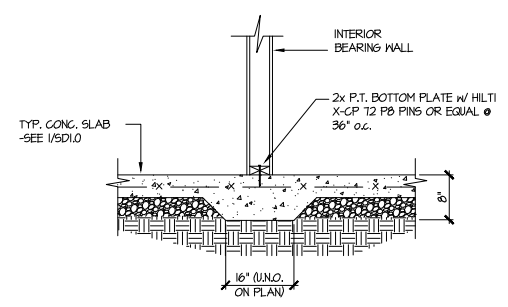

9 TYPICAL THICKENED SLAB @ INTERIOR BEARING WALL

MULHERN+KULP
 RESIDENTIAL STRUCTURAL ENGINEERING
 3825 Shallowford Parkway, Suite 105 - Alpharetta, GA 30022
 770-777-8974 - mulhern+kulp.com
 NC License # C-3825

Mulhern+Kulp project number:
 256-22019
 project mgr: SMK
 drawn by: RAP
 issue date: 01.13.2023

REVISIONS:
 date: initial:

SMITH DOUGLAS
 HOMES

FOUNDATION DETAILS
 BENSON II MODEL
 120 MPH WIND ZONE
 NORTH CAROLINA

HARRINGTON
 Lot 44

sheet:
SD1.0



MULHERN+KULP
RESIDENTIAL STRUCTURAL ENGINEERING

3625 Brookside Parkway, Suite 165, Alpharetta, GA 30022 ▶ p 770-777-0074 ▶ mulhernkulp.com

August 18, 2023

Jody Hunt
Director of Product Development
SMITH DOUGLAS HOMES
110 Village Trail, Suite 215
Woodstock, GA 30188

ALTERNATE GARAGE CURB DETAIL
Smith Douglas Homes

Reference
Current Structural Plans prepared by Mulhern & Kulp

Jody:

Pursuant to your request, we have prepared this letter to address the "Alternate Garage Curb Details", prepared by Mulhern & Kulp for Smith Douglas Homes shown below. The foundation details shown below call for a 4" wide curb with a maximum of 8" stem wall height; these are an acceptable alternative to the 6" wide curb at the garage per M&K foundation details 3 & 4 on sheet SD-1.0 at 2x4 garage wall locations.

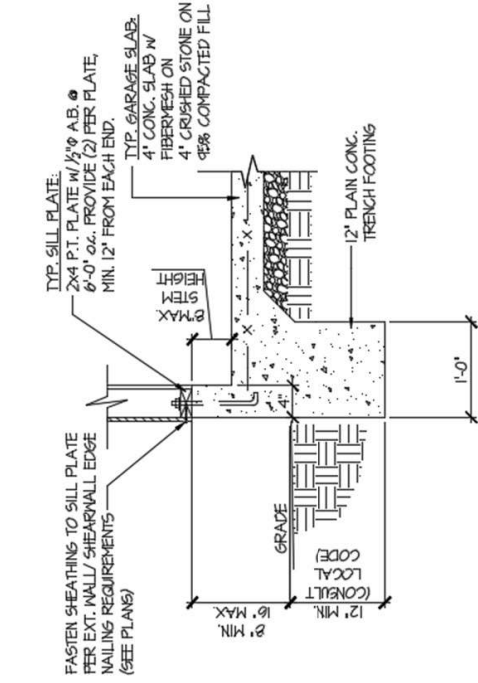

(A) TYPICAL SLAB ON GRADE GARAGE PERIMETER FOOTING

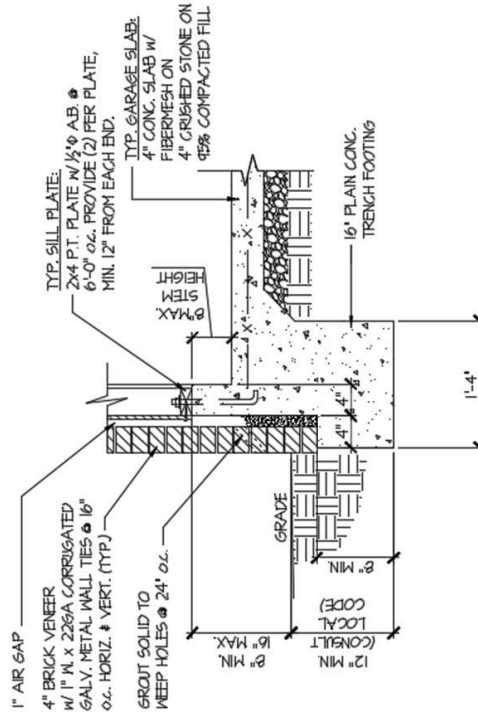

(B) TYPICAL SLAB ON GRADE GARAGE PERIMETER FOOTING

Please feel free to call if you have any questions.

Respectfully,

MULHERN & KULP STRUCTURAL ENGINEERING, INC.

NC License # C-3825

Shaun M. Kreidel, P.E. Project Manager + Atlanta Office Director



Signature + Seal 08/18/2023

HARRINGTON
Lot 44

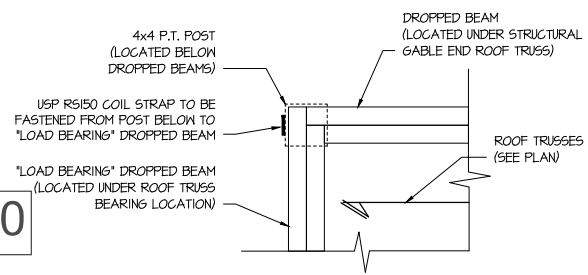
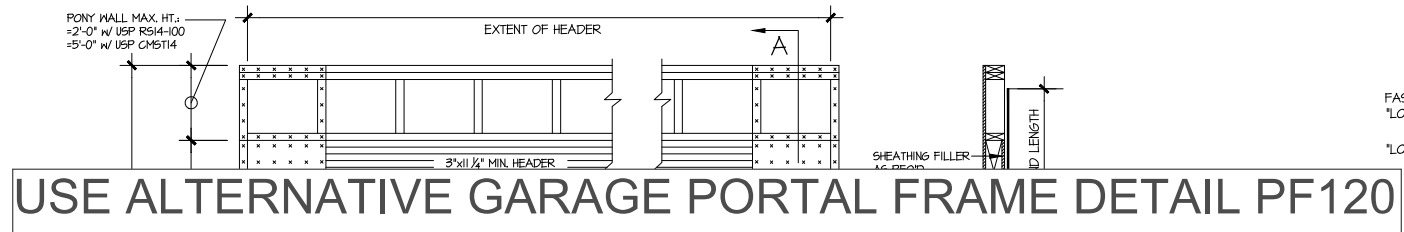

COVERED PORCH CONNECTION DETAIL
 SCALE: 1/2"=1'-0"

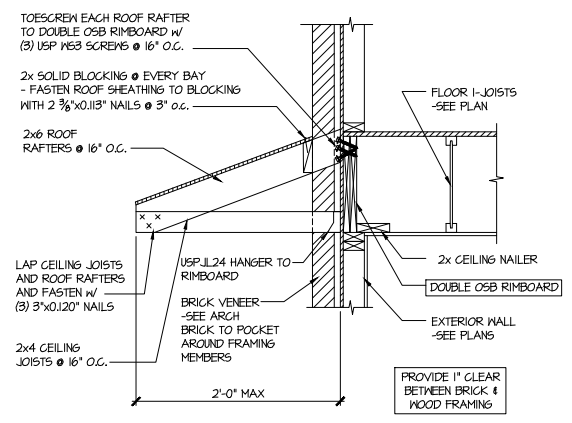

DETAIL @ PENT ROOF
 SCALE: 3/4"=1'-0"

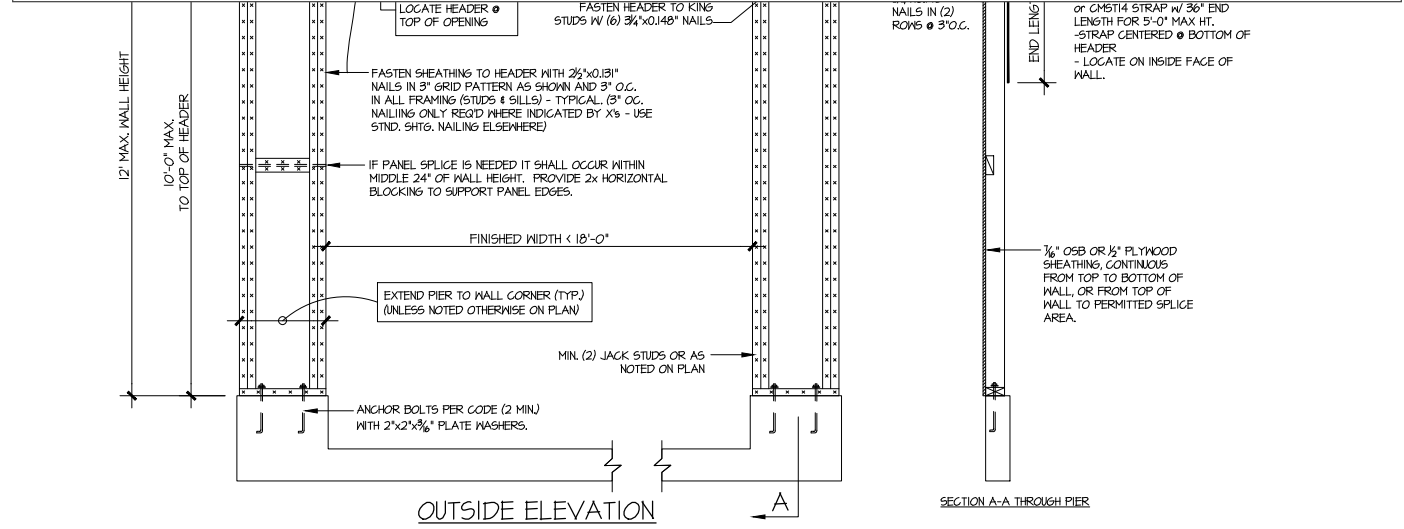

NOTE: ALL SHEATHABLE AREAS OF EXTERIOR WALL SHALL BE FULLY SHEATHED WITH 1/2" PLYWOOD OR 1/2" OSB

WALL FRAMING SPECIFICATION

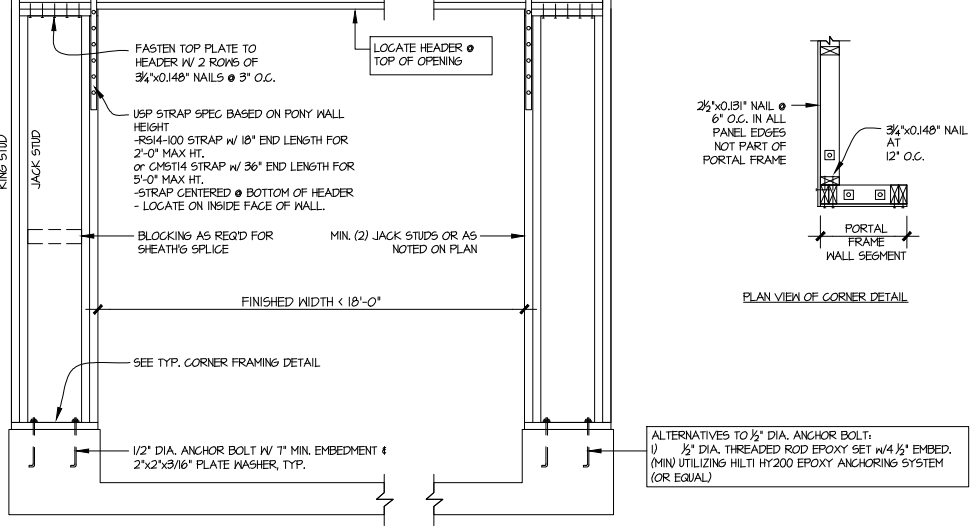
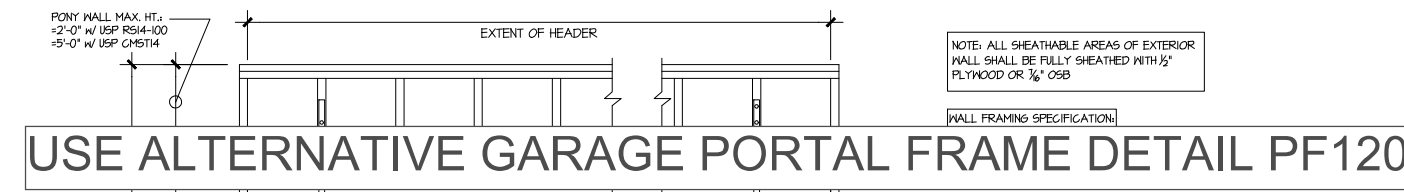

GARAGE PORTAL FRAME BRACING ELEVATION
 SCALE: N.T.S.
 BOTH SIDES OF GARAGE DOOR
 115 MPH WIND SPEED (ULT)

MULHERN+KULP
 RESIDENTIAL STRUCTURAL ENGINEERING
 3825 Remondino Parkway, Suite 105 - Alpharetta, GA 30022
 770-777-8974 - mulhern+kulp.com
 NC License # C-3825

Mulhern+Kulp project number:
 256-22019

project mgr: SMK
 drawn by: RAP
 issue date: 01.13.2023

REVISIONS:

date:	initial:

SMITH DOUGLAS
 HOMES

FRAMING DETAILS

BENSON II MODEL

120 MPH WIND ZONE
 NORTH CAROLINA

HARRINGTON
 Lot 44

sheet:
SD2.0

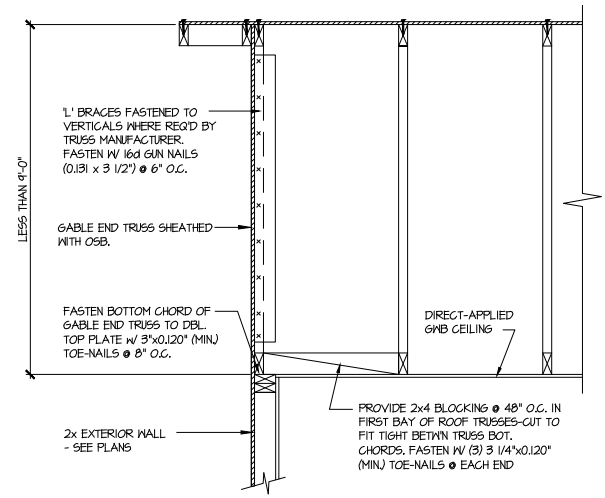
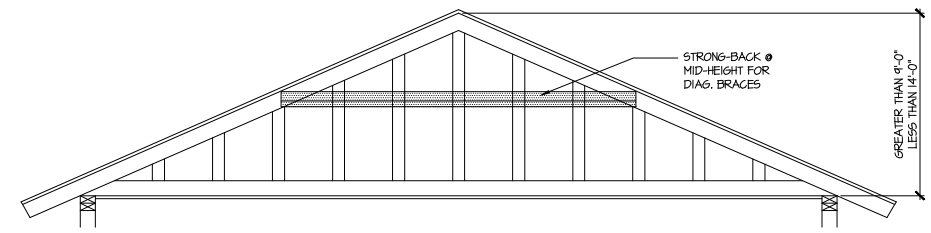
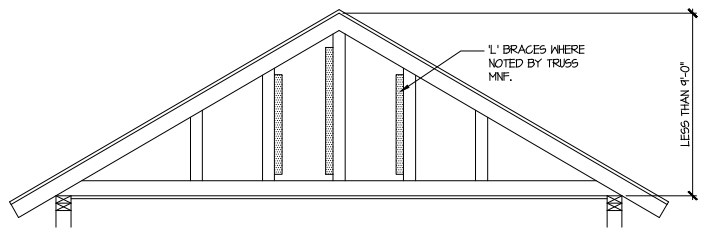

A TYPICAL GABLE END BRACING DETAIL
 SCALE: NONE
 REQ'D @ GABLE END TRUSS HEIGHT UP TO 9'-0"

BRACE GABLE END TRUSSES PER ABOVE DETAIL WHEN GABLE HEIGHT IS LESS THAN 9'-0". L' BRACES REQUIRED WHERE NOTED BY TRUSS MANUFACTURER.

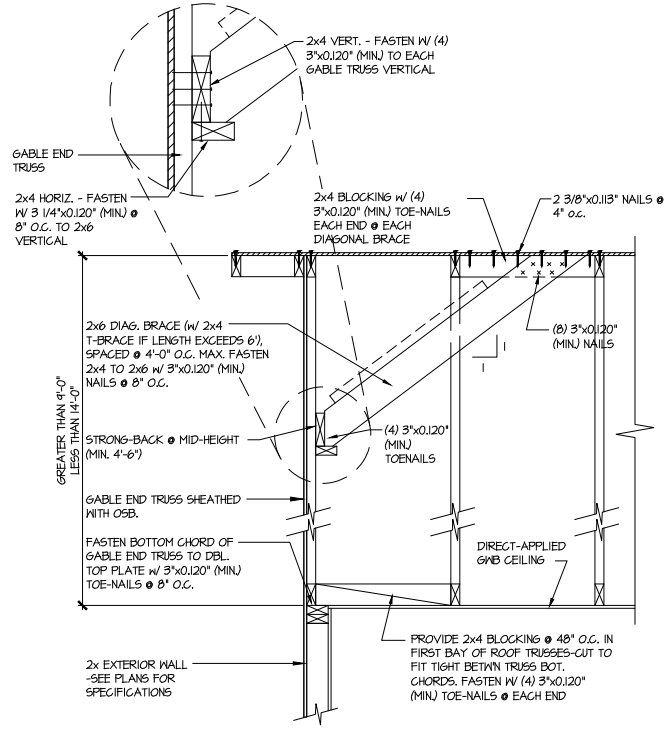

B TYPICAL GABLE END BRACING DETAIL
 SCALE: NONE
 REQ'D @ GABLE END TRUSS HEIGHT BETWEEN 9'-0" TO 14'-0"

BRACE GABLE END TRUSSES PER ABOVE DETAIL WHEN GABLE HEIGHT EXCEEDS 9'-0". L' BRACES NOT REQUIRED.

LETTERED DETAILS ARE TYPICAL FOR THIS HOME & SHALL BE IMPLEMENTED IN ALL APPLICABLE AREAS. THESE DETAILS ARE NOT "CUT" ON THE PLANS.
 NUMBERED DETAILS ARE PLAN SPECIFIC AND ARE ONLY REQUIRED WHERE SPECIFICALLY INDICATED ("CUT") ON THE PLANS.

MULHERN+KULP
 RESIDENTIAL STRUCTURAL ENGINEERING
 3025 Remondelle Parkway, Suite 105 - Alpharetta, GA 30022
 770-777-8874 - mulhern+kulp.com
 NC License # C-3825

Mulhern+Kulp project number:
 256-22019
 project mgr: SMK
 drawn by: RAP
 issue date: 01.13.2023

REVISIONS:
 date: initial:

SMITH DOUGLAS
 HOMES

FRAMING DETAILS
 BENSON II MODEL
 120 MPH WIND ZONE
 NORTH CAROLINA

HARRINGTON
 Lot 44

sheet:
SD2.1



MULHERN+KULP
RESIDENTIAL STRUCTURAL ENGINEERING

3625 Brookside Parkway, Suite 165, Alpharetta, GA 30022 ▶ p 770-777-0074 ▶ mulhernkulp.com

July 28, 2023

Jody Hunt
Director of Product Development
SMITH DOUGLAS HOMES
110 Village Trail, Suite 215
Woodstock, GA 30188

ALTERNATE GARAGE PORTAL FRAME DETAIL
Smith Douglas Homes

Reference

"Alternate Garage Portal Frame Detail" on sheet PF-120 & PF-130, prepared by Mulhern & Kulp dated 07/28/2023 - attached

Jody:

Pursuant to your request, we have prepared this letter to address the "Alternate Garage Portal Frame Detail", prepared by Mulhern & Kulp for Smith Douglas Homes.

The "Alternate Garage Portal Frame Detail" on sheet "PF-120" is an acceptable alternative portal frame design for anywhere in North Carolina with a wind speed less than or equal to 120mph ultimate wind speed per ASCE 7-16. The "Alternate Garage Portal Frame Detail" on sheet "PF-130" is an acceptable alternative portal frame design for anywhere in North Carolina with a wind speed less than or equal to 130mph ultimate wind speed per ASCE 7-16. These details only apply to structural plans that have been designed by Mulhern & Kulp. It is the responsibility of "SDH" to provide the correct "Alternate Garage Portal Frame Detail", to the building department that matches the jurisdiction's wind speed requirements.

Please feel free to call if you have any questions.

Respectfully,

MULHERN & KULP STRUCTURAL ENGINEERING, INC.

NC License # C-3825

Shaun M. Kreidel, P.E. Project Manager + Atlanta Office Director

Signature + Seal 07/28/2023

REVISIONS:	
date:	initial:

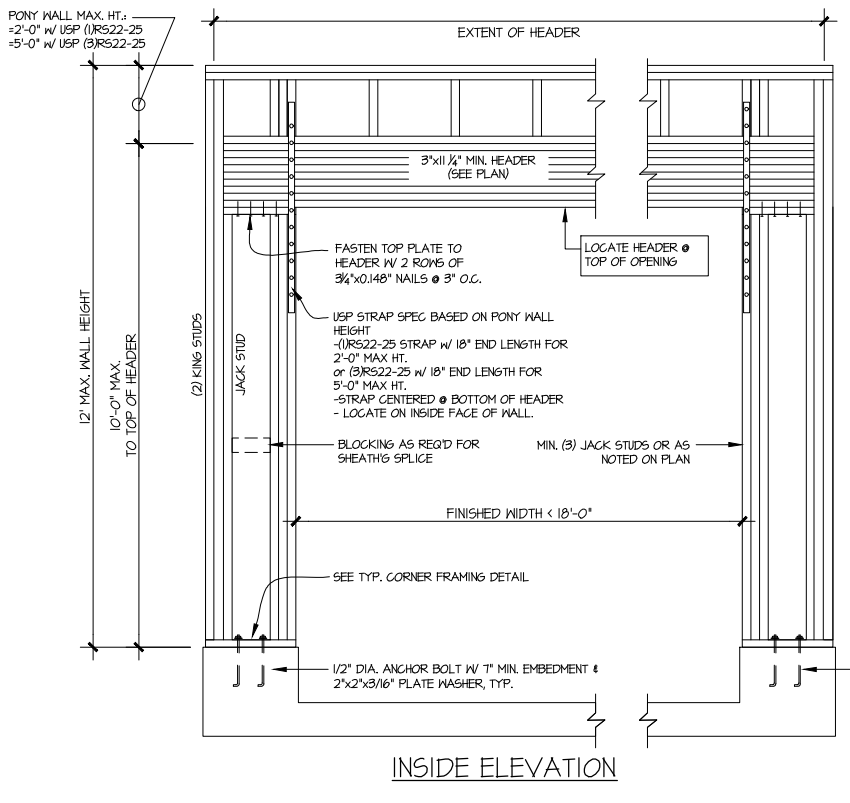
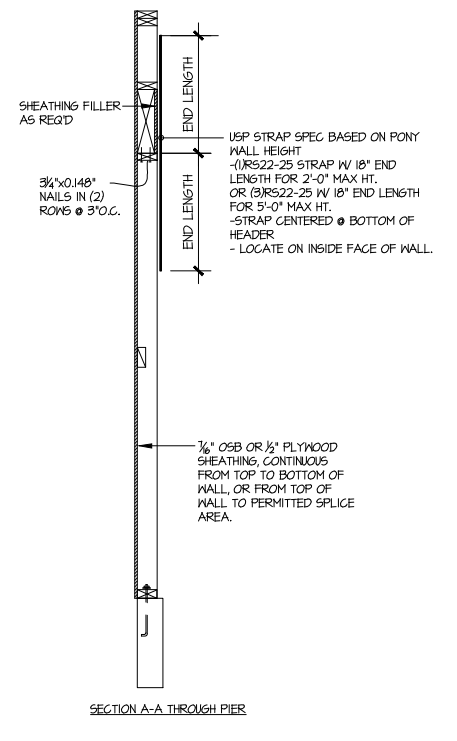
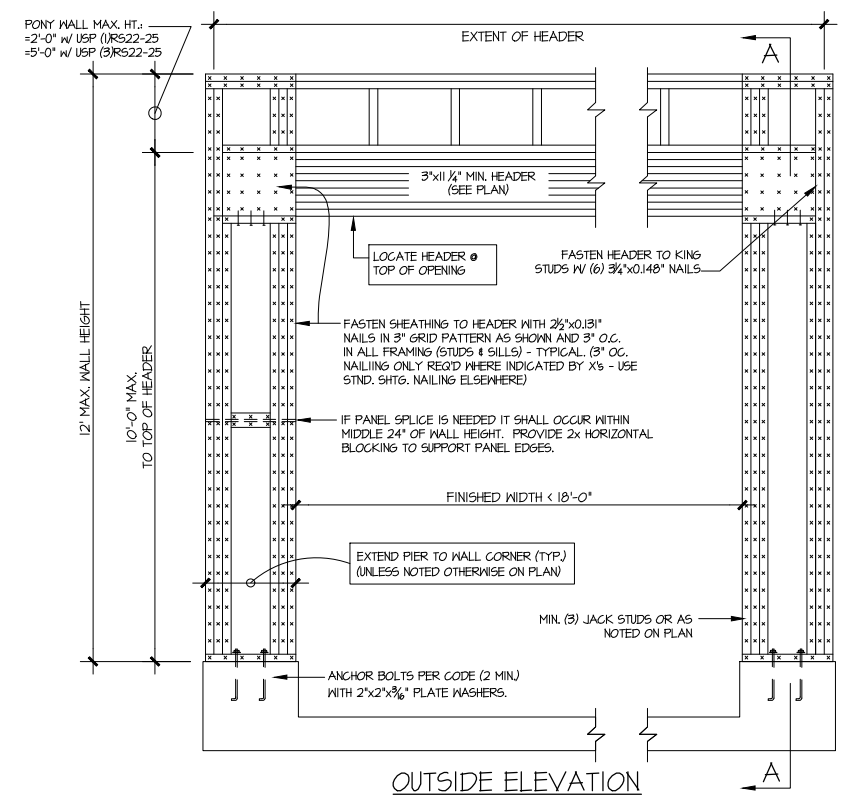

NOTE: ALL SHEATHABLE AREAS OF EXTERIOR WALL SHALL BE FULLY SHEATHED WITH 1/2" PLYWOOD OR 3/8" OSB

WALL FRAMING SPECIFICATION:
@2x4 WALL: USE SFF #2 GRADE STUDS (OR BETTER)
@2x6 WALL: USE SFF #1UD GRADE STUDS (OR BETTER)

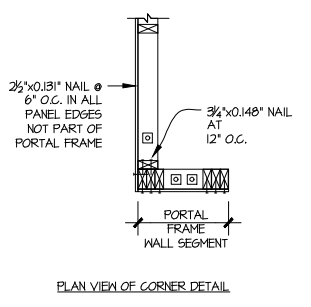

ALTERNATIVES TO 1/2" DIA. ANCHOR BOLT:
1) 1/2" DIA. THREADED ROD EPOXY SET W/ 1/4" 1/2" EMBED. (MIN) UTILIZING HILTI HY200 EPOXY ANCHORING SYSTEM (OR EQUAL)

A ALTERNATE GARAGE PORTAL FRAME BRACING ELEVATION

SCALE: N.T.S.

BOTH SIDES OF GARAGE DOOR
120 MPH WIND SPEED (ULT)

HARRINGTON
Lot 44

THIS IS A TRUSS PLACEMENT DIAGRAM (TPD) ONLY, NOT AN ENGINEERED DOCUMENT. Trusses are designed as individual building components to be incorporated into the building design at the specification of the building designer. See individual truss design drawings (TDDs) for each truss design identified on the TPD. The Contractor is responsible for the permanent bracing of the roof and floor system, and the building designer is responsible for the permanent bracing of the roof and floor system and the overall structure. The design of the support structure including but not limited to headers, beams, walls, and columns is also the responsibility of the building designer. For general guidance regarding installation and bracing, consult "Building Component Safety Information (BCSI)" available from the SBC Association (www.sbcassociation.com). It is the responsibility of the General Contractor to verify that the provided component layout matches the final intended construction plans, loading conditions, and use. If they do not, it is the responsibility of the General Contractor to notify UFP and provide plans containing the latest specifications and designs. UFP will not be responsible for plan changes by others after final approval of shop drawings, or for errors or modifications made on-site during construction. DO NOT CUT, NOTCH, DRILL, OR OTHERWISE "REPAIR" MANUFACTURED TRUSSES IN ANY WAY WITHOUT PRIOR WRITTEN AUTHORIZATION BY A LICENSED PROFESSIONAL DESIGNATED BY UFP. The Framing is responsible to verify all dimensions, including adjusting member spacing within tolerances to allow for the drop and rise of plumbing/HVAC, unless noted otherwise. Truss-to-wall connections, if shown, are for uplift only and do not consider lateral loads. All connectors on this project are to be installed per the connector manufacturer's specifications. All connectors shown that are not truss-to-truss are suggestions only and are to be verified by the Building Designer or Engineer of Record for suitability to this particular project. UFP accepts no responsibility for the specific application or suitability of any connector that is not truss-to-truss as they apply to this specific structure.

ROOF TRUSS PLACEMENT PLAN

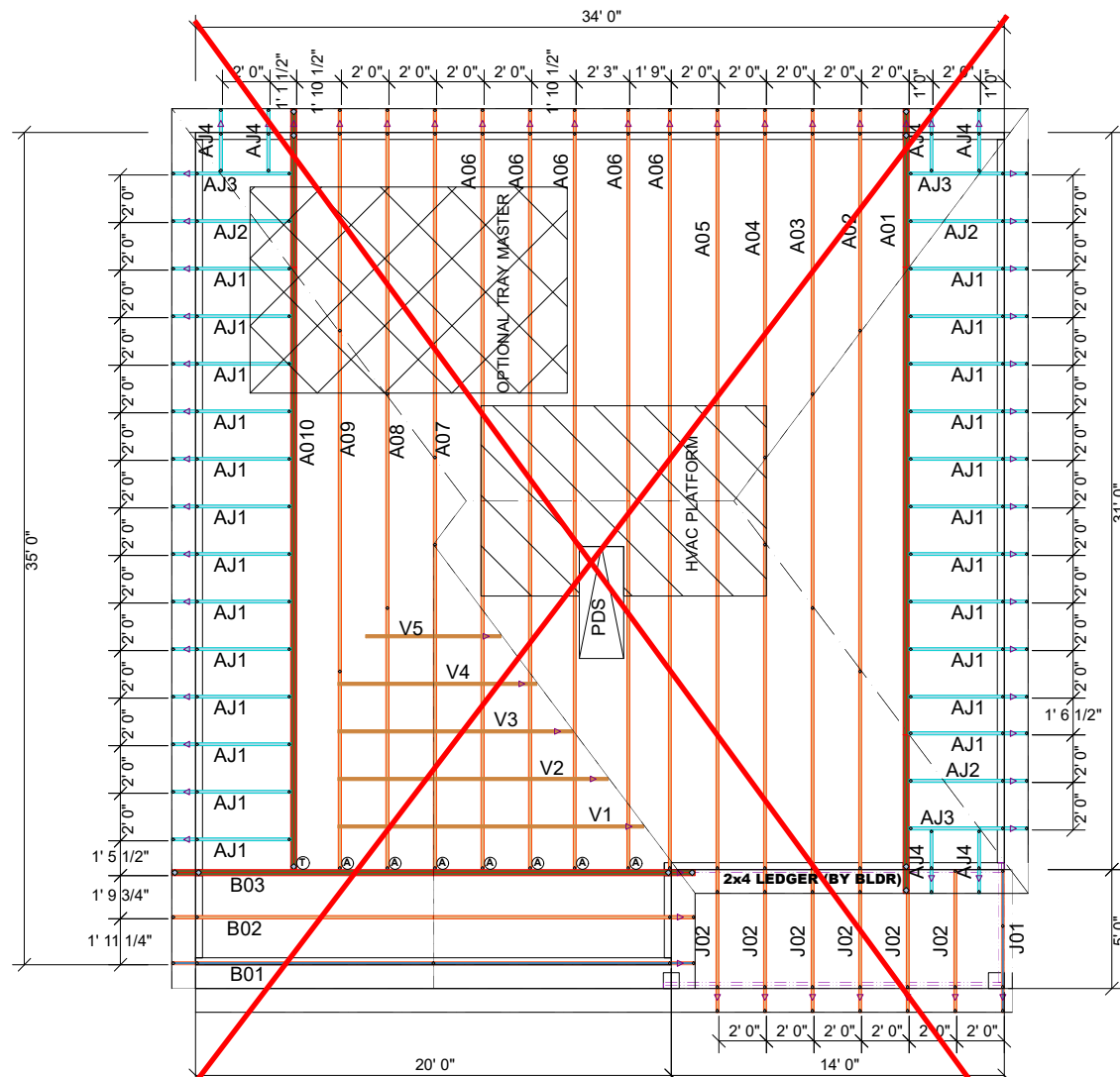

BENSON II CFI

QTY	DESCRIPTION	TYPE	MARK
7	FACE MOUNT HANGER	HUS26	A
1	FACE MOUNT HANGER	THD28-2	T

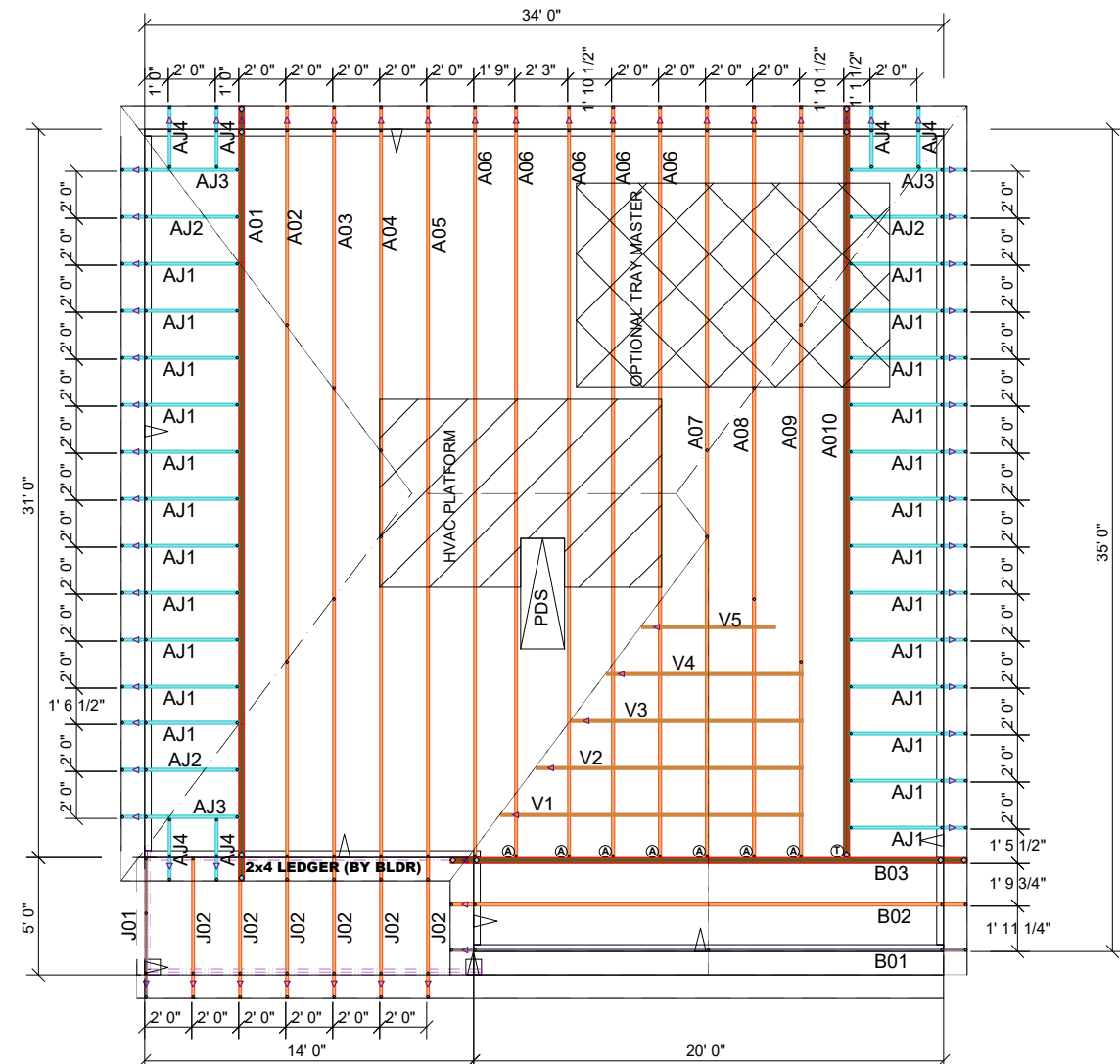

BENSON II CFI

MARK	TYPE	DESCRIPTION	QTY
(A)	HUS26	FACE MOUNT HANGER	7
(T)	THD28-2	FACE MOUNT HANGER	1

△ INDICATES LEFT END OF TRUSS SCALE: 1/8" = 1'

UFP SITE BUILT
A UFP INDUSTRIES COMPANY

Burlington, NC
Chesapeake, VA
Clinton, NC
Conway, SC
Jefferson, GA

Locust, NC
Liberty, NC
Ooltewah, TN
Pearisburg, VA
Stanfield, NC

Customer Service (800) 476-9356



This drawing is property of UFP Site Built, LLC. Any unauthorized use of this document without written permission is prohibited. UFP relinquishes ownership of delivered product upon delivery. Owner of product must obtain UFP's authorization prior to any alteration or modification of product. UFP will not be held responsible for any unauthorized modifications done or costs incurred without prior written authorization from UFP.

SMITH DOUGLAS

BENSON CFI ROOF

REVISIONS	DESCRIPTION	DATE	DSN

DESIGNER
LAYOUT DATE 04.28.2023
ARCH DATE
STRUC DATE N/A
JOB #: MASTER

