

RE: J0724-4217  
 Lot 140 Duncans Creek

Trenco  
 818 Soundside Rd  
 Edenton, NC 27932

**Site Information:**

Customer: Project Name: J0724-4217  
 Lot/Block: Model:  
 Address: Subdivision:  
 City: State:

**General Truss Engineering Criteria & Design Loads (Individual Truss Design Drawings Show Special Loading Conditions):**

Design Code: IRC2015/TPI2014 Design Program: MiTek 20/20 8.4  
 Wind Code: N/A Wind Speed: N/A mph  
 Roof Load: N/A psf Floor Load: 55.0 psf

This package includes 16 individual, dated Truss Design Drawings and 0 Additional Drawings.

No.	Seal#	Truss Name	Date
1	I64045946	F01	3/6/2024
2	I64045947	F02	3/6/2024
3	I64045948	F03	3/6/2024
4	I64045949	F04	3/6/2024
5	I64045950	F05	3/6/2024
6	I64045951	F06	3/6/2024
7	I64045952	F07	3/6/2024
8	I64045953	F08	3/6/2024
9	I64045954	F09	3/6/2024
10	I64045955	F10	3/6/2024
11	I64045956	F11	3/6/2024
12	I64045957	FKW1	3/6/2024
13	I64045958	FKW2	3/6/2024
14	I64045959	FKW3	3/6/2024
15	I64045960	FKW4	3/6/2024
16	I64045961	FKW5	3/6/2024

The truss drawing(s) referenced above have been prepared by Truss Engineering Co. under my direct supervision based on the parameters provided by Comtech, Inc - Fayetteville.

Truss Design Engineer's Name: Gilbert, Eric

My license renewal date for the state of North Carolina is December 31, 2024.

North Carolina COA: C-0844

IMPORTANT NOTE: The seal on these truss component designs is a certification that the engineer named is licensed in the jurisdiction(s) identified and that the designs comply with ANSI/TPI 1. These designs are based upon parameters shown (e.g., loads, supports, dimensions, shapes and design codes), which were given to TRENCO. Any project specific information included is for TRENCO customers file reference purpose only, and was not taken into account in the preparation of these designs. TRENCO has not independently verified the applicability of the design parameters or the designs for any particular building. Before use, the building designer should verify applicability of design parameters and properly incorporate these designs into the overall building design per ANSI/TPI 1, Chapter 2.



March 06, 2024

Job J0724-4217	Truss F01	Truss Type Floor	Qty 4	Ply 1	Lot 140 Duncans Creek I64045946 Job Reference (optional)
-------------------	--------------	---------------------	----------	----------	--

Comtech, Inc. Fayetteville, NC - 28314,

8.430 s Jan 6 2022 MiTek Industries, Inc. Tue Mar 5 12:22:15 2024 Page 1  
ID:JQb1igK2ne3CQdqy3dwnCxyStrD-RfC?PsB70Hq3NSgPqnL8w3ulTXbGKWrCDoi7J4zJC?f

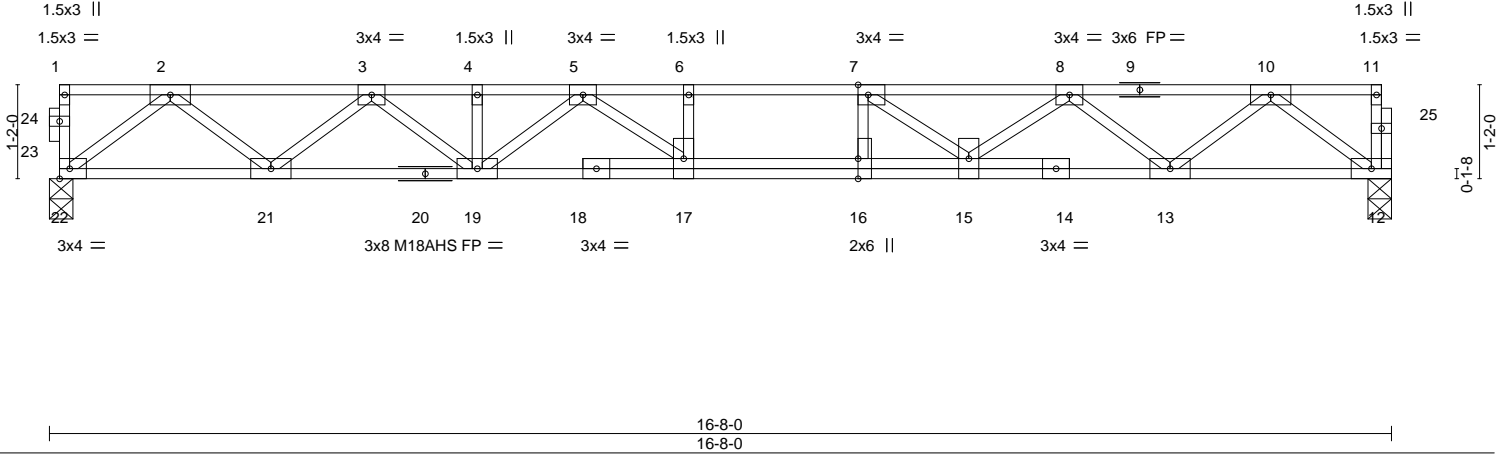
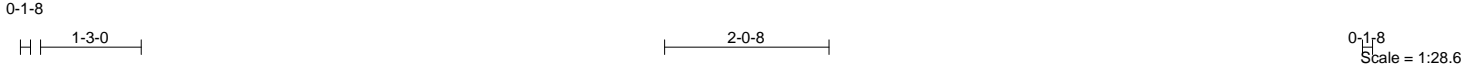

Plate Offsets (X,Y)--	[7:0-1-8,Edge], [16:0-3-0,Edge]				
<b>LOADING</b> (psf)	<b>SPACING-</b> 2-0-0	<b>CSI.</b>	<b>DEFL.</b> in (loc) l/defl L/d	<b>PLATES</b>	<b>GRIP</b>
TCLL 40.0	Plate Grip DOL 1.00	TC 0.41	Vert(LL) -0.20 16-17 >997 480	MT20	244/190
TCDL 10.0	Lumber DOL 1.00	BC 0.71	Vert(CT) -0.27 16-17 >724 360	M18AHS	186/179
BCLL 0.0	Rep Stress Incr YES	WB 0.47	Horz(CT) 0.05 12 n/a n/a		
BCDL 5.0	Code IRC2015/TPI2014	Matrix-S		Weight: 91 lb	FT = 20%F, 11%E

<b>LUMBER-</b>	<b>BRACING-</b>
TOP CHORD 2x4 SP No.1(flat)	TOP CHORD Structural wood sheathing directly applied or 6-0-0 oc purlins, except end verticals.
BOT CHORD 2x4 SP No.1(flat)	BOT CHORD Rigid ceiling directly applied or 10-0-0 oc bracing.
WEBS 2x4 SP No.3(flat)	

**REACTIONS.** (size) 22=0-3-8, 12=0-3-8  
Max Grav 22=899(LC 1), 12=893(LC 1)

**FORCES.** (lb) - Max. Comp./Max. Ten. - All forces 250 (lb) or less except when shown.  
 TOP CHORD 2-3=-1833/0, 3-4=-3019/0, 4-5=-3019/0, 5-6=-3644/0, 6-7=-3644/0, 7-8=-3099/0, 8-10=-1861/0  
 BOT CHORD 21-22=0/1076, 19-21=0/2545, 17-19=0/3409, 16-17=0/3644, 15-16=0/3644, 13-15=0/2622, 12-13=0/1109  
 WEBS 2-22=-1374/0, 2-21=0/985, 3-21=-927/0, 3-19=0/605, 10-12=-1389/0, 10-13=0/979, 8-13=-991/0, 8-15=0/605, 7-15=-853/0, 7-16=-95/331, 5-19=-498/0, 5-17=0/550

- NOTES-**
- 1) Unbalanced floor live loads have been considered for this design.
  - 2) All plates are MT20 plates unless otherwise indicated.
  - 3) All plates are 3x6 MT20 unless otherwise indicated.
  - 4) Plates checked for a plus or minus 1 degree rotation about its center.
  - 5) Recommend 2x6 strongbacks, on edge, spaced at 10-0-0 oc and fastened to each truss with 3-10d (0.131" X 3") nails. Strongbacks to be attached to walls at their outer ends or restrained by other means.

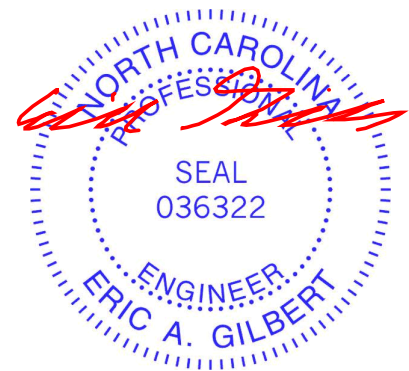

Job J0724-4217	Truss F02	Truss Type FLOOR	Qty 3	Ply 1	Lot 140 Duncans Creek I64045947
-------------------	--------------	---------------------	----------	----------	------------------------------------

Comtech, Inc. Fayetteville, NC - 28314,

8.430 s Jan 6 2022 MiTek Industries, Inc. Tue Mar 5 12:22:16 2024 Page 1  
ID:JQb1igK2ne3CQdqy3dwnCxyStrD-RfC?PsB70Hq3NSgPqnL8w3ulTXbGKWrCDoi7J4zJC?f

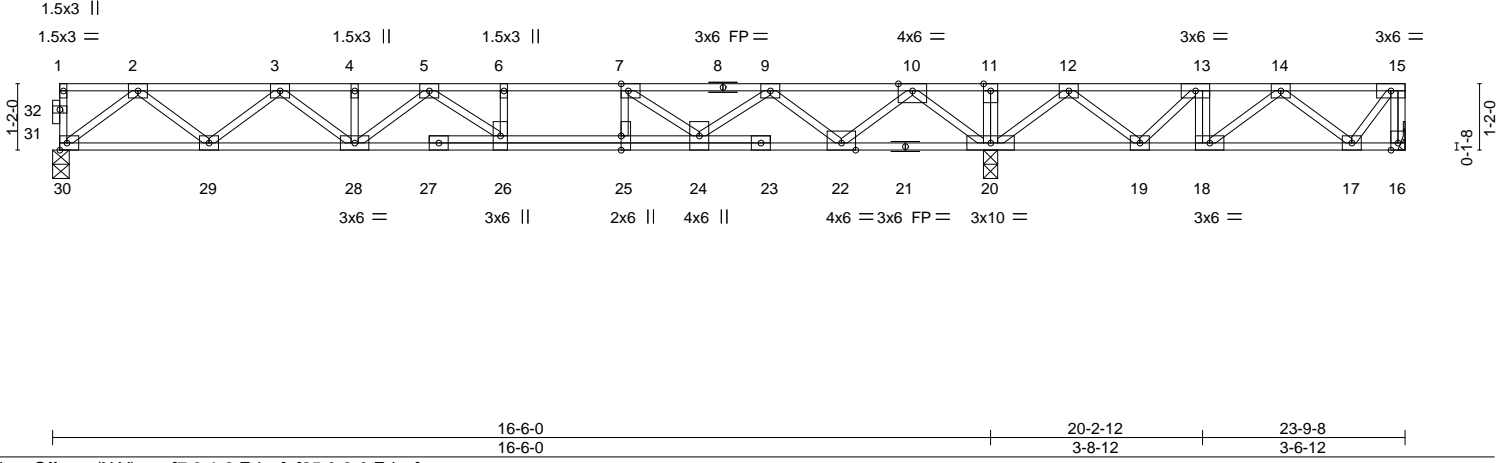

LOADING (psf)	SPACING-	CSI.	DEFL.	PLATES	GRIP
TCLL 40.0	2-0-0	TC 0.52	in (loc) l/defl L/d	MT20	244/190
TCDL 10.0	Plate Grip DOL 1.00	BC 0.61	Vert(LL) -0.16 26-28 >999 480		
BCLL 0.0	Lumber DOL 1.00	WB 0.56	Vert(CT) -0.22 26-28 >905 360		
BCDL 5.0	Rep Stress Incr YES	Matrix-S	Horz(CT) 0.03 20 n/a n/a		
	Code IRC2015/TPI2014			Weight: 131 lb	FT = 20%F, 11%E

**LUMBER-**  
TOP CHORD 2x4 SP No.1(flat)  
BOT CHORD 2x4 SP No.1(flat)  
WEBS 2x4 SP No.3(flat)

**BRACING-**  
TOP CHORD Structural wood sheathing directly applied or 6-0-0 oc purlins, except end verticals.  
BOT CHORD Rigid ceiling directly applied or 6-0-0 oc bracing.

**REACTIONS.** (size) 16=Mechanical, 30=0-3-8, 20=0-3-0  
Max Uplift 16=185(LC 3)  
Max Grav 16=290(LC 4), 30=769(LC 3), 20=1741(LC 1)

**FORCES.** (lb) - Max. Comp./Max. Ten. - All forces 250 (lb) or less except when shown.  
TOP CHORD 15-16=-292/183, 2-3=-1508/0, 3-4=-2396/0, 4-5=-2396/0, 5-6=-2504/0, 6-7=-2504/0, 7-9=-1669/0, 10-11=0/2111, 11-12=0/2111, 12-13=-146/1105, 13-14=-367/766  
BOT CHORD 29-30=0/909, 28-29=0/2076, 26-28=0/2563, 25-26=0/2504, 24-25=0/2504, 22-24=0/1052, 20-22=-842/0, 19-20=-1502/0, 18-19=-766/367, 17-18=-424/377  
WEBS 13-18=0/280, 2-30=-1161/0, 2-29=0/779, 3-29=-740/0, 3-28=0/408, 10-20=-1592/0, 10-22=0/1180, 9-22=-1150/0, 9-24=0/796, 7-24=-1099/0, 7-25=0/453, 12-20=-1049/0, 12-19=0/671, 13-19=-609/0, 14-18=-430/0, 14-17=-283/349, 15-17=-254/259

- NOTES-**
- 1) Unbalanced floor live loads have been considered for this design.
  - 2) All plates are 3x4 MT20 unless otherwise indicated.
  - 3) Plates checked for a plus or minus 1 degree rotation about its center.
  - 4) Refer to girder(s) for truss to truss connections.
  - 5) Provide mechanical connection (by others) of truss to bearing plate capable of withstanding 100 lb uplift at joint(s) except (jt=lb) 16=185.
  - 6) Recommend 2x6 strongbacks, on edge, spaced at 10-0-0 oc and fastened to each truss with 3-10d (0.131" X 3") nails. Strongbacks to be attached to walls at their outer ends or restrained by other means.
  - 7) CAUTION, Do not erect truss backwards.

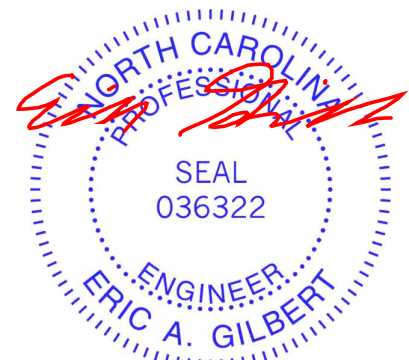

March 6, 2024

<p><b>WARNING - Verify design parameters and READ NOTES ON THIS AND INCLUDED MITEK REFERENCE PAGE MII-7473 rev. 1/2/2023 BEFORE USE.</b></p> <p>Design valid for use only with MiTek® connectors. This design is based only upon parameters shown, and is for an individual building component, not a truss system. Before use, the building designer must verify the applicability of design parameters and properly incorporate this design into the overall building design. Bracing indicated is to prevent buckling of individual truss web and/or chord members only. Additional temporary and permanent bracing is always required for stability and to prevent collapse with possible personal injury and property damage. For general guidance regarding the fabrication, storage, delivery, erection and bracing of trusses and truss systems, see <b>ANSI/TPH Quality Criteria and DSB-22</b> available from Truss Plate Institute (www.tpinst.org) and <b>BCSI Building Component Safety Information</b> available from the Structural Building Component Association (www.sbcacomponents.com)</p>	 818 Soundside Road Edenton, NC 27932
--	---

Job J0724-4217	Truss F03	Truss Type FLOOR	Qty 3	Ply 1	Lot 140 Duncans Creek Job Reference (optional)	164045948
-------------------	--------------	---------------------	----------	----------	---	-----------

Comtech, Inc. Fayetteville, NC - 28314,

8.430 s Jan 6 2022 MiTek Industries, Inc. Tue Mar 5 12:22:17 2024 Page 1

ID:JQb1igK2ne3CQdqy3dwnCxyStrD-RfC?PsB70Hq3NSgPqnL8w3ulTXbGKWrCDoi7J4zJC?f



Scale = 1:45.4

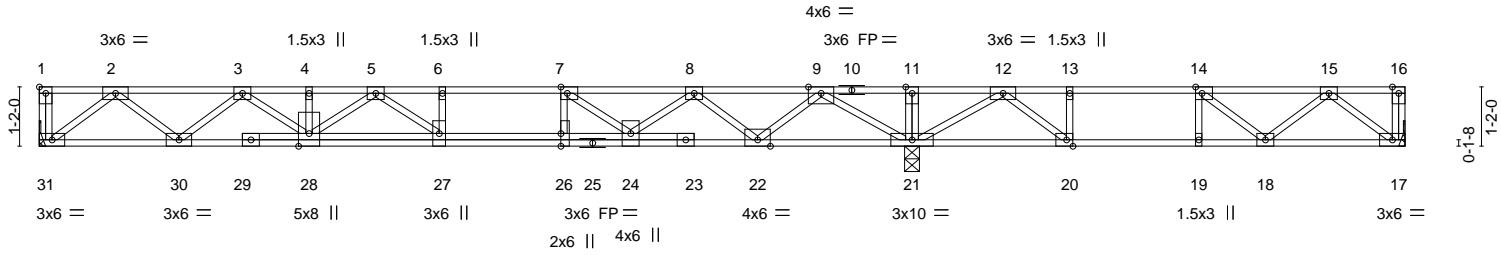

Plate Offsets (X, Y)--	[1:Edge,0-1-8], [7:0-1-8,Edge], [14:0-1-8,Edge], [26:0-3-0,Edge]
------------------------	--

<b>LOADING</b> (psf)	<b>SPACING-</b> 2-0-0	<b>CSI.</b>	<b>DEFL.</b> in (loc) l/defl L/d	<b>PLATES</b>	<b>GRIP</b>
TCLL 40.0	Plate Grip DOL 1.00	TC 0.74	Vert(LL) -0.21 27-28 >960 480	MT20	244/190
TCDL 10.0	Lumber DOL 1.00	BC 0.74	Vert(CT) -0.29 27-28 >702 360		
BCLL 0.0	Rep Stress Incr YES	WB 0.53	Horz(CT) 0.04 17 n/a n/a		
BCDL 5.0	Code IRC2015/TPI2014	Matrix-S			
				Weight: 145 lb	FT = 20%F, 11%E

<b>LUMBER-</b>	<b>BRACING-</b>
TOP CHORD 2x4 SP No.1(flat)	TOP CHORD Structural wood sheathing directly applied or 6-0-0 oc purlins, except end verticals.
BOT CHORD 2x4 SP No.1(flat)	BOT CHORD Rigid ceiling directly applied or 10-0-0 oc bracing, Except: 6-0-0 oc bracing: 20-21,19-20,18-19.
WEBS 2x4 SP No.3(flat)	

**REACTIONS.** (size) 31=Mechanical, 21=0-3-8, 17=Mechanical  
Max Grav 31=884(LC 10), 21=1654(LC 1), 17=494(LC 4)

**FORCES.** (lb) - Max. Comp./Max. Ten. - All forces 250 (lb) or less except when shown.

TOP CHORD 2-3=-1812/0, 3-4=-3108/0, 4-5=-3108/0, 5-6=-3510/0, 6-7=-3510/0, 7-8=-2814/0, 8-9=-1479/0, 9-11=0/1322, 11-12=0/1322, 12-13=-996/288, 13-14=-996/288, 14-15=-845/53

BOT CHORD 30-31=0/1090, 28-30=0/2566, 27-28=0/3415, 26-27=0/3510, 24-26=0/3510, 22-24=0/2280, 21-22=0/661, 20-21=-695/506, 19-20=-288/996, 18-19=-288/996, 17-18=0/604

WEBS 2-31=-1368/0, 2-30=0/940, 3-30=-981/0, 3-28=0/677, 5-28=-404/0, 5-27=-149/420, 9-21=-1811/0, 9-22=0/1104, 8-22=-1081/0, 8-24=0/721, 7-24=-1022/0, 7-26=-26/403, 12-21=-1074/0, 12-20=0/893, 15-17=-758/0, 15-18=-118/313, 14-18=-193/299, 13-20=-409/0

- NOTES-**
- 1) Unbalanced floor live loads have been considered for this design.
  - 2) All plates are 3x4 MT20 unless otherwise indicated.
  - 3) Plates checked for a plus or minus 1 degree rotation about its center.
  - 4) Refer to girder(s) for truss to truss connections.
  - 5) Recommend 2x6 strongbacks, on edge, spaced at 10-0-0 oc and fastened to each truss with 3-10d (0.131" X 3") nails. Strongbacks to be attached to walls at their outer ends or restrained by other means.
  - 6) CAUTION, Do not erect truss backwards.

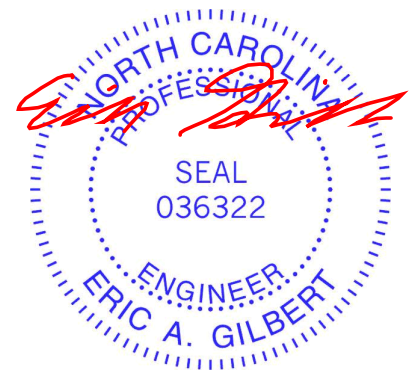

<p><b>WARNING - Verify design parameters and READ NOTES ON THIS AND INCLUDED MITEK REFERENCE PAGE MII-7473 rev. 1/2/2023 BEFORE USE.</b></p> <p>Design valid for use only with MiTek® connectors. This design is based only upon parameters shown, and is for an individual building component, not a truss system. Before use, the building designer must verify the applicability of design parameters and properly incorporate this design into the overall building design. Bracing indicated is to prevent buckling of individual truss web and/or chord members only. Additional temporary and permanent bracing is always required for stability and to prevent collapse with possible personal injury and property damage. For general guidance regarding the fabrication, storage, delivery, erection and bracing of trusses and truss systems, see <b>ANSI/TPH Quality Criteria and DSB-22</b> available from Truss Plate Institute (www.tpinst.org) and <b>BCSI Building Component Safety Information</b> available from the Structural Building Component Association (www.sbcacomponents.com)</p>	<p>818 Soundside Road Edenton, NC 27932</p>
--	---

Job J0724-4217	Truss F04	Truss Type FLOOR	Qty 3	Ply 1	Lot 140 Duncans Creek I64045949
-------------------	--------------	---------------------	----------	----------	------------------------------------

Comtech, Inc. Fayetteville, NC - 28314,

8.430 s Jan 6 2022 MiTek Industries, Inc. Tue Mar 5 12:22:19 2024 Page 1

ID:JQb1igK2ne3CQdqy3dwnCxyStrD-RfC?PsB70Hq3NSgPqnL8w3ulTXbGKWrCDoi7J4zJC?f



Scale = 1:45.4

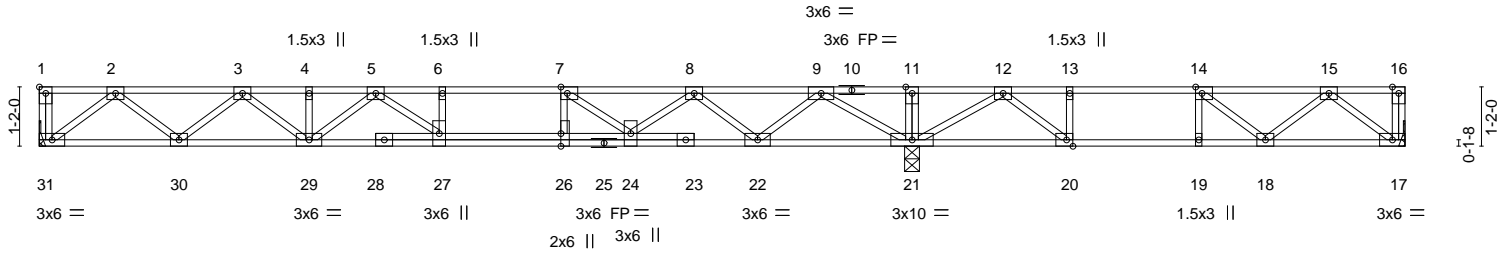

Plate Offsets (X, Y)--	[1:Edge,0-1-8], [7:0-1-8,Edge], [14:0-1-8,Edge], [26:0-3-0,Edge]
------------------------	--

LOADING (psf)	SPACING-	1-7-3	CSI.	DEFL.	in (loc)	l/defl	L/d	PLATES	GRIP	
TCLL 40.0	Plate Grip DOL	1.00	TC 0.60	Vert(LL)	-0.17	27	>999	480	MT20	244/190
TCDL 10.0	Lumber DOL	1.00	BC 0.60	Vert(CT)	-0.23	27	>888	360		
BCLL 0.0	Rep Stress Incr	YES	WB 0.42	Horz(CT)	0.04	17	n/a	n/a		
BCDL 5.0	Code IRC2015/TP12014		Matrix-S							

Weight: 142 lb FT = 20%F, 11%E

<b>LUMBER-</b>	<b>BRACING-</b>
TOP CHORD 2x4 SP No.1(flat)	TOP CHORD Structural wood sheathing directly applied or 6-0-0 oc purlins, except end verticals.
BOT CHORD 2x4 SP No.1(flat)	BOT CHORD Rigid ceiling directly applied or 10-0-0 oc bracing, Except: 6-0-0 oc bracing: 20-21,19-20,18-19.
WEBS 2x4 SP No.3(flat)	

**REACTIONS.** (size) 31=Mechanical, 21=0-3-8, 17=Mechanical  
Max Grav 31=704(LC 10), 21=1328(LC 1), 17=394(LC 4)

**FORCES.** (lb) - Max. Comp./Max. Ten. - All forces 250 (lb) or less except when shown.

TOP CHORD 2-3=-1456/0, 3-4=-2361/0, 4-5=-2361/0, 5-6=-2767/0, 6-7=-2767/0, 7-8=-2226/0, 8-9=-1155/0, 9-11=0/1086, 11-12=0/1086, 12-13=-792/248, 13-14=-792/248, 14-15=-673/52

BOT CHORD 30-31=0/876, 29-30=0/2005, 27-29=0/2631, 26-27=0/2767, 24-26=0/2767, 22-24=0/1799, 21-22=0/497, 20-21=-581/398, 19-20=-248/792, 18-19=-248/792, 17-18=0/482

WEBS 2-31=-1099/0, 2-30=0/755, 3-30=-714/0, 3-29=0/455, 5-29=-344/0, 5-27=-53/378, 9-21=-1451/0, 9-22=0/887, 8-22=-868/0, 8-24=0/576, 7-24=-808/0, 7-26=-23/320, 12-21=-866/0, 12-20=0/725, 15-17=-605/0, 14-18=-152/250, 13-20=-332/0

- NOTES-**
- 1) Unbalanced floor live loads have been considered for this design.
  - 2) All plates are 3x4 MT20 unless otherwise indicated.
  - 3) Plates checked for a plus or minus 1 degree rotation about its center.
  - 4) Refer to girder(s) for truss to truss connections.
  - 5) Recommend 2x6 strongbacks, on edge, spaced at 10-0-0 oc and fastened to each truss with 3-10d (0.131" X 3") nails. Strongbacks to be attached to walls at their outer ends or restrained by other means.
  - 6) CAUTION, Do not erect truss backwards.



March 6, 2024

<p><b>WARNING - Verify design parameters and READ NOTES ON THIS AND INCLUDED MITEK REFERENCE PAGE MII-7473 rev. 1/2/2023 BEFORE USE.</b></p> <p>Design valid for use only with MiTek® connectors. This design is based only upon parameters shown, and is for an individual building component, not a truss system. Before use, the building designer must verify the applicability of design parameters and properly incorporate this design into the overall building design. Bracing indicated is to prevent buckling of individual truss web and/or chord members only. Additional temporary and permanent bracing is always required for stability and to prevent collapse with possible personal injury and property damage. For general guidance regarding the fabrication, storage, delivery, erection and bracing of trusses and truss systems, see <b>ANSI/TPH Quality Criteria and DSB-22</b> available from Truss Plate Institute (www.tpinst.org) and <b>BCSI Building Component Safety Information</b> available from the Structural Building Component Association (www.sbcacomponents.com)</p>	<p>818 Soundside Road Edenton, NC 27932</p>
--	---

Job J0724-4217	Truss F05	Truss Type FLOOR	Qty 3	Ply 1	Lot 140 Duncans Creek 164045950
-------------------	--------------	---------------------	----------	----------	------------------------------------

Comtech, Inc. Fayetteville, NC - 28314,

8.430 s Jan 6 2022 MiTek Industries, Inc. Tue Mar 5 12:22:20 2024 Page 1

ID:JQb1igK2ne3CQdqy3dwnCxyStrD-RfC?PsB70Hq3NSgPqnL8w3ulTXbGKWrCDoi7J4zJC?f



Scale = 1:44.6

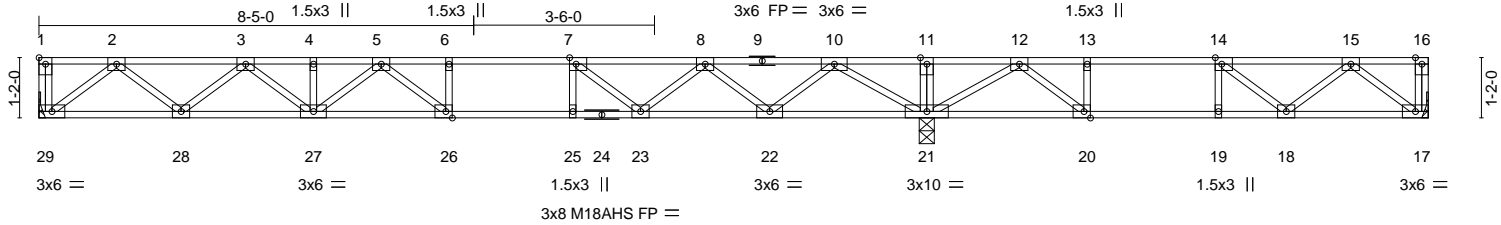

Plate Offsets (X,Y)--	[1:Edge,0-1-8], [7:0-1-8,Edge], [14:0-1-8,Edge], [20:0-1-8,Edge], [26:0-1-8,Edge]
-----------------------	---

<b>LOADING</b> (psf)	<b>SPACING-</b> 1-7-3	<b>CSI.</b>	<b>DEFL.</b> in (loc) l/defl L/d	<b>PLATES</b>	<b>GRIP</b>
TCLL 40.0	Plate Grip DOL 1.00	TC 0.59	Vert(LL) -0.23 26-27 >886 480	MT20	244/190
TCDL 10.0	Lumber DOL 1.00	BC 0.85	Vert(CT) -0.31 26-27 >650 360	M18AHS	186/179
BCLL 0.0	Rep Stress Incr YES	WB 0.42	Horz(CT) 0.05 17 n/a n/a		
BCDL 5.0	Code IRC2015/TP12014	Matrix-S		Weight: 133 lb	FT = 20%F, 11%E

<b>LUMBER-</b>	<b>BRACING-</b>
TOP CHORD 2x4 SP No.1(flat)	TOP CHORD Structural wood sheathing directly applied or 6-0-0 oc purlins, except end verticals.
BOT CHORD 2x4 SP No.1(flat)	BOT CHORD Rigid ceiling directly applied or 10-0-0 oc bracing, Except: 6-0-0 oc bracing: 20-21,19-20,18-19.
WEBS 2x4 SP No.3(flat)	

**REACTIONS.** (size) 29=Mechanical, 17=Mechanical, 21=0-3-8  
Max Grav 29=707(LC 10), 17=396(LC 4), 21=1319(LC 1)

**FORCES.** (lb) - Max. Comp./Max. Ten. - All forces 250 (lb) or less except when shown.

TOP CHORD 2-3=-1458/0, 3-4=-2388/0, 4-5=-2388/0, 5-6=-2649/0, 6-7=-2649/0, 7-8=-2189/0, 8-10=-1191/0, 10-11=0/1022, 11-12=0/1022, 12-13=-800/220, 13-14=-800/220, 14-15=-677/37

BOT CHORD 28-29=0/877, 27-28=0/2020, 26-27=0/2618, 25-26=0/2649, 23-25=0/2649, 22-23=0/1799, 21-22=0/539, 20-21=-540/410, 19-20=-220/800, 18-19=-220/800, 17-18=0/484

WEBS 2-29=-1100/0, 2-28=0/757, 3-28=-732/0, 3-27=0/470, 5-27=-293/0, 5-26=-178/313, 10-21=-1453/0, 10-22=0/876, 8-22=-823/0, 8-23=0/548, 7-23=-691/0, 15-17=-607/0, 15-18=-90/252, 12-21=-857/0, 12-20=0/709, 13-20=-324/0

- NOTES-**
- 1) Unbalanced floor live loads have been considered for this design.
  - 2) All plates are MT20 plates unless otherwise indicated.
  - 3) All plates are 3x4 MT20 unless otherwise indicated.
  - 4) Plates checked for a plus or minus 1 degree rotation about its center.
  - 5) Refer to girder(s) for truss to truss connections.
  - 6) Recommend 2x6 strongbacks, on edge, spaced at 10-0-0 oc and fastened to each truss with 3-10d (0.131" X 3") nails. Strongbacks to be attached to walls at their outer ends or restrained by other means.
  - 7) CAUTION, Do not erect truss backwards.

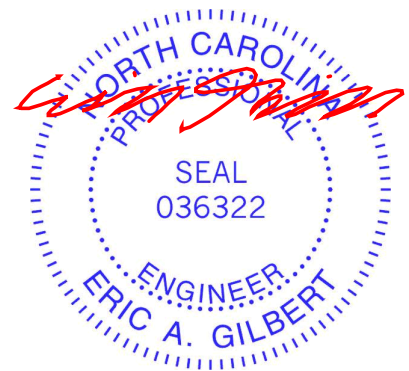

March 6, 2024

<p><b>WARNING - Verify design parameters and READ NOTES ON THIS AND INCLUDED MITEK REFERENCE PAGE MII-7473 rev. 1/2/2023 BEFORE USE.</b></p> <p>Design valid for use only with MiTek® connectors. This design is based only upon parameters shown, and is for an individual building component, not a truss system. Before use, the building designer must verify the applicability of design parameters and properly incorporate this design into the overall building design. Bracing indicated is to prevent buckling of individual truss web and/or chord members only. Additional temporary and permanent bracing is always required for stability and to prevent collapse with possible personal injury and property damage. For general guidance regarding the fabrication, storage, delivery, erection and bracing of trusses and truss systems, see <b>ANSI/TPH Quality Criteria and DSB-22</b> available from Truss Plate Institute (www.tpinst.org) and <b>BCSI Building Component Safety Information</b> available from the Structural Building Component Association (www.sbcacomponents.com)</p>	<p>818 Soundside Road Edenton, NC 27932</p>
--	---



Job J0724-4217	Truss F06	Truss Type Floor	Qty 4	Ply 1	Lot 140 Duncans Creek Job Reference (optional)	I64045951
-------------------	--------------	---------------------	----------	----------	---	-----------

Comtech, Inc. Fayetteville, NC - 28314,

8.430 s Jan 6 2022 MiTek Industries, Inc. Tue Mar 5 12:22:21 2024 Page 1  
ID:JQb1igK2ne3CQdqy3dwnCxyStrD-RfC?PsB70Hq3NSgPqnL8w3ulTXbGKWrCDoi7J4zJC?f

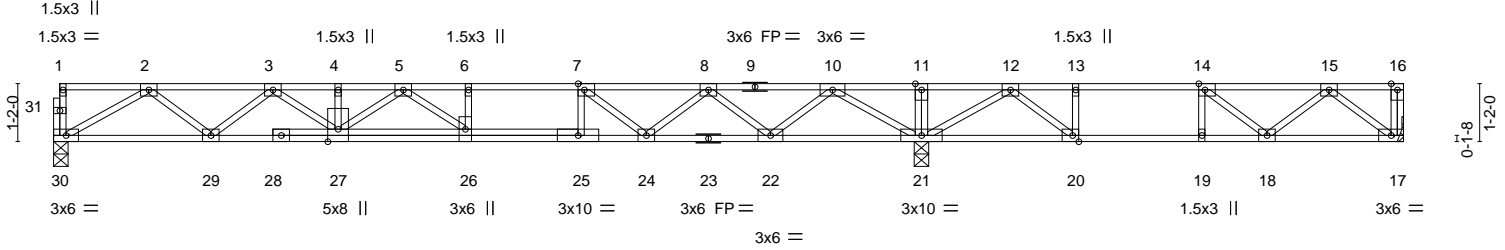

Plate Offsets (X,Y)--	[7:0-1-8,Edge], [14:0-1-8,Edge], [20:0-1-8,Edge]
-----------------------	--

LOADING (psf)	SPACING-	1-7-3	CSI.	DEFL.	in (loc)	l/defl	L/d	PLATES	GRIP
TCLL 40.0	Plate Grip DOL	1.00	TC 0.59	Vert(LL)	-0.22	26-27	>931	MT20	244/190
TCDL 10.0	Lumber DOL	1.00	BC 0.98	Vert(CT)	-0.31	26-27	>678		
BCLL 0.0	Rep Stress Incr	YES	WB 0.43	Horz(CT)	0.04	17	n/a		
BCDL 5.0	Code IRC2015/TPI2014		Matrix-S						
								Weight: 142 lb	FT = 20%F, 11%E

LUMBER-	BRACING-
TOP CHORD 2x4 SP No.1(flat)	TOP CHORD Structural wood sheathing directly applied or 6-0-0 oc purlins, except end verticals.
BOT CHORD 2x4 SP No.1(flat)	BOT CHORD Rigid ceiling directly applied or 2-2-0 oc bracing.
WEBS 2x4 SP No.3(flat)	

**REACTIONS.** (size) 30=0-3-8, 21=0-3-8, 17=Mechanical  
Max Grav 30=714(LC 10), 21=1337(LC 1), 17=394(LC 4)

**FORCES.** (lb) - Max. Comp./Max. Ten. - All forces 250 (lb) or less except when shown.  
**TOP CHORD** 2-3=-1666/0, 3-4=-2669/0, 4-5=-2669/0, 5-6=-2760/0, 6-7=-2760/0, 7-8=-2231/0, 8-10=-1211/0, 10-11=0/1075, 11-12=0/1075, 12-13=-794/239, 13-14=-794/239, 14-15=-674/47  
**BOT CHORD** 29-30=0/1117, 27-29=0/2254, 26-27=0/2833, 25-26=0/2758, 24-25=0/2760, 22-24=0/1830, 21-22=0/541, 20-21=-569/401, 19-20=-239/794, 18-19=-239/794, 17-18=0/482  
**WEBS** 2-30=-1289/0, 2-29=0/715, 3-29=-764/0, 3-27=0/518, 10-21=-1483/0, 10-22=0/902, 8-22=-842/0, 8-24=0/560, 7-24=-757/0, 7-25=-16/262, 5-27=-272/0, 5-26=-300/248, 12-21=-865/0, 12-20=0/720, 13-20=-329/0, 15-17=-605/0

- NOTES-**
- 1) Unbalanced floor live loads have been considered for this design.
  - 2) All plates are 3x4 MT20 unless otherwise indicated.
  - 3) Plates checked for a plus or minus 1 degree rotation about its center.
  - 4) Refer to girder(s) for truss to truss connections.
  - 5) Recommend 2x6 strongbacks, on edge, spaced at 10-0-0 oc and fastened to each truss with 3-10d (0.131" X 3") nails. Strongbacks to be attached to walls at their outer ends or restrained by other means.
  - 6) CAUTION, Do not erect truss backwards.



March 6, 2024

<p><b>WARNING - Verify design parameters and READ NOTES ON THIS AND INCLUDED MITEK REFERENCE PAGE MII-7473 rev. 1/2/2023 BEFORE USE.</b></p> <p>Design valid for use only with MiTek® connectors. This design is based only upon parameters shown, and is for an individual building component, not a truss system. Before use, the building designer must verify the applicability of design parameters and properly incorporate this design into the overall building design. Bracing indicated is to prevent buckling of individual truss web and/or chord members only. Additional temporary and permanent bracing is always required for stability and to prevent collapse with possible personal injury and property damage. For general guidance regarding the fabrication, storage, delivery, erection and bracing of trusses and truss systems, see <b>ANSI/TPH Quality Criteria and DSB-22</b> available from Truss Plate Institute (<a href="http://www.tpinst.org">www.tpinst.org</a>) and <b>BCSI Building Component Safety Information</b> available from the Structural Building Component Association (<a href="http://www.sbcacomponents.com">www.sbcacomponents.com</a>)</p>	<p>818 Soundside Road Edenton, NC 27932</p>
--	---

Job J0724-4217	Truss F07	Truss Type Floor	Qty 2	Ply 1	Lot 140 Duncans Creek I64045952
-------------------	--------------	---------------------	----------	----------	------------------------------------

Comtech, Inc. Fayetteville, NC - 28314,

8.430 s Jan 6 2022 MiTek Industries, Inc. Tue Mar 5 12:22:22 2024 Page 1  
ID:JQb1igK2ne3CQdqy3dwnCxyStrD-RfC?PsB70Hq3NSgPqnL8w3ulTXbGKWrCDoi7J4zJC?f

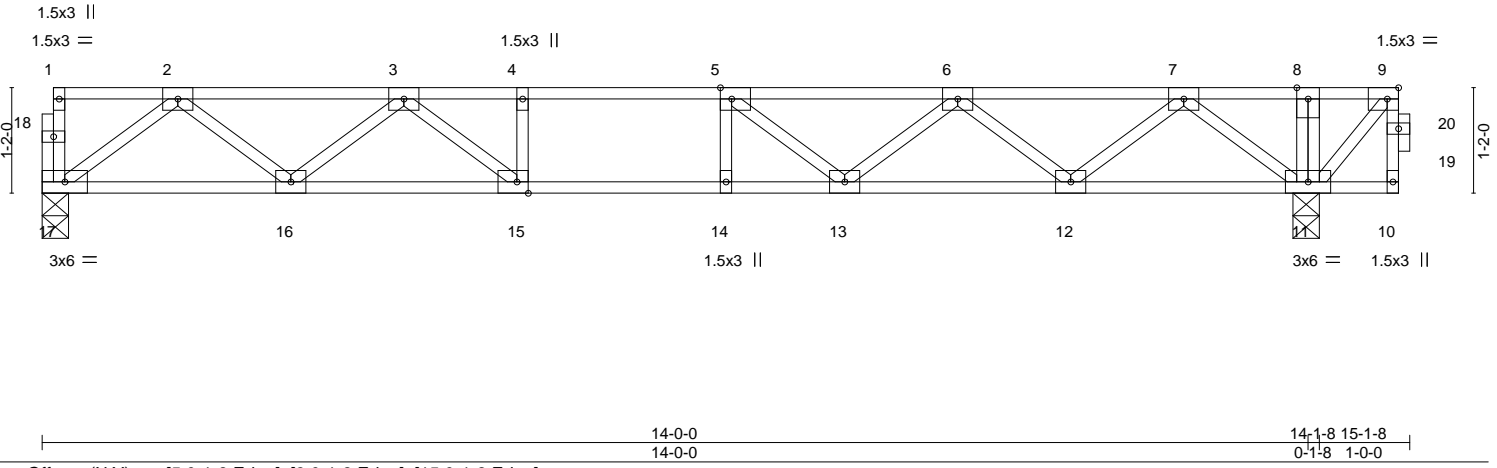

LOADING (psf)	SPACING-	2-0-0	CSI.	DEFL.	in (loc)	l/defl	L/d	PLATES	GRIP
TCLL 40.0	Plate Grip DOL	1.00	TC 0.50	Vert(LL)	-0.14 13-14	>999	480	MT20	244/190
TCDL 10.0	Lumber DOL	1.00	BC 0.74	Vert(CT)	-0.18 13-14	>919	360		
BCLL 0.0	Rep Stress Incr	NO	WB 0.40	Horz(CT)	0.03 11	n/a	n/a		
BCDL 5.0	Code IRC2015/TPI2014		Matrix-S						
								Weight: 77 lb	FT = 20%F, 11%E

<b>LUMBER-</b>	<b>BRACING-</b>
TOP CHORD 2x4 SP No.1(flat)	TOP CHORD Structural wood sheathing directly applied or 6-0-0 oc purlins, except end verticals.
BOT CHORD 2x4 SP No.1(flat)	BOT CHORD Rigid ceiling directly applied or 10-0-0 oc bracing, Except: 6-0-0 oc bracing: 11-12.
WEBS 2x4 SP No.3(flat)	
<b>REACTIONS.</b> (size) 17=0-3-8, 11=0-3-8 Max Grav 17=721(LC 3), 11=1405(LC 1)	

<b>FORCES.</b> (lb) - Max. Comp./Max. Ten. - All forces 250 (lb) or less except when shown.
TOP CHORD 2-3=-1426/0, 3-4=-2264/0, 4-5=-2264/0, 5-6=-2030/0, 6-7=-1140/0, 7-8=0/484, 8-9=0/484
BOT CHORD 16-17=0/892, 15-16=0/1941, 14-15=0/2264, 13-14=0/2264, 12-13=0/1751, 11-12=-203/506
WEBS 2-17=-1117/0, 2-16=0/695, 3-16=-670/0, 3-15=0/595, 7-11=-1196/0, 7-12=0/830, 6-12=-800/0, 6-13=0/451, 5-13=-521/0, 4-15=-256/0, 9-11=-718/0

- NOTES-**
- 1) Unbalanced floor live loads have been considered for this design.
  - 2) All plates are 3x4 MT20 unless otherwise indicated.
  - 3) Plates checked for a plus or minus 1 degree rotation about its center.
  - 4) Magnitude of user added load(s) on this truss have been applied uniformly across all gravity load cases with no adjustments.
  - 5) Recommend 2x6 strongbacks, on edge, spaced at 10-0-0 oc and fastened to each truss with 3-10d (0.131" X 3") nails. Strongbacks to be attached to walls at their outer ends or restrained by other means.
  - 6) CAUTION, Do not erect truss backwards.

<b>LOAD CASE(S)</b> Standard
1) Dead + Floor Live (balanced): Lumber Increase=1.00, Plate Increase=1.00
Uniform Loads (plf)
Vert: 10-17=-10, 1-9=-100
Concentrated Loads (lb)
Vert: 9=500



March 6, 2024

<p><b>WARNING - Verify design parameters and READ NOTES ON THIS AND INCLUDED MITEK REFERENCE PAGE MII-7473 rev. 1/2/2023 BEFORE USE.</b></p> <p>Design valid for use only with MiTek® connectors. This design is based only upon parameters shown, and is for an individual building component, not a truss system. Before use, the building designer must verify the applicability of design parameters and properly incorporate this design into the overall building design. Bracing indicated is to prevent buckling of individual truss web and/or chord members only. Additional temporary and permanent bracing is always required for stability and to prevent collapse with possible personal injury and property damage. For general guidance regarding the fabrication, storage, delivery, erection and bracing of trusses and truss systems, see <b>ANSI/TPH Quality Criteria and DSB-22</b> available from Truss Plate Institute (<a href="http://www.tpinst.org">www.tpinst.org</a>) and <b>BCSI Building Component Safety Information</b> available from the Structural Building Component Association (<a href="http://www.sbcacomponents.com">www.sbcacomponents.com</a>)</p>	<p>ENGINEERING BY</p> <p><b>TRENCO</b></p> <p>A MiTek Affiliate</p> <p>818 Soundside Road Edenton, NC 27932</p>
--	---



Job J0724-4217	Truss F08	Truss Type Floor	Qty 2	Ply 1	Lot 140 Duncans Creek Job Reference (optional)	164045953
-------------------	--------------	---------------------	----------	----------	---	-----------

Comtech, Inc. Fayetteville, NC - 28314,

8.430 s Jan 6 2022 MiTek Industries, Inc. Tue Mar 5 12:22:23 2024 Page 1

ID:JQb1igK2ne3CQdqy3dwnCxyStrD-RfC?PsB70Hq3NSgPqnL8w3ulTXbGKWRCDoi7J4zJC?f



Scale = 1:24.6

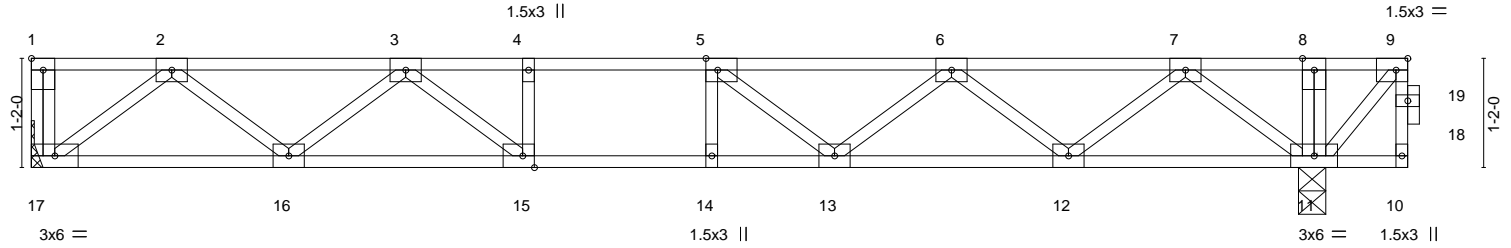

Plate Offsets (X, Y)--	[1:Edge,0-1-8], [5:0-1-8,Edge], [9:0-1-8,Edge], [15:0-1-8,Edge]
------------------------	---

LOADING (psf)	SPACING-	2-0-0	CSI.	DEFL.	in (loc)	l/defl	L/d	PLATES	GRIP
TCLL 40.0	Plate Grip DOL	1.00	TC 0.42	Vert(LL)	-0.12	13-14	>999	MT20	244/190
TCDL 10.0	Lumber DOL	1.00	BC 0.68	Vert(CT)	-0.15	13-14	>999		
BCLL 0.0	Rep Stress Incr	NO	WB 0.38	Horz(CT)	0.03	11	n/a		
BCDL 5.0	Code IRC2015/TPI2014		Matrix-S						
								Weight: 76 lb	FT = 20%F, 11%E

<b>LUMBER-</b>	<b>BRACING-</b>
TOP CHORD 2x4 SP No.1(flat)	TOP CHORD Structural wood sheathing directly applied or 6-0-0 oc purlins, except end verticals.
BOT CHORD 2x4 SP No.1(flat)	BOT CHORD Rigid ceiling directly applied or 10-0-0 oc bracing, Except: 6-0-0 oc bracing: 11-12.
WEBS 2x4 SP No.3(flat)	

**REACTIONS.** (size) 17=Mechanical, 11=0-3-8  
Max Grav 17=710(LC 3), 11=1390(LC 1)

**FORCES.** (lb) - Max. Comp./Max. Ten. - All forces 250 (lb) or less except when shown.  
TOP CHORD 2-3=-1385/0, 3-4=-2168/0, 4-5=-2168/0, 5-6=-1955/0, 6-7=-1102/0, 7-8=0/484, 8-9=0/484  
BOT CHORD 16-17=0/870, 15-16=0/1880, 14-15=0/2168, 13-14=0/2168, 12-13=0/1696, 11-12=-208/485  
WEBS 2-17=-1092/0, 2-16=0/670, 3-16=-644/0, 3-15=0/542, 7-11=-1171/0, 7-12=0/807, 6-12=-777/0, 6-13=0/423, 5-13=-482/0, 9-11=-718/0

- NOTES-**
- 1) Unbalanced floor live loads have been considered for this design.
  - 2) All plates are 3x4 MT20 unless otherwise indicated.
  - 3) Plates checked for a plus or minus 1 degree rotation about its center.
  - 4) Refer to girder(s) for truss to truss connections.
  - 5) Magnitude of user added load(s) on this truss have been applied uniformly across all gravity load cases with no adjustments.
  - 6) Recommend 2x6 strongbacks, on edge, spaced at 10-0-0 oc and fastened to each truss with 3-10d (0.131" X 3") nails. Strongbacks to be attached to walls at their outer ends or restrained by other means.
  - 7) CAUTION, Do not erect truss backwards.

**LOAD CASE(S)** Standard  
1) Dead + Floor Live (balanced): Lumber Increase=1.00, Plate Increase=1.00  
Uniform Loads (plf)  
Vert: 10-17=-10, 1-9=-100  
Concentrated Loads (lb)  
Vert: 9=500

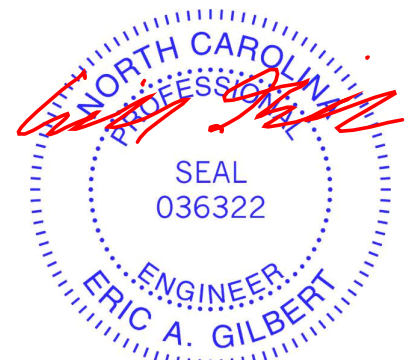

March 6, 2024

<p><b>WARNING - Verify design parameters and READ NOTES ON THIS AND INCLUDED MITEK REFERENCE PAGE MII-7473 rev. 1/2/2023 BEFORE USE.</b></p> <p>Design valid for use only with MiTek® connectors. This design is based only upon parameters shown, and is for an individual building component, not a truss system. Before use, the building designer must verify the applicability of design parameters and properly incorporate this design into the overall building design. Bracing indicated is to prevent buckling of individual truss web and/or chord members only. Additional temporary and permanent bracing is always required for stability and to prevent collapse with possible personal injury and property damage. For general guidance regarding the fabrication, storage, delivery, erection and bracing of trusses and truss systems, see <b>ANSI/TPH Quality Criteria and DSB-22</b> available from Truss Plate Institute (www.tpinst.org) and <b>BCSI Building Component Safety Information</b> available from the Structural Building Component Association (www.sbcacomponents.com)</p>	<p>ENGINEERING BY <b>TRENCO</b> A MITEK Affiliate</p> <p>818 Soundside Road Edenton, NC 27932</p>
--	---

Job	Truss	Truss Type	Qty	Ply	Lot 140 Duncans Creek	I64045954
J0724-4217	F09	Floor	3	1	Job Reference (optional)	

Comtech, Inc. Fayetteville, NC - 28314,

8.430 s Jan 6 2022 MiTek Industries, Inc. Tue Mar 5 12:22:24 2024 Page 1  
 ID:JQb1igK2ne3CQdqy3dwnCxyStrD-RfC?PsB70Hq3NSgPqnL8w3ulTXbGKWrCDoi7J4zJC?f

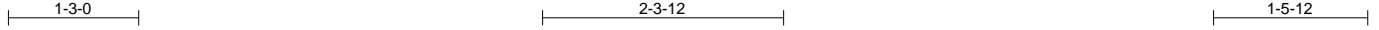

Scale = 1:22.1

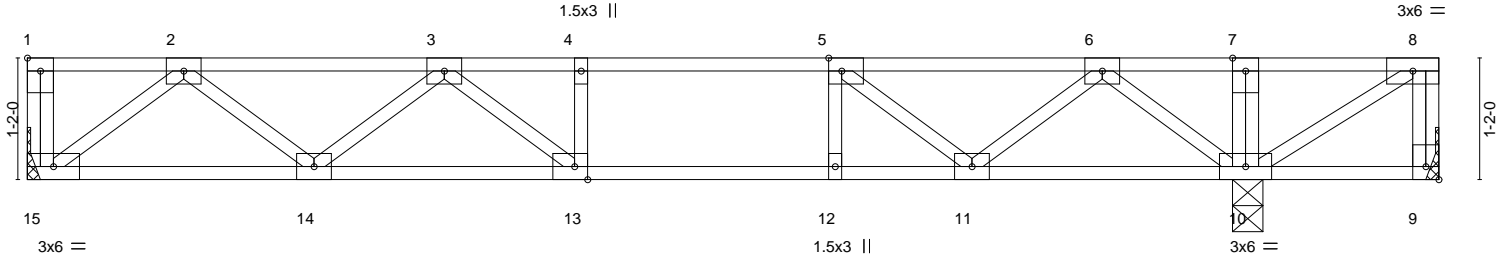

	11-8-4	11-8-4	11-8-8	13-6-8
Plate Offsets (X,Y)--	[1:Edge,0-1-8], [5:0-1-8,Edge], [9:Edge,0-1-8], [13:0-1-8,Edge]		0-0-4	1-10-0

<b>LOADING</b> (psf)	<b>SPACING-</b>	2-0-0	<b>CSI.</b>	<b>DEFL.</b>	in (loc)	l/defl	L/d	<b>PLATES</b>	<b>GRIP</b>
TCLL 40.0	Plate Grip DOL	1.00	TC 0.48	Vert(LL)	-0.12	13-14	>999	MT20	244/190
TCDL 10.0	Lumber DOL	1.00	BC 0.62	Vert(CT)	-0.16	13-14	>886		
BCLL 0.0	Rep Stress Incr	YES	WB 0.31	Horz(CT)	0.02	9	n/a		
BCDL 5.0	Code IRC2015/TPI2014		Matrix-S						
								Weight: 70 lb	FT = 20%F, 11%E

<b>LUMBER-</b>	<b>BRACING-</b>
TOP CHORD 2x4 SP No.1(flat)	TOP CHORD Structural wood sheathing directly applied or 6-0-0 oc purlins, except end verticals.
BOT CHORD 2x4 SP No.1(flat)	BOT CHORD Rigid ceiling directly applied or 10-0-0 oc bracing.
WEBS 2x4 SP No.3(flat)	

**REACTIONS.** (size) 9=Mechanical, 15=Mechanical, 10=0-3-8  
 Max Uplift 9=282(LC 8)  
 Max Grav 9=138(LC 7), 15=604(LC 3), 10=1070(LC 8)

**FORCES.** (lb) - Max. Comp./Max. Ten. - All forces 250 (lb) or less except when shown.  
 TOP CHORD 8-9=-135/283, 2-3=-1138/0, 3-4=-1507/0, 4-5=-1507/0, 5-6=-934/0, 6-7=-110/581, 7-8=-109/582  
 BOT CHORD 14-15=0/735, 13-14=0/1474, 12-13=0/1507, 11-12=0/1507, 10-11=0/497  
 WEBS 2-15=-922/0, 2-14=0/525, 3-14=-437/0, 6-10=-966/0, 6-11=0/650, 5-11=-735/0, 8-10=-680/127

- NOTES-**
- Unbalanced floor live loads have been considered for this design.
  - All plates are 3x4 MT20 unless otherwise indicated.
  - Plates checked for a plus or minus 1 degree rotation about its center.
  - Refer to girder(s) for truss to truss connections.
  - Provide mechanical connection (by others) of truss to bearing plate capable of withstanding 100 lb uplift at joint(s) except (jt=lb) 9=282.
  - Recommend 2x6 strongbacks, on edge, spaced at 10-0-0 oc and fastened to each truss with 3-10d (0.131" X 3") nails. Strongbacks to be attached to walls at their outer ends or restrained by other means.
  - CAUTION, Do not erect truss backwards.



March 6, 2024

Job	Truss	Truss Type	Qty	Ply	Lot 140 Duncans Creek	I64045955
J0724-4217	F10	FLOOR	5	1	Job Reference (optional)	

Comtech, Inc. Fayetteville, NC - 28314,

8.430 s Jan 6 2022 MiTek Industries, Inc. Tue Mar 5 12:22:25 2024 Page 1

ID:JQb1igK2ne3CQdqy3dwnCxyStrD-RfC?PsB70Hq3NSgPqnL8w3ulTXbGKWrcD0i7J4zJC?f

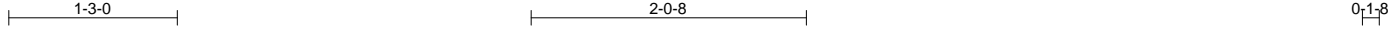

Scale = 1:17.1

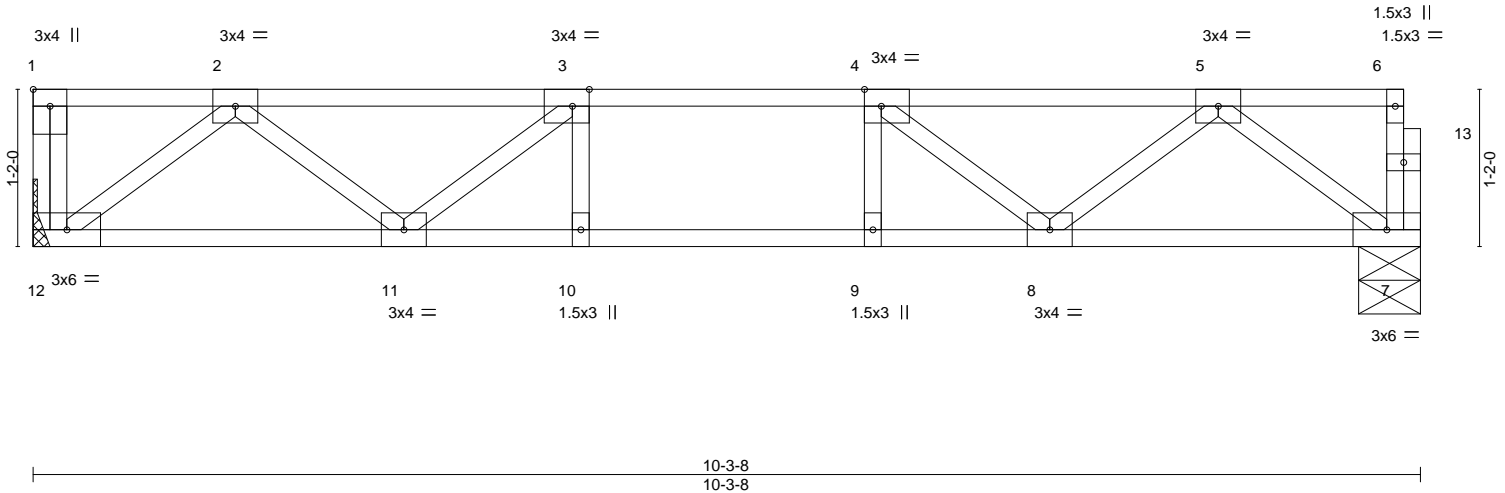

Plate Offsets (X,Y)--	[1:Edge,0-1-8], [3:0-1-8,Edge], [4:0-1-8,Edge]				
<b>LOADING</b> (psf)	<b>SPACING-</b> 1-7-3	<b>CSI.</b>	<b>DEFL.</b> in (loc) l/defl L/d	<b>PLATES</b>	<b>GRIP</b>
TCLL 40.0	Plate Grip DOL 1.00	TC 0.19	Vert(LL) -0.05 9 >999 480	MT20	244/190
TCDL 10.0	Lumber DOL 1.00	BC 0.33	Vert(CT) -0.06 9 >999 360		
BCLL 0.0	Rep Stress Incr YES	WB 0.16	Horz(CT) 0.01 7 n/a n/a		
BCDL 5.0	Code IRC2015/TPI2014	Matrix-S		Weight: 52 lb	FT = 20%F, 11%E

<b>LUMBER-</b>	<b>BRACING-</b>
TOP CHORD 2x4 SP No.1(flat)	TOP CHORD Structural wood sheathing directly applied or 6-0-0 oc purlins, except end verticals.
BOT CHORD 2x4 SP No.1(flat)	BOT CHORD Rigid ceiling directly applied or 10-0-0 oc bracing.
WEBS 2x4 SP No.3(flat)	

**REACTIONS.** (size) 12=Mechanical, 7=0-5-8  
Max Grav 12=442(LC 1), 7=437(LC 1)

**FORCES.** (lb) - Max. Comp./Max. Ten. - All forces 250 (lb) or less except when shown.  
TOP CHORD 2-3=-795/0, 3-4=-1047/0, 4-5=-794/0  
BOT CHORD 11-12=0/531, 10-11=0/1047, 9-10=0/1047, 8-9=0/1047, 7-8=0/530  
WEBS 2-12=-666/0, 2-11=0/343, 3-11=-355/0, 5-7=-663/0, 5-8=0/344, 4-8=-355/0

- NOTES-**
- 1) Unbalanced floor live loads have been considered for this design.
  - 2) Plates checked for a plus or minus 1 degree rotation about its center.
  - 3) Refer to girder(s) for truss to truss connections.
  - 4) Recommend 2x6 strongbacks, on edge, spaced at 10-0-0 oc and fastened to each truss with 3-10d (0.131" X 3") nails. Strongbacks to be attached to walls at their outer ends or restrained by other means.
  - 5) CAUTION, Do not erect truss backwards.



March 6, 2024

<p><b>WARNING - Verify design parameters and READ NOTES ON THIS AND INCLUDED MITEK REFERENCE PAGE MII-7473 rev. 1/2/2023 BEFORE USE.</b></p> <p>Design valid for use only with MiTek® connectors. This design is based only upon parameters shown, and is for an individual building component, not a truss system. Before use, the building designer must verify the applicability of design parameters and properly incorporate this design into the overall building design. Bracing indicated is to prevent buckling of individual truss web and/or chord members only. Additional temporary and permanent bracing is always required for stability and to prevent collapse with possible personal injury and property damage. For general guidance regarding the fabrication, storage, delivery, erection and bracing of trusses and truss systems, see <b>ANSI/TPH Quality Criteria and DSB-22</b> available from Truss Plate Institute (www.tpinst.org) and <b>BCSI Building Component Safety Information</b> available from the Structural Building Component Association (www.sbcacomponents.com)</p>	<p>818 Soundside Road Edenton, NC 27932</p>
--	---

Job J0724-4217	Truss F11	Truss Type Floor	Qty 5	Ply 1	Lot 140 Duncans Creek 164045956
-------------------	--------------	---------------------	----------	----------	------------------------------------

Comtech, Inc. Fayetteville, NC - 28314,

8.430 s Jan 6 2022 MiTek Industries, Inc. Tue Mar 5 12:22:26 2024 Page 1  
ID:JQb1igK2ne3CQdqy3dwnCxyStrD-RfC?PsB70Hq3NSgPqnL8w3ulTXbGKWrCDoi7J4zJC?f



Scale = 1:18.7

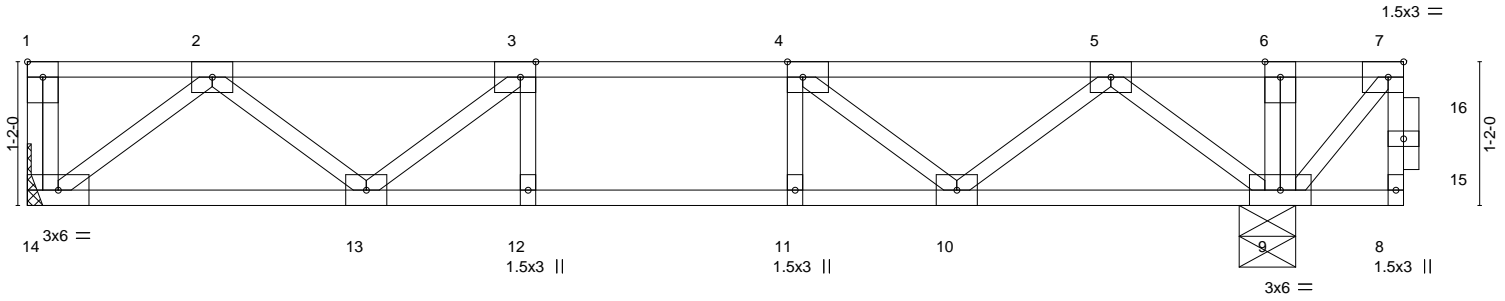

Plate Offsets (X,Y)--	[1:Edge,0-1-8], [3:0-1-8,Edge], [4:0-1-8,Edge], [7:0-1-8,Edge]
-----------------------	--

<b>LOADING</b> (psf)	<b>SPACING-</b> 2-0-0	<b>CSI.</b>	<b>DEFL.</b> in (loc) l/defl L/d	<b>PLATES</b>	<b>GRIP</b>
TCLL 40.0	Plate Grip DOL 1.00	TC 0.43	Vert(LL) -0.07 12-13 >999 480	MT20	244/190
TCDL 10.0	Lumber DOL 1.00	BC 0.58	Vert(CT) -0.09 12-13 >999 360		
BCLL 0.0	Rep Stress Incr NO	WB 0.25	Horz(CT) 0.01 9 n/a n/a		
BCDL 5.0	Code IRC2015/TPI2014	Matrix-S		Weight: 59 lb	FT = 20%F, 11%E

<b>LUMBER-</b>	<b>BRACING-</b>
TOP CHORD 2x4 SP No.1(flat)	TOP CHORD Structural wood sheathing directly applied or 6-0-0 oc purlins, except end verticals.
BOT CHORD 2x4 SP No.1(flat)	BOT CHORD Rigid ceiling directly applied or 10-0-0 oc bracing, Except: 6-0-0 oc bracing: 9-10.
WEBS 2x4 SP No.3(flat)	
<b>REACTIONS.</b> (size) 14=Mechanical, 9=0-5-8 Max Grav 14=503(LC 3), 9=1208(LC 1)	

**FORCES.** (lb) - Max. Comp./Max. Ten. - All forces 250 (lb) or less except when shown.

TOP CHORD	2-3=-868/0, 3-4=-1073/0, 4-5=-641/96, 5-6=0/480, 6-7=0/479
BOT CHORD	13-14=0/608, 12-13=0/1073, 11-12=0/1073, 10-11=0/1073, 9-10=-269/247
WEBS	2-14=-763/0, 2-13=0/338, 3-13=-302/50, 5-9=-872/0, 5-10=0/520, 4-10=-603/0, 7-9=-711/0

- NOTES-**
- 1) Unbalanced floor live loads have been considered for this design.
  - 2) All plates are 3x4 MT20 unless otherwise indicated.
  - 3) Plates checked for a plus or minus 1 degree rotation about its center.
  - 4) Refer to girder(s) for truss to truss connections.
  - 5) Magnitude of user added load(s) on this truss have been applied uniformly across all gravity load cases with no adjustments.
  - 6) Recommend 2x6 strongbacks, on edge, spaced at 10-0-0 oc and fastened to each truss with 3-10d (0.131" X 3") nails. Strongbacks to be attached to walls at their outer ends or restrained by other means.
  - 7) CAUTION, Do not erect truss backwards.

**LOAD CASE(S)** Standard

- 1) Dead + Floor Live (balanced): Lumber Increase=1.00, Plate Increase=1.00

Uniform Loads (plf)  
Vert: 8-14=-10, 1-7=-100

Concentrated Loads (lb)  
Vert: 7=-500



Job	Truss	Truss Type	Qty	Ply	Lot 140 Duncans Creek	164045957
J0724-4217	FKW1	Floor Supported Gable	1	1	Job Reference (optional)	

Comtech, Inc. Fayetteville, NC - 28314,

8.430 s Jan 6 2022 MiTek Industries, Inc. Tue Mar 5 12:22:27 2024 Page 1  
 ID:JQb1igK2ne3CQdqy3dwnCxyStrD-RfC?PsB70Hq3NSgPqnL8w3ulTXbGKWrCDoi7J4zJC?f

0-1/8

0-1/8

Scale = 1:27.6

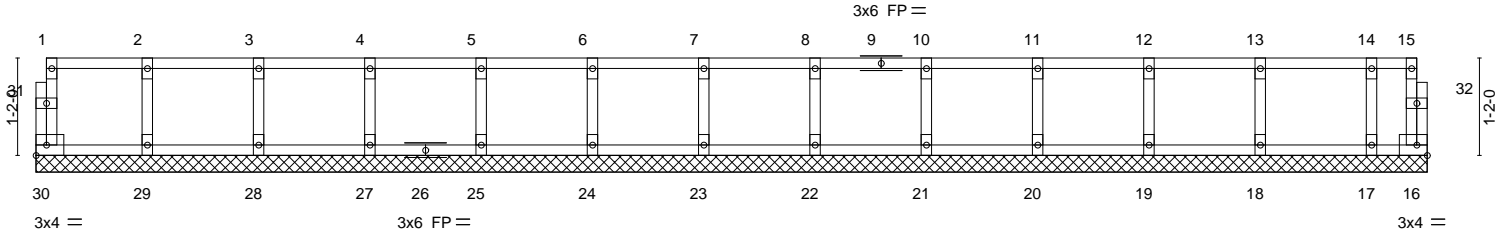

16-8-0  
16-8-0

LOADING (psf)	SPACING-	2-0-0	CSI.	DEFL.	in (loc)	l/defl	L/d	PLATES	GRIP	
TCLL 40.0	Plate Grip DOL	1.00	TC 0.06	Vert(LL)	n/a	-	n/a	999	MT20	244/190
TCDL 10.0	Lumber DOL	1.00	BC 0.01	Vert(CT)	n/a	-	n/a	999		
BCLL 0.0	Rep Stress Incr	YES	WB 0.03	Horz(CT)	0.00	16	n/a	n/a		
BCDL 5.0	Code IRC2015/TPI2014		Matrix-R							
									Weight: 70 lb	FT = 20%F, 11%E

**LUMBER-**  
 TOP CHORD 2x4 SP No.1(flat)  
 BOT CHORD 2x4 SP No.1(flat)  
 WEBS 2x4 SP No.3(flat)  
 OTHERS 2x4 SP No.3(flat)

**BRACING-**  
 TOP CHORD Structural wood sheathing directly applied or 6-0-0 oc purlins, except end verticals.  
 BOT CHORD Rigid ceiling directly applied or 10-0-0 oc bracing.

**REACTIONS.** All bearings 16-8-0.  
 (lb) - Max Grav All reactions 250 lb or less at joint(s) 30, 16, 29, 28, 27, 25, 24, 23, 22, 21, 20, 19, 18, 17

**FORCES.** (lb) - Max. Comp./Max. Ten. - All forces 250 (lb) or less except when shown.

- NOTES-**
- 1) All plates are 1.5x3 MT20 unless otherwise indicated.
  - 2) Plates checked for a plus or minus 1 degree rotation about its center.
  - 3) Gable requires continuous bottom chord bearing.
  - 4) Truss to be fully sheathed from one face or securely braced against lateral movement (i.e. diagonal web).
  - 5) Gable studs spaced at 1-4-0 oc.
  - 6) Recommend 2x6 strongbacks, on edge, spaced at 10-0-0 oc and fastened to each truss with 3-10d (0.131" X 3") nails. Strongbacks to be attached to walls at their outer ends or restrained by other means.



March 6, 2024

**WARNING - Verify design parameters and READ NOTES ON THIS AND INCLUDED MITEK REFERENCE PAGE MII-7473 rev. 1/2/2023 BEFORE USE.**  
 Design valid for use only with MiTek® connectors. This design is based only upon parameters shown, and is for an individual building component, not a truss system. Before use, the building designer must verify the applicability of design parameters and properly incorporate this design into the overall building design. Bracing indicated is to prevent buckling of individual truss web and/or chord members only. Additional temporary and permanent bracing is always required for stability and to prevent collapse with possible personal injury and property damage. For general guidance regarding the fabrication, storage, delivery, erection and bracing of trusses and truss systems, see **ANSI/TP1 Quality Criteria and DSB-22** available from Truss Plate Institute (www.tpinst.org) and **BCSI Building Component Safety Information** available from the Structural Building Component Association (www.sbcacomponents.com)



818 Soundside Road  
 Edenton, NC 27932

Job	Truss	Truss Type	Qty	Ply	Lot 140 Duncans Creek	I64045958
J0724-4217	FKW2	Floor Supported Gable	1	1	Job Reference (optional)	

Comtech, Inc. Fayetteville, NC - 28314,

8.430 s Jan 6 2022 MiTek Industries, Inc. Tue Mar 5 12:22:28 2024 Page 1  
 ID:JQb1igK2ne3CQdqy3dwnCxyStrD-RfC?PsB70Hq3NSgPqnL8w3ulTXbGKWrCDoi7J4zJC?f

0-1-8

0-1-8

Scale = 1:45.4

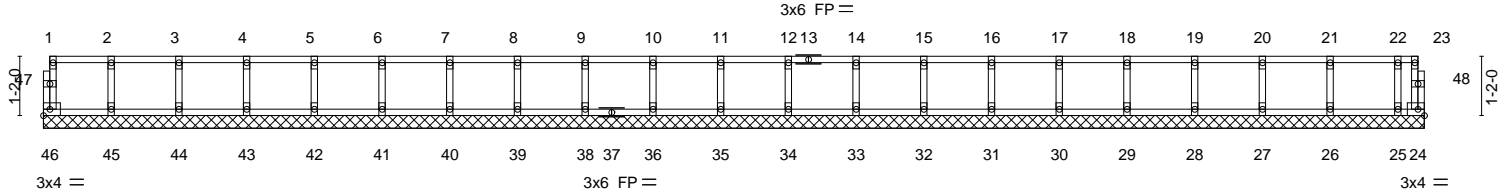

27-2-4  
27-2-4

LOADING (psf)	SPACING-	CSI.	DEFL.	in (loc)	l/defl	L/d	PLATES	GRIP
TCLL 40.0	2-0-0 Plate Grip DOL 1.00	TC 0.06	Vert(LL)	n/a	-	n/a	MT20	244/190
TCDL 10.0	Lumber DOL 1.00	BC 0.01	Vert(CT)	n/a	-	n/a		
BCLL 0.0	Rep Stress Incr YES	WB 0.03	Horz(CT)	0.00	24	n/a		
BCDL 5.0	Code IRC2015/TPI2014	Matrix-R						
							Weight: 113 lb	FT = 20%F, 11%E

**LUMBER-**  
 TOP CHORD 2x4 SP No.1(flat)  
 BOT CHORD 2x4 SP No.1(flat)  
 WEBS 2x4 SP No.3(flat)  
 OTHERS 2x4 SP No.3(flat)

**BRACING-**  
 TOP CHORD Structural wood sheathing directly applied or 6-0-0 oc purlins, except end verticals.  
 BOT CHORD Rigid ceiling directly applied or 10-0-0 oc bracing.

**REACTIONS.** All bearings 27-2-4.  
 (lb) - Max Grav All reactions 250 lb or less at joint(s) 46, 24, 45, 44, 43, 42, 41, 40, 39, 38, 36, 35, 34, 33, 32, 31, 30, 29, 28, 27, 26, 25

**FORCES.** (lb) - Max. Comp./Max. Ten. - All forces 250 (lb) or less except when shown.

**NOTES-**

- All plates are 1.5x3 MT20 unless otherwise indicated.
- Plates checked for a plus or minus 1 degree rotation about its center.
- Gable requires continuous bottom chord bearing.
- Truss to be fully sheathed from one face or securely braced against lateral movement (i.e. diagonal web).
- Gable studs spaced at 1-4-0 oc.
- Recommend 2x6 strongbacks, on edge, spaced at 10-0-0 oc and fastened to each truss with 3-10d (0.131" X 3") nails. Strongbacks to be attached to walls at their outer ends or restrained by other means.



March 6, 2024

**WARNING - Verify design parameters and READ NOTES ON THIS AND INCLUDED MITEK REFERENCE PAGE MII-7473 rev. 1/2/2023 BEFORE USE.**  
 Design valid for use only with MiTek® connectors. This design is based only upon parameters shown, and is for an individual building component, not a truss system. Before use, the building designer must verify the applicability of design parameters and properly incorporate this design into the overall building design. Bracing indicated is to prevent buckling of individual truss web and/or chord members only. Additional temporary and permanent bracing is always required for stability and to prevent collapse with possible personal injury and property damage. For general guidance regarding the fabrication, storage, delivery, erection and bracing of trusses and truss systems, see **ANSI/TPH Quality Criteria and DSB-22** available from Truss Plate Institute (www.tpinst.org) and **BCSI Building Component Safety Information** available from the Structural Building Component Association (www.sbcacomponents.com)



818 Soundside Road  
 Edenton, NC 27932



Job	Truss	Truss Type	Qty	Ply	Lot 140 Duncans Creek	I64045959
J0724-4217	FKW3	Floor Supported Gable	1	1		
						Job Reference (optional)

Comtech, Inc. Fayetteville, NC - 28314,

8.430 s Jan 6 2022 MiTek Industries, Inc. Tue Mar 5 12:22:29 2024 Page 1

ID:JQb1igK2ne3CQdqy3dwnCxyStrD-RfC?PsB70Hq3NSgPqnL8w3ulTXbGKWrCDoi7J4zJC?f

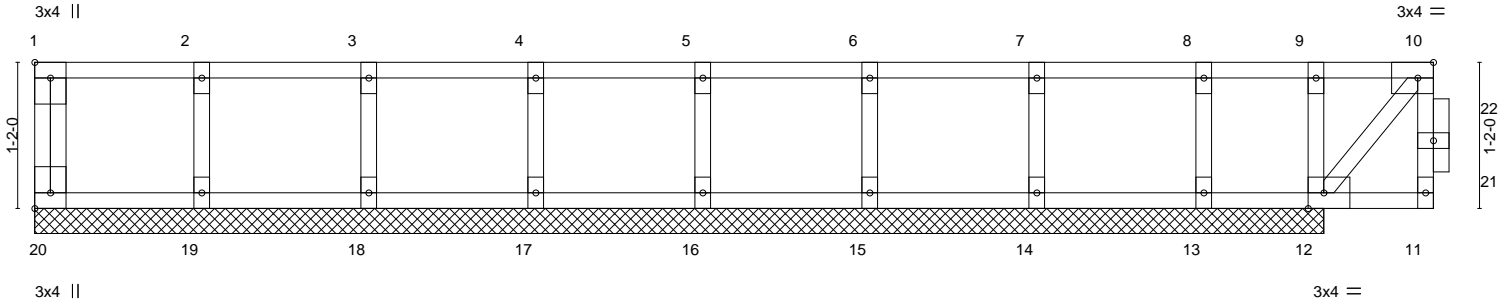

Plate Offsets (X, Y)--	[1:Edge,0-1-8], [10:0-1-8,Edge], [12:0-1-8,Edge], [20:Edge,0-1-8]
------------------------	---

LOADING (psf)	SPACING-	2-0-0	CSI.	DEFL.	in (loc)	l/defl	L/d	PLATES	GRIP
TCLL 40.0	Plate Grip DOL	1.00	TC 0.34	Vert(LL)	n/a	-	n/a	MT20	244/190
TCDL 10.0	Lumber DOL	1.00	BC 0.29	Vert(CT)	n/a	-	n/a		
BCLL 0.0	Rep Stress Incr	NO	WB 0.07	Horz(CT)	-0.00	12	n/a		
BCDL 5.0	Code IRC2015/TPI2014		Matrix-S						
								Weight: 51 lb	FT = 20%F, 11%E

LUMBER-	BRACING-
TOP CHORD 2x4 SP No.1(flat)	TOP CHORD Structural wood sheathing directly applied or 10-0-0 oc purlins, except end verticals.
BOT CHORD 2x4 SP No.1(flat)	BOT CHORD Rigid ceiling directly applied or 10-0-0 oc bracing.
WEBS 2x4 SP No.3(flat)	
OTHERS 2x4 SP No.3(flat)	

**REACTIONS.** All bearings 10-3-8.  
 (lb) - Max Uplift All uplift 100 lb or less at joint(s) except 13=-171(LC 4)  
 Max Grav All reactions 250 lb or less at joint(s) 20, 19, 18, 17, 16, 15, 14 except 12=483(LC 1)

**FORCES.** (lb) - Max. Comp./Max. Ten. - All forces 250 (lb) or less except when shown.  
 WEBS 9-12=-321/0

- NOTES-**
- 1) Unbalanced floor live loads have been considered for this design.
  - 2) All plates are 1.5x3 MT20 unless otherwise indicated.
  - 3) Plates checked for a plus or minus 1 degree rotation about its center.
  - 4) Truss to be fully sheathed from one face or securely braced against lateral movement (i.e. diagonal web).
  - 5) Gable studs spaced at 1-4-0 oc.
  - 6) Provide mechanical connection (by others) of truss to bearing plate capable of withstanding 171 lb uplift at joint 13.
  - 7) Non Standard bearing condition. Review required.
  - 8) Magnitude of user added load(s) on this truss have been applied uniformly across all gravity load cases with no adjustments.
  - 9) Recommend 2x6 strongbacks, on edge, spaced at 10-0-0 oc and fastened to each truss with 3-10d (0.131" X 3") nails. Strongbacks to be attached to walls at their outer ends or restrained by other means.
  - 10) CAUTION, Do not erect truss backwards.

**LOAD CASE(S)** Standard

- 1) Dead + Floor Live (balanced): Lumber Increase=1.00, Plate Increase=1.00

Uniform Loads (plf)  
 Vert: 11-20=-10, 1-9=-100, 9-10=-250

Concentrated Loads (lb)  
 Vert: 10=-40

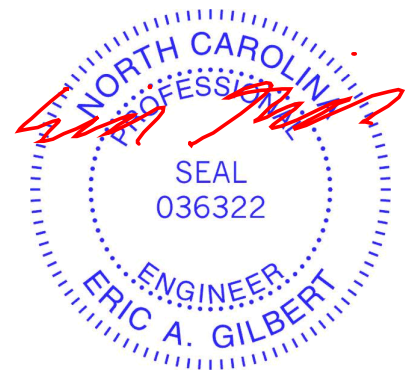

March 6, 2024

Job J0724-4217	Truss FKW4	Truss Type Floor Supported Gable	Qty 1	Ply 1	Lot 140 Duncans Creek Job Reference (optional)	I64045960
-------------------	---------------	-------------------------------------	----------	----------	---	-----------

Comtech, Inc. Fayetteville, NC - 28314,

8.430 s Jan 6 2022 MiTek Industries, Inc. Tue Mar 5 12:22:30 2024 Page 1  
ID:JQb1igK2ne3CQdqy3dwnCxyStrD-RfC?PsB70Hq3NSgPqnL8w3ulTXbGKWrCDoi7J4zJC?f

0.1-8

Scale = 1:18.2

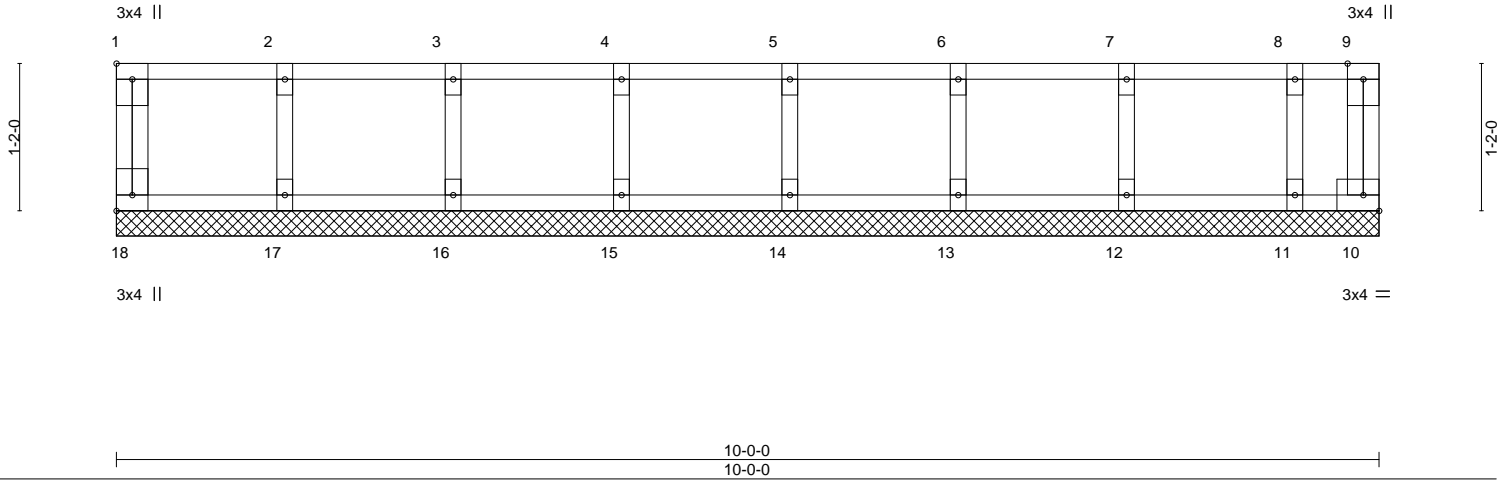

Plate Offsets (X,Y)--		[1:Edge,0-1-8], [18:Edge,0-1-8]							
<b>LOADING</b> (psf)	<b>SPACING-</b>	2-0-0	<b>CSI.</b>	<b>DEFL.</b>	in (loc)	l/defl	L/d	<b>PLATES</b>	<b>GRIP</b>
TCLL 40.0	Plate Grip DOL	1.00	TC 0.06	Vert(LL)	n/a	-	n/a	MT20	244/190
TCDL 10.0	Lumber DOL	1.00	BC 0.01	Vert(CT)	n/a	-	n/a		
BCLL 0.0	Rep Stress Incr	YES	WB 0.03	Horz(CT)	0.00	10	n/a		
BCDL 5.0	Code IRC2015/TPI2014		Matrix-R						
								Weight: 45 lb	FT = 20%F, 11%E

<b>LUMBER-</b>		<b>BRACING-</b>	
TOP CHORD	2x4 SP No.1(flat)	TOP CHORD	Structural wood sheathing directly applied or 6-0-0 oc purlins, except end verticals.
BOT CHORD	2x4 SP No.1(flat)	BOT CHORD	Rigid ceiling directly applied or 10-0-0 oc bracing.
WEBS	2x4 SP No.3(flat)		
OTHERS	2x4 SP No.3(flat)		

**REACTIONS.** All bearings 10-0-0.  
(lb) - Max Grav All reactions 250 lb or less at joint(s) 18, 10, 17, 16, 15, 14, 13, 12, 11

**FORCES.** (lb) - Max. Comp./Max. Ten. - All forces 250 (lb) or less except when shown.

- NOTES-**
- All plates are 1.5x3 MT20 unless otherwise indicated.
  - Plates checked for a plus or minus 1 degree rotation about its center.
  - Gable requires continuous bottom chord bearing.
  - Truss to be fully sheathed from one face or securely braced against lateral movement (i.e. diagonal web).
  - Gable studs spaced at 1-4-0 oc.
  - Recommend 2x6 strongbacks, on edge, spaced at 10-0-0 oc and fastened to each truss with 3-10d (0.131" X 3") nails. Strongbacks to be attached to walls at their outer ends or restrained by other means.
  - CAUTION, Do not erect truss backwards.



March 6, 2024

Job J0724-4217	Truss FKW5	Truss Type Floor Supported Gable	Qty 1	Ply 1	Lot 140 Duncans Creek Job Reference (optional)	164045961
-------------------	---------------	-------------------------------------	----------	----------	---	-----------

Comtech, Inc. Fayetteville, NC - 28314,

8.430 s Jan 6 2022 MiTek Industries, Inc. Tue Mar 5 12:22:31 2024 Page 1  
ID:JQb1igK2ne3CQdqy3dwnCxyStrD-RfC?PsB70Hq3NSgPqnL8w3ulTXbGKWrCDoi7J4zJC?f

0-1/8

0-1/8

Scale = 1:24.9

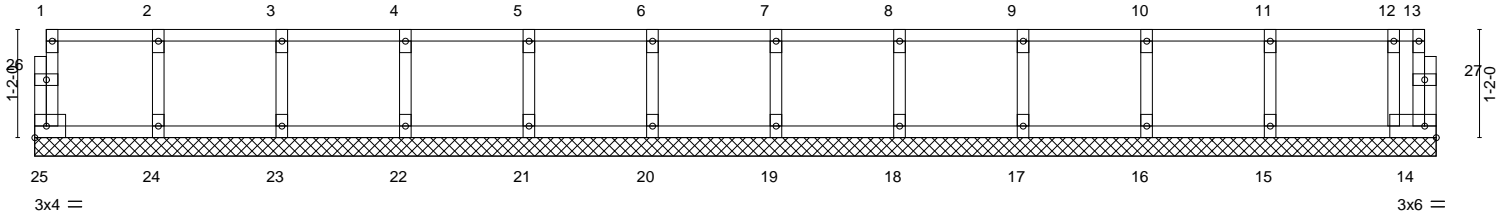

15-1-8  
15-1-8

LOADING (psf)	SPACING-	CSI.	DEFL.	in (loc)	l/defl	L/d	PLATES	GRIP
TCLL 40.0	Plate Grip DOL 1.00	TC 0.08	Vert(LL)	n/a	-	n/a	MT20	244/190
TCDL 10.0	Lumber DOL 1.00	BC 0.02	Vert(CT)	n/a	-	n/a		
BCLL 0.0	Rep Stress Incr YES	WB 0.03	Horz(CT)	0.00	14	n/a		
BCDL 5.0	Code IRC2015/TPI2014	Matrix-R					Weight: 65 lb	FT = 20%F, 11%E

**LUMBER-**  
TOP CHORD 2x4 SP No.1(flat)  
BOT CHORD 2x4 SP No.1(flat)  
WEBS 2x4 SP No.3(flat)  
OTHERS 2x4 SP No.3(flat)

**BRACING-**  
TOP CHORD Structural wood sheathing directly applied or 6-0-0 oc purlins, except end verticals.  
BOT CHORD Rigid ceiling directly applied or 10-0-0 oc bracing.

**REACTIONS.** All bearings 15-1-8.  
(lb) - Max Grav All reactions 250 lb or less at joint(s) 25, 14, 24, 23, 22, 21, 20, 19, 18, 17, 16, 15

**FORCES.** (lb) - Max. Comp./Max. Ten. - All forces 250 (lb) or less except when shown.

- NOTES-**
- 1) All plates are 1.5x3 MT20 unless otherwise indicated.
  - 2) Plates checked for a plus or minus 1 degree rotation about its center.
  - 3) Gable requires continuous bottom chord bearing.
  - 4) Truss to be fully sheathed from one face or securely braced against lateral movement (i.e. diagonal web).
  - 5) Gable studs spaced at 1-4-0 oc.
  - 6) Recommend 2x6 strongbacks, on edge, spaced at 10-0-0 oc and fastened to each truss with 3-10d (0.131" X 3") nails. Strongbacks to be attached to walls at their outer ends or restrained by other means.



March 6, 2024

**WARNING - Verify design parameters and READ NOTES ON THIS AND INCLUDED MITEK REFERENCE PAGE MII-7473 rev. 1/2/2023 BEFORE USE.**  
Design valid for use only with MiTek® connectors. This design is based only upon parameters shown, and is for an individual building component, not a truss system. Before use, the building designer must verify the applicability of design parameters and properly incorporate this design into the overall building design. Bracing indicated is to prevent buckling of individual truss web and/or chord members only. Additional temporary and permanent bracing is always required for stability and to prevent collapse with possible personal injury and property damage. For general guidance regarding the fabrication, storage, delivery, erection and bracing of trusses and truss systems, see **ANSI/TPH Quality Criteria and DSB-22** available from Truss Plate Institute (www.tpinst.org) and **BCSI Building Component Safety Information** available from the Structural Building Component Association (www.sbcacomponents.com)



818 Soundside Road  
Edenton, NC 27932

# Symbols

## PLATE LOCATION AND ORIENTATION

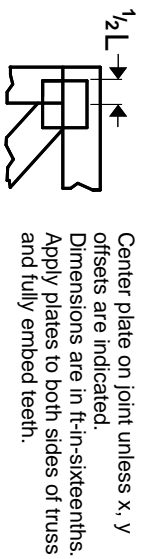

Center plate on joint unless x, y offsets are indicated. Dimensions are in ft-in-sixteenths. Apply plates to both sides of truss and fully embed teeth.



For 4 x 2 orientation, locate plates 0- 1/16\" from outside edge of truss.



This symbol indicates the required direction of slots in connector plates.

\* Plate location details available in MITek software or upon request.

## PLATE SIZE

**4 X 4**

The first dimension is the plate width measured perpendicular to slots. Second dimension is the length parallel to slots.

## LATERAL BRACING LOCATION



Indicated by symbol shown and/or by text in the bracing section of the output. Use T or I bracing if indicated.

## BEARING

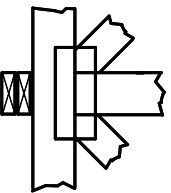

Indicates location where bearings (supports) occur. Icons vary but reaction section indicates joint number/letter where bearings occur. Min size shown is for crushing only.

## Industry Standards:

ANSI/TP1: National Design Specification for Metal Plate Connected Wood Truss Construction.  
DSB-22: Design Standard for Bracing.  
BCSI: Building Component Safety Information, Guide to Good Practice for Handling, Installing, Restraining & Bracing of Metal Plate Connected Wood Trusses.

# Numbering System

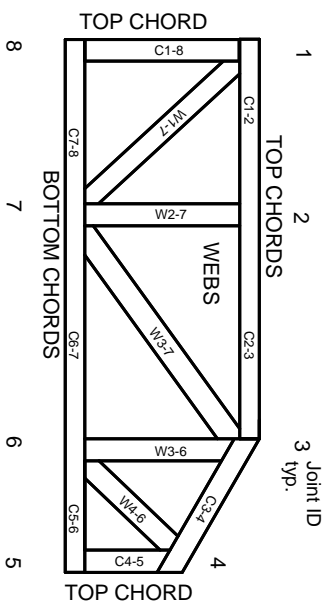

**JOINTS ARE GENERALLY NUMBERED/LETTERED CLOCKWISE AROUND THE TRUSS STARTING AT THE JOINT FARTHEST TO THE LEFT.**

**CHORDS AND WEBS ARE IDENTIFIED BY END JOINT NUMBERS/LETTERS.**

# Product Code Approvals

ICC-ES Reports:

ESR-1988, ESR-2362, ESR-2685, ESR-3282  
ESR-4722, ESL-1388

# Design General Notes

Trusses are designed for wind loads in the plane of the truss unless otherwise shown.

Lumber design values are in accordance with ANSI/TP1 section 6.3. These truss designs rely on Lumber values established by others.

© 2023 MITek® All Rights Reserved

**MITek**

ENGINEERING BY  
**TRENGO**  
A MITek Affiliate

MITek Engineering Reference Sheet: MIL-7473 rev. 1/2/2023

# General Safety Notes

## Failure to Follow Could Cause Property Damage or Personal Injury

1. Additional stability/bracing for truss system, e.g. diagonal or X-bracing, is always required. See BCSI.
2. Truss bracing must be designed by an engineer. For wide truss spacing, individual lateral braces themselves may require bracing, or alternative Tor I bracing should be considered.
3. Never exceed the design loading shown and never stack materials on inadequately braced trusses.
4. Provide copies of this truss design to the building designer, erection supervisor, property owner and all other interested parties.
5. Cut members to bear tightly against each other.
6. Place plates on each face of truss at each joint and embed fully. Knots and wane at joint locations are regulated by ANSI/TP1 1.
7. Design assumes trusses will be suitably protected from the environment in accord with ANSI/TP1 1.
8. Unless otherwise noted, moisture content of lumber shall not exceed 19% at time of fabrication.
9. Unless expressly noted, this design is not applicable for use with fire retardant, preservative treated, or green lumber.
10. Camber is a non-structural consideration and is the responsibility of truss fabricator. General practice is to camber for dead load deflection.
11. Plate type, size, orientation and location dimensions indicated are minimum plating requirements.
12. Lumber used shall be of the species and size, and in all respects, equal to or better than that specified.
13. Top chords must be sheathed or purlins provided at spacing indicated on design.
14. Bottom chords require lateral bracing at 10 ft. spacing, or less, if no ceiling is installed, unless otherwise noted.
15. Connections not shown are the responsibility of others.
16. Do not cut or alter truss member or plate without prior approval of an engineer.
17. Install and load vertically unless indicated otherwise.
18. Use of green or treated lumber may pose unacceptable environmental, health or performance risks. Consult with project engineer before use.
19. Review all portions of this design (front, back, words and pictures) before use. Reviewing pictures alone is not sufficient.
20. Design assumes manufacture in accordance with ANSI/TP1 1 Quality Criteria.
21. The design does not take into account any dynamic or other loads other than those expressly stated.