

Trenco
818 Soundside Rd
Edenton, NC 27932

Re: J0524-3232
135 Duncans Creek

The truss drawing(s) referenced below have been prepared by Truss Engineering Co. under my direct supervision based on the parameters provided by Comtech, Inc - Fayetteville.

Pages or sheets covered by this seal: I68934271 thru I68934272

My license renewal date for the state of North Carolina is December 31, 2024.

North Carolina COA: C-0844



October 17, 2024

Gilbert, Eric

IMPORTANT NOTE: The seal on these truss component designs is a certification that the engineer named is licensed in the jurisdiction(s) identified and that the designs comply with ANSI/TPI 1. These designs are based upon parameters shown (e.g., loads, supports, dimensions, shapes and design codes), which were given to MiTek or TRENCO. Any project specific information included is for MiTek's or TRENCO's customers file reference purpose only, and was not taken into account in the preparation of these designs. MiTek or TRENCO has not independently verified the applicability of the design parameters or the designs for any particular building. Before use, the building designer should verify applicability of design parameters and properly incorporate these designs into the overall building design per ANSI/TPI 1, Chapter 2.

| | | | | | | |
|-------------------|--------------|---------------------|-----------|----------|---|-----------|
| Job J0524-3232 | Truss F01 | Truss Type FLOOR | Qty 11 | Ply 1 | 135 Duncans Creek Job Reference (optional) | 168934271 |
|-------------------|--------------|---------------------|-----------|----------|---|-----------|

Comtech, Inc. Fayetteville, NC - 28314,

8.630 s Sep 26 2024 MiTek Industries, Inc. Wed Oct 16 06:55:37 2024 Page 1

ID:MRVdg0cxPqsK8U739DzMHizpZII-RfC?PsB70Hq3NSgPqnL8w3uITXbGKWrCDoi7J4zJC?f



REPAIR: REMOVE BEARING AT JOINT 20.



INSTALL 2 X 4 SP NO.2
CUT TO FIT TIGHT.

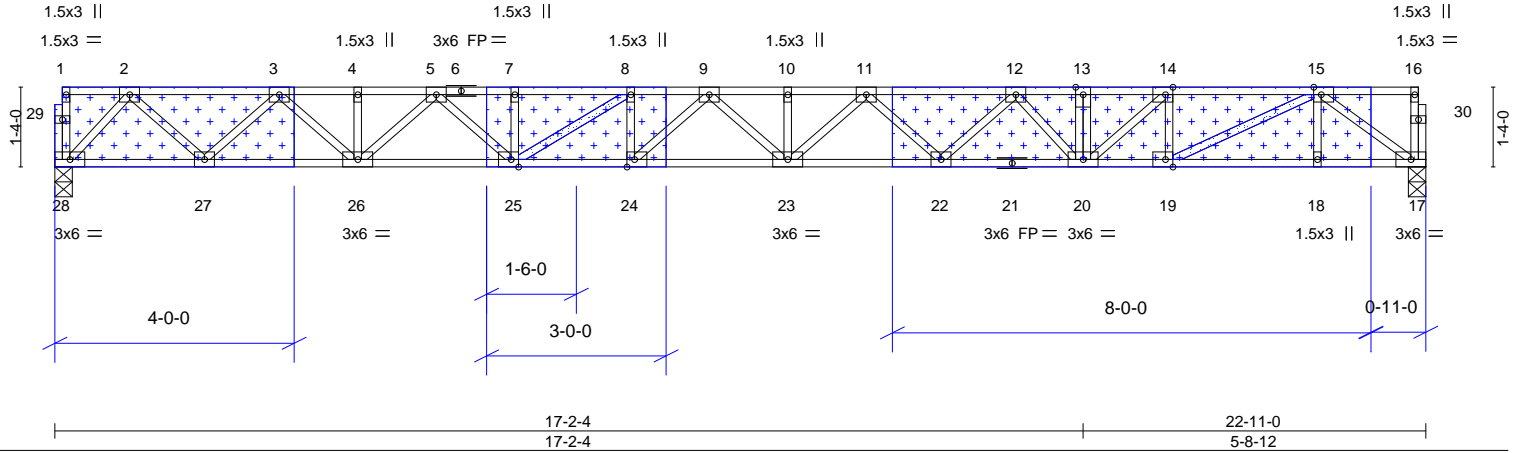

Plate Offsets (X,Y)-- [2:0-0-0,0-0-0], [14:0-1-8,Edge], [15:0-1-8,Edge], [19:0-1-8,Edge], [24:0-1-8,Edge], [25:0-1-8,Edge]

| | | | | | | | | | |
|----------------------|----------------------|-------|-------------|--------------|----------|--------|------|----------------|-----------------|
| LOADING (psf) | SPACING- | 1-7-3 | CSI. | DEFL. | in (loc) | l/defl | L/d | PLATES | GRIP |
| TCLL 40.0 | Plate Grip DOL | 1.00 | TC 0.49 | Vert(LL) | -0.46 | 23-24 | >594 | MT20 | 244/190 |
| TCDL 10.0 | Lumber DOL | 1.00 | BC 0.88 | Vert(CT) | -0.63 | 23-24 | >431 | | |
| BCLL 0.0 | Rep Stress Incr | YES | WB 0.79 | Horz(CT) | 0.10 | 17 | n/a | | |
| BCDL 5.0 | Code IRC2015/TPI2014 | | Matrix-S | | | | | | |
| | | | | | | | | Weight: 128 lb | FT = 20%F, 11%E |

LUMBER-
TOP CHORD 2x4 SP No.1(flat)
BOT CHORD 2x4 SP No.1(flat)
WEBS 2x4 SP No.3(flat)

BRACING-
TOP CHORD Structural wood sheathing directly applied or 5-11-14 oc purlins, except end verticals.
BOT CHORD Rigid ceiling directly applied or 10-0-0 oc bracing.

REACTIONS. (lb/size) 28=992/0-3-8, 17=992/0-3-8



ATTACH 3/4" PLYWOOD OR OSB GUSSET (23/32" RATED SHEATHING 48/24 EXP 1) TO EACH SIDE OF TRUSS WITH ONE ROW OF (0.131" X 2.5") NAILS SPACED 2" O.C. FROM EACH FACE INTO EACH COVERED TRUSS MEMBER. IN ADDITION TO REQUIRED NAILING, CONSTRUCTION QUALITY ADHESIVE RECOMMENDED TO REDUCE POTENTIAL SQUEAKS.

FORCES. (lb) - Max. Comp./Max. Ten. - All forces 250 (lb) or less except when shown.
TOP CHORD 2-3=-1728/0, 3-4=-3182/0, 4-5=-3182/0, 5-6=-4162/0, 6-7=-4162/0, 7-8=-4162/0, 8-9=-4554/0, 9-10=-4643/0, 10-11=-4643/0, 11-12=-4229/0, 12-13=-3466/0, 13-14=-3466/0, 14-15=-2819/0
BOT CHORD 27-28=0/904, 26-27=0/2529, 25-26=0/3727, 24-25=0/4554, 23-24=0/4653, 22-23=0/4523, 21-22=0/3915, 20-21=0/3915, 19-20=0/2819, 18-19=0/1322, 17-18=0/1322
WEBS 2-28=-1326/0, 2-27=0/1145, 3-27=-1114/0, 3-26=0/887, 12-20=-656/0, 12-22=0/438, 11-22=-408/0, 5-26=-741/0, 15-17=-1623/0, 14-20=0/847, 14-19=-718/0, 5-25=0/592, 8-25=-462/0, 15-19=0/1665

- NOTES-**
- 1) All plates are 3x4 MT20 unless otherwise indicated.
 - 2) N/A
 - 3) The Fabrication Tolerance at joint 21 = 0%, joint 3 = 0%
 - 4) Plates checked for a plus or minus 1 degree rotation about its center.
 - 5) This truss is designed in accordance with the 2015 International Residential Code sections R502.11.1 and R802.10.2 and referenced standard ANSI/TPI 1.
 - 6) Recommend 2x6 strongbacks, on edge, spaced at 10-0-0 oc and fastened to each truss with 3-10d (0.131" X 3") nails. Strongbacks to be attached to walls at their outer ends or restrained by other means.
 - 7) CAUTION, Do not erect truss backwards.



October 17, 2024

WARNING - Verify design parameters and READ NOTES ON THIS AND INCLUDED MITEK REFERENCE PAGE MII-7473 rev. 1/2/2023 BEFORE USE.
Design valid for use only with MiTek® connectors. This design is based only upon parameters shown, and is for an individual building component, not a truss system. Before use, the building designer must verify the applicability of design parameters and properly incorporate this design into the overall building design. Bracing indicated is to prevent buckling of individual truss web and/or chord members only. Additional temporary and permanent bracing is always required for stability and to prevent collapse with possible personal injury and property damage. For general guidance regarding the fabrication, storage, delivery, erection and bracing of trusses and truss systems, see **ANSI/TPH Quality Criteria and DSB-22** available from Truss Plate Institute (www.tpinst.org) and **BCSI Building Component Safety Information** available from the Structural Building Component Association (www.sbcacomponents.com)



818 Soundside Road
Edenton, NC 27932

| | | | | | | |
|---|-------|------------|-----|-----|-------------------|--|
| Job | Truss | Truss Type | Qty | Ply | 135 Duncans Creek | 68934272 |
| J0524-3232 | F02 | FLOOR | 1 | 1 | | |
| Comtech, Inc. Fayetteville, NC - 28314, | | | | | | 8.630 s Sep 26 2024 MiTek Industries, Inc. Wed Oct 16 06:55:38 2024 Page 1 |
| | | | | | | ID:MRVdg0cxPqsK8U739DzMHizpZII-RfC?PsB70Hq3NSgPqnL8w3uITXbGKWrCDoi7J4zJC?f |



REPAIR: REMOVE BEARING AT JOINT 20.



INSTALL 2 X 4 SP NO.2 CUT TO FIT TIGHT.

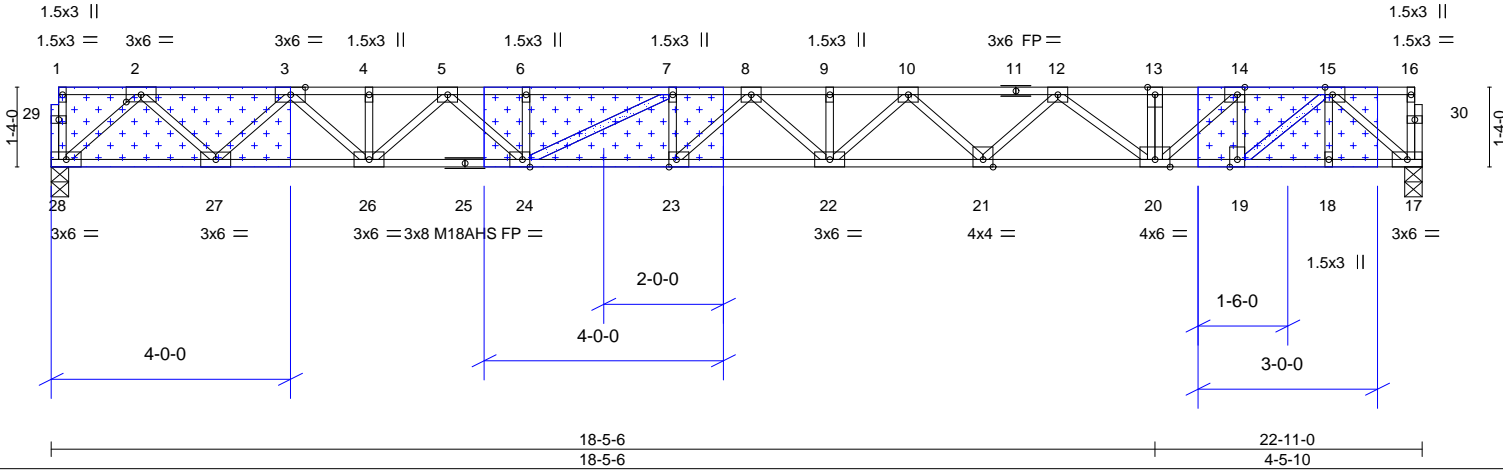

| | |
|-----------------------|---|
| Plate Offsets (X,Y)-- | [2:0-2-15,0-1-7], [3:0-2-15,Edge], [14:0-1-8,Edge], [15:0-1-8,Edge], [23:0-1-8,Edge], [24:0-1-8,Edge], [27:0-0-0,0-0-0] |
|-----------------------|---|

| | | | | | | | | | | |
|----------------------|----------------------|-------|-------------|--------------|----------|--------|------|---------------|----------------|-----------------|
| LOADING (psf) | SPACING- | 1-7-3 | CSL. | DEFL. | in (loc) | l/defl | L/d | PLATES | GRIP | |
| TCLL 40.0 | Plate Grip DOL | 1.00 | TC 0.49 | Vert(LL) | -0.46 | 22-23 | >598 | 480 | MT20 | 244/190 |
| TCDL 10.0 | Lumber DOL | 1.00 | BC 0.88 | Vert(CT) | -0.63 | 22-23 | >434 | 360 | M18AHS | 186/179 |
| BCLL 0.0 | Rep Stress Incr | YES | WB 0.60 | Horz(CT) | 0.10 | 17 | n/a | n/a | | |
| BCDL 5.0 | Code IRC2015/TPI2014 | | Matrix-S | | | | | | | |
| | | | | | | | | | Weight: 128 lb | FT = 20%F, 11%E |

| | |
|------------------------------|---|
| LUMBER- | BRACING- |
| TOP CHORD 2x4 SP No.1 (flat) | TOP CHORD Structural wood sheathing directly applied or 5-11-14 oc purlins, except end verticals. |
| BOT CHORD 2x4 SP No.1 (flat) | BOT CHORD Rigid ceiling directly applied or 10-0-0 oc bracing. |
| WEBS 2x4 SP No.3 (flat) | |

REACTIONS. (lb/size) 28=992/0-3-8, 17=992/0-3-8

FORCES. (lb) - Max. Comp./Max. Ten. - All forces 250 (lb) or less except when shown.

TOP CHORD 2-3=-1888/0, 3-4=-3296/0, 4-5=-3296/0, 5-6=-4239/0, 6-7=-4239/0, 7-8=-4644/0, 8-9=-4578/0, 9-10=-4578/0, 10-11=-4023/0, 11-12=-4023/0, 12-13=-2899/0, 13-14=-2899/0, 14-15=-2092/0

BOT CHORD 27-28=0/1087, 26-27=0/2667, 25-26=0/3814, 24-25=0/3814, 23-24=0/4644, 22-23=0/4659, 21-22=0/4386, 20-21=0/3638, 19-20=0/2092, 18-19=0/1121, 17-18=0/1121

WEBS 2-28=-1445/0, 2-27=0/1115, 3-27=-1082/0, 3-26=0/855, 5-26=-705/0, 5-24=0/578, 12-20=-923/0, 12-21=0/536, 10-21=-504/0, 10-22=0/261, 15-17=-1462/0, 14-20=0/1053, 14-19=-789/0, 15-19=0/1258, 7-24=-451/0

NOTES-

- 1) All plates are MT20 plates unless otherwise indicated.
- 2) All plates are 3x4 MT20 unless otherwise indicated.
- 3) N/A
- 4) The Fabrication Tolerance at joint 25 = 0%
- 5) Plates checked for a plus or minus 1 degree rotation about its center.
- 6) This truss is designed in accordance with the 2015 International Residential Code sections R502.11.1 and R802.10.2 and referenced standard ANSI/TPI 1.
- 7) Recommend 2x6 strongbacks, on edge, spaced at 10-0-0 oc and fastened to each truss with 3-10d (0.131" X 3") nails. Strongbacks to be attached to walls at their outer ends or restrained by other means.
- 8) CAUTION, Do not erect truss backwards.



ATTACH 3/4" PLYWOOD OR OSB GUSSET (23/32" RATED SHEATHING 48/24 EXP 1) TO EACH SIDE OF TRUSS WITH ONE ROW OF (0.131" X 2.5") NAILS SPACED 2" O.C. FROM EACH FACE INTO EACH COVERED TRUSS MEMBER. IN ADDITION TO REQUIRED NAILING, CONSTRUCTION QUALITY ADHESIVE RECOMMENDED TO REDUCE POTENTIAL SQUEAKS.

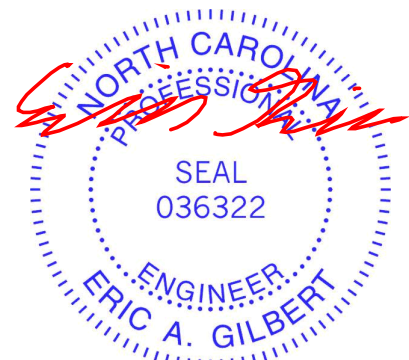

Symbols

PLATE LOCATION AND ORIENTATION

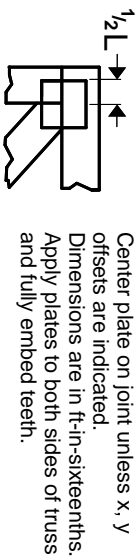

Center plate on joint unless x, y offsets are indicated. Dimensions are in ft-in-sixteenths. Apply plates to both sides of truss and fully embed teeth.

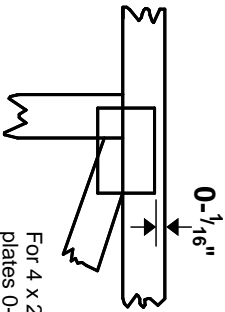

For 4 x 2 orientation, locate plates 0- 1/16\" from outside edge of truss.

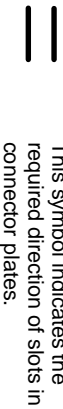

* Plate location details available in MITek software or upon request.

PLATE SIZE

4 X 4

The first dimension is the plate width measured perpendicular to slots. Second dimension is the length parallel to slots.

LATERAL BRACING LOCATION



Indicated by symbol shown and/or by text in the bracing section of the output. Use T or I bracing if indicated.

BEARING

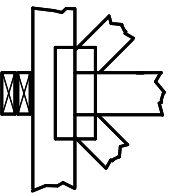

Indicates location where bearings (supports) occur. Icons vary but reaction section indicates joint number/letter where bearings occur. Min size shown is for crushing only.

Industry Standards:

ANSI/TP1: National Design Specification for Metal Plate Connected Wood Truss Construction.
DSB-22: Design Standard for Bracing.
BCSI: Building Component Safety Information, Guide to Good Practice for Handling, Installing, Restraining & Bracing of Metal Plate Connected Wood Trusses.

Numbering System

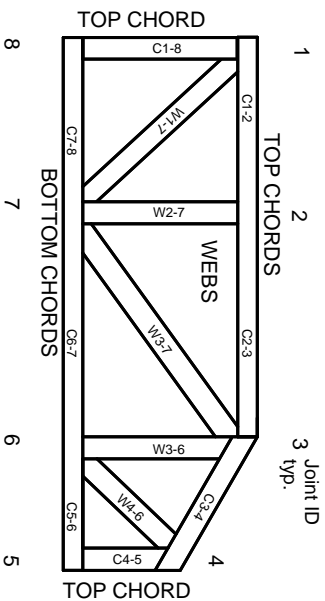

JOINTS ARE GENERALLY NUMBERED/LETTERED CLOCKWISE AROUND THE TRUSS STARTING AT THE JOINT FARTHEST TO THE LEFT.

CHORDS AND WEBS ARE IDENTIFIED BY END JOINT NUMBERS/LETTERS.

Product Code Approvals

ICC-ES Reports:

ESR-1988, ESR-2362, ESR-2685, ESR-3282
ESR-4722, ESL-1388

Design General Notes

Trusses are designed for wind loads in the plane of the truss unless otherwise shown.

Lumber design values are in accordance with ANSI/TP1 section 6.3. These truss designs rely on Lumber values established by others.

© 2023 MITek® All Rights Reserved

MITek

ENGINEERING BY
TRENGO
A MITek Affiliate

MITek Engineering Reference Sheet: MIL-7473 rev. 1/2/2023

General Safety Notes

Failure to Follow Could Cause Property Damage or Personal Injury

1. Additional stability/bracing for truss system, e.g. diagonal or X-bracing, is always required. See BCSI.
2. Truss bracing must be designed by an engineer. For wide truss spacing, individual lateral braces themselves may require bracing, or alternative Tor I bracing should be considered.
3. Never exceed the design loading shown and never stack materials on inadequately braced trusses.
4. Provide copies of this truss design to the building designer, erection supervisor, property owner and all other interested parties.
5. Cut members to bear tightly against each other.
6. Place plates on each face of truss at each joint and embed fully. Knots and wane at joint locations are regulated by ANSI/TP1 1.
7. Design assumes trusses will be suitably protected from the environment in accord with ANSI/TP1 1.
8. Unless otherwise noted, moisture content of lumber shall not exceed 19% at time of fabrication.
9. Unless expressly noted, this design is not applicable for use with fire retardant, preservative treated, or green lumber.
10. Camber is a non-structural consideration and is the responsibility of truss fabricator. General practice is to camber for dead load deflection.
11. Plate type, size, orientation and location dimensions indicated are minimum plating requirements.
12. Lumber used shall be of the species and size, and in all respects, equal to or better than that specified.
13. Top chords must be sheathed or purlins provided at spacing indicated on design.
14. Bottom chords require lateral bracing at 10 ft. spacing, or less, if no ceiling is installed, unless otherwise noted.
15. Connections not shown are the responsibility of others.
16. Do not cut or alter truss member or plate without prior approval of an engineer.
17. Install and load vertically unless indicated otherwise.
18. Use of green or treated lumber may pose unacceptable environmental, health or performance risks. Consult with project engineer before use.
19. Review all portions of this design (front, back, words and pictures) before use. Reviewing pictures alone is not sufficient.
20. Design assumes manufacture in accordance with ANSI/TP1 1 Quality Criteria.
21. The design does not take into account any dynamic or other loads other than those expressly stated.