

# Residence for

Garman Homes  
 Lot 0155 Serenity  
 Fuquay Varina, North Carolina



This document is property of Garman Homes Inc, and was prepared for their use only. The plans, elevations, illustrations, and other material contained within this set may not be reproduced, either in part or wholly, in any manner without the express written permission of Garman Homes, Inc. All right reserved and protected under federal law.

**Project Number**  
 Project Number  
**Plan Number**  
 FP-1942

## INDEX TO DRAWINGS

- COVER SHEET  
 1 FRONT & LEFT SIDE ELEVATIONS  
 2 REAR & RIGHT SIDE ELEVATIONS  
 3 FIRST & SECOND FLOOR PLANS  
 E FIRST & SECOND FLOOR ELECTRICAL PLANS  
 M FIRST & SECOND FLOOR MECHANICAL PLANS  
 P FIRST FLOOR PLUMBING PLAN  
 D CONSTRUCTION DETAILS

- S1 FOUNDATION PLAN & FIRST FLOOR FRAMING PLAN  
 S2 SECOND FLOOR FRAMING PLAN & ROOF FRAMING PLAN  
 S3 GARAGE FOUNDATION PLAN, FIRST FLOOR & ROOF FRAMING PLANS  
 SD1 STRUCTURAL DETAILS  
 SPEC STRUCTURAL NOTES

## GENERAL NOTES

- ALL WORK TO BE DONE IN STRICT ACCORDANCE WITH NORTH CAROLINA STATE RESIDENTIAL BUILDING CODE, 2018 EDITION (HEREWITH SHOWN AS N.C.S.R.B.C.).
- DIMENSIONS SHOWN ON DRAWINGS GOVERN OVER SCALE.
- STUD WALL DESIGN SHALL CONFORM TO ALL N.C.S.R.B.C. REQUIREMENTS
- CONTRACTOR SHALL USE TEMPERED SAFETY GLASS IN ALL LOCATIONS AS REQUIRED BY N.C.S.R.B.C., 2018 EDITION, SECTION R308.4.
- ANY HABITABLE ROOM SHALL MEET ALL LIGHT/VENTILATION AND EGRESS AS REQUIRED BY N.C.S.R.B.C. 2018 EDITION, SECTIONS R-303.1 AND R-310.1.
- ALL EXTERIOR WALLS SHOWN ON FLOOR PLANS ARE 2X6 FRAME UNLESS NOTED OTHERWISE. ALL INTERIOR WALLS SHOWN ON FLOOR PLANS ARE 2X4 FRAME UNLESS NOTED OTHERWISE.
- ALL ANGLED WALLS SHOWN ON FLOOR PLANS ARE 45 UNLESS NOTED OTHERWISE.
- ALL WINDOWS SHALL HAVE A MINIMUM DPI RATING OF 25. BUILDER SHALL VERIFY WITH WINDOW MANUFACTURER THAT UNITS INSTALLED MEET THESE REQUIREMENTS AS PER N.C.S.R.B.C., 2018 EDITION, TABLE 301.2(4).
- ENERGY EFFICIENCY REQUIREMENTS FOR THE SPECIFIC CLIMATE ZONE WHERE STRUCTURE IS BEING BUILT SHALL BE IN ACCORDANCE WITH CHAPTER 11 OF THE N.C.S.R.B.C., 2018 EDITION, AS SHOWN IN SECTION N1101.2.

## RESIDENTIAL BUILDING CODE SUMMARY

- PLANS ARE DESIGNED TO THE 2018 N.C.S.R.B.C.
- HOUSE IS DESIGNED FOR 115 MPH ULTIMATE DESIGN WIND SPEED (89 MPH NOMINAL DESIGN WIND SPEED), EXPOSURE B.
- ANCHOR BOLTS SHALL BE MIN. 1/2" DIAMETER AND SHALL EXTEND 7" MIN. INTO MASONRY OR CONCRETE. BOLTS TO BE NO MORE THAN 6' O.C. AND WITHIN 12" FROM THE CORNER.
- MEAN ROOF HEIGHT: 29'-7"
- COMPONENT & CLADDING DESIGNED FOR THE FOLLOWING LOADS:  

MEAN ROOF HGT:	UP TO 30'	30'-1" TO 35'	35'-1" TO 40'	40'-1" TO 45'
ZONE 1	16.5,-18.0	17.3,-18.9	17.3,-18.9	17.3,-18.9
ZONE 2	16.5,-21.0	17.3,-22.1	17.3,-22.1	17.3,-22.1
ZONE 3	16.5,-21.0	17.3,-22.1	17.3,-22.1	17.3,-22.1
ZONE 4	18.0,-19.5	18.9,-20.5	18.9,-20.5	18.9,-20.5
ZONE 5	18.0,-24.1	18.9,-25.3	18.9,-25.3	18.9,-25.3
- MINIMUM VALUES FOR ENERGY COMPLIANCE: Zone 4
- MAXIMUM GLAZING U-FACTOR: .35
- INSULATING VALUES: CEILING: R-49 / WALLS: R-15 / FLOOR: R-19 SLABS: R-10. CODE REFERENCE: TABLE N1102.1

## AREA CALCULATIONS

	HEATED (SQ. FT.)	UNHEATED (SQ. FT.)	UNFINISHED (SQ. FT.)
1ST FLOOR:	830	FRONT PORCH: 85	BASEMENT: N/A
2ND FLOOR:	1112	GARAGE: 425	1ST FLOOR: N/A
		PATIO: 100	2ND FLOOR: N/A
TOTAL:	1942	TOTAL: 525	ATTIC: N/A
			TOTAL: N/A

OVERALL DIMENSIONS  
 WIDTH: 34'-4"  
 DEPTH: 50'-2"

## FOUNDATION VENTILATION CALCULATIONS

(REFERENCE: N.C.S.R.B.C. 2018 EDITION SECTION R408.)

NOT APPLICABLE WITH SLAB FOUNDATIONS



1

2

HONEYSUCKLE  
 SER ELEVATION A  
 LOT 0155 SERENITY

## MATERIALS LEGEND

	EARTH/COMPACT FILL		FINISH WOOD
	CONCRETE		ROUGH WOOD
	BRICK		BLOCKING
	CONCRETE BLOCK/STONE		PLYWOOD
	STEEL		BATT INSULATION
	ALUMINUM		RIGID INSULATION

## ATTIC VENTILATION REQUIREMENTS

NATURAL ROOF VENTILATION CALCULATIONS

$$\frac{1340 \text{ SQ. FT.}}{150} = 8.93 \text{ SQ. FT. VENT REQ'D}$$

BUILDER TO PROVIDE APPROPRIATE VENTILATING AS REQUIRED PER CODE

MECHANICAL ROOF VENTILATION CALCULATIONS

$$\frac{1340 \text{ SQ. FT.}}{300} = 4.47 \text{ SQ. FT. VENT REQ'D}$$

BUILDER TO PROVIDE APPROPRIATE VENTILATING AS REQUIRED PER CODE

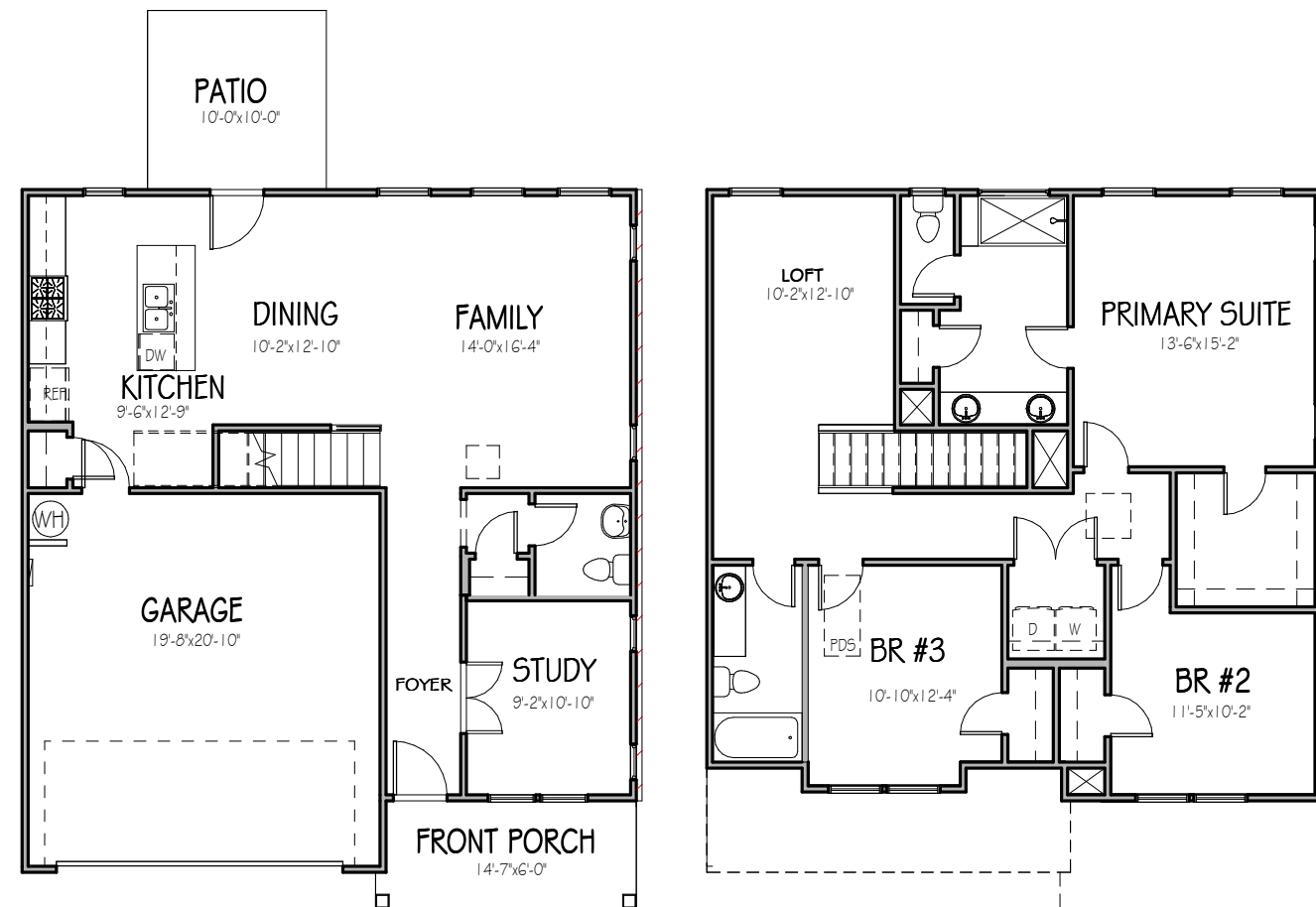

**Drawn By**  
 MMH  
**Checked By**  
 JM  
**Date Drawn**  
 3/15/20  
**Revision Date**  
 7/2/20  
 4/5/22  
 10/26/22

Sheet

C

THE PURPOSE OF THESE DRAWINGS IS TO SHOW THE INTENT OF THE DESIGN AND CONSTRUCTION OF THIS HOME. CONTRACTOR SHOULD VERIFY ALL CONDITIONS AND DIMENSIONS PRIOR TO CONSTRUCTION. ONCE A PERMIT HAS BEEN ISSUED, CONTRACTOR SHALL ASSUME ALL RESPONSIBILITY TO THE ACCURACY OF THE PLANS AND ANY CHANGES MADE DURING CONSTRUCTION.



This document is property of Garman Homes Inc, and was prepared for their use only. The plans, elevations, illustrations, and other material contained within this set may not be reproduced, either in part or wholly, in any manner without the express written permission of Garman Homes, Inc. All right reserved and protected under federal law.

<b>Project Number</b>	Project Number
<b>Plan Number</b>	FP-1942

**HONEYSUCKLE**  
 SER ELEVATION A  
 LOT 0155 SERENITY

<b>Drawn By</b>	MH
<b>Checked By</b>	CM
<b>Date Drawn</b>	4/8/20
<b>Revision Date</b>	7/1/20 4/5/22 10/26/22

Sheet

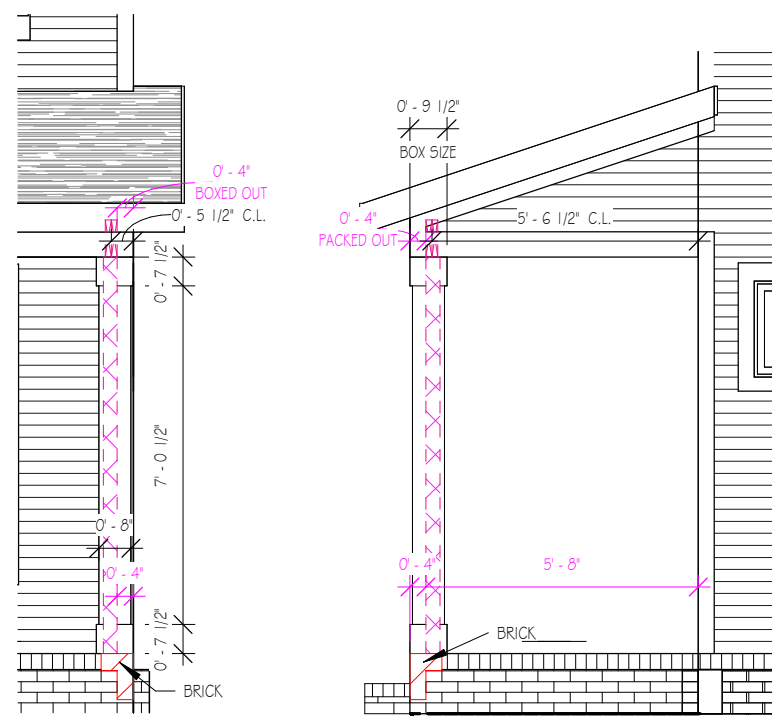

**COLUMN DETAILS**

1/4" = 1'-0"



**FRONT ELEVATION**

1/8" = 1'-0"

NOTE - SLOPE ALL GRADE AWAY FROM HOUSE FOR POSITIVE DRAINAGE

NOTE:  
PROVIDE RAILS @ PORCH ONLY IF REQUIRED BY CODE

15' MIN. HGT. FOUNDATION FRONT GRADE TO FINISHED FRONT PORCH

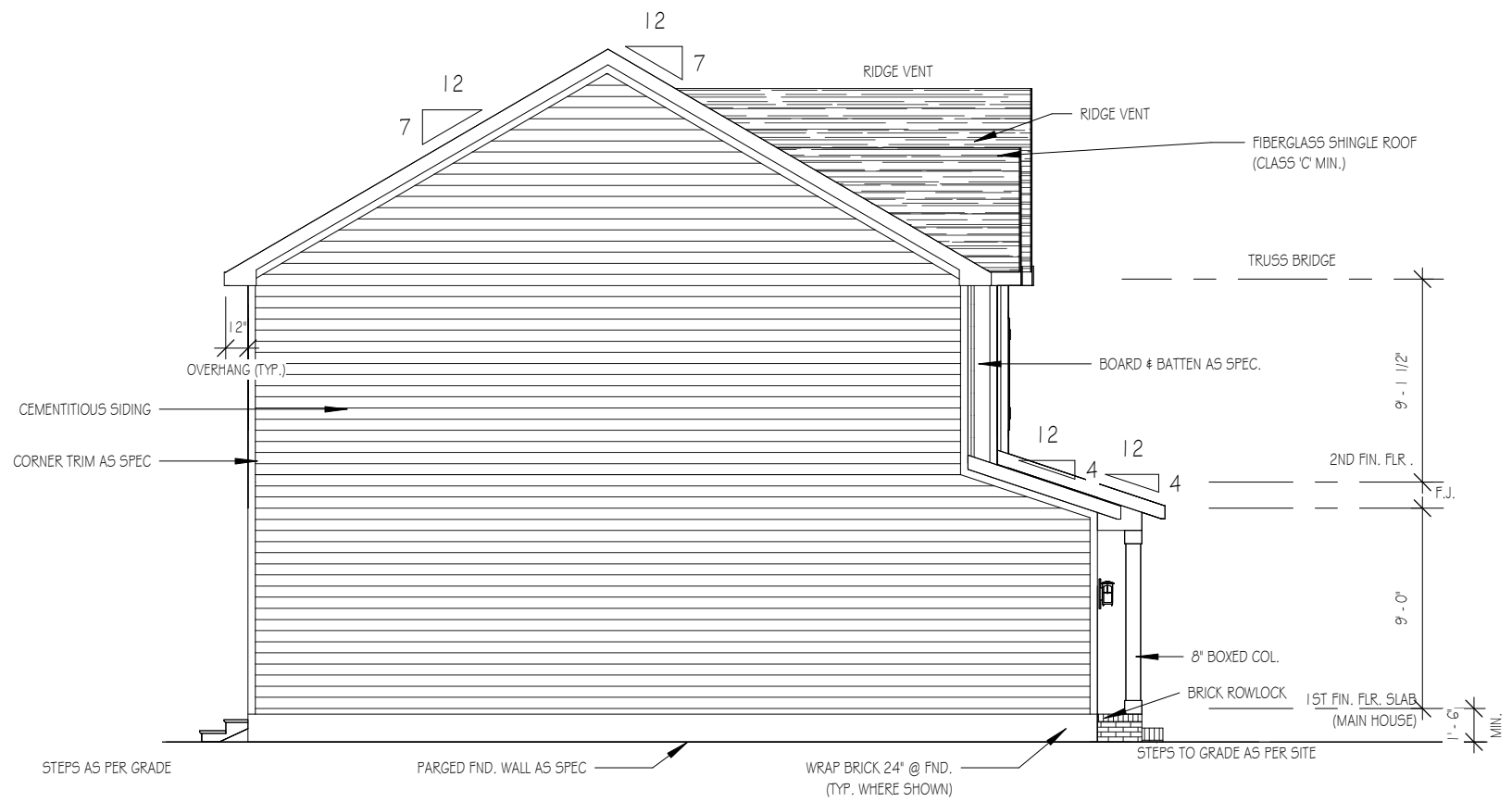

**LEFT SIDE ELEVATION**

1/8" = 1'-0"

THE PURPOSE OF THESE DRAWINGS IS TO SHOW THE INTENT OF THE DESIGN AND CONSTRUCTION OF THIS HOME. CONTRACTOR SHOULD VERIFY ALL CONDITIONS AND DIMENSIONS PRIOR TO CONSTRUCTION. ONCE A PERMIT HAS BEEN ISSUED, CONTRACTOR SHALL ASSUME ALL RESPONSIBILITY TO THE ACCURACY OF THE PLANS AND ANY CHANGES MADE DURING CONSTRUCTION.



This document is property of Garman Homes Inc, and was prepared for their use only. The plans, elevations, illustrations, and other material contained within this set may not be reproduced, either in part or wholly, in any manner without the express written permission of Garman Homes, Inc. All right reserved and protected under federal law.

<b>Project Number</b>	Project Number
<b>Plan Number</b>	FP-1942



**REAR ELEVATION**

1/8" = 1'-0" NOTE - SLOPE ALL GRADES AWAY FROM HOUSE FOR POSITIVE DRAINAGE

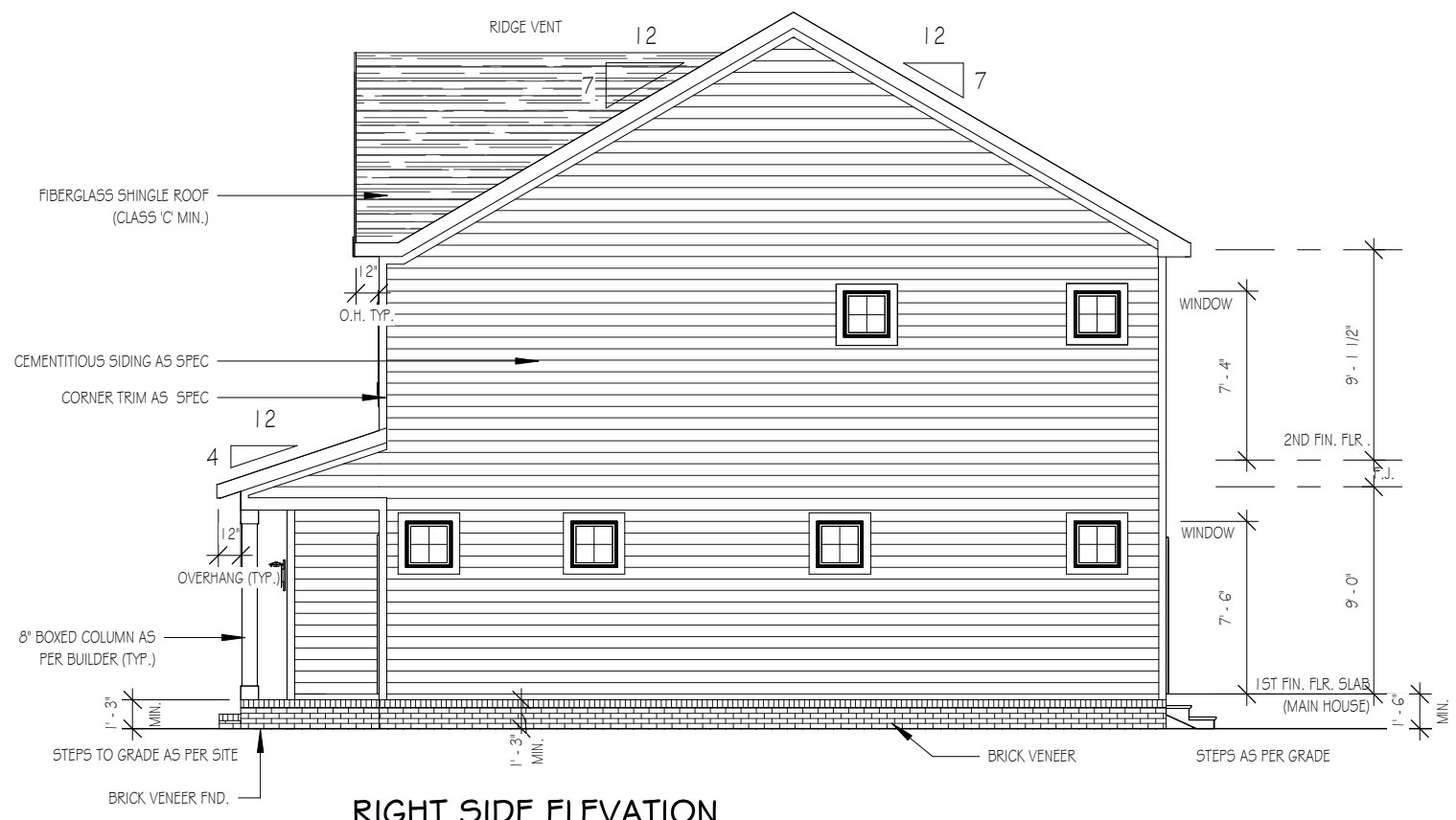

**RIGHT SIDE ELEVATION**

1/8" = 1'-0"

**HONEYSUCKLE**  
 SER ELEVATION A  
 LOT 0155 SERENITY

<b>Drawn By</b>	MH
<b>Checked By</b>	CM
<b>Date Drawn</b>	4/8/20
<b>Revision Date</b>	7/1/20
	4/5/22
	10/26/22

Sheet



THE PURPOSE OF THESE DRAWINGS IS TO SHOW THE INTENT OF THE DESIGN AND CONSTRUCTION OF THIS HOME. CONTRACTOR SHOULD VERIFY ALL CONDITIONS AND DIMENSIONS PRIOR TO CONSTRUCTION. ONCE A PERMIT HAS BEEN ISSUED, CONTRACTOR SHALL ASSUME ALL RESPONSIBILITY TO THE ACCURACY OF THE PLANS AND ANY CHANGES MADE DURING CONSTRUCTION.

This document is property of Garman Homes Inc, and was prepared for their use only. The plans, elevations, illustrations, and other material contained within this set may not be reproduced, either in part or wholly, in any manner without the express written permission of Garman Homes, Inc. All right reserved and protected under federal law.

<b>Project Number</b>	Project Number
<b>Plan Number</b>	FP-1942

ELECTRICAL LEGEND	
	FLUSH MOUNT/PENDANT LIGHT
	LED DISK LIGHT
	KEYLESS LIGHT
	RECESSED CAN LIGHT
	WALL SCONCE
	FLOOD LIGHT
	FLUORESCENT LIGHT
	CEILING FAN
	EXHAUST FAN
	ETHERNET OUTLET
	CABLE OUTLET
	SMOKE DETECTOR
	FLOOR RECEPTACLE
	DUPLEX RECEPTACLE
	GFCI RECEPTACLE
	220 VOLT RECEPTACLE
	ELECTRICAL PANEL
	SINGLE SWITCH
	3-WAY SWITCH
	DIMMER SWITCH
	THERMOSTAT
	D.B.
	DOORBELL

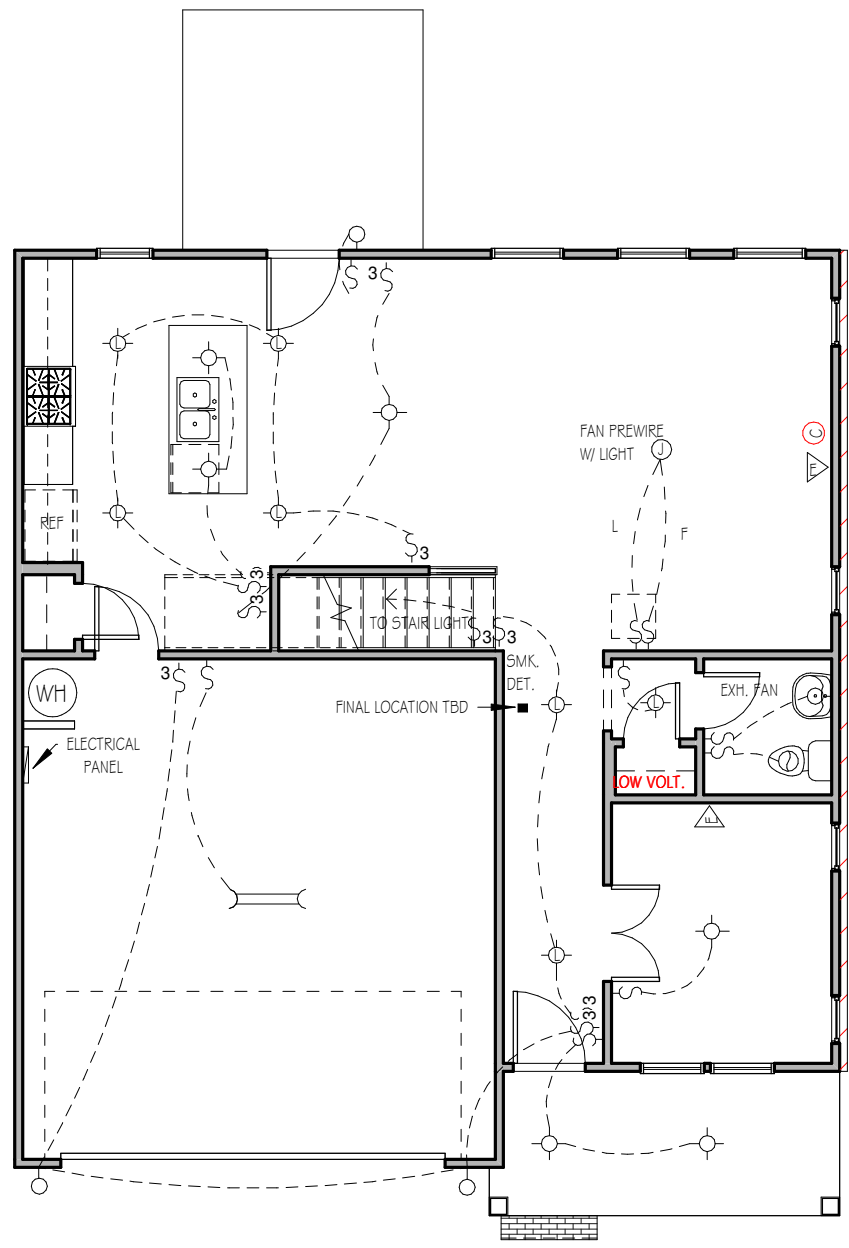

\*\*NOTE: THREE ETHERNET OUTLETS IN THESE PREDETERMINED LOCATIONS ARE STANDARD. ANY ADDITIONAL OUTLETS ARE AN UPGRADE.

**FIRST FLOOR ELECTRICAL PLANS**

1/8" = 1'-0"

NOTE - ELECTRICAL RECEPTACLE AND SWITCH QUANTITIES AND LOCATIONS SHOWN ON PLAN ARE FOR ILLUSTRATION PURPOSES ONLY. ACTUAL NUMBER AND LOCATIONS SHALL BE FIELD DETERMINED AS PER CLIENT AND BUILDER EXCEPT WHERE CODE REQUIREMENTS APPLY.

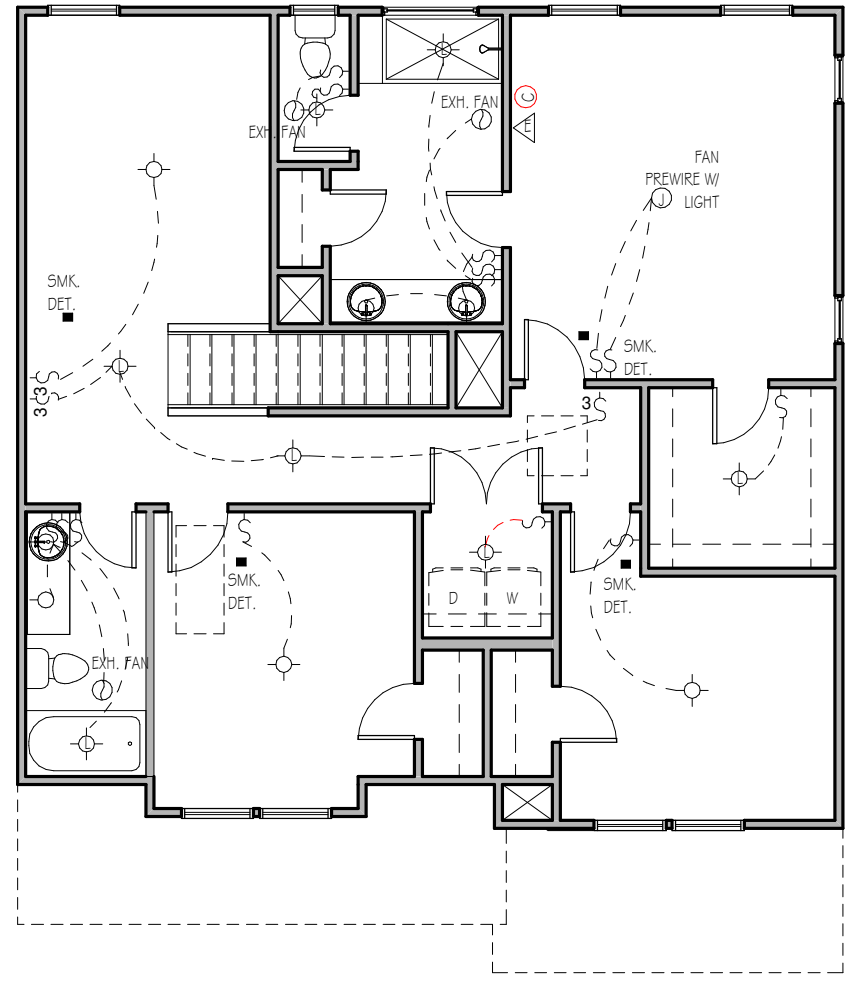

**SECOND FLOOR ELECTRICAL PLAN**

1/8" = 1'-0"

NOTE - ELECTRICAL RECEPTACLE AND SWITCH QUANTITIES AND LOCATIONS SHOWN ON PLAN ARE FOR ILLUSTRATION PURPOSES ONLY. ACTUAL NUMBER AND LOCATIONS SHALL BE FIELD DETERMINED AS PER CLIENT AND BUILDER EXCEPT WHERE CODE REQUIREMENTS APPLY.

**HONEYSUCKLE**  
SER ELEVATION A  
LOT 0155 SERENITY

<b>Drawn By</b>	MH
<b>Checked By</b>	CM
<b>Date Drawn</b>	4/8/20
<b>Revision Date</b>	7/1/20
	4/5/22
	10/26/22

Sheet

THE PURPOSE OF THESE DRAWINGS IS TO SHOW THE INTENT OF THE DESIGN AND CONSTRUCTION OF THIS HOME. CONTRACTOR SHOULD VERIFY ALL CONDITIONS AND DIMENSIONS PRIOR TO CONSTRUCTION. ONCE A PERMIT HAS BEEN ISSUED, CONTRACTOR SHALL ASSUME ALL RESPONSIBILITY TO THE ACCURACY OF THE PLANS AND ANY CHANGES MADE DURING CONSTRUCTION.



This document is property of Garman Homes Inc, and was prepared for their use only. The plans, elevations, illustrations, and other material contained within this set may not be reproduced, either in part or wholly, in any manner without the express written permission of Garman Homes, Inc. All right reserved and protected under federal law.

<b>Project Number</b>	Project Number
<b>Plan Number</b>	FP-1942

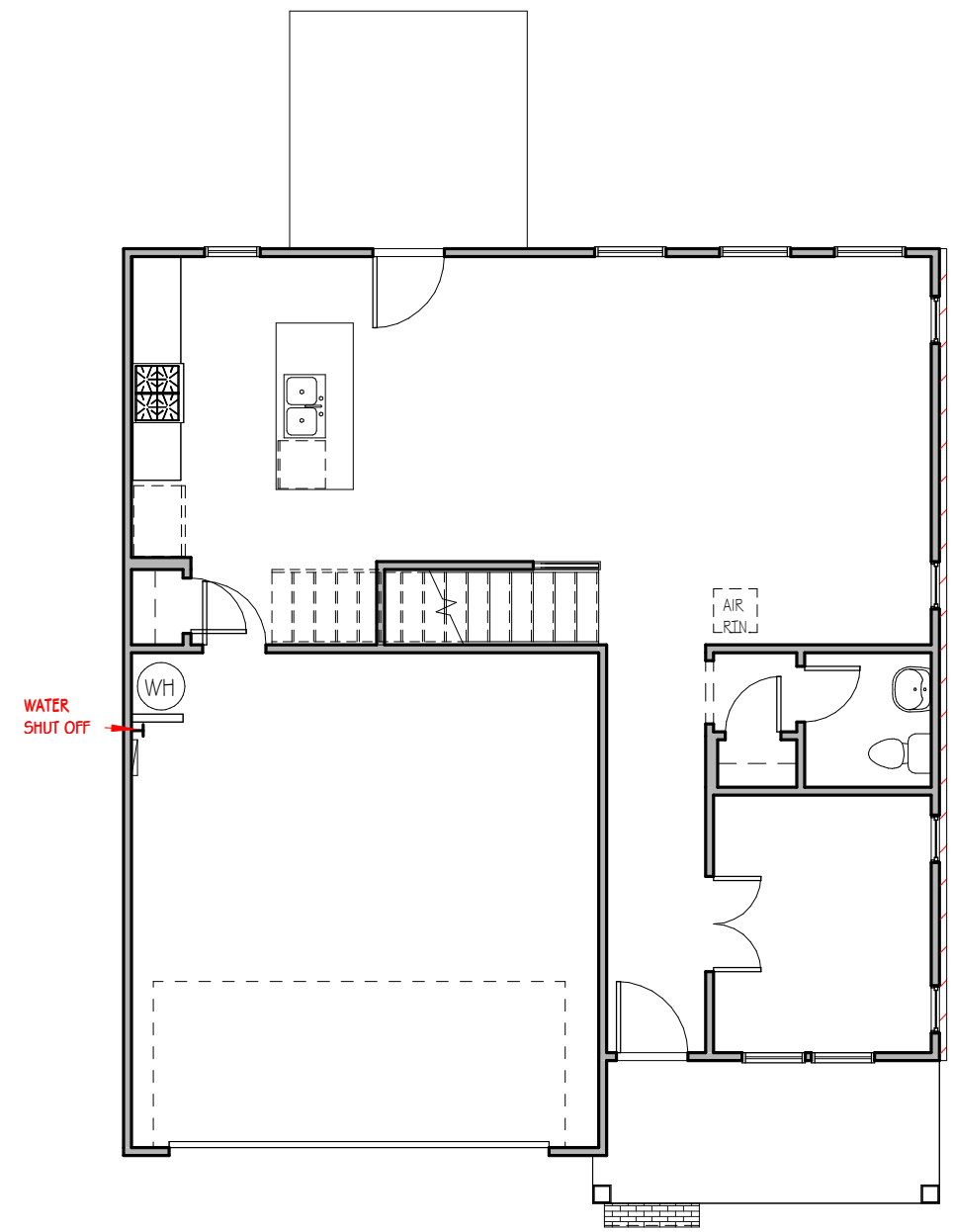

FIRST FLOOR MECHANICAL PLAN

1/8" = 1'-0"

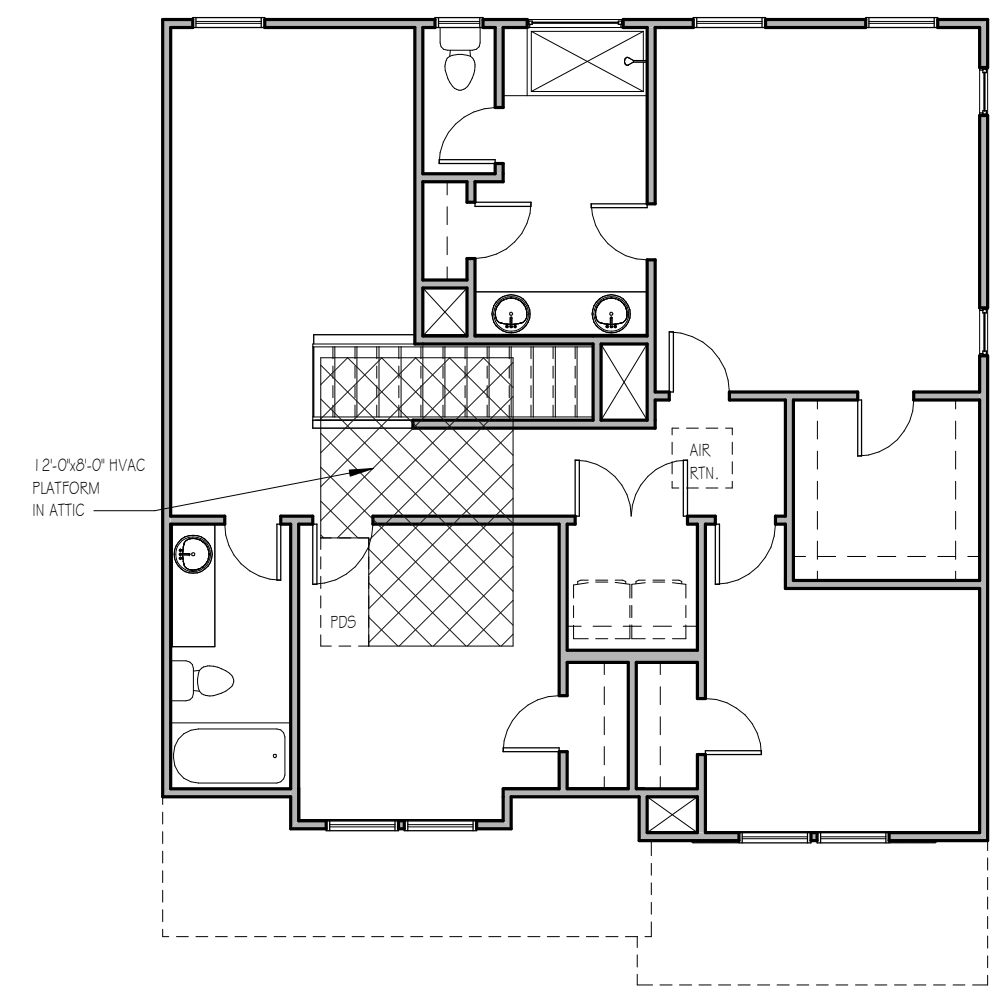

SECOND FLOOR MECHANICAL PLAN

1/8" = 1'-0"

**HONEYSUCKLE**  
SER ELEVATION A  
LOT 0155 SERENITY

<b>Drawn By</b>	MH
<b>Checked By</b>	CM
<b>Date Drawn</b>	4/8/20
<b>Revision Date</b>	7/1/20
	4/5/22
	10/26/22

Sheet

M



THE PURPOSE OF THESE DRAWINGS IS TO SHOW THE INTENT OF THE DESIGN AND CONSTRUCTION OF THIS HOME. CONTRACTOR SHOULD VERIFY ALL CONDITIONS AND DIMENSIONS PRIOR TO CONSTRUCTION. ONCE A PERMIT HAS BEEN ISSUED, CONTRACTOR SHALL ASSUME ALL RESPONSIBILITY TO THE ACCURACY OF THE PLANS AND ANY CHANGES MADE DURING CONSTRUCTION.



This document is property of Garman Homes Inc, and was prepared for their use only. The plans, elevations, illustrations, and other material contained within this set may not be reproduced, either in part or wholly, in any manner without the express written permission of Garman Homes, Inc. All right reserved and protected under federal law.

<b>Project Number</b>	Project Number
<b>Plan Number</b>	FP-1942

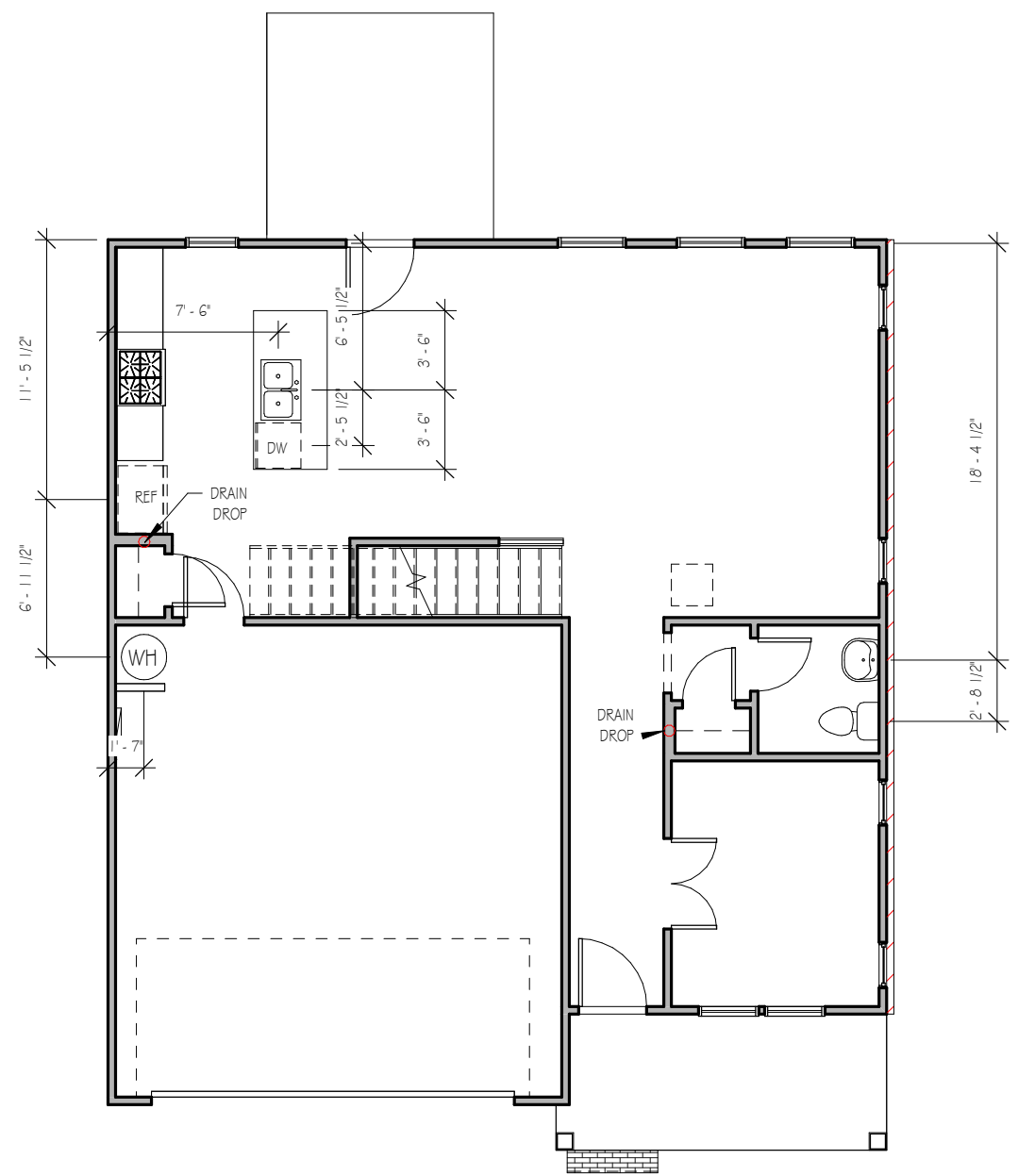

**FIRST FLOOR PLUMBING**

1/8" = 1'-0"

**HONEYSUCKLE**  
SER ELEVATION A  
LOT 0155 SERENITY

<b>Drawn By</b>	MH
<b>Checked By</b>	CM
<b>Date Drawn</b>	4/8/20
<b>Revision Date</b>	7/1/20
	4/5/22
	10/26/22

Sheet

**P**

THE PURPOSE OF THESE DRAWINGS IS TO SHOW THE INTENT OF THE DESIGN AND CONSTRUCTION OF THIS HOME. CONTRACTOR SHOULD VERIFY ALL CONDITIONS AND DIMENSIONS PRIOR TO CONSTRUCTION. ONCE A PERMIT HAS BEEN ISSUED, CONTRACTOR SHALL ASSUME ALL RESPONSIBILITY TO THE ACCURACY OF THE PLANS AND ANY CHANGES MADE DURING CONSTRUCTION.



This document is property of Garman Homes Inc. and was prepared for their use only. The plans, elevations, illustrations, and other material contained within this set may not be reproduced, either in part or wholly, in any manner without the express written permission of Garman Homes, Inc. All right reserved and protected under federal law.

Project Number \_\_\_\_\_  
 Project Number \_\_\_\_\_  
 Plan Number \_\_\_\_\_

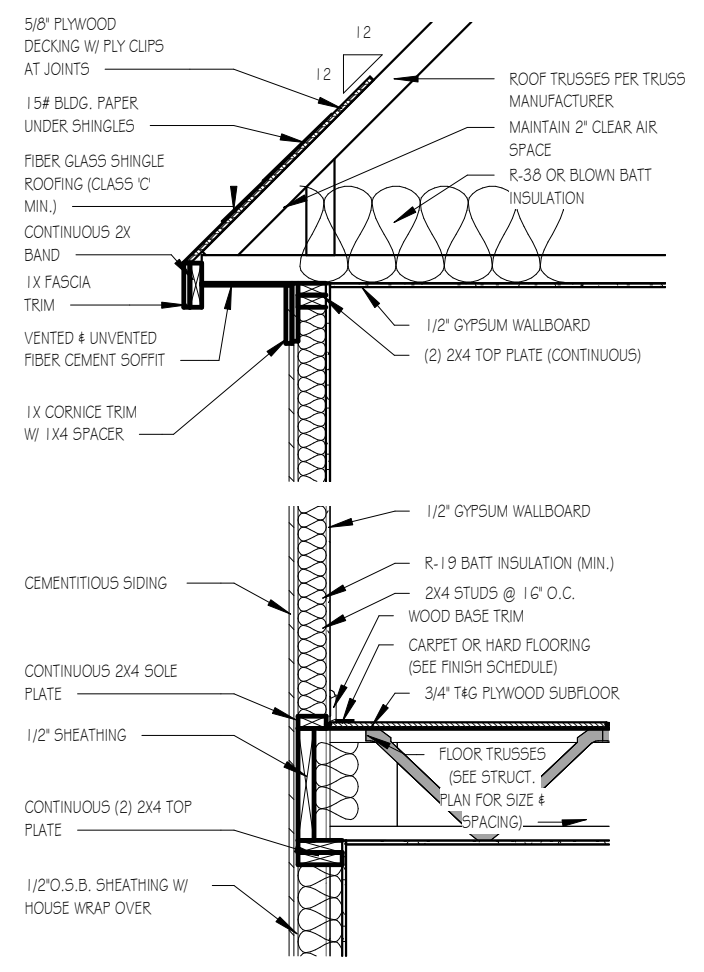

**TWO-STORY WALL SECTION**

1/2" = 1'-0"

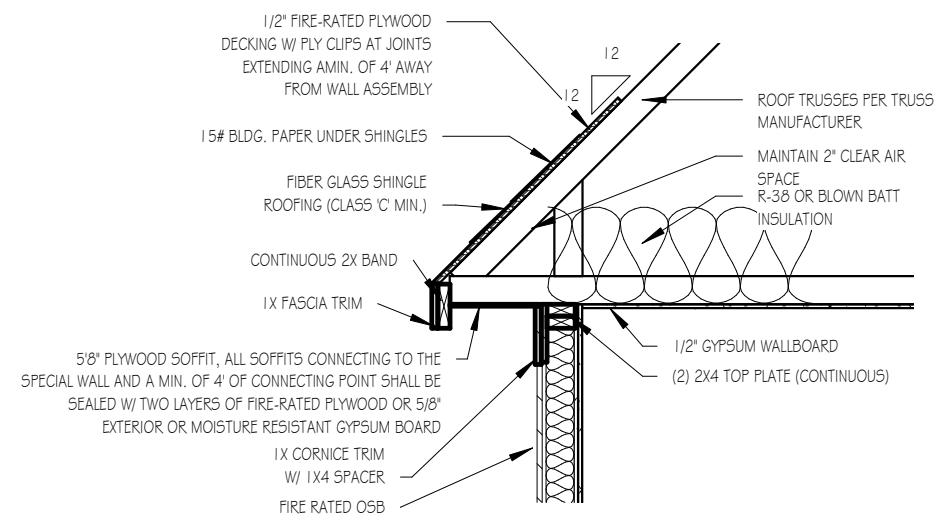

**ROOF DETAIL SPECIAL FIRE-RATED WALLS**

1/2" = 1'-0"

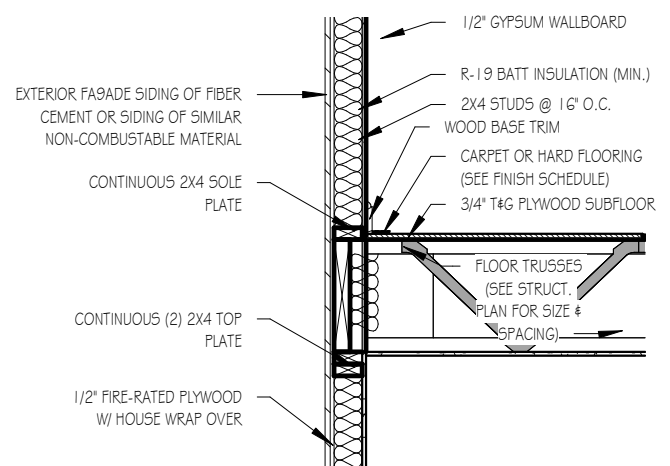

**SECOND FLOOR SECTION - SPECIAL FIRE-RATED WALLS**

1/2" = 1'-0"

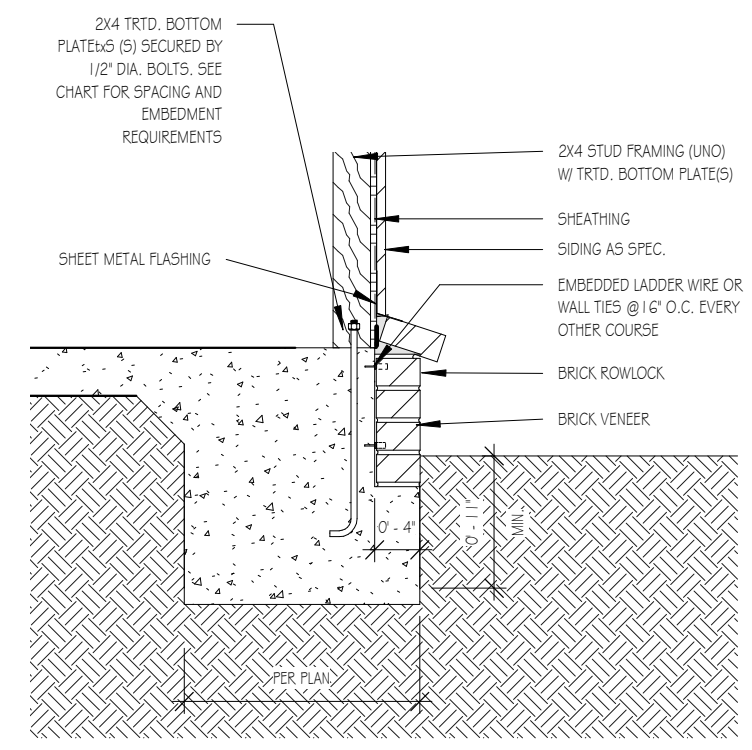

**TYPICAL SLAB W/ BRICK VENEER**

3/4" = 1'-0"

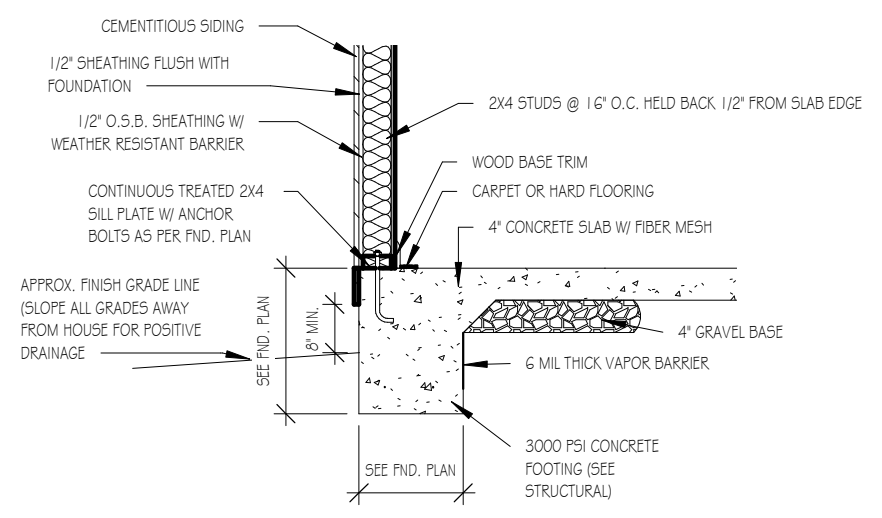

**FOUNDATION DETAIL - SLAB**

1/2" = 1'-0"

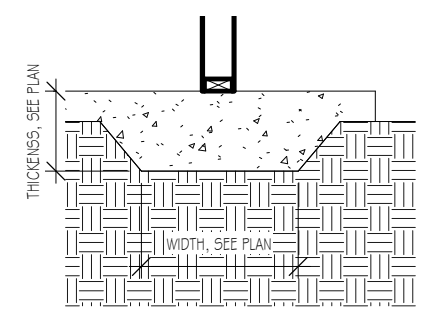

**LUG FOOTING**

1/2" = 1'-0"

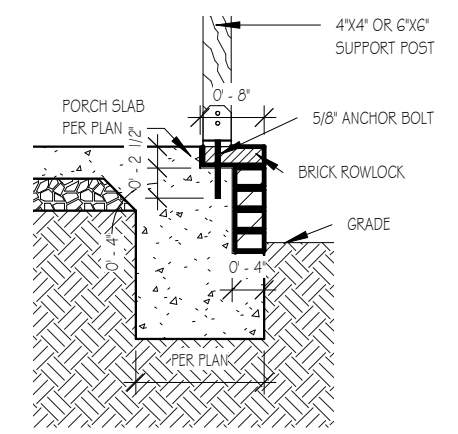

**FRONT PORCH COLUMNS SUPPORT ATTACHMENT**

1/2" = 1'-0"

TYPICAL DETAIL SHEET  
SERENITY COLLECTION

Drawn By	MMH
Checked By	JM
Date Drawn	10/28/20
Revision Date	9/14/22
	9/20/22

Sheet  
**D**



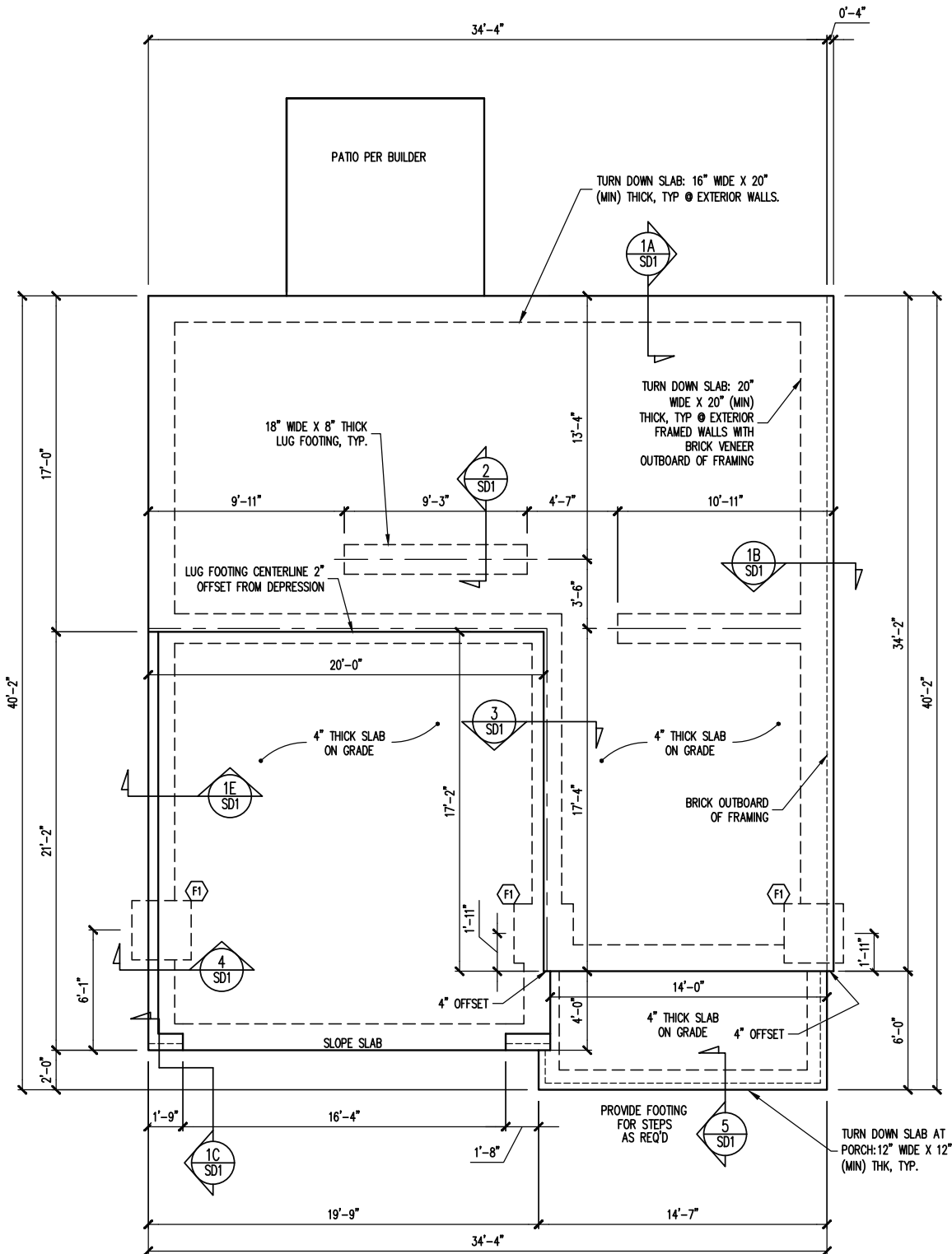
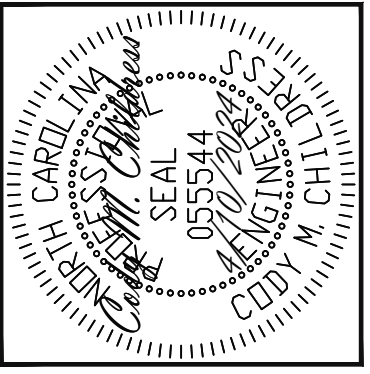

FOUNDATION PLAN  
ELEVATION A-BRICK RIGHT  
1/8" = 1'-0"

FOUNDATION SCHEDULE	
F1	ENLARGE FOOTING TO 36" SQ. X 12" THK
NOTES: -HEIGHT AND BACKFILL LIMITATIONS FOR FOUNDATION WALLS ARE TO BE GOVERNED BY THE NCSBC, LATEST EDITION.	

ENGINEERING SEAL VALID FOR 1 YEAR ONLY.  
The structural design of this plan is the property of Engineering Tech Associates, P.A. These plans are for the client listed only. Engineering Tech Associates, P.A. assumes no liability for these plans if construction or permitting takes place more than 1 year after the seal date without written permission from Engineering Tech Associates, P.A.

**Engineering Tech**  
STRUCTURAL ENGINEERS  
License No. C-3870  
318 W Millbrook Rd Suite 201  
Raleigh, North Carolina 27609  
Phone (919) 844-1661  
ASSOCIATES, P.A.

SCOPE	FRESH PAINT
LOC	STRUCTURAL ADDENDUM
PLAN	TBD
	MASTER
	HONEYSUCKLE

ENG: CMC  
DATE: 4/10/2024

PROJECT NO.  
24-30-029

SHEET NO.  
S5A

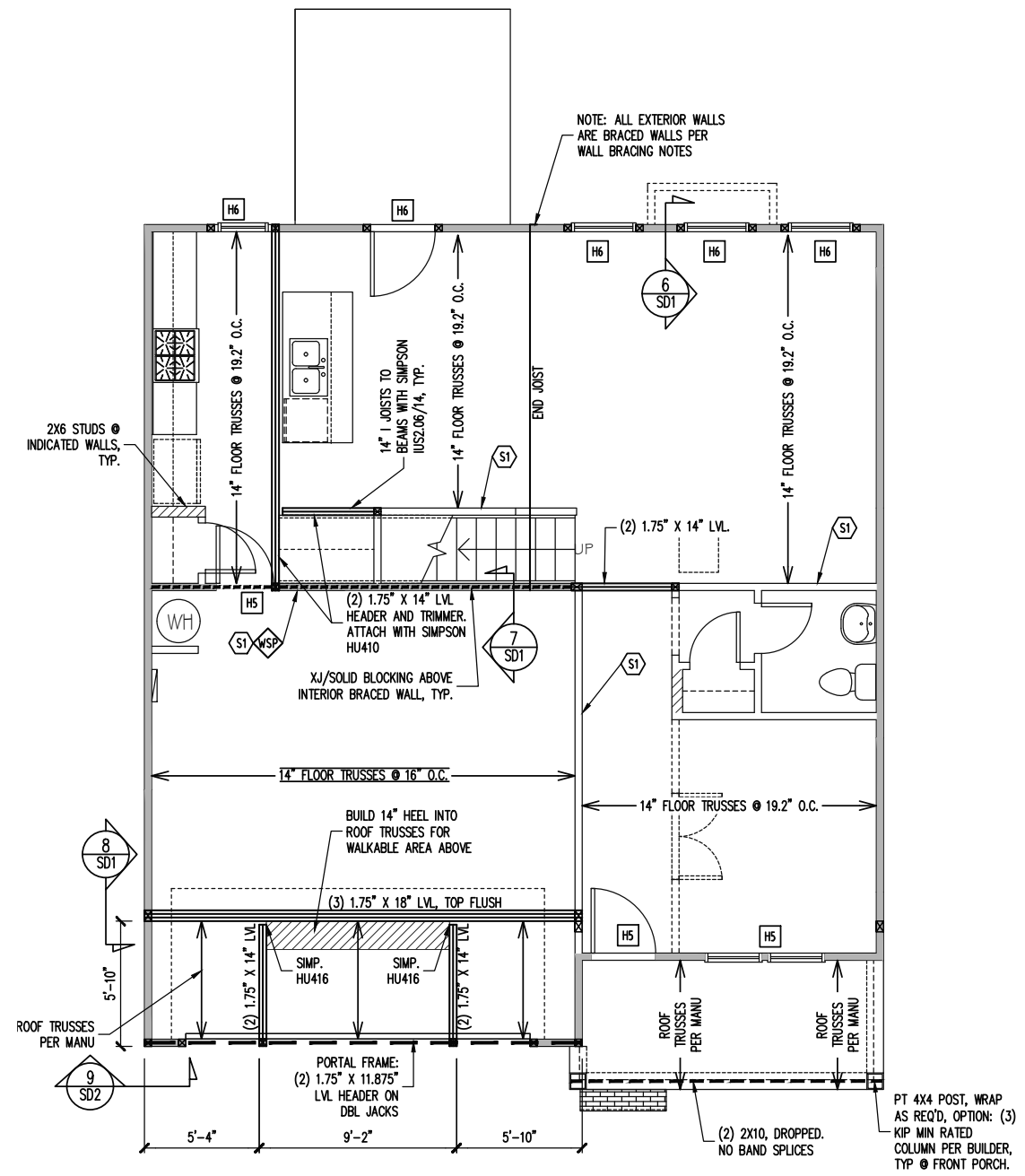
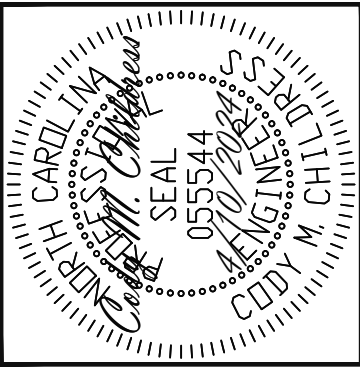

**1ST FLOOR FRAMING PLAN  
ELEVATION A**  
WALLS AND CEILING  
1/8" = 1'-0"

**FRAMING SCHEDULE**  
S1 INTERIOR LOAD BEARING WALL: SECURE TO THICKENED SLAB BELOW WITH 1/2"Ø RED HEADER ANCHOR (OR EQUAL) @ 6'-0" O.C., 12" MAX FROM ENDS / CORNERS OF WALL, 7" MIN EMBEDMENT INTO SLAB BELOW.

**JOIST SUBSTITUTION**  
14" FLOOR TRUSSES PERMITTED TO BE SUBSTITUTED WITH 14" I-JOISTS.  
MAINTAIN MINIMUM SPACING AS CALLED OUT ON PLANS.  
SIMP. IUS/ITS3.56/14 HANGERS TO BE SUBSTITUTED WITH SIMP. IUS/ITS2.06/14 HANGER WHEN I-JOISTS HAVE BEEN INSTALLED.

**CONSTRUCTION SPECIFICATIONS**  
INSTANT REFERENCES  
REFER TO THE CONSTRUCTION SPECIFICATIONS SECTIONS FOR THE FOLLOWING INFORMATION:  
PART 1.01: CURRENT GOVERNING CODE  
PART 14: STUD SUPPORT FOR BEAMS  
PART 17: KING STUDS FOR EXTERIOR WALLS  
SEE DETAIL / CONSTRUCTION SPECIFICATIONS SHEETS FOR I-JOISTS ALLOWABLE SUBSTITUTIONS

**WALL BRACING**  
SHADED WALLS:  
ALL EXTERIOR STUD WALLS, EXTERIOR SIDE, ARE TO BE CONTINUOUSLY SHEATHED WITH 7/16 APA RATED OSB NAILED TO STUDS WITH 8d NAILS @ 6" O.C. AT PANEL EDGES, 12" O.C. IN PANEL FIELD.  
WSP - ONE SIDE OF INTERIOR WALL OR INSIDE OF EXTERIOR WALL WITH 3/8" MIN. THICKNESS WOOD STRUCTURAL PANELING. ATTACH WSP TO STUD WALL WITH 8d NAILS @ 4" O.C. AT PANEL EDGES, 8" O.C. IN PANEL FIELD.  
NOTES:  
PROVIDED CONTINUOUS SHEATHING = 145' MIN.  
REFERENCE PART 16.02 OF CONSTRUCTION SPECIFICATIONS FOR GENERAL WIND BRACING INFORMATION.

**HEADER SCHEDULE**  
H1 SINGLE 2X4 TURNED FLAT (A)  
H2 (2) 2X4'S ON SINGLE JACKS (B)  
H3 (2) 2X10'S ON SINGLE JACKS (C)  
H4 (2) 1.75" X 9.25" LVL'S ON DBL JACKS  
H5 (2) 2X8'S ON SINGLE JACKS  
H6 (2) 2X8'S ON DOUBLE JACKS  
(A) TYPICAL FOR INTERIOR NON LOAD BEARING WALLS ONLY, ROUGH OPENING 38" MAX.  
(B) TYPICAL FOR INTERIOR NON LOAD BEARING WALLS ONLY, ROUGH OPNG 38" TO 74" MAX.  
(C) TYPICAL FOR ALL CONDITIONS NOT LISTED IN (A) OR (B) UNO.  
NOTES:  
-HEADERS IN NON LOAD BEARING INTERIOR WALLS ARE NOT LABELED.

**FOUNDATION SCHEDULE**  
F1 ENLARGE FOOTING TO 36" SQ. X 12" THK  
NOTES:  
-HEIGHT AND BACKFILL LIMITATIONS FOR FOUNDATION WALLS ARE TO BE GOVERNED BY THE NCSBC, LATEST EDITION.

ENGINEERING SEAL VALID FOR 1 YEAR ONLY.  
The structural design of this plan is the property of Engineering Tech Associates, P.A. These plans are for the client listed only. Engineering Tech Associates, P.A. assumes no liability for these plans if construction or permitting takes place more than 1 year after the seal date without written permission from Engineering Tech Associates, P.A.

**Engineering Tech**  
STRUCTURAL ENGINEERS  
License No. C-3870  
318 W Millbrook Rd Suite 201  
Raleigh, North Carolina 27609  
Phone (919) 844-1661  
ASSOCIATES, P.A.

FRESH PAINT	
SCOPE	STRUCTURAL ADDENDUM
LOC	TBD
PLAN	MASTER
	HONEYSUCKLE

ENG: CMC  
DATE: 4/10/2024

PROJECT NO.  
24-30-029

SHEET NO.  
S1A  
1 of 7

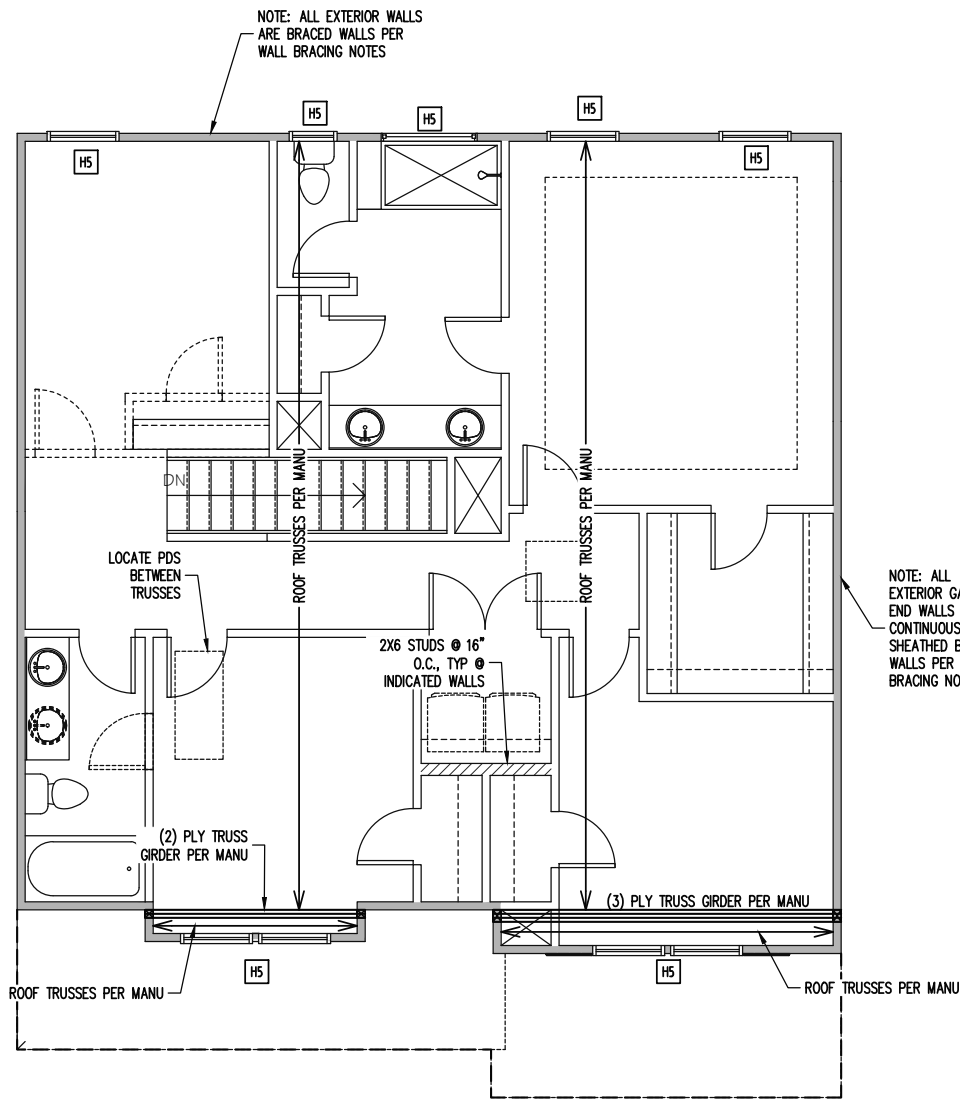

2ND FLOOR FRAMING PLAN  
ELEVATION A  
WALLS AND CEILING  
1/8" = 1'-0"

OPTIONAL SCREENED PORCH

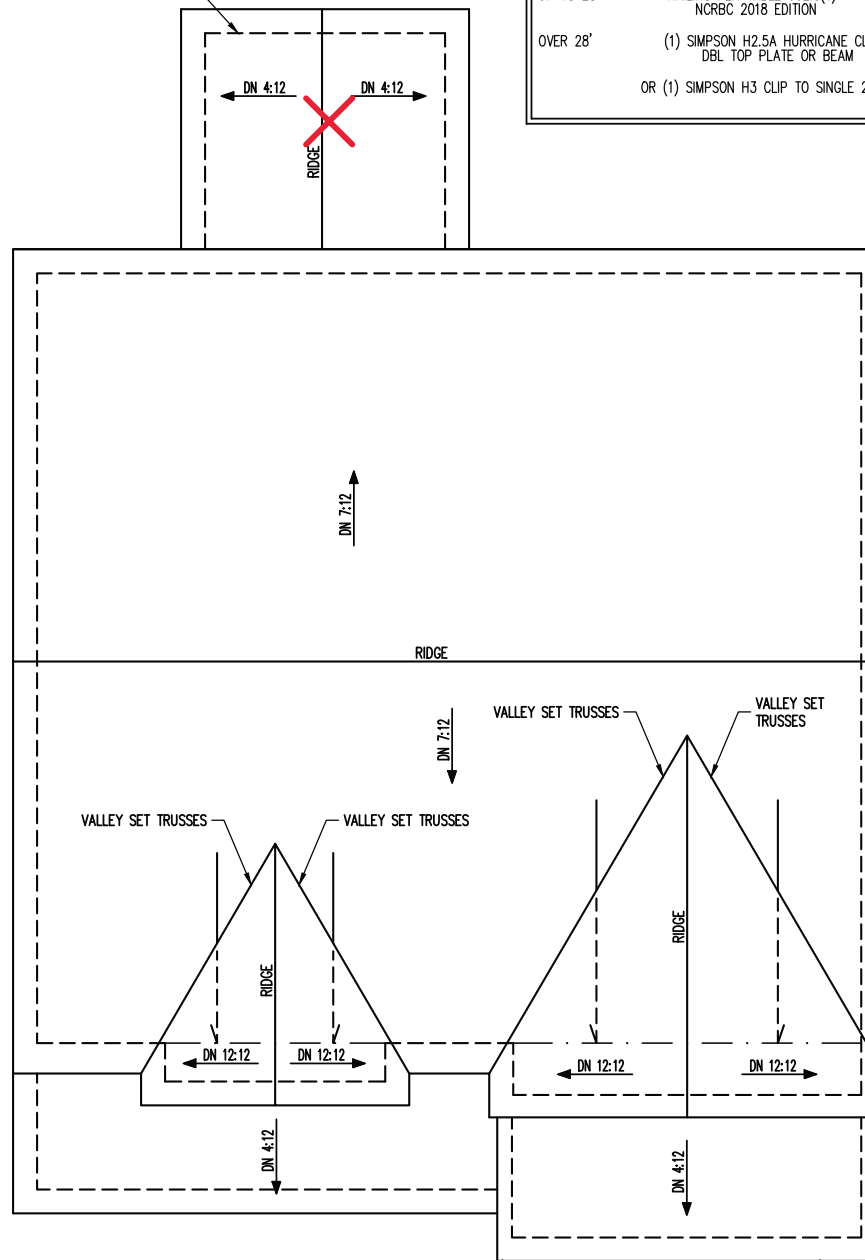

ROOF FRAMING PLAN  
ELEVATION A  
1/8" = 1'-0"

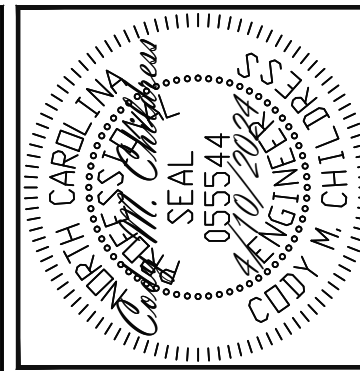

ENGINEERING SEAL VALID FOR 1 YEAR ONLY.  
The structural design of this plan is the property of Engineering Tech Associates, P.A. These plans are for the client listed only. Engineering Tech Associates, P.A. assumes no liability for these plans if construction or permitting takes place more than 1 year after the seal date without written permission from Engineering Tech Associates, P.A.

STRUCTURAL ENGINEERS  
License No. C-3870  
318 W Millbrook Rd Suite 201  
Raleigh, North Carolina 27609  
TECH ASSOCIATES, P.A.  
Phone (919) 844-1661

SCOPE	FRESH PAINT
LOC	STRUCTURAL ADDENDUM
PLAN	TBD MASTER HONEYSUCKLE

ENG: CMC  
DATE: 4/10/2024

PROJECT NO.  
24-30-029

SHEET NO.  
S2A  
2 of 7

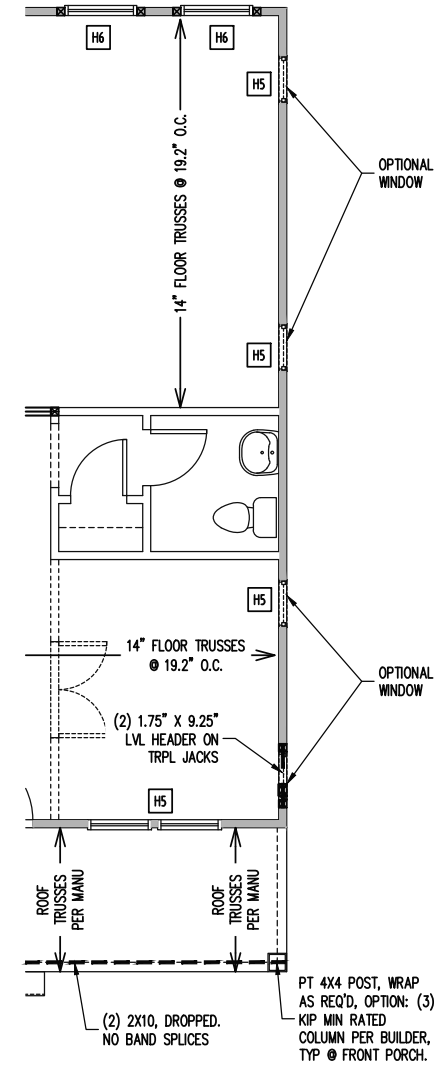

1ST FLOOR FRAMING PLAN  
 OPTIONAL WINDOWS  
 1/8" = 1'-0"

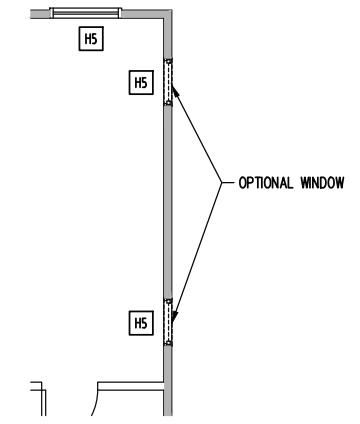

2ND FLOOR FRAMING PLAN  
 OPTIONAL WINDOWS, PRIMARY SUITE  
 1/8" = 1'-0"

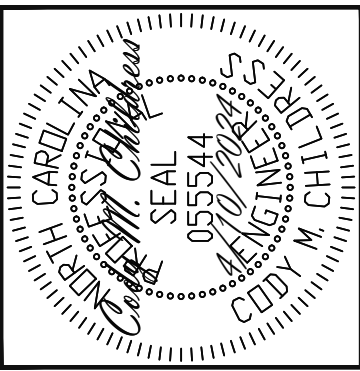

ENGINEERING SEAL VALID FOR 1 YEAR ONLY.  
 The structural design of this plan is the property of Engineering Tech Associates, P.A. These plans are for the client listed only. Engineering Tech Associates, P.A. assumes no liability for these plans if construction or permitting takes place more than 1 year after the seal date without written permission from Engineering Tech Associates, P.A.

**Engineering Tech**  
 ASSOCIATES, P.A.  
 STRUCTURAL ENGINEERS  
 License No. C-3870  
 318 W Millbrook Rd Suite 201  
 Raleigh, North Carolina 27609  
 Phone (919) 844-1661

SCOPE	FRESH PAINT
LOC	STRUCTURAL ADDENDUM
PLAN	TBD
	MASTER
	HONEYSUCKLE

ENG: CMC  
 DATE: 4/10/2024

PROJECT NO.  
 24-30-029

SHEET NO.  
 S4A

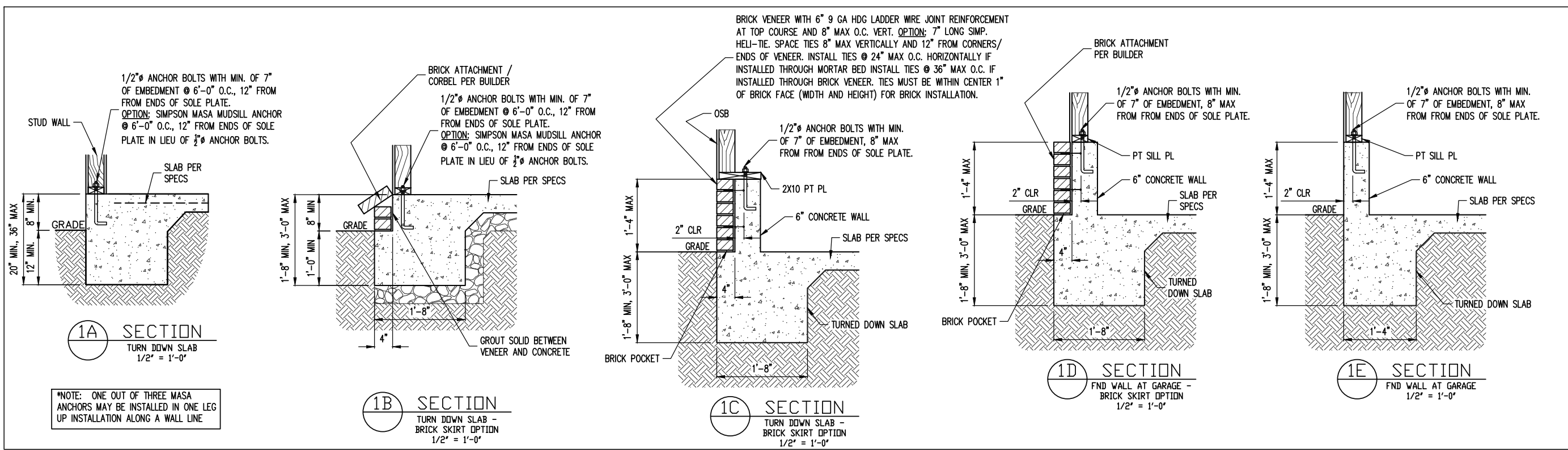

\*NOTE: ONE OUT OF THREE MASA ANCHORS MAY BE INSTALLED IN ONE LEG UP INSTALLATION ALONG A WALL LINE

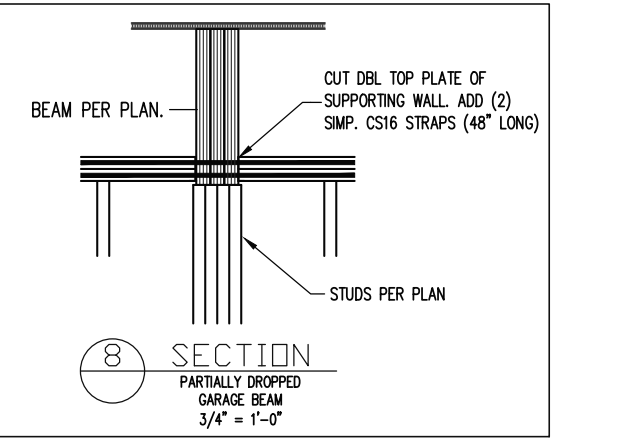
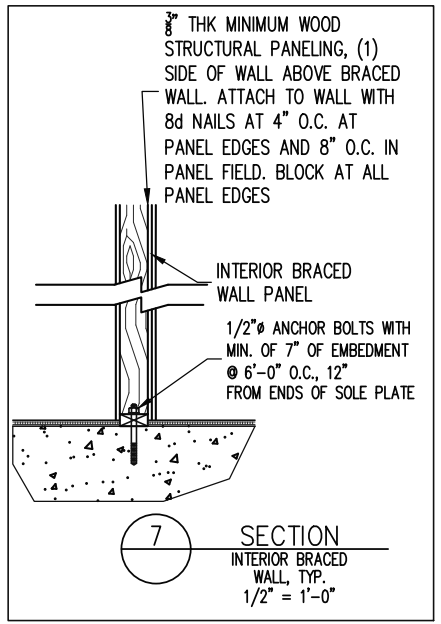
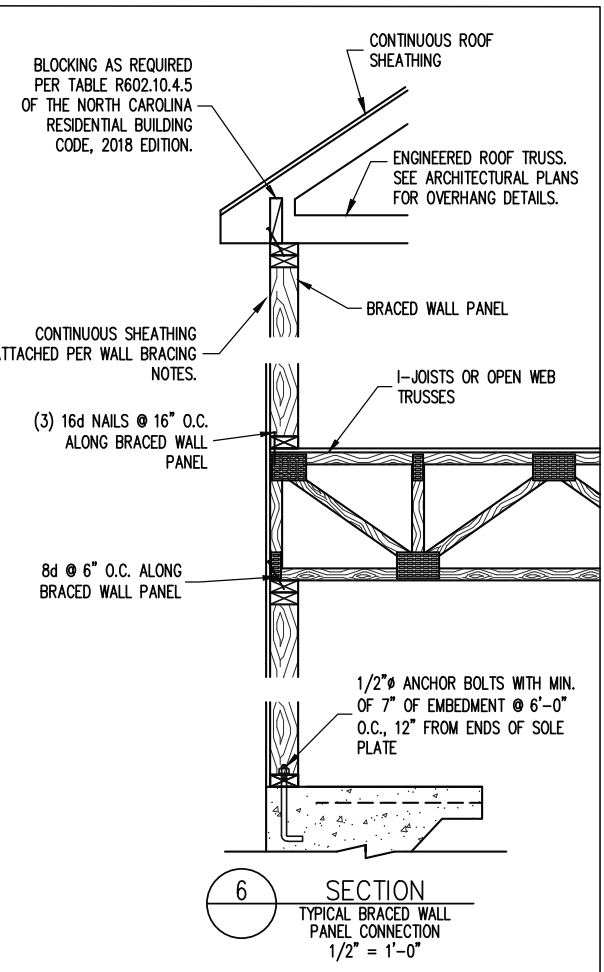
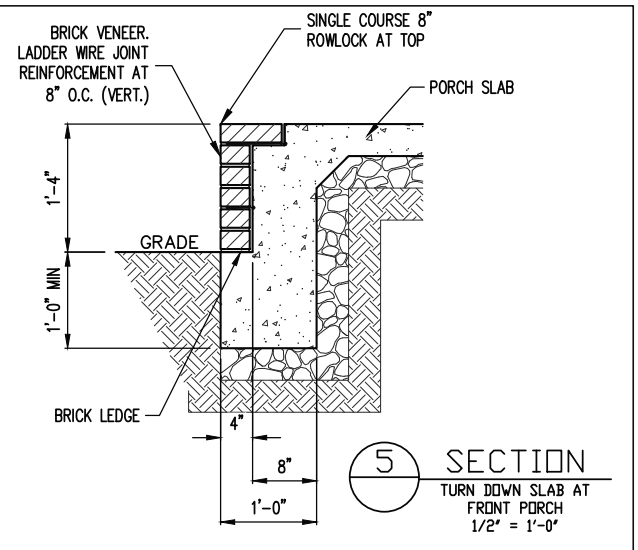
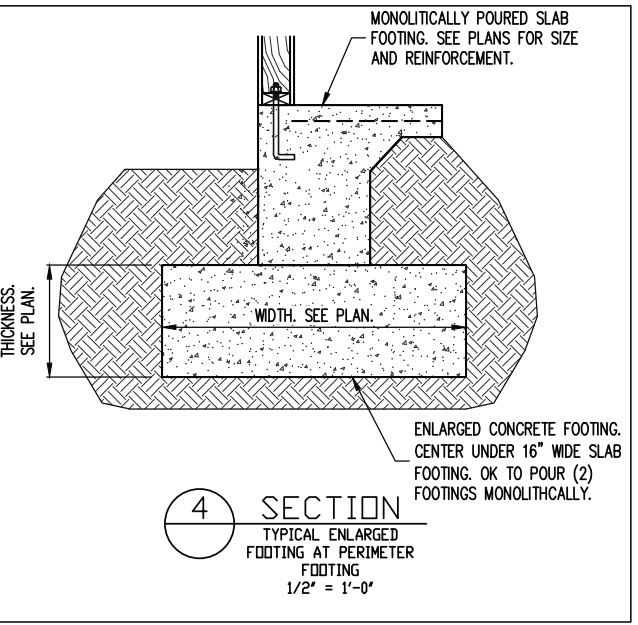
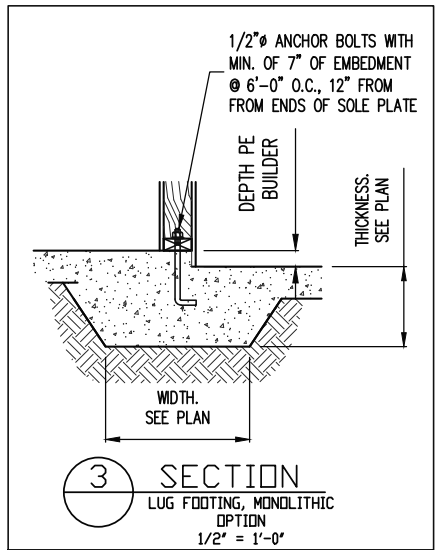
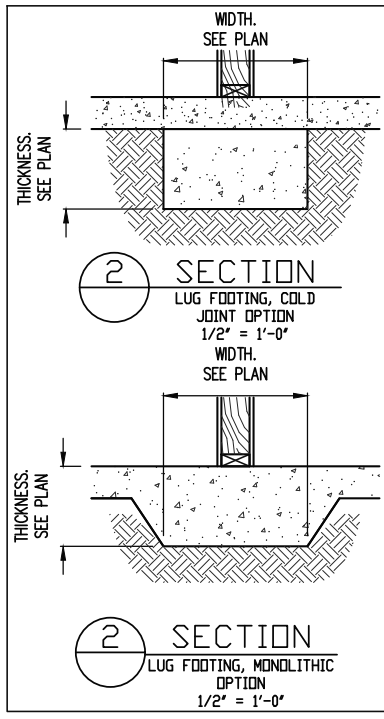
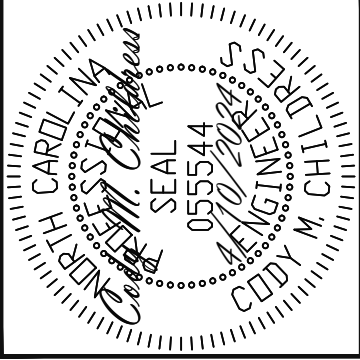

ENGINEERING SEAL VALID FOR 1 YEAR ONLY.  
The structural design of this plan is the property of Engineering Tech Associates, P.A. These plans are for the client listed only. Engineering Tech Associates, P.A. assumes no liability for these plans if construction or permitting takes place more than 1 year after the seal date without written permission from Engineering Tech Associates, P.A.

STRUCTURAL ENGINEERS  
License No. C-3870  
318 W Millbrook Rd Suite 201  
Raleigh, North Carolina 27609  
Phone (919) 844-1661

SCOPE	FRESH PAINT
LOC	STRUCTURAL ADDENDUM
PLAN	TBD
	MASTER
	HONEYSUCKLE

ENG: CMC  
DATE: 4/10/2024

PROJECT NO.  
24-30-029

SHEET NO.  
SD1

# CONSTRUCTION SPECIFICATIONS

## PART 1: GENERAL

- 1.01 CONSTRUCTION SHALL MEET THE REQUIREMENTS OF THE NORTH CAROLINA RESIDENTIAL CODE, 2018 EDITION.
- 1.02 DIMENSIONS SHOWN SHALL GOVERN OVER SCALE ON THESE DRAWINGS.
- 1.05 METHODS, PROCEDURES AND SEQUENCES OF CONSTRUCTION ARE THE RESPONSIBILITY OF THE CONTRACTOR, WHO SHALL TAKE ALL NECESSARY PRECAUTIONS TO MAINTAIN AND INSURE THE INTEGRITY OF THE STRUCTURE AT ALL STAGES OF CONSTRUCTION.

## PART 2: DESIGN LOADS

2.01 DESIGN LOADS SHALL CONFORM WITH THE TABLE BELOW:

USE	LIVE LOAD (PSF)	DEAD LOAD (PSF)
BALCONIES, DECKS, ATTICS WITH FIXED STAIR ACCESS, DWELLING UNITS INCLUDING ATTICS WITH FIXED STAIR ACCESS, STAIRS, FIRE ESCAPES	40	10
GARAGES (PASSENGER CARS ONLY)	50	--
ATTICS (NO STORAGE, LESS THAN 5' HEADROOM)	10	10
ATTICS (WITH STORAGE)	20	10
ROOF	20	10 (15 FOR VAULTS)

NOTES: - INDIVIDUAL STAIR TREADS ARE TO BE DESIGNED FOR THE UNIFORMLY DISTRIBUTED LIVE LOAD OF 40 PSF OR A 300 LB. CONCENTRATED LOAD ACTING OVER AN AREA OF 4 SQ. WHICHEVER PRODUCES THE GREATER STRESS.  
- BUILDER TO VERIFY DEAD LOAD DOES NOT EXCEED 10 PSF WHEN HEAVY FLOOR OR ROOF FINISHES SUCH AS TILE OR SLATE ARE UTILIZED. NOTIFY ENGINEERING UNDER THESE CONDITIONS

- 2.02 INTERIOR WALLS: 5 PSF LATERAL.
- 2.03 BASIC WIND DESIGN VELOCITY OF 120 MPH.
- 2.04 SOIL BEARING CAPACITY 2000 PSF (PRESUMPTIVE).

## PART 5: CONCRETE AND SLABS ON GRADE

5.01 CAST IN PLACE CONCRETE SHALL BE OF NORMAL WEIGHT, 6% AIR ENTRAINMENT, AND SHALL HAVE A MINIMUM COMPRESSIVE STRENGTH OF 3000 PSI AT 28 DAYS TYP UNO. ALL CONCRETE, INCLUDING CONCRETE FOR FOOTINGS, IS TO BE CAST IN PLACE, TYP UNO.

5.03 SLABS ON GRADE, IF ANY, SHALL CONTAIN SYNTHETIC POLYPROPYLENE FIBRILLATED MICRO FIBERS, FIBER LENGTH 1 1/2", DOSAGE RATE 1 1/2 LBS/CU YD. SLAB TO BE PLACED ON A 6 MIL VAPOR BARRIER ON 2" MIN GRANULAR FILL ON SOIL WITH 90% MIN STANDARD PROCTOR DENSITY. VAPOR BARRIER MAY BE OMITTED FOR SLABS NOT IN ENCLOSED AREAS

## PART 7: MASONRY

- 7.03 MORTAR SHALL BE TYPE S. MORTAR AND GROUT SHALL CONFORM TO ASTM C476, MIN COMPRESSIVE STRENGTH OF 2000 PSI.
- 7.05 LADDER WIRE REINFORCEMENT SHALL CONFORM TO ASTM A951. 6" MIN LAPS FOR CONTINUOUS WALL APPLICATIONS

## PART 8: BOLTS AND LAG SCREWS

8.03 ANCHOR RODS AND BOLTS SHALL CONFORM TO ASTM F1554-15 GRADE 36 UNO. BENT ANCHOR BOLTS SHALL HAVE A 2" MIN HOOK UNO

## PART 9: DRIVEN FASTENERS

9.01 NAILS, SPIKES AND STAPLES SHALL CONFORM TO ASTM F 1667- 05. NAILS ARE TO BE COMMON WIRE OR BOX

## PART 10: DIMENSIONAL LUMBER

10.01 SOLID SAWN WOOD FRAMING DESIGN IS BASED ON NO. 2 SPRUCE PINE FIR OR SYP #2 FOR JOISTS, RAFTERS, GIRDERS, BEAMS, STUDS, ETC.

## PART 11: ENGINEERED LUMBER

11.01 LVL OR PSL MINIMUM ALLOWABLE DESIGN STRESSES ARE AS FOLLOWS:  
E= 1.9 X 10<sup>6</sup> PSI, Fb = 2600 PSI, Fv = 285 PSI, Fc = 750 PSI  
LSL MINIMUM ALLOWABLE DESIGN STRESSES ARE AS FOLLOWS:  
E= 1.3 X 10<sup>6</sup> PSI, Fb = 1700 PSI, Fv = 400 PSI, Fc = 680 PSI

11.02 LVL OR PSL MEMBERS MAY BE RIPPED FROM DEEPER MEMBERS TO MATCH THE MEMBER DEPTH SPECIFIED IN THE PLANS

## PART 12: PRESSURE TREATED LUMBER

12.01 LUMBER IN CONTACT WITH THE GROUND, CONCRETE OR MASONRY SHALL BE PRESSURE TREATED IN ACCORDANCE WITH AWPA STANDARD C-15. ALL OTHER EXPOSED LUMBER SHALL BE TREATED IN ACCORDANCE WITH AWPA STANDARD C-2 OR BY ANY METHOD GIVING EQUAL PROTECTION. THE BUILDING CODE OFFICE MAY ALSO APPROVE A NATURAL DECAY RESISTANT WOOD PER SECTION 19-6(A)

## PART 14: STUD SUPPORTS FOR BEAMS

14.01 STEEL, ENGINEERED LUMBER, AND FLITCH PLATE BEAMS BEARING ON A STUD WALL SHALL BEAR AS FOLLOWS:

1-WHEN THE BEAM IS PERPENDICULAR TO, OR SKEWED RELATIVE TO THE WALL, THE BEAM SHALL BEAR FULL WIDTH ON THE SUPPORTING WALL INDICATED AND SHALL BE SUPPORTED BY A MINIMUM OF THREE GANGED STUDS, OR A GANGED STUD COLUMN WITH A NUMBER OF STUDS SUCH THAT THE STUD COLUMN IS AT LEAST AS WIDE AS THE TRUE WIDTH OF THE BEAM BEING SUPPORTED, WHICHEVER IS GREATER, TYP UNO. FOR THE SKEWED CONDITION PARTICULAR CARE SHALL BE TAKEN TO ENSURE STUD COLUMN IS CENTERED ON THE BEAM

2-BEAMS BEARING ONTO THE END OF A STUD WALL PARALLEL TO THE BEAM SHALL BEAR A MINIMUM OF 4 1/2" ONTO THE WALL AND BE SUPPORTED BY A TRPL STUD GANGED COLUMN TYP UNO.

## 14.02 DIMENSIONAL LUMBER BEAMS BEARING ON A STUD WALL SHALL BEAR AS FOLLOWS:

1-WHEN THE BEAM IS PERPENDICULAR TO, OR SKEWED RELATIVE TO THE WALL, THE BEAM SHALL BEAR FULL WIDTH ON THE SUPPORTING WALL INDICATED (LESS 1 1/2" TO ALLOW FOR A CONTINUOUS RIM JOIST WHERE APPLICABLE) AND SHALL BE SUPPORTED BY A GANGED STUD COLUMN THE SAME WIDTH AS THE BEAM TYP UNO. (E.G. A TRIPLE 2X10 IS TO BE SUPPORTED BY (3) STUDS). FOR THE SKEWED CONDITION PARTICULAR CARE SHALL BE TAKEN TO ENSURE STUD COLUMN IS CENTERED ON THE BEAM

2-BEAMS BEARING ONTO THE END OF A STUD WALL PARALLEL TO THE BEAM SHALL BEAR A MINIMUM OF 3" ONTO THE WALL AND BE SUPPORTED BY A DBL STUD GANGED COLUMN TYP UNO.

14.03 EXTRA JOISTS BEARING ON A STUD WALL PERPENDICULAR TO OR SKEWED RELATIVE TO THE BEAM SHALL BE SUPPORTED BY ONE ADDITIONAL STUD.

14.04 STUDS THAT ARE GANGED TO FORM A COLUMN SHALL HAVE ADJACENT STUDS WITHIN THE COLUMN NAILED TOGETHER WITH ONE ROW OF 10d NAILS AT 8" O.C. (TWO ROWS OF 10d NAILS @ 8" O.C., 3" APART, FOR 2X8 OR 2X10 STUDS) ALL COLUMNS SHALL BE CONTINUOUS DOWN TO THE FOUNDATION OR OTHER PROPERLY DESIGNED STRUCTURAL ELEMENT SUCH AS A BEAM. COLUMNS TRANSFERRING LOADS THROUGH FLOOR LEVELS SHALL BE SOLIDLY BLOCKED FOR THE FULL WIDTH OF THE STUD COLUMN WITHIN THE CAVITY FORMED BY THE FLOOR JOISTS.

## PART 15: NAILING OF MULTI PLY WOOD BEAMS

15.01 SOLID SAWN LUMBER JOISTS THAT ARE GANGED TO FORM A BEAM SHALL HAVE ADJACENT MEMBERS IN THE BEAM NAILED TOGETHER WITH THREE ROWS OF 10d NAILS @ 16" O.C. FOR 2X10 OR LARGER, TWO ROWS OF 10d NAILS @ 16" O.C. FOR 2X8, ONE ROW OF 10d NAILS @ 16" O.C. FOR 2X6 OR SMALLER. STAGGER ROWS 5" MIN.

15.02 LVL MEMBERS THAT ARE GANGED TO FORM A BEAM SHALL HAVE ADJACENT MEMBERS IN THE BEAM FASTENED TOGETHER PER MANUFACTURERS RECOMMENDATIONS, TYP UNO

## PART 16: WALL FRAMING AND BRACING

16.01 STUD WALLS SHALL CONSIST OF 2X4 STUDS SPACED AT 16" O.C. UNO. STUDS SHALL BE CONTINUOUS FROM SOLE PLATE AT FLOOR TO DOUBLE TOP PLATE AT THE CEILING OR ROOF. NO INTERMEDIATE BANDS OR PLATES SHALL CAUSE DISCONTINUITIES IN A STUD WALL EXCEPT AS REQUIRED FOR DOOR OR WINDOW OPENINGS. THE KING STUDS FOR SUCH OPENINGS SHALL BE CONTINUOUS, TYP UNO.  
MAX ALLOWABLE WALL HEIGHTS FOR EXTERIOR STUD WALLS, WITH SOLE PLATE AND DBL TOP PLATE AND 7/16" OSB EXTERIOR BRACING AND ROW OF 2X4 / 2X6 PURLINS AT 8' HEIGHT (AND AT 16' HEIGHT FOR TALL WALLS), TYP UNO:

16.02 FOR WALL BRACING THE FOLLOWING SHALL APPLY:  
-BLOCKING AT UNSUPPORTED PANEL EDGES IS REQUIRED TYP UNO.  
-WALL BRACING IS BY ENGINEERED DESIGN AND NOT PRESCRIPTIVE PER SECTION 602.10 OF THE 2018 NCRBC. CONTINUOUS SHEATHING HAS BEEN PROVIDED, ALONG WITH ALTERNATIVE METHODS TO INSURE THE MINIMUM INTENT OF SECTION 602.10 OF THE 2018 NCRBC HAS BEEN MET AND EXCEEDED.

-BRACED WALL PANELS SHALL BE FASTENED IN ACCORDANCE WITH TABLE 602.3(1) TO PROVIDE CONTINUOUS PANEL UPLIFT RESISTANCE AND COMPLIANCE WITH NCRBC R602.3.5 AND R602.11 UNLESS NOTED OTHERWISE ON STRUCTURAL PLANS.  
-MAY SUBSTITUTE WSP FOR GB

-SINGLE JOIST, CONTINUOUS RIM JOIST, OR BLOCKING OF EQUAL DEPTH IS REQUIRED ABOVE AND BELOW ALL BRACED WALLS. NAIL BLOCKING ABOVE WALL TO TOP PLATE WITH 16d TOE NAILS @ 6" O.C. NAIL SOLE PLATE OF BRACED WALL TO BLOCKING BELOW WITH (3) 16d NAILS @ 16" O.C. BLOCKING AT HORIZONTAL JOINTS IN BRACED WALL LINES ONLY REQUIRED AT SHADED WALLS, UNO.

## PART 17: KING STUDS

17.01 KING STUDS FOR OPENINGS IN EXTERIOR WALLS SHALL BE AS FOLLOWS:

MAX OPENING WIDTH	NUMBER OF KING STUDS				
	5'-0"	9'-0"	13'-0"	17'-0"	21'-0"
2X4	1	2	3	4	5
STUD SIZE	2X6	1	1	2	2
	2X8	1	1	1	2

## PART 18: SUBSTITUTIONS

18.01 MATERIAL OR MEMBER SIZE SUBSTITUTIONS OR PLAN DEVIATIONS REQUIRE THE WRITTEN AUTHORIZATION OF THE DESIGNERS. UNAUTHORIZED DEVIATIONS ARE THE SOLE RESPONSIBILITY OF THE CONTRACTOR.

## PART 19: OWNERSHIP OF STRUCTURAL DESIGN

19.01 THE STRUCTURAL DESIGN OF THIS PLAN IS THE PROPERTY OF ENGINEERING TECH ASSOCIATES (ETA). THESE PLANS ARE FOR THE ONE TIME USE AT THE LOCATION INDICATED AND FOR THE CLIENT LISTED. ETA ASSUMES NO LIABILITY FOR THESE PLANS IF THEY ARE REPRODUCED, IN WHOLE OR IN PART, FOR CONSTRUCTION AT ANY OTHER LOCATION WITHOUT WRITTEN PERMISSION FROM ETA

(2) CONT. 2X TOP PLATES, EXTEND EACH END INTO ADJACENT WALL. NAIL SPLICES WITH 8-16d NAILS PER SPLICE/LAP.

CONT. 2X PLATE WITH 10d NAILS AT 16" O.C. INTO HEADER/BREAM

7/16" O.S.B. OR 15/32" PLYWOOD EXTERIOR WALL SHEATHING AT UNSHADED AREAS (BEAM, INFILL WALL ABOVE BEAM, AND CENTER WALL). NAIL SHEATHING TO ALL SUPPORTS (STUDS, PLATES, BLOCKING, ETC.) WITH 8d NAILS AT 6" O.C. AT SHEET EDGES AND 12" O.C. IN THE FIELD.

WHERE FULL HEIGHT PANEL WIDTH EXCEEDS 16", PROVIDE ADDITIONAL STUDS AT 16" O.C. NAIL SHEATHING TO ALL STUDS WITH 8d NAILS AT 3" O.C.

FOR A PANEL SPLICE (IF NEEDED), PANEL EDGES SHALL OCCUR OVER AND BE NAILED TO COMMON BLOCKING AND OCCUR WITHIN MIDDLE 24" OF WALL HEIGHT. ONE ROW OF 3" O.C. NAILING IS REQUIRED IN EACH PANEL EDGE.

7/16" O.S.B. OR 15/32" PLYWOOD EXTERIOR WALL SHEATHING. AT SHADED AREAS NAIL SHEATHING TO ALL SUPPORTS (STUDS, PLATES, BLOCKING, ETC.) WITH 8d NAILS AT 3" O.C.

(2)2x STUD MIN. AT START AND END OF WALL SEGMENTS EACH SIDE OF OPENING. SEE PLANS FOR ADDITIONAL STUDS

2x4 P.T. PLATE WITH TWO 1/2" DIA x 7" EMBED ANCHOR BOLTS WITH A 3/16"x2"x2" PLATE WASHERS OR ADDITIONAL HOLDOWN PER PLANS. OPTION: (2) 5/8" DIA. THREADED RODS INSTALLED PER SECTION R602.10.4.3 OF THE NCRBC, LATEST EDITION.

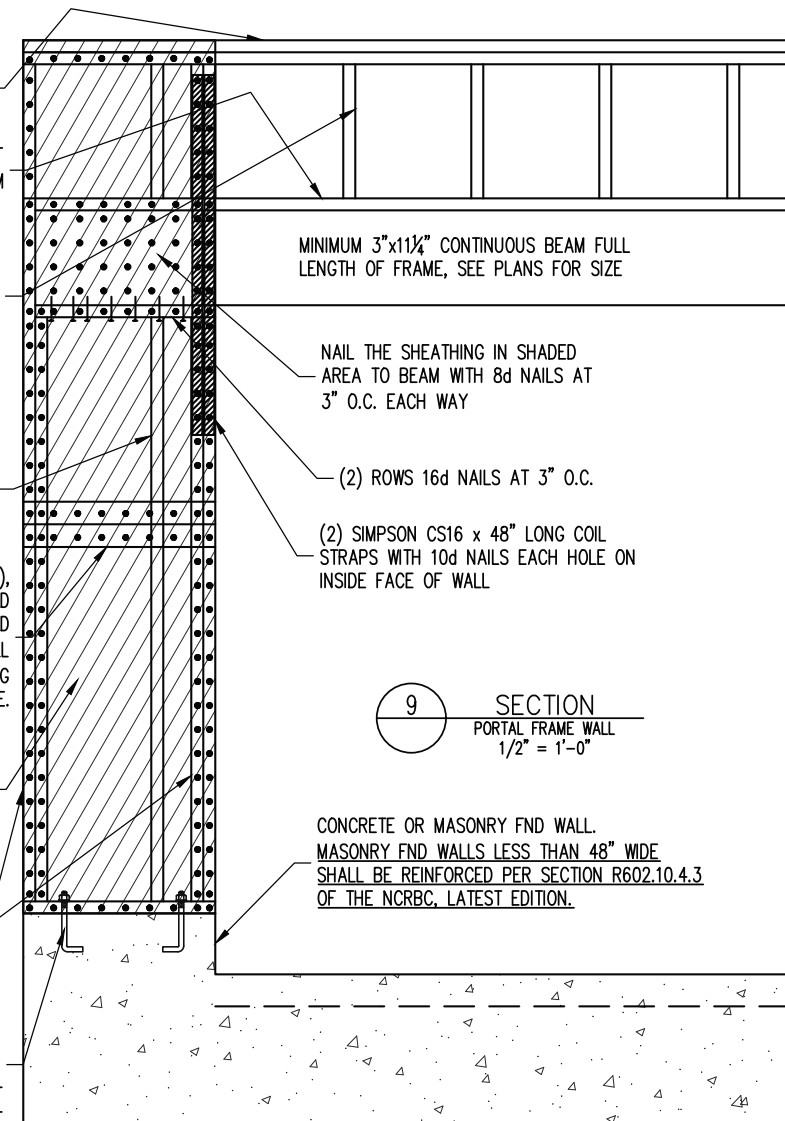

9 SECTION  
PORTAL FRAME WALL  
1/2" = 1'-0"

## NOTES

THE BUILDER IS RESPONSIBLE FOR REVIEWING PLANS PRIOR TO CONSTRUCTION. THE BUILDER SHALL IMMEDIATELY CONTACT THE ENGINEER OF RECORD (EOR) BEFORE PROCEEDING IF THE FOLLOWING CONDITIONS ARE NOTED BEFORE OR DURING CONSTRUCTION:  
1) THE WORKING PLANS DO NOT BEAR THE SEAL OF THE EOR  
2) THE PLANS CONTAIN DISCREPANT OR INCOMPLETE INFORMATION

ANY ERRORS DUE TO A FAILURE TO FOLLOW THE ABOVE PROCEDURES SHALL NOT BE THE RESPONSIBILITY OF THE EOR. FURTHERMORE, IT IS THE RESPONSIBILITY OF THE BUILDER TO ENSURE THAT ANY REVISIONS ISSUED BY THE EOR ARE PROMPTLY DISTRIBUTED TO THE SUBCONTRACTORS

THE EOR DOES NOT PERFORM FENESTRATION OR VENTING CALCULATIONS OR ANY OTHER CALCULATIONS THAT ARE NOT DIRECTLY RELATED TO STRUCTURAL ENGINEERING.

ROOF AND FLOOR TRUSSES TO BE DESIGNED BY AN ENGINEER REGISTERED BY THE STATE. FINAL TRUSS DRAWING SHOULD BE SUBMITTED TO THE EOR FOR REVIEW

## ABBREVIATIONS

ABV ABOVE	FND FOUNDATION	TJ TRIPLE JOIST
B. BOTH	FTG FOOTING	TYP TYPICAL
B.E. BOTH ENDS	HDG HOT DIPPED	TRPL TRIPLE
BTWN BETWEEN	GALV GALVANIZED	TSP TRIPLE STUD POCKET
CIP CAST IN PLACE	HGR HANGER	UNO UNLESS NOTED OTHERWISE
CONC CONCRETE	LVL LAMINATED VENEER LUMBER	XJ EXTRA JOIST
CS CONTINUOUS SHEATHING	NTS NOT TO SCALE	
DIA DIAMETER	O.C. ON CENTER	
DBL DOUBLE	PSL PARALLEL STRAND LUMBER	
DJ DOUBLE JOIST	PT PRESSURE TREATED	
DSP DBL STUD POCKET	QJ QUAD JOIST	
EQ EQUAL	SP STUD POCKET	
EA EACH	SQ SQUARE	
FLG FLANGE		
FL PL FLITCH PLATE		
FLR FLOOR		

## ALLOWABLE I-JOIST SUBSTITUTION

NOTE: MAINTAIN JOIST DEPTH, DIRECTION, AND SPACING SPECIFIED ON PLANS.

MANUFACTURER	DEPTH	SERIES	SIMPSON FACE MOUNT HGR	SIMPSON TOP FLANGE HGR
BLUELIX	14"	BLI 40	IUS2.56/14	ITS2.56/14
BOISE CASCADE	14"	BCI 5000s	IUS2.06/14	ITS2.06/14
BOISE CASCADE	14"	BCI 6000S	IUS2.37/14	ITS2.37/14
LP CORP	14"	LPI 20+	IUS2.56/14	ITS2.56/14
NORDIC	14"	NI 40X	IUS2.56/14	ITS2.56/14
ROSEBURG	14"	RFPI 40s	IUS2.56/14	ITS2.56/14
WEYERHAEUSER	14"	TJ 210	IUS2.06/14	ITS2.06/14
WEYERHAEUSER	14"	EEL-20	IUS2.37/14	ITS2.73/14

JOISTS NOT LISTED IN THE ABOVE TABLE MAY BE USED PROVIDED THEY MEET OR EXCEED THE PROPERTIES OF THOSE LISTED. SUBSTITUTE USP BRAND HANGERS WITH EQUIVALENT VALUES AS DESIRED.

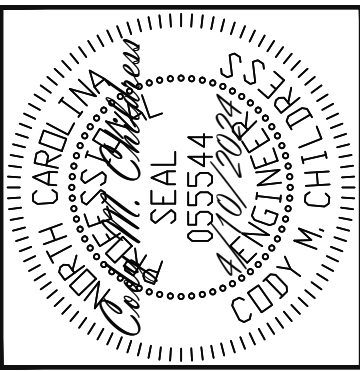

ENGINEERING SEAL VALID FOR 1 YEAR ONLY. The structural design of this plan is the property of Engineering Tech Associates, P.A. These plans are for the client listed only. Engineering Tech Associates, P.A. assumes no liability for these plans if construction or permitting takes place more than 1 year after the seal date without written permission from Engineering Tech Associates, P.A.

**Engineering Tech Associates, P.A.**  
STRUCTURAL ENGINEERS  
License No. C-3870  
318 W Millbrook Rd Suite 201  
Raleigh, North Carolina 27609  
Phone (919) 844-1661

FRESH PAINT	STRUCTURAL ADDENDUM	TBD	MASTER	HONEYSUCKLE
SCOPE	LOC	PLAN		

ENG: CMC  
DATE: 4/10/2024

PROJECT NO.  
24-30-029

SHEET NO.  
SD2  
7 of 7