

# DOGWOOD

## DOGWOOD REVISION LIST - STRUCTURAL:

- 1.) ADDED JOIST SERIES/SPACING (11-16)
- 2.) CHANGED FRAMING AND REMOVED FOOTINGS AND FOUNDATION SUPPORT FOR THE REMOVED VAULT IN BEDROOM 3. (11-16)
- 3.) ADDED FRAMING FOR CHASE AT SECOND FLOOR. (11-16)
- 4.) ADDED/REMOVED EXTRA JOISTS IN CRAWL (11-16)
- 5.) ADDED PLUMBING DIMENSIONS WITH OPTIONAL MASTER MATH ON MONO (11-16)
- 6.) CHANGED ALL GARAGE HEADERS TO (3) PLY (11-16)
- 7.) CHANGED DOUBLE STUD POCKETS TO TRIPLE STUD POCKETS (11-18)
- 8.) REMOVED BRICK FROM REAR PORCH (11-18)
- 9.) REMOVED INTERIOR WALL BRACING PANELS (11-18)
- 10.) 2018 CODE UPDATE (6-19)
- 11.) CHANGE 2X6 EXTERIOR WALLS TO 2X4 EXTERIOR WALLS. (3-11-20)
- 12.) SQUARE FOOTAGES CHANGE ON SECOND FLOOR BETWEEN ALL ELEVATIONS DUE TO CLOSET BUMP OUT (B ELEVATIONS) AND BEDROOM 4 BUMP OUT (C ELEVATIONS) (08-13-20)
- 13.) SQUARE FOOTAGE OF FIRST FLOOR CHANGES WITH B ELEVATIONS DUE TO BUMP OUT IN FOYER (08-13-20)
- 14.) CHANGED ALL EXTERIOR WALLS FROM 2X6 TO 2X4 EXCEPT WHERE SHADED (11-01-20)
- 15.) REMOVED HEADER FROM STANDARD OWNER'S BATHROOM FOR TRANSOM WINDOW THAT WAS REMOVED (09-07-22)
- 16.) BASEMENT INTERIOR WALLS CHANGED FROM 2X4 TO 2X6 (09-28-22)
- 17.) CHANGED WALL BETWEEN FAMILY ROOM AND KITCHEN TO 2X6 (09-28-22)
- 18.) CHANGED OPENING FROM FOYER TO FAMILY ROOM FROM 4'-6" TO 4'-4" (09-28-22)

## DOGWOOD REVISION LIST - ARCHITECTURAL:

- NOVEMBER 01, 2020
- |   |   |
|---|---|
| <ol style="list-style-type: none"> <li>1. CREATED ELEVATIONS TO BE IN STANDARDS WITH OTHER PLANS (SEE SHEETS A-1 THROUGH A-3-5)</li> <li>2. CHANGED COLUMNS ON ELEVATIONS TO STANDARD COLUMNS</li> <li>3. CHANGED GARAGE DOORS TO REPRESENT STANDARD GARAGE DOOR FOR EACH ELEVATION</li> <li>4. FIXED COVERED PORCH TO KEEP COLUMNS FROM OVERLAPPING EDGE OF CONCRETE</li> <li>5. REMOVED GRIDS FROM TRANSOMS ABOVE FRONT DOOR</li> <li>6. ADDED NOTE FOR GARAGE DOOR "GARAGE DOOR PER SPECIFICATIONS AND GLASS INSERT (TOP PANEL ONLY)"</li> <li>7. MOVED ROOF PLANS TO SHEETS S-4</li> <li>8. ROOF ABOVE COVERED PATIO CHANGED TO SHED ROOF (SEE ON SIDE AND REAR ELEVATIONS)</li> <li>9. REMOVED OPTION FOR FIREPLACE IN OWNER'S BEDROOM</li> <li>10. CREATED SLAB INTERFACE PLAN (SEE SHEET A-4 THROUGH A-4-2)</li> <li>11. MOVED ALL OPTIONS OFF BASE PLAN AND PLACED ON SEPARATE SHEET</li> <li>12. ADDED NOTE FOR FLUSH COUNTERTOP ON ISLAND AND 34 1/2" H. WALL UNDER</li> <li>13. CHANGED PATIO SIZE TO STANDARD 12X10'</li> <li>14. ADDED OPTIONAL GAS LINE</li> <li>15. CHANGED NAME OF "FLEX ROOM" TO "STUDY"</li> <li>16. CHANGED "BREAKFAST ROOM" TO "CASUAL DINING"</li> <li>17. ADDED 2ND HOSE BIB</li> <li>18. CALLED OUT "45" WALL WITH CAP" AS STANDARD</li> <li>19. CHANGED ALL EXTERIOR WALLS FROM 2X6 TO 2X4 EXCEPT WHERE SHADED</li> <li>20. ADDED NOTE "OPT. REF."</li> <li>21. ADDED NOTE "OPT. W/D"</li> <li>22. ADDED NOTE "WASHER ALWAYS TO BE LOCATED TO THE LEFT OF DRYER"</li> <li>23. ADDED PDS ATTIC ACCESS</li> <li>24. VERIFIED VENTILATION AND LIGHT REQUIREMENTS AT OWNER'S BEDROOM MEETS CODE (11-01-20)</li> <li>25. SQUARE FOOTAGES ARE UPDATED AND CHANGED DUE TO MOVEMENT OF WALL DOWN CENTER OF HOUSE TO KEEP WALLS FROM MOVING BETWEEN ELEVATION CHOICES</li> <li>26. SQUARE FOOTAGE OF COVERED PORCH CHANGED DUE TO KEEPING COLUMNS FROM OVERLAPPING CONCRETE EDGE</li> <li>27. CREATED PARTIAL PLANS FOR B &amp; C ELEVATIONS (FLOOR, SLAB, &amp; ELECTRICAL)</li> <li>28. REMOVED ALL WALL OUTLETS</li> <li>29. REMOVED ALL PHONE OUTLETS</li> <li>30. REMOVED ALL TV OUTLETS</li> <li>31. PLACED STANDARD 3 BULB LIGHT IN KITCHEN</li> <li>32. VERIFIED COACH LIGHT LOCATIONS (SEE ELEVS</li> </ol> | <ol style="list-style-type: none"> <li>FOR DIMS)</li> <li>33. PLACED DASHED FANS WHERE APPLICABLE WITH NOTE 'STD. LIGHT, OPT. FAN/LT PREWIRE'</li> <li>34. UPDATED ELECTRICAL KEY</li> <li>35. REMOVED UNDER CABINET LIGHTINGS</li> <li>36. VERIFIED CO2 DETECTOR LOCATIONS</li> <li>37. SHOWED PENDANT LIGHTS AS OPTIONAL</li> <li>38. SHOWED CAN LIGHTS IN KITCHEN AND FAMILY ROOM AS "OPTIONAL CAN LIGHTS"</li> <li>39. PLACED OPTIONAL FLOOR LIGHTS</li> <li>40. PLACED OPTIONAL FLOOR OUTLET IN FAMILY ROOM</li> <li>41. PLACED CALCULATIONS FOR SOFFIT AND RIDGE VENT REQUIREMENTS</li> <li>42. CHANGED LAYOUT FOR BASE OWNER'S BATHROOM</li> <li>43. ADDED OPTIONAL OWNER'S BATH 2 &amp; OWNER'S BATH 3</li> <li>44. REMOVED "OPTIONAL COVERED DECK AT OWNER'S BATH"</li> </ol> <p>FEBRUARY 01, 2022</p> <ol style="list-style-type: none"> <li>45. ADDED OPTIONAL DOUBLE GARAGE DOOR FLOOR PLAN TO FIRST FLOOR OPTIONS SHEET (02-01-22)</li> <li>46. ADDED OPTIONAL BASEMENT TO PLANS (02-01-22)</li> <li>47. REMOVED TRANSOM WINDOW FROM OWNER'S BATH 1 (09-07-22)</li> <li>48. CHANGED BASEMENT INTERIOR WALLS TO 2X6 (09-28-22)</li> <li>49. CHANGED WALL BETWEEN FAMILY ROOM AND KITCHEN TO 2X6 (09-28-22)</li> <li>50. CHANGED OPENING FROM FOYER TO FAMILY ROOM FROM 4'-6" TO 4'-4" (09-28-22)</li> <li>51. RECENTERED WINDOWS AND FIREPLACE IN FAMILY ROOM (09-28-22)</li> <li>52. CREATED CHASE ON TUB SIDE OF OWNER'S BATH 2 BY REMOVING SOME DEPTH FROM EXISTING CHASE ON SHOWER SIDE TO GET CLEARANCE FOR TUBS FAUCET (11-01-23)</li> <li>53. CREATED EQUAL CHASE IN SHOWER LOCATION FOR PRIMARY OWNER'S BATH 2 (11-01-23)</li> <li>54. WINDOW OF OWNER'S BATH 2 MOVED BY 7" (11-01-23)</li> <li>55. CHANGED OWNER'S BEDROOM TO PRIMARY BEDROOM (11-01-23)</li> <li>56. CHANGED OWNER'S BATH TO PRIMARY BATH (11-01-23)</li> </ol> |
|---|---|



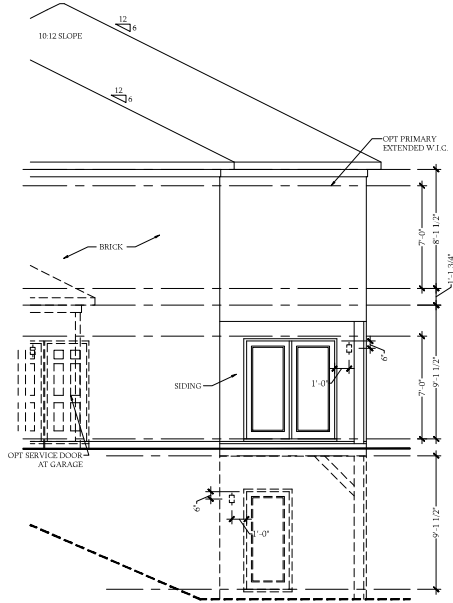

Side Elevation  
w/ Extended W.I.C.

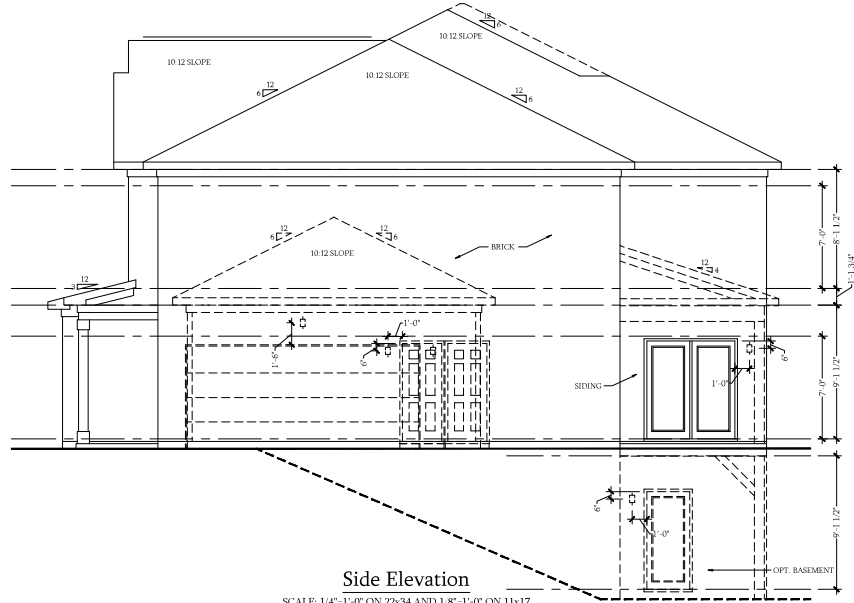

Side Elevation

SCALE: 1/4"=1'-0" ON 2x34 AND 1/8"=1'-0" ON 11x17

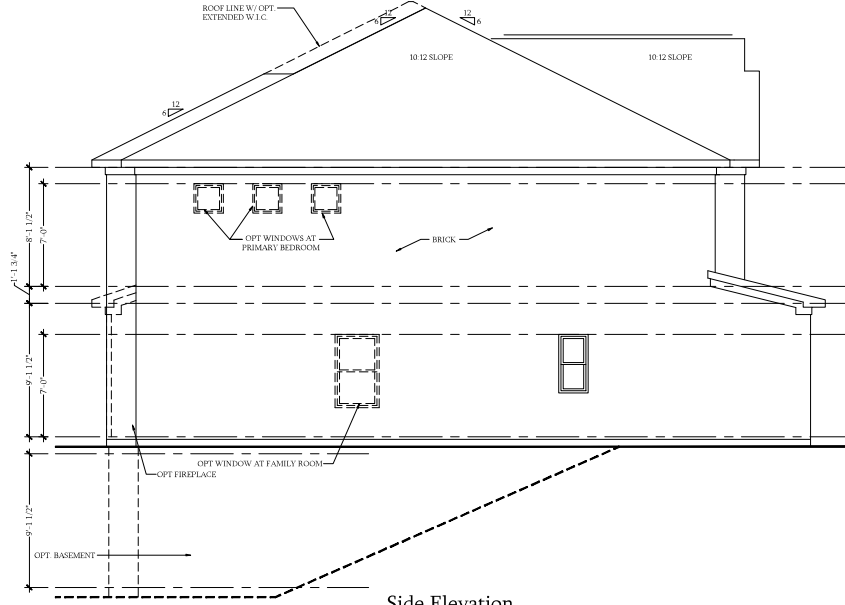

Side Elevation

SCALE: 1/4"=1'-0" ON 2x34 AND 1/8"=1'-0" ON 11x17



DREAM FINDERS  
HOMES

PRICE, PROMOTIONS, INCENTIVES, FEATURES, OPTIONS, FINANCING AND CONSTRUCTION COSTS ARE SUBJECT TO CHANGE WITHOUT NOTICE. DIMENSIONS ARE SUBJECT TO CHANGE WITHOUT NOTICE. MATERIALS AND FINISHES ARE SUBJECT TO CHANGE WITHOUT NOTICE. ALL DIMENSIONS ARE TO FACE UNLESS NOTED OTHERWISE. THIS DRAWING IS NOT TO BE USED FOR CONSTRUCTION. ANY REPRODUCTION, ADAPTATION OR DISPLAY OF THIS DRAWING WITHOUT THE WRITTEN PERMISSION OF DREAM FINDERS HOMES IS STRICTLY PROHIBITED. © 2019 DREAM FINDERS HOMES.

DREAM FINDERS HOMES  
DOWNSIDE

DATE: JANUARY 17, 2019  
REV: FEBRUARY 01, 2022  
SCALE: AS NOTED  
DRAWN BY:  
ENGINEERED BY:  
REVIEWED BY:

A-4 SIDE  
ELEVATIONS  
A-1.5









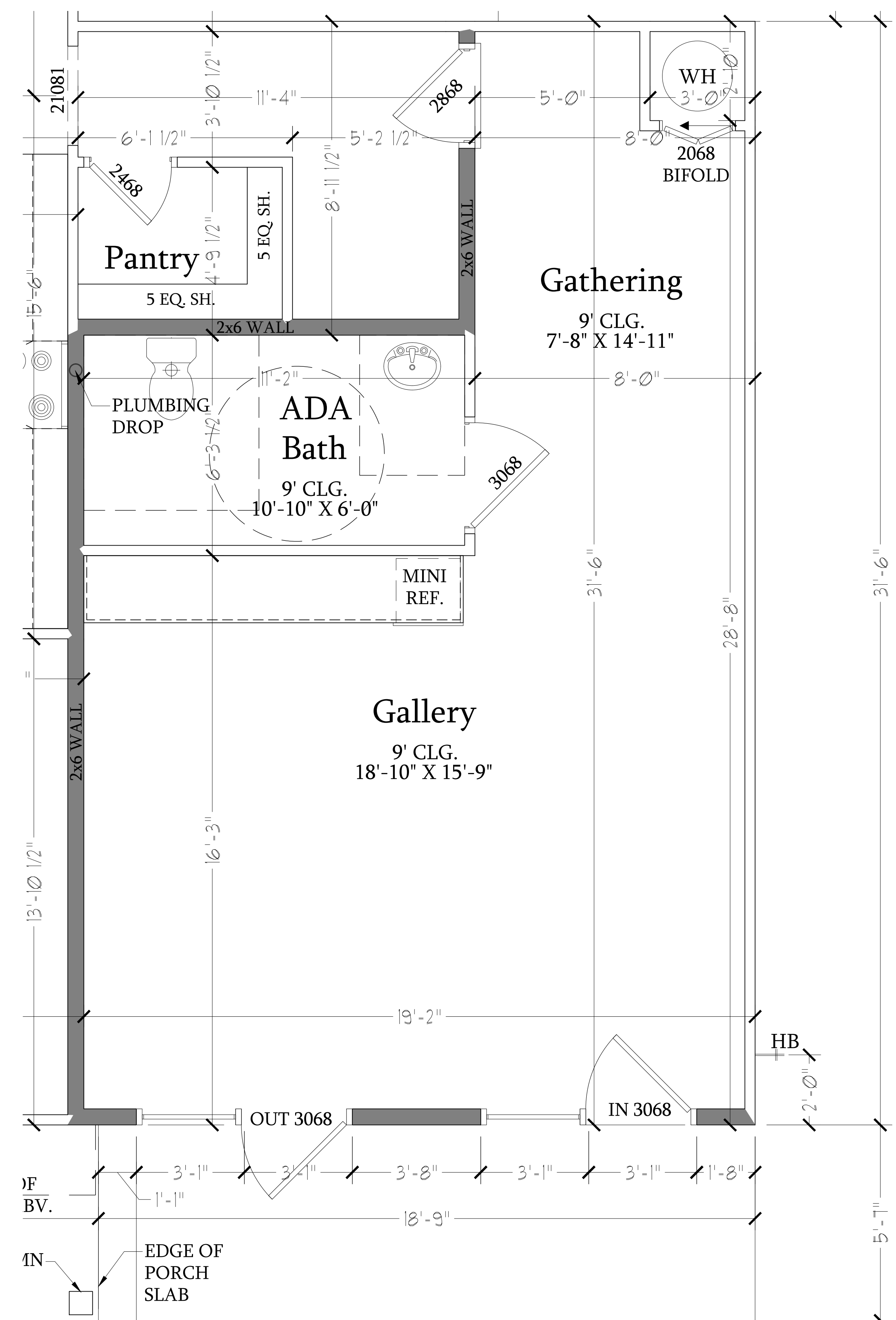

PRICES, PROMOTIONS, INCENTIVES, FEATURES, OPTIONS, FLOOR PLANS, ELEVATIONS, DESIGNS, MATERIALS AND DIMENSIONS ARE SUBJECT TO CHANGE WITHOUT NOTICE. SQUARE FOOTAGE AND DIMENSIONS ARE ESTIMATED AND MAY VARY IN ACTUAL CONSTRUCTION. ACTUAL POSITION AND PLACEMENT OF WALLS, DOORS, WINDOWS, CLOSET AND CLOSET PLAN, FLOOR PLANS AND ELEVATIONS AND RENDERINGS ARE ARTIST CONCEPTIONS. FLOOR PLANS ARE THE COPYRIGHTED PROPERTY OF DREAM FINDERS HOMES. ANY USE, REPRODUCTION, ADAPTATION, OR DISPLAY OF THIS INFORMATION WITHOUT THE WRITTEN PERMISSION OF DREAM FINDERS HOMES IS STRICTLY PROHIBITED. SALES CONSULTANT FOR CURRENT DETAILS. COPYRIGHT © DREAM FINDERS HOMES

DREAM FINDERS HOMES  
 DOGWOOD  
 SALES CENTER - COLLEX596

DATE: JANUARY 17, 2019  
 REV.: FEBRUARY 01, 2022  
 SCALE: 1/4"=1'-0"  
 DRAWN BY:  
 ENGINEERED BY:  
 REVIEWED BY:

FIRST FLOOR  
 PLAN  
 A-6









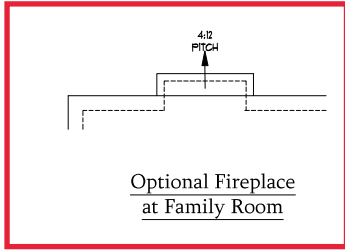

Optional Fireplace  
at Family Room

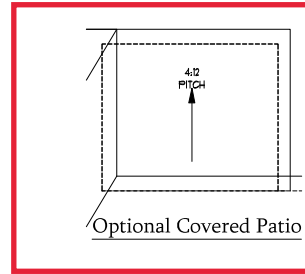

Optional Covered Patio

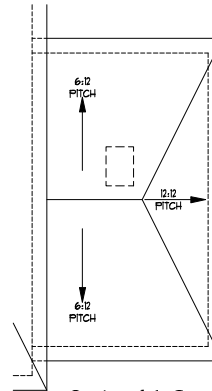

Optional 1-Car  
Carriage Garage  
Elevation C

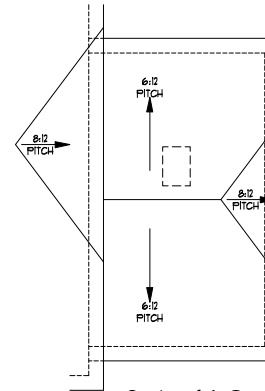

Optional 1-Car  
Carriage Garage  
Elevation B

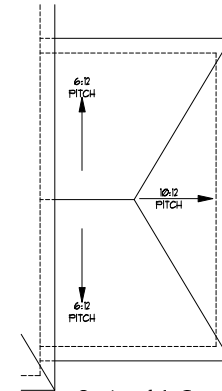

Optional 1-Car  
Carriage Garage  
Elevation A



DREAM FINDERS  
HOMES

PRICE, PROMOTIONS, INCENTIVES, FEATURES, OPTIONS, FINANCING, AND CONSTRUCTION METHODS ARE SUBJECT TO CHANGE WITHOUT NOTICE. PERMITS ARE SUBJECT TO LOCAL REGULATIONS. ALL MEASUREMENTS ARE IN FEET AND INCHES UNLESS OTHERWISE NOTED. THIS PLAN IS A GENERAL CONCEPTUAL DESIGN AND SHOULD BE USED AS A GUIDE ONLY. ALL DIMENSIONS AND FINISHES ARE SUBJECT TO CHANGE WITHOUT NOTICE. ANY USE, REPRODUCTION, ADAPTATION OR DISPLAY OF THIS PLAN WITHOUT THE WRITTEN PERMISSION OF DREAM FINDERS HOMES IS STRICTLY PROHIBITED. © 2022 DREAM FINDERS HOMES.

DREAM FINDERS HOMES  
DOGWOOD

DATE: JANUARY 17, 2019  
REV: FEBRUARY 01, 2022  
SCALE: 1/4"=1'-0"  
DRAWN BY:  
ENGINEERED BY:  
REVIEWED BY:

ROOF PLAN  
OPTIONS  
A-8.3





**ELECTRICAL LEGEND**

- 120V OUTLET
- 120V GFI OUTLET
- 120V SWITCHED OUTLET
- 120V BASEBOARD OUTLET
- 4 PLEX
- FLOOR MOUNTED 120V
- FLOOR MOUNTED 120V GFI
- WEATHERPROOF
- 220V OUTLET
- 120V DEDICATED CIRCUIT
- 220V DEDICATED CIRCUIT
- SPECIAL PURPOSE (240 V, ETC.)
- WALL MOUNT LIGHT
- CEILING MOUNT LIGHT
- PENDANT LIGHT
- RECESSED CAN LIGHT
- MINI CAN LIGHT
- INVEALL LIGHT
- FLUORESCENT LIGHT
- UNDERCABINET LIGHT
- FLOOR LIGHT
- SWITCH
- 3-WAY SWITCH
- 4-WAY SWITCH
- DIMMER SWITCH
- TELEPHONE
- TV CONNECTION
- CONDUIT FOR COMPONENT WIRING
- SPEAKER
- COMBINATION CARBON MONOXIDE DETECTOR
- 110 V SMOKE DETECTOR
- EXHAUST FAN
- LOW VOLTAGE PANEL

- CEILING FAN
- CEILING FAN W/ LIGHT

**ELECTRICAL NOTES:**

1. PROVIDE AND INSTALL GROUND FAULT CIRCUIT INTERRUPTERS (GFCI) AS INDICATED ON PLANS OR AS ITEM NO. 4 AND 5 BELOW INDICATES.
2. UNLESS OTHERWISE INDICATED, INSTALL SWITCHES AND RECEPTACLES AT THE FOLLOWING HEIGHTS ABOVE FINISHED FLOOR: SWITCHES ... 42" OUTLETS ... 14" TELEPHONE ... 14" (UNLESS ASV COUNTERTOP) TELEVISION ... 14"
3. ALL SMOKE DETECTORS SHALL BE HARDWIRED INTO AN ELECTRICAL POWER SOURCE AND SHALL BE EQUIPPED WITH A MONITORED BATTERY BACKUP. PROVIDE AND INSTALL LOCALLY CERTIFIED SMOKE DETECTORS.
4. ALL 15A AND 20A RECEPTACLES IN SLEEPING ROOMS, FAMILY ROOMS, DINING ROOMS, LIVING ROOMS, PORCHES, LIBRARIES, DEN, SUNROOMS, RECREATION ROOMS, CLOSETS, HALLWAYS, AND SIMILAR AREAS WILL REQUIRE A COMBINATION TYPE AFCI DEVICE AND TAMPER PROOF RECEPTACLES.
5. ALL 15A AND 20A 120V RECEPTACLES LOCATED IN THE GARAGE AND UTILITY ROOMS SHALL BE G.F.C.I. PROTECTED (G.F.I.).
6. IT IS THE RESPONSIBILITY OF THE LICENSED ELECTRICIAN TO ENSURE THAT ALL ELECTRICAL WORK IS IN FULL COMPLIANCE WITH ALL APPLICABLE LOCAL STANDARDS, CODES, AND ORDINANCES.
7. EVERY BUILDING HAVING A FOSSIL FUEL-BURNING HEATER OR APPLIANCE, FIREPLACE, OR AN ATTACHED GARAGE SHALL HAVE AN OPERATIONAL CARBON MONOXIDE DETECTOR INSTALLED WITHIN 10 FEET OF EACH ROOM USED FOR SLEEPING PURPOSES.
8. ALARMS SHALL RECEIVE THEIR PRIMARY POWER FROM THE BUILDING WIRING. WHEN SUCH WIRING IS SERVED FROM THE LOCAL POWER UTILITY, SUCH ALARMS SHALL HAVE BATTERY BACKUP. COMBINATION SMOKE/CARBON MONOXIDE ALARMS SHALL BE LISTED OR LABELED BY A NATIONALLY RECOGNIZED TESTING LABORATORY.

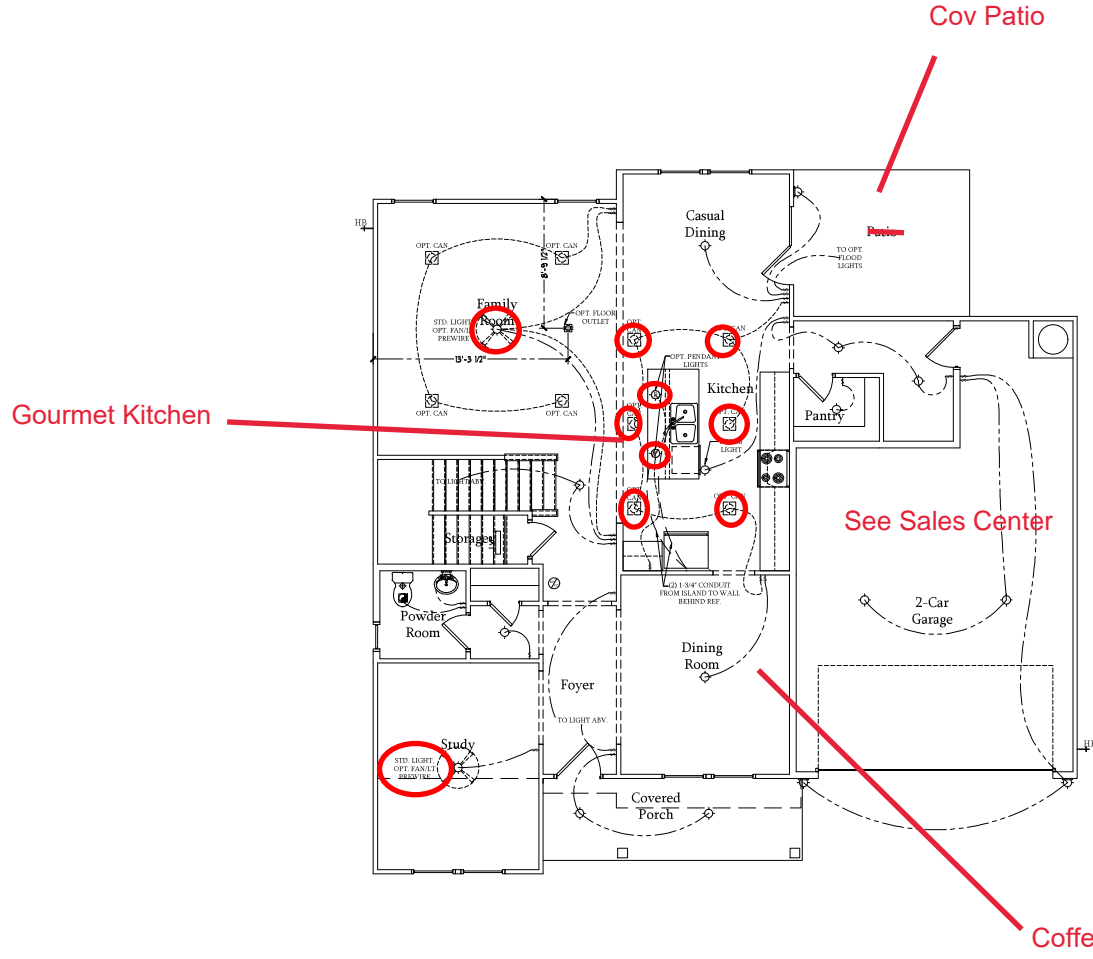

**First Floor Plan**  
SCALE: 1/4"=1'-0" ON 22x34 AND 1/8"=1'-0" ON 11x17



































PRICE, PROMOTIONS, INCENTIVES, FEATURES, OPTIONS, FINANCING, AND DELIVERY SCHEDULES ARE SUBJECT TO CHANGE WITHOUT NOTICE. PERMITS ARE SUBJECT TO CHANGE WITHOUT NOTICE. ALL MATERIALS AND CONSTRUCTION SHALL BE IN ACCORDANCE WITH THE LATEST EDITIONS OF THE NATIONAL ELECTRICAL CODE (NEC) AND THE NATIONAL FIRE ALARM AND SIGNAL CODE (NFPA 72). ALL ELECTRICAL WORK SHALL BE PERFORMED BY THE BEST QUALITY CONTRACTORS. ALL ELECTRICAL WORK SHALL BE IN ACCORDANCE WITH ALL APPLICABLE LOCAL STANDARDS, CODES, AND ORDINANCES. ANY USE, REPRODUCTION, ADAPTATION OR DISPLAY OF THIS DOCUMENT WITHOUT THE WRITTEN PERMISSION OF DREAM FINDERS HOMES IS STRICTLY PROHIBITED. © 2019 DREAM FINDERS HOMES.

**DREAM FINDERS HOMES**  
**DOGWOOD**

DATE: JANUARY 17, 2019  
REV: FEBRUARY 01, 2022  
SCALE: 1/4"=1'-0"  
DRAWN BY:  
ENGINEERED BY:  
REVIEWED BY:

FIRST FLOOR ELECTRICAL PLAN

**ELECTRICAL LEGEND**

-  110V OUTLET
-  110V GFI OUTLET
-  110V SWITCHED OUTLET
-  110V BASEBOARD OUTLET
-  4-PLEX
-  FLOOR MOUNTED 120V
-  FLOOR MOUNTED 120V GFI
-  WEATHERPROOF
-  220V OUTLET
-  120V DEDICATED CIRCUIT
-  220V DEDICATED CIRCUIT
-  SPECIAL PURPOSE (240 V, ETC.)
-  WALL MOUNT LIGHT
-  CEILING MOUNT LIGHT
-  PENDANT LIGHT
-  RECESSED CAN LIGHT
-  LED PUCK LIGHT
-  LED CEILING MOUNTED LIGHT
-  FLUORESCENT LIGHT
-  UNDERCABINET LIGHT
-  FLOOD LIGHT
-  SWITCH
-  3-WAY SWITCH
-  4-WAY SWITCH
-  DIMMER SWITCH
-  TELEPHONE
-  TV CONNECTION
-  CONDUIT FOR COMPONENT WIRING
-  SPEAKER
-  COMBO SMOKE/ CARBON MONOXIDE DETECTOR
-  110 V SMOKE DETECTOR
-  EXHAUST FAN
-  LOW VOLTAGE PANEL

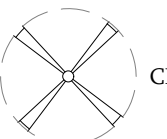
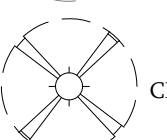
-  CEILING FAN
-  CEILING FAN W/ LIGHT

**ELECTRICAL NOTES:**

1. PROVIDE AND INSTALL GROUND FAULT CIRCUIT-INTERRUPTERS (G.F.I.) AS INDICATED ON PLANS OR AS ITEM NO. 4 AND 5 BELOW INDICATES.
2. UNLESS OTHERWISE INDICATED, INSTALL SWITCHES AND RECEPTACLES AT THE FOLLOWING HEIGHTS ABOVE FINISHED FLOOR:  
 SWITCHES . . . . 42"  
 OUTLETS . . . . 14"  
 TELEPHONE . . .14" (UNLESS ABV COUNTERTOP)  
 TELEVISION . .14"
3. ALL SMOKE DETECTORS SHALL BE HARDWIRED INTO AN ELECTRICAL POWER SOURCE AND SHALL BE EQUIPPED WITH A MONITORED BATTERY BACKUP. PROVIDE AND INSTALL LOCALLY CERTIFIED SMOKE DETECTORS.
4. ALL 15A AND 20A RECEPTACLES IN SLEEPING ROOMS, FAMILY ROOMS, DINING ROOMS, LIVING ROOMS, PARLORS, LIBRARIES, DENS, SUNROOMS, RECREATION ROOMS, CLOSETS, HALLWAYS, AND SIMILAR AREAS WILL REQUIRE A COMBINATION TYPE A.F.C.I. DEVICE AND TAMPER-PROOF RECEPTACLES.
5. ALL 15A AND 20A 120V RECEPTACLES LOCATED IN THE GARAGE AND UTILITY ROOMS SHALL BE G.F.C.I. PROTECTED (G.F.I.).
6. IT IS THE RESPONSIBILITY OF THE LICENSED ELECTRICIAN TO ENSURE THAT ALL ELECTRICAL WORK IS IN FULL COMPLIANCE WITH ALL APPLICABLE LOCAL STANDARDS, CODES, AND ORDINANCES.
7. EVERY BUILDING HAVING A FOSSIL-FUEL-BURNING HEATER OR APPLIANCE, FIREPLACE, OR AN ATTACHED GARAGE SHALL HAVE AN OPERATIONAL CARBON MONOXIDE DETECTOR INSTALLED WITHIN 10 FEET OF EACH ROOM USED FOR SLEEPING PURPOSES.
8. ALARMS SHALL RECEIVE THEIR PRIMARY POWER FROM THE BUILDING WIRING WHEN SUCH WIRING IS SERVED FROM THE LOCAL POWER UTILITY. SUCH ALARMS SHALL HAVE BATTERY BACKUP. COMBINATION SMOKE/CARBON MONOXIDE ALARMS SHALL BE LISTED OR LABELED BY A NATIONALLY RECOGNIZED TESTING LABORATORY.

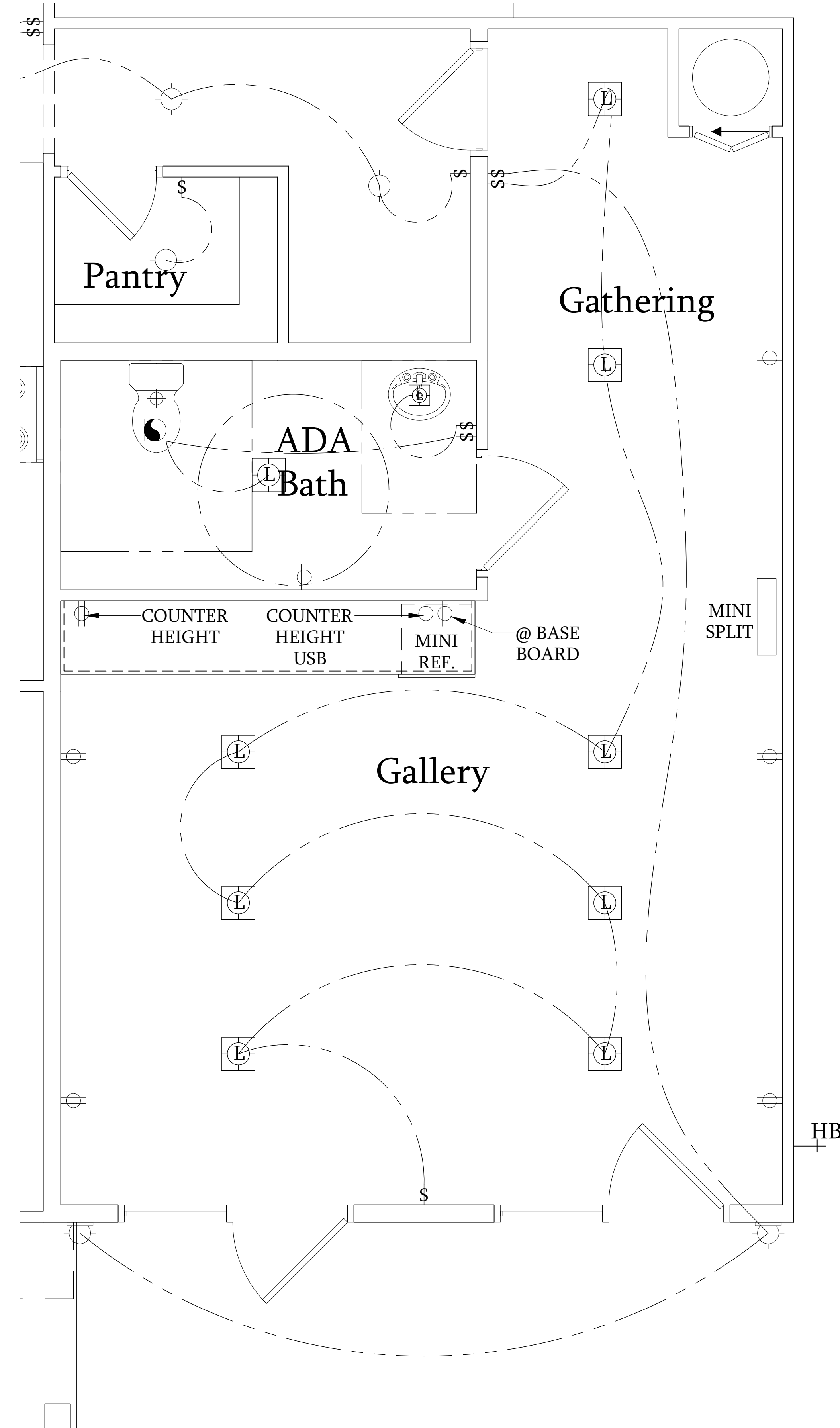

PRICES, PROMOTIONS, INCENTIVES, FEATURES, OPTIONS, FLOOR PLANS, ELEVATIONS, DESIGNS, MATERIALS AND DIMENSIONS ARE SUBJECT TO CHANGE WITHOUT NOTICE. SQUARE FOOTAGE AND DIMENSIONS ARE ESTIMATED AND MAY VARY IN ACTUAL CONSTRUCTION. ACTUAL POSITION AND DIMENSIONS SHALL BE SHOWN ON THE SITE PLAN AND PLOT PLAN, FLOOR PLANS AND ELEVATION. RENDERINGS ARE ARTIST CONCEPTIONS. FLOOR PLANS ARE THE COPYRIGHTED PROPERTY OF DREAM FINDERS HOMES. ANY USE, REPRODUCTION, ADAPTATION, OR DISPLAY WITHOUT THE WRITTEN PERMISSION OF DREAM FINDERS HOMES. SALES CONSULTANT FOR CURRENT DETAILS. COPYRIGHT © DREAM FINDERS HOMES

**DREAM FINDERS HOMES**  
**DOGWOOD**  
**SALES CENTER - COLLEX596**

DATE: JANUARY 17, 2019  
 REV.: FEBRUARY 01, 2022  
 SCALE: 1/4"=1'-0"  
 DRAWN BY:  
 ENGINEERED BY:  
 REVIEWED BY:

FIRST FLOOR  
 ELECTRICAL  
 PLAN

**E-1**

**ELECTRICAL LEGEND**

- 120V OUTLET
- 120V GFI OUTLET
- 120V SWITCHED OUTLET
- 120V BASEBOARD OUTLET
- 4 PLEX
- FLOOR MOUNTED 120V
- FLOOR MOUNTED 120V GFI
- WEATHERPROOF
- 220V OUTLET
- 120V DEDICATED CIRCUIT
- 220V DEDICATED CIRCUIT
- SPECIAL PURPOSE (240 V, ETC.)
- WALL MOUNT LIGHT
- CEILING MOUNT LIGHT
- PENDANT LIGHT
- RECESSED CAN LIGHT
- MINI CAN LIGHT
- EVERY ALL LIGHT
- FLUORESCENT LIGHT
- UNDERCABINET LIGHT
- FLOOD LIGHT
- SWITCH
- 3 WAY SWITCH
- 4 WAY SWITCH
- DIMMER SWITCH
- TELEPHONE
- TV CONNECTION
- CONDUIT FOR COMPONENT WIRING
- SPEAKER
- COMBO SMOKE CARBON MONOXIDE DETECTOR
- 110 V SMOKE DETECTOR
- EXHAUST FAN
- LOW VOLTAGE PANEL

- CEILING FAN
- CEILING FAN W/ LIGHT

**ELECTRICAL NOTES:**

1. PROVIDE AND INSTALL GROUND FAULT CIRCUIT INTERRUPTERS (GFCI) INSTALLED ON PLANS OR ASHTA NO. 4 AND 5 BELOW INDICATES.
2. UNLESS OTHERWISE INDICATED, INSTALL SWITCHES AND RECEPTACLES AT THE FOLLOWING HEIGHTS ABOVE FINISHED FLOOR: SWITCHES - 42" OUTLETS - 14" TELEPHONE - 14" (UNLESS A/B/V COUNTERTOP) TELEVISION - 14"
3. ALL SMOKE DETECTORS SHALL BE HARDWIRED INTO AN ELECTRICAL POWER SOURCE AND SHALL BE EQUIPPED WITH A MONITORED BATTERY BACKUP. PROVIDE AND INSTALL LOCALLY CERTIFIED SMOKE DETECTORS.
4. ALL 15A AND 20A RECEPTACLES IN SLEEPING ROOMS, FAMILY ROOMS, DINING ROOMS, LIVING ROOMS, PORCHES, LIBRARIES, DEN, SUNROOMS, RECREATION ROOMS, CLOSETS, HALLWAYS, AND SIMILAR AREAS WILL REQUIRE A COMBINATION TYPE AFCI DEVICE AND TAMPER PROOF RECEPTACLES.
5. ALL 15A AND 20A 120V RECEPTACLES LOCATED IN THE GARAGE AND UTILITY ROOMS SHALL BE GFI-CI PROTECTED (GFI).
6. IT IS THE RESPONSIBILITY OF THE LICENSED ELECTRICIAN TO ENSURE THAT ALL ELECTRICAL WORK IS IN FULL COMPLIANCE WITH ALL APPLICABLE LOCAL STANDARDS, CODES, AND ORDINANCES.
7. EVERY BUILDING HAVING A FOSIL FUEL-BURNING HEATER OR APPLIANCE, FIREPLACE, OR AN ATTACHED GARAGE SHALL HAVE AN OPERATIONAL CARBON MONOXIDE DETECTOR INSTALLED WITHIN 10 FEET OF EACH ROOM USED FOR SLEEPING PURPOSES.
8. ALARMS SHALL RECEIVE THEIR PRIMARY POWER FROM THE BUILDING, WHEREBY WHEN SUCH WIRING IS SERVED FROM THE LOCAL POWER UTILITY, SUCH ALARMS SHALL HAVE BATTERY BACKUP. COMBINATION SMOKE CARBON MONOXIDE ALARMS SHALL BE LISTED OR LABELED BY A NATIONALLY RECOGNIZED TESTING LABORATORY.

**ELECTRICAL NOTES:**

1. PROVIDE AND INSTALL GROUND FAULT CIRCUIT INTERRUPTERS (GFCI) INSTALLED ON PLANS OR ASHTA NO. 4 AND 5 BELOW INDICATES.
2. UNLESS OTHERWISE INDICATED, INSTALL SWITCHES AND RECEPTACLES AT THE FOLLOWING HEIGHTS ABOVE FINISHED FLOOR: SWITCHES - 42" OUTLETS - 14" TELEPHONE - 14" (UNLESS A/B/V COUNTERTOP) TELEVISION - 14"
3. ALL SMOKE DETECTORS SHALL BE HARDWIRED INTO AN ELECTRICAL POWER SOURCE AND SHALL BE EQUIPPED WITH A MONITORED BATTERY BACKUP. PROVIDE AND INSTALL LOCALLY CERTIFIED SMOKE DETECTORS.
4. ALL 15A AND 20A RECEPTACLES IN SLEEPING ROOMS, FAMILY ROOMS, DINING ROOMS, LIVING ROOMS, PORCHES, LIBRARIES, DEN, SUNROOMS, RECREATION ROOMS, CLOSETS, HALLWAYS, AND SIMILAR AREAS WILL REQUIRE A COMBINATION TYPE AFCI DEVICE AND TAMPER PROOF RECEPTACLES.
5. ALL 15A AND 20A 120V RECEPTACLES LOCATED IN THE GARAGE AND UTILITY ROOMS SHALL BE GFI-CI PROTECTED (GFI).
6. IT IS THE RESPONSIBILITY OF THE LICENSED ELECTRICIAN TO ENSURE THAT ALL ELECTRICAL WORK IS IN FULL COMPLIANCE WITH ALL APPLICABLE LOCAL STANDARDS, CODES, AND ORDINANCES.
7. EVERY BUILDING HAVING A FOSIL FUEL-BURNING HEATER OR APPLIANCE, FIREPLACE, OR AN ATTACHED GARAGE SHALL HAVE AN OPERATIONAL CARBON MONOXIDE DETECTOR INSTALLED WITHIN 10 FEET OF EACH ROOM USED FOR SLEEPING PURPOSES.
8. ALARMS SHALL RECEIVE THEIR PRIMARY POWER FROM THE BUILDING, WHEREBY WHEN SUCH WIRING IS SERVED FROM THE LOCAL POWER UTILITY, SUCH ALARMS SHALL HAVE BATTERY BACKUP. COMBINATION SMOKE CARBON MONOXIDE ALARMS SHALL BE LISTED OR LABELED BY A NATIONALLY RECOGNIZED TESTING LABORATORY.

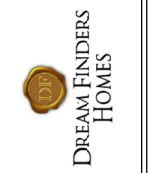
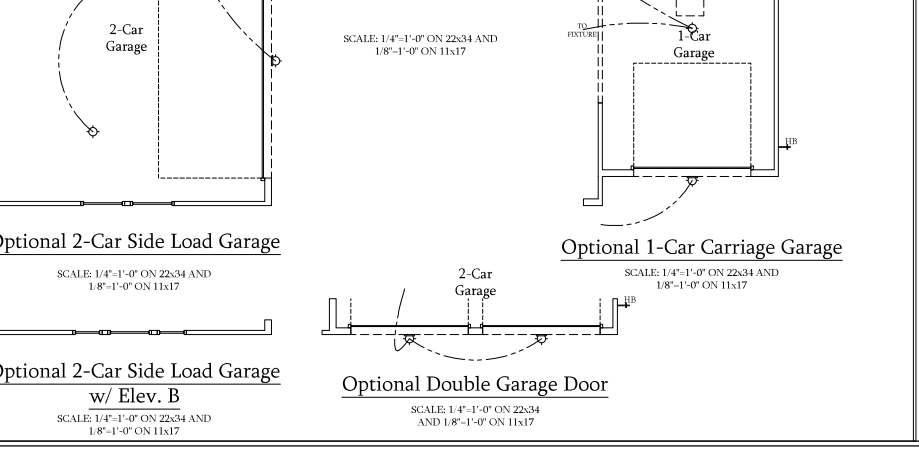
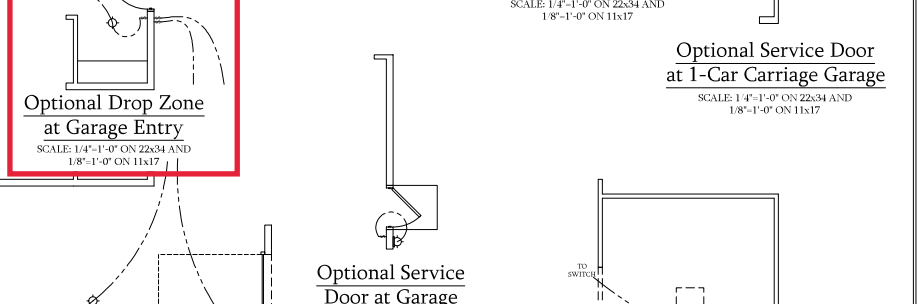
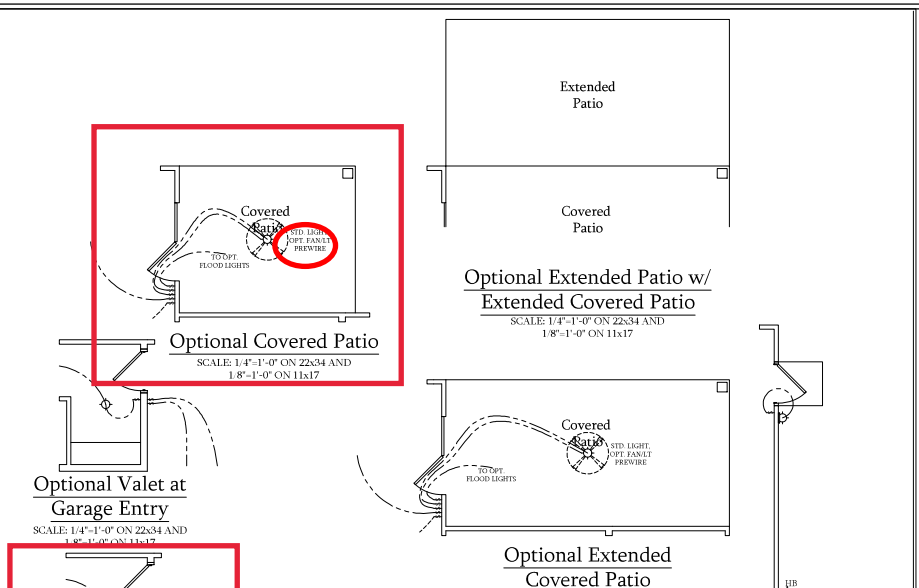
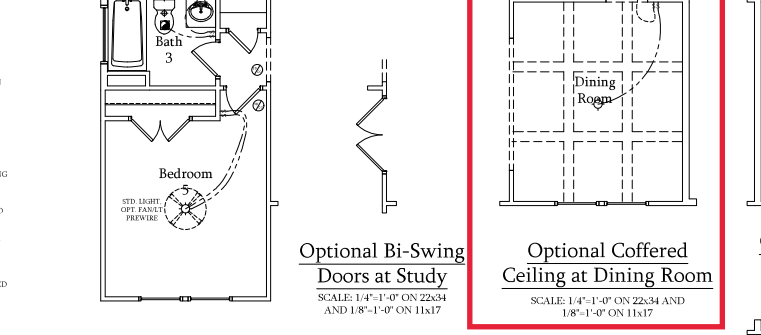
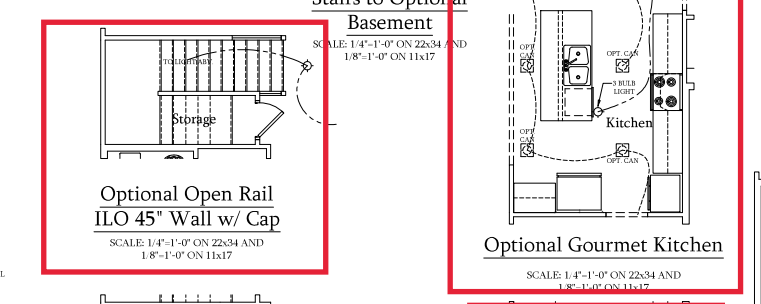
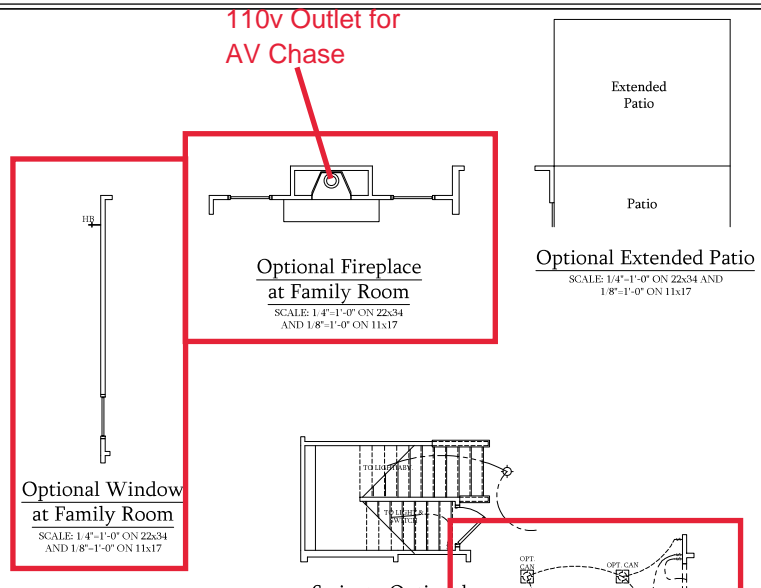

PRICE, PROMOTIONS, INCENTIVES, FEATURES, OPTIONS, FINANCING, AND CONSTRUCTION ARE SUBJECT TO CHANGE WITHOUT NOTICE. PERMITS ARE SUBJECT TO CHANGE WITHOUT NOTICE. SCHEDULES OF FINISHES AND CONSTRUCTION ARE SUBJECT TO CHANGE WITHOUT NOTICE. THIS PLAN IS A PRELIMINARY PLAN. THE FINISHED PLAN OF HOUSE OR LOT WILL BE FURNISHED BY THE DATE PLAN IS ISSUED. THIS PLAN IS A PRELIMINARY PLAN. THE FINISHED PLAN OF HOUSE OR LOT WILL BE FURNISHED BY THE DATE PLAN IS ISSUED. THIS PLAN IS A PRELIMINARY PLAN. THE FINISHED PLAN OF HOUSE OR LOT WILL BE FURNISHED BY THE DATE PLAN IS ISSUED. ANY USE, REPRODUCTION, ADAPTATION OR DISPLAY OF THIS PLAN WITHOUT THE WRITTEN PERMISSION OF DREAM FINDER'S HOMES IS STRICTLY PROHIBITED. © DREAM FINDER'S HOMES.

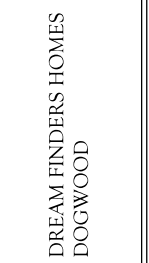

DATE: JANUARY 17, 2019  
 REV: FEBRUARY 01, 2022  
 SCALE: 1/4"-1'-0"  
 DRAWN BY:  
 ENGINEERED BY:  
 REVIEWED BY:  
 FIRST FLOOR ELECTRICAL PLAN - OPTIONS  
**E-1.1**

**ELECTRICAL LEGEND**

- 120V OUTLET
- 120V GFI OUTLET
- 120V SWITCHED OUTLET
- 120V BASEBOARD OUTLET
- 4 PLEX
- FLOOR MOUNTED 120V
- FLOOR MOUNTED 120V GFI
- WEATHERPROOF
- 220V OUTLET
- 120V DEDICATED CIRCUIT
- 220V DEDICATED CIRCUIT
- SPECIAL PURPOSE (240 V, ETC.)
- WALL MOUNT LIGHT
- CEILING MOUNT LIGHT
- PENDANT LIGHT
- RECESSED CAN LIGHT
- MINI CAN LIGHT
- INVESTAL LIGHT
- FLUORESCENT LIGHT
- UNDERCABINET LIGHT
- FLOOD LIGHT
- SWITCH
- 3-WAY SWITCH
- 4-WAY SWITCH
- DIMMER SWITCH
- TELEPHONE
- TV CONNECTION
- CONDUIT FOR COMPONENT WIRING
- SPEAKER
- COMBINATION CARBON MONOXIDE DETECTOR
- 110 V SMOKE DETECTOR
- EXHAUST FAN
- LOW VOLTAGE PANEL

- CEILING FAN
- CEILING FAN W/ LIGHT

**ELECTRICAL NOTES:**

1. PROVIDE AND INSTALL ALL GROUND FAULT CIRCUIT INTERRUPTERS (GFCI) AS INDICATED ON PLANS OR AS ITEM NO. 4 AND 5 BELOW INDICATES.
2. UNLESS OTHERWISE INDICATED, INSTALL SWITCHES AND RECEPTACLES AT THE FOLLOWING HEIGHTS ABOVE FINISHED FLOOR: SWITCHES - 42" OUTLETS - 14" TELEPHONE - 14" (UNLESS ASV COUNTERTOP) TELEVISION - 14"
3. ALL SMOKE DETECTORS SHALL BE HARDWIRED INTO AN ELECTRICAL POWER SOURCE AND SHALL BE EQUIPPED WITH A MONITORED BATTERY BACKUP. PROVIDE AND INSTALL LOCALLY CERTIFIED SMOKE DETECTORS.
4. ALL 15A AND 20A RECEPTACLES IN SLEEPING ROOMS, FAMILY ROOMS, DINING ROOMS, LIVING ROOMS, PARELORS, LIBRARIES, DEN, SUNROOMS, RECREATION ROOMS, CLOSETS, HALLWAYS, AND SMALL AREAS WILL REQUIRE A COMBINATION TYPE AFCI DEVICE AND TAMPER PROOF RECEPTACLES.
5. ALL 15A AND 20A 120V RECEPTACLES LOCATED IN THE GARAGE AND UTILITY ROOMS SHALL BE G.F.C.I. PROTECTED (G.F.I.).
6. IT IS THE RESPONSIBILITY OF THE LICENSED ELECTRICIAN TO ENSURE THAT ALL ELECTRICAL WORK IS IN FULL COMPLIANCE WITH ALL APPLICABLE LOCAL STANDARDS, CODES, AND ORDINANCES.
7. EVERY BUILDING HAVING A FOSSIL FUEL-BURNING HEATER OR APPLIANCE, FIREPLACE, OR AN ATTACHED GARAGE SHALL HAVE AN OPERATIONAL CARBON MONOXIDE DETECTOR INSTALLED WITHIN 10 FEET OF EACH ROOM USED FOR SLEEPING PURPOSES.
8. ALARMS SHALL RECEIVE THEIR PRIMARY POWER FROM THE BUILDING WIRING. WHEN SUCH WIRING IS SERVED FROM THE LOCAL POWER UTILITY, SUCH ALARMS SHALL HAVE BATTERY BACKUP. COMBINATION SMOKE/CARBON MONOXIDE ALARMS SHALL BE LISTED OR LABELED BY A NATIONALLY RECOGNIZED TESTING LABORATORY.

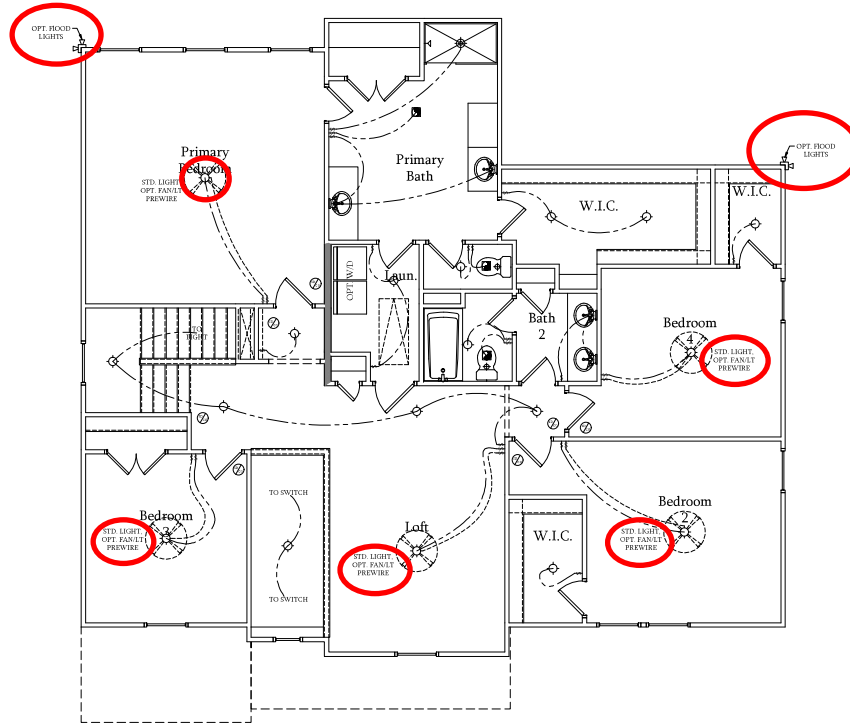

**Second Floor Plan**  
 SCALE: 1/4"=1'-0" ON 22x34 AND  
 1/8"=1'-0" ON 11x17



PRICE, PROMOTIONS, INCENTIVES, FEATURES, OPTIONS, AND FINANCING ARE SUBJECT TO CHANGE WITHOUT NOTICE. PERMITS ARE SUBJECT TO LOCAL REGULATIONS. ALL DIMENSIONS ARE IN FEET AND INCHES UNLESS OTHERWISE NOTED. MEASUREMENTS ARE TO FACE UNLESS OTHERWISE NOTED. THIS PLAN IS A PRELIMINARY CONCEPTUAL DESIGN. ALL DIMENSIONS ARE APPROXIMATE. THE CONTRACTOR SHALL VERIFY ALL DIMENSIONS AND CONDITIONS BEFORE BEGINNING WORK. THE CONTRACTOR SHALL BE RESPONSIBLE FOR OBTAINING ALL NECESSARY PERMITS AND FOR VERIFYING ALL LOCAL REGULATIONS. ANY USE, REPRODUCTION, ADAPTATION OR DISPLAY OF THIS PLAN WITHOUT THE WRITTEN PERMISSION OF DREAM FINDERS HOMES IS PROHIBITED. © 2012 DREAM FINDERS HOMES.

DREAM FINDERS HOMES  
 DOWNSIDE

DATE: JANUARY 17, 2019  
 REV: FEBRUARY 01, 2022  
 SCALE: 1/4"=1'-0"  
 DRAWN BY:  
 ENGINEERED BY:  
 REVIEWED BY:

SECOND FLOOR  
 ELECTRICAL PLAN  
 E-2



**KSE**  
**ENGINEERING**

1900 AM DRIVE, SUITE 201, QUAKERTOWN, PA 18951  
www.kse-eng.com (215) 804-4449

DOGWOOD  
RH  
NORTH CAROLINA

THESE DRAWINGS ARE TO BE USED IN CONJUNCTION WITH AND COORDINATED WITH THE ARCHITECTURAL, CIVIL, MECHANICAL, ELECTRICAL, AND PLUMBING DRAWINGS. THIS COORDINATION IS NOT THE RESPONSIBILITY OF THE STRUCTURAL ENGINEER OF RECORD (SER). SHOULD ANY DISCREPANCIES BECOME APPARENT, THE CONTRACTOR SHALL NOTIFY KSE ENGINEERING, P.C. BEFORE CONSTRUCTION BEGINS. IT IS THE INTENT OF THE ENGINEER LISTED ON THESE DOCUMENTS THAT THESE DOCUMENTS BE ACCURATE, PROVIDING LICENSED PROFESSIONALS CLEAR INFORMATION. EVERY ATTEMPT HAS BEEN MADE TO PREVENT ERROR. THE BUILDER AND ALL SUBCONTRACTORS ARE REQUIRED TO REVIEW ALL OF THE INFORMATION CONTAINED IN THESE DOCUMENTS PRIOR TO THE COMMENCEMENT OF ANY WORK. THE ENGINEER IS NOT RESPONSIBLE FOR ANY PLAN ERRORS, OMISSIONS, OR MISINTERPRETATIONS UNDETECTED AND NOT REPORTED TO THE ENGINEER PRIOR TO CONSTRUCTION. ALL CONSTRUCTION MUST BE IN ACCORDANCE TO THE INFORMATION FOUND IN THESE DOCUMENTS.

DESIGN SPECIFICATIONS:

DESIGN BUILDING CODE (REFERRED TO HEREIN AS "THE BUILDING CODE"):  
• 2018 NORTH CAROLINA RESIDENTIAL CODE. WALL BRACING PER INTERNATIONAL RESIDENTIAL CODE 2015 EDITION.

DESIGN LIVE LOADS:  
• ROOF = 20 PSF (LOAD DURATION FACTOR=1.25)  
• UNINHABITABLE ATTICS WITH LIMITED STORAGE = 20 PSF (WHERE SPECIFIED ON PLANS)  
• HABITABLE ATTICS AND ATTICS SERVED WITH FIXED STAIRS = 30 PSF  
• FLOOR = 40 PSF  
• FLOOR (SLEEPING AREAS) = 30 PSF  
• DECK = 40 PSF  
• BALCONY = 40 PSF  
• STAIRS = 40 PSF

DESIGN DEAD LOADS:  
• ROOF TRUSS = 17 PSF (TC=7, BC=10)  
• FLOOR TRUSS = 15 PSF (TC=10, BC=5)  
• FLOOR JOIST = 10 PSF  
• QUEEN ANNE BRICK = 25 PSF

\*NOTE: STRUCTURAL FRAMING HAS NOT BEEN DESIGNED FOR TILE, GRANITE, MARBLE OR OTHER MATERIALS HEAVIER THAN THE ABOVE LOADING UNLESS SPECIFICALLY NOTED ON PLANS.\*

DESIGN WIND LOADS:  
• ULTIMATE WIND SPEED = Up to 130 MPH  
• EXPOSURE CATEGORY = B

ASSUMED SOIL BEARING CAPACITY = 2000 PSF

ASSUMED LATERAL SOIL PRESSURE = 45 PCF

FROST DEPTH = 12"

SEISMIC DESIGN CATEGORY = B

ENGINEERED LUMBER SHALL HAVE THE FOLLOWING MINIMUM DESIGN VALUES:

- TJI 210 SERIES (SERIES AND SPACING PER PLANS)
- LSL: E=1,550,000 PSI, F<sub>b</sub>=2,325 PSI, F<sub>v</sub>=310 PSI, F<sub>c</sub>=900 PSI
- LVL: E=2,000,000 PSI, F<sub>b</sub>=2,600 PSI, F<sub>v</sub>=285 PSI, F<sub>c</sub>=750 PSI
- PSL: E=2,100,000 PSI, F<sub>b</sub>=2,900 PSI, F<sub>v</sub>=290 PSI, F<sub>c</sub>=625 PSI

THIS PLAN HAS BEEN DESIGNED PER THE 2018 EDITION OF THE NC RESIDENTIAL CODE. WHERE FRAMING, FOUNDATION, OR OTHER STRUCTURAL ITEMS DO NOT COMPLY WITH THE PRESCRIPTIVE METHODS OF THE CODE, THOSE ITEMS HAVE BEEN DESIGNED IN ACCORDANCE WITH ACCEPTED ENGINEERING PRACTICE PER NCRS R301.1.3.



KSE  
ENGINEERING

1900 AM DRIVE, SUITE 201, QUAKERTOWN, PA 18951  
www.kse-eng.com (215) 804-4449



T&H  
HOMES

Cover Sheet

Dogwood Model – RH  
Up to 130 M.P.H.  
Carolina Division

Project #: 105-16007  
Designed By: KRK  
Checked By:  
Issue Date: 4/9/19  
Re-Issue: 10/10/22  
Scale: 1/8"=1'-0" @ 11x17  
1/4"=1'-0" @ 22x34



S-0



**GENERAL STRUCTURAL NOTES:**

- THE DESIGN PROFESSIONAL WHOSE SEAL APPEARS ON THESE DRAWINGS IS THE STRUCTURAL ENGINEER OF RECORD (SER) FOR THIS PROJECT. THE SER BEARS THE RESPONSIBILITY OF THE PRIMARY STRUCTURAL ELEMENTS AND THE PERFORMANCE OF THIS STRUCTURE. NO OTHER PARTY MAY REVISE, ALTER, OR DELETE ANY STRUCTURAL ASPECTS OF THESE CONSTRUCTION DOCUMENTS WITHOUT WRITTEN CONSENT OF KSE ENGINEERING, P.C. OR THE SER. FOR THE PURPOSES OF THESE CONSTRUCTION DOCUMENTS, THE SER AND KSE ENGINEERING SHALL BE CONSIDERED THE SAME ENTITY.
- THIS STRUCTURE IS ONLY STABLE IN ITS COMPLETED FORM. THE CONTRACTOR SHALL PROVIDE ALL REQUIRED TEMPORARY BRACING DURING CONSTRUCTION TO STABILIZE THE STRUCTURE.
- THE SER IS NOT RESPONSIBLE FOR CONSTRUCTION SEQUENCES, METHODS, OR TECHNIQUES IN CONNECTION WITH THE CONSTRUCTION OF THIS STRUCTURE. THE SER WILL NOT BE HELD RESPONSIBLE FOR THE CONTRACTOR'S FAILURE TO CONFORM TO THE CONTRACT DOCUMENTS, SHOULD ANY NON-COMFORMITIES OCCUR.
- THE SER DOES NOT CERTIFY DIMENSIONAL ACCURACY OR ARCHITECTURAL LAYOUT INCLUDING ROOF GEOMETRY. THE SER ASSUMES NO LIABILITY FOR CHANGES MADE TO THESE PLANS BY OTHERS, OR FOR CONSTRUCTION METHODS, OR FOR ANY DEVIATION FROM THE PLANS. THE SER SHALL BE NOTIFIED PRIOR TO CONSTRUCTION IF ANY DISCREPANCIES ARE NOTED ON THE PLANS.
- ANY STRUCTURAL ELEMENTS OR DETAILS NOT FULLY DEVELOPED ON THE CONSTRUCTION DRAWINGS SHALL BE COMPLETED UNDER THE DIRECTION OF A LICENSED PROFESSIONAL ENGINEER. THESE SHOP DRAWINGS SHALL BE REVIEWED FOR ACTUAL FIELD CONDITIONS BEFORE ANY CONSTRUCTION BEGINS. THE SHOP DRAWINGS WILL BE REVIEWED FOR OVERALL COMPLIANCE AS IT RELATES TO THE STRUCTURAL DESIGN OF THIS PROJECT. VERIFICATION OF THE SHOP DRAWINGS FOR OVERALL COMPLIANCE IS THE RESPONSIBILITY OF THE SER OR KSE ENGINEERING, P.C. VERIFICATION OF ASSUMED FIELD CONDITIONS IS NOT THE RESPONSIBILITY OF THE SER. THE CONTRACTOR SHALL VERIFY THE FIELD CONDITIONS FOR ACCURACY AND REPORT ANY DISCREPANCIES TO KSE ENGINEERING, P.C. BEFORE CONSTRUCTION BEGINS.
- THE SER IS NOT RESPONSIBLE FOR ANY SECONDARY STRUCTURAL ELEMENTS OR NON-STRUCTURAL ELEMENTS, EXCEPT FOR THE ELEMENTS SPECIFICALLY NOTED ON THE STRUCTURAL DRAWINGS.
- THIS STRUCTURE AND ALL CONSTRUCTION SHALL CONFORM TO ALL APPLICABLE SECTIONS OF THE BUILDING CODE AND ANY LOCAL CODES OR RESTRICTIONS.
- DO NOT SCALE DRAWINGS. WRITTEN DIMENSIONS TAKE PRECEDENCE OVER SCALED DIMENSIONS. ALL DIMENSIONS ARE TO FACE OF STUD OR TO FACE OF FRAMING UNLESS OTHERWISE NOTED.
- PROVIDE MOISTURE PROTECTION AND FLASHING PER ARCHITECTURAL DETAILS.

**FOUNDATIONS:**

- FOUNDATIONS SHALL BE CONSTRUCTED IN ACCORDANCE WITH CHAPTER 4 OF THE BUILDING CODE.
- THE CONTRACTOR IS SOLELY RESPONSIBLE FOR VERIFYING THE SATURABILITY OF THE SITE SOIL CONDITIONS AT THE TIME OF CONSTRUCTION. THE BUILDER SHALL FURNISH ANY AND ALL REPORTS RECEIVED FROM THE GEOTECHNICAL ENGINEER ON THE STUDY OF THE PROPOSED SITE TO THE DESIGNER, STRUCTURAL ENGINEER, AND GENERAL CONTRACTOR.
- MAXIMUM DEPTH OF UNBALANCED FILL AGAINST MASONRY WALLS TO BE AS SPECIFIED IN THE BUILDING CODE.
- THE SER HAS NOT PERFORMED A SUBSURFACE INVESTIGATION. VERIFICATION OF THE ASSUMED VALUE IS THE RESPONSIBILITY OF THE OWNER OR THE CONTRACTOR. SHOULD ANY ADVERSE SOIL CONDITION BE ENCOUNTERED, THE SER MUST BE CONTACTED BEFORE PROCEEDING.
- THE BOTTOM OF ALL FOOTINGS SHALL EXTEND BELOW THE FROST LINE FOR THE REGION IN WHICH THE STRUCTURE IS TO BE CONSTRUCTED, BUT NOT LESS THAN A MINIMUM OF 12" BELOW GRADE. ALL FOOTINGS TO HAVE A MINIMUM PROJECTION OF 2" ON EACH SIDE OF FOUNDATION WALLS. MAXIMUM FOOTING PROJECTION SHALL NOT EXCEED THE THICKNESS OF THE FOOTING.
- WOOD SILL PLATES SHALL BE ANCHORED TO THE FOUNDATION WITH  $\frac{1}{2}$ " ANCHOR BOLTS WITH MINIMUM 7" EMBEDMENT, SPACED A MAXIMUM OF 6'-0" O.C. INSTALL MINIMUM 2 ANCHOR BOLTS PER SECTION, 12" MAXIMUM FROM CORNERS.  $\frac{3}{4}$ " DIAMETER x 8" LONG SIMPSON TITEN HD OR USF SCREW-BOLT+ SCREWS MAY BE SUBSTITUTED ON A 1' FOR 1 BASIS.
- ANY FILL SHALL BE PLACED UNDER THE DIRECTION OR RECOMMENDATION OF A LICENSED PROFESSIONAL ENGINEER. THE RESULTING SOIL SHALL BE COMPACTED TO A MINIMUM OF 95% MAXIMUM DRY DENSITY.
- EXCAVATIONS OF FOOTINGS SHALL BE LINED TEMPORARILY WITH A 6 MIL POLYETHYLENE MEMBRANE IF PLACEMENT OF CONCRETE DOES NOT OCCUR WITHIN 24 HOURS OF EXCAVATION.
- NO CONCRETE SHALL BE PLACED AGAINST ANY SUBGRADE CONTAINING WATER, ICE, FROST, OR LOOSE MATERIAL.
- PROVIDE FOUNDATION WATERPROOFING AND DRAIN WITH POSITIVE SLOPE TO OUTLET AS REQUIRED BY SITE CONDITIONS (SEE ARCHITECTURAL PLANS AND DETAILS).
- NONE OF THE FOUNDATION DESIGNS IN THESE DOCUMENTS ARE SUITABLE FOR INSTALLATION IN SHRINK/SWELL CONDITIONS. REFER TO GEOTECHNICAL ENGINEER FOR APPROPRIATE DESIGN.
- LOTS SHALL BE GRADED TO DRAIN SURFACE WATER AWAY FROM FOUNDATION WALLS. THE GRADE SHALL FALL A MINIMUM OF 6 INCHES WITHIN THE FIRST TEN FEET.
- CRAWL SPACE TO BE GRADED LEVEL AND CLEAR OF ALL DEBRIS.
- PROVIDE MINIMUM 6 MIL APPROVED VAPOR BARRIER. ALL JOINTS TO BE LAPPED MINIMUM 12" AND SEALED.

**CONCRETE & REINFORCING**

- CONCRETE DESIGN BASED ON ACI 318 AND ACI 318.1R OR ACI 332. CONCRETE SHALL HAVE A NOMINAL COMPRESSIVE STRENGTH (F<sub>c</sub>) OF 3,000 PSI MINIMUM AT 28 DAYS PER CODE (VARIES W/ WEATHER), UNLESS OTHERWISE NOTED ON THE PLAN.
- CONCRETE SHALL BE PROPORTIONED, MIXED, AND PLACED IN ACCORDANCE WITH THE LATEST EDITIONS OF ACI 318: "BUILDING CODE REQUIREMENTS FOR REINFORCED CONCRETE AND ACI 308: "SPECIFICATIONS FOR STRUCTURAL CONCRETE FOR BUILDINGS".
- AIR ENTRAINED CONCRETE MUST BE USED FOR ALL STRUCTURAL ELEMENTS EXPOSED TO FREEZE/THAW CYCLES AND DEICING CHEMICALS. AIR ENTRAINMENT AMOUNTS (IN PERCENT) SHALL BE WITHIN -1% TO +2% OF 5% FOR FOOTINGS AND EXTERIOR SLABS.
- NO ADMIXTURES SHALL BE ADDED TO ANY STRUCTURAL CONCRETE WITHOUT WRITTEN PERMISSION OF THE SER. WATER ADDED TO CONCRETE ON SITE SHALL NOT EXCEED THAT ALLOWED BY THE MIX DESIGN.
- CONCRETE SLABS-ON-GRADE SHALL BE CONSTRUCTED IN ACCORDANCE WITH ACI 302.1R: "GUIDE FOR CONCRETE SLAB AND SLAB CONSTRUCTION".
- CONTROL OR SAW CUT JOINTS (CUT OR TOOLED) SHALL BE SPACED IN INTERIOR SLABS-ON-GRADE AT A MAXIMUM OF 15'-0" O.C. AND IN EXTERIOR SLABS-ON-GRADE AT A MAXIMUM OF 10'-0" UNLESS OTHERWISE NOTED. CARE SHALL BE TAKEN TO AVOID RE-ENTRANT CORNERS.
- CONTROL OR SAW CUT JOINTS SHALL BE PRODUCED USING CONVENTIONAL CUT OR TOOLED PROCESSES WITHIN 4 TO 12 HOURS AFTER THE SLAB HAS BEEN FINISHED.
- ALL WELDED WIRE FABRIC (W.W.F.) FOR CONCRETE SLABS-ON-GRADE SHALL BE PLACED AT MID-DEPTH OF SLAB. THE W.W.F. SHALL BE SECURELY SUPPORTED DURING THE CONCRETE POUR. FIBROUS CONCRETE REINFORCING, OR POLYPROPYLENE FIBERS MAY BE USED IN LIEU OF W.W.F. APPLICATION OF POLYPROPYLENE FIBERS PER CUBIC YARD OF CONCRETE SHALL BE PER MANUFACTURER AND COMPLY WITH ASTM C1116, ANY LOCAL BUILDING CODE REQUIREMENTS AND SHALL MEET OR EXCEED CURRENT INDUSTRY STANDARDS.
- POLYPROPYLENE REINFORCING TO BE 100% VIRGIN, CONTAINING NO REPROCESSED OLEFIN MATERIALS AND SPECIFICALLY MANUFACTURED FOR USE AS CONCRETE SECONDARY REINFORCING.
- ALL REINFORCING SHALL BE NEW BILLET STEEL CONFORMING TO ASTM A615, GRADE 60.
- DETAILING, FABRICATION, AND PLACEMENT OF REINFORCING STEEL SHALL BE IN ACCORDANCE WITH THE LATEST EDITION OF ACI 318: "MANUAL OF STANDARD PRACTICE FOR DETAILING CONCRETE STRUCTURES".
- HORIZONTAL FOOTING AND WALL REINFORCEMENT SHALL BE CONTINUOUS AND SHALL HAVE 90° BENDS, OR CORNER BARS WITH THE SAME SIZE/SPACING AS THE HORIZONTAL REINFORCEMENT.
- PROVIDE REINFORCEMENT LAP AS NOTED BELOW, UNLESS NOTED OTHERWISE:
  - #4 BARS - 30" LENGTH
  - #5 BARS - 36" LENGTH
  - #6 BARS - 45" LENGTH
- WHERE REINFORCING DOWELS ARE REQUIRED, THEY SHALL BE EQUIVALENT IN SIZE AND SPACING TO THE VERTICAL REINFORCEMENT. THE DOWEL SHALL EXTEND 48 BAR DIAMETERS VERTICALLY AND 20 BAR DIAMETERS INTO THE FOOTING. SEE KSE FOUNDATION DETAILS.
- WHERE FOOTING BOTTOMS ARE TO BE STEPPED AT SLOPING GRADE CONDITIONS, PROVIDE CONTINUOUS REINFORCING WITH 2 BARS TO MATCH FOOTING REINFORCING AS REQUIRED.
- BAR SUPPORT ACCESSORIES SHALL BE PROVIDED IN ACCORDANCE WITH THE LATEST ACI MANUAL OF STANDARD PRACTICE FOR DETAILING REINFORCED CONCRETE STRUCTURES, EXCEPT THAT REINFORCING SHALL BE CHARGED ON THE BOTTOM AND/OR THE SIDES ON BOLSTERS SPACED NOT MORE THAN 4 FEET ON CENTER. NO ROCKS, CMU, CLAY TILE, OR BRICK SHALL BE USED TO SUPPORT REINFORCING.
- FOR GRADE SUPPORTED SLABS, SLAB REINFORCING SHALL BE HELD IN PLACE BY BAR SUPPORTS AND ACCESSORIES AS DESCRIBED IN THE CRESI MANUAL OF STANDARD PRACTICE. BAR SUPPORTS SHALL BE SPACED A MAXIMUM OF 4'-0" O.C. BOTH WAYS IN STRAIGHT LINES ON THE MESH GRID.

**MASONRY**

- ALL MASONRY SHALL CONFORM TO ASTM C-90, F<sub>m</sub>=1500 PSI. ALL BRICK SHALL CONFORM TO ASTM C-216, F<sub>m</sub>=1500 PSI. ALL MORTAR SHALL BE TYPE "S" (TYPE "M" BELOW GRADE) AND CONFORM TO ASTM C-270.
- ALL MASONRY WORK SHALL BE IN ACCORDANCE WITH "BUILDING CODE REQUIREMENTS FOR MASONRY STRUCTURES" ACI 530/ASCE 5/TMS 402 AND "SPECIFICATIONS FOR MASONRY STRUCTURES" ACI 530.1/ASCE 6/TMS 602.
- THE UNSUPPORTED HEIGHT OF SOLID MASONRY PIERS SHALL NOT EXCEED TEN TIMES THEIR LEAST DIMENSION. UNFILLED HOLLOW PIERS SHALL BE USED IF THE UNSUPPORTED HEIGHT IS NOT MORE THAN FOUR TIMES THEIR LEAST DIMENSION.
- EACH CRAWL SPACE PIER SHALL BEAR IN THE MIDDLE THIRD OF ITS RESPECTIVE FOOTING AND EACH ORDER SHALL BEAR IN THE MIDDLE THIRD OF THE PIERS. PLASTERS TO BE BONDED TO PERIMETER FOUNDATION WALL.
- TOP COURSE OF MASONRY SHALL BE GROUDED SOLID.
- HORIZONTAL WALL JOINT REINFORCEMENT SHALL BE STANDARD 9 GAGE GALVANIZED LATCHER OR OTHER TYPE SPACED AT 16" O.C., UNLESS SHOWN OTHERWISE ON THE DRAWINGS.
- SPUNCE WIRE REINFORCEMENT SHALL BE LAPPED AT LEAST 6" AND CONTAIN AT LEAST ONE CROSS WIRE OF EACH PIECE OF REINFORCEMENT WITHIN THE 6". LAP WITH STANDARD "I" AND "L" SHAPED PIECES AT INTERSECTIONS AND CORNERS.

**WOOD FRAMING:**

- SOLID SAWN WOOD FRAMING MEMBERS SHALL CONFORM TO THE SPECIFICATIONS LISTED IN THE LATEST EDITION OF THE "NATIONAL DESIGN SPECIFICATION FOR WOOD CONSTRUCTION" (NDS), UNLESS OTHERWISE NOTED. ALL WOOD FRAMING MEMBERS ARE DESIGNED TO BE:
  - SPRUCE-PINE-FIR (SPF) WITH THE FOLLOWING MINIMUM DESIGN REQUIREMENTS FOR REINFORCED CONCRETE:
    - E=1,400,000 PSI, F<sub>v</sub>=875 PSI, F<sub>v</sub>=135 PSI
    - 1.1. FRAMING: SPF #2.
    - 1.2. PLATES: SPF #2.
    - 1.3. STUDS: SPF STUD GRADE.
- WALL STUD SPACING: (MAXIMUM 10' NOMINAL PLATE HEIGHT):
  - 1 & 2 STORY EXTERIOR AND INTERIOR BEARING: 24x @ 16" O.C. OR 2x6 @ 24" O.C., U.N.O.
  - BOTTOM OF 3 STORIES EXTERIOR AND INTERIOR BEARING: 2x6 @ 16" O.C., U.N.O.
  - INTERIOR NON-BEARING: 2x @ 24" O.C., U.N.O.
- LUMBER EXPOSED TO WEATHER OR IN CONTACT WITH CONCRETE SHALL BE PRESERVATIVE TREATED SOUTHERN YELLOW PINE #2 OR BETTER.
- ANCHOR SILL PLATES IN ACCORDANCE W/ GENERAL STRUCTURAL NOTES.
- ALL BEAMS SPECIFIED ARE MINIMUM SIZES ONLY. LARGER MEMBERS MAY BE SUBSTITUTED AS NEEDED FOR EASE OF CONSTRUCTION.
- NAILS SHALL BE COMMON WIRE NAILS UNLESS OTHERWISE NOTED.
- BOLT HOLES SHALL BE DRILLED AND SCREWS SHALL BE IN ACCORDANCE WITH NDS SPECIFICATIONS.
- INDIVIDUAL STUDS FORMING A COLUMN SHALL BE ATTACHED WITH (2) ROWS 10x 10x @ 6" O.C. STAGGERED. THE STUD COLUMN SHALL BE FULLY BLOCKED AT ALL FLOOR LEVELS TO ENSURE PROPER LOAD TRANSFER. WOOD STUDS SHALL BE NAILED TO EDGE OF EACH STUD.
- FACE NAIL ALL MULTI-PLY BEAMS AND HEADERS WITH (2) ROWS 16d COMMON NAILS @ 16" O.C., STAGGERED, OR PER MANUFACTURER'S SPECIFICATIONS FOR ENGINEERED LUMBER. APPLY NAILING FROM BOTH FACES FOR (3) OR MORE PLYS.
- FASTEN 4-PLY BEAMS WITH (1)  $\frac{1}{2}$ " DIAMETER THROUGH BOLT W/ NUTS AND WASHERS AT 12" O.C. STAGGERED TOP AND BOTTOM.  $\frac{1}{2}$ " MINIMUM EDGE DISTANCE. (UNLESS OTHERWISE NOTED).
- ALL BEAMS AND HEADERS SHALL HAVE (1)2x JACK STUD & (1)2x KING STUD UNLESS OTHERWISE NOTED. THE NUMBER OF STUDS INDICATED ON PLANS ARE THE TOTAL NUMBER OF JACK STUDS REQUIRED, UNLESS OTHERWISE NOTED.
- PROVIDE KING STUDS AT EACH END OF HEADERS AS NOTED BELOW.
  - (1) STUD UP TO 8' OPENING
  - (2) STUDS UP TO 8' OPENING
  - (3) STUDS UP TO 9' OPENING
- ALL BEAMS TO BE CONTINUOUSLY SUPPORTED LATERALLY AND SHALL BEAR FULL WIDTH ON THE SUPPORTING WALLS OR COLUMNS INDICATED WITH A MINIMUM OF TWO STUDS, UNLESS OTHERWISE NOTED. ALL BEAM SPLICES SHALL OCCUR AT SUPPORTS.
- SOLID BLOCKING TO BE PROVIDED AT ALL POINT LOADS THROUGH FLOOR LEVELS TO THE FOUNDATION OR TO OTHER STRUCTURAL COMPONENTS.
- ALL LUMBER SPECIFIED ON DRAWINGS IS INTENDED FOR DRY USE ONLY (MOISTURE CONTENT <19% UNLESS OTHERWISE NOTED).
- WATERPROOFING AND DRAIN SAFETY SYSTEMS ARE THE RESPONSIBILITY OF THE CONTRACTOR AND ARE TO BE DESIGNED AND DETAILED BY OTHERS.
- ANY WOOD FRAME INTERIOR BEARING WALL STUDS THAT HAVE HOLES IN THE CENTER OF THE STUD UP TO 1" DIAMETER SHALL HAVE STUD PROTECTION SHIELDS, ALL HOLES OVER 1" IN DIAMETER FOR PLUMBING LINES, ETC. SHALL BE REPAIRED WITH SIMPSON HSS2 OR USP S151 STUD SHOES, TYPICAL, UNLESS OTHERWISE NOTED.
- BEARING WALLS SHALL BE SHEATHED NOT LESS THAN ONE SIDE WITH OSB OR GYPSUM BOARD. BRIGING SHALL BE INSTALLED NOT GREATER THAN 4 FEET APART MEASURED VERTICALLY FROM EITHER END OF THE STUD IN LINE OF SHEATHING.
- DIAGONAL BRACING SHALL BE INSTALLED AT EACH END OF BASEMENT BEARING WALLS AND NOT MORE THAN 20' ON CENTER.

**EXTERIOR WOOD FRAMED DECKS:**

- DECKS ARE TO BE FRAMED IN ACCORDANCE WITH APPLICABLE BUILDING CODES AND AS REFERENCED ON THE STRUCTURAL PLANS, EITHER THROUGH CODE REFERENCES OR CONSTRUCTION DETAILS.
- PRESERVATIVE TREATED WOOD FRAMING TO BE SOUTHERN YELLOW PINE #2 OR BETTER.
- GUARD RAILS REQUIRED AT DECKS. DESIGN BY OTHERS TO MEET MINIMUM CODE REQUIREMENTS.
- PROVIDE DECK LATERAL LOAD AND BRACING CONNECTIONS PER BUILDING CODE.

**RAFTER FRAMED ROOF CONSTRUCTION:**

- PROVIDE 2x4x4'-0" RAFTER TIES AT 48" O.C.
- RAFTERS SHALL BE SUPPORTED BY PURLINS AND PURLIN BRACES AS SHOWN ON THE PLAN. PURLIN BRACES SHALL NOT BEAR ON ANY CEILING JOIST, STRINGBACK OR HEADER UNLESS SPECIFICALLY SHOWN ON PLAN. RAFTERS MAY BE SPLICED AT PURLIN LOCATIONS.
- CENDING JOISTS SHALL HAVE LATERAL SUPPORT W/ 1x4 FLAT BRACING ON TOP EDGE OF JOIST AT LOOSE JOIST ENDS (WHERE JOISTS NOT FASTENED TO RAFTERS) OR FULL DEPTH BLOCKING. FASTEN END OF BRACING TO RAFTER OR FULL END FRAMING.
- FASTEN RAFTER AND CEILING JOIST WITH (6) 12d NAILS UNLESS OTHERWISE NOTED.
- PROVIDE VERTICAL 2x6 STRINGBACKS AT CEILING JOISTS @ 8'-0" O.C. THE STRINGBACK ENDS TO GABLE STUDS OR RAFTERS WHERE POSSIBLE. PROVIDE BLOCKING BETWEEN TOP PLATES AND STRINGBACKS. PROVIDE 2x4 FLAT FASTENED TO EACH JOIST WITH (2) 12d NAILS. FASTEN STRINGBACK TO 2x4 FLAT WITH 12d NAILS @ 12" O.C. AND FASTENED TO EACH JOIST WITH (1) 12d TOWEL.

**WOOD TRUSSES (FLOOR & ROOF):**

- THE WOOD TRUSS MANUFACTURER/FABRICATOR IS RESPONSIBLE FOR THE DESIGN OF THE WOOD TRUSSES. SUBMIT SEALED SHOP DRAWINGS AND SUPPORTING CALCULATIONS TO THE SER FOR REVIEW PRIOR TO FABRICATION. THE SER SHALL HAVE A MINIMUM OF (5) DAYS FOR REVIEW. THE REVIEW BY THE SER SHALL BE FOR OVERALL COMPLIANCE OF THE DESIGN DOCUMENTS. THE SER SHALL ASSUME NO RESPONSIBILITY FOR THE CORRECTNESS OF THE STRUCTURAL DESIGN OF THE WOOD TRUSSES.
- THE WOOD TRUSSES SHALL BE DESIGNED FOR ALL REQUIRED LOADINGS AS SPECIFIED IN THE LOCAL BUILDING CODE, THE ASCE STANDARD "MINIMUM DESIGN LOADS FOR BUILDINGS AND OTHER STRUCTURES" (ASCE 7), AND THE LOADING REQUIREMENTS SHOWN ON THESE SPECIFICATIONS. THE TRUSS DRAWINGS SHALL BE COORDINATED WITH ALL OTHER CONSTRUCTION DOCUMENTS AND PROVISIONS PROVIDED FOR LOADS SHOWN ON THESE DRAWINGS INCLUDING BUT NOT LIMITED TO HVAC EQUIPMENT, PIPING, AND ARCHITECTURAL FIXTURES ATTACHED TO THE TRUSSES.
- THE TRUSSES SHALL BE DESIGNED, FABRICATED, AND ERECTED IN ACCORDANCE WITH THE LATEST EDITION OF THE ANSI/TFP 1: "NATIONAL DESIGN STANDARD FOR METAL PLATE CONNECTED WOOD TRUSS CONSTRUCTION".
- THE TRUSS MANUFACTURER SHALL PROVIDE ADEQUATE BRACING INFORMATION IN ACCORDANCE WITH "BUILDING COMPONENT SAFETY INFORMATION GUIDE TO GOOD PRACTICE FOR HANDLING, INSTALLING, RESTRAINING & BRACING OF METAL CONNECTED WOOD TRUSSES" (BCS). THIS BRACING, BOTH TEMPORARY AND PERMANENT, SHALL BE SHOWN ON THE SHOP DRAWINGS. ALSO, THE SHOP DRAWINGS SHALL SHOW THE REQUIRED ATTACHMENTS FOR THE TRUSSES.
- THE CONTRACTOR IS RESPONSIBLE FOR INSTALLING TEMPORARY BRACING UNLESS OTHERWISE NOTED. BRACING SHALL BE AS REQUIRED DURING CONSTRUCTION. AT A MINIMUM, CONTRACTOR SHALL FOLLOW THE REQUIREMENTS OF THE LATEST BCSI. THE CONTRACTOR SHALL KEEP A COPY OF THE BCSI SUMMARY SHEETS ON SITE.
- THE CONTRACTOR IS RESPONSIBLE FOR INSTALLING ALL PERMANENT TRUSS BRACING SHOWN IN THE STRUCTURAL DRAWINGS AND IN THE TRUSS DESIGNS. ALL CONTINUOUS LATERAL BRACING OF WEBS REQUIRES BRACES. REFER TO BCSI SUMMARY SHEET B3 FOR TYPES OF DIAGONAL BRACES TO PROVIDE AT EACH CONTINUOUS LATERAL BRACE LINE. SUCH DIAGONAL BRACES SHALL NOT BE SPACED MORE THAN 20 FEET O.C. DIAGONAL BRACES SHALL BE FASTENED TO EACH TRUSS WEB WITH A MINIMUM OF TWO 10d FACE NAILS. WHERE CONTINUOUS LATERAL BRACING IS NOT SHOWN ON THE DRAWINGS, BRACING SHALL BE PROVIDED AT ADJACENT TRUSSES NOT BEING IDENTICAL. THE CONTRACTOR SHALL COORDINATE WITH THE TRUSS SPECIALTY ENGINEER/MANUFACTURER TO DETERMINE WHAT TYPE OF ALTERNATE BRACE (I.E., T OR L BRACE, ETC.) IS REQUIRED.
- ANY CHORDS OR TRUSS WEBS SHOWN ON THESE DRAWINGS HAVE BEEN SHOWN AS A REFERENCE ONLY. THE FINAL DESIGN OF THE TRUSSES SHALL BE PER THE MANUFACTURER.
- TRUSS LAYOUT AND PLACEMENT BY MANUFACTURER TO CONCORD WITH THE BRACING LAYOUT SHOWN ON THE SEALED STRUCTURAL DRAWINGS. TRUSS PROFILES TO BE SEALED BY THE TRUSS MANUFACTURER. TRUSS PLANS TO BE COORDINATED WITH THE SEALED STRUCTURAL DRAWINGS.
- TRUSS MANUFACTURER TO PROVIDE REQUIRED UPLIFT CONNECTORS FOR ALL TRUSSES.
- PROVIDE SIMPSON H254, USP RT7 OR EQUIVALENT AT EACH TRUSS TO TOP PLATE CONNECTION, UNLESS OTHERWISE NOTED.

**WOOD STRUCTURAL PANELS:**

- FABRICATION AND PLACEMENT OF STRUCTURAL WOOD SHEATHING SHALL BE IN ACCORDANCE WITH THE APA DESIGN/CONSTRUCTION GUIDE "RESIDENTIAL AND COMMERCIAL", AND ALL OTHER APPLICABLE APA STANDARDS.
- ALL REQUIRED WOOD SHEATHING SHALL BEAR THE MARK OF THE APA.
- WOOD WALL SHEATHING SHALL COMPLY WITH THE REQUIREMENTS OF LOCAL BUILDING CODES FOR THE APPROPRIATE STATE AS INDICATED ON THESE DRAWINGS. REFER TO WALL BRACING NOTES IN PLAN SET FOR MORE INFORMATION. EXTERIOR WALLS TO BE FULLY SHEATHED USING  $\frac{7}{8}$ " OSB OR PLYWOOD MINIMUM. AT BRACED WALL PANELS, PROVIDE BLOCKING AT ALL SHEET EDGES NOT FALLING ON STUDS OR PLATES.
- ROOF SHEATHING SHALL BE APA RATED SHEATHING EXPOSURE 1 OR 2. ROOF SHEATHING SHALL BE CONTINUOUS OVER TWO SUPPORTS MINIMUM AND ATTACHED TO ITS SUPPORTING ROOF FRAMING WITH 8d NAILS AT 6" O.C. AT PANEL EDGES AND AT 12" O.C. IN PANEL FIELD UNLESS OTHERWISE NOTED ON THE PLANS. SHEATHING SHALL BE APPLIED WITH THE LONG DIRECTION PERPENDICULAR TO FRAMING. SHEATHING SHALL HAVE A SPAN RATING CONSISTENT WITH THE FRAMING SPACING. PROVIDE SUITABLE EDGE SUPPORT BY USE OF PLYWOOD CLIPS OR LUMBER BLOCKING UNLESS OTHERWISE NOTED. PANEL END JOINTS SHALL OCCUR OVER FRAMING. ROOF SHEATHING TO BE  $\frac{7}{8}$ " OSB MINIMUM.
- WOOD FLOOR SHEATHING SHALL BE APA RATED SHEATHING EXPOSURE 1 OR 2. ATTACH SHEATHING TO ITS SUPPORTING FRAMING WITH (1) 10d NAIL AT 6" O.C. AT PANEL EDGES AND AT 12" O.C. IN PANEL FIELD UNLESS OTHERWISE NOTED ON THE PLANS. SHEATHING SHALL BE APPLIED PERPENDICULAR TO FRAMING. SHEATHING SHALL HAVE A SPAN RATING CONSISTENT WITH THE FRAMING SPACING. PROVIDE SUITABLE EDGE SUPPORT BY USE OF T&G PLYWOOD OR LUMBER BLOCKING UNLESS OTHERWISE NOTED. PANEL END JOINTS SHALL OCCUR OVER FRAMING.
- SHEATHING SHALL HAVE A  $\frac{1}{8}$ " GAP AT PANEL ENDS AND EDGES AS RECOMMENDED IN ACCORDANCE WITH THE APA.

**STRUCTURAL FIBERBOARD PANELS:**

- STRUCTURAL FIBERBOARD SHEATHING SHALL ONLY BE USED WHERE SPECIFICALLY NOTED ON THE STRUCTURAL PLANS.
- FABRICATION AND PLACEMENT OF STRUCTURAL FIBERBOARD SHEATHING SHALL BE IN ACCORDANCE WITH THE APPLICABLE AFA STANDARDS.
- FIBERBOARD WALL SHEATHING SHALL COMPLY WITH THE REQUIREMENTS OF LOCAL BUILDING CODES FOR THE APPROPRIATE STATE AS INDICATED ON THESE DRAWINGS. REFER TO WALL BRACING NOTES IN PLAN SET FOR MORE INFORMATION.
- SHEATHING SHALL HAVE A  $\frac{1}{8}$ " GAP AT PANEL ENDS AND EDGES AS RECOMMENDED IN ACCORDANCE WITH THE AFA.

**STRUCTURAL STEEL:**

- STRUCTURAL STEEL SHALL BE FABRICATED AND ERECTED IN ACCORDANCE WITH THE AMERICAN INSTITUTE OF STEEL CONSTRUCTION "CODE OF STANDARD PRACTICE FOR STEEL BUILDINGS AND BRIDGES" AND OF THE MANUAL OF STEEL CONSTRUCTION "LOAD RESISTANCE FACTOR DESIGN" LATEST EDITIONS.
- ALL STEEL SHALL HAVE A MINIMUM YIELD STRESS (F<sub>y</sub>) OF 50 KSI UNLESS OTHERWISE NOTED.
- WELDING SHALL CONFORM TO THE LATEST EDITION OF THE AMERICAN WELDING SOCIETY'S STRUCTURAL WELDING CODE AWA D1.1. ELECTRODES FOR SHOP AND FIELDING WELDING SHALL BE CLASS E70XX. ALL WELDING SHALL BE PERFORMED BY A CERTIFIED WELDER PER THE ABOVE STANDARDS.
- ALL STEEL BEAMS TO BE SUPPORTED AT EACH END WITH A MINIMUM BEARING LENGTH OF 3x $\frac{1}{2}$ " AND FULL FLANGE WIDTH UNLESS OTHERWISE NOTED. BEAMS MUST BE ATTACHED AT EACH END WITH A MINIMUM OF FOUR 16d NAILS OR (2)  $\frac{1}{2}$ " x 4" LAG SCREWS UNLESS OTHERWISE NOTED.
- INSTALL 2x WOOD PLATE ON TOP OF STEEL BEAMS, RIPPED TO MATCH BEAM WIDTH. FASTEN PLATE TO BEAM W/ HLTI X-DNI 52 PC PINS AT 12" O.C. STAGGERED OR  $\frac{1}{2}$ " DIAMETER BOLTS AT 24" O.C.

**MECHANICAL FASTENERS:**

- ALL METAL HARDWARE AND FASTENERS TO BE SIMPSON STRONG-TIE OR APPROVED EQUIVALENT.
- ALL HARDWARE AND FASTENERS IN CONTACT WITH PRESERVATIVE PRESSURE TREATED LUMBER SHALL BE HOT DIPPED GALVANIZED IN ACCORDANCE WITH ASTM A 153, G-185.
- MANY OF THE NEW PRESURE TREATED WOODS USE CHEMICALS THAT ARE CORROSIVE TO STEEL. IT IS THE CONTRACTOR'S RESPONSIBILITY TO VERIFY THE TYPE OF WOOD TREATMENT AND SELECT APPROPRIATE CONNECTORS THAT WILL RESIST THE APPLICABLE CORROSIVE CHEMICALS.

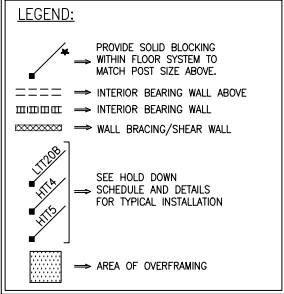

SPAN	LINTEL SIZE	END BEARING
UP TO 3'-0"	5"x3"x3/4"	4"
UP TO 6'-3"	5"x3"x3/4" L.L.V.	8"
UP TO 9'-6"	6"x3"x3/4" L.L.V.	12"

LINTELS ARE NOT DESIGNED TO BE BOLTED TO HEADERS UNLESS SPECIFIED ON UNIT PLANS.  
SPANS OVER 4'-0" SHALL BE SHORED UP UNTIL CURED.



General Structural Notes  
Up to 130 M.P.H.  
North Carolina

Project #: 105-19000  
Designed By: KSK  
Checked By:  
Issue Date: 1/1/19  
Re-issues:  
Scale: 1/8"=1'-0" @ 11x17  
1/4"=1'-0" @ 22x34



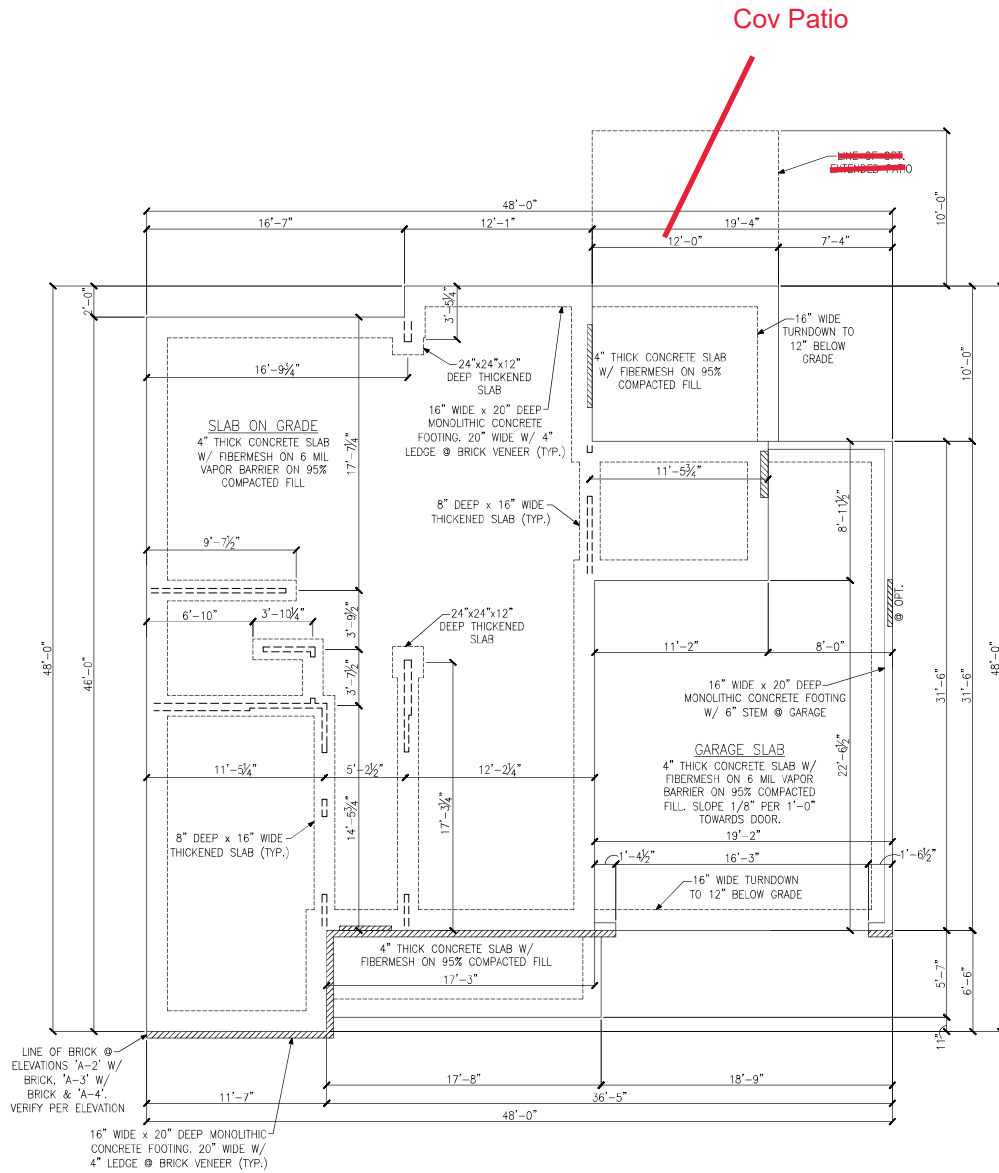

MONOLITHIC SLAB FOUNDATION PLAN  
ELEVATIONS 'A-1', 'A-2', 'A-3' & 'A-4'

LEGEND	
	PROVIDE SOLID BLOCKING WITHIN FLOOR SYSTEM TO MATCH POST SIZE ABOVE.
	BEARING WALL ABOVE
	INTERIOR BEARING WALL
	BRACED WALL PANEL (SEE KSE STRUCTURAL DETAILS SET FOR BRACED WALL PANEL SHEATHING FASTENING & BLOCKING DETAILS)
	LOCATION OF DOOR ABOVE
REFER TO KSE STRUCTURAL DETAILS SET FOR GENERAL STRUCTURAL NOTES AND TYPICAL DETAILS	

Monolithic Slab Foundation Plan  
Elevations 'A-1', 'A-2', 'A-3' & 'A-4'  
Dogwood Model - RH  
Up to 130 M.P.H.  
Carolina Division

Project #:	105-16007
Designed By:	KRK
Checked By:	
Issue Date:	4/9/19
Re-issue:	10/10/22
Scale:	1/8"=1'-0" @ 11x17 1/4"=1'-0" @ 22x34





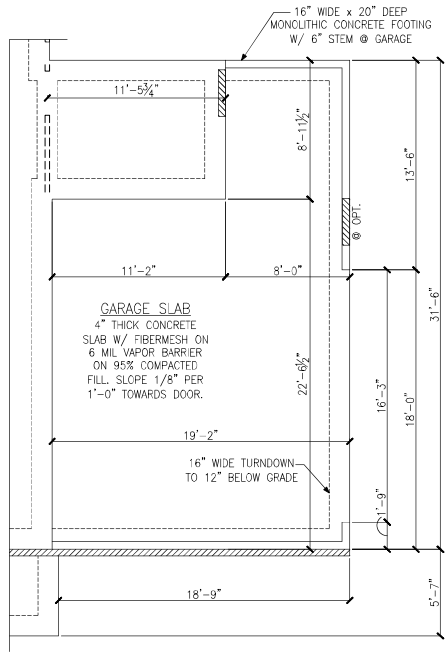

**PARTIAL FOUNDATION PLAN**  
OPTIONAL 2-CAR SIDE LOAD GARAGE  
ELEVATION A

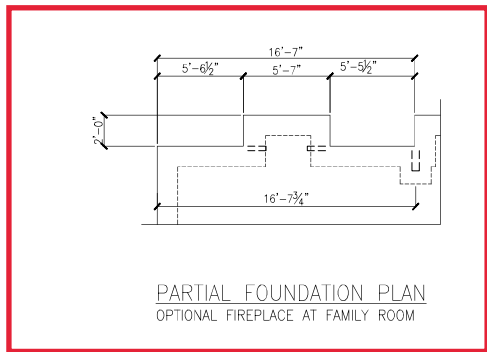

**PARTIAL FOUNDATION PLAN**  
OPTIONAL FIREPLACE AT FAMILY ROOM

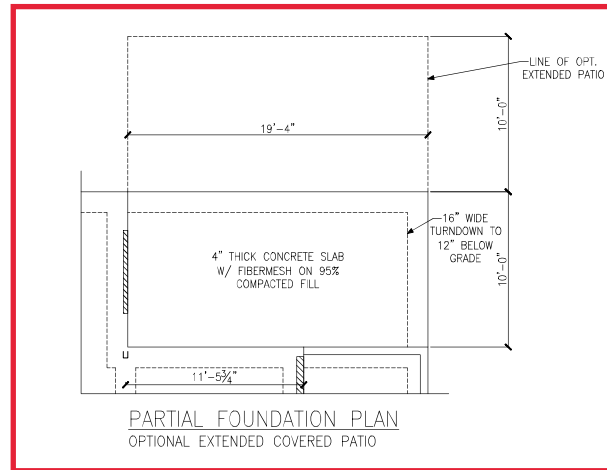

**PARTIAL FOUNDATION PLAN**  
OPTIONAL EXTENDED COVERED PATIO

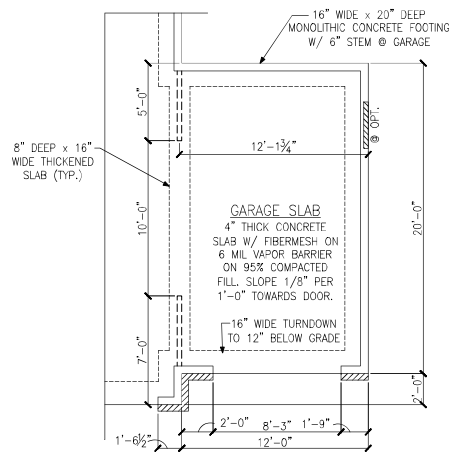

**MONOLITHIC SLAB FOUNDATION PLAN**  
OPTIONAL 1-CAR CARRIAGE GARAGE

LEGEND	
	PROVIDE SOLID BLOCKING
	WITHIN FLOOR SYSTEM TO MATCH POST SIZE ABOVE.
	BEARING WALL ABOVE
	INTERIOR BEARING WALL
	BRACED WALL PANEL (SEE KSE STRUCTURAL DETAILS SET FOR BRACED WALL PANEL SHEATHING FASTENING & BLOCKING DETAILS)
	LOCATION OF DOOR ABOVE
REFER TO KSE STRUCTURAL DETAILS SET FOR GENERAL STRUCTURAL NOTES AND TYPICAL DETAILS	





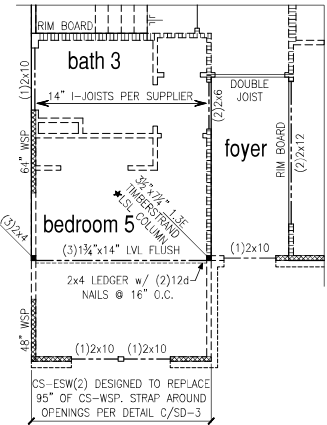
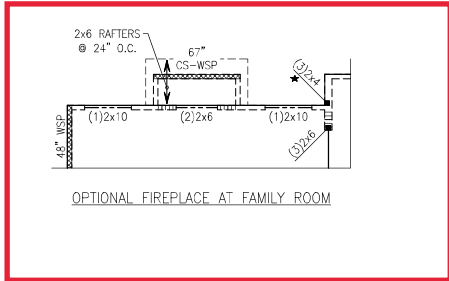

PARTIAL FRAMING PLAN  
OPTIONAL BED 5 & BATH 3 ILO STUDY

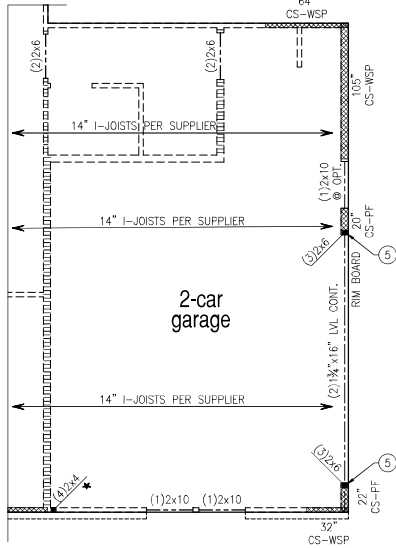

PARTIAL FRAMING PLAN  
OPTIONAL 2-CAR SIDE LOAD GARAGE  
ELEVATION A

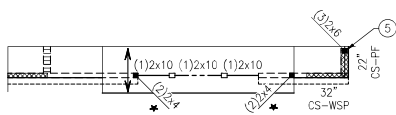

PARTIAL FRAMING PLAN  
OPTIONAL 2-CAR SIDE LOAD GARAGE  
ELEVATION B

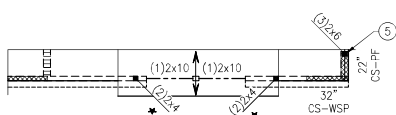

PARTIAL FRAMING PLAN  
OPTIONAL 2-CAR SIDE LOAD GARAGE  
ELEVATION C

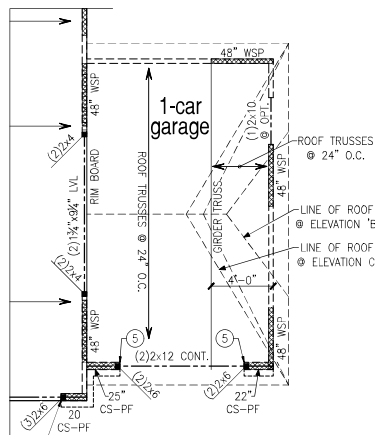
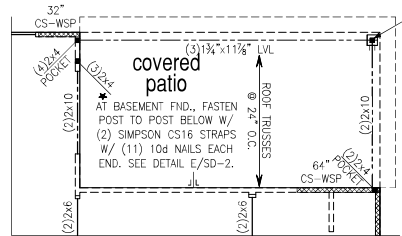
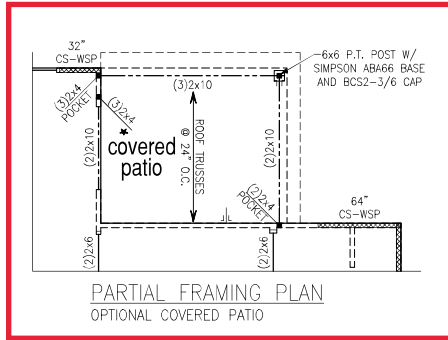

PARTIAL FRAMING PLAN  
OPTIONAL 1-CAR CARRIAGE GARAGE

**LEGEND**

- ★ PROVIDE SOLID BLOCKING WITHIN FLOOR SYSTEM TO MATCH POST SIZE ABOVE.
- BEARING WALL ABOVE
- INTERIOR BEARING WALL
- BRACED WALL PANEL (SEE KSE STRUCTURAL DETAILS SET FOR BRACED WALL PANEL SHEATHING FASTENING & BLOCKING DETAILS)

REFER TO KSE STRUCTURAL DETAILS SET FOR GENERAL STRUCTURAL NOTES AND TYPICAL DETAILS

PLAN DESIGNED WITH 9" WALL PLATES

FLOOR FRAMING TO BE 14" DEEP TJI 110 SERIES OR EQUAL, SPACING PER MANUFACTURER.

**KEYNOTES:**

- ④ INSTALL ONE PANEL CS-PF PORTAL FRAME PER DETAIL A OR B/SD-4.
- ⑤ INSTALL TWO PANEL CS-PF PORTAL FRAME PER DETAIL A OR B/SD-4.



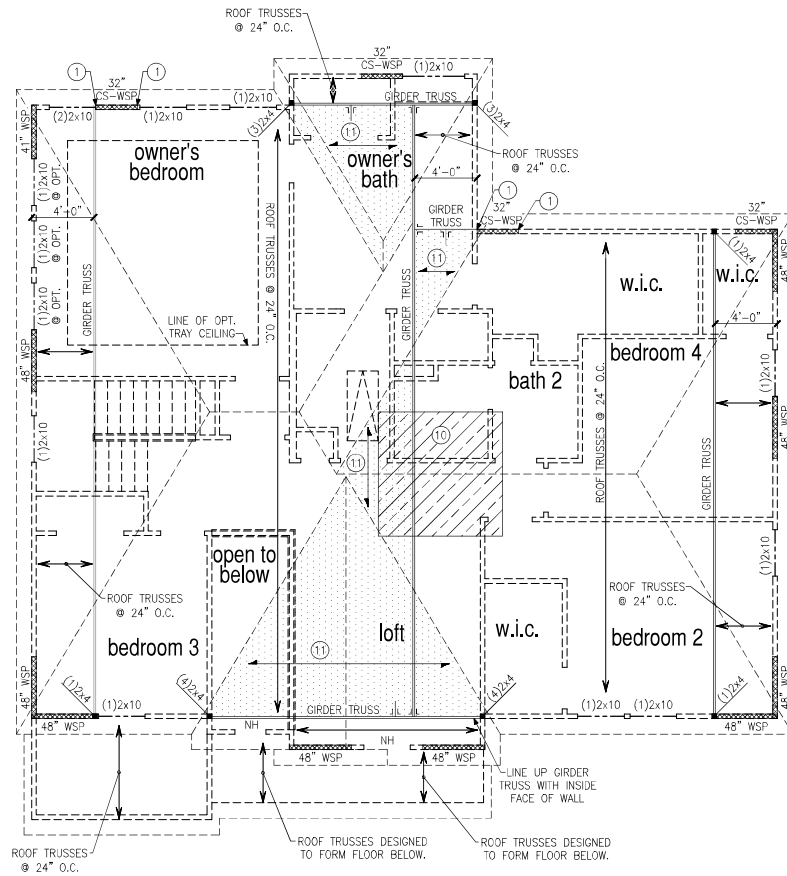

**ROOF FRAMING PLAN**  
ELEVATIONS 'A-1', 'A-2' & 'A-3' w/ STONE

LEGEND	
	PROVIDE SOLID BLOCKING WITHIN FLOOR SYSTEM TO MATCH POST SIZE ABOVE.
	BEARING WALL ABOVE
	INTERIOR BEARING WALL
	BRACED WALL PANEL (SEE KSE STRUCTURAL DETAILS SET FOR BRACED WALL PANEL SHEATHING FASTENING & BLOCKING DETAILS)
REFER TO KSE STRUCTURAL DETAILS SET FOR GENERAL STRUCTURAL NOTES AND TYPICAL DETAILS	
PLAN DESIGNED WITH 8" WALL PLATES	
KEYNOTES:	
①	CONNECT STUD AT END OF BRACED WALL PANEL TO FRAMING BELOW WITH A 30" LONG SIMPSON CS22 COIL STRAP WITH MIN 8-104 NAILS EACH END.
⑩	8"x8" HVAC PLATFORM TRUSSES DESIGNED TO SUPPORT HVAC UNITS.
⑪	2x6 OVERFRAMING w/ 2x8 RIDGE AND VALLEY PLATES OR VALLEY SET TRUSSES @ 24" O.C. (TYP.)



Roof Framing Plan  
Elevations 'A-1', 'A-2', 'A-3' w/ Stone  
Dogwood Model - RH  
Up to 130 M.P.H.  
Carolina Division

Project #:	105-16007
Designed By:	KRK
Checked By:	
Issue Date:	4/9/19
Re-issue:	10/10/22
Scale:	1/8"=1'-0" @ 11x17 1/4"=1'-0" @ 22x34



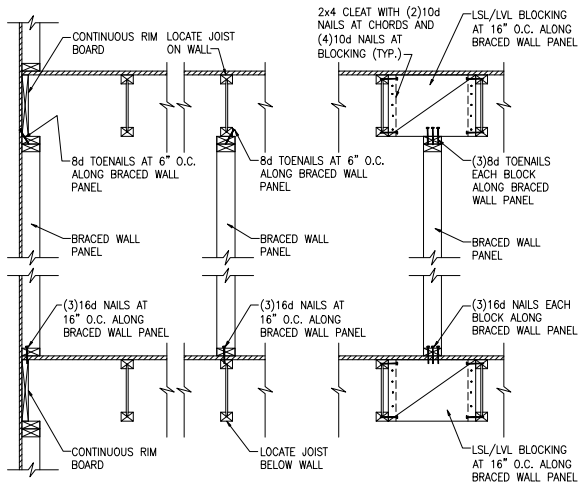

**(A) TYPICAL BRACED WALL PANEL TO FLOOR/CEILING CONNECTION**  
BRACED WALL PANELS PARALLEL TO I-JOISTS

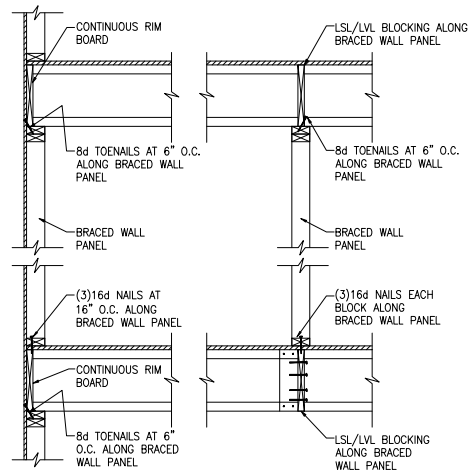

**(B) TYPICAL BRACED WALL PANEL TO FLOOR/CEILING CONNECTION**  
BRACED WALL PANELS PERPENDICULAR TO I-JOISTS

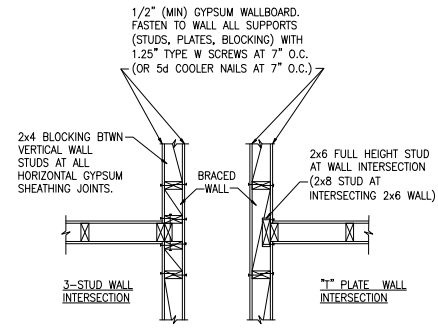

BRACED WALL INTERSECTIONS MAY BE FRAMED USING EITHER THE 3-STUD OR THE T-PLATE METHOD.

**(C) METHOD GB(1) AND GB(2) INTERSECTION DETAILS**

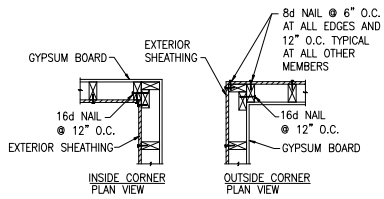

**(D) TYPICAL EXTERIOR CORNER WALL FRAMING**

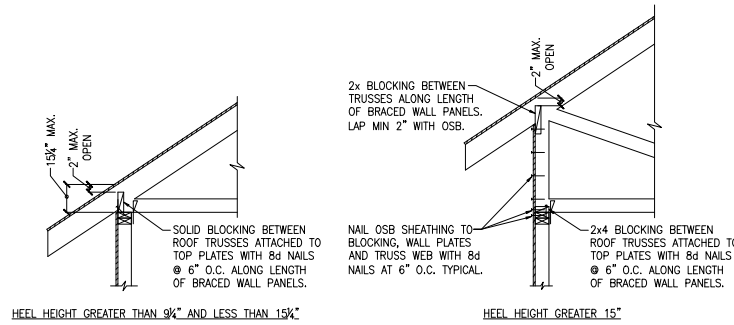

**(E) ROOF TRUSS BEARING/BLOCKING AT BRACED WALL PANELS**  
ONLY REQUIRED AT BRACED WALL PANELS



Project #: 105-19000  
Designed By: KRK  
Checked By:  
Issue Date: 1/1/19  
Re-Issue:  
Scale: 1/8"=1'-0" @ 11x17  
1/4"=1'-0" @ 22,34

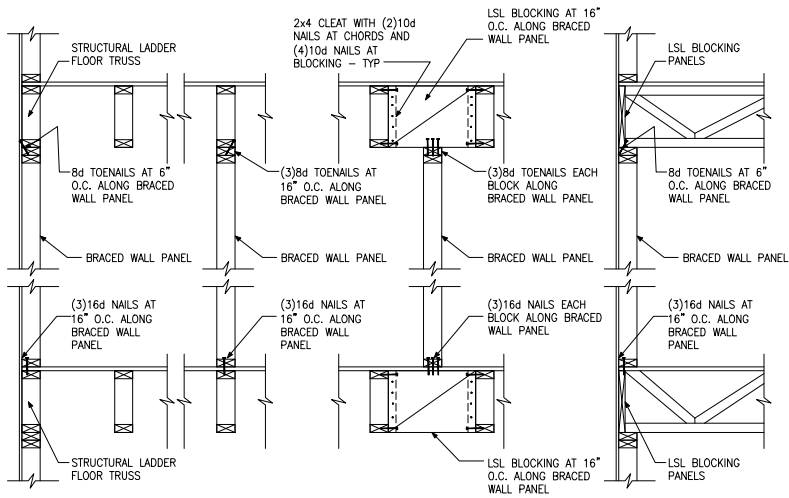

**A** TYPICAL BRACED WALL PANEL TO FLOOR / CEILING CONNECTION  
BRACED WALL PANELS PARALLEL TO TRUSSES

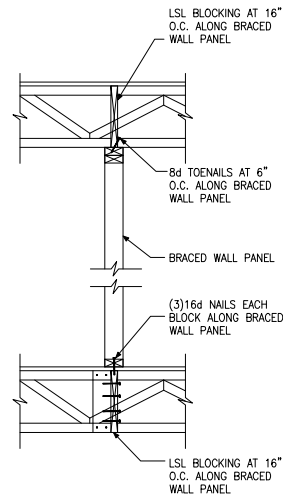

**B** TYPICAL BRACED WALL PANEL TO FLOOR / CEILING CONNECTION  
BRACED WALL PANELS PERPENDICULAR TO TRUSSES

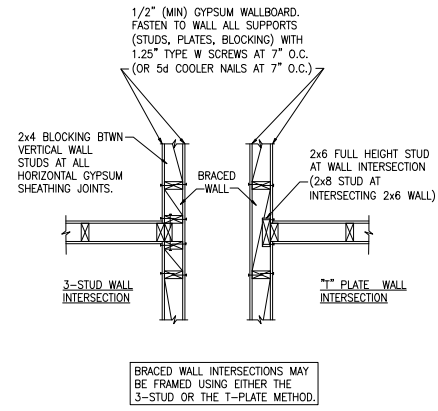

**C** METHOD GB(1) AND GB(2) INTERSECTION DETAILS

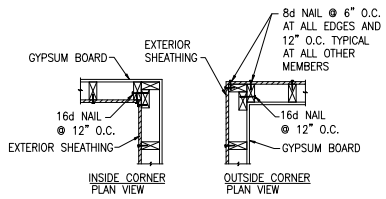

**D** TYPICAL EXTERIOR CORNER WALL FRAMING

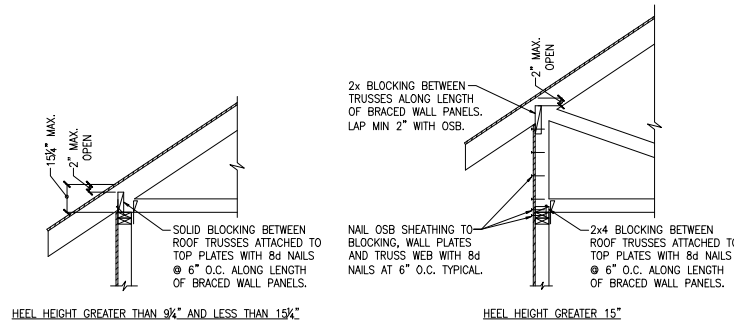

**E** ROOF TRUSS BEARING/BLOCKING AT BRACED WALL PANELS  
ONLY REQUIRED AT BRACED WALL PANELS



Project #:	105-19000
Designed By:	KRK
Checked By:	
Issue Date:	1/1/19
Re-Issue:	
Scale:	1/8"=1'-0" @ 11x17 1/4"=1'-0" @ 22x34

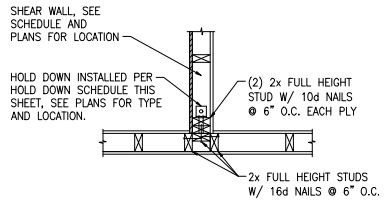

(A) TYPICAL HOLD DOWN DETAIL

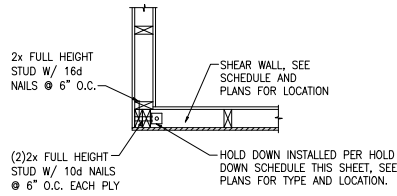

(B) TYPICAL HOLD DOWN DETAIL

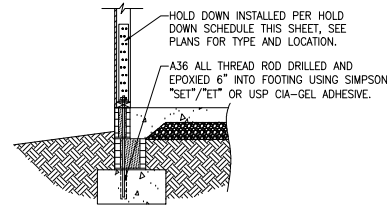

(C) HOLD DOWN AT STEMWALL SLAB FOUNDATION

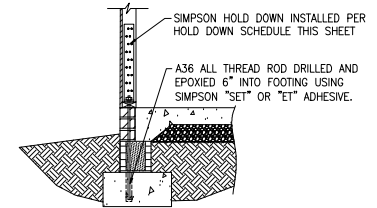

(C) HOLD DOWN AT STEMWALL SLAB

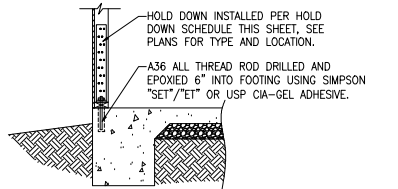

(D) HOLD DOWN AT MONOLITHIC SLAB FOUNDATION

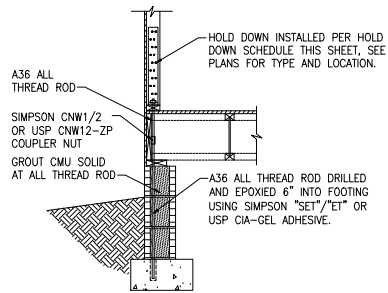

(E) HOLD DOWN AT CRAWL SPACE FOUNDATION

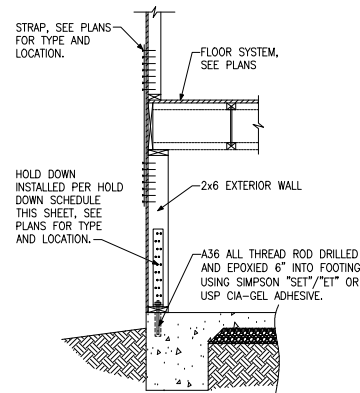

(F) HOLD DOWN AT BASEMENT FOUNDATION MONOLITHIC TURN-DOWN

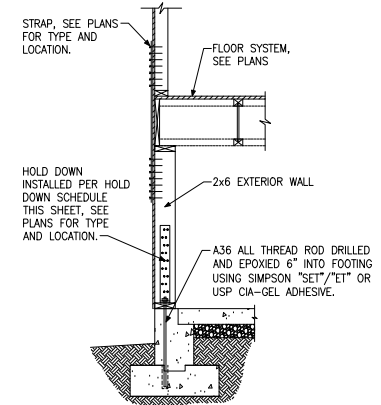

(G) HOLD DOWN AT BASEMENT FOUNDATION STEM WALL

HOLD DOWN SCHEDULE			
HOLD DOWN		ALL THREAD ROD	FASTENERS
SIMPSON	USP		
LTP2	N.A.	½" DIA.	(12)0.148"x2½" LONG NAILS
HTT4	HTT16	¾" DIA.	(18)0.148"x2½" LONG NAILS
HTT5	HTT45	¾" DIA.	(26)0.148"x2½" LONG NAILS



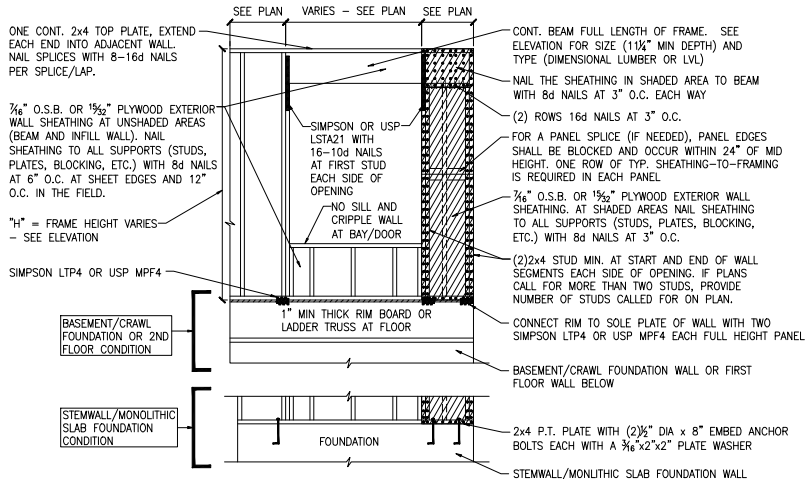

**A** METHOD CS-PF: CONTINUOUS PORTAL FRAME PANEL CONSTRUCTION  
ONE BRACED WALL SEGMENT

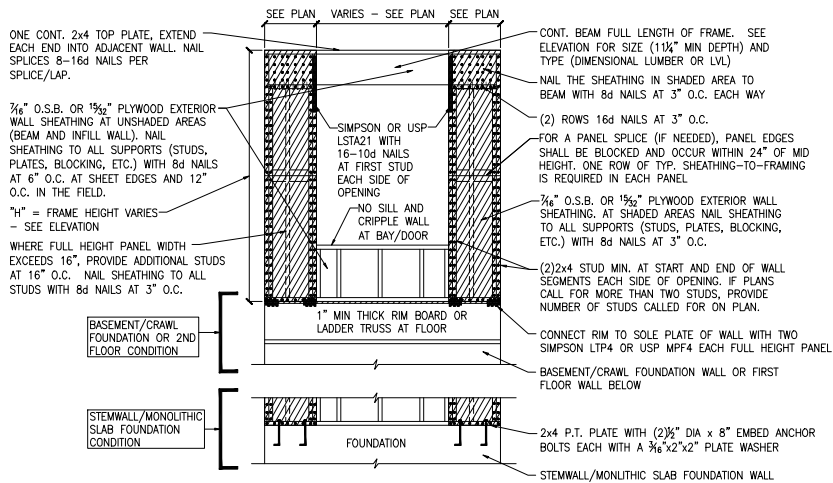

**B** METHOD CS-PF: CONTINUOUS PORTAL FRAME PANEL CONSTRUCTION  
TWO BRACED WALL SEGMENTS

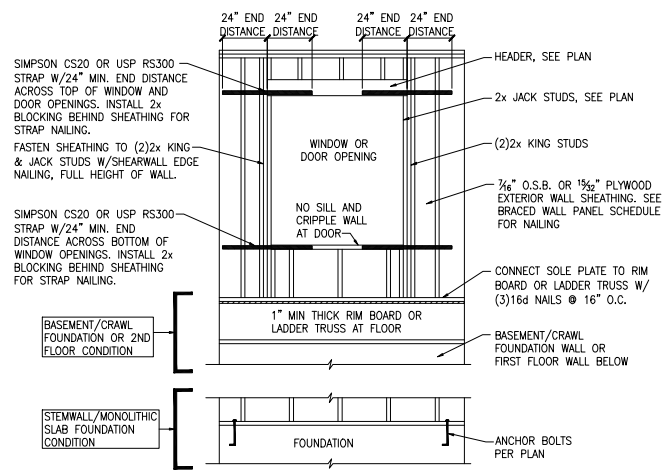

**C** WINDOW OR DOOR REINFORCEMENT IN ENGINEERED SHEAR WALL  
ONLY REQUIRED WHERE SPECIFIED ON PLANS

BRACED WALL PANEL AND ENGINEERED SHEAR WALL SCHEDULE			
PANEL TYPES	PANEL TYPE	MATERIAL	FASTENERS
WSP	INTERMITTENT WOOD STRUCTURAL PANEL	7/16" OSB	6D OR 8D COMMON NAILS AT 6" O.C. AT SHEET EDGES AND 12" O.C. AT INTERMEDIATE SUPPORTS. ENGINEERED ALTERNATIVE: 16 GAGE BY 1.75" LONG STAPLES AT 3" O.C. AT SHEET EDGES AND 6" O.C. AT INTERMEDIATE SUPPORTS
GB(1)	INTERMITTENT GYPSUM BOARD (SHEATHING ONE FACE OF WALL)	1/2" GYPSUM	1.5" LONG GALV. ROOFING NAILS, 6d COMMON NAILS, OR 1.25" LONG TYPE W DRYWALL SCREWS AT 7" O.C. AT SHEET EDGES AND INTERMEDIATE SUPPORTS.
GB(1)-4	INTERMITTENT GYPSUM BOARD (SHEATHING ONE FACE OF WALL)	1/2" GYPSUM	1.5" LONG GALV. ROOFING NAILS, 6d COMMON NAILS, OR 1.25" LONG TYPE W DRYWALL SCREWS AT 4" O.C. AT SHEET EDGES AND INTERMEDIATE SUPPORTS.
GB(2)	INTERMITTENT GYPSUM BOARD (SHEATHING BOTH FACES OF WALL)	1/2" GYPSUM	1.5" LONG GALV. ROOFING NAILS, 6d COMMON NAILS, OR 1.25" LONG TYPE W DRYWALL SCREWS AT 7" O.C. AT SHEET EDGES AND INTERMEDIATE SUPPORTS.
CS-WSP	CONTINUOUS SHEATHED WOOD STRUCTURAL PANEL	7/16" OSB	6D OR 8D COMMON NAILS AT 6" O.C. AT SHEET EDGES AND 12" O.C. AT INTERMEDIATE SUPPORTS. ENGINEERED ALTERNATIVE: 16 GAGE BY 1.75" LONG STAPLES AT 3" O.C. AT SHEET EDGES AND 6" O.C. AT INTERMEDIATE SUPPORTS
CS-PF	CONTINUOUS SHEATHED PORTAL FRAME	7/16" OSB	NAILING PER DETAIL
PFH	PORTAL FRAME WITH HOLD DOWNS	7/16" OSB	NAILING PER DETAIL
CS-ESW(1)	ENGINEERED SHEAR WALL, TYPE 1	7/16" OSB	8D COMMON NAILS AT 6" O.C. AT SHEET EDGES AND 12" O.C. AT INTERMEDIATE SUPPORTS. CONTINUOUS OSB AROUND DOOR/WINDOW OPENINGS
CS-ESW(2)	ENGINEERED SHEAR WALL, TYPE 2	7/16" OSB	8D COMMON NAILS AT 4" O.C. AT SHEET EDGES AND 12" O.C. AT INTERMEDIATE SUPPORTS. CONTINUOUS OSB AROUND DOOR/WINDOW OPENINGS
CS-ESW(3)	ENGINEERED SHEAR WALL, TYPE 3	7/16" OSB	8D COMMON NAILS AT 3" O.C. AT SHEET EDGES AND 12" O.C. AT INTERMEDIATE SUPPORTS. CONTINUOUS OSB AROUND DOOR/WINDOW OPENINGS

**BRACED WALL PANEL NOTES:**

- ALL BRACED WALL PANELS, EXCEPT GB(1) & GB(2), SHALL HAVE 2x BLOCKING BETWEEN WALL STUDS AT ALL HORIZONTAL SHEET EDGES.
- PROVIDE NAILING/BLOCKING ABOVE AND BELOW ALL BRACED WALL PANELS PER KSE BRACED WALL DETAILS.
- SMOOTH ALL EXTERIOR WALLS OF THE HOUSE WITH 3/8" O.S.B., OR 1/2" PLYWOOD, FASTENED PER IRC. AT EXTERIOR CORNERS, SHEATHING SHALL BE FASTENED PER KSE BRACED WALL DETAILS. AT INTERIOR WALL INTERSECTIONS, FASTEN STUDS & WALL BRACING PER KSE BRACED WALL DETAILS.
- BRACED WALL PANELS AND ENGINEERED SHEAR WALLS ARE PROVIDED PER IRC. PANEL LENGTHS SHOWN ON PLANS ARE THE MINIMUM LENGTH REQUIRED.





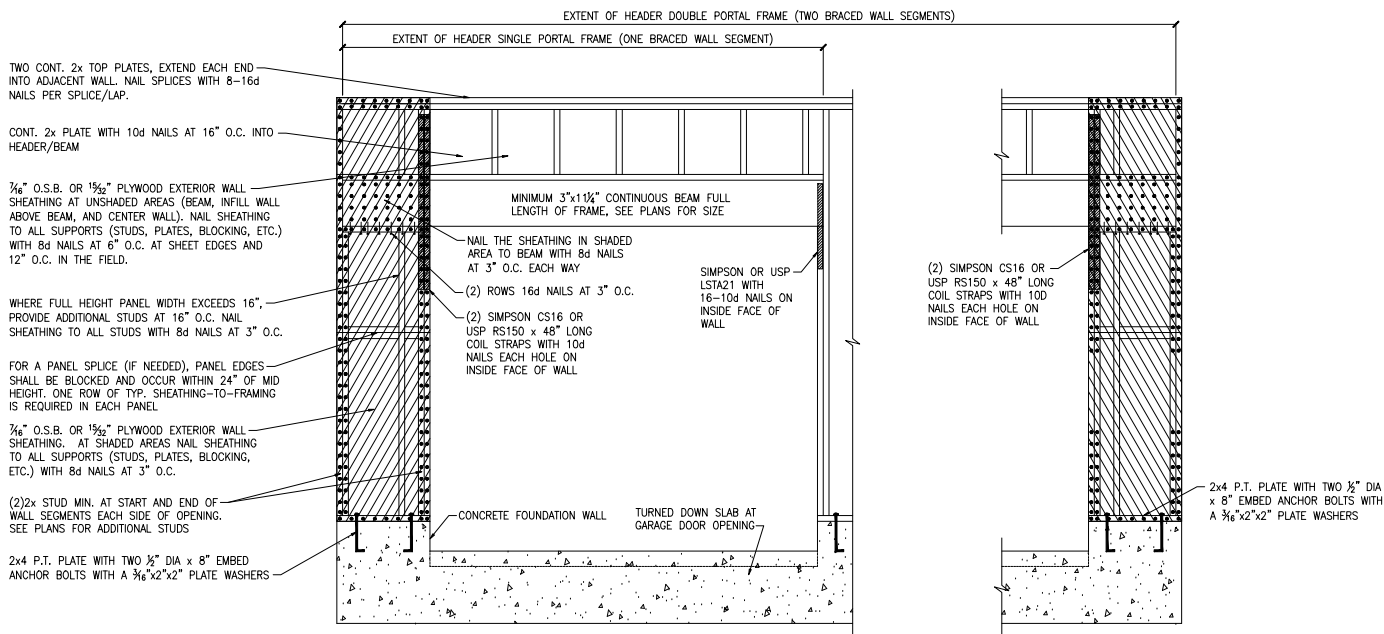

**(A) METHOD CS-PF: CONTINUOUS PORTAL FRAME PANEL CONSTRUCTION**  
 MONOLITHIC SLAB OR BASEMENT FOUNDATION

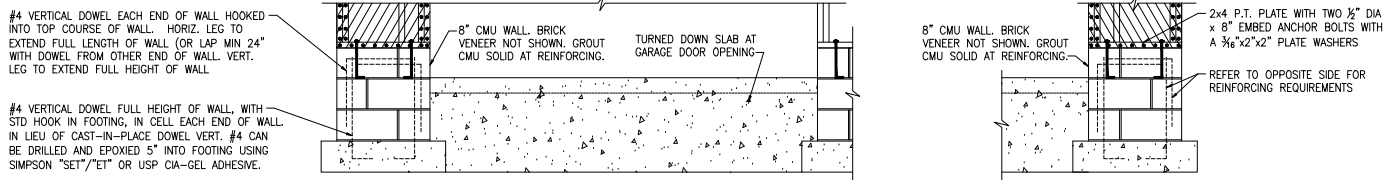

**(B) METHOD CS-PF: CONTINUOUS PORTAL FRAME PANEL CONSTRUCTION**  
 STEMWALL SLAB OR CRAWL SPACE FOUNDATION

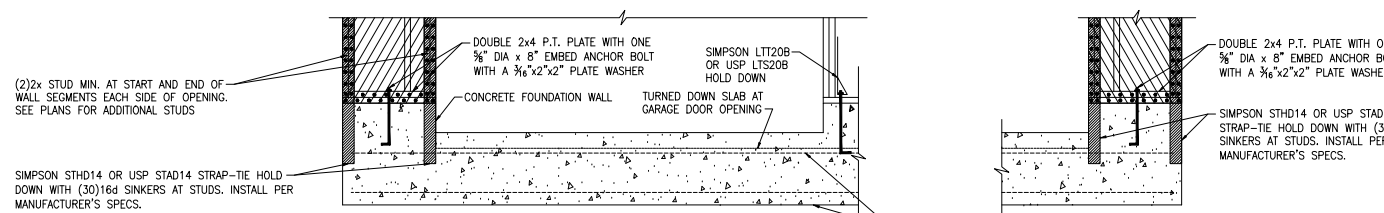

**(C) METHOD PFH: PORTAL FRAME WITH HOLD-DOWNS**  
 MONOLITHIC SLAB OR BASEMENT FOUNDATION



Portal Frame Details

Up to 130 M.P.H.  
 North Carolina

Project #:	105-19000
Designed By:	KRK
Checked By:	
Issue Date:	1/1/19
Re-Issue:	
Scale:	1/8"=1'-0" @ 11x17 1/4"=1'-0" @ 22x34

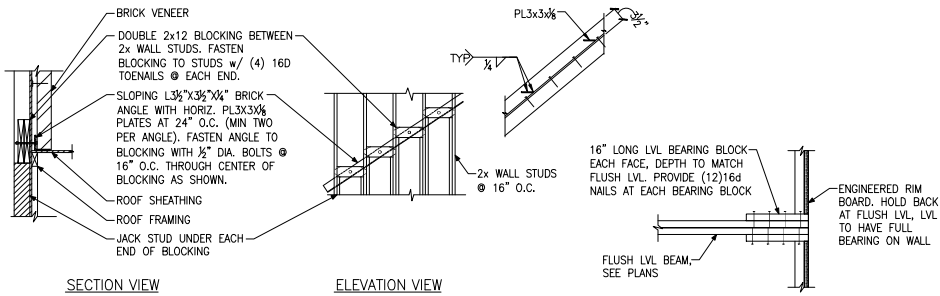

**(A) BRICK LEDGER CONNECTION DETAIL**

**(B) BEARING ENHANCER FLUSH LVL**

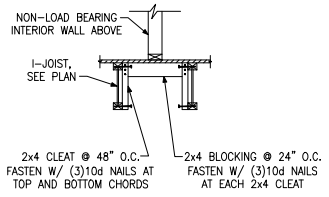

**(C) I-JOIST LADDER BLOCKING AS REQUIRED @ PARALLEL WALLS**

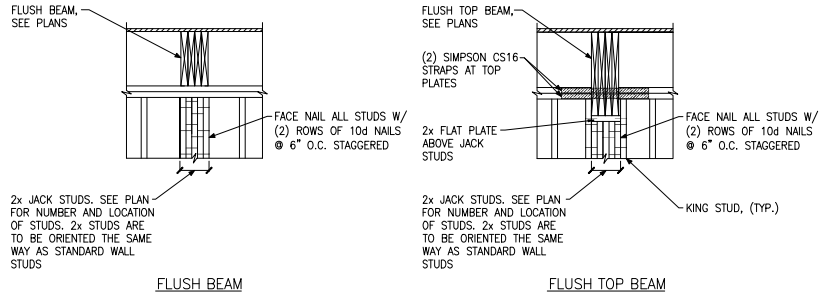

**(E) BUILT-UP STUD DETAIL SUPPORTING BEAM**

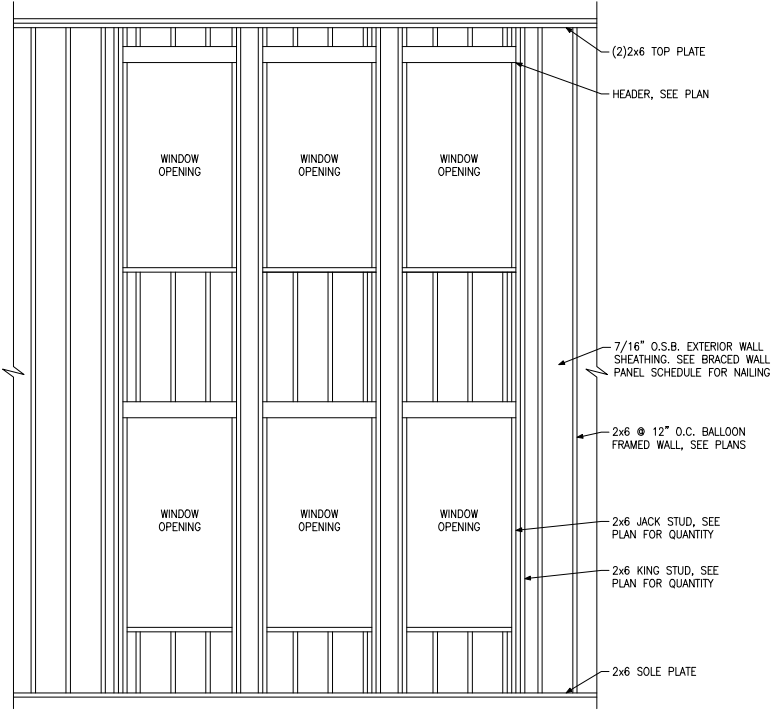

**(D) BALLOON FRAMED WALL DETAIL N.T.S.**



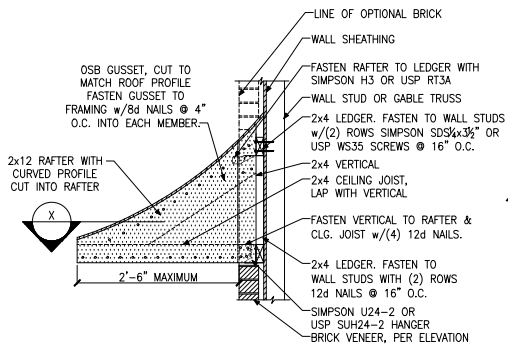

**(A) PENT ROOF DETAIL**  
CURVED ROOF

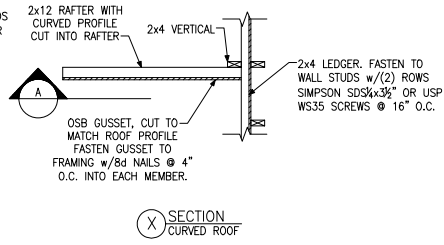

**(X) SECTION**  
CURVED ROOF

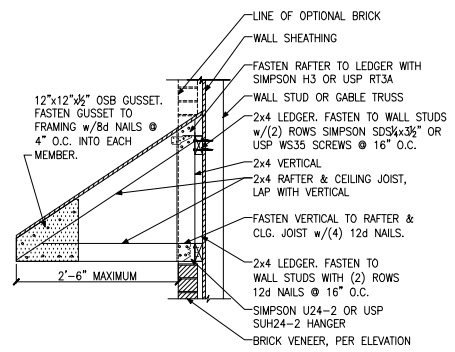

**(B) PENT ROOF DETAIL**  
STRAIGHT ROOF

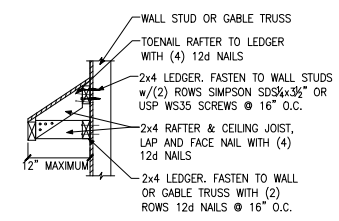

**(C) EYEBROW ROOF DETAIL**  
STRAIGHT ROOF

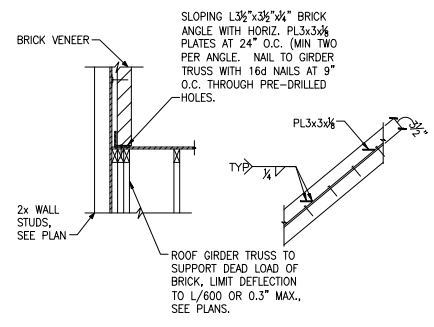

**(D) TRUSS DETAIL**

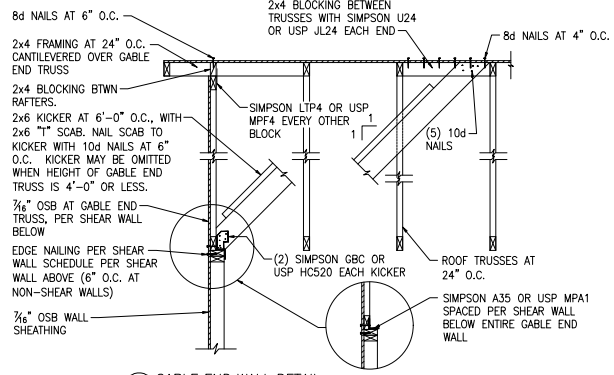

**(E) GABLE END WALL DETAIL**

Project #:	105-19000
Designed By:	KRK
Checked By:	
Issue Date:	1/1/19
Re-Issue:	
Scale:	1/8"=1'-0" @ 11x17 1/4"=1'-0" @ 22x34



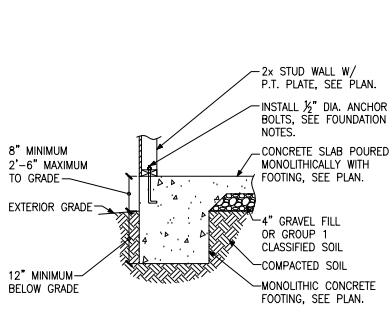

**A** FOUNDATION SECTION  
EXTERIOR WALL

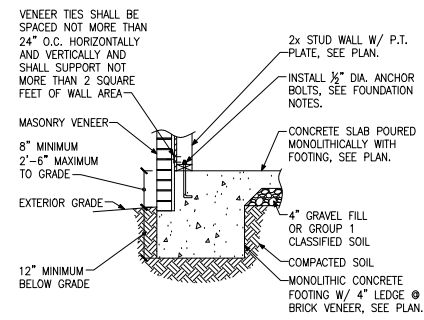

**B** FOUNDATION SECTION  
EXTERIOR WALL @ MASONRY  
VENEER

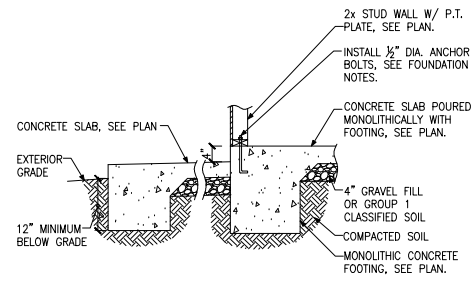

**C** FOUNDATION SECTION  
EXTERIOR WALL AT PORCH

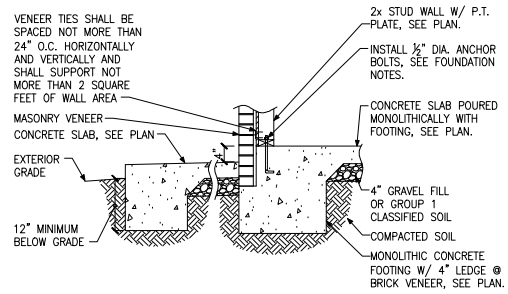

**D** FOUNDATION SECTION  
EXTERIOR WALL AT PORCH W/ MASONRY  
VENEER

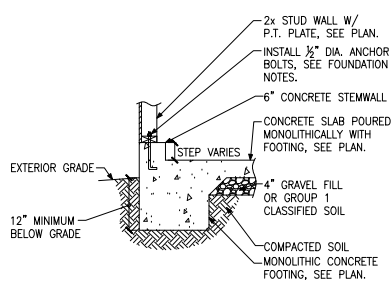

**E** FOUNDATION SECTION  
EXTERIOR GARAGE WALL

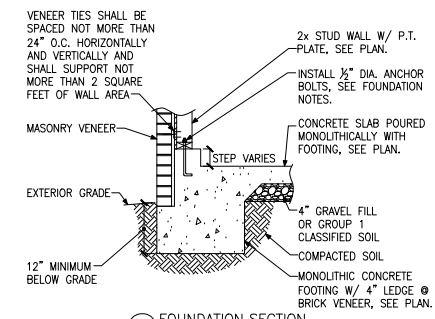

**F** FOUNDATION SECTION  
EXTERIOR GARAGE WALL @ MASONRY  
VENEER

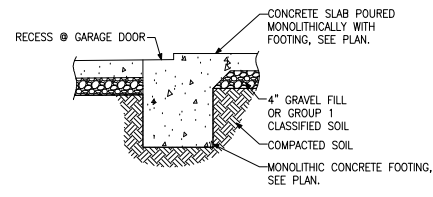

**G** FOUNDATION SECTION  
GARAGE DOOR

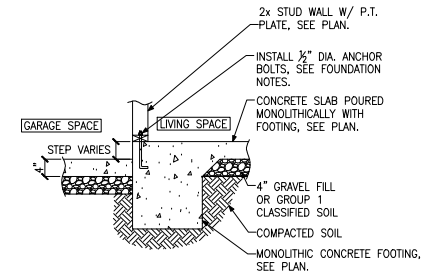

**H** FOUNDATION SECTION  
INTERIOR GARAGE WALL

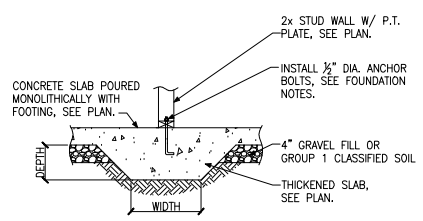

**J** FOUNDATION SECTION  
THICKENED SLAB

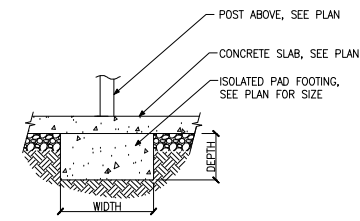

**K** FOUNDATION SECTION  
ISOLATED PAD FOOTING

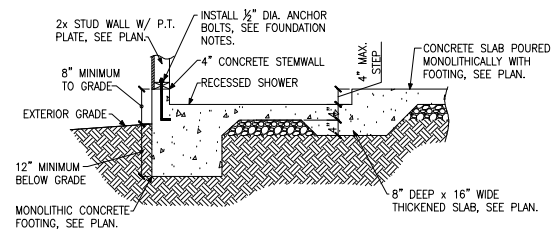

**L** FOUNDATION SECTION  
THICKENED SLAB @ RECESSED SHOWER



Project #:	105-19000
Designed By:	KRK
Checked By:	
Issue Date:	1/1/19
Re-Issue:	
Scale:	1/8"=1'-0" @ 11x17 1/4"=1'-0" @ 22x34

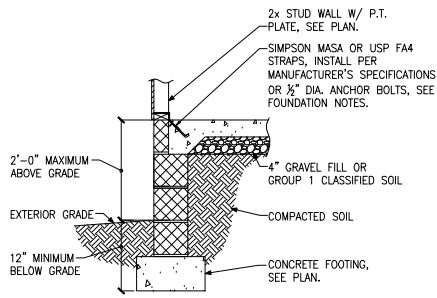

**A** FOUNDATION SECTION  
EXTERIOR WALL

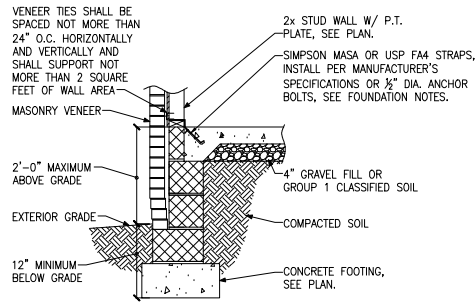

**B** FOUNDATION SECTION  
EXTERIOR WALL @ MASONRY  
VENEER

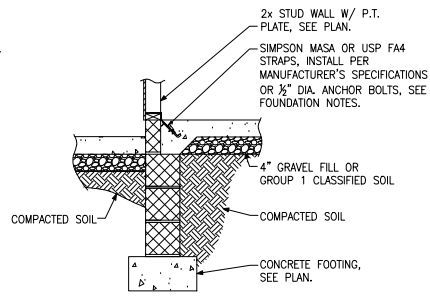

**C** FOUNDATION SECTION  
EXTERIOR WALL AT PORCH

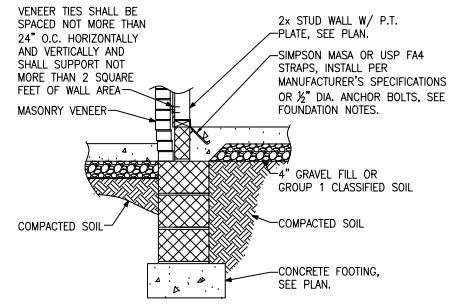

**D** FOUNDATION SECTION  
EXTERIOR WALL AT PORCH W/ MASONRY  
VENEER

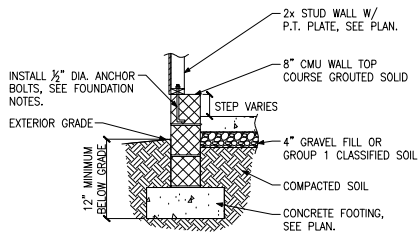

**E** FOUNDATION SECTION  
EXTERIOR GARAGE WALL

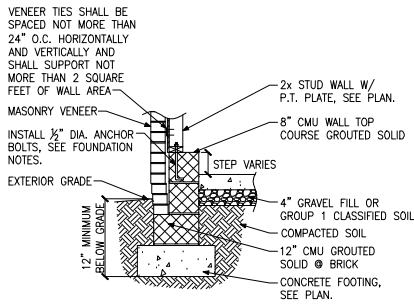

**F** FOUNDATION SECTION  
EXTERIOR GARAGE WALL @ MASONRY  
VENEER

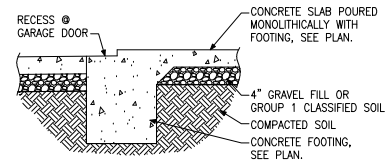

**G** FOUNDATION SECTION  
GARAGE DOOR

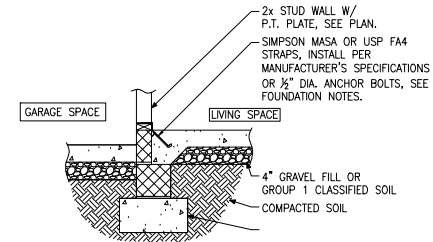

**H** FOUNDATION SECTION  
INTERIOR GARAGE WALL

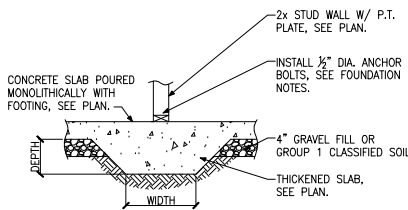

**J** FOUNDATION SECTION  
THICKENED SLAB

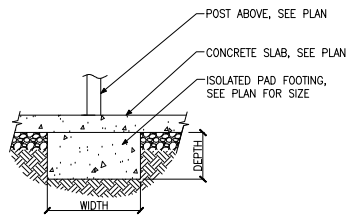

**K** FOUNDATION SECTION  
ISOLATED PAD FOOTING

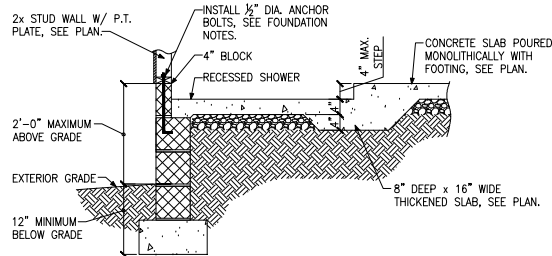

**L** FOUNDATION SECTION  
THICKENED SLAB @ RECESSED SHOWER

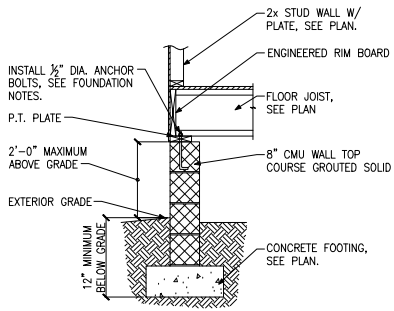

**A** FOUNDATION SECTION  
EXTERIOR WALL

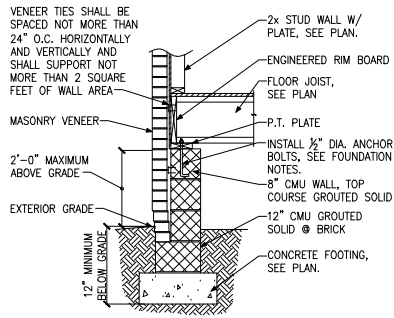

**B** FOUNDATION SECTION  
EXTERIOR WALL @ MASONRY VENEER

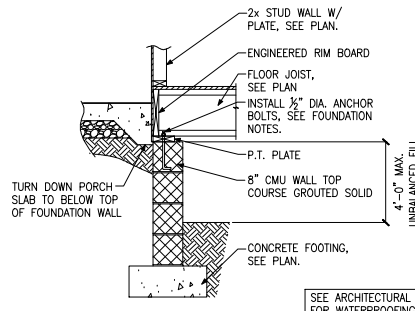

**C** FOUNDATION SECTION  
EXTERIOR WALL AT PORCH

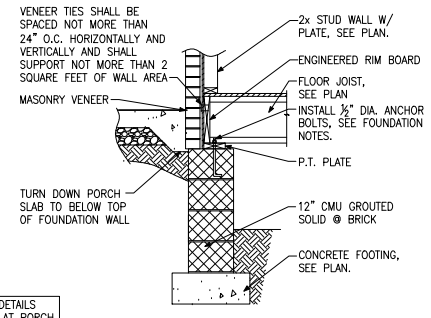

**D** FOUNDATION SECTION  
EXTERIOR WALL AT PORCH W/ MASONRY VENEER

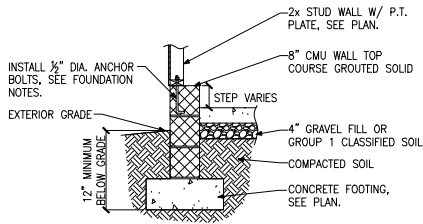

**E** FOUNDATION SECTION  
EXTERIOR GARAGE WALL

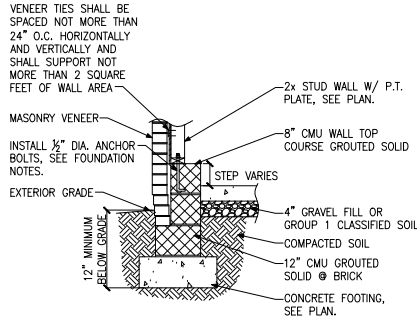

**F** FOUNDATION SECTION  
EXTERIOR GARAGE WALL @ MASONRY VENEER

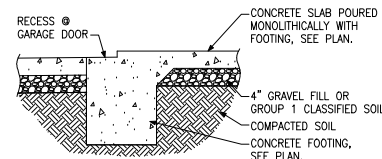

**G** FOUNDATION SECTION  
GARAGE DOOR

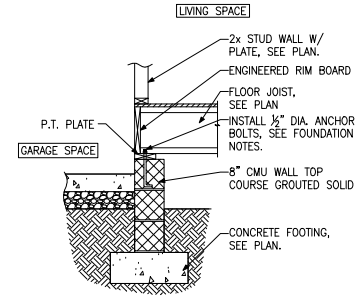

**H** FOUNDATION SECTION  
INTERIOR GARAGE WALL

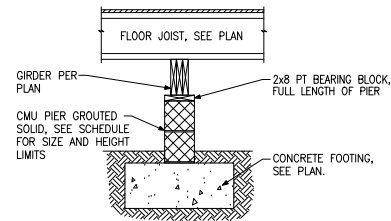

**J** FOUNDATION SECTION  
INTERIOR PIER

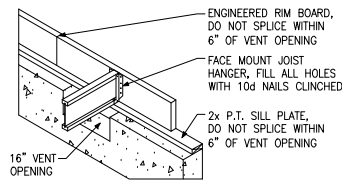

**K** CRAWL SPACE VENT DETAIL

PIER AND FOOTING SCHEDULE		
PIER HEIGHT	PIER SIZE	MIN. FOOTING SIZE
UP TO 2'-8"	8" x 16"	24" x 24" x 12" U.N.O.
UP TO 5'-4"	16" x 16"	24" x 24" x 12" U.N.O.
UP TO 8'-0"	16" x 16"	30" x 30" x 12" U.N.O.

NOTE:  
PIERS SHALL BE CAPPED WITH 8" OF SOLID MASONRY OR CONCRETE OR TOP COURSE FILLED SOLID WITH CONCRETE/MORTAR.  
PIERS OVER 5'-4" SHALL BE FILLED SOLIDLY WITH CONCRETE OR TYPE M OR S MORTAR.  
FOR PIERS OVER 8'-0" CONTACT KSE ENGINEERING FOR PIER AND FOOTING DESIGN.





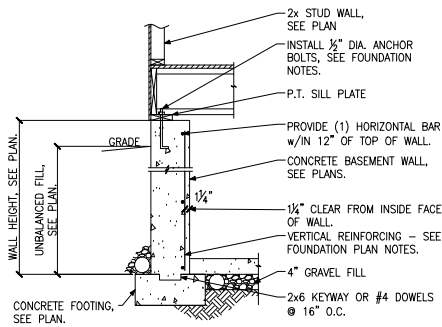

**(A)** FOUNDATION SECTION  
EXTERIOR WALL

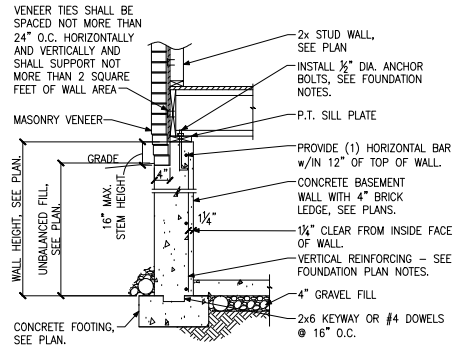

**(B)** FOUNDATION SECTION  
EXTERIOR WALL @ MASONRY VENEER

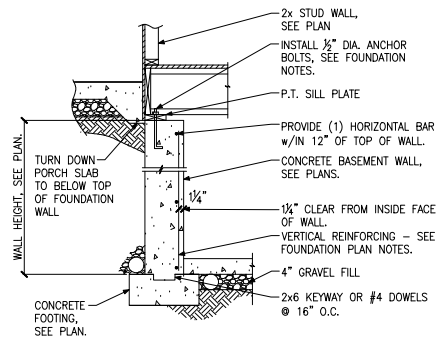

**(C)** FOUNDATION SECTION  
EXTERIOR WALL AT PORCH

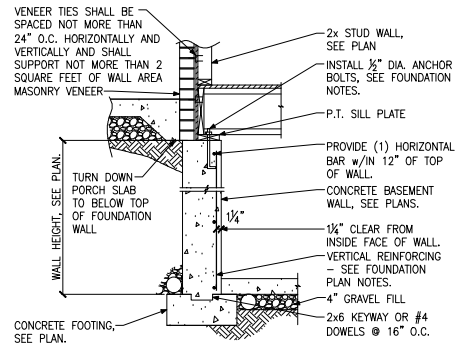

**(D)** FOUNDATION SECTION  
EXTERIOR WALL AT PORCH W/ MASONRY VENEER

SEE ARCHITECTURAL DETAILS  
FOR WATERPROOFING AT PORCH  
SLAB/WOOD FRAMING.

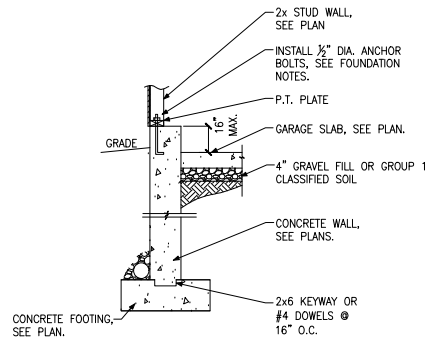

**(E)** FOUNDATION SECTION  
EXTERIOR GARAGE WALL

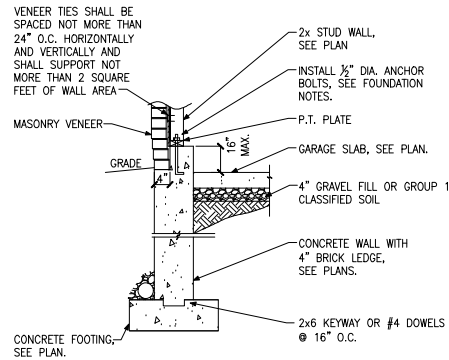

**(F)** FOUNDATION SECTION  
EXTERIOR GARAGE WALL @ MASONRY VENEER

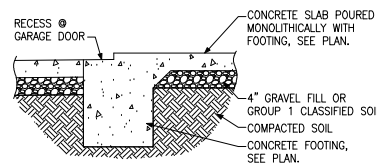

**(G)** FOUNDATION SECTION  
GARAGE DOOR

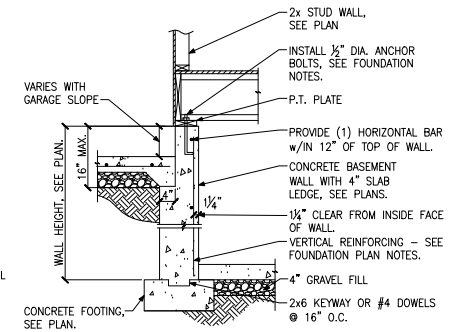

**(H)** FOUNDATION SECTION  
INTERIOR GARAGE WALL

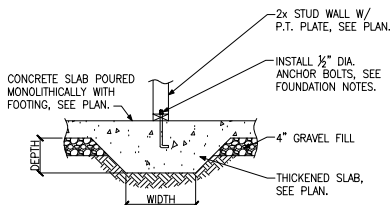

**(J)** FOUNDATION SECTION  
THICKENED SLAB

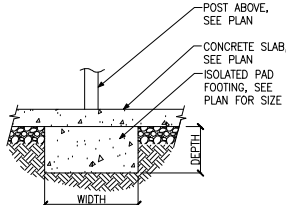

**(K)** FOUNDATION SECTION  
ISOLATED PAD FOOTING

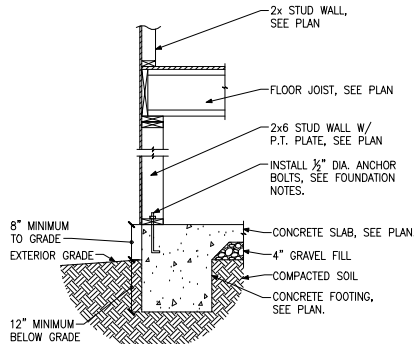

**(L)** FOUNDATION SECTION  
WALKOUT BASEMENT

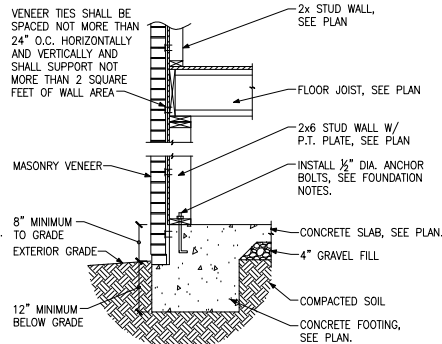

**(M)** FOUNDATION SECTION  
WALKOUT BASEMENT



Project #:	105-19000
Designed By:	KRK
Checked By:	
Issue Date:	1/1/19
Re-Issue:	
Scale:	1/8"=1'-0" @ 11x17 1/4"=1'-0" @ 22x34

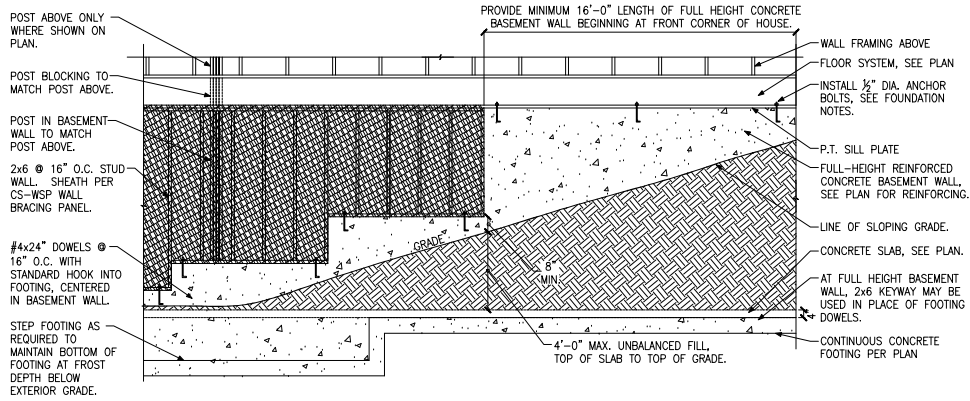

**(A) FOUNDATION ELEVATION**  
STEPPED SIDEWALL

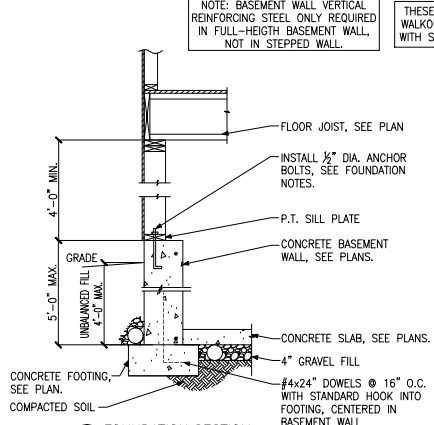

**(B) FOUNDATION SECTION**  
STEPPED SIDEWALL

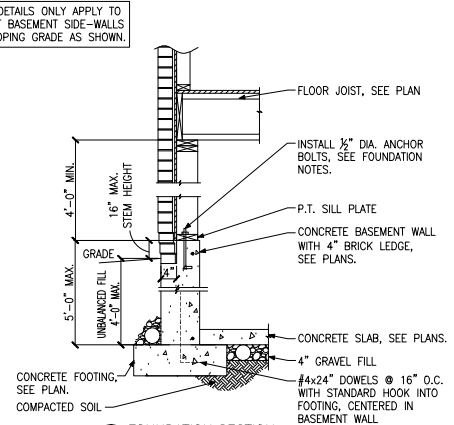

**(C) FOUNDATION SECTION**  
STEPPED SIDEWALL @ MASONRY VENEER

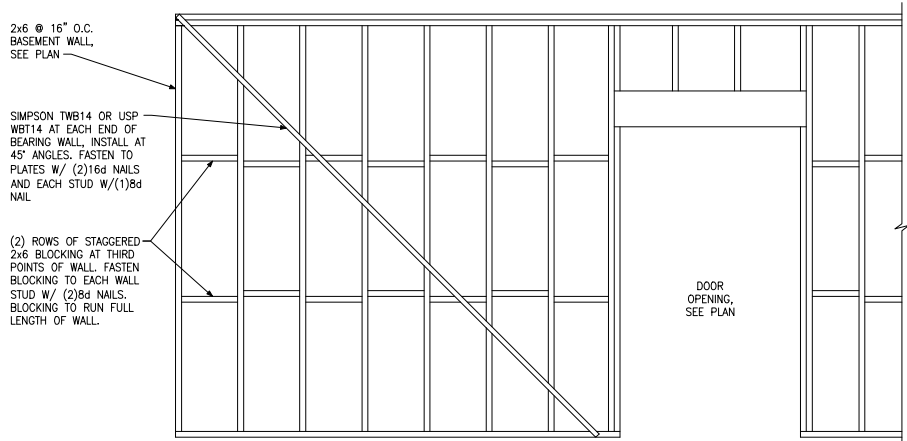

**(D) BASEMENT BEARING WALL BRACING DETAIL**

NOTE: BLOCKING AND SIMPSON STRAPS ARE NOT REQUIRED IF WALL IS SHEATHED ON ONE FACE WITH GYPSUM WALL BOARD

Project #:	105-19000
Designed By:	KRK
Checked By:	
Issue Date:	1/1/19
Re-Issue:	
Scale:	1/8"=1'-0" @ 11x17 1/4"=1'-0" @ 22x34

