

Nordic I-Joists with a Side Top Flange Notch

This technical note provides guidance to builders in case of damage caused to Nordic I-joists.

This technical note only applies if the following assumptions are met:

1. Maximum of one notch per I-joist.
2. Notch on the side of the top flange.
3. Notch depth up to 1 inch.
4. Notch length up to 4 inches.
5. For multiple spans, the end spans are 40% or more of the adjacent span and the notch is located between the mid-span and the end (see the drawing at the bottom left).
6. Uniformly distributed loads.

For all other cases, here are the options:

- a. Replace the damaged joist;
- b. Add a new joist within three inches of the notched joist;
 - Verify sheathing span limits for the increased spacing.
 - Verify simple span joist capacity.
- c. Contact Nordic Technical Support.

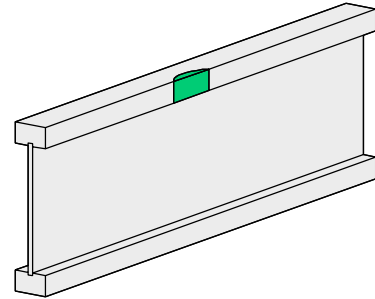

The following tables provide the allowable spans for Nordic I-joists with a side top flange notch, for simple and multiple spans, notch depths of 1/2 and 1 inch, with and without repair. The drawings below illustrate the notch location from nearest support, x , as well as its depth and length.

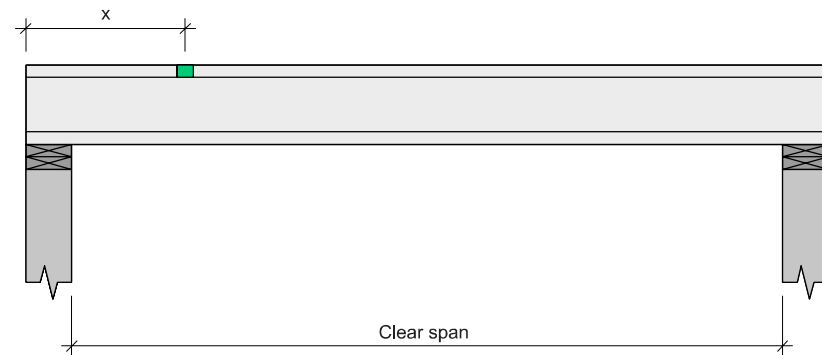

Elevation view of a simple-span joist and notch location

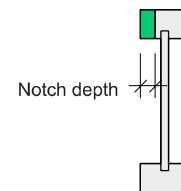

Section view of a side top flange notch

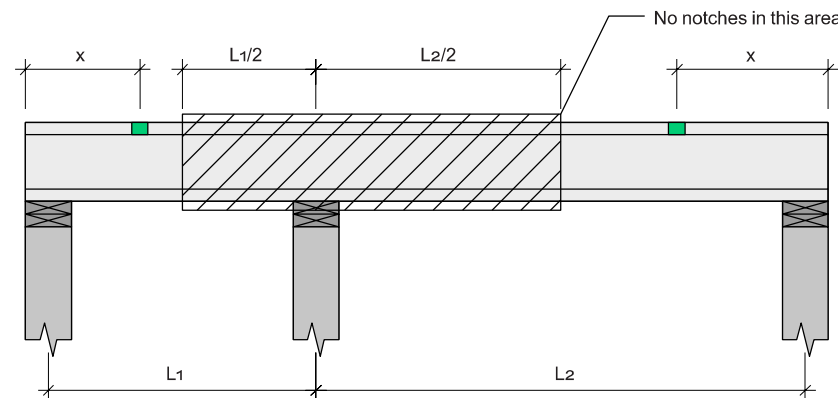

Elevation view of a multiple-span joist and notch location

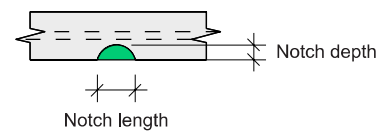

Top view of a side top flange notch

Repair Option for Nordic I-Joists with a Side Top Flange Notch

The following options are applicable to Nordic I-joists with a side top flange notch, only if the assumptions described on page 1 are met. In the following tables, the "No repair" columns indicate the allowable spans requiring no repair, while the "Repair" columns indicate the allowable spans when a repair is required.

Repair detail:

1. Install a 2x4 S-P-F No. 2 or better reinforcement, at least 6 feet long, on either side of the top flange.
2. The reinforcement must be centered on the notch, or installed from the support if the notch is at a distance of 3 feet or less from the support.
3. Attach the reinforcement with 8d common nails at 3 inches o.c., as shown.

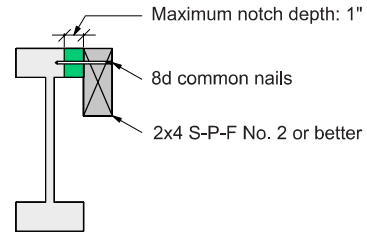

Section view of a repaired I-joist

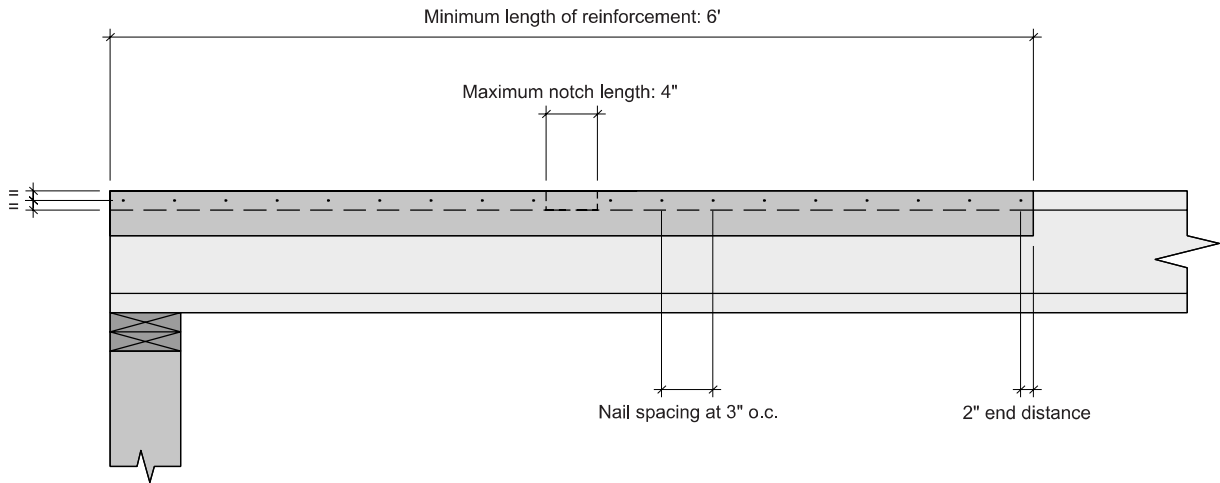

Elevation view of a repaired I-joist

Design Criteria

Notch depth:	1/2 inch
Span:	Simple span
Loads:	Live load = 40 psf and dead load = 10 psf
Deflection limit:	L/240 under total load
Sheathing:	APA Rated nailed-glued sheathing

Allowable Floor Spans

Live load deflection limit of L/480

Joist depth	Joist series	Notch location (x) ≤ 4 ft								Notch location (x) ≤ 8 ft							
		On center spacing								On center spacing							
		12"		16"		19.2"		24"		12"		16"		19.2"		24"	
		No repair	Repair	No repair	Repair	No repair	Repair	No repair	Repair	No repair	Repair	No repair	Repair	No repair	Repair	No repair	Repair
9-1/2"	NI-40x	18'-7"	18'-8"	16'-11"	17'-0"	16'-0"	16'-1"	14'-10"	15'-0"	18'-6"	18'-8"	16'-6"	17'-0"	15'-0"	16'-1"	-	-
	NI-60	18'-10"	18'-11"	17'-2"	17'-4"	16'-3"	16'-4"	15'-1"	15'-3"	18'-10"	18'-11"	17'-2"	17'-4"	16'-2"	16'-4"	-	-
	NI-80	20'-10"	20'-11"	19'-0"	19'-1"	17'-11"	18'-0"	16'-8"	16'-9"	20'-10"	20'-11"	18'-11"	19'-1"	17'-10"	18'-0"	16'-7"	16'-9"
11-7/8"	NI-40x	22'-1"	22'-2"	20'-2"	20'-3"	19'-0"	19'-2"	17'-2"	17'-2"	22'-1"	22'-2"	19'-0"	20'-3"	17'-2"	19'-2"	15'-3"	17'-2"
	NI-60	22'-6"	22'-8"	20'-7"	20'-8"	19'-5"	19'-6"	18'-1"	18'-2"	22'-6"	22'-8"	20'-6"	20'-8"	19'-4"	19'-6"	17'-8"	18'-2"
	NI-80	24'-10"	24'-11"	22'-7"	22'-8"	21'-3"	21'-4"	19'-9"	19'-11"	24'-9"	24'-11"	22'-7"	22'-8"	21'-3"	21'-4"	19'-9"	19'-11"
14"	NI-40x	25'-1"	25'-2"	22'-10"	22'-11"	21'-2"	21'-2"	18'-11"	18'-11"	25'-0"	25'-2"	21'-4"	22'-11"	19'-1"	21'-2"	16'-10"	18'-11"
	NI-60	25'-8"	25'-9"	23'-4"	23'-6"	22'-0"	22'-2"	20'-8"	20'-8"	25'-7"	25'-9"	23'-4"	23'-6"	22'-0"	22'-2"	19'-8"	20'-8"
	NI-80	28'-2"	28'-3"	25'-8"	25'-9"	24'-2"	24'-3"	22'-6"	22'-7"	28'-2"	28'-3"	25'-7"	25'-9"	24'-1"	24'-3"	22'-5"	22'-7"
16"	NI-60	28'-11"	29'-0"	26'-4"	26'-5"	24'-10"	24'-10"	23'-1"	23'-1"	28'-11"	29'-0"	26'-4"	26'-5"	24'-9"	24'-10"	23'-0"	23'-1"
	NI-80	28'-5"	28'-6"	25'-11"	26'-0"	24'-5"	24'-7"	22'-9"	22'-10"	28'-5"	28'-6"	25'-11"	26'-0"	24'-5"	24'-7"	21'-6"	22'-10"
	NI-90	31'-3"	31'-4"	28'-5"	28'-6"	26'-9"	26'-10"	24'-11"	25'-0"	31'-2"	31'-4"	28'-5"	28'-6"	26'-9"	26'-10"	24'-10"	25'-0"
	NI-90	32'-0"	32'-1"	29'-2"	29'-2"	27'-5"	27'-6"	25'-6"	25'-7"	32'-0"	32'-1"	29'-1"	29'-2"	27'-5"	27'-6"	25'-6"	25'-7"

Live load deflection limit of L/360

Joist depth	Joist series	Notch location (x) ≤ 4 ft								Notch location (x) ≤ 8 ft							
		On center spacing								On center spacing							
		12"		16"		19.2"		24"		12"		16"		19.2"		24"	
		No repair	Repair	No repair	Repair	No repair	Repair	No repair	Repair	No repair	Repair	No repair	Repair	No repair	Repair	No repair	Repair
9-1/2"	NI-40x	20'-6"	20'-7"	18'-6"	18'-6"	16'-11"	16'-11"	15'-1"	15'-1"	19'-4"	20'-7"	16'-6"	18'-6"	15'-0"	16'-11"	-	-
	NI-60	20'-11"	21'-0"	19'-1"	19'-2"	18'-0"	18'-1"	16'-9"	16'-11"	20'-10"	21'-0"	19'-0"	19'-2"	17'-3"	18'-1"	15'-5"	16'-11"
	NI-80	23'-1"	23'-2"	21'-1"	21'-1"	19'-10"	19'-11"	18'-6"	18'-7"	23'-0"	23'-2"	21'-0"	21'-1"	19'-10"	19'-11"	18'-5"	18'-7"
11-7/8"	NI-40x	24'-5"	24'-5"	21'-1"	21'-1"	19'-3"	19'-3"	17'-2"	17'-2"	22'-9"	24'-5"	19'-0"	21'-1"	17'-2"	19'-3"	15'-3"	17'-2"
	NI-60	24'-11"	25'-0"	22'-9"	22'-10"	21'-6"	21'-7"	19'-9"	19'-9"	24'-11"	25'-0"	22'-7"	22'-10"	20'-1"	21'-7"	17'-8"	19'-7"
	NI-80	27'-6"	27'-6"	25'-0"	25'-1"	23'-7"	23'-8"	22'-0"	22'-1"	27'-5"	27'-6"	25'-0"	25'-1"	23'-7"	23'-8"	21'-11"	22'-1"
14"	NI-90	28'-3"	28'-4"	25'-9"	25'-10"	24'-3"	24'-4"	22'-7"	22'-8"	28'-2"	28'-4"	25'-8"	25'-10"	24'-3"	24'-4"	22'-6"	22'-8"
	NI-40x	26'-9"	26'-9"	23'-2"	23'-2"	21'-2"	21'-2"	18'-11"	18'-11"	25'-10"	26'-9"	21'-4"	23'-2"	19'-1"	21'-2"	16'-10"	18'-11"
	NI-60	28'-4"	28'-5"	25'-10"	26'-0"	24'-3"	24'-3"	21'-8"	21'-8"	28'-4"	28'-5"	25'-7"	26'-0"	22'-7"	24'-3"	19'-8"	21'-8"
16"	NI-80	31'-2"	31'-3"	28'-5"	28'-6"	26'-9"	26'-10"	24'-11"	25'-0"	31'-2"	31'-3"	28'-4"	28'-6"	26'-9"	26'-10"	24'-11"	25'-0"
	NI-90	32'-0"	32'-1"	29'-2"	29'-3"	27'-6"	27'-7"	25'-7"	25'-8"	32'-0"	32'-1"	29'-2"	29'-3"	27'-5"	27'-7"	25'-7"	25'-8"
	NI-60	31'-6"	31'-6"	28'-7"	28'-7"	26'-1"	26'-1"	23'-4"	23'-4"	31'-5"	31'-6"	28'-5"	28'-7"	25'-0"	26'-1"	21'-6"	23'-4"
16"	NI-80	34'-7"	34'-8"	31'-6"	31'-7"	29'-8"	29'-9"	27'-7"	27'-9"	34'-6"	34'-8"	31'-5"	31'-7"	29'-8"	29'-9"	27'-7"	27'-9"
	NI-90	35'-5"	35'-6"	32'-3"	32'-4"	30'-5"	30'-6"	28'-4"	28'-5"	35'-5"	35'-6"	32'-3"	32'-4"	30'-4"	30'-6"	28'-3"	28'-5"

Notes:

- The tabulated clear spans are applicable to residential floor construction meeting the above design criteria and are based on a sheathing thickness of 19/32 inch (40/20 or 20 oc) for a joist spacing of 19.2 inches or less and on a sheathing thickness of 23/32 inch (48/24 or 24 oc) for a joist spacing of 24 inches.
- Minimum bearing length shall be 1-3/4 inch for end bearings and 3-1/2 inches for intermediate bearings.
- Bearing stiffeners are not required when I-joists are used in accordance with these tables, except as required for hangers.
- See page 1 for design assumptions. Repair shall be designed according to detail on page 2.

Design Criteria

Notch depth:	1/2 inch
Span:	Multiple spans
Loads:	Live load = 40 psf and dead load = 10 psf
Deflection limit:	L/240 under total load
Sheathing:	APA Rated nailed-glued sheathing

Allowable Floor Spans

Live load deflection limit of L/480

Joist depth	Joist series	Notch location (x) ≤ 4 ft								Notch location (x) ≤ 8 ft							
		On center spacing								On center spacing							
		12"		16"		19.2"		24"		12"		16"		19.2"		24"	
		No repair	Repair	No repair	Repair	No repair	Repair	No repair	Repair	No repair	Repair	No repair	Repair	No repair	Repair	No repair	Repair
9-1/2"	NI-40x	20'-3"	20'-4"	18'-5"	18'-5"	16'-10"	16'-10"	15'-0"	15'-0"	20'-2"	20'-4"	18'-5"	18'-5"	16'-10"	16'-10"	-	-
	NI-60	20'-7"	20'-8"	18'-9"	18'-10"	17'-8"	17'-9"	16'-5"	16'-7"	20'-6"	20'-8"	18'-8"	18'-10"	17'-7"	17'-9"	16'-5"	16'-7"
	NI-80	22'-9"	22'-9"	20'-8"	20'-9"	19'-6"	19'-6"	18'-1"	18'-2"	22'-8"	22'-9"	20'-8"	20'-9"	19'-5"	19'-6"	18'-1"	18'-2"
11-7/8"	NI-40x	24'-1"	24'-2"	21'-0"	21'-0"	19'-2"	19'-2"	17'-1"	17'-1"	24'-1"	24'-2"	21'-0"	21'-0"	19'-2"	19'-2"	17'-1"	17'-1"
	NI-60	24'-7"	24'-8"	22'-5"	22'-6"	21'-1"	21'-2"	19'-8"	19'-8"	24'-6"	24'-8"	22'-4"	22'-6"	21'-1"	21'-2"	19'-7"	19'-8"
	NI-80	27'-1"	27'-1"	24'-7"	24'-8"	23'-2"	23'-3"	21'-6"	21'-7"	27'-0"	27'-1"	24'-7"	24'-8"	23'-2"	23'-3"	21'-6"	21'-7"
14"	NI-40x	26'-8"	26'-8"	23'-1"	23'-1"	21'-1"	21'-1"	18'-10"	18'-10"	26'-8"	26'-8"	23'-1"	23'-1"	21'-1"	21'-1"	18'-10"	18'-10"
	NI-60	28'-0"	28'-0"	25'-6"	25'-7"	24'-0"	24'-1"	21'-7"	21'-7"	27'-11"	28'-0"	25'-5"	25'-7"	23'-11"	24'-1"	21'-7"	21'-7"
	NI-80	30'-9"	30'-10"	28'-0"	28'-0"	26'-4"	26'-5"	24'-6"	24'-6"	30'-8"	30'-10"	27'-11"	28'-0"	26'-3"	26'-5"	24'-5"	24'-6"
16"	NI-60	31'-1"	31'-1"	28'-3"	28'-4"	26'-0"	26'-0"	23'-3"	23'-3"	31'-0"	31'-1"	28'-3"	28'-4"	26'-0"	26'-0"	23'-3"	23'-3"
	NI-80	34'-1"	34'-2"	31'-0"	31'-1"	29'-2"	29'-3"	27'-1"	27'-2"	34'-1"	34'-2"	30'-11"	31'-1"	29'-2"	29'-3"	27'-1"	27'-2"
	NI-90	35'-0"	35'-0"	31'-9"	31'-10"	29'-11"	29'-11"	27'-9"	27'-10"	34'-11"	35'-0"	31'-9"	31'-10"	29'-10"	29'-11"	27'-9"	27'-10"

Live load deflection limit of L/360

Joist depth	Joist series	Notch location (x) ≤ 4 ft								Notch location (x) ≤ 8 ft							
		On center spacing								On center spacing							
		12"		16"		19.2"		24"		12"		16"		19.2"		24"	
		No repair	Repair	No repair	Repair	No repair	Repair	No repair	Repair	No repair	Repair	No repair	Repair	No repair	Repair	No repair	Repair
9-1/2"	NI-40x	21'-4"	21'-4"	18'-5"	18'-5"	16'-10"	16'-10"	15'-0"	15'-0"	21'-4"	21'-4"	18'-5"	18'-5"	16'-10"	16'-10"	-	-
	NI-60	22'-9"	22'-10"	20'-9"	20'-10"	19'-4"	19'-4"	17'-3"	17'-3"	22'-9"	22'-10"	20'-9"	20'-10"	19'-4"	19'-4"	17'-3"	17'-3"
	NI-80	25'-2"	25'-3"	22'-11"	23'-0"	21'-7"	21'-8"	19'-0"	19'-0"	25'-2"	25'-3"	22'-11"	23'-0"	21'-7"	21'-8"	19'-0"	19'-0"
11-7/8"	NI-40x	24'-4"	24'-4"	21'-0"	21'-0"	21'-0"	21'-0"	17'-1"	17'-1"	24'-4"	24'-4"	21'-0"	21'-0"	19'-2"	19'-2"	17'-1"	17'-1"
	NI-60	27'-3"	27'-3"	24'-1"	24'-1"	22'-0"	22'-0"	19'-8"	19'-8"	27'-2"	27'-3"	24'-1"	24'-1"	22'-0"	22'-0"	19'-8"	19'-8"
	NI-80	30'-0"	30'-0"	27'-3"	27'-4"	25'-9"	25'-9"	23'-5"	23'-5"	29'-11"	30'-0"	27'-3"	27'-4"	25'-8"	25'-9"	23'-5"	23'-5"
14"	NI-40x	30'-10"	30'-10"	28'-1"	28'-1"	26'-5"	26'-6"	24'-7"	24'-8"	30'-9"	30'-10"	28'-0"	28'-1"	26'-5"	26'-6"	24'-7"	24'-8"
	NI-60	26'-8"	26'-8"	23'-1"	23'-1"	21'-1"	21'-1"	18'-10"	18'-10"	26'-8"	26'-8"	23'-1"	23'-1"	21'-1"	21'-1"	18'-10"	18'-10"
	NI-80	30'-7"	30'-7"	26'-6"	26'-6"	24'-2"	24'-2"	21'-7"	21'-7"	30'-7"	30'-7"	26'-6"	26'-6"	24'-2"	24'-2"	21'-7"	21'-7"
16"	NI-60	33'-0"	33'-0"	28'-7"	28'-7"	26'-0"	26'-0"	23'-3"	23'-3"	33'-0"	33'-0"	28'-7"	28'-7"	26'-0"	26'-0"	23'-3"	23'-3"
	NI-80	37'-9"	37'-9"	34'-0"	34'-0"	31'-0"	31'-0"	27'-8"	27'-8"	37'-8"	37'-9"	34'-0"	34'-0"	31'-0"	31'-0"	27'-8"	27'-8"
	NI-90	38'-8"	38'-9"	35'-3"	35'-3"	33'-2"	33'-3"	28'-11"	28'-11"	38'-8"	38'-9"	35'-2"	35'-3"	33'-2"	33'-3"	28'-11"	28'-11"

Notes:

- The tabulated clear spans are applicable to residential floor construction meeting the above design criteria and are based on a sheathing thickness of 19/32 inch (40/20 or 20 oc) for a joist spacing of 19.2 inches or less and on a sheathing thickness of 23/32 inch (48/24 or 24 oc) for a joist spacing of 24 inches.
- Minimum bearing length shall be 1-3/4 inch for end bearings and 3-1/2 inches for intermediate bearings.
- Bearing stiffeners are not required when I-joists are used in accordance with these tables, except as required for hangers.
- See page 1 for design assumptions. Repair shall be designed according to detail on page 2.

Design Criteria

Notch depth:	1/2 inch
Span:	Simple span
Loads:	Live load = 40 psf and dead load = 15 psf
Deflection limit:	L/240 under total load
Sheathing:	APA Rated nailed-glued sheathing

Allowable Floor Spans

Live load deflection limit of L/480

Joist depth	Joist series	Notch location (x) ≤ 4 ft								Notch location (x) ≤ 8 ft							
		On center spacing								On center spacing							
		12"		16"		19.2"		24"		12"		16"		19.2"		24"	
		No repair	Repair	No repair	Repair	No repair	Repair	No repair	Repair	No repair	Repair	No repair	Repair	No repair	Repair	No repair	Repair
9-1/2"	NI-40x	18'-7"	18'-8"	16'-11"	17'-0"	16'-0"	16'-1"	14'-5"	14'-5"	18'-4"	18'-8"	15'-8"	17'-0"	14'-4"	16'-1"	-	-
	NI-60	18'-10"	18'-11"	17'-2"	17'-4"	16'-3"	16'-4"	15'-1"	15'-3"	18'-10"	18'-11"	17'-2"	17'-4"	16'-2"	16'-4"	-	-
	NI-80	20'-10"	20'-11"	19'-0"	19'-1"	17'-11"	18'-0"	16'-8"	16'-9"	20'-10"	20'-11"	18'-11"	19'-1"	17'-10"	18'-0"	16'-7"	16'-9"
11-7/8"	NI-40x	22'-1"	22'-2"	20'-1"	20'-1"	18'-4"	18'-4"	16'-5"	16'-5"	21'-5"	22'-2"	18'-0"	20'-1"	16'-4"	18'-4"	14'-7"	16'-5"
	NI-60	22'-6"	22'-8"	20'-7"	20'-8"	19'-5"	19'-6"	18'-1"	18'-2"	22'-6"	22'-8"	20'-6"	20'-8"	19'-0"	19'-6"	16'-9"	18'-2"
	NI-80	24'-10"	24'-11"	22'-7"	22'-8"	21'-3"	21'-4"	19'-9"	19'-11"	24'-9"	24'-11"	22'-7"	22'-8"	21'-3"	21'-4"	19'-9"	19'-11"
14"	NI-40x	25'-1"	25'-2"	22'-1"	22'-1"	20'-2"	20'-2"	18'-0"	18'-0"	24'-2"	25'-2"	20'-1"	22'-1"	18'-1"	20'-2"	16'-0"	18'-0"
	NI-60	25'-8"	25'-9"	23'-4"	23'-6"	22'-0"	22'-2"	20'-6"	20'-8"	25'-7"	25'-9"	23'-4"	23'-6"	21'-3"	22'-2"	18'-7"	20'-8"
	NI-80	28'-2"	28'-3"	25'-8"	25'-9"	24'-2"	24'-3"	22'-6"	22'-7"	28'-2"	28'-3"	25'-7"	25'-9"	24'-1"	24'-3"	22'-5"	22'-7"
16"	NI-60	28'-11"	29'-0"	26'-4"	26'-5"	24'-10"	24'-10"	23'-1"	23'-1"	28'-11"	29'-0"	26'-4"	26'-5"	24'-9"	24'-10"	23'-0"	23'-1"
	NI-80	28'-5"	28'-6"	25'-11"	26'-0"	24'-5"	24'-7"	22'-3"	22'-3"	28'-5"	28'-6"	25'-10"	26'-0"	23'-5"	24'-7"	20'-3"	22'-3"
	NI-90	31'-3"	31'-4"	28'-5"	28'-6"	26'-9"	26'-10"	24'-11"	25'-0"	31'-2"	31'-4"	28'-5"	28'-6"	26'-9"	26'-10"	24'-10"	25'-0"
		32'-0"	32'-1"	29'-2"	29'-2"	27'-5"	27'-6"	25'-6"	25'-7"	32'-0"	32'-1"	29'-1"	29'-2"	27'-5"	27'-6"	25'-6"	25'-7"

Live load deflection limit of L/360

Joist depth	Joist series	Notch location (x) ≤ 4 ft								Notch location (x) ≤ 8 ft							
		On center spacing								On center spacing							
		12"		16"		19.2"		24"		12"		16"		19.2"		24"	
		No repair	Repair	No repair	Repair	No repair	Repair	No repair	Repair	No repair	Repair	No repair	Repair	No repair	Repair	No repair	Repair
9-1/2"	NI-40x	20'-5"	20'-5"	17'-8"	17'-8"	16'-1"	16'-1"	14'-5"	14'-5"	18'-4"	20'-5"	15'-8"	17'-8"	14'-4"	16'-1"	-	-
	NI-60	20'-11"	21'-0"	19'-1"	19'-2"	18'-0"	18'-1"	16'-6"	16'-6"	20'-10"	21'-0"	18'-2"	19'-2"	16'-5"	18'-1"	14'-8"	16'-1"
	NI-80	23'-1"	23'-2"	21'-1"	21'-1"	19'-10"	19'-11"	18'-6"	18'-7"	23'-0"	23'-2"	21'-0"	21'-1"	19'-10"	19'-11"	18'-4"	18'-7"
11-7/8"	NI-40x	23'-3"	23'-3"	20'-1"	20'-1"	18'-4"	18'-4"	16'-5"	16'-5"	21'-5"	23'-3"	18'-0"	20'-1"	16'-4"	18'-4"	14'-7"	16'-5"
	NI-60	24'-11"	25'-0"	22'-9"	22'-10"	21'-0"	21'-0"	18'-10"	18'-10"	24'-11"	25'-0"	21'-3"	22'-10"	19'-0"	21'-0"	16'-9"	18'-7"
	NI-80	27'-6"	27'-6"	25'-0"	25'-1"	23'-7"	23'-8"	22'-0"	22'-1"	27'-5"	27'-6"	25'-0"	25'-1"	23'-7"	23'-8"	21'-5"	22'-1"
14"	NI-90	28'-3"	28'-4"	25'-9"	25'-10"	24'-3"	24'-4"	22'-7"	22'-8"	28'-2"	28'-4"	25'-8"	25'-10"	24'-3"	24'-4"	22'-6"	22'-8"
	NI-40x	25'-6"	25'-6"	22'-1"	22'-1"	20'-2"	20'-2"	18'-0"	18'-0"	24'-2"	25'-6"	20'-1"	22'-1"	18'-1"	20'-2"	16'-0"	18'-0"
	NI-60	28'-4"	28'-5"	25'-4"	25'-4"	23'-1"	23'-1"	20'-8"	20'-8"	28'-4"	28'-5"	23'-11"	25'-4"	21'-3"	23'-1"	18'-7"	20'-8"
16"	NI-80	31'-2"	31'-3"	28'-5"	28'-6"	26'-9"	26'-10"	24'-7"	24'-7"	31'-2"	31'-3"	28'-4"	28'-6"	26'-9"	26'-10"	24'-3"	24'-7"
	NI-90	32'-0"	32'-1"	29'-2"	29'-3"	27'-6"	27'-7"	25'-7"	25'-8"	32'-0"	32'-1"	29'-2"	29'-3"	27'-5"	27'-7"	25'-7"	25'-8"
	NI-60	31'-6"	31'-6"	27'-3"	27'-3"	24'-11"	24'-11"	22'-3"	22'-3"	31'-5"	31'-6"	26'-6"	27'-3"	23'-5"	24'-11"	20'-3"	22'-3"
		34'-7"	34'-8"	31'-6"	31'-7"	29'-7"	29'-7"	26'-6"	26'-6"	34'-6"	34'-8"	31'-5"	31'-7"	29'-7"	29'-7"	26'-6"	26'-6"
		35'-5"	35'-6"	32'-3"	32'-4"	30'-5"	30'-6"	28'-0"	28'-0"	35'-5"	35'-6"	32'-3"	32'-4"	30'-4"	30'-6"	28'-0"	28'-0"

Notes:

- The tabulated clear spans are applicable to residential floor construction meeting the above design criteria and are based on a sheathing thickness of 19/32 inch (40/20 or 20 oc) for a joist spacing of 19.2 inches or less and on a sheathing thickness of 23/32 inch (48/24 or 24 oc) for a joist spacing of 24 inches.
- Minimum bearing length shall be 1-3/4 inch for end bearings and 3-1/2 inches for intermediate bearings.
- Bearing stiffeners are not required when I-joists are used in accordance with these tables, except as required for hangers.
- See page 1 for design assumptions. Repair shall be designed according to detail on page 2.

Design Criteria

Notch depth:	1/2 inch
Span:	Multiple spans
Loads:	Live load = 40 psf and dead load = 15 psf
Deflection limit:	L/240 under total load
Sheathing:	APA Rated nailed-glued sheathing

Allowable Floor Spans

Live load deflection limit of L/480

Joist depth	Joist series	Notch location (x) ≤ 4 ft								Notch location (x) ≤ 8 ft							
		On center spacing								On center spacing							
		12"		16"		19.2"		24"		12"		16"		19.2"		24"	
		No repair	Repair	No repair	Repair	No repair	Repair	No repair	Repair	No repair	Repair	No repair	Repair	No repair	Repair	No repair	Repair
9-1/2"	NI-40x	20'-3"	20'-4"	17'-7"	17'-7"	16'-0"	16'-0"	14'-4"	14'-4"	20'-2"	20'-4"	17'-7"	17'-7"	16'-0"	16'-0"	-	-
	NI-60	20'-7"	20'-8"	18'-9"	18'-10"	17'-8"	17'-9"	16'-5"	16'-5"	20'-6"	20'-8"	18'-8"	18'-10"	17'-7"	17'-9"	16'-5"	16'-5"
	NI-80	22'-9"	22'-9"	20'-8"	20'-9"	19'-6"	19'-6"	17'-3"	17'-3"	22'-8"	22'-9"	20'-8"	20'-9"	19'-5"	19'-6"	17'-3"	17'-3"
11-7/8"	NI-40x	23'-2"	23'-2"	20'-0"	20'-0"	18'-3"	18'-3"	16'-4"	16'-4"	23'-2"	23'-2"	20'-0"	20'-0"	18'-3"	18'-3"	16'-4"	16'-4"
	NI-60	24'-7"	24'-8"	22'-5"	22'-6"	21'-0"	21'-0"	18'-9"	18'-9"	24'-6"	24'-8"	22'-4"	22'-4"	21'-0"	21'-0"	18'-9"	18'-9"
	NI-80	27'-1"	27'-1"	24'-7"	24'-8"	23'-2"	23'-3"	21'-4"	21'-4"	27'-0"	27'-1"	24'-7"	24'-8"	23'-2"	23'-3"	21'-4"	21'-4"
14"	NI-40x	25'-5"	25'-5"	22'-0"	22'-0"	20'-1"	20'-1"	17'-11"	17'-11"	25'-5"	25'-5"	22'-0"	22'-0"	20'-1"	20'-1"	17'-11"	17'-11"
	NI-60	28'-0"	28'-0"	25'-3"	25'-3"	23'-0"	23'-0"	20'-7"	20'-7"	27'-11"	28'-0"	25'-3"	25'-3"	23'-0"	23'-0"	20'-7"	20'-7"
	NI-80	30'-9"	30'-10"	28'-0"	28'-0"	26'-4"	26'-5"	24'-0"	24'-0"	30'-8"	30'-10"	27'-11"	28'-0"	26'-3"	26'-5"	24'-0"	24'-0"
16"	NI-60	31'-1"	31'-1"	27'-2"	27'-2"	24'-10"	24'-10"	22'-2"	22'-2"	31'-0"	31'-1"	27'-2"	27'-2"	24'-10"	24'-10"	22'-2"	22'-2"
	NI-80	34'-1"	34'-2"	31'-0"	31'-1"	29'-2"	29'-3"	26'-3"	26'-3"	34'-1"	34'-2"	30'-11"	31'-1"	29'-2"	29'-3"	26'-3"	26'-3"
	NI-90	35'-0"	35'-0"	31'-9"	31'-10"	29'-11"	29'-11"	26'-3"	26'-3"	34'-11"	35'-0"	31'-9"	31'-10"	29'-10"	29'-11"	26'-3"	26'-3"

Live load deflection limit of L/360

Joist depth	Joist series	Notch location (x) ≤ 4 ft								Notch location (x) ≤ 8 ft							
		On center spacing								On center spacing							
		12"		16"		19.2"		24"		12"		16"		19.2"		24"	
		No repair	Repair	No repair	Repair	No repair	Repair	No repair	Repair	No repair	Repair	No repair	Repair	No repair	Repair	No repair	Repair
9-1/2"	NI-40x	20'-4"	20'-4"	17'-7"	17'-7"	16'-0"	16'-0"	14'-4"	14'-4"	20'-4"	20'-4"	17'-7"	17'-7"	16'-0"	16'-0"	-	-
	NI-60	22'-9"	22'-10"	20'-2"	20'-2"	18'-5"	18'-5"	16'-5"	16'-5"	22'-9"	22'-10"	20'-2"	20'-2"	18'-5"	18'-5"	16'-5"	16'-5"
	NI-80	25'-2"	25'-3"	22'-11"	23'-0"	21'-7"	21'-7"	17'-3"	17'-3"	25'-2"	25'-3"	22'-11"	23'-0"	21'-7"	21'-7"	17'-3"	17'-3"
11-7/8"	NI-40x	23'-2"	23'-2"	20'-0"	20'-0"	18'-3"	18'-3"	16'-4"	16'-4"	23'-2"	23'-2"	20'-0"	20'-0"	18'-3"	18'-3"	16'-4"	16'-4"
	NI-60	26'-7"	26'-7"	23'-0"	23'-0"	21'-0"	21'-0"	18'-9"	18'-9"	26'-7"	26'-7"	23'-0"	23'-0"	21'-0"	21'-0"	18'-9"	18'-9"
	NI-80	30'-0"	30'-0"	27'-4"	27'-4"	25'-0"	25'-0"	21'-4"	21'-4"	29'-11"	30'-0"	27'-3"	27'-4"	25'-0"	25'-0"	21'-4"	21'-4"
14"	NI-40x	25'-5"	25'-5"	22'-0"	22'-0"	20'-1"	20'-1"	17'-11"	17'-11"	25'-5"	25'-5"	22'-0"	22'-0"	20'-1"	20'-1"	17'-11"	17'-11"
	NI-60	29'-2"	29'-2"	25'-3"	25'-3"	23'-0"	23'-0"	20'-7"	20'-7"	29'-2"	29'-2"	25'-3"	25'-3"	23'-0"	23'-0"	20'-7"	20'-7"
	NI-80	34'-0"	34'-1"	30'-1"	30'-1"	27'-5"	27'-5"	24'-0"	24'-0"	34'-0"	34'-1"	30'-1"	30'-1"	27'-5"	27'-5"	24'-0"	24'-0"
16"	NI-90	35'-0"	35'-0"	31'-10"	31'-10"	30'-0"	30'-0"	24'-2"	24'-2"	34'-11"	35'-0"	31'-9"	31'-10"	29'-11"	30'-0"	24'-2"	24'-2"
	NI-60	31'-5"	31'-5"	27'-2"	27'-2"	24'-10"	24'-10"	22'-2"	22'-2"	31'-5"	31'-5"	27'-2"	27'-2"	24'-10"	24'-10"	22'-2"	22'-2"
	NI-80	37'-5"	37'-5"	32'-5"	32'-5"	29'-7"	29'-7"	26'-3"	26'-3"	37'-5"	37'-5"	32'-5"	32'-5"	29'-7"	29'-7"	26'-3"	26'-3"
	NI-90	38'-8"	38'-9"	35'-3"	35'-3"	32'-10"	32'-10"	26'-3"	26'-3"	38'-8"	38'-9"	35'-2"	35'-3"	32'-10"	32'-10"	26'-3"	26'-3"

Notes:

- The tabulated clear spans are applicable to residential floor construction meeting the above design criteria and are based on a sheathing thickness of 19/32 inch (40/20 or 20 oc) for a joist spacing of 19.2 inches or less and on a sheathing thickness of 23/32 inch (48/24 or 24 oc) for a joist spacing of 24 inches.
- Minimum bearing length shall be 1-3/4 inch for end bearings and 3-1/2 inches for intermediate bearings.
- Bearing stiffeners are not required when I-joists are used in accordance with these tables, except as required for hangers.
- See page 1 for design assumptions. Repair shall be designed according to detail on page 2.

Design Criteria

Notch depth:	1 inch
Span:	Simple span
Loads:	Live load = 40 psf and dead load = 10 psf
Deflection limit:	L/240 under total load
Sheathing:	APA Rated nailed-glued sheathing

Allowable Floor Spans

Live load deflection limit of L/480

Joist depth	Joist series	Notch location (x) ≤ 4 ft								Notch location (x) ≤ 8 ft							
		On center spacing								On center spacing							
		12"		16"		19.2"		24"		12"		16"		19.2"		24"	
No repair	Repair	No repair	Repair	No repair	Repair	No repair	Repair	No repair	Repair	No repair	Repair	No repair	Repair	No repair	Repair		
9-1/2"	NI-40x	18'-5"	18'-8"	16'-9"	17'-0"	14'-7"	16'-1"	12'-5"	15'-0"	16'-4"	18'-8"	14'-2"	16'-6"	-	-	-	-
	NI-60	18'-9"	18'-11"	17'-1"	17'-4"	16'-1"	16'-4"	14'-11"	15'-3"	18'-7"	18'-11"	16'-3"	17'-4"	14'-10"	16'-4"	-	-
	NI-80	20'-9"	20'-11"	18'-11"	19'-1"	17'-9"	18'-0"	16'-6"	16'-9"	20'-8"	20'-11"	18'-9"	19'-1"	17'-8"	18'-0"	16'-5"	16'-9"
11-7/8"	NI-40x	22'-0"	22'-2"	20'-0"	20'-3"	17'-9"	19'-2"	15'-0"	17'-2"	18'-10"	22'-2"	16'-1"	19'-1"	14'-9"	17'-2"	-	-
	NI-60	22'-5"	22'-8"	20'-5"	20'-8"	19'-3"	19'-6"	17'-10"	18'-2"	22'-4"	22'-8"	18'-8"	20'-8"	16'-10"	19'-4"	15'-1"	17'-1"
	NI-80	24'-9"	24'-11"	22'-6"	22'-8"	21'-2"	21'-4"	19'-8"	19'-11"	24'-7"	24'-11"	22'-4"	22'-8"	21'-1"	21'-4"	19'-7"	19'-11"
14"	NI-40x	24'-11"	25'-2"	22'-8"	22'-11"	20'-7"	21'-2"	17'-3"	18'-11"	21'-1"	25'-2"	17'-9"	21'-5"	16'-1"	19'-1"	14'-5"	16'-10"
	NI-60	25'-5"	25'-9"	23'-3"	23'-6"	21'-10"	22'-2"	20'-4"	20'-8"	25'-3"	25'-9"	20'-11"	23'-6"	18'-9"	21'-9"	16'-6"	18'-11"
	NI-80	28'-1"	28'-3"	25'-7"	25'-9"	24'-1"	24'-3"	22'-4"	22'-7"	28'-0"	28'-3"	25'-5"	25'-9"	23'-11"	24'-3"	22'-3"	22'-7"
16"	NI-40x	28'-10"	29'-0"	26'-3"	26'-5"	24'-8"	24'-10"	22'-11"	23'-1"	28'-9"	29'-0"	26'-1"	26'-5"	24'-7"	24'-10"	22'-10"	23'-1"
	NI-60	28'-4"	28'-6"	25'-9"	26'-0"	24'-3"	24'-7"	22'-7"	22'-10"	28'-1"	28'-6"	23'-0"	26'-0"	20'-6"	23'-11"	17'-11"	20'-9"
	NI-80	31'-2"	31'-4"	28'-4"	28'-6"	26'-8"	26'-10"	24'-9"	25'-0"	31'-0"	31'-4"	28'-2"	28'-6"	26'-7"	26'-10"	24'-8"	25'-0"
NI-90	31'-11"	32'-1"	29'-0"	29'-2"	27'-4"	27'-6"	25'-5"	25'-7"	31'-10"	32'-1"	28'-11"	29'-2"	27'-3"	27'-6"	25'-3"	25'-7"	

Live load deflection limit of L/360

Joist depth	Joist series	Notch location (x) ≤ 4 ft								Notch location (x) ≤ 8 ft							
		On center spacing								On center spacing							
		12"		16"		19.2"		24"		12"		16"		19.2"		24"	
No repair	Repair	No repair	Repair	No repair	Repair	No repair	Repair	No repair	Repair	No repair	Repair	No repair	Repair	No repair	Repair		
9-1/2"	NI-40x	20'-5"	20'-7"	16'-9"	18'-6"	14'-7"	16'-11"	12'-5"	15'-1"	16'-4"	19'-5"	14'-2"	16'-6"	-	-	-	-
	NI-60	20'-9"	21'-0"	18'-11"	19'-2"	17'-10"	18'-1"	15'-2"	16'-11"	19'-0"	21'-0"	16'-3"	18'-6"	14'-10"	16'-9"	-	-
	NI-80	23'-0"	23'-2"	20'-11"	21'-1"	19'-9"	19'-11"	18'-4"	18'-7"	22'-10"	23'-2"	20'-10"	21'-1"	19'-7"	19'-11"	17'-5"	18'-7"
11-7/8"	NI-40x	24'-4"	24'-5"	20'-7"	21'-1"	17'-9"	19'-3"	15'-0"	17'-2"	18'-10"	22'-10"	16'-1"	19'-1"	14'-9"	17'-2"	-	-
	NI-60	24'-10"	25'-0"	22'-7"	22'-10"	21'-4"	21'-7"	18'-6"	19'-9"	22'-4"	25'-0"	18'-8"	21'-8"	16'-10"	19'-4"	15'-1"	17'-1"
	NI-80	27'-4"	27'-6"	24'-11"	25'-1"	23'-6"	23'-8"	21'-10"	22'-1"	27'-3"	27'-6"	24'-10"	25'-1"	23'-4"	23'-8"	20'-3"	22'-1"
14"	NI-40x	28'-2"	28'-4"	25'-8"	25'-10"	24'-2"	24'-4"	22'-5"	22'-8"	28'-0"	28'-4"	25'-6"	25'-10"	24'-0"	24'-4"	22'-4"	22'-8"
	NI-60	26'-9"	26'-9"	23'-2"	23'-2"	20'-7"	21'-2"	17'-3"	18'-11"	21'-1"	25'-11"	17'-9"	21'-5"	16'-1"	19'-1"	14'-5"	16'-10"
	NI-80	28'-3"	28'-5"	25'-8"	26'-0"	24'-3"	24'-3"	21'-5"	21'-8"	25'-3"	28'-5"	20'-11"	24'-6"	18'-9"	21'-9"	16'-6"	18'-11"
16"	NI-40x	31'-1"	31'-3"	28'-4"	28'-6"	26'-8"	26'-10"	24'-10"	25'-0"	31'-0"	31'-3"	28'-2"	28'-6"	26'-6"	26'-10"	22'-9"	25'-0"
	NI-60	31'-11"	32'-1"	29'-1"	29'-3"	27'-5"	27'-7"	25'-6"	25'-8"	31'-10"	32'-1"	28'-11"	29'-3"	27'-3"	27'-7"	25'-4"	25'-8"
	NI-80	31'-4"	31'-6"	28'-6"	28'-7"	26'-1"	26'-1"	23'-4"	23'-4"	28'-1"	31'-6"	23'-0"	27'-2"	20'-6"	23'-11"	17'-11"	20'-9"
NI-90	34'-5"	34'-8"	31'-4"	31'-7"	29'-7"	29'-9"	27'-6"	27'-9"	34'-4"	34'-8"	31'-3"	31'-7"	29'-5"	29'-9"	25'-2"	27'-9"	
NI-90	35'-4"	35'-6"	32'-2"	32'-4"	30'-4"	30'-6"	28'-2"	28'-5"	35'-3"	35'-6"	32'-1"	32'-4"	30'-2"	30'-6"	28'-1"	28'-5"	

Notes:

- The tabulated clear spans are applicable to residential floor construction meeting the above design criteria and are based on a sheathing thickness of 19/32 inch (40/20 or 20 oc) for a joist spacing of 19.2 inches or less and on a sheathing thickness of 23/32 inch (48/24 or 24 oc) for a joist spacing of 24 inches.
- Minimum bearing length shall be 1-3/4 inch for end bearings and 3-1/2 inches for intermediate bearings.
- Bearing stiffeners are not required when I-joists are used in accordance with these tables, except as required for hangers.
- See page 1 for design assumptions. Repair shall be designed according to detail on page 2.

Design Criteria

Notch depth:	1 inch
Span:	Multiple spans
Loads:	Live load = 40 psf and dead load = 10 psf
Deflection limit:	L/240 under total load
Sheathing:	APA Rated nailed-glued sheathing

Allowable Floor Spans

Live load deflection limit of L/480

Joist depth	Joist series	Notch location (x) ≤ 4 ft								Notch location (x) ≤ 8 ft							
		On center spacing								On center spacing							
		12"		16"		19.2"		24"		12"		16"		19.2"		24"	
		No repair	Repair	No repair	Repair	No repair	Repair	No repair	Repair	No repair	Repair	No repair	Repair	No repair	Repair	No repair	Repair
9-1/2"	NI-40x	20'-1"	20'-4"	18'-3"	18'-5"	16'-10"	16'-10"	15'-0"	15'-0"	20'-0"	20'-4"	17'-9"	18'-5"	16'-5"	16'-10"	-	-
	NI-60	20'-5"	20'-8"	18'-7"	18'-10"	17'-6"	17'-9"	16'-3"	16'-7"	20'-4"	20'-8"	18'-6"	18'-10"	17'-5"	17'-9"	16'-2"	16'-7"
	NI-80	22'-8"	22'-9"	20'-7"	20'-9"	19'-4"	19'-6"	18'-0"	18'-2"	22'-6"	22'-9"	20'-5"	20'-9"	19'-3"	19'-6"	17'-10"	18'-2"
11-7/8"	NI-40x	24'-0"	24'-2"	21'-0"	21'-0"	19'-2"	19'-2"	17'-1"	17'-1"	23'-7"	24'-2"	20'-1"	21'-0"	18'-4"	19'-2"	16'-7"	17'-1"
	NI-60	24'-5"	24'-8"	22'-3"	22'-6"	21'-0"	21'-2"	19'-6"	19'-8"	24'-4"	24'-8"	22'-2"	22'-6"	20'-11"	21'-2"	18'-9"	19'-8"
	NI-80	27'-0"	27'-1"	24'-6"	24'-8"	23'-1"	23'-3"	21'-5"	21'-7"	26'-10"	27'-1"	24'-5"	24'-8"	22'-11"	23'-3"	21'-4"	21'-7"
14"	NI-40x	26'-8"	26'-8"	23'-1"	23'-1"	21'-1"	21'-1"	18'-10"	18'-10"	26'-4"	26'-8"	22'-2"	23'-1"	20'-1"	21'-1"	18'-0"	18'-10"
	NI-60	27'-10"	28'-0"	25'-4"	25'-7"	23'-10"	24'-1"	21'-7"	21'-7"	27'-9"	28'-0"	25'-2"	25'-7"	23'-4"	24'-1"	20'-8"	21'-7"
	NI-80	30'-8"	30'-10"	27'-10"	28'-0"	26'-3"	26'-5"	24'-4"	24'-6"	30'-6"	30'-10"	27'-9"	28'-0"	26'-1"	26'-5"	24'-3"	24'-6"
16"	NI-60	31'-6"	31'-7"	28'-7"	28'-9"	26'-11"	27'-1"	25'-0"	25'-2"	31'-4"	31'-7"	28'-6"	28'-9"	26'-10"	27'-1"	24'-10"	25'-2"
	NI-80	30'-11"	31'-1"	28'-1"	28'-4"	26'-0"	26'-0"	23'-3"	23'-3"	30'-11"	31'-1"	28'-0"	28'-4"	25'-7"	26'-0"	22'-4"	23'-3"
	NI-90	34'-0"	34'-2"	30'-11"	31'-1"	29'-1"	29'-3"	27'-0"	27'-2"	33'-10"	34'-2"	30'-9"	31'-1"	28'-11"	29'-3"	26'-11"	27'-2"
	NI-90	34'-10"	35'-0"	31'-8"	31'-10"	29'-10"	29'-11"	27'-8"	27'-10"	34'-9"	35'-0"	31'-7"	31'-10"	29'-8"	29'-11"	27'-6"	27'-10"

Live load deflection limit of L/360

Joist depth	Joist series	Notch location (x) ≤ 4 ft								Notch location (x) ≤ 8 ft							
		On center spacing								On center spacing							
		12"		16"		19.2"		24"		12"		16"		19.2"		24"	
		No repair	Repair	No repair	Repair	No repair	Repair	No repair	Repair	No repair	Repair	No repair	Repair	No repair	Repair	No repair	Repair
9-1/2"	NI-40x	21'-4"	21'-4"	18'-5"	18'-5"	16'-10"	16'-10"	15'-0"	15'-0"	20'-5"	21'-4"	17'-9"	18'-5"	16'-5"	16'-10"	-	-
	NI-60	22'-8"	22'-10"	20'-7"	20'-10"	19'-4"	19'-4"	17'-3"	17'-3"	22'-6"	22'-10"	20'-3"	20'-10"	18'-6"	19'-4"	16'-9"	17'-3"
	NI-80	25'-1"	25'-3"	22'-10"	23'-0"	21'-6"	21'-8"	19'-0"	19'-0"	25'-0"	25'-3"	22'-9"	23'-0"	21'-5"	21'-8"	19'-0"	19'-0"
11-7/8"	NI-40x	24'-4"	24'-4"	21'-0"	21'-0"	19'-2"	19'-2"	17'-1"	17'-1"	23'-7"	24'-4"	20'-1"	21'-0"	18'-4"	19'-2"	16'-7"	17'-1"
	NI-60	27'-1"	27'-3"	24'-1"	24'-1"	22'-0"	22'-0"	19'-8"	19'-8"	26'-11"	27'-3"	23'-4"	24'-1"	21'-1"	22'-0"	18'-9"	19'-8"
	NI-80	29'-10"	30'-0"	27'-2"	27'-4"	25'-7"	25'-9"	23'-5"	23'-5"	29'-9"	30'-0"	27'-1"	27'-4"	25'-6"	25'-9"	23'-5"	23'-5"
14"	NI-40x	30'-9"	30'-10"	27'-11"	28'-1"	26'-4"	26'-6"	24'-6"	24'-8"	30'-7"	30'-10"	27'-10"	28'-1"	26'-2"	26'-6"	24'-4"	24'-8"
	NI-60	26'-8"	26'-8"	23'-1"	23'-1"	21'-1"	21'-1"	18'-10"	18'-10"	26'-4"	26'-8"	22'-2"	23'-1"	20'-1"	21'-1"	18'-0"	18'-10"
	NI-80	30'-7"	30'-7"	26'-6"	26'-6"	24'-2"	24'-2"	21'-7"	21'-7"	30'-7"	30'-7"	26'-1"	26'-6"	23'-4"	24'-2"	20'-8"	21'-7"
16"	NI-60	33'-11"	34'-1"	30'-11"	31'-1"	28'-9"	28'-9"	25'-9"	25'-9"	33'-10"	34'-1"	30'-9"	31'-1"	28'-9"	28'-9"	25'-9"	25'-9"
	NI-80	34'-10"	35'-0"	31'-9"	31'-10"	29'-10"	30'-0"	26'-7"	26'-7"	34'-9"	35'-0"	31'-7"	31'-10"	29'-9"	30'-0"	26'-7"	26'-7"
	NI-90	33'-0"	33'-0"	28'-7"	28'-7"	26'-0"	26'-0"	23'-3"	23'-3"	33'-0"	33'-0"	28'-7"	28'-7"	25'-7"	26'-0"	22'-4"	23'-3"
	NI-80	37'-8"	37'-9"	34'-0"	34'-0"	31'-0"	31'-0"	27'-8"	27'-8"	37'-6"	37'-9"	34'-0"	34'-0"	31'-0"	31'-0"	27'-8"	27'-8"
	NI-90	38'-7"	38'-9"	35'-1"	35'-3"	33'-1"	33'-3"	28'-11"	28'-11"	38'-6"	38'-9"	35'-0"	35'-3"	32'-11"	33'-3"	28'-11"	28'-11"

Notes:

- The tabulated clear spans are applicable to residential floor construction meeting the above design criteria and are based on a sheathing thickness of 19/32 inch (40/20 or 20 oc) for a joist spacing of 19.2 inches or less and on a sheathing thickness of 23/32 inch (48/24 or 24 oc) for a joist spacing of 24 inches.
- Minimum bearing length shall be 1-3/4 inch for end bearings and 3-1/2 inches for intermediate bearings.
- Bearing stiffeners are not required when I-joists are used in accordance with these tables, except as required for hangers.
- See page 1 for design assumptions. Repair shall be designed according to detail on page 2.

Design Criteria

Notch depth:	1 inch
Span:	Simple span
Loads:	Live load = 40 psf and dead load = 15 psf
Deflection limit:	L/240 under total load
Sheathing:	APA Rated nailed-glued sheathing

Allowable Floor Spans

Live load deflection limit of L/480

Joist depth	Joist series	Notch location (x) ≤ 4 ft								Notch location (x) ≤ 8 ft							
		On center spacing								On center spacing							
		12"		16"		19.2"		24"		12"		16"		19.2"		24"	
		No repair	Repair	No repair	Repair	No repair	Repair	No repair	Repair	No repair	Repair	No repair	Repair	No repair	Repair	No repair	Repair
9-1/2"	NI-40x	18'-5"	18'-8"	15'-7"	17'-0"	13'-7"	16'-1"	11'-8"	14'-5"	15'-7"	18'-4"	13'-7"	15'-9"	-	-	-	-
	NI-60	18'-9"	18'-11"	17'-1"	17'-4"	16'-1"	16'-4"	14'-1"	15'-3"	18'-0"	18'-11"	15'-5"	17'-4"	14'-2"	15'-11"	-	-
	NI-80	20'-9"	20'-11"	18'-11"	19'-1"	17'-9"	18'-0"	16'-6"	16'-9"	20'-8"	20'-11"	18'-9"	19'-1"	17'-8"	18'-0"	16'-5"	16'-9"
11-7/8"	NI-40x	22'-0"	22'-2"	19'-0"	20'-1"	16'-6"	18'-4"	13'-11"	16'-5"	17'-10"	21'-6"	15'-4"	18'-1"	14'-1"	16'-4"	-	-
	NI-60	22'-5"	22'-8"	20'-5"	20'-8"	19'-3"	19'-6"	17'-2"	18'-2"	21'-0"	22'-8"	17'-8"	20'-5"	16'-1"	18'-4"	14'-5"	16'-2"
	NI-80	24'-9"	24'-11"	22'-6"	22'-8"	21'-2"	21'-4"	19'-8"	19'-11"	24'-7"	24'-11"	22'-4"	22'-8"	21'-1"	21'-4"	19'-1"	19'-11"
14"	NI-40x	24'-11"	25'-2"	22'-1"	22'-1"	19'-1"	20'-2"	16'-0"	18'-0"	19'-11"	24'-3"	16'-11"	20'-2"	15'-4"	18'-1"	13'-10"	16'-0"
	NI-60	25'-5"	25'-9"	23'-3"	23'-6"	21'-10"	22'-2"	19'-10"	20'-8"	23'-8"	25'-9"	19'-9"	23'-0"	17'-9"	20'-5"	15'-9"	17'-11"
	NI-80	28'-1"	28'-3"	25'-7"	25'-9"	24'-1"	24'-3"	22'-4"	22'-7"	28'-0"	28'-3"	25'-5"	25'-9"	23'-11"	24'-3"	21'-5"	22'-7"
16"	NI-40x	28'-10"	29'-0"	26'-3"	26'-5"	24'-8"	24'-10"	22'-11"	23'-1"	28'-9"	29'-0"	26'-1"	26'-5"	24'-7"	24'-10"	22'-10"	23'-1"
	NI-60	28'-4"	28'-6"	25'-9"	26'-0"	24'-3"	24'-7"	22'-3"	22'-3"	26'-3"	28'-6"	21'-7"	25'-5"	19'-4"	22'-6"	17'-0"	19'-6"
	NI-80	31'-2"	31'-4"	28'-4"	28'-6"	26'-8"	26'-10"	24'-9"	25'-0"	31'-0"	31'-4"	28'-2"	28'-6"	26'-7"	26'-10"	23'-7"	25'-0"
	NI-90	31'-11"	32'-1"	29'-0"	29'-2"	27'-4"	27'-6"	25'-5"	25'-7"	31'-10"	32'-1"	28'-11"	29'-2"	27'-3"	27'-6"	25'-3"	25'-7"

Live load deflection limit of L/360

Joist depth	Joist series	Notch location (x) ≤ 4 ft								Notch location (x) ≤ 8 ft							
		On center spacing								On center spacing							
		12"		16"		19.2"		24"		12"		16"		19.2"		24"	
		No repair	Repair	No repair	Repair	No repair	Repair	No repair	Repair	No repair	Repair	No repair	Repair	No repair	Repair	No repair	Repair
9-1/2"	NI-40x	19'-6"	20'-5"	15'-7"	17'-8"	13'-7"	16'-1"	11'-8"	14'-5"	15'-7"	18'-4"	13'-7"	15'-9"	-	-	-	-
	NI-60	20'-9"	21'-0"	18'-11"	19'-2"	16'-8"	18'-1"	14'-1"	16'-6"	18'-0"	20'-10"	15'-5"	17'-7"	14'-2"	15'-11"	-	-
	NI-80	23'-0"	23'-2"	20'-11"	21'-1"	19'-9"	19'-11"	18'-4"	18'-7"	22'-10"	23'-2"	20'-10"	21'-1"	18'-8"	19'-11"	16'-6"	17'-11"
11-7/8"	NI-40x	23'-3"	23'-3"	19'-0"	20'-1"	16'-6"	18'-4"	13'-11"	16'-5"	17'-10"	21'-6"	15'-4"	18'-1"	14'-1"	16'-4"	-	-
	NI-60	24'-10"	25'-0"	22'-7"	22'-10"	20'-6"	21'-0"	17'-2"	18'-10"	21'-0"	24'-8"	17'-8"	20'-5"	16'-1"	18'-4"	14'-5"	16'-2"
	NI-80	27'-4"	27'-6"	24'-11"	25'-1"	23'-6"	23'-8"	21'-10"	22'-1"	27'-3"	27'-6"	24'-9"	25'-1"	21'-11"	23'-8"	19'-1"	20'-11"
14"	NI-40x	28'-2"	28'-4"	25'-8"	25'-10"	24'-2"	24'-4"	22'-5"	22'-8"	28'-0"	28'-4"	25'-6"	25'-10"	24'-0"	24'-4"	22'-0"	22'-8"
	NI-60	25'-6"	25'-6"	22'-1"	22'-1"	19'-1"	20'-2"	16'-0"	18'-0"	19'-11"	24'-3"	16'-11"	20'-2"	15'-4"	18'-1"	13'-10"	16'-0"
	NI-80	28'-3"	28'-5"	25'-4"	25'-4"	23'-1"	23'-1"	19'-10"	20'-8"	23'-8"	28'-1"	19'-9"	23'-0"	17'-9"	20'-5"	15'-9"	17'-11"
16"	NI-40x	31'-1"	31'-3"	28'-4"	28'-6"	26'-8"	26'-10"	24'-7"	24'-7"	31'-0"	31'-3"	28'-2"	28'-6"	24'-10"	26'-10"	21'-5"	23'-7"
	NI-60	31'-11"	32'-1"	29'-1"	29'-3"	27'-5"	27'-7"	25'-6"	25'-8"	31'-10"	32'-1"	28'-11"	29'-3"	27'-3"	27'-7"	24'-11"	25'-8"
	NI-80	31'-4"	31'-6"	27'-3"	27'-3"	24'-11"	24'-11"	22'-3"	22'-3"	26'-3"	31'-3"	21'-7"	25'-5"	19'-4"	22'-6"	17'-0"	19'-6"
16"	NI-80	34'-5"	34'-8"	31'-4"	31'-7"	29'-7"	29'-7"	26'-6"	26'-6"	34'-4"	34'-8"	31'-3"	31'-7"	27'-6"	29'-7"	23'-7"	26'-1"
	NI-90	35'-4"	35'-6"	32'-2"	32'-4"	30'-4"	30'-6"	28'-0"	28'-0"	35'-3"	35'-6"	32'-1"	32'-4"	30'-2"	30'-6"	27'-7"	28'-0"

Notes:

- The tabulated clear spans are applicable to residential floor construction meeting the above design criteria and are based on a sheathing thickness of 19/32 inch (40/20 or 20 oc) for a joist spacing of 19.2 inches or less and on a sheathing thickness of 23/32 inch (48/24 or 24 oc) for a joist spacing of 24 inches.
- Minimum bearing length shall be 1-3/4 inch for end bearings and 3-1/2 inches for intermediate bearings.
- Bearing stiffeners are not required when I-joists are used in accordance with these tables, except as required for hangers.
- See page 1 for design assumptions. Repair shall be designed according to detail on page 2.

Design Criteria

Notch depth:	1 inch
Span:	Multiple spans
Loads:	Live load = 40 psf and dead load = 15 psf
Deflection limit:	L/240 under total load
Sheathing:	APA Rated nailed-glued sheathing

Allowable Floor Spans

Live load deflection limit of L/480

Joist depth	Joist series	Notch location (x) ≤ 4 ft								Notch location (x) ≤ 8 ft							
		On center spacing								On center spacing							
		12"		16"		19.2"		24"		12"		16"		19.2"		24"	
		No repair	Repair	No repair	Repair	No repair	Repair	No repair	Repair	No repair	Repair	No repair	Repair	No repair	Repair	No repair	Repair
9-1/2"	NI-40x	20'-1"	20'-4"	17'-7"	17'-7"	16'-0"	16'-0"	14'-4"	14'-4"	19'-5"	20'-4"	17'-0"	17'-7"	15'-9"	16'-0"	-	-
	NI-60	20'-5"	20'-8"	18'-7"	18'-10"	17'-6"	17'-9"	16'-3"	16'-5"	20'-4"	20'-8"	18'-6"	18'-10"	17'-5"	17'-9"	16'-1"	16'-5"
	NI-80	22'-8"	22'-9"	20'-7"	20'-9"	19'-4"	19'-6"	17'-3"	17'-3"	22'-6"	22'-9"	20'-5"	20'-9"	19'-3"	19'-6"	17'-3"	17'-3"
11-7/8"	NI-40x	23'-2"	23'-2"	20'-0"	20'-0"	18'-3"	18'-3"	16'-4"	16'-4"	22'-3"	23'-2"	19'-2"	20'-0"	17'-7"	18'-3"	16'-0"	16'-4"
	NI-60	24'-5"	24'-8"	22'-3"	22'-6"	21'-0"	21'-0"	18'-9"	18'-9"	24'-4"	24'-8"	22'-1"	22'-6"	20'-0"	21'-0"	17'-11"	18'-9"
	NI-80	27'-0"	27'-1"	24'-6"	24'-8"	23'-1"	23'-3"	21'-4"	21'-4"	26'-10"	27'-1"	24'-5"	24'-8"	22'-11"	23'-3"	21'-4"	21'-4"
14"	NI-40x	25'-5"	25'-5"	22'-0"	22'-0"	20'-1"	20'-1"	17'-11"	17'-11"	24'-10"	25'-5"	21'-1"	22'-0"	19'-2"	20'-1"	17'-3"	17'-11"
	NI-60	27'-10"	28'-0"	25'-3"	25'-3"	23'-0"	23'-0"	20'-7"	20'-7"	27'-9"	28'-0"	24'-7"	25'-3"	22'-1"	23'-0"	19'-8"	20'-7"
	NI-80	30'-8"	30'-10"	27'-10"	28'-0"	26'-3"	26'-5"	24'-0"	24'-0"	30'-6"	30'-10"	27'-9"	28'-0"	26'-1"	26'-5"	24'-0"	24'-0"
16"	NI-40x	31'-6"	31'-7"	28'-7"	28'-9"	26'-11"	27'-1"	24'-2"	24'-2"	31'-4"	31'-7"	28'-6"	28'-9"	26'-10"	27'-1"	24'-2"	24'-2"
	NI-60	30'-11"	31'-1"	27'-2"	27'-2"	24'-10"	24'-10"	22'-2"	22'-2"	30'-11"	31'-1"	27'-0"	27'-2"	24'-1"	24'-10"	21'-3"	22'-2"
	NI-80	34'-0"	34'-2"	30'-11"	31'-1"	29'-1"	29'-3"	26'-3"	26'-3"	33'-10"	34'-2"	30'-9"	31'-1"	28'-11"	29'-3"	26'-3"	26'-3"
	NI-90	34'-10"	35'-0"	31'-8"	31'-10"	29'-10"	29'-11"	26'-3"	26'-3"	34'-9"	35'-0"	31'-7"	31'-10"	29'-8"	29'-11"	26'-3"	26'-3"

Live load deflection limit of L/360

Joist depth	Joist series	Notch location (x) ≤ 4 ft								Notch location (x) ≤ 8 ft							
		On center spacing								On center spacing							
		12"		16"		19.2"		24"		12"		16"		19.2"		24"	
		No repair	Repair	No repair	Repair	No repair	Repair	No repair	Repair	No repair	Repair	No repair	Repair	No repair	Repair	No repair	Repair
9-1/2"	NI-40x	20'-4"	20'-4"	17'-7"	17'-7"	16'-0"	16'-0"	14'-4"	14'-4"	19'-5"	20'-4"	17'-0"	17'-7"	15'-9"	16'-0"	-	-
	NI-60	22'-8"	22'-10"	20'-2"	20'-2"	18'-5"	18'-5"	16'-5"	16'-5"	22'-6"	22'-10"	19'-3"	20'-2"	17'-8"	18'-5"	16'-1"	16'-5"
	NI-80	25'-1"	25'-3"	22'-10"	23'-0"	21'-6"	21'-7"	17'-3"	17'-3"	25'-0"	25'-3"	22'-9"	23'-0"	21'-5"	21'-7"	17'-3"	17'-3"
11-7/8"	NI-40x	23'-2"	23'-2"	20'-0"	20'-0"	18'-3"	18'-3"	16'-4"	16'-4"	22'-3"	23'-2"	19'-2"	20'-0"	17'-7"	18'-3"	16'-0"	16'-4"
	NI-60	26'-7"	26'-7"	23'-0"	23'-0"	21'-0"	21'-0"	18'-9"	18'-9"	26'-3"	26'-7"	22'-1"	23'-0"	20'-0"	21'-0"	17'-11"	18'-9"
	NI-80	29'-10"	30'-0"	27'-2"	27'-4"	25'-0"	25'-0"	21'-4"	21'-4"	29'-9"	30'-0"	27'-1"	27'-4"	25'-0"	25'-0"	21'-4"	21'-4"
14"	NI-40x	30'-9"	30'-10"	27'-11"	28'-1"	26'-4"	26'-6"	24'-2"	24'-2"	30'-7"	30'-10"	27'-10"	28'-1"	26'-2"	26'-6"	24'-2"	24'-2"
	NI-60	25'-5"	25'-5"	22'-0"	22'-0"	20'-1"	20'-1"	17'-11"	17'-11"	24'-10"	25'-5"	21'-1"	22'-0"	19'-2"	20'-1"	17'-3"	17'-11"
	NI-80	29'-2"	29'-2"	25'-3"	25'-3"	23'-0"	23'-0"	20'-7"	20'-7"	29'-2"	29'-2"	24'-7"	25'-3"	22'-1"	23'-0"	19'-8"	20'-7"
16"	NI-40x	33'-11"	34'-1"	30'-1"	30'-1"	27'-5"	27'-5"	24'-0"	24'-0"	33'-10"	34'-1"	30'-1"	30'-1"	27'-5"	27'-5"	24'-0"	24'-0"
	NI-60	34'-10"	35'-0"	31'-9"	31'-10"	29'-10"	30'-0"	24'-2"	24'-2"	34'-9"	35'-0"	31'-7"	31'-10"	29'-9"	30'-0"	24'-2"	24'-2"
	NI-80	31'-5"	31'-5"	27'-2"	27'-2"	24'-10"	24'-10"	22'-2"	22'-2"	31'-5"	31'-5"	27'-0"	27'-2"	24'-1"	24'-10"	21'-3"	22'-2"
	NI-90	37'-5"	37'-5"	32'-5"	32'-5"	29'-7"	29'-7"	26'-3"	26'-3"	37'-5"	37'-5"	32'-5"	32'-5"	29'-7"	29'-7"	26'-3"	26'-3"
	NI-90	38'-7"	38'-9"	35'-1"	35'-3"	32'-10"	32'-10"	26'-3"	26'-3"	38'-6"	38'-9"	35'-0"	35'-3"	32'-10"	32'-10"	26'-3"	26'-3"

Notes:

- The tabulated clear spans are applicable to residential floor construction meeting the above design criteria and are based on a sheathing thickness of 19/32 inch (40/20 or 20 oc) for a joist spacing of 19.2 inches or less and on a sheathing thickness of 23/32 inch (48/24 or 24 oc) for a joist spacing of 24 inches.
- Minimum bearing length shall be 1-3/4 inch for end bearings and 3-1/2 inches for intermediate bearings.
- Bearing stiffeners are not required when I-joists are used in accordance with these tables, except as required for hangers.
- See page 1 for design assumptions. Repair shall be designed according to detail on page 2.