

**ENTRY DETAIL**  
SCALE: 1/8" = 1'-0"

PROVIDE HANDRAIL  
WHEN REQUIRED BY  
CODE

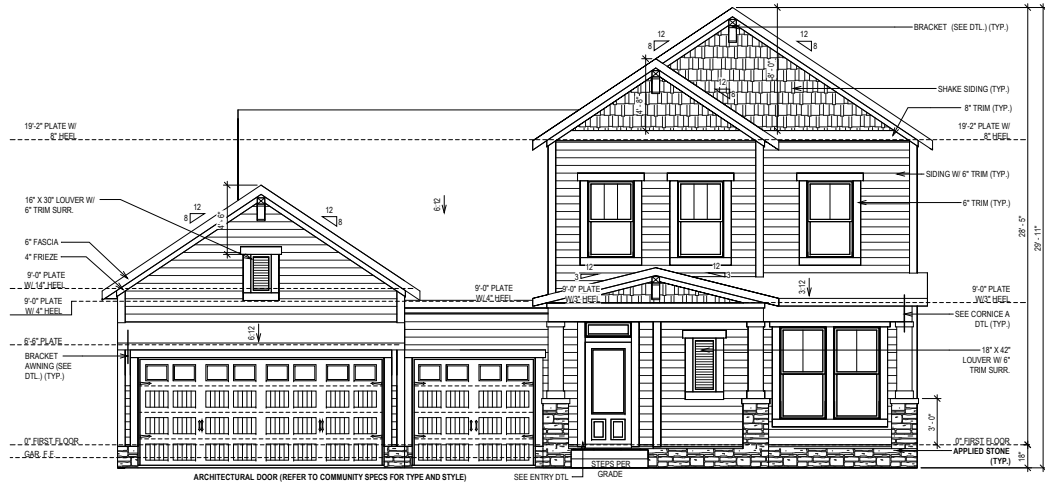

**FRONT ELEVATION "B"**



**REAR ELEVATION**

© Weekley Homes, L.P. 2020  
The measurements, dimensions, and other specifications shown on this document are guidelines for construction use only. This document may not be relied on as a representation of what the completed structure will look like.

**David Weekley Homes**  
C/N/NU/IR Scale: 1/8" = 1'-0"  
Date: 09/21/2020 Rev: 12/5/23 AM

Proj. No.: 142  
Lot: 3277  
Block: 0142  
Sect:

SERENITY 65' (IM)  
627 SERENITY WALK PARKWAY  
FUYQUAY VARINA, NC

SOUTH  
**B329-B**  
**ELV-1**  
BUCKHORN  
RALEIGH

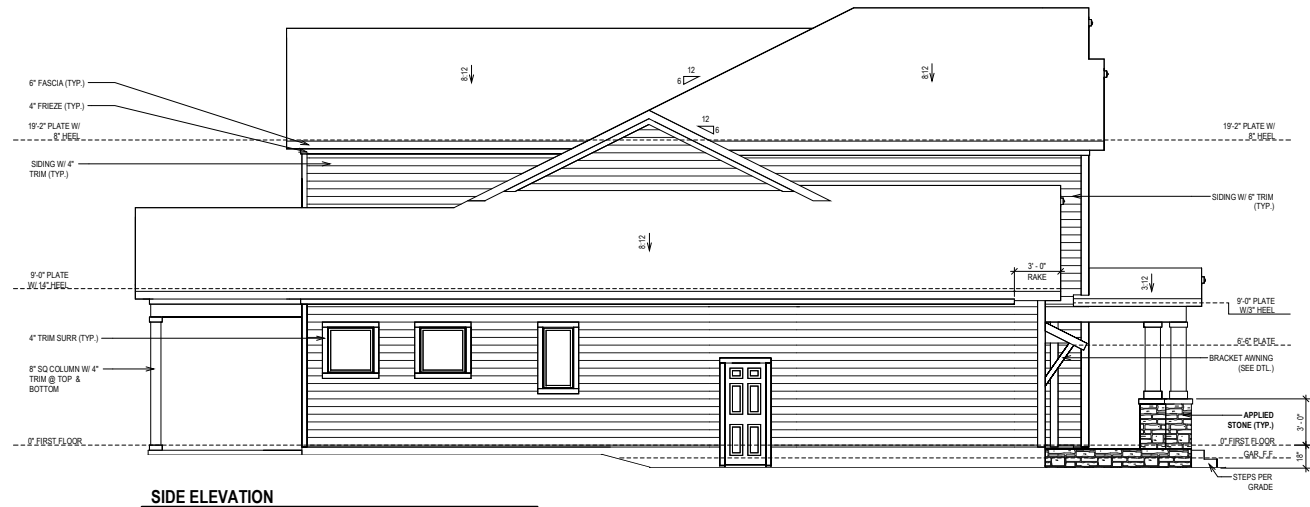

SIDE ELEVATION

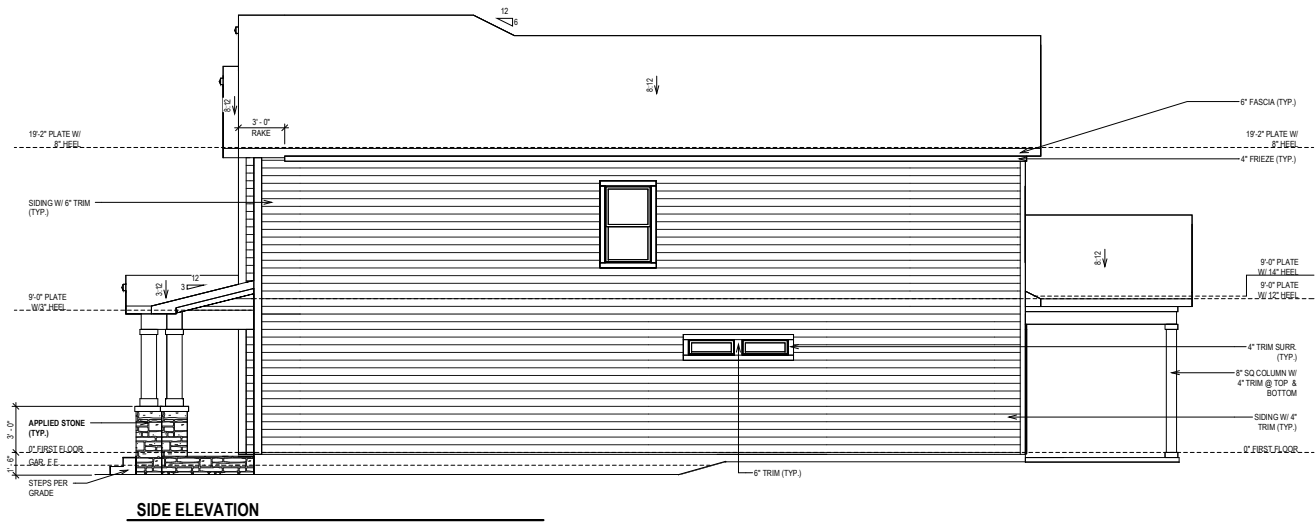

SIDE ELEVATION

© Weekley Homes, L.P. 2020  
 The measurements, dimensions, and other specifications shown on this document are guidelines for construction use only. This document may not be relied on as a representation of what the completed structure will look like.

**David Weekley Homes**  
 C/N/INUIR Scale: 1/8"=1'-0"  
 Date: 09/21/2020 Rev: 12/5/23 AM

142  
 Proj. No.: 3277  
 Lot: 0142  
 Block:  
 Sect:  
**SERENITY 65' (IM)**  
**627 SERENITY WALK PARKWAY**  
**FUQUAY VARINA, NC**

**SOUTH**  
**B329-B**  
**ELV-2**  
**BUCKHORN**  
**RALEIGH**



**SHEET INDEX:**

S-0	COVER SHEET
S-0.1	GENERAL STRUCTURAL NOTES
S-1	MONOLITHIC SLAB FOUNDATION PLAN
S-2	SECOND FLOOR FRAMING PLAN
S-3	ROOF FRAMING PLAN
SD-1	BRACED WALL DETAILS
SD-2	HOLD DOWN DETAILS
SD-3	BRACED WALL NOTES & DETAILS
SD-4	PORTAL FRAME DETAILS
SD-5	MISCELLANEOUS FRAMING DETAILS
SD-6	MISCELLANEOUS FRAMING DETAILS
SD-7	MONOLITHIC SLAB FOUNDATION DETAILS
SD-8	NOT USED
SD-9	NOT USED
SD-10	NOT USED
SD-11	NOT USED
SD-12	ADVANCED FRAMING DETAILS & NOTES



**KSE**  
**ENGINEERING**

1900 AM DRIVE, SUITE 201, QUAKERTOWN, PA 18951  
www.kse-eng.com (215) 804-4449

**B329 BUCKHORN**  
SERENITY, LOT #142

RALEIGH, NORTH CAROLINA

THESE DRAWINGS ARE TO BE USED IN CONJUNCTION WITH AND COORDINATED WITH THE ARCHITECTURAL, CIVIL, MECHANICAL, ELECTRICAL, AND PLUMBING DRAWINGS. THIS COORDINATION IS NOT THE RESPONSIBILITY OF THE STRUCTURAL ENGINEER OF RECORD (SER). SHOULD ANY DISCREPANCIES BECOME APPARENT, THE CONTRACTOR SHALL NOTIFY KSE ENGINEERING, P.C. BEFORE CONSTRUCTION BEGINS. IT IS THE INTENT OF THE ENGINEER LISTED ON THESE DOCUMENTS THAT THESE DOCUMENTS BE ACCURATE, PROVIDING LICENSED PROFESSIONALS CLEAR INFORMATION. EVERY ATTEMPT HAS BEEN MADE TO PREVENT ERROR. THE BUILDER AND ALL SUBCONTRACTORS ARE REQUIRED TO REVIEW ALL OF THE INFORMATION CONTAINED IN THESE DOCUMENTS PRIOR TO THE COMMENCEMENT OF ANY WORK. THE ENGINEER IS NOT RESPONSIBLE FOR ANY PLAN ERRORS, OMISSIONS, OR MISINTERPRETATIONS UNDETECTED AND NOT REPORTED TO THE ENGINEER PRIOR TO CONSTRUCTION. ALL CONSTRUCTION MUST BE IN ACCORDANCE TO THE INFORMATION FOUND IN THESE DOCUMENTS.

**DESIGN SPECIFICATIONS:**

DESIGN BUILDING CODE (REFERRED TO HEREIN AS "THE BUILDING CODE"):  
 • 2018 NORTH CAROLINA RESIDENTIAL CODE. WALL BRACING PER INTERNATIONAL RESIDENTIAL CODE 2015 EDITION.

DESIGN LIVE LOADS:  
 • ROOF = 20 PSF (LOAD DURATION FACTOR=1.25)  
 • UNINHABITABLE ATTICS WITH LIMITED STORAGE = 20 PSF (WHERE SPECIFIED ON PLANS)  
 • HABITABLE ATTICS AND ATTICS SERVED WITH FIXED STAIRS = 30 PSF  
 • FLOOR = 40 PSF  
 • FLOOR (SLEEPING AREAS) = 30 PSF  
 • DECK/BALCONY = 40 PSF  
 • STAIRS = 40 PSF

DESIGN DEAD LOADS:  
 • ROOF TRUSS = 17 PSF (TC=7, BC=10)  
 • FLOOR TRUSS = 15 PSF (TC=10, BC=5)  
 • FLOOR JOIST = 10 PSF  
 • STANDARD BRICK = 40 PSF  
 • QUEEN ANNE BRICK = 25 PSF

\*NOTE: STRUCTURAL FRAMING HAS NOT BEEN DESIGNED FOR TILE, GRANITE, MARBLE OR OTHER MATERIALS HEAVIER THAN THE ABOVE LOADING UNLESS SPECIFICALLY NOTED ON PLANS.\*

DESIGN WIND LOADS:  
 • ULTIMATE WIND SPEED = 115 MPH  
 • EXPOSURE CATEGORY = B

ASSUMED SOIL BEARING CAPACITY = 2000 PSF

ASSUMED LATERAL SOIL PRESSURE = 45 PCF

FROST DEPTH = 12" MINIMUM

SEISMIC DESIGN CATEGORY = B

ENGINEERED LUMBER SHALL HAVE THE FOLLOWING MINIMUM DESIGN VALUES:

- TJI 210 SERIES (SERIES AND SPACING PER PLANS)
- LSL: E=1,550,000 PSI, F<sub>b</sub>=2,325 PSI, F<sub>v</sub>=310 PSI, F<sub>c</sub>=900 PSI
- LVL: E=2,000,000 PSI, F<sub>b</sub>=2,600 PSI, F<sub>v</sub>=285 PSI, F<sub>c</sub>=750 PSI
- PSL: E=2,100,000 PSI, F<sub>b</sub>=2,900 PSI, F<sub>v</sub>=290 PSI, F<sub>c</sub>=625 PSI



1900 AM DRIVE, SUITE 201, QUAKERTOWN, PA 18951  
www.kse-eng.com (215) 804-4449

David Weekley Homes  
Raleigh, NC

Cover Sheet  
Serenity, Lot #142  
B329 Buckhorn Model  
Serenity  
Raleigh, North Carolina

Project #: 047-20009  
 Designed By: JPS  
 Checked By:  
 Issue Date: 3/20/24  
 Re-Issue:  
 Scale: 1/8"=1'-0" @ 11x17  
 1/4"=1'-0" @ 22,34



S-0

**GENERAL STRUCTURAL NOTES:**

- THE DESIGN PROFESSIONAL WHOSE SEAL APPEARS ON THESE DRAWINGS IS THE DESIGNER OF RECORD (DOR) FOR THIS PROJECT. THE SER BEARS THE RESPONSIBILITY OF THE PRIMARY STRUCTURAL ELEMENTS AND THE PERFORMANCE OF THIS STRUCTURE. NO OTHER PARTY MAY REVISE, ALTER, OR DELETE ANY STRUCTURAL ASPECTS OF THESE CONSTRUCTION DOCUMENTS WITHOUT THE CONSENT OF KSE ENGINEERING, P.C. OR THE SER. FOR THE PURPOSES OF THESE CONSTRUCTION DOCUMENTS, THE SER AND KSE ENGINEERING SHALL BE CONSIDERED THE SAME ENTITY.
- THIS STRUCTURE IS ONLY STABLE IN ITS COMPLETED FORM. THE CONTRACTOR SHALL PROVIDE ALL REQUIRED TEMPORARY BRACING DURING CONSTRUCTION TO STABILIZE THE STRUCTURE.
- THE SER IS NOT RESPONSIBLE FOR CONSTRUCTION SEQUENCES, METHODS, OR TECHNIQUES IN CONNECTION WITH THE CONSTRUCTION OF THIS STRUCTURE. THE SER WILL NOT BE HELD RESPONSIBLE FOR THE CONTRACTOR'S FAILURE TO CONFORM TO THE CONTRACT DOCUMENTS, SHOULD ANY NON-COMPLIANCE OCCUR.
- THE SER DOES NOT CERTIFY DIMENSIONAL ACCURACY OR ARCHITECTURAL LAYOUT INCLUDING ROOF GEOMETRY. THE SER ASSUMES NO LIABILITY FOR CHANGES MADE TO THESE PLANS BY OTHERS, OR FOR CONSTRUCTION METHODS, OR FOR ANY DEVIATION FROM THE PLANS. THE SER SHALL BE NOTIFIED PRIOR TO CONSTRUCTION IF ANY DISCREPANCIES ARE NOTED ON THE PLANS.
- ANY STRUCTURAL ELEMENTS OR DETAILS NOT FULLY DEVELOPED ON THE CONSTRUCTION DRAWINGS SHALL BE COMPLETED UNDER THE DIRECTION OF A LICENSED PROFESSIONAL ENGINEER. THESE SHOP DRAWINGS SHALL BE REVIEWED FOR ACTUAL FIELD CONDITIONS BEFORE ANY CONSTRUCTION BEGINS. THE SHOP DRAWINGS WILL BE REVIEWED FOR OVERALL COMPLIANCE AS IT RELATES TO THE STRUCTURAL DESIGN OF THIS PROJECT. VERIFICATION OF THE SHOP DRAWINGS SHALL BE THE RESPONSIBILITY OF THE CONTRACTOR. THE SER HAS NO RESPONSIBILITY OF THE SER OR KSE ENGINEERING, P.C. VERIFICATION OF ASSUMED FIELD CONDITIONS IS NOT THE RESPONSIBILITY OF THE SER. THE CONTRACTOR SHALL VERIFY THE FIELD CONDITIONS FOR ACCURACY AND REPORT ANY DISCREPANCIES TO KSE ENGINEERING, P.C. BEFORE CONSTRUCTION BEGINS.
- THE SER IS NOT RESPONSIBLE FOR ANY SECONDARY STRUCTURAL ELEMENTS OR NON-STRUCTURAL ELEMENTS, EXCEPT FOR THE ELEMENTS SPECIFICALLY NOTED ON THE STRUCTURAL DRAWINGS.
- THIS STRUCTURE AND ALL CONSTRUCTION SHALL CONFORM TO ALL APPLICABLE SECTIONS OF THE BUILDING CODE AND ANY LOCAL CODES OR RESTRICTIONS.
- FOR ALL DIMENSIONS, WRITTEN DIMENSIONS TAKE PRECEDENCE OVER SCALED DIMENSIONS. ALL DIMENSIONS ARE TO FACE OF STUD OR TO FACE OF FRAMING UNLESS OTHERWISE NOTED.
- WATERPROOFING AND FLASHING BY OTHERS.

**FOUNDATIONS:**

- FOUNDATIONS SHALL BE CONSTRUCTED IN ACCORDANCE WITH CHAPTER 4 OF THE BUILDING CODE.
- CONTRACTOR IS SOLELY RESPONSIBLE FOR VERIFYING THE SUITABILITY OF THE SITE SOIL CONDITIONS AT THE TIME OF CONSTRUCTION. THE BUILDER SHALL FURNISH ANY AND ALL REPORTS RECEIVED FROM THE GEOTECHNICAL ENGINEER ON THE STUDY OF THE PROPOSED SITE TO THE DESIGNER, STRUCTURAL ENGINEER, AND GENERAL CONTRACTOR.
- MAXIMUM DEPTH OF UNBALANCED FILL AGAINST MASONRY WALLS TO BE AS SPECIFIED IN THE BUILDING CODE.
- THE SER HAS NOT PERFORMED A SUBSURFACE INVESTIGATION. VERIFICATION OF THE ASSUMED VALUE IS THE RESPONSIBILITY OF THE OWNER OR THE CONTRACTOR. SHOULD ANY ADVERSE SOIL CONDITION BE ENCOUNTERED, THE SER MUST BE CONTACTED BEFORE PROCEEDING.
- THE BOTTOM OF ALL FOOTINGS SHALL EXTEND BELOW THE FROST LINE FOR THE REGION IN WHICH THE STRUCTURE IS TO BE CONSTRUCTED, BUT NOT LESS THAN A MINIMUM OF 12" BELOW GRADE. ALL FOOTINGS TO HAVE A MINIMUM PROJECTION OF 2" ON EACH SIDE OF FOUNDATION WALLS. MAXIMUM FOOTING PROJECTION SHALL NOT EXCEED THE THICKNESS OF THE FOOTING.
- WOOD SILL PLATES SHALL BE ANCHORED TO THE FOUNDATION WITH ½" ANCHOR BOLTS WITH MINIMUM 7" EMBEDMENT, SPACED A MAXIMUM OF 6'-0" O.C. INSTALL MINIMUM 2 ANCHOR BOLTS PER SECTION, 12" HIGHER FROM CORNERS. ½" DIAMETER x 8' LONG SIMPSON TITEN HD OR USP SCREW-BOLT+4 SCREWS MAY BE SUBSTITUTED ON A 1 FOR 1 BASIS FOR CONCRETE FOUNDATIONS ONLY.
- ANY FILL SHALL BE PLACED UNDER THE DIRECTION OR RECOMMENDATION OF A LICENSED PROFESSIONAL ENGINEER. THE RESULTING SOIL SHALL BE COMPACTED TO A MINIMUM OF 95% MAXIMUM DRY DENSITY.
- EXCAVATIONS OF FOOTINGS SHALL BE LINED TEMPORARILY WITH A 6 MIL POLYETHYLENE MEMBRANE. IF PLACEMENT OF CONCRETE DOES NOT OCCUR WITHIN 24 HOURS OF EXCAVATION.
- NO CONCRETE SHALL BE PLACED AGAINST ANY SUBGRADE CONTAINING WATER, ICE, FROST, OR LOOSE MATERIAL.
- PROVIDE FOUNDATION WATERPROOFING AND DRAIN WITH POSITIVE SLOPE TO OUTLET AS REQUIRED BY SITE CONDITIONS (SEE ARCHITECTURAL PLANS AND DETAILS).
- NONE OF THE FOUNDATION DESIGN DETAILS IN THESE DOCUMENTS ARE SUITABLE FOR INSTALLATION IN SHRINK/SWELL CONDITIONS. REFER TO GEOTECHNICAL ENGINEER FOR APPROPRIATE DESIGN.
- LOTS SHALL BE GRADED TO DRAIN SURFACE WATER AWAY FROM FOUNDATION WALLS. THE GRADE SHALL FALL A MINIMUM OF 6 INCHES WITHIN THE FIRST FEET.
- CRAWL SPACE TO BE GRADED LEVEL AND CLEAR OF ALL DEBRIS.
- PROVIDE MINIMUM 6 MIL APPROVED VAPOR BARRIER. ALL JOINTS TO BE LAPPED MINIMUM 12" AND SEALED.

**CONCRETE & REINFORCING**

- CONCRETE DESIGN BASED ON ACI 318 AND ACI 318.1 OR ACI 332. CONCRETE SHALL HAVE A NORMAL WEIGHT AGGREGATE AND A MINIMUM COMPRESSIVE STRENGTH (f'c) = 3,000 PSI MINIMUM AT 28 DAYS PER CODE (VARIES w/ WEATHER), UNLESS OTHERWISE NOTED ON THE PLAN.
- CONCRETE SHALL BE PROPORTIONED, MIXED, AND PLACED IN ACCORDANCE WITH THE LATEST EDITIONS OF ACI 318 "BUILDING CODE REQUIREMENTS FOR REINFORCED CONCRETE" AND ACI 309 "CONCRETE SPECIFICATIONS FOR STRUCTURAL CONCRETE FOR BUILDINGS".
- AIR ENTRAINMENT CONCRETE MUST BE USED FOR ALL STRUCTURAL ELEMENTS EXPOSED TO FREEZE/THAW CYCLES AND DEICING CHEMICALS. AIR ENTRAINMENT AMOUNTS (IN PERCENT) SHALL BE WITHIN -1% TO +2% OF 5% FOR FOOTINGS AND EXTERIOR SLABS.
- NO ADMIXTURES SHALL BE ADDED TO ANY STRUCTURAL CONCRETE WITHOUT WRITTEN PERMISSION OF THE SER. WATER ADDED TO CONCRETE ON SITE SHALL NOT EXCEED THAT ALLOWED BY THE MIX DESIGN.
- CONCRETE SLABS-ON-GRADE SHALL BE CONSTRUCTED IN ACCORDANCE WITH ACI 302.1R "GUIDE FOR CONCRETE SLAB AND SLAB CONSTRUCTION".
- CONTROL OR SAW CUT JOINTS (CUT OR TOOLED) SHALL BE SPACED IN INTERIOR SLABS-ON-GRADE AT A MAXIMUM OF 15'-0" O.C. AND IN EXTERIOR SLABS-ON-GRADE AT A MAXIMUM OF 10'-0" UNLESS OTHERWISE NOTED. CARE SHALL BE TAKEN TO AVOID RE-ENTRANCE CORNERS.
- CONTROL OR SAW CUT JOINTS SHALL BE PRODUCED USING CONVENTIONAL CUT OR TOOLED PROCESSES WITHIN 4 TO 12 HOURS AFTER THE SLAB HAS BEEN FINISHED.
- REINFORCING STEEL MAY EXTEND THROUGH A SAW CUT JOINT.
- ALL WELDED WIRE FABRIC (W.W.F.) FOR CONCRETE SLABS-ON-GRADE SHALL BE PLACED AT MID-DEPTH OF SLAB. THE W.W.F. SHALL BE SECURELY SUPPORTED DURING THE CONCRETE POUR. FIBROUS CONCRETE REINFORCEMENT, OR POLYPROPYLENE FIBERS MAY BE USED IN LIEU OF W.W.F. APPLICATION OF POLYPROPYLENE FIBERS PER CUBIC YARD OF CONCRETE SHALL BE PER MANUFACTURER AND COMPLY WITH ASTM C1116. ANY LOCAL BUILDING CODE REQUIREMENTS AND SHALL MEET OR EXCEED CURRENT INDUSTRY STANDARD.
- POLYPROPYLENE REINFORCING TO BE 100% VIRGIN, CONTAINING NO REFINISHED OLEFIN MATERIALS AND SPECIFICALLY MANUFACTURED FOR USE AS CONCRETE REINFORCEMENT.
- STEEL REINFORCING BARS SHALL BE NEW BILLET STEEL CONFORMING TO ASTM A615, GRADE 60.
- DETAILING, FABRICATION, AND PLACEMENT OF REINFORCING STEEL SHALL BE IN ACCORDANCE WITH THE LATEST EDITION OF ACI 318 "MANUAL OF STANDARD PRACTICE FOR DETAILING CONCRETE STRUCTURES".
- HORIZONTAL FOOTING AND WALL REINFORCEMENT SHALL BE CONTINUOUS AND SHALL HAVE 90° BENDS, OR CORNER BARS WITH THE SAME SIZE/SPACING AS THE HORIZONTAL REINFORCEMENT.
- PROVIDE REINFORCEMENT LAP AS NOTED BELOW, UNLESS NOTED OTHERWISE:  
#4 BARS - 30" LENGTH  
#5 BARS - 38" LENGTH  
#6 BARS - 45" LENGTH
- WHERE REINFORCING DOWELS ARE REQUIRED, THEY SHALL BE EQUIVALENT IN SIZE AND SPACING TO THE VERTICAL REINFORCEMENT. THE DOWEL SHALL EXTEND 50 BAR DIAMETERS VERTICALLY AND 20 BAR DIAMETERS INTO THE FOOTING. SEE KSE FOUNDATION DETAILS.
- WHERE FOOTING BOTTOMS ARE TO BE STEPPED AT SLOPING GRADE CONDITIONS, PROVIDE CONTINUOUS REINFORCING WITH 2 BARS (TO MATCH FOOTING REINFORCING) AS REQUIRED.
- BAR SUPPORT ACCESSORIES SHALL BE PROVIDED IN ACCORDANCE WITH THE LATEST ACI MANUAL OF STANDARD PRACTICE FOR DETAILING REINFORCED CONCRETE STRUCTURES, EXCEPT THAT REINFORCING SHALL BE CHARGED ON THE BOTTOM AND/OR THE SIDES ON BOLSTERS SPACED NOT MORE THAN 4 FEET ON CENTER. NO ROCKS, CMU, CLAY TILE, OR BRICK SHALL BE USED TO SUPPORT REINFORCING.
- FOR GRADE SUPPORTED SLABS, SLAB REINFORCING SHALL BE HELD IN PLACE BY BAR SUPPORTS AND ACCESSORIES AS DESCRIBED IN THE CRSI MANUAL OF STANDARD PRACTICE. BAR SUPPORTS SHALL BE SPACED A MAXIMUM OF 4'-0" O.C. BOTH WAYS IN STRAIGHT LINES ON THE MESH GRID.

**MASONRY**

- ALL MASONRY SHALL CONFORM TO ASTM C-90, F<sub>m</sub>=1500 PSI. ALL BRICK SHALL CONFORM TO ASTM C-216, F<sub>m</sub>=1500 PSI. ALL MORTAR SHALL BE TYPE "S" (M' BELOW GRADE) AND CONFORM TO ASTM C-270. COURSE GROUT SHALL CONFORM TO ASTM C-476 WITH A MAXIMUM AGGREGATE SIZE OF ¾" AND A MINIMUM COMPRESSIVE STRENGTH OF 2,000 PSI.
- ALL MASONRY WORK SHALL BE IN ACCORDANCE WITH "BUILDING CODE REQUIREMENTS FOR MASONRY STRUCTURES" ACI 530/ASCE 5/TMS 402 AND "SPECIFICATIONS FOR MASONRY STRUCTURES" ACI 530.1/ASCE 6/TMS 602.
- THE UNSUPPORTED HEIGHT OF SOLID MASONRY PIERS SHALL NOT EXCEED TEN TIMES THEIR LEAST DIMENSION. UNFILLED HOLLOW PIERS MAY BE USED IF THE UNSUPPORTED HEIGHT IS NOT MORE THAN FOUR TIMES THEIR LEAST DIMENSION.
- EACH COURSE SPACE SHALL BE IN THE MIDDLE THIRD OF ITS RESPECTIVE FOOTING AND EACH COURSE SHALL BE IN THE MIDDLE THIRD OF THE PIERS. PLASTERS TO BE BONDED TO PERIMETER FOUNDATION WALL.
- TOP COURSE OF MASONRY SHALL BE GROUTED SOLID.
- HORIZONTAL WALL JOINT REINFORCEMENT SHALL BE STANDARD 9 GAGE GALVANIZED LADDER OR TRUSS TYPE SPACED AT 16" O.C., UNLESS SHOWN OTHERWISE ON THE DRAWINGS.
- SPUN WIRE REINFORCEMENT SHALL BE LAPPED AT LEAST 6" AND CONTAIN AT LEAST ONE CROSS WIRE OF EACH PIECE OF REINFORCEMENT WITHIN THE 6". LAP WITH STANDARD 'I' AND 'L' SHAPED PIECES AT INTERSECTIONS AND CORNERS.

**WOOD FRAMING:**

- SOLID SAWN WOOD FRAMING MEMBERS SHALL CONFORM TO THE SPECIFICATIONS LISTED IN THE LATEST EDITION OF THE "NATIONAL DESIGN SPECIFICATION FOR WOOD CONSTRUCTION" (NDS). UNLESS OTHERWISE NOTED, ALL WOOD FRAMING MEMBERS ARE DESIGNED TO BE: SPRUCE-PINE-FIR (SPF) WITH THE FOLLOWING MINIMUM DESIGN PROPERTIES FOR REINFORCED CONCRETE AND WOOD FRAMING: E=1,400,000 PSI, F<sub>v</sub>=875 PSI, F<sub>w</sub>=135 PSI  
1.1. FRAMING: SPF #2  
1.2. PLATES: SPF #2  
1.3. STUDS: SPF STUD GRADE.
- ALL LUMBER EXPOSED TO WEATHER OR IN CONTACT WITH CONCRETE SHALL BE PRESERVATIVE TREATED SOUTHERN YELLOW PINE #2 OR BETTER.
- ANCHOR SILL PLATES IN ACCORDANCE w/ GENERAL STRUCTURAL NOTES.
- ALL BEAMS SPECIFIED ARE MINIMUM SIZES ONLY. LARGER MEMBERS MAY BE SUBSTITUTED AS NEEDED FOR EASE OF CONSTRUCTION.
- NAILS SHALL BE COMMON WIRE NAILS UNLESS OTHERWISE NOTED.
- BOLT HOLES AND LEAD HOLES FOR LAG SCREWS SHALL BE IN ACCORDANCE WITH NDS SPECIFICATIONS.
- INDIVIDUAL STUDS FORMING A COLUMN SHALL BE ATTACHED WITH (2) ROWS 10x NAILS @ 6" O.C. STAGGERED. THE STUD COLUMN SHALL BE FULLY BLOCKED AT ALL FLOOR LEVELS TO ENSURE PROPER LOAD TRANSFER. WALL SHEATHING SHALL BE NAILED TO EDGE OF EACH STUD. FACE NAIL, ALL MULTI-PLY BEAMS AND HEADERS WITH (2) ROWS 16d COMMON NAILS @ 12" O.C. STAGGERED. (6" FROM MANUFACTURER'S SPECIFICATIONS FOR ENGINEERED LUMBER. APPLY NAILING FROM BOTH FACES FOR 3) OR MORE PLYS.
- FASTEN 4-PLY BEAMS WITH (1) ½" DIAMETER THROUGH BOLT w/ NUT WASHERS AT 12" O.C. STAGGERED TOP AND BOTTOM, ½" MINIMUM EDGE DISTANCE. (UNLESS OTHERWISE NOTED).
- ALL BEAMS AND HEADERS SHALL HAVE (1)2x JACK STUD & (1)2x KING STUD UNLESS OTHERWISE NOTED. THE NUMBER OF STUDS INDICATED ON PLANS ARE THE TOTAL NUMBER OF JACK STUDS REQUIRED, UNLESS OTHERWISE NOTED.
- PROVIDE KING STUDS AT EACH END OF HEADERS AS NOTED BELOW.  
24" O.C. STUD SPACING:  
(1) STUD UP TO 3' OPENING  
(2) STUDS UP TO 4' OPENING  
(3) STUDS UP TO 8' OPENING  
(4) STUDS UP TO 12' OPENING  
(5) STUDS UP TO 16' OPENING
- ALL BEAMS TO BE CONTINUOUSLY SUPPORTED LATERALLY AND SHALL BEAR FULL WIDTH ON THE SUPPORTING WALLS OR COLUMNS INDICATED WITH A MINIMUM OF TWO STUDS, UNLESS OTHERWISE NOTED. ALL BEAM SPLICES SHALL OCCUR OVER SUPPORTS.
- SOLID BLOCKING TO BE PROVIDED AT ALL POINT LOADS THROUGH FLOOR LEVELS TO THE FOUNDATION OR TO OTHER STRUCTURAL COMPONENTS.
- ALL LUMBER SPECIFIED ON DRAWINGS IS INTENDED FOR DRY USE ONLY (MOISTURE CONTENT < 19% UNLESS OTHERWISE NOTED).
- ALL WATERPROOFING AND FIRE SAFETY SYSTEMS ARE THE RESPONSIBILITY OF THE CONTRACTOR AND ARE TO BE DESIGNED AND DETAILED BY OTHERS.
- ANY WOOD FRAME INTERIOR BEARING WALL STUDS THAT HAVE HOLES IN THE CENTER OF THE STUD UP TO 1" DIAMETER SHALL HAVE STUD PROTECTION SHIELDS. ALL HOLES OVER 1" IN DIAMETER FOR PLUMBING LINES, ETC. SHALL BE REPAIRED WITH SIMPSON HSS2 OR USP ST1 STUD SHOES, TYPICAL, UNLESS OTHERWISE NOTED.
- BEARING WALLS SHALL BE SHEATHED ON NOT LESS THAN ONE SIDE WITH OSB OR GYPSUM BOARD. BRIDGING SHALL BE INSTALLED NOT GREATER THAN 4 FEET APART MEASURED VERTICALLY FROM EITHER END OF THE STUD IN LIEU OF SHEATHING.

**EXTERIOR WOOD FRAMED DECKS:**

- DECKS ARE TO BE FRAMED IN ACCORDANCE WITH APPLICABLE BUILDING CODES AND AS REFERENCED ON THE STRUCTURAL PLANS, EITHER THROUGH CODE REFERENCES OR CONSTRUCTION DETAILS.
- PRESERVATIVE TREATED WOOD FRAMING TO BE SOUTHERN YELLOW PINE #2 OR BETTER.
- GUARD RAILS AND LATERAL BRACING IS REQUIRED AT DECKS, DESIGN BY OTHERS.
- PROVIDE DECK LATERAL LOAD CONNECTIONS PER BUILDING CODE.

**RAFTER FRAMED ROOF CONSTRUCTION:**

- PROVIDE 2x4x4'-0" RAFTER TIES AT 50' O.C.
- RAFTERS SHALL BE SUPPORTED BY PURLINS AND PURLIN BRACES AS SHOWN ON THE PLAN. PURLIN BRACES SHALL NOT BEAR ON ANY CEILING JOIST, STRONGBACK OR HEADER UNLESS SPECIFICALLY SHOWN ON PLAN. RAFTERS MAY BE SPLICED AT PURLIN LOCATIONS.
- CEILING JOISTS SHALL HAVE LATERAL SUPPORT w/ 1x4 flat BRACING ON TOP EDGE OF JOIST AT LOOSE JOIST ENDS (WHERE JOISTS NOT FASTENED TO RAFTERS) OR FULL DEPTH BLOCKING. FASTEN END OF BRACING TO RAFTER OR CABLE END FRAMING.
- FASTEN RAFTER AND CEILING JOIST WITH (6) 12d NAILS UNLESS OTHERWISE NOTED.
- PROVIDE VERTICAL 2x6 STRONGBACKS AT CEILING JOISTS @ 8'-0" O.C. THE STRONGBACK ENDS TO CABLE STUDS OR RAFTERS WHERE POSSIBLE. PROVIDE BLOCKING BETWEEN TOP PLATES AND STRONGBACKS. PROVIDE 2x4 flat FASTENED TO EACH JOIST WITH (2) 12d NAILS. FASTEN STRONGBACK TO 2x4 FLAT WITH 12d NAILS @ 12" O.C. AND FASTENED TO EACH JOIST WITH (1) 12d TONNAIL.

**WOOD TRUSSES (FLOOR & ROOF):**

- THE WOOD TRUSS MANUFACTURER/FABRICATOR IS RESPONSIBLE FOR THE DESIGN OF THE WOOD TRUSSES. SUBMIT SEALED SHOP DRAWINGS AND SUPPORTING CALCULATIONS TO THE SER FOR REVIEW PRIOR TO FABRICATION. THE SER SHALL HAVE A MINIMUM OF (5) DAYS FOR REVIEW. THE REVIEW BY THE SER SHALL BE FOR OVERALL COMPLIANCE OF THE DESIGN DOCUMENTS. THE SER SHALL ASSUME NO RESPONSIBILITY FOR THE CORRECTNESS OF THE STRUCTURAL DESIGN FOR THE WOOD TRUSSES.
- THE WOOD TRUSSES SHALL BE DESIGNED FOR ALL REQUIRED LOADINGS AS SPECIFIED IN THE LOCAL BUILDING CODE, THE ASCE STANDARD "MINIMUM DESIGN LOADS FOR BUILDINGS AND OTHER STRUCTURES" (ASCE 7), AND THE LOADING REQUIREMENTS SHOWN ON THESE SPECIFICATIONS. THE TRUSS DRAWINGS SHALL BE COORDINATED WITH ALL OTHER CONSTRUCTION DOCUMENTS AND PROVISIONS PROVIDED FOR LOADS SHOWN ON THESE DRAWINGS INCLUDING BUT NOT LIMITED TO HVAC EQUIPMENT, PIPING, AND ARCHITECTURAL FIXTURES ATTACHED TO THE TRUSSES.
- THE TRUSSES SHALL BE DESIGNED, FABRICATED, AND ERECTED IN ACCORDANCE WITH THE LATEST EDITION OF THE ANSI/TPI 1: "NATIONAL DESIGN STANDARD FOR METAL PLATE CONNECTED WOOD TRUSS CONSTRUCTION".
- THE TRUSS MANUFACTURER SHALL PROVIDE ADEQUATE BRACING INFORMATION IN ACCORDANCE WITH "BUILDING COMPONENT SAFETY INFORMATION GUIDE TO GOOD PRACTICE FOR HANDLING, INSTALLING, RESTRAINING & BRACING OF METAL PLATE CONNECTED WOOD TRUSSES" (BCI). THIS BRACING, BOTH TEMPORARY AND PERMANENT, SHALL BE SHOWN ON THE SHOP DRAWINGS. ALSO, THE SHOP DRAWINGS SHALL SHOW THE REQUIRED ATTACHMENTS FOR THE TRUSSES.
- THE CONTRACTOR IS RESPONSIBLE FOR INSTALLING TEMPORARY BRACING AND SHORING FOR THE FLOOR AND ROOF TRUSSES AS REQUIRED DURING CONSTRUCTION. AT A MINIMUM, CONTRACTOR SHALL FOLLOW THE REQUIREMENTS OF THE LATEST BCI. JACK STUD, SHALL KEEP A COPY OF THE BCI SUMMARY SHEETS ON SITE.
- THE CONTRACTOR IS RESPONSIBLE FOR INSTALLING ALL PERMANENT TRUSS BRACING SHOWN IN THE STRUCTURAL DRAWINGS AND IN THE TRUSS DESIGNS. ALL CONTINUOUS LATERAL BRACING OF WEBS REQUIRES BRACES. REFER TO BCI SUMMARY SHEET B3 FOR TYPES OF DIAGONAL BRACES TO PROVIDE AT EACH CONTINUOUS LATERAL BRACE LINE. SUCH DIAGONAL BRACES SHALL NOT BE SPACED MORE THAN 20 FEET O.C. DIAGONAL BRACES SHALL BE FASTENED TO EACH TRUSS WEB WITH A MINIMUM OF TWO 10d FACE NAILS. WHERE CONTINUOUS LATERAL BRACING CANNOT BE INSTALLED, DUE TO A MINIMUM OF THREE ADJACENT TRUSSES NOT BEING IDENTICAL, THE CONTRACTOR SHALL COORDINATE WITH THE TRUSS SPECIALTY ENGINEER/MANUFACTURER TO DETERMINE WHAT TYPE OF ALTERNATE BRACE (I.E., T OR L BRACE, ETC.) IS REQUIRED.
- ANY CHORDS OR TRUSS WEBS SHOWN ON THESE DRAWINGS HAVE BEEN SHOWN AS A REFERENCE ONLY. THE FINAL DESIGN OF THE TRUSSES SHALL BE PER THE MANUFACTURER.
- TRUSS LAYOUT AND PLACEMENT BY MANUFACTURER TO CONCORD WITH STRUCTURAL SUPPORT LOCATIONS SHOWN ON THE SEALED STRUCTURAL DRAWINGS. TRUSS PROFILES TO BE SEALED BY THE TRUSS MANUFACTURER. TRUSS PLANS TO BE COORDINATED WITH THE SEALED STRUCTURAL DRAWINGS.
- THE CONTRACTOR IS RESPONSIBLE TO PROVIDE REQUIRED UPLIFT CONNECTORS FOR ALL TRUSSES.
- PROVIDE SIMPSON H254, USP RT7 OR EQUIVALENT AT EACH TRUSS TO TOP PLATE CONNECTION, UNLESS OTHERWISE NOTED.

**WOOD STRUCTURAL PANELS:**

- FABRICATION AND PLACEMENT OF STRUCTURAL WOOD SHEATHING SHALL BE IN ACCORDANCE WITH THE APA DESIGN/CONSTRUCTION GUIDE "RESIDENTIAL AND COMMERCIAL," AND ALL OTHER APPLICABLE APA STANDARDS.
- ALL STRUCTURALLY REQUIRED WOOD SHEATHING SHALL BEAR THE MARK OF THE APA.
- WOOD WALL SHEATHING SHALL COMPLY WITH THE REQUIREMENTS OF LOCAL BUILDING CODES FOR THE APPROPRIATE STATE AS INDICATED ON THESE DRAWINGS. REFER TO WALL BRACING NOTES IN PLAN SET FOR MORE INFORMATION. EXTERIOR WALLS TO BE FULLY SHEATHED USING ¾" OSB MINIMUM. AT BRACED WALL PANELS, PROVIDE BLOCKING AT ALL SHEET EDGES NOT FALLING ON STUDS OR PLATES.
- ROOF SHEATHING SHALL BE APA RATED SHEATHING EXPOSURE 1 OR 2. ROOF SHEATHING SHALL BE CONTINUOUS OVER TWO SUPPORTS MINIMUM AND ATTACHED TO ITS SUPPORTING ROOF FRAMING WITH 8d NAIL AT 6" O.C. AT PANEL EDGES AND AT 12" O.C. IN PANEL FIELD UNLESS OTHERWISE NOTED ON THE PLANS. SHEATHING SHALL BE APPLIED WITH THE LONG DIRECTION PERPENDICULAR TO FRAMING. SHEATHING SHALL HAVE A SPAN RATING CONSISTENT WITH THE FRAMING SPACING. PROVIDE SUITABLE EDGE SUPPORT BY USE OF PLYWOOD CLIPS OR LUMBER BLOCKING UNLESS OTHERWISE NOTED. PANEL END JOINTS SHALL OCCUR OVER FRAMING. ROOF SHEATHING TO BE ¾" OSB MINIMUM.
- WOOD FLOOR SHEATHING SHALL BE APA RATED SHEATHING EXPOSURE 1 OR 2. ATTACH SHEATHING TO ITS SUPPORTING FRAMING WITH (1) 10d NAIL AT 6" O.C. AT PANEL EDGES AND AT 12" O.C. IN PANEL FIELD UNLESS OTHERWISE NOTED ON THE PLANS. SHEATHING SHALL BE APPLIED PERPENDICULAR TO FRAMING. SHEATHING SHALL HAVE A SPAN RATING CONSISTENT WITH THE FRAMING SPACING. PROVIDE SUITABLE EDGE SUPPORT BY USE OF T&G PLYWOOD OR LUMBER BLOCKING UNLESS OTHERWISE NOTED. PANEL END JOINTS SHALL OCCUR OVER FRAMING.
- SHEATHING SHALL HAVE A ½" GAP AT PANEL ENDS AND EDGES AS RECOMMENDED IN ACCORDANCE WITH THE APA.

**STRUCTURAL FIBERBOARD PANELS:**

- STRUCTURAL FIBERBOARD SHEATHING SHALL ONLY BE USED WHERE SPECIFICALLY NOTED ON THE STRUCTURAL PLANS.
- FABRICATION AND PLACEMENT OF STRUCTURAL FIBERBOARD SHEATHING SHALL BE IN ACCORDANCE WITH THE APPLICABLE ALFA STANDARDS.
- STRUCTURAL FIBERBOARD SHEATHING SHALL COMPLY WITH THE REQUIREMENTS OF LOCAL BUILDING CODES FOR THE APPROPRIATE STATE AS INDICATED ON THESE DRAWINGS. REFER TO WALL BRACING NOTES IN PLAN SET FOR MORE INFORMATION.
- SHEATHING SHALL HAVE A ½" GAP AT PANEL ENDS AND EDGES AS RECOMMENDED IN ACCORDANCE WITH THE ALFA.

**STRUCTURAL STEEL:**

- STRUCTURAL STEEL SHALL BE FABRICATED AND ERECTED IN ACCORDANCE WITH THE AMERICAN INSTITUTE OF STEEL CONSTRUCTION "CODE OF STANDARD PRACTICE FOR STEEL BUILDINGS AND BRIDGES" AND OF THE MANUAL OF STEEL CONSTRUCTION "LOAD RESISTANCE FACTOR DESIGN" LATEST EDITIONS.
- ALL STEEL SHALL HAVE A MINIMUM YIELD STRESS (F<sub>y</sub>) OF 50 KSI UNLESS OTHERWISE NOTED.
- THE WELDING SHALL CONFORM TO THE LATEST EDITION OF THE AMERICAN WELDING SOCIETY'S STRUCTURAL WELDING CODE AISC D1.1. ELECTRODES FOR SHOP AND FIELDING WELDING SHALL BE CLASS E70XX. ALL WELDING SHALL BE PERFORMED BY A CERTIFIED WELDER PER THE ABOVE STANDARDS.
- ALL STEEL BEAMS TO BE SUPPORTED AT EACH END WITH A MINIMUM BEARING LENGTH OF 3½" AND FULL LENGTH WIDTH UNLESS OTHERWISE NOTED. BEAMS MUST BE ATTACHED AT EACH END WITH A MINIMUM OF FOUR 16d NAILS OR (2) ½" x 4" LAG SCREWS UNLESS OTHERWISE NOTED.
- INSTALL 2x WOOD PLATE ON TOP OF STEEL BEAMS, RIPPED TO MATCH BEAM WIDTH. FASTEN PLATE TO BEAM w/ H/2 x D-IN 52" Ø8 PINS AT 12" O.C. STAGGERED OR ½" DIAMETER BOLTS AT 24" O.C.

**METAL FASTENERS:**

- ALL METAL HARDWARE AND FASTENERS TO BE SIMPSON STRONG-TIE OR APPROVED EQUIVALENT.
- ALL HARDWARE AND FASTENERS IN CONTACT WITH PRESERVATIVE TREATED LUMBER SHALL BE HOT DIPPED GALVANIZED IN ACCORDANCE WITH ASTM A 153. G-185.
- MANY OF THE NEW PRESURE TREATED WOODS USE CHEMICALS THAT ARE CORROSIVE TO STEEL. IT IS THE CONTRACTOR'S RESPONSIBILITY TO VERIFY THE TYPE OF WOOD TREATMENT AND SELECT APPROPRIATE CONNECTORS THAT WILL RESIST THE APPLICABLE CORROSIVE CHEMICALS.

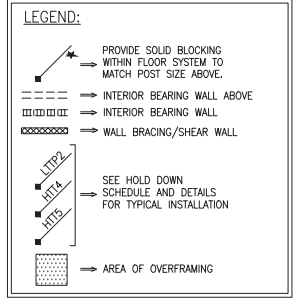

SPAN	LINTEL SIZE	END BEARING
UP TO 3'-0"	5" x 3½" x ¾"	4"
UP TO 6'-3"	5" x 3½" x ¾" L.L.V.	8"
UP TO 9'-6"	6" x 3½" x ¾" L.L.V.	12"

LINTELS ARE NOT DESIGNED TO BE BOLTED TO HEADERS UNLESS SPECIFIED ON UNIT PLANS.  
SPANS OVER 4'-0" SHALL BE SHORED UP UNTIL CURED.



1900 ANDRIVE, SUITE 201, QUAKERTOWN, PA 19081  
www.kse-eng.com  
David Weekley Homes  
Raleigh, NC

General Structural Notes  
Serenity, Lot #142  
B329 Buckhorn Model  
Serenity  
Raleigh, North Carolina

Project #: 047-2009  
Designed By: JFS  
Checked By:  
Issue Date: 3/20/24  
Re-Issue:

Scale: 1/8"=1'-0" @ 11x17  
1/4"=1'-0" @ 22x34



S-0.1

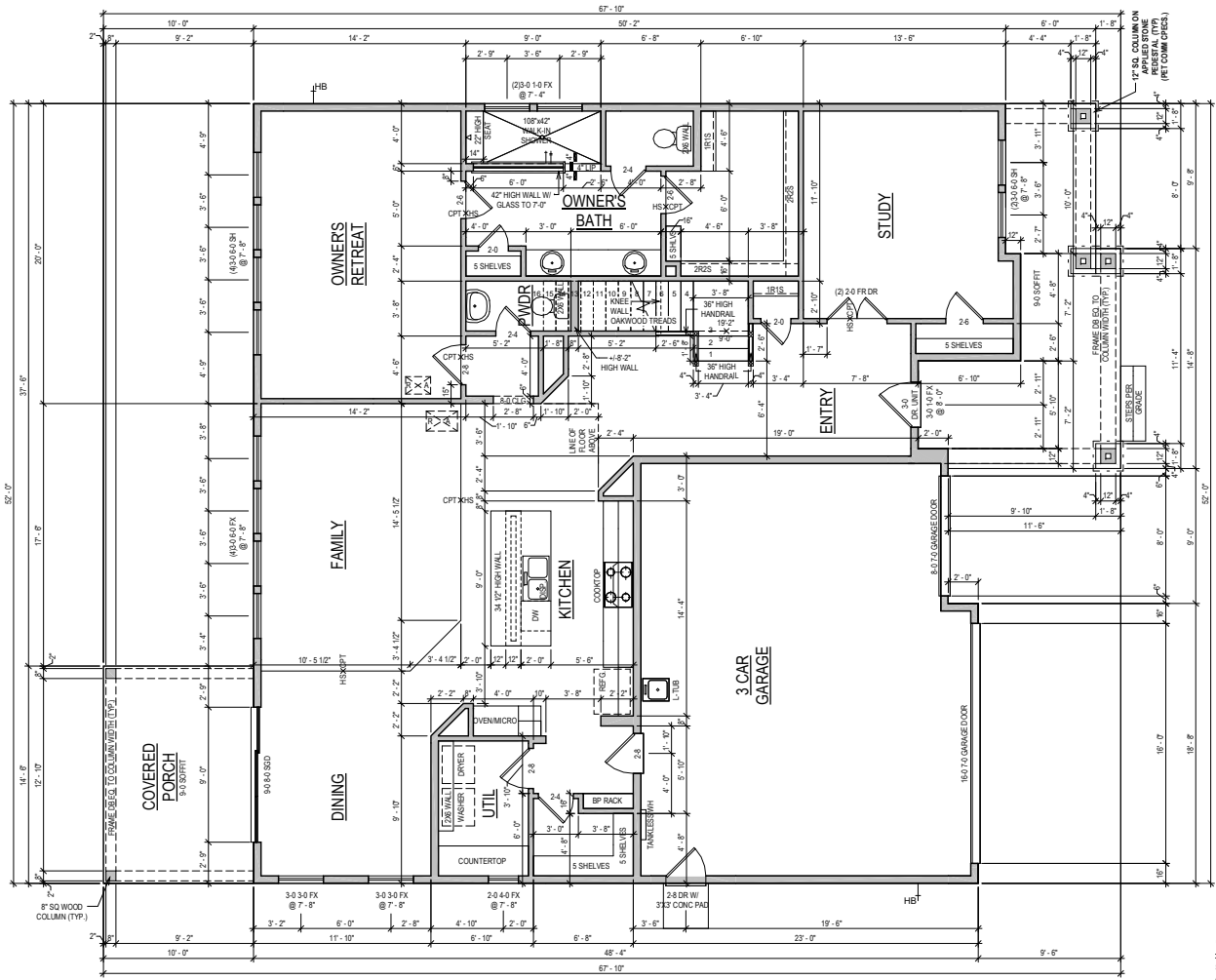

**FIRST FLOOR**

**GENERAL REQUIREMENTS**

**SLOPED SURFACE REQUIREMENTS**  
ALL PATIOS TO SLOPE 1/4" PER FOOT

GARAGE FLOOR TO BE SLOPED 1/8" PER FOOT TOWARDS VEHICLE ENTRY DOOR  
ROOF DECKS AND BALCONIES TO BE SLOPED 1/4" PER FOOT TOWARDS RELIEF POINTS

**RAILING REQUIREMENTS**  
FINISHED HANDRAIL REQUIRED AT STAIRS WITH 4 OR MORE RSERS

FINISHED HANDRAIL HEIGHT BETWEEN 34" AND 36" MEASURED VERTICALLY ABOVE TREAD NOSING

FINISHED GUARDRAILS REQUIRED AT DECKS, BALCONIES AND WALKWAYS THAT ARE 30" OR GREATER ABOVE GRADE AND BE AT A MINIMUM OF 36" IN HEIGHT

FINISHED GUARDRAIL AND HANDRAIL SPINDLES MUST BE SPACED SO A 4" SPHERE WILL NOT PASS THROUGH

**PLAN SQFT**

LIVING	
1ST FLOOR	1856 SF
2ND FLOOR	1126 SF
<b>TOTAL LIVING</b>	<b>3021 SF</b>
<b>SLAB</b>	
1ST FLOOR	1895 SF
COVERED PORCH	145 SF
FRONT PORCH	202 SF
GARAGE	613 SF
<b>TOTAL SLAB</b>	<b>2855 SF</b>
<b>FRAMING</b>	
1ST FLOOR	1856 SF
2ND FLOOR	1080 SF
COVERED PORCH	145 SF
FRONT PORCH	202 SF
GARAGE	613 SF
<b>TOTAL FRAMING</b>	<b>3935 SF</b>

- OPTION LIST**
- 505 B DINING ROOM
  - FREESTANDING UTILITY SINK @ GARAGE
  - BACKPACK RACK
  - STOVE
  - COUNTERTOP @ UTILITY
  - COVERED PORCH
  - COVERED DECK
  - OWNER'S BATH
  - DOOR @ OWNER'S CLOSET
  - HARD SURFACE TREADS
  - RAILING @ STAIRS
  - OWNER'S BATH
  - COUNTERTOP @ UTILITY

**NOTE: ALL 1ST FLR. CEILING HEIGHTS 9'-0" UNLESS NOTED OTHERWISE**

**ADVANCED FRAMING: 2X6 EXTERIOR PERIMETER WALLS & ALL INSULATED WALLS UNLESS NOTED OTHERWISE**

© Weekly Homes LP, 2020  
The measurements, dimensions, and other specifications shown on this document are guidelines for construction use only. This document may not be relied on as a representation of what the completed structure will look like.

**David Weekly Homes**  
C/N/NU/IR Scale: 1/8"=1'-0"  
Date: 09/21/2020 Rev: 12/5/23 AM

Proj. No.: 142  
Lot: 3277  
Block:  
Job No.: 0142  
Sect:

**SERENITY 65' (IM)**  
**627 SERENITY WALK PARKWAY**  
**FUQUAY VARINA, NC**

**SOUTH**  
**B329-B**  
**PLN-1**  
**BUCKHORN**  
**RALEIGH**

11 11

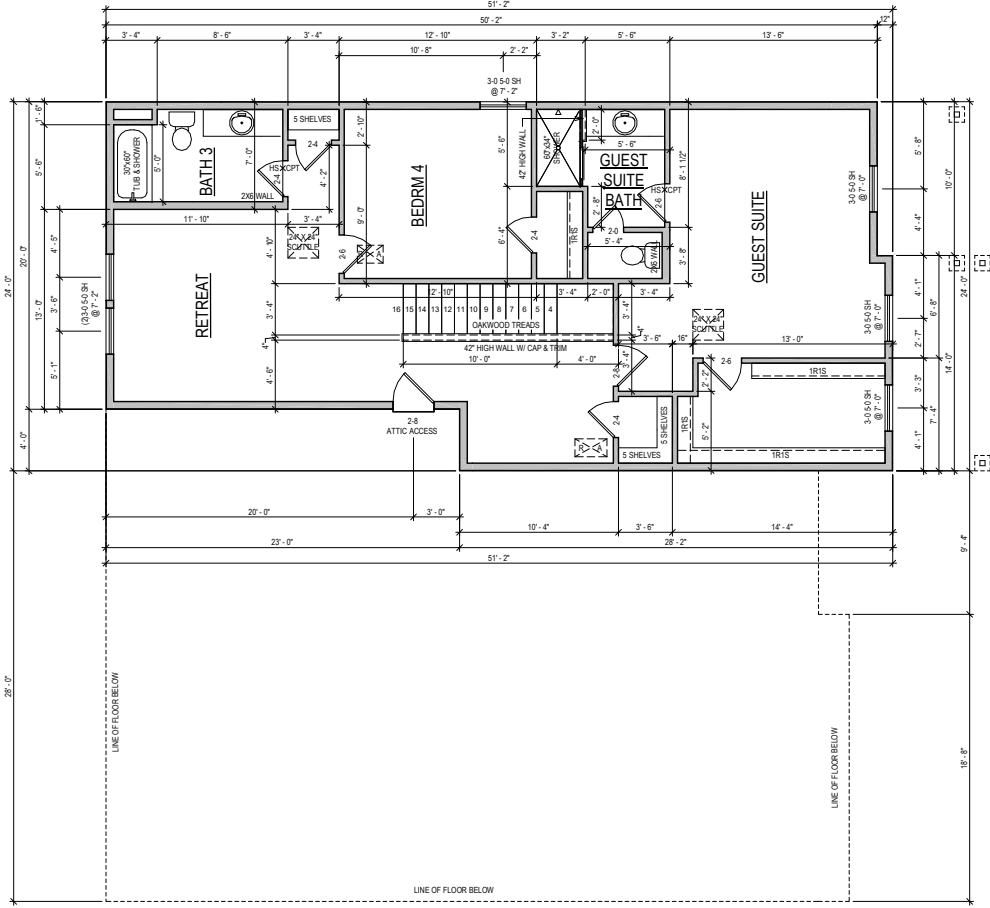

**SECOND FLOOR**

NOTE: ALL 2ND FLR. CEILING HEIGHTS  
9'-0" UNLESS NOTED OTHERWISE

ADVANCED FRAMING: 2X6 EXTERIOR  
PERIMETER WALLS & ALL INSULATED  
WALLS UNLESS NOTED OTHERWISE

**SERENITY 65' (IM)**  
**627 SERENITY WALK PARKWAY**  
**FUQUAY VARINA, NC**

**SOUTH**  
**B329-B**  
**PLN-2**  
**BUCKHORN**  
**RALEIGH**

Proj. No.: **142**  
Lot: **3277**  
Job No.: **0142**  
Block:  
Sect:

**David Weekley Homes**  
C/N/U/I/R Scale: 1/8"=1'-0"  
Date: 09/21/2020 Rev: 12/5/23 AM

© Weekley Homes, L.P. 2020  
The measurements, dimensions, and other specifications shown on this document are guidelines for construction use only. This document may not be relied on as a representation of what the completed structure will look like.

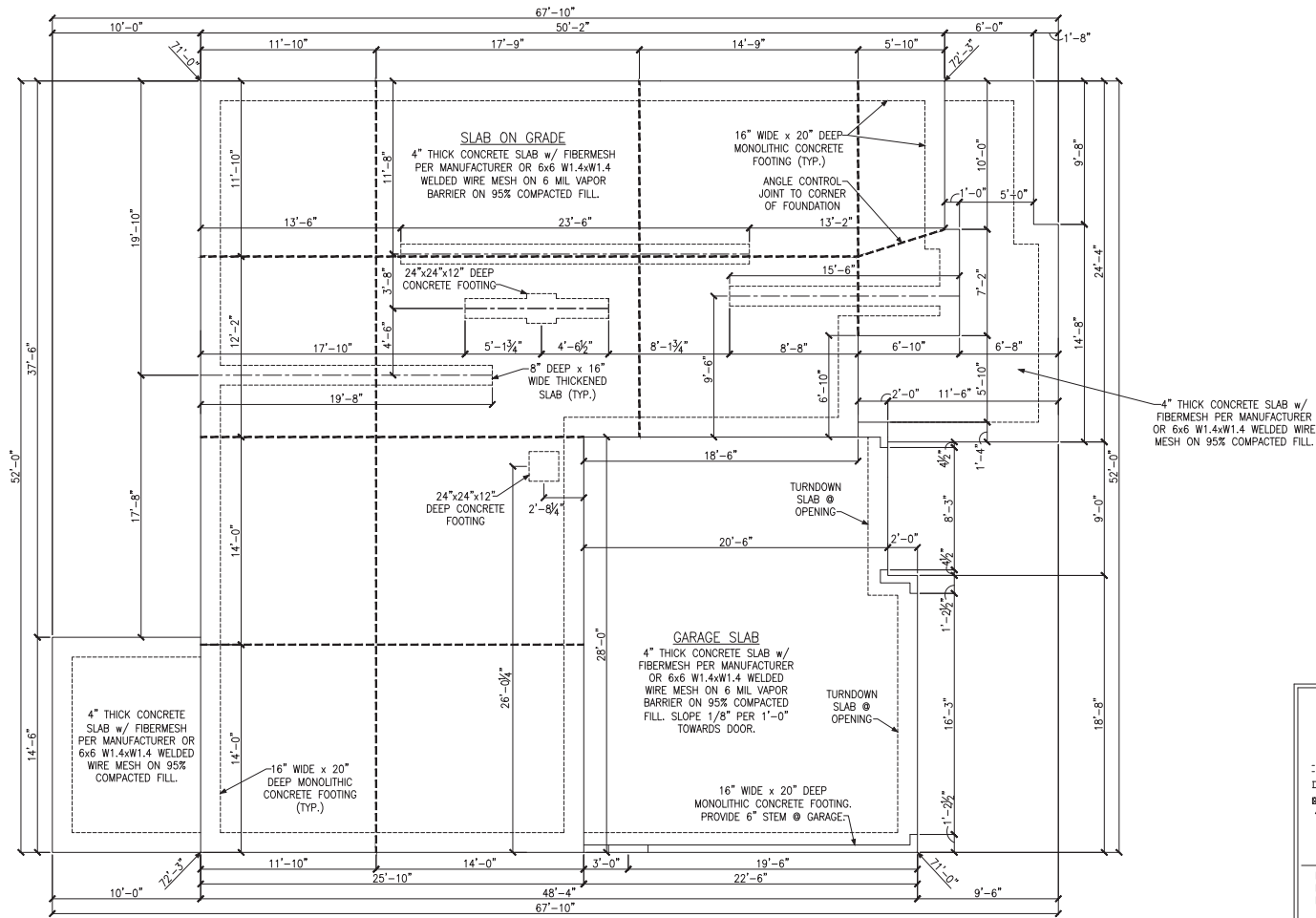

**LEGEND**

- PROVIDE SOLID BLOCKING WITHIN FLOOR SYSTEM TO MATCH POST SIZE ABOVE.
- BEARING WALL ABOVE
- INTERIOR BEARING WALL
- BRACED WALL PANEL (SEE KSE STRUCTURAL DETAILS SET FOR BRACED WALL PANEL SHEATHING FASTENING & BLOCKING DETAILS)
- 48\"/>

REFER TO KSE STRUCTURAL DETAILS SET FOR GENERAL STRUCTURAL NOTES, TYPICAL DETAILS AND ADVANCED FRAMING NOTES AND DETAILS

MONOLITHIC SLAB FOUNDATION PLAN







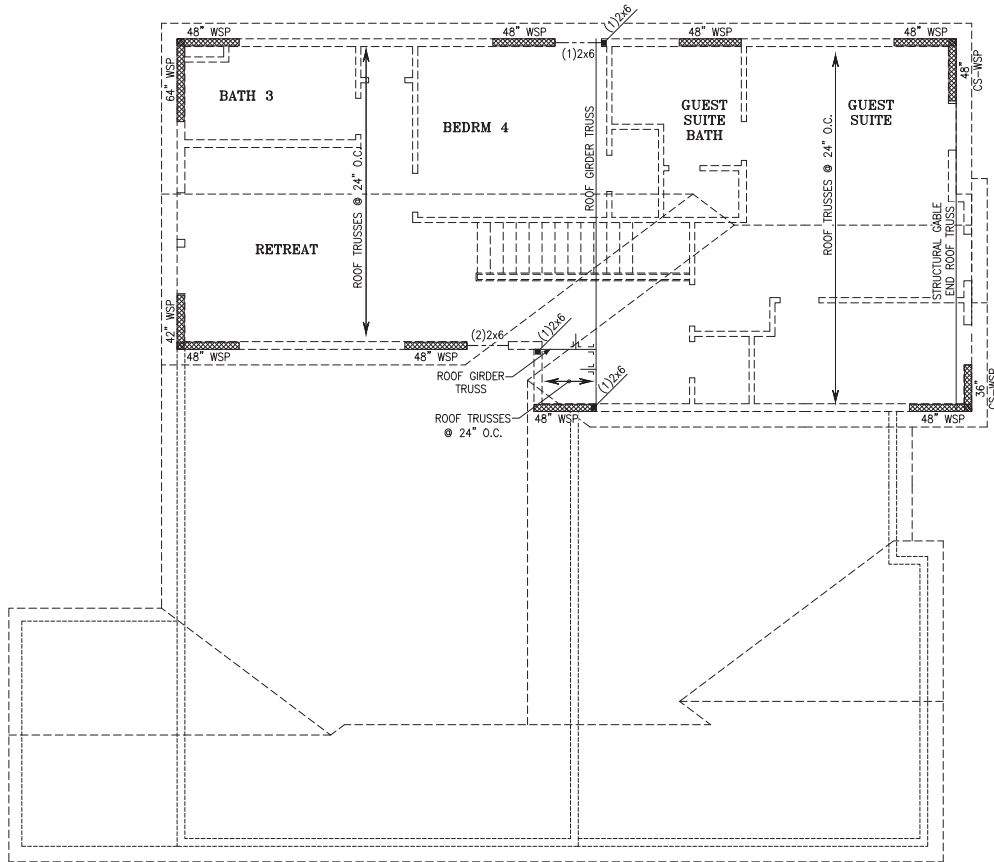

ROOF FRAMING PLAN

LEGEND	
	PROVIDE SOLID BLOCKING WITHIN FLOOR SYSTEM TO MATCH POST SIZE ABOVE.
	BEARING WALL ABOVE
	INTERIOR BEARING WALL
	BRACED WALL PANEL (SEE KSE STRUCTURAL DETAILS SET FOR BRACED WALL PANEL SHEATHING FASTENING & BLOCKING DETAILS)
	REFER TO KSE STRUCTURAL DETAILS SET FOR GENERAL STRUCTURAL NOTES, TYPICAL DETAILS AND ADVANCED FRAMING NOTES AND DETAILS
PLAN DESIGNED WITH 9' NOMINAL WALL PLATE HEIGHT	



Roof Framing Plan  
 Serenity, Lot #142  
 B329 Buckhorn Model  
 Serenity  
 Raleigh, North Carolina

Project #: 047-20009  
 Designed By: JPS  
 Checked By:  
 Issue Date: 3/20/24  
 Re-Issue:  
 Scale: 1/8"=1'-0" @ 11x17  
 1/4"=1'-0" @ 22,34



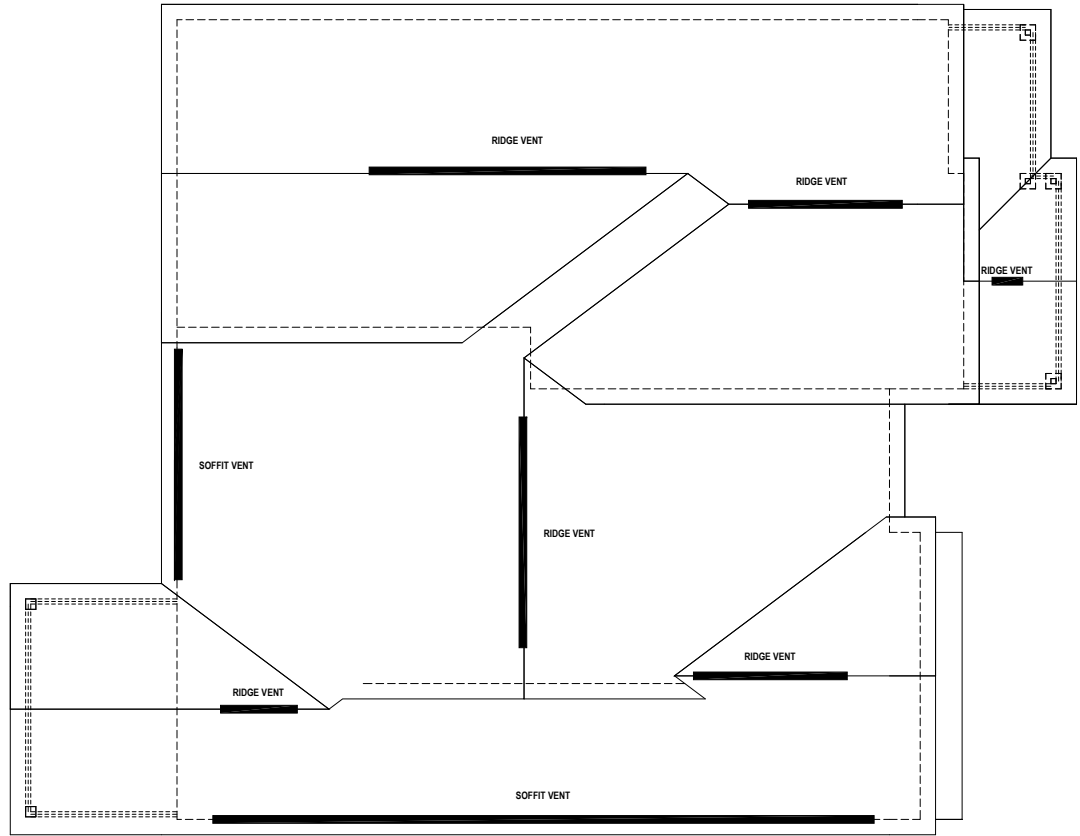

ROOF PLAN CALCS

ROOF VENT CALCULATION:  
 ATTIC SPACE: 2855 SQ.FT.  
 REQUIRED VENTILATION: 1370 SQ.IN. REQ.  
 SOFFIT VENT PROVIDED: 58 LINEAL FEET  
 RIDGE VENT PROVIDED: 60 LINEAL FEET  
 AIR HAWK VENT PROVIDED: 0 UNITS  
 PROVIDED VENTILATION: 1370 SQ.IN.  
 50-80% IN UPPER PORTION: 79%

© Weekley Homes, L.P. 2020  
 The measurements, dimensions, and other specifications shown on this document are guidelines for construction use only. This document may not be relied on as a representation of what the completed structure will look like.

**David Weekley Homes**

CN/NU/IR      Scale: 1/8"=1'-0"  
 Date:              Rev: 12/5/23 AM

142  
 Lot:      Block:      Sect:  
 Proj. No.: 3277      Job No.: 0142  
 SERENITY 65' (IM)  
 627 SERENITY WALK PARKWAY  
 FUGUAY VARINA, NC

SOUTH  
**B329-B**  
**RFP-2**  
 BUCKHORN  
 RALEIGH

**General Notes:** \*\* CUTTING OR DRILLING OF COMPONENTS SHOULD NOT BE DONE WITHOUT CONTACTING COMPONENT SUPPLIER FIRST. CUSTOMER TAKES FULL RESPONSIBILITY FOR COMPONENTS IF CUT BEFORE AUTHORIZATION. \*\* ALL BEARING POINTS MUST BE INSTALLED PRIOR TO SETTING ANY COMPONENTS.

\* FRAMER MUST REFER TO PLANS WHILE SETTING COMPONENTS. \* DAMAGED COMPONENTS SHOULD NOT BE INSTALLED UNLESS TOLD TO BY THE COMPONENT PLANT.

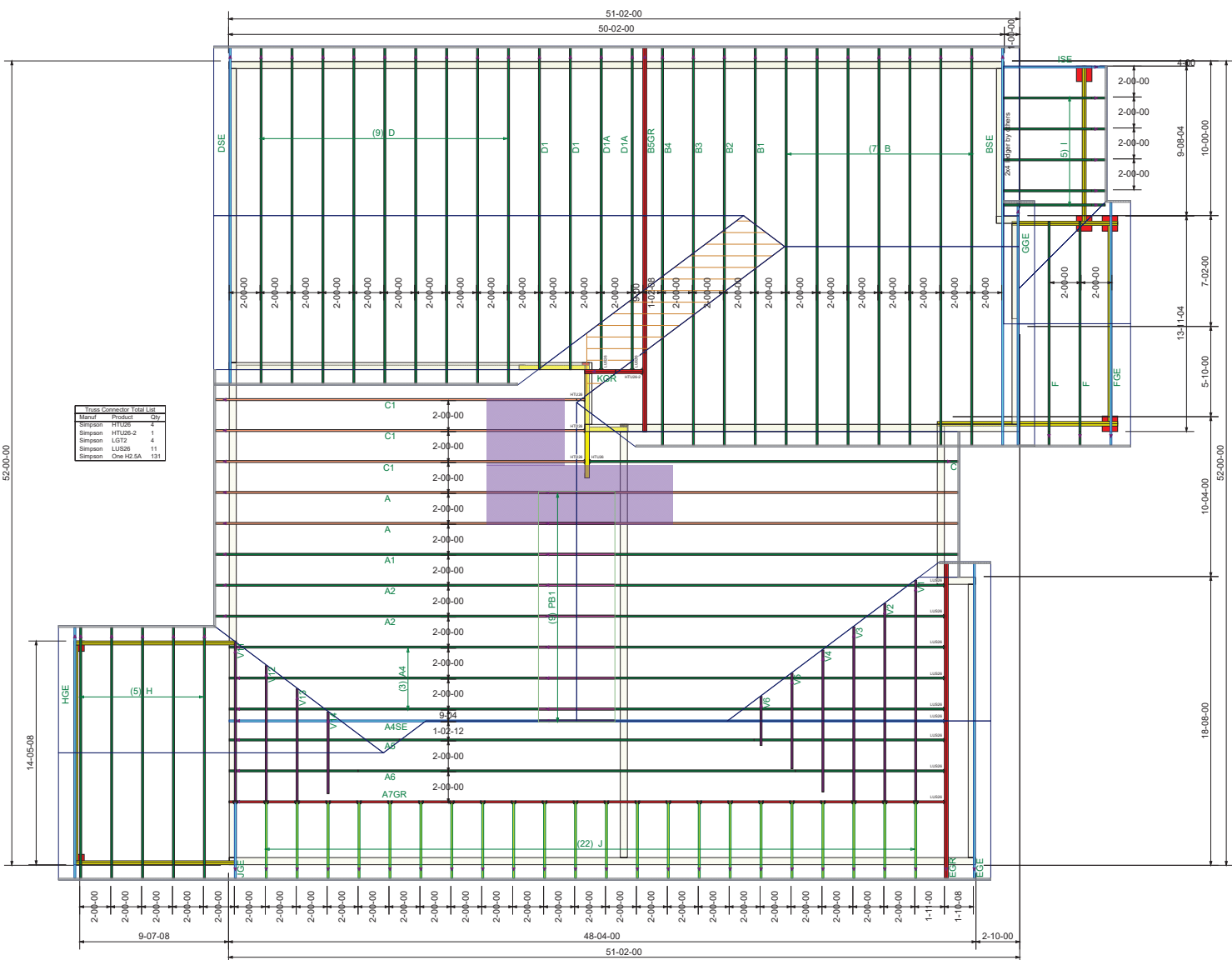

Truss Connector	Total List	
Manuf	Product	Qty
Simpson	HTD8	4
Simpson	HTL26-2	1
Simpson	LG12	4
Simpson	LUS26	11
Simpson	One H2.5A	131

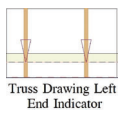

\*\* TRUSS TO TRUSS CONNECTIONS ARE FOC-MAILED, UNLESS NOTED OTHERWISE. \*\* DIMENSIONS ARE READ AS: FOOT-INCH-SIXTEENTH. \*\* SHEDDERS MUST BE FULLY CONNECTED TOGETHER PRIOR TO ADDING ANY LOADS. \*\* REFER TO FINAL TRUSS ENGINEERING SHEETS FOR PLY TO PLY CONNECTIONS.

Revisions	
00/00/00	Name
00/00/00	Name
00/00/00	Name
00/00/00	Name
00/00/00	Name

**THIS IS A TRUSS PLACEMENT PROGRAM ONLY.** These trusses are designed as individual components to be incorporated into the building design at the specification of the building designer. See individual design sheets for each truss design identified on the placement drawing. The building designer is responsible for the overall design of the truss and for the overall structure. The design of the truss support structure including headers, beams, walls, and columns is the responsibility of the building designer. "Bracing of Wood Truss" available from the Truss Plate Institute, 583 D'Orazio Drive, Madison, WI 53719



David Weekley  
142 Serenity  
**COMPONENT PLAN**

Scale:	NTS
Date:	3/29/2024
Designer:	ND
Project Number:	24030153
Sheet Number:	

**1/1**



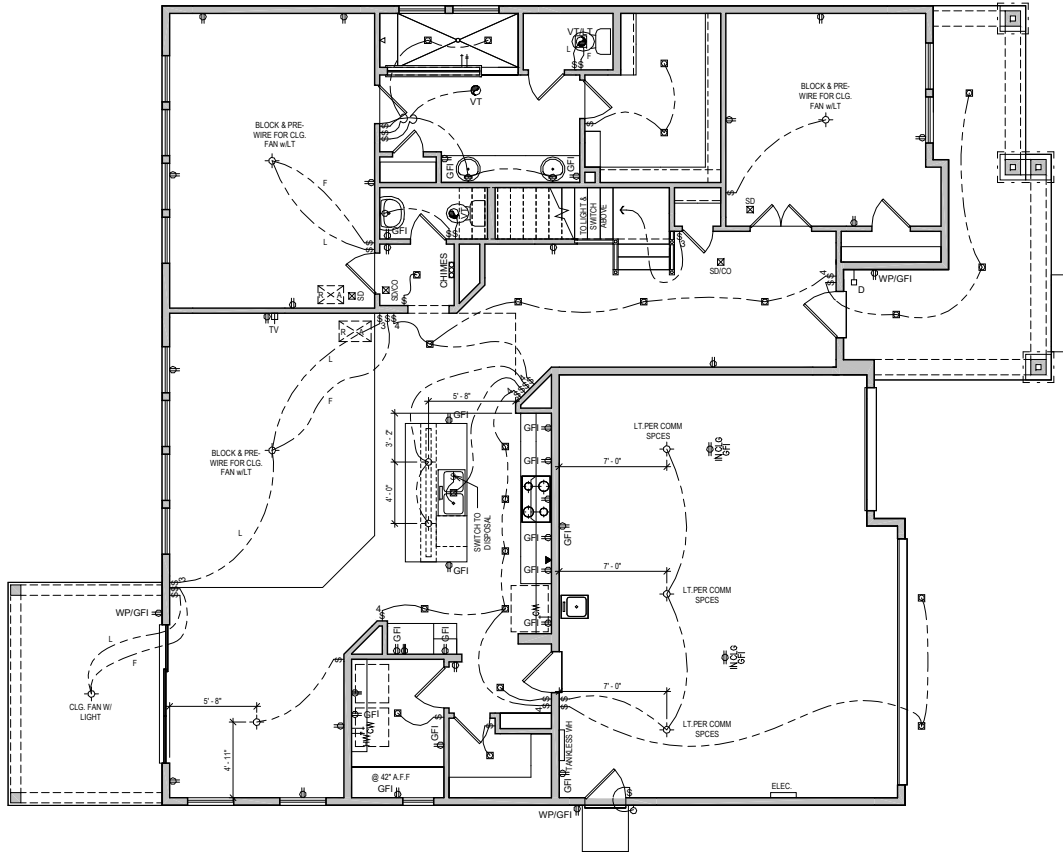

**FIRST FLOOR**

UTILITY LEGEND					
⊕	110V OUTLET	⊕	12" A.F.F. (U.S.N.C.)	⊕	ELEVATOR CALL BUTTON
GFI	GROUND FAULT INTERRUPTOR (WEATHER PROOF AS NOTED)	⊕	220V OUTLET (30" A.F.F. @ UTILITY)	⊕	RECESS CAN LIGHT (EYEBALL AS NOTED)
1/2	HALF HOT OUTLET	⊕	PHONE LINE	VT	EXHAUST VENT
⊕	CABLE TELEVISION	⊕	STANDARD SWITCH (3 OR 4 WAY AS NOTED)	SD	SMOKE DETECTOR (CARBON MONOXIDE AS NOTED)
⊕	SURFACE MOUNTED LIGHT	⊕	SURFACE MOUNTED LED LIGHT	D	DOOR BELL
⊕	WALL MOUNTED LIGHT	⊕	LED DISC LIGHT	CHIMES	CHIMES
		⊕	WALL MOUNTED LIGHT	⊕	DOOR BELL CHIMES
		⊕	WALL MOUNTED LIGHT	ELEC	PANELBOARD W/ CIRCUIT BREAKERS
		⊕	WALL MOUNTED LIGHT	HB	HOSE BIB
		⊕	WALL MOUNTED LIGHT	⊕	GAS TAP
		⊕	WALL MOUNTED LIGHT	⊕	CW, HW
		⊕	WALL MOUNTED LIGHT	⊕	COLD/HOT WATER SUPPLY

IN ALL HABITABLE ROOMS LIGHT BOXES MUST BE FAN RATED

CITY SPECIFIC  
 VTLT RECESSED CAN/ EXHAUST VENT COMBO

ALL RECESS CANS SHOWN ON PLAN ARE LED PER COMMUNITY SPEC.

**MID-ATLANTIC General Notes**

1. ALL ELECTRICAL PLUGS TO BE 9" TO TOP FROM FLOOR IN ROOMS WITH WALL MOLDINGS.
2. SWITCH FOR ATTIC LIGHT TO BE LOCATED OUTSIDE OF ATTIC SPACE, 12 INCHES FROM CEILING.
3. DO NOT RUN WIRES ON TOP OF JOISTS IN AREAS LIKELY TO HAVE DECKING IN ATTIC. (near disappearing stairs)
4. PROVIDE SMOKE DETECTORS IN EVERY BEDROOM. SEE SPECS FOR REQUIRED TYPE AND WIRING.
5. PROVIDE GAS AT APPLIANCES PER COMMUNITY REQUIREMENTS.
6. LOCATE ELECTRICAL PANEL IN LOCATION CLOSEST TO SERVICE.

© Weekley Homes, L.P. 2020  
 The measurements, dimensions, and other specifications shown on this document are guidelines for construction use only. This document may not be relied on as a representation of what the completed structure will look like.

**David Weekley Homes**  
 CN/NU/IR Date: 09/21/2020 Scale: 1/8"=1'-0" Rev: 12/5/23 AM

Proj. No.: 142  
 Lot: 3277  
 Block: 0142  
 Sect:

**SERENITY 65' (IM)**  
**627 SERENITY WALK PARKWAY**  
**FUQUAY VARINA, NC**

**SOUTH B329-B**  
**ELE-1**  
**BUCKHORN**  
**RALEIGH**

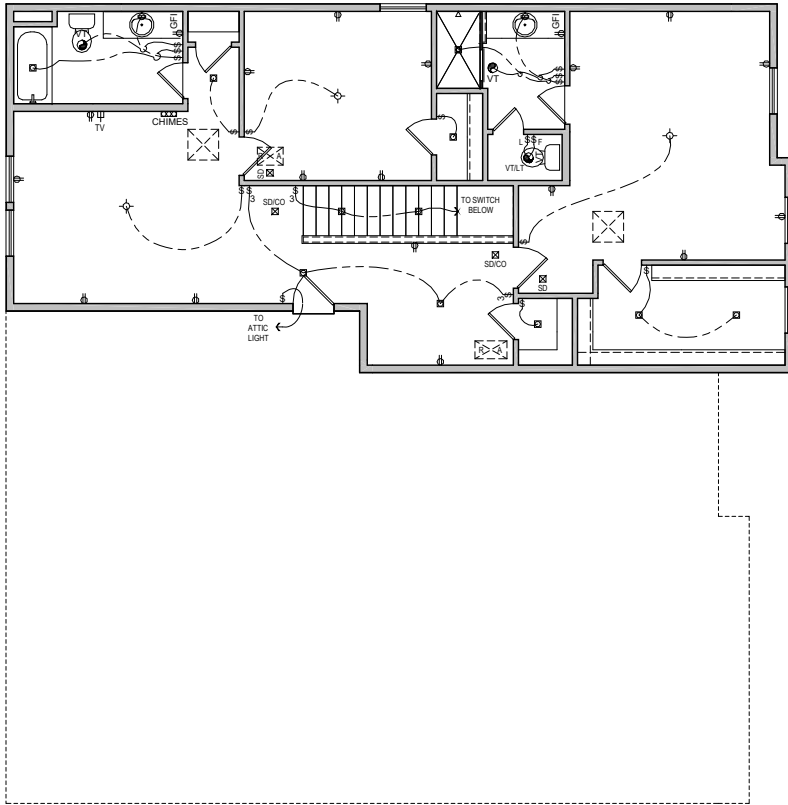

**SECOND FLOOR**

UTILITY LEGEND	
⊕	110V OUTLET 12" A.F.F. (U.N.C.)
⊕	GROUND FAULT INTERRUPTOR (WEATHER PROOF AS NOTED)
1/2 ⊕	HALF HOT OUTLET
⊕	220V OUTLET (30" A.F.F. @ UTILITY)
∇	PHONE LINE
TV	CABLE TELEVISION
⊕	STANDARD SWITCH (3 OR 4 WAY AS NOTED)
⊕	SURFACE MOUNTED LIGHT
⊕	SURFACE MOUNTED LED LIGHT
⊕	WALL MOUNTED LIGHT
E	ELEVATOR CALL BUTTON
⊕	RECESS CAN LIGHT (EYEBALL AS NOTED)
VTL	EXHAUST VENT
SD	SMOKE DETECTOR (CARBON MONOXIDE AS NOTED)
D	DOOR BELL
CHIMES	CHIMES
DOOR BELL	DOOR BELL
CHIMES	CHIMES
PANELBOARD W/ CIRCUIT BREAKERS	PANELBOARD W/ CIRCUIT BREAKERS
HOSE BIB	HOSE BIB
GAS	GAS TAP
CW, HW	COLD/HOT WATER SUPPLY

IN ALL HABITABLE ROOMS  
LIGHT BOXES MUST BE FAN  
RATED

CITY SPECIFIC  
RECESSED CAN/ EXHAUST  
VENT COMBO

ALL RECESS CANS SHOWN  
ON PLAN ARE LED PER  
COMMUNITY SPEC.

**MID-ATLANTIC General Notes**

1. ALL ELECTRICAL PLUGS TO BE 9" TO TOP FROM FLOOR IN ROOMS WITH WALL MOLDINGS.
2. SWITCH FOR ATTIC LIGHT TO BE LOCATED OUTSIDE OF ATTIC SPACE, 12 INCHES FROM CEILING.
3. DO NOT RUN WIRES ON TOP OF JOISTS IN AREAS LIKELY TO HAVE DECKING IN ATTIC. (near disappearing stairs)
4. PROVIDE SMOKE DETECTORS IN EVERY BEDROOM. SEE SPECS FOR REQUIRED TYPE AND WIRING.
5. PROVIDE GAS AT APPLIANCES PER COMMUNITY REQUIREMENTS.
6. LOCATE ELECTRICAL PANEL IN LOCATION CLOSEST TO SERVICE.

© Weekley Homes, L.P., 2020  
The measurements, dimensions, and other specifications shown on this document are guidelines for construction use only. This document may not be relied on as a representation of what the completed structure will look like.

**David Weekley Homes**  
CN/NU/IR Date: 09/21/2020 Scale: 1/8"=1'-0" Rev: 12/5/23 AM

Proj. No.: 142  
Lot: 3277  
Block: 0142  
Sect:

**SERENITY 65' (IM)**  
**627 SERENITY WALK PARKWAY**  
**FUQUAY VARINA, NC**

**SOUTH**  
**B329-B**  
**ELE-2**  
**BUCKHORN**  
**RALEIGH**



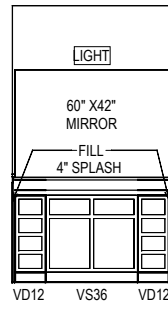
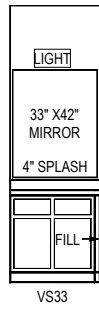
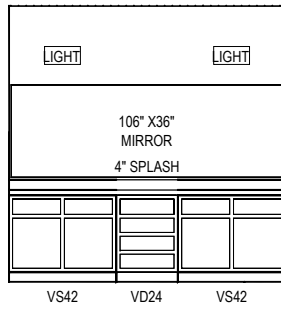
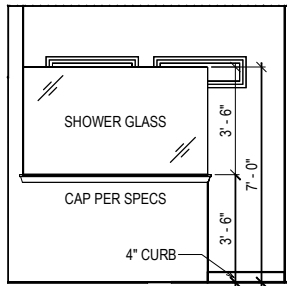
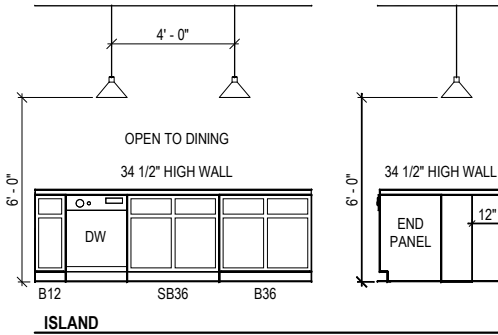
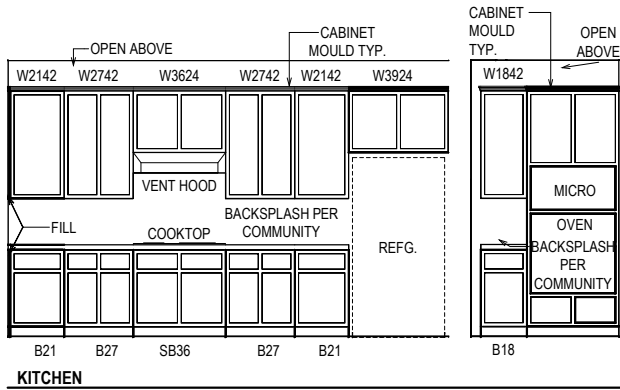

**OWNER'S BATH**

**BATH 3**

**SUITE BATH**

**PWDR**

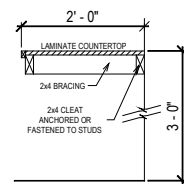
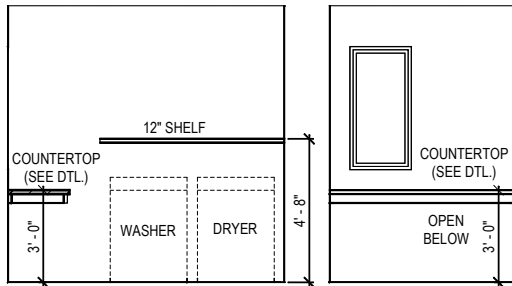

SCALE: 1/2" = 1'-0"

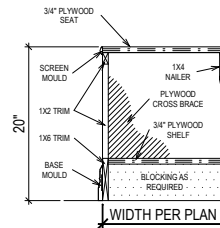
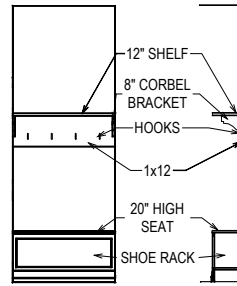

SCALE: 3/4" = 1'-0"

© Weekley Homes, L.P. 2020  
 The measurements, dimensions, and other specifications shown on this document are guidelines for construction use only. This document may not be relied on as a representation of what the completed structure will look like.

**David Weekley Homes**  
 C/N/NU/IR Date: 09/21/2020 Scale: 1/4" = 1'-0" Rev: 12/5/23 AM

Proj. No.: 142  
 Lot: 3277  
 Block: 0142  
 Sect:

**SERENITY 65' (IM)**  
**627 SERENITY WALK PARKWAY**  
**FUQUAY VARINA, NC**

**SOUTH**  
**B329-B**  
**INT-1**  
**BUCKHORN**  
**RALEIGH**

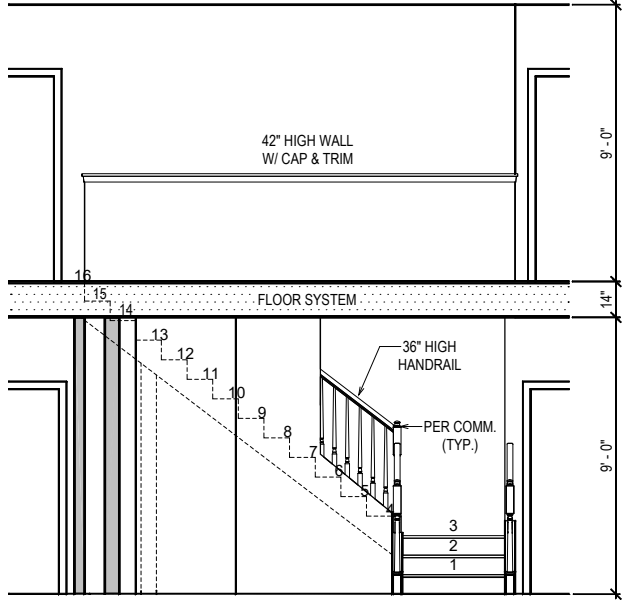

STAIR SECTION

© Weekley Homes, L.P. 2020  
 The measurements, dimensions, and other specifications shown on this document are guidelines for construction use only. This document may not be relied on as a representation of what the completed structure will look like.

**David Weekley Homes**

CN/NU/IR	Date: 09/21/2020	Scale: 1/4"=1'-0"	Rev: 12/5/23 AM
----------	------------------	-------------------	-----------------

<b>SERENITY 65' (IM)</b> <b>627 SERENITY WALK PARKWAY</b> <b>FUQUAY VARINA, NC</b>	Proj. No.:	142
	Lot:	3277
	Job No.:	0142
	Block:	
	Sect:	

SOUTH  
**B329-B**  
**INT-2**  
 BUCKHORN  
 RALEIGH

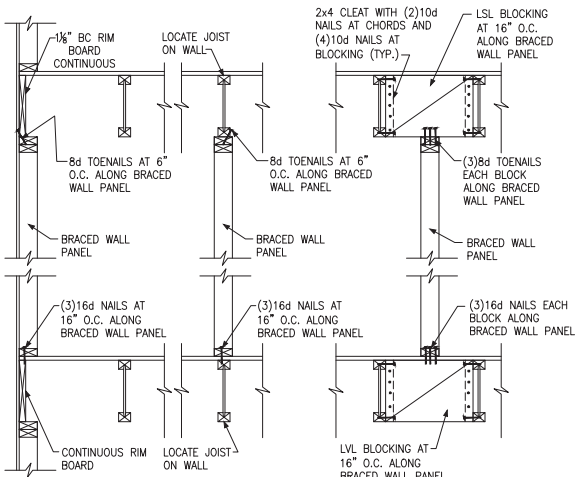

**A** TYPICAL BRACED WALL PANEL TO FLOOR/CEILING CONNECTION  
BRACED WALL PANELS PARALLEL TO I-JOISTS

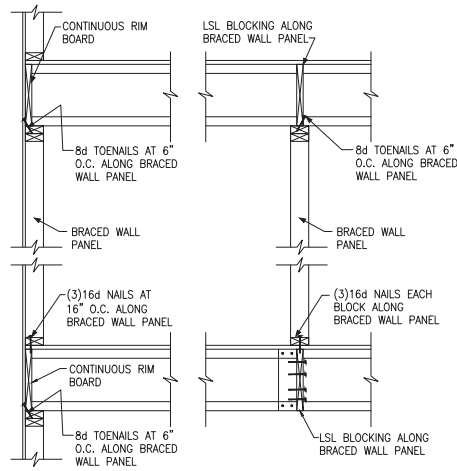

**B** TYPICAL BRACED WALL PANEL TO FLOOR/CEILING CONNECTION  
BRACED WALL PANELS PERPENDICULAR TO I-JOISTS

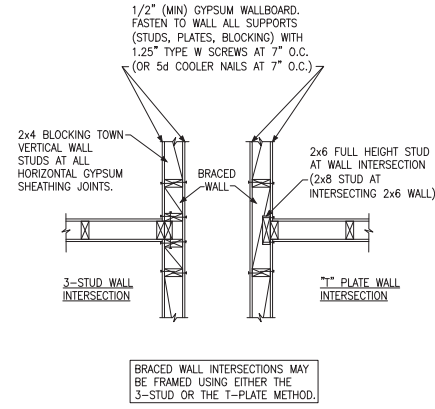

**C** METHOD GB(1) AND GB(2) INTERSECTION DETAILS

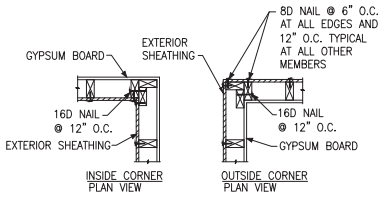

**D** TYPICAL EXTERIOR CORNER WALL FRAMING

NOTE: A THIRD STUD AND/OR PARTITION INTERSECTION BACKING STUDS SHALL BE PERMITTED TO BE OMITTED THROUGH THE USE OF WOOD BACKUP CLEATS, METAL DRYWALL CLIPS OR OTHER APPROVED DEVICES THAT WILL SERVE AS ADEQUATE BACKING FOR THE FACING MATERIALS.

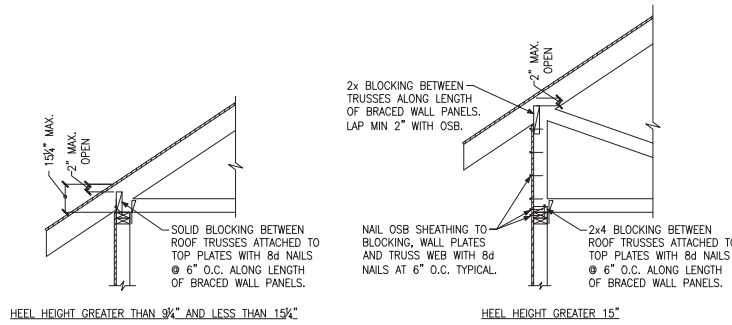

**E** ROOF TRUSS BEARING/BLOCKING AT BRACED WALL PANELS  
ONLY REQUIRED AT BRACED WALL PANELS



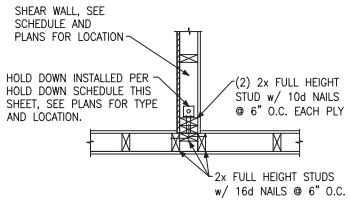

(A) TYPICAL HOLD DOWN DETAIL

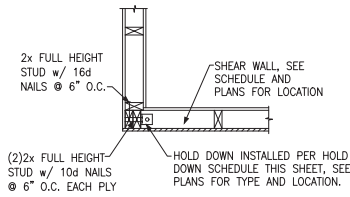

(B) TYPICAL HOLD DOWN DETAIL

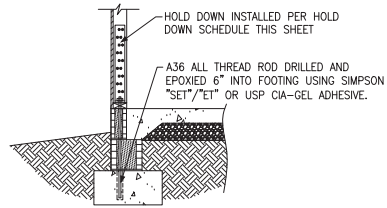

(C) HOLD DOWN AT STEMWALL SLAB

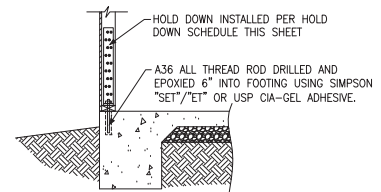

(D) HOLD DOWN AT MONOLITHIC SLAB

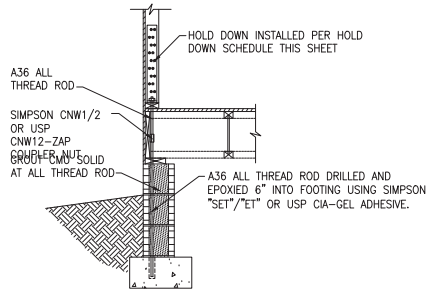

(E) HOLD DOWN AT CRAWL FOUNDATION

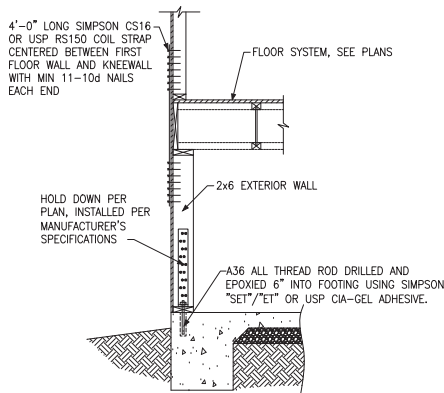

(F) HOLD DOWN AT FOUNDATION MONOLITHIC TURN-DOWN

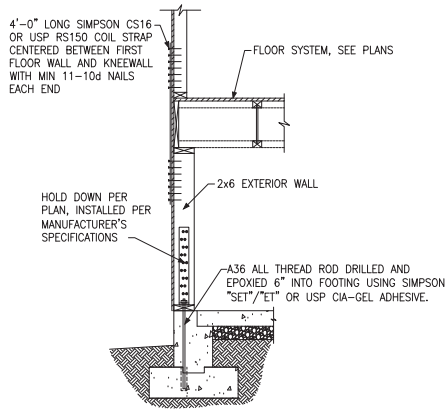

(G) HOLD DOWN AT FOUNDATION STEM WALL

HOLD DOWN SCHEDULE			
HOLD DOWN		ALL TREAD ROD	FASTENERS
SIMPSON	USP		
LTP2	LTS20B	½" DIA.	(10)10d NAILS
HTT4	HTT16	¾" DIA.	(18)16dx2½" LONG NAILS
HTT5	HTT45	¾" DIA.	(26)16dx2½" LONG NAILS



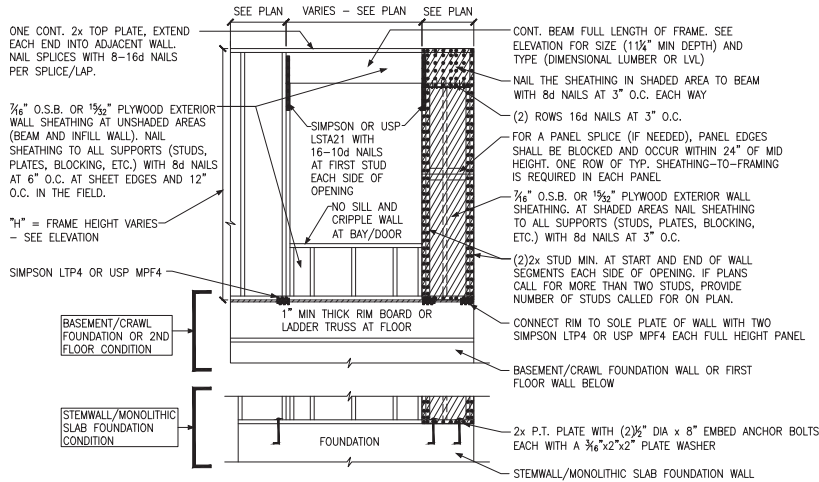

**A** METHOD CS-PF: CONTINUOUS PORTAL FRAME PANEL CONSTRUCTION  
ONE BRACED WALL SEGMENT

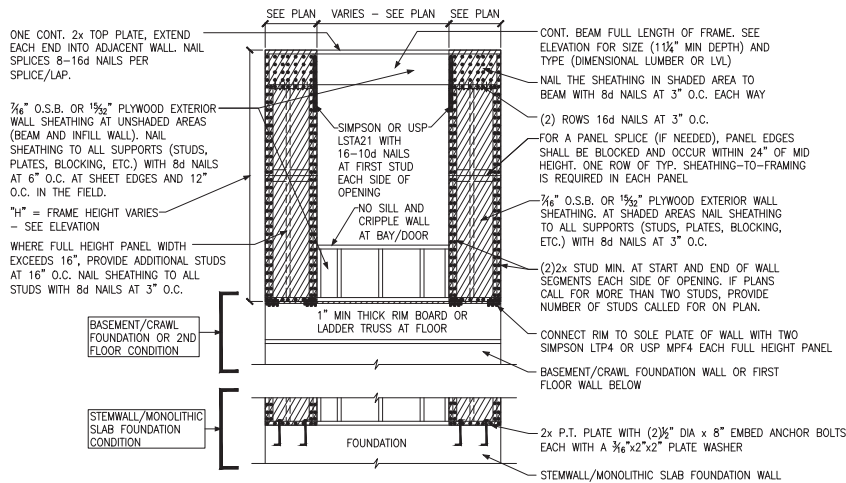

**B** METHOD CS-PF: CONTINUOUS PORTAL FRAME PANEL CONSTRUCTION  
TWO BRACED WALL SEGMENTS

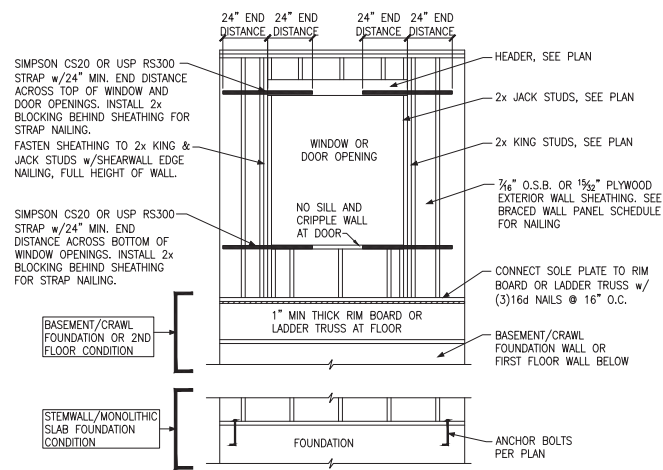

**C** WINDOW OR DOOR REINFORCEMENT IN ENGINEERED SHEAR WALL  
ONLY REQUIRED WHERE SPECIFIED ON PLANS

BRACED WALL PANEL AND ENGINEERED SHEAR WALL SCHEDULE			
PANEL TYPES	PANEL TYPE	MATERIAL	FASTENERS
WSP	INTERMITTENT WOOD STRUCTURAL PANEL	7/16" OSB	6d or 8d COMMON NAILS AT 6" O.C. AT SHEET EDGES AND 12" O.C. AT INTERMEDIATE SUPPORTS. ENGINEERED ALTERNATIVE: 16 GAGE BY 1.75" LONG STAPLES AT 3" O.C. AT SHEET EDGES AND 6" O.C. AT INTERMEDIATE SUPPORTS
GB(1)	INTERMITTENT GYPSUM BOARD (SHEATHING ONE FACE OF WALL)	1/2" GYPSUM	1.5" LONG GAL. ROOFING NAILS, 6d COMMON NAILS, OR 1.25" LONG TYPE W DRYWALL SCREWS AT 7" O.C. AT SHEET EDGES AND INTERMEDIATE SUPPORTS.
GB(1)-4	INTERMITTENT GYPSUM BOARD (SHEATHING ONE FACE OF WALL)	1/2" GYPSUM	1.5" LONG GAL. ROOFING NAILS, 6d COMMON NAILS, OR 1.25" LONG TYPE W DRYWALL SCREWS AT 4" O.C. AT SHEET EDGES AND INTERMEDIATE SUPPORTS.
GB(2)	INTERMITTENT GYPSUM BOARD (SHEATHING BOTH FACES OF WALL)	1/2" GYPSUM	1.5" LONG GAL. ROOFING NAILS, 6d COMMON NAILS, OR 1.25" LONG TYPE W DRYWALL SCREWS AT 7" O.C. AT SHEET EDGES AND INTERMEDIATE SUPPORTS.
CS-WSP	CONTINUOUS SHEATHED WOOD STRUCTURAL PANEL	7/16" OSB	6d or 8d COMMON NAILS AT 6" O.C. AT SHEET EDGES AND 12" O.C. AT INTERMEDIATE SUPPORTS. ENGINEERED ALTERNATIVE: 16 GAGE BY 1.75" LONG STAPLES AT 3" O.C. AT SHEET EDGES AND 6" O.C. AT INTERMEDIATE SUPPORTS
CS-PF	CONTINUOUS SHEATHED PORTAL FRAME	7/16" OSB	NAILING PER DETAIL
CS-EPF	PORTAL FRAME WITH HOLD DOWNS	7/16" OSB	NAILING PER DETAIL
CS-ESW(1)	ENGINEERED SHEAR WALL, TYPE 1	7/16" OSB	8d COMMON NAILS AT 6" O.C. AT SHEET EDGES AND 12" O.C. AT INTERMEDIATE SUPPORTS. CONTINUOUS OSB AROUND DOOR/WINDOW OPENINGS
CS-ESW(2)	ENGINEERED SHEAR WALL, TYPE 2	7/16" OSB	8d COMMON NAILS AT 4" O.C. AT SHEET EDGES AND 12" O.C. AT INTERMEDIATE SUPPORTS. CONTINUOUS OSB AROUND DOOR/WINDOW OPENINGS
CS-ESW(3)	ENGINEERED SHEAR WALL, TYPE 3	7/16" OSB	8d COMMON NAILS AT 3" O.C. AT SHEET EDGES AND 12" O.C. AT INTERMEDIATE SUPPORTS. CONTINUOUS OSB AROUND DOOR/WINDOW OPENINGS

**BRACED WALL PANEL NOTES:**

- ALL BRACED WALL PANELS, EXCEPT GB(1) & GB(2), SHALL HAVE 2x BLOCKING BETWEEN WALL STUDS AT ALL HORIZONTAL SHEET EDGES.
- PROVIDE NAILING/BLOCKING ABOVE AND BELOW ALL BRACED WALL PANELS PER KSE BRACED WALL DETAILS.
- 3/4" O.S.B. OR 1/2" PLYWOOD, FASTENED PER IRC. AT EXTERIOR CORNERS, SHEATHING SHALL BE FASTENED PER KSE BRACED WALL DETAILS. AT INTERIOR WALL INTERSECTIONS, FASTEN STUDS & WALL BRACING PER KSE BRACED WALL DETAILS.
- BRACED WALL PANELS AND ENGINEERED SHEAR WALLS ARE PROVIDED PER IRC. PANEL LENGTHS SHOWN ON PLANS ARE THE MINIMUM LENGTH REQUIRED.



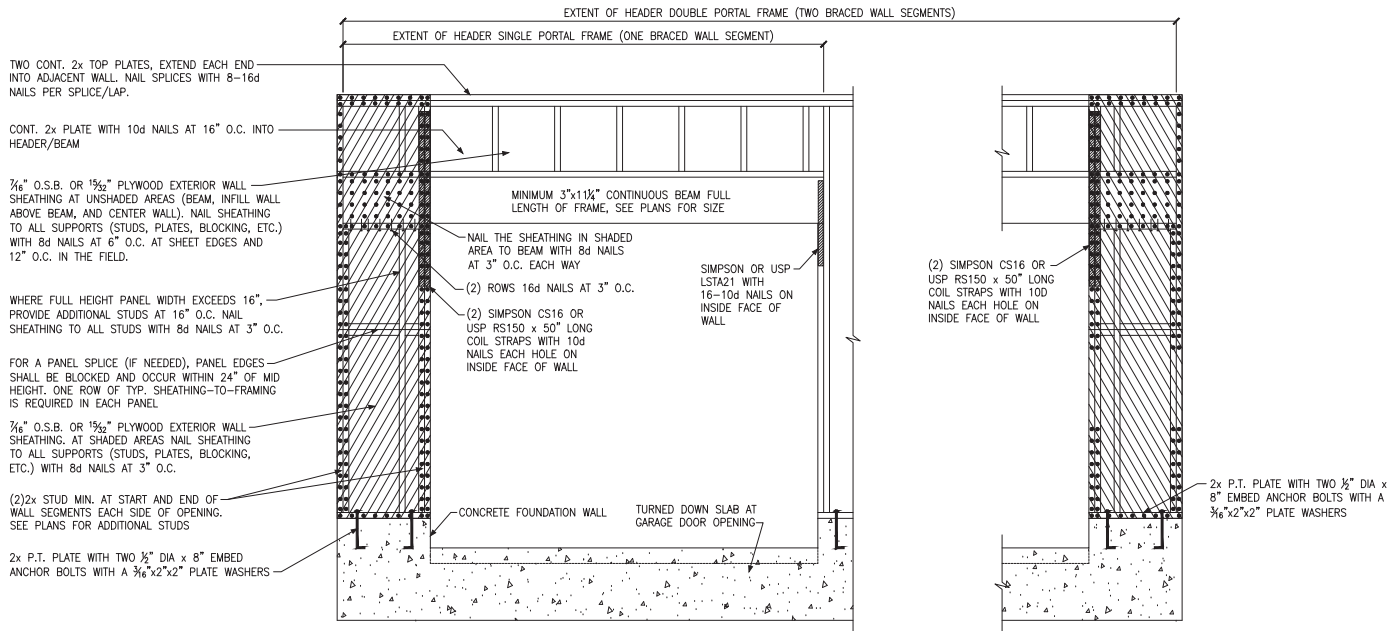

**(A) METHOD CS-PF: CONTINUOUS PORTAL FRAME PANEL CONSTRUCTION**  
MONOLITHIC SLAB OR BASEMENT FOUNDATION

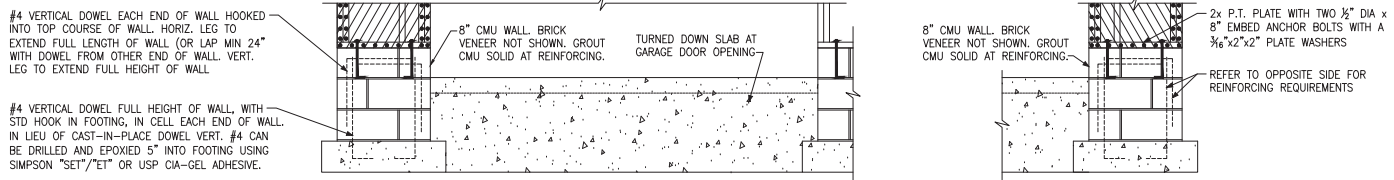

**(B) METHOD CS-PF: CONTINUOUS PORTAL FRAME PANEL CONSTRUCTION**  
STEMWALL SLAB OR CRAWL SPACE FOUNDATION

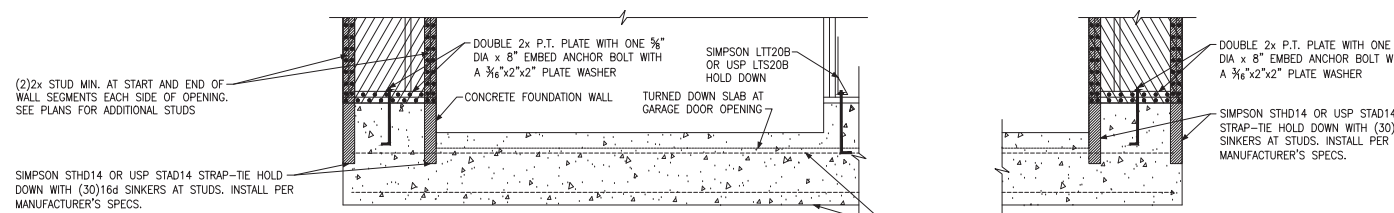

**(C) METHOD CS-EPF: ENGINEERED PORTAL FRAME WITH HOLD-DOWNS**  
CONTINUOUS #4 HIGH AND LOW. PROVIDE MIN 24" LAPS WHERE SPICED.



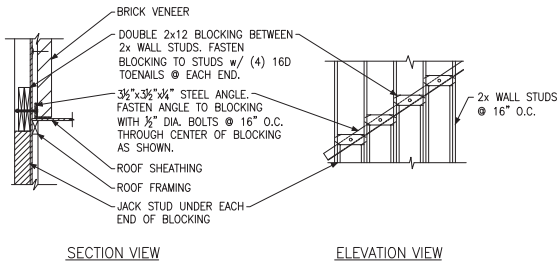

SECTION VIEW ELEVATION VIEW

(A) BRICK LEDGER CONNECTION DETAIL

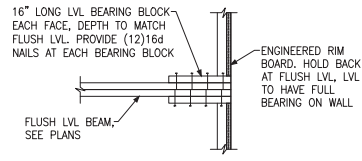

(B) BEARING ENHANCER FLUSH LVL

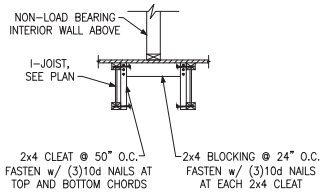

(C) I-JOIST LADDER BLOCKING AS REQUIRED @ PARALLEL WALLS

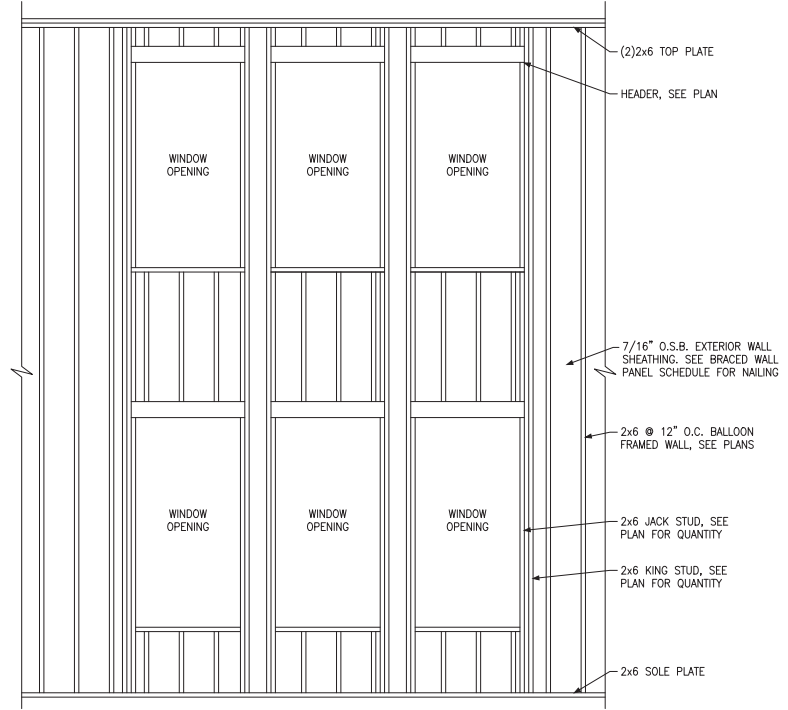

(D) BALLOON FRAMED WALL DETAIL N.T.S.

WALL STUD SIZE, HEIGHT & SPACING SCHEDULE						
STUD SIZE	BEARING WALLS				NONBEARING WALLS	
	LATERALLY UNSUPPORTED STUD HEIGHT	MAXIMUM SPACING WHEN SUPPORTING A ROOF-CEILING ASSEMBLY OR A HABITABLE ATTIC ASSEMBLY, ONLY	MAXIMUM SPACING WHEN SUPPORTING ONE FLOOR, PLUS A ROOF-CEILING ASSEMBLY OR A HABITABLE ATTIC ASSEMBLY	MAXIMUM SPACING WHEN SUPPORTING TWO FLOORS, PLUS A ROOF-CEILING ASSEMBLY OR A HABITABLE ATTIC ASSEMBLY	LATERALLY UNSUPPORTED STUD HEIGHT	MAXIMUM SPACING
2x4	10'-0"	24"	16"	-	14'-0"	24"
2x6	10'-0"	24"	24"	16"	20'-0"	24"



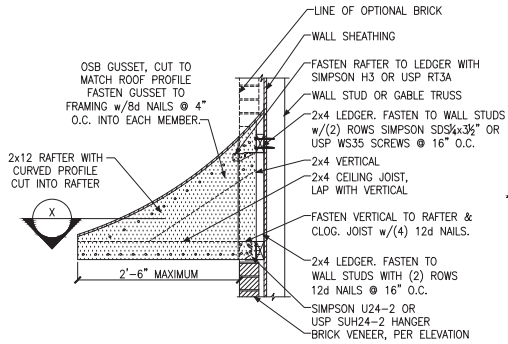

**A PENT ROOF DETAIL**  
CURVED ROOF

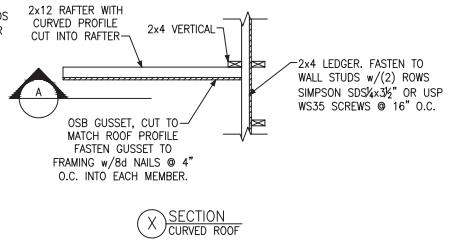

**X SECTION**  
CURVED ROOF

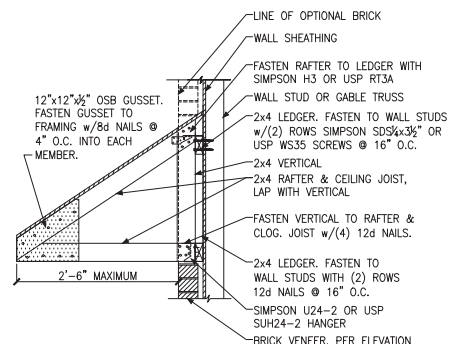

**B PENT ROOF DETAIL**  
STRAIGHT ROOF

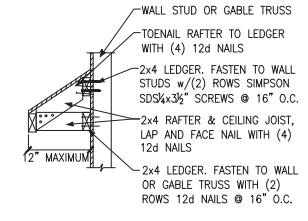

**C EYEBROW ROOF DETAIL**  
STRAIGHT ROOF

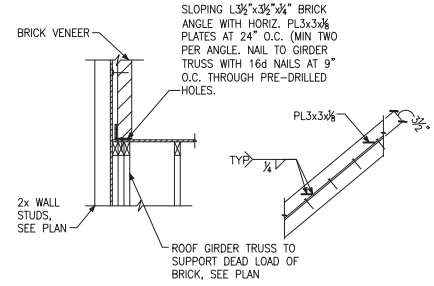

**D TRUSS DETAIL**

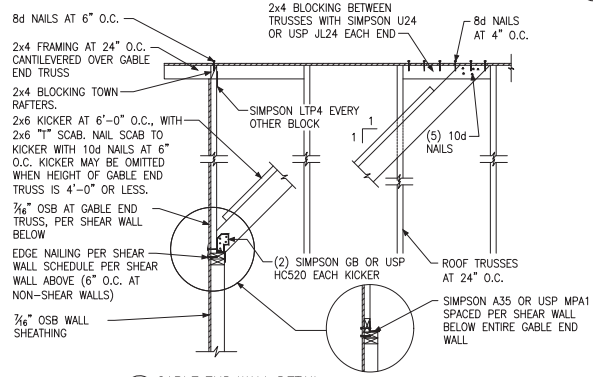

**E GABLE END WALL DETAIL**





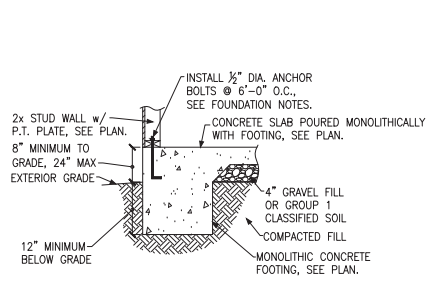

**A** FOUNDATION SECTION  
EXTERIOR WALL

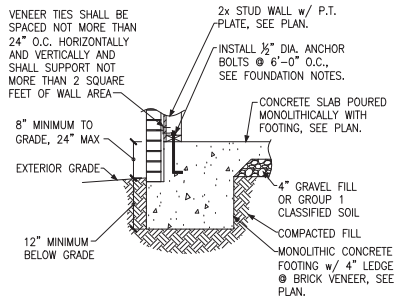

**B** FOUNDATION SECTION  
EXTERIOR WALL @ BRICK VENEER

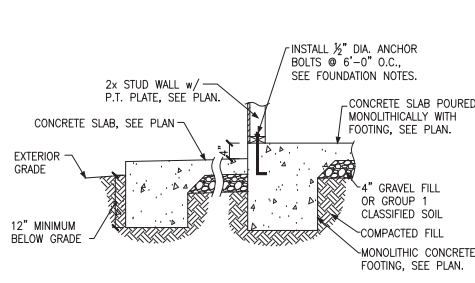

**C** FOUNDATION SECTION  
EXTERIOR WALL AT PORCH

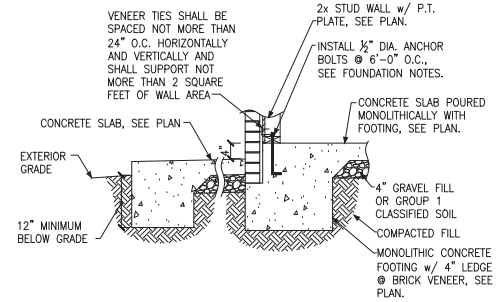

**D** FOUNDATION SECTION  
EXTERIOR WALL AT PORCH w/ BRICK VENEER

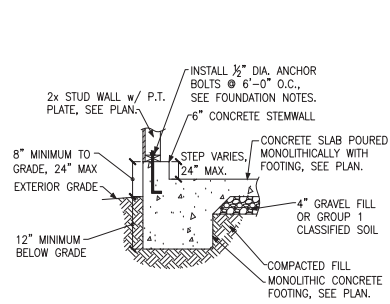

**E** FOUNDATION SECTION  
EXTERIOR GARAGE WALL

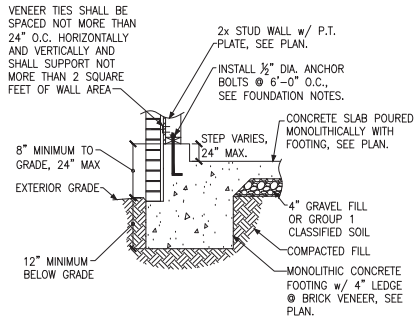

**F** FOUNDATION SECTION  
EXTERIOR GARAGE WALL @ BRICK VENEER

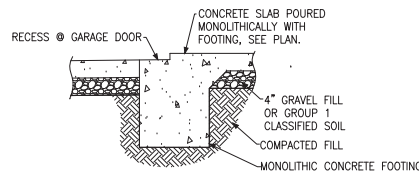

**G** GARAGE DOOR SECTION  
GARAGE DOOR

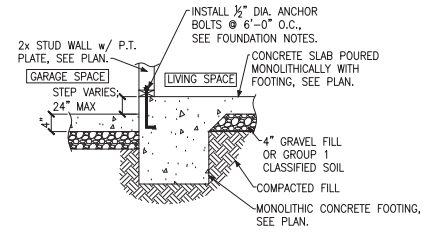

**H** THICKENED SLAB  
AT GARAGE

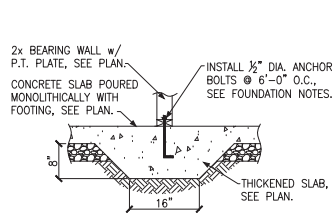

**J** THICKENED SLAB SECTION  
INTERIOR BEARING WALL

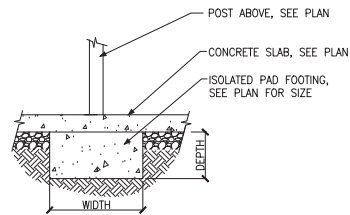

**K** ISOLATED PAD FOOTING  
INTERIOR COLUMN



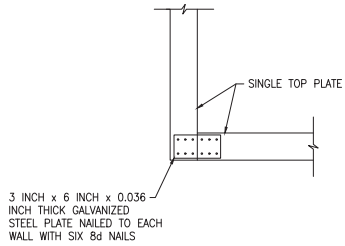

**A** SINGLE TOP PLATE SPLICE WALL INTERSECTION

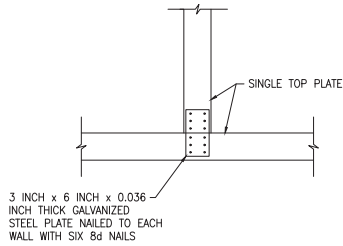

**B** SINGLE TOP PLATE SPLICE WALL INTERSECTION

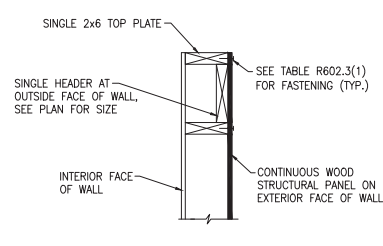

**C** SINGLE LOAD BEARING HEADER EXTERIOR WALL

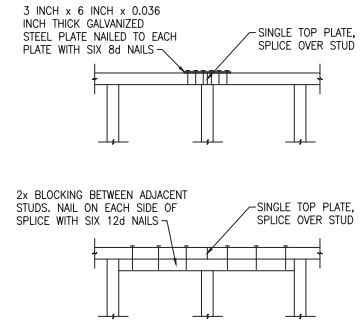

**D** SINGLE TOP PLATE SPLICE INTERIOR OR EXTERIOR WALL

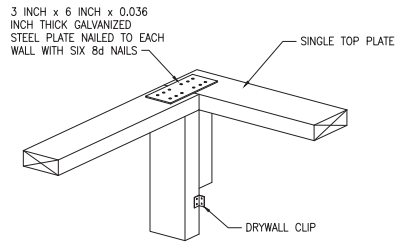

**E** SINGLE TOP PLATE SPLICE WALL INTERSECTION

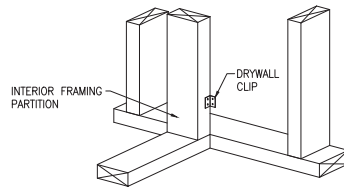

**F** SINGLE TOP PLATE SPLICE WALL INTERSECTION

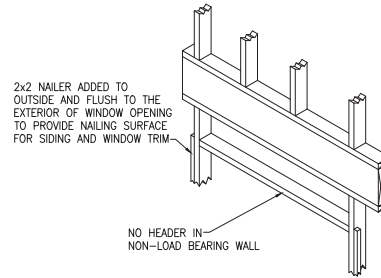

**G** NON-LOAD BEARING HEADER EXTERIOR WALL

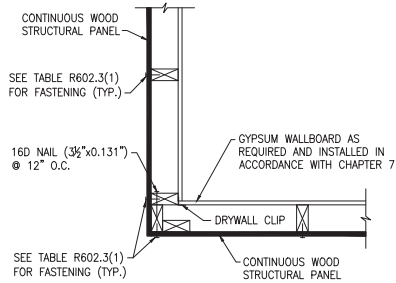

**H** TYPICAL EXTERIOR CORNER FRAMING OUTSIDE CORNER DETAIL

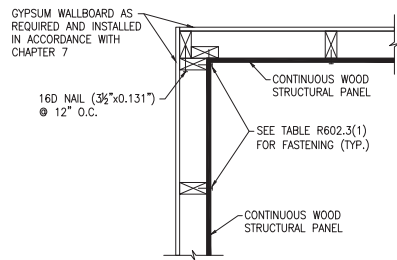

**J** TYPICAL EXTERIOR CORNER FRAMING INSIDE CORNER DETAIL

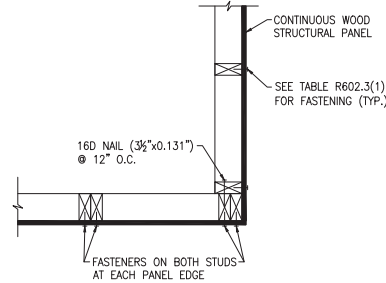

**K** TYPICAL EXTERIOR CORNER FRAMING GARAGE DOOR CORNER DETAIL

**ADVANCED FRAMING NOTES**

- 1.) EXTERIOR WALLS TO BE 2x6 S.P.F. STUDS @ 24" O.C. WITH SINGLE TOP PLATE. TOP PLATE TO BE SPLICED PER NC RESIDENTIAL CODE.
- 2.) INTERIOR BEARING WALLS TO BE PER NC RESIDENTIAL CODE.
- 3.) ROOF TRUSSES AND FLOOR JOISTS ARE TO BE STACKED AND CENTERED OVER STUDS WITH A TOLERANCE OF NO MORE THAN 1 INCH. ADDITIONAL STUDS ARE TO BE ADDED WHERE THE ROOF TRUSSES AND FLOOR JOISTS ARE NOT STACKED OVER STUDS WITHIN 1" TOLERANCE.
- 4.) INTERIOR NON-LOAD BEARING WALLS TO BE 2x4 S.P.F. STUDS @ 24" O.C. WITH SINGLE TOP PLATE. TOP PLATE TO BE SPLICED PER NC RESIDENTIAL CODE.
- 5.) LOAD-BEARING HEADERS ARE NOT REQUIRED IN INTERIOR OR EXTERIOR NONBEARING WALLS. A SINGLE FLAT 2x MEMBER MAY BE USED AS A HEADER IN INTERIOR OR EXTERIOR NONBEARING WALLS FOR OPENINGS UP TO 8 FEET IN WIDTH IF THE VERTICAL DISTANCE TO THE PARALLEL NAILING SURFACE IS NOT MORE THAN 24 INCHES. FOR SUCH NONBEARING HEADERS, NO CRIPPLES OR BLOCKING ARE REQUIRED ABOVE THE HEADER.

