

**PLANS DESIGNED TO THE
2018 NORTH CAROLINA STATE
RESIDENTIAL BUILDING CODE**

MEAN ROOF HEIGHT: 17'-2" HEIGHT TO RIDGE: 25'-6"

CLIMATE ZONE	ZONE 3A	ZONE 4A	ZONE 5A
FENESTRATION U-FACTOR	0.35	0.35	0.35
SKYLIGHT U-FACTOR	0.55	0.55	0.55
GLAZED FENESTRATION SHGC	0.30	0.30	0.30
CEILING R-VALUE	38 or 30ci	38 or 30ci	38 or 30ci
WALL R-VALUE	15	15	19
FLOOR R-VALUE	19	19	30
* BASEMENT WALL R-VALUE	5/13	10/15	10/15
** SLAB R-VALUE	0	10	10
* CRAWL SPACE WALL R-VALUE	5/13	10/15	10/19

* 10/15" MEANS R-10 SHEATHING INSULATION OR R-13 CAVITY INSULATION
 ** INSULATION DEPTH WITH MONOLITHIC SLAB 2" OR WITH INSULATION GAP TO BOTTOM OF FOOTING. INSULATION DEPTH WITH STEM WALL SLAB 2" OR TO BOTTOM OF FOUNDATION WALL

DESIGNED FOR WIND SPEED OF 120 MPH, 3 SECOND GUST (93 FASTEST MILE) EXPOSURE 'B'

COMPONENT & CLADDING DESIGNED FOR THE FOLLOWING LOADS

MEAN ROOF	UP TO 30'	30'-1" TO 35'	35'-1" TO 40'	40'-1" TO 45'
ZONE 1	14.2	-15.0	14.9	-15.8
ZONE 2	14.2	-18.0	14.9	-18.9
ZONE 3	14.2	-18.0	14.9	-18.9
ZONE 4	15.5	-16.0	16.3	-16.8
ZONE 5	15.5	-20.0	16.3	-21.0

DESIGNED FOR WIND SPEED OF 120 MPH, 3 SECOND GUST (101 FASTEST MILE) EXPOSURE 'B'

COMPONENT & CLADDING DESIGNED FOR THE FOLLOWING LOADS

MEAN ROOF	UP TO 30'	30'-1" TO 35'	35'-1" TO 40'	40'-1" TO 45'
ZONE 1	16.7	-18.0	17.5	-18.9
ZONE 2	16.7	-21.0	17.5	-22.1
ZONE 3	16.7	-21.0	17.5	-22.1
ZONE 4	18.2	-19.0	19.1	-20.0
ZONE 5	18.2	-24.0	19.1	-25.2

ROOF VENTILATION

SECTION R806

SQUARE FOOTAGE OF ROOF TO BE VENTED = 2,111 SQ.FT.
 NET FREE CROSS VENTILATION NEEDED:
 WITHOUT 50% TO 80% OF VENTING 3'-0" ABOVE EAVE = 14.07 SQ.FT.
 WITH 50% TO 80% OF VENTING 3'-0" ABOVE EAVE; OR WITH CLASS 1 OR II VAPOR RETARDER ON WARM-IN-WINTER SIDE OF CEILING = 7.04 SQ.FT.

GUARD RAIL NOTES

SECTION R312

R312.1 Where required. Guards shall be located along open-sided walking surfaces, including stairs, ramps and landings, that are located more than 30 inches (762 mm) measured vertically to the floor or grade below at any point within 36 inches (914 mm) horizontally to the edge of the open side. Insect screening shall not be considered as a guard.
R312.2 Height. Required guards at open-sided walking surfaces, including stairs, porches, balconies or landings, shall be not less than 36 inches (914 mm) high measured vertically above the adjacent walking surface, adjacent fixed seating or the line connecting the leading edges of the treads.

Exceptions:

- Guards on the open sides of stairs shall have a height not less than 34 inches (864 mm) measured vertically from a line connecting the leading edges of the treads.
 - Where the top of the guard also serves as a handrail on the open sides of stairs, the top of the guard shall not be not less than 34 inches (864 mm) and not more than 38 inches (965 mm) measured vertically from a line connecting the leading edges of the treads.
- R312.3 Opening limitations.** Required guards shall not have openings from the walking surface to the required guard height which allow passage of a sphere 4 inches (102 mm) in diameter.

Exceptions:

- The triangular openings at the open side of a stair, formed by the riser, tread and bottom rail of a guard, shall not allow passage of a sphere 6 inches (153 mm) in diameter.
- Guards on the open sides of stairs shall not have openings which allow passage of a sphere 43/8 inches (111 mm) in diameter.

AIR LEAKAGE

Section N1102.4

N1102.4.1 Building thermal envelope. The building thermal envelope shall be durably sealed with an air barrier system to limit infiltration. The sealing methods between dissimilar materials shall allow for differential expansion and contraction. For all homes, where present, the following shall be caulked, gasketed, weather stripped or otherwise sealed with an air barrier material or solid material consistent with Appendix E-2.4 of this code:

- Blocking and sealing floor/ceiling systems and under knee walls open to unconditioned or exterior space.
- Capping and sealing shafts or chases, including flue shafts.
- Capping and sealing soffit or dropped ceiling areas.

NOTE:
MONO SLAB - STONE TO RUN TO THE BOTTOM OF WINDOW
STEM WALL - STONE TO FOUNDATION HEIGHT ONLY

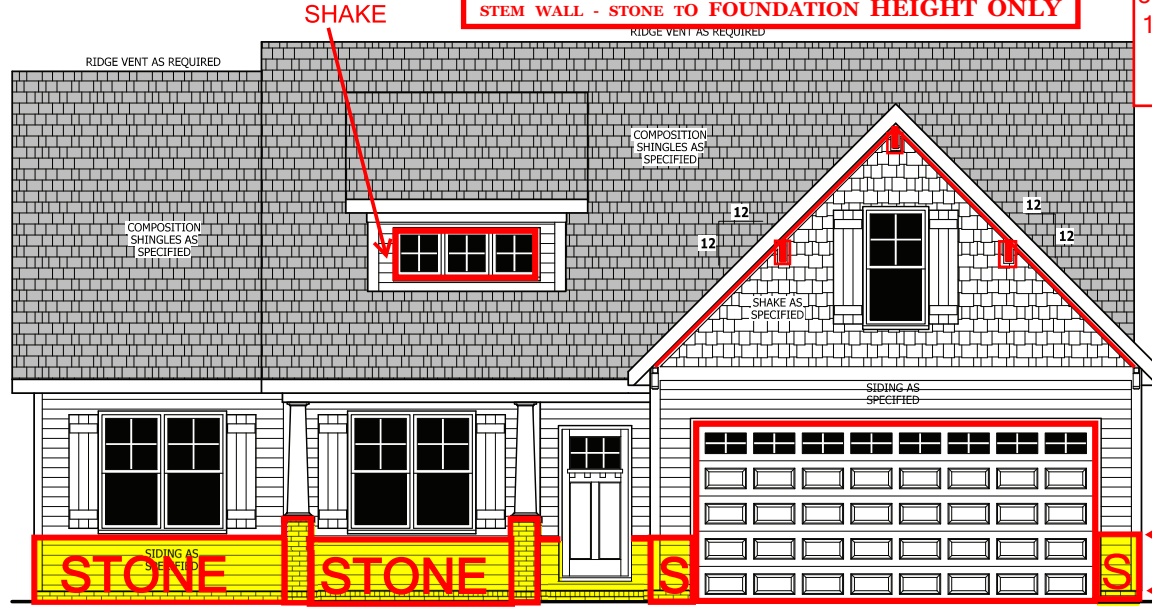

FRONT ELEVATION

SCALE 1/4" = 1'-0"

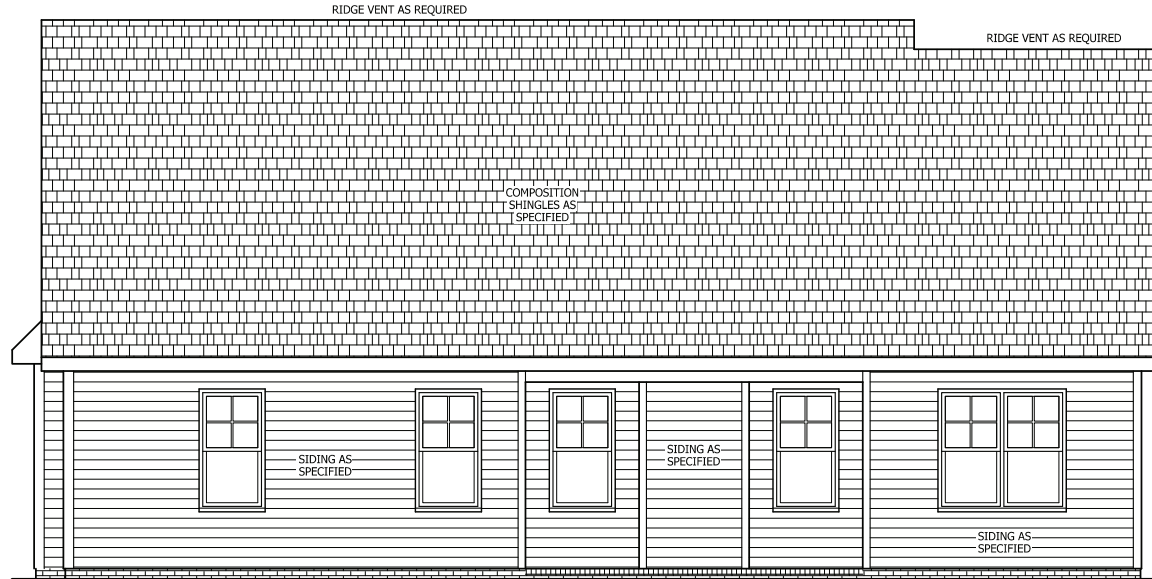

REAR ELEVATION

SCALE 1/4" = 1'-0"

**WEST POINTE III
 LOT 9
 3CG
 185 HILLWOOD DR.
 SANFORD, NC**

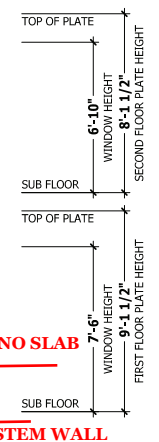

SQUARE FOOTAGE

HEATED	
FIRST FLOOR	1351 SQ.FT.
PLAYROOM	221 SQ.FT.
TOTAL	1572 SQ.FT.
HEATED OPTIONAL	
HALF BATH	28 SQ.FT.
TOTAL	28 SQ.FT.
UNHEATED	
FRONT PORCH	134 SQ.FT.
GARAGE	447 SQ.FT.
REAR PORCH	113 SQ.FT.
TOTAL	694 SQ.FT.
UNHEATED OPTIONAL	
THIRD GARAGE	307 SQ.FT.
TOTAL	307 SQ.FT.

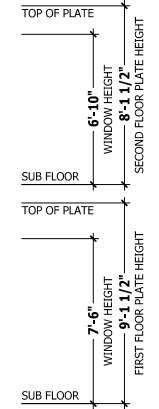

PURCHASER MUST VERIFY ALL DIMENSIONS AND CONDITIONS BEFORE CONSTRUCTION BEGINS. HAYNES HOME PLANS, INC. ASSUMES NO LIABILITY FOR CONTRACTORS PRACTICES AND PROCEDURES. CODES AND CONDITIONS MAY VARY WITH LOCATION. A LOCAL DESIGNER, ARCHITECT OR ENGINEER SHOULD BE CONSULTED BEFORE CONSTRUCTION. THESE DRAWINGS ARE INSTRUMENTS OF SERVICE AND AS SUCH SHALL REMAIN PROPERTY OF THE DESIGNER.

FRONT & REAR ELEVATIONS
SINCLAIR

HAYNES WEAVER HOMES
HOME PLANS, INC.
 910.630.2100 • 910.606.4696
 P.O. BOX 702, WAKE FOREST, NC 27588 919.455.4180 FAX 919.455.4099

SQUARE FOOTAGE	
HEATED	
FIRST FLOOR	1351 SQ.FT.
PLAYROOM	221 SQ.FT.
TOTAL	1572 SQ.FT.
HEATED OPTIONAL	
HALF BATH	28 SQ.FT.
TOTAL	28 SQ.FT.
UNHEATED	
FRONT PORCH	134 SQ.FT.
GARAGE	447 SQ.FT.
REAR PORCH	113 SQ.FT.
TOTAL	694 SQ.FT.
UNHEATED OPTIONAL	
THIRD GARAGE	307 SQ.FT.
TOTAL	307 SQ.FT.

© Copyright 2019
 Haynes Home Plans, Inc.
3/6/2020
190320B
PAGE 1 OF 8

\\ARCHIVE\Archive\Builder\Weaver Development Company, Inc.\200309B Sinclair\200309B Sinclair - Right.aec

3 CAR GARAGE

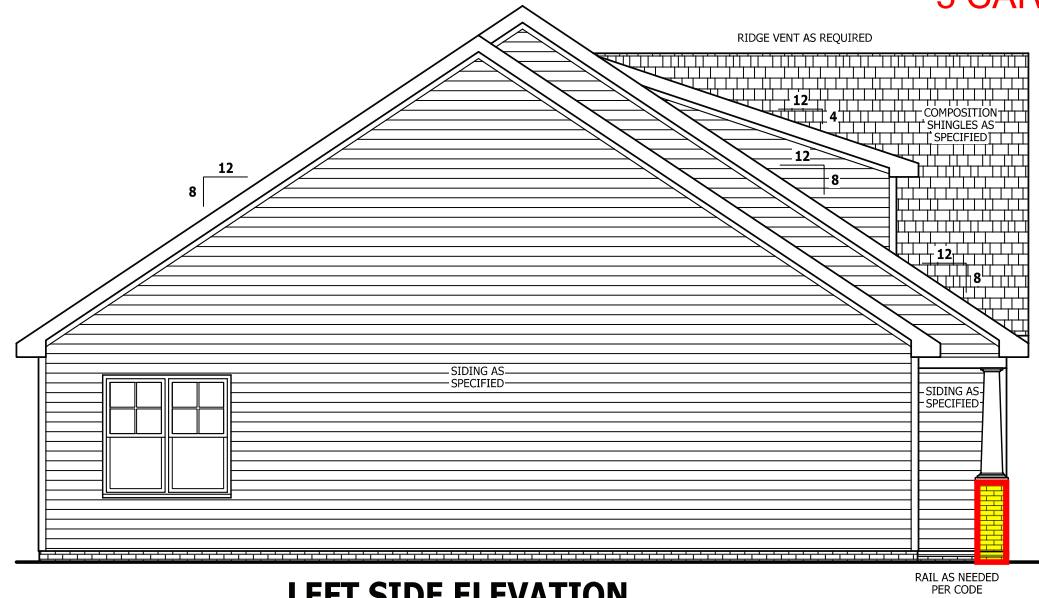

LEFT SIDE ELEVATION

SCALE 1/4" = 1'-0"

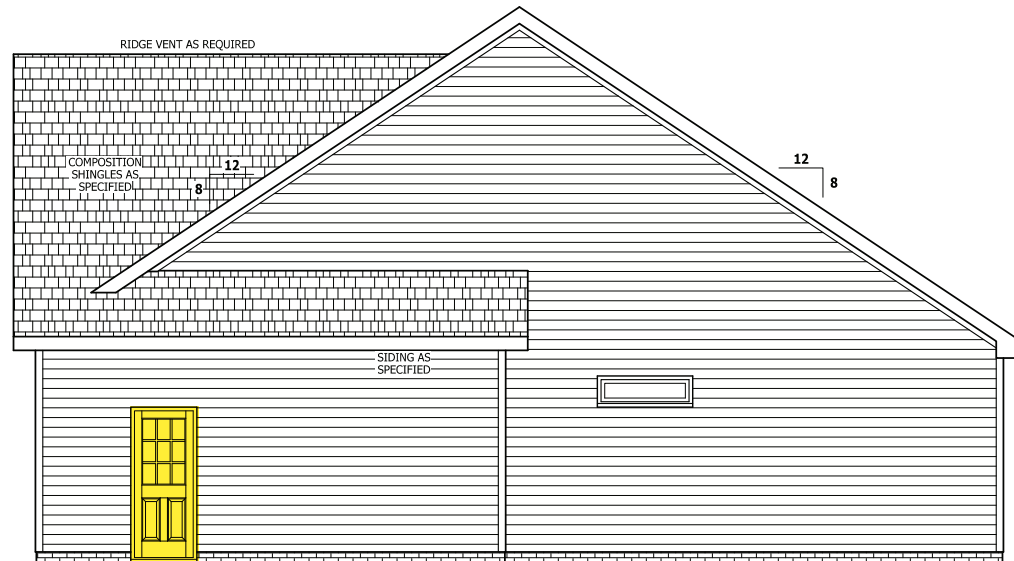
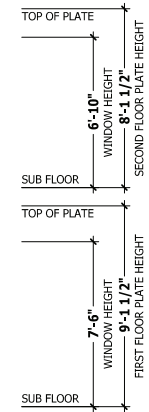

RIGHT SIDE ELEVATION

SCALE 1/4" = 1'-0"

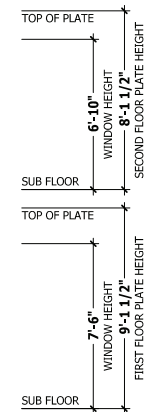

PURCHASER MUST VERIFY ALL DIMENSIONS AND CONDITIONS BEFORE CONSTRUCTION BEGINS. HAYNES HOME PLANS, INC. ASSUMES NO LIABILITY FOR CONTRACTORS PRACTICES AND PROCEDURES. CODES AND CONDITIONS MAY VARY WITH LOCATION. A LOCAL DESIGNER, ARCHITECT OR ENGINEER SHOULD BE CONSULTED BEFORE CONSTRUCTION. THESE DRAWINGS ARE INSTRUMENTS OF SERVICE AND AS SUCH SHALL REMAIN PROPERTY OF THE DESIGNER.

LEFT & RIGHT ELEVATIONS
SINCLAIR

WEAVER HOMES
910.630.2100 • 910.606.4696
250 Weaver Drive, Fayetteville, NC 28304

HAYNES HOME PLANS, INC.
P.O. Box 702, Wake Forest, NC 27588 919-435-4180 Fax: 919-435-4099

SQUARE FOOTAGE	
HEATED	
FIRST FLOOR	1351 SQ. FT.
PLAYROOM	221 SQ. FT.
TOTAL	1572 SQ. FT.
HEATED OPTIONAL	
HALF BATH	28 SQ. FT.
TOTAL	28 SQ. FT.
UNHEATED	
POCKET PORCH	124 SQ. FT.
GARAGE	442 SQ. FT.
REAR PORCH	113 SQ. FT.
TOTAL	679 SQ. FT.
UNHEATED OPTIONAL	
100SQ GARAGE	307 SQ. FT.
TOTAL	307 SQ. FT.

3 CAR GARAGE

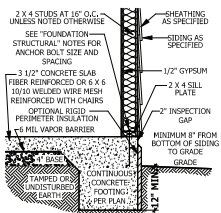

A MONOLITHIC SECTION
SCALE 1/2" = 1'-0"

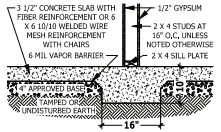

B LUG FOOTING SECTION
SCALE 1/2" = 1'-0"

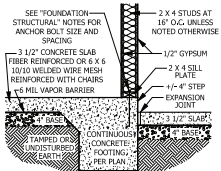

C MONOLITHIC AT STEP
SCALE 1/2" = 1'-0"

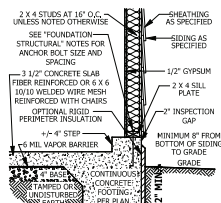

D MONOLITHIC AT GARAGE
SCALE 1/2" = 1'-0"

FOUNDATION STRUCTURAL

115 to 130 mph wind zone (1 1/2 to 2 1/2 story)
CONTINUOUS FOOTING: 16" wide and 8" thick minimum, 20" wide minimum at brick veneer. Must extend 2" to either side of supported wall.
GIRDERS: (3) 2 X 10 girder unless noted otherwise.
PIERS: 16" X 16" piers with 8" solid masonry cap on 30" X 30" X 10" concrete footing with maximum pier height of 64" with hollow masonry and 160" with solid masonry.
POINT LOADS: ■ designates significant point load and should have solid blocking to pier, girder or foundation wall.
115 and 120 MPH ANCHORS BOLTS: 1/2" diameter anchor bolts embedded minimum 7", maximum 6'-0" on center, within 12" of plate ends, and minimum two anchor bolts per plate.
130 MPH ANCHORS BOLTS: 1/2" diameter anchor bolts embedded minimum 15", maximum 4'-0" on center, within 12" of plate ends, and minimum two anchor bolts per plate.
CONCRETE: Concrete shall have a minimum 28 day strength of 3000 psi and a maximum 5" slump. Air entrained per table 402.2. All concrete shall be in accordance with ACI standards. All samples for pumpcrete shall be taken from the exit end of the pump.
SOILS: Allowable soil bearing pressure assumed to be 2000 PSF. The contractor must contact a geotechnical engineer and a structural engineer if unsatisfactory subsurface conditions are encountered. The surface area adjacent to the foundation wall shall be provided with adequate drainage, and shall be graded so as to drain surface water away from foundation walls.

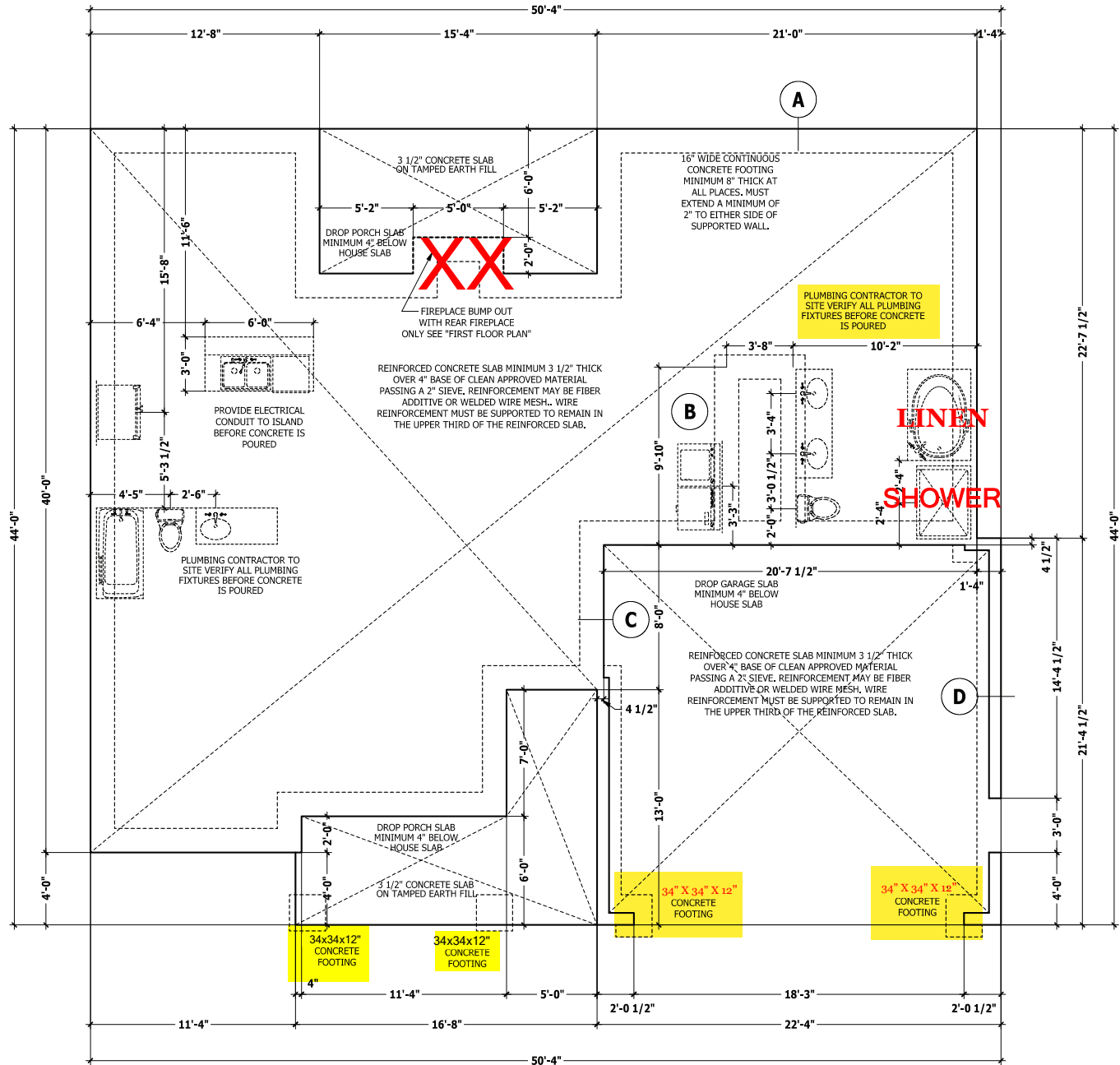

MONOLITHIC SLAB PLAN

SCALE 1/4" = 1'-0"

PURCHASER MUST VERIFY ALL DIMENSIONS AND CONDITIONS BEFORE CONSTRUCTION BEGINS. HAYNES HOME PLANS, INC. ASSUMES NO LIABILITY FOR CONTRACTORS PRACTICES AND PROCEDURES. CODES AND CONDITIONS MAY VARY WITH LOCATION. A LOCAL DESIGNER, ARCHITECT OR ENGINEER SHOULD BE CONSULTED BEFORE CONSTRUCTION. THESE DRAWINGS ARE INSTRUMENTS OF SERVICE AND AS SUCH SHALL REMAIN PROPERTY OF THE DESIGNER.

MONOLITHIC SLAB PLAN
SINCLAIR

HAYNES WE AVER
HOME PLANS, INC.
910.630.2100 • 910.606.4696
P.O. Box 702, Wake Forest, NC 27588 919.435.4180 FAX 919.435.4099

SQUARE FOOTAGE	
HEATED	
FIRST FLOOR	1351 SQ.FT.
PLAYROOM	221 SQ.FT.
TOTAL	1572 SQ.FT.
HEATED OPTIONAL	
HALF BATH	28 SQ.FT.
TOTAL	28 SQ.FT.
UNHEATED	
FRONT PORCH	124 SQ.FT.
GARAGE	442 SQ.FT.
REAR PORCH	113 SQ.FT.
TOTAL	679 SQ.FT.
UNHEATED OPTIONAL	
1/2RD GARAGE	307 SQ.FT.
TOTAL	307 SQ.FT.

DWELLING / GARAGE SEPARATION

REFER TO SECTIONS R302.5, R302.6, AND R302.7

WALLS. A minimum 1/2" gypsum board must be installed on all walls supporting floor/ceiling assemblies used for separation required by this section.
STAIRS. A minimum of 1/2" gypsum board must be installed on the underside and exposed sides of all stairways.

CEILING. A minimum of 1/2" gypsum must be installed on the garage ceiling if there are no habitable room above the garage. If there are habitable room above the garage a minimum of 5/8" type X gypsum board must be installed on the garage ceiling.
OPENING PENETRATIONS. Openings between the garage and residence shall be equipped with solid wood doors not less than 1 3/8 inches (35 mm) in thickness, solid or honeycomb core steel doors not less than 1 3/8 inches (35 mm) thick, or 20-minute fire-rated doors.

DUCT PENETRATIONS. Ducts in the garage and ducts penetrating the walls or ceilings separating the dwelling from the garage shall be constructed of a minimum No. 26 gage (0.48 mm) sheet steel or other approved material and shall have no openings into the garage.

OTHER PENETRATIONS. Penetrations through the separation required in Section R302.6 shall be protected as required by Section R302.11, Item 4.

3 CAR GARAGE

PURCHASER MUST VERIFY ALL DIMENSIONS AND CONDITIONS BEFORE CONSTRUCTION BEGINS. HAYNES HOME PLANS, INC. ASSUMES NO LIABILITY FOR CONTRACTORS PRACTICES AND PROCEDURES. CODES AND CONDITIONS MAY VARY WITH LOCATION. A LOCAL DESIGNER, ARCHITECT OR ENGINEER SHOULD BE CONSULTED BEFORE CONSTRUCTION. THESE DRAWINGS ARE INSTRUMENTS OF SERVICE AND AS SUCH SHALL REMAIN PROPERTY OF THE DESIGNER.

FIRST FLOOR PLAN
SINCLAIR

WEAVER HOMES
 910.630.2100 • 910.606.4696

HAYNES HOME PLANS, INC.
 P.O. BOX 702, HAME FOREST, NC 27538 919.435.1180 FAX 919.435.0999

SQUARE FOOTAGE	
HEATED	
FIRST FLOOR	1351 SQ.FT.
PLAYROOM	221 SQ.FT.
TOTAL	1572 SQ.FT.
HEATED OPTIONAL	
HALF BATH	28 SQ.FT.
TOTAL	28 SQ.FT.
UNHEATED	
FRONT PORCH	134 SQ.FT.
GARAGE	447 SQ.FT.
REAR PORCH	113 SQ.FT.
TOTAL	694 SQ.FT.
UNHEATED OPTIONAL	
THIRD GARAGE	307 SQ.FT.
TOTAL	307 SQ.FT.

© Copyright 2019
 Haynes Home Plans, Inc.
3/6/2020
190320B
PAGE 4 OF 8

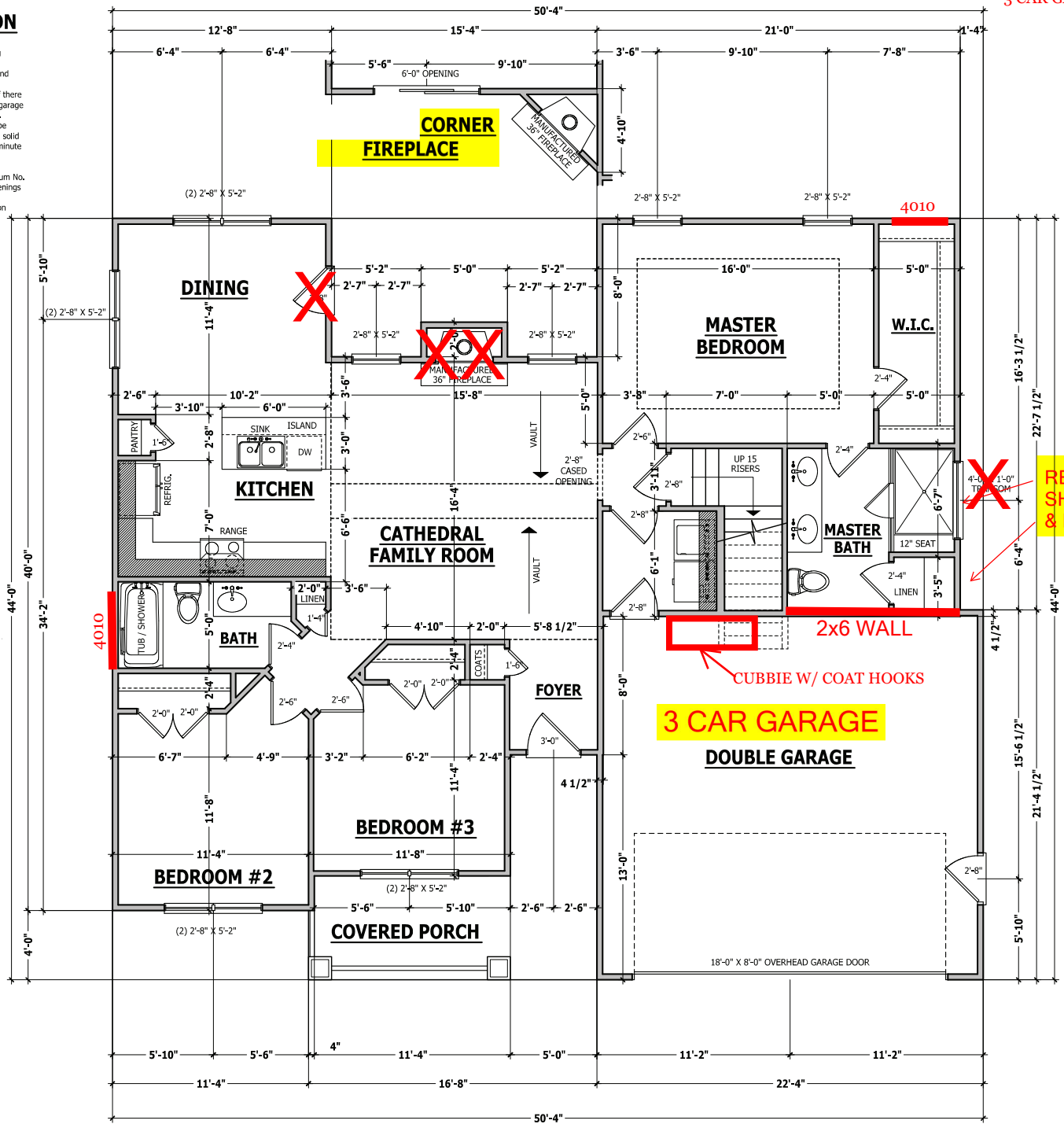

FIRST FLOOR PLAN

SCALE 1/4" = 1'-0"

WALL THICKNESSES

Exterior walls and walls adjacent to a garage area are drawn as 4" or as noted 2 X 6 are drawn as 6" to include 1/2" sheathing or gypsum. Subtract 1/2" for stud face.
Interior walls are drawn as 3 1/2" or as noted 2 X 6 are drawn as 5 1/2", and do not include gypsum.

SQUARE FOOTAGE

HEATED	
FIRST FLOOR	1351 SQ.FT.
PLAYROOM	221 SQ.FT.
TOTAL	1572 SQ.FT.
HEATED OPTIONAL	
HALF BATH	28 SQ.FT.
TOTAL	28 SQ.FT.
UNHEATED	
FRONT PORCH	134 SQ.FT.
GARAGE	447 SQ.FT.
REAR PORCH	113 SQ.FT.
TOTAL	694 SQ.FT.
UNHEATED OPTIONAL	
THIRD GARAGE	307 SQ.FT.
TOTAL	307 SQ.FT.

\\ARCHIVE\Archive\Builder\Weaver Development Company, Inc.\200309B Sinclair\200309B Sinclair - Right.aec

STRUCTURAL NOTES

All construction shall conform to the latest requirements of the 2018 North Carolina Residential Building Code, plus all local codes and regulations. This document in no way shall be construed to supersede the code.

JOB SITE PRACTICES AND SAFETY: Haynes Home Plans, Inc. assumes no liability for contractor practices and procedures or safety program. Haynes Home Plans, Inc. takes no responsibility for the contractor's failure to carry out the construction work in accordance with the contract documents. All members shall be framed, anchored, and braced in accordance with good construction practice and the building code.

DESIGN LOADS	LIVE LOAD (PSF)	DEAD LOAD (PSF)	DEFLECTION (LL)
Attics without storage	10	10	L/240
Attics with limited storage	20	10	L/360
Attics with fixed stairs	40	10	L/360
Balconies and decks	40	10	L/360
Fire escapes	40	10	L/360
Guardrails and handrails	200	—	—
Guardrail in-fill components	50	—	—
Passenger vehicle garages	50	10	L/360
Rooms other than sleeping	40	10	L/360
Sleeping rooms	30	10	L/360
Stairs	40	—	L/360
Snow	20	—	—

FRAMING LUMBER: All non treated framing lumber shall be SPF #2 (Fb = 875 PSI) or SYP #2 (Fb = 750 PSI) and all treated lumber shall be SYP #2 (Fb = 750 PSI) unless noted other wise.

ENGINEERED WOOD BEAMS

Laminated veneer lumber (LVL) = Fb=2600 PSI, Fv=285 PSI, E=1.9x10⁶ PSI
 Parallel strand lumber (PSL) = Fb=2900 PSI, Fv=290 PSI, E=2.0x10⁶ PSI
 Laminated strand lumber (LSL) Fb=2250 PSI, Fv=400 PSI, E=1.55x10⁶ PSI
 Install all connections per manufacturers instructions.

TRUSS AND I-JOIST MEMBERS:

All roof truss and I-joist layouts shall be prepared in accordance with this document. Trusses and I-joists shall be installed according to the manufacturer's specifications. Any change in truss or I-joist layout shall be coordinated with Haynes Homes Plans, Inc.

LINTELS: Brick lintels shall be 3 1/2" x 3 1/2" x 1/4" steel angle for up to 6'-0" span, 6" x 4" x 5/16" steel angle with 6" leg vertical for spans up to 9'-0" unless noted otherwise. 3 1/2" x 3 1/2" x 1/4" steel angle with 1/2" bolts at 2'-0" on center for spans up to 18'-0" unless noted otherwise.

FLOOR SHEATHING: OSB or CDX floor sheathing minimum 1/2" thick for 16" on center joist spacing, minimum 5/8" thick for 19.2" on center joist spacing, and minimum 3/4" thick for 24" on center joist spacing.

ROOF SHEATHING: OSB or CDX roof sheathing minimum 3/8" thick for 16" on center rafters and 7/16" for 24" on center rafters.

CONCRETE AND SOILS: See foundation notes.

BRACE WALL PANEL NOTES

EXTERIOR WALLS: All exterior walls to be sheathed with CS-WSP or CS-SFB in accordance with section R602.10.3 unless noted otherwise.

GYPSUM: All interior sides of exterior walls and both sides interior walls to have 1/2" gypsum installed. When not using method GB gypsum to be fastened per table R702.3.5. Method GB to be fastened per table R602.10.1.

REQUIRED LENGTH OF BRACING: Required brace wall length for each side of the circumscribed rectangle are interpolated per table R602.10.3. Methods CS-WSP and CS-SFB contribute their actual length. Method GB contributes 0.5 it's actual length. Method PF contributes 1.5 times its actual length.

HD: 800 lbs hold down hold down device fastened to the edge of the brace wall panel closets to the corner.

Methods Per Table R602.10.1

CS-WSP: Shall be minimum 3/8" OSB or CDX nailed at 6" on center at edges and 12" on center at intermediate supports with 5d common nails or 8d(2 1/2" long x 0.113" diameter).

CS-SFB: Shall be minimum 1/2" structural fiber board nailed at 3" on center at edges and 3" on center at intermediate supports with 1 1/2" long x 0.12" diameter galvanized roofing nails.

GB: Interior walls show as GB are to have minimum 1/2" gypsum board on both sides of the wall fastened at 7" on center at edges and 7" on center at intermediate supports with minimum 5d cooler nails or #6 screws.

PF: Portal frame per figure R602.10.1

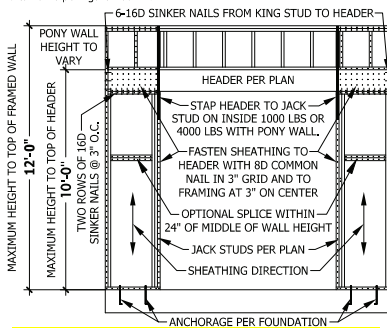

PF PORTAL FRAME AT OPENING

(METHOD PF PER FIGURE AND SECTION R602.10.1)

SCALE 1/4" = 1'-0"

EXTERIOR HEADERS

-(2) 2 X 6 WITH 1 JACK STUD EACH END

- KING STUDS EACH END

UNLESS NOTED OTHERWISE

HEADER SPAN < 3' 3'-4' 4'-8' 8'-12' 12'-16'

KING STUD(S) 1 2 3 5 6

INTERIOR HEADERS

- LOAD BEARING HEADERS (2) 2 X 6 WITH

1 JACK STUD AND 1 KING STUD EACH END

UNLESS NOTED OTHERWISE

- NON LOAD BEARING HEADERS TO BE

LADDER FRAMED

OPTIONAL CORNER FIREPLACE

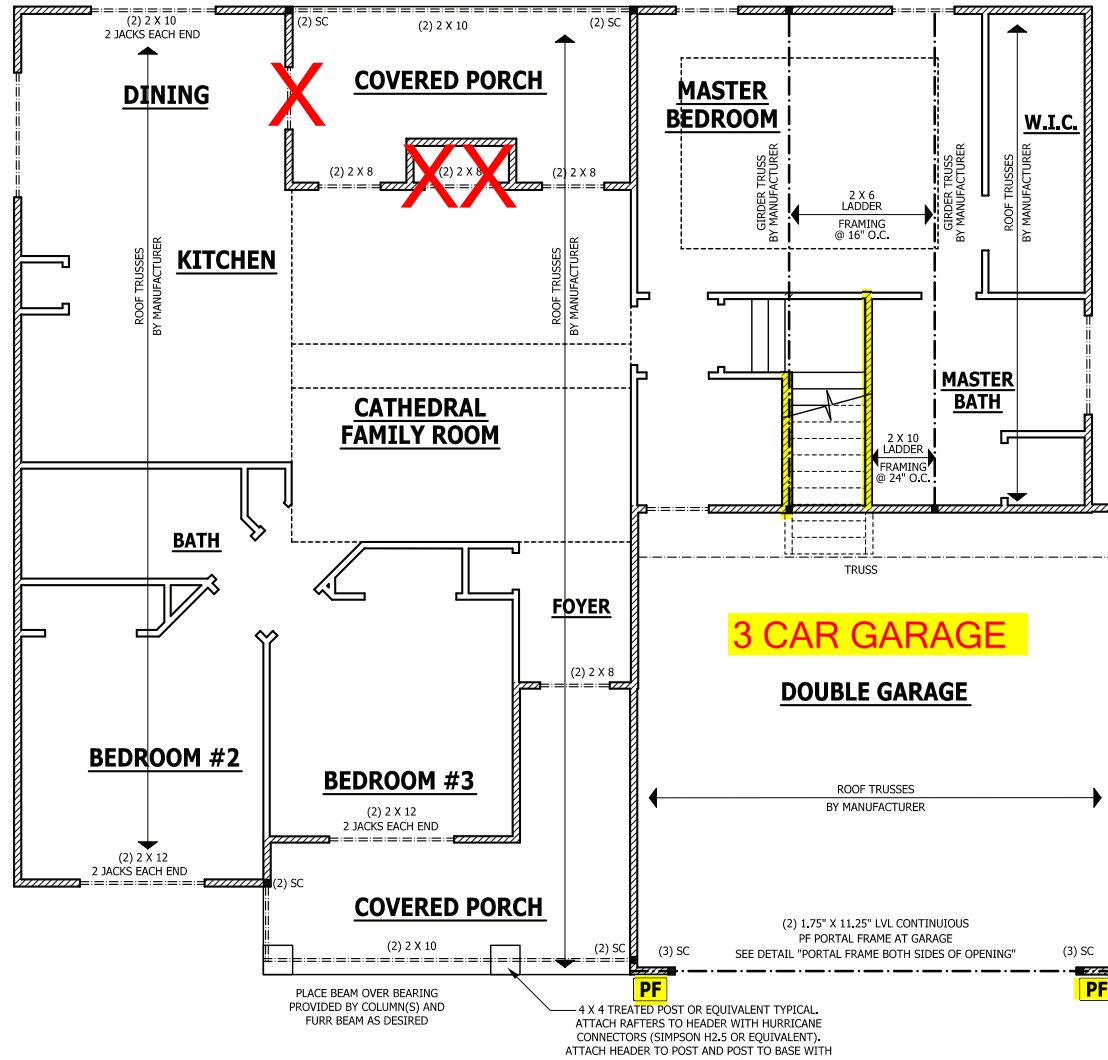

FIRST FLOOR STRUCTURAL

SCALE 1/4" = 1'-0"

ROOF TRUSS REQUIREMENTS

TRUSS DESIGN: Trusses to be designed and engineered in accordance with these drawings. Any variation with these drawings must be brought to Haynes Home Plans, Inc. attention before construction begins.

KNEE WALL AND CEILING HEIGHTS: All finished knee wall heights and ceiling heights are shown furred down 10" from roof decking for insulation. If for any reason the truss manufacturer fails to meet or exceed designated heel heights, finished knee wall heights, or finished ceiling heights shown on these drawings the finished square footage may vary. Any discrepancy must be brought to Haynes Home Plans, Inc. attention, so a suitable solution can be reached before construction begins. Any variation due to these conditions not being met is the responsibility of the truss manufacturer.

ANCHORAGE: All required anchors for trusses due to uplift or bearing shall meet the requirements as specified on the truss schematics.

BEARING: All trusses shall be designed for bearing on SPF #2 plates or ledgers unless noted otherwise.

Plate Heights & Floor Systems: See elevation page(s) for plate heights and floor system thicknesses.

FIRST FLOOR STRUCTURAL

SINCLAIR

HAYNES WEAVER
HOME PLANS, INC.
 P.O. BOX 702, WAKE FOREST, NC 27588 919-435-4180 FAX 919-435-9189
 910.630.2100 • 910.606.4696
 © Haynes Home Plans, Inc. 2019

SQUARE FOOTAGE	
HEATED	1351 SQ.FT.
FRST FLOOR	222 SQ.FT.
PLAYROOM	129 SQ.FT.
TOTAL	1699 SQ.FT.
HEATED OPTIONAL	
FRST FLOOR	28 SQ.FT.
HALF BATH	28 SQ.FT.
TOTAL	56 SQ.FT.
UNHEATED	
FRONT PORCH	124 SQ.FT.
GARAGE	442 SQ.FT.
REAR PORCH	113 SQ.FT.
TOTAL	679 SQ.FT.
UNHEATED OPTIONAL	
FRST GARAGE	307 SQ.FT.
TOTAL	307 SQ.FT.

© Copyright 2019

Haynes Home Plans, Inc.

3/6/2020

190320B

PAGE 5 OF 8

STRUCTURAL NOTES

All construction shall conform to the latest requirements of the 2018 North Carolina Residential Building Code, plus all local codes and regulations. This document in no way shall be construed to supersede the code.
JOB SITE PRACTICES AND SAFETY: Haynes Home Plans, Inc. assumes no liability for contractor practices and procedures or safety program. Haynes Home Plans, Inc. takes no responsibility for the contractor's failure to carry out the construction work in accordance with the contract documents. All members shall be framed, anchored, and braced in accordance with good construction practice and the building code.

DESIGN LOADS	LIVE LOAD (PSF)	DEAD LOAD (PSF)	DEFLECTION (LL)
Attics without storage	10	-	L/240
Attics with limited storage	20	10	L/360
Attics with fixed stairs	40	10	L/360
Balconies and decks	40	10	L/360
Fire escapes	40	10	L/360
Guardrails and handrails	200	-	-
Guardrail in-fill components	50	-	-
Passenger vehicle garages	50	10	L/360
Rooms other than sleeping	40	10	L/360
Sleeping rooms	30	10	L/360
Stairs	40	-	L/360
Snow	20	-	-

FRAMING LUMBER: All non treated framing lumber shall be SPF #2 (Fb = 875 PSI) or SYP #2 (Fb = 750 PSI) and all treated lumber shall be SYP #2 (Fb = 750 PSI) unless noted otherwise.

ENGINEERED WOOD BEAMS:
 Laminated veneer lumber (LVL) = Fb=2600 PSI, Fv=285 PSI, E=1.9x10⁶ PSI
 Parallel strand lumber (PSL) = Fb=2900 PSI, Fv=290 PSI, E=2.0x10⁶ PSI
 Laminated strand lumber (LSL) Fb=2250 PSI, Fv=400 PSI, E=1.55x10⁶ PSI
 Install all connections per manufacturer's instructions.

TRUSS AND I-JOIST MEMBERS: All roof truss and I-joist layouts shall be prepared in accordance with this document. Trusses and I-joists shall be installed according to the manufacturer's specifications. Any change in truss or I-joist layout shall be coordinated with Haynes Home Plans, Inc.

LINTELS: Brick lintels shall be 3 1/2" x 3 1/2" x 1/4" steel angle for up to 6'-0" span, 6" x 4" x 5/16" steel angle with 6" leg vertical for spans up to 9'-0" unless noted otherwise, 3 1/2" x 2 1/2" x 1/4" steel angle with 1/2" bolts at 2'-0" on center for spans up to 18'-0" unless noted otherwise.

FLOOR SHEATHING: OSB or CDX floor sheathing minimum 1/2" thick for 16" on center joist spacing, minimum 5/8" thick for 19.2" on center joist spacing, and minimum 3/4" thick for 24" on center joist spacing.

ROOF SHEATHING: OSB or CDX roof sheathing minimum 3/8" thick for 16" on center rafters and 7/16" for 24" on center rafters.

CONCRETE AND SOILS: See foundation notes.

ROOF TRUSS REQUIREMENTS

TRUSS DESIGN: Trusses to be designed and engineered in accordance with these drawings. Any variation with these drawings must be brought to Haynes Home Plan, Inc. attention before construction begins.

KNEE WALL AND CEILING HEIGHTS. All finished knee wall heights and ceiling heights are shown furred down 10" from roof decking for insulation. If for any reason the truss manufacturer fails to meet or exceed designated heel heights, finished knee wall heights, or finished ceiling heights shown on these drawings the finished square footage may vary. Any discrepancy must be brought to Haynes Home Plans, Inc. attention, so a suitable solution can be reached before construction begins. Any variation due to these conditions not being met is the responsibility of the truss manufacturer.

ANCHORAGE. All required anchors for trusses due to uplift or bearing shall meet the requirements as specified on the truss schematics.

BEARING. All trusses shall be designed for bearing on SPF #2 plates or ledgers unless noted otherwise.

Plate Heights & Floor Systems. See elevation page(s) for plate heights and floor system thicknesses.

EXTERIOR HEADERS

- (2) 2 X 6 WITH 1 JACK STUD EACH END UNLESS NOTED OTHERWISE

- KING STUDS EACH END PER TABLE BELOW

HEADER SPAN	< 3'	3'-4'	4'-8'	8'-12'	12'-16'
KING STUD(S)	1	2	3	5	6

INTERIOR HEADERS

- LOAD BEARING HEADERS (2) 2 X 6 WITH 1 JACK STUD AND 1 KING STUD EACH END UNLESS NOTED OTHERWISE

- NON LOAD BEARING HEADERS TO BE LADDER FRAMED

ATTIC ACCESS

SECTION R807

R807.1 Attic access. An attic access opening shall be provided to attic areas that exceed 400 square feet (37.16 m²) and have a vertical height of 60 inches (1524 mm) or greater. The net clear opening shall not be less than 20 inches by 30 inches (508 mm by 762 mm) and shall be located in a hallway or other readily accessible location. A 30-inch (762 mm) minimum unobstructed headroom in the attic space shall be provided at some point above the access opening. See Section M1305.1.3 for access requirements where mechanical equipment is located in attics.

Exceptions:

1. Concealed areas not located over the main structure including porches, areas behind knee walls, dormers, bay windows, etc. are not required to have access.
2. Pull down stair treads, stringers, handrails, and hardware may protrude into the net clear opening.

WALL THICKNESSES

Exterior walls and walls adjacent to a garage area are drawn as 4" or as noted 2 X 6 are drawn as 6" to include 1/2" sheathing or gypsum. Subtract 1/2" for stud face.

Interior walls are drawn as 3 1/2" or as noted 2 X 6 are drawn as 5 1/2", and do not include gypsum.

3 CAR GARAGE

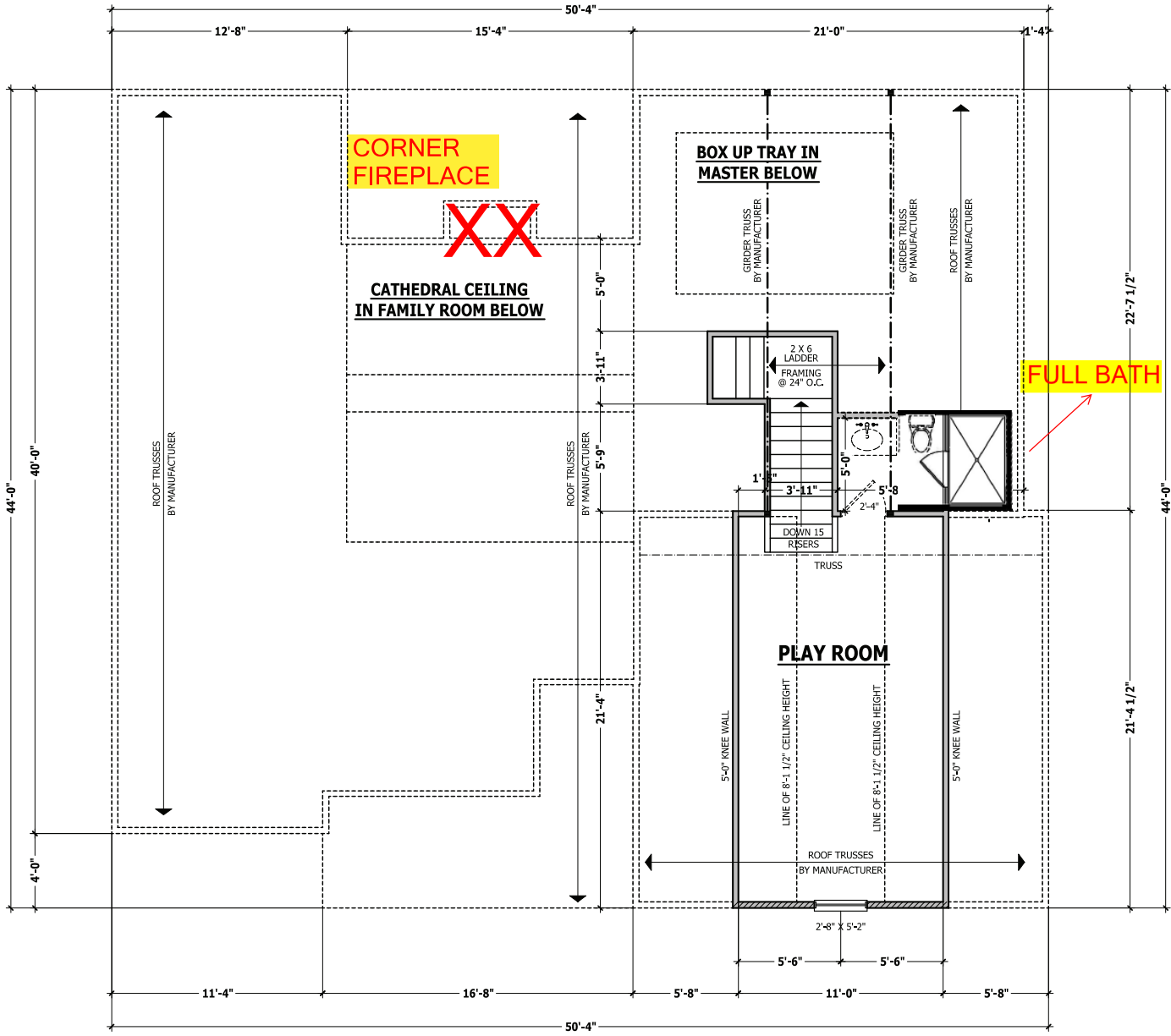

SECOND FLOOR PLAN

SCALE 1/4" = 1'-0"

PURCHASER MUST VERIFY ALL DIMENSIONS AND CONDITIONS BEFORE CONSTRUCTION BEGINS. HAYNES HOME PLANS, INC. ASSUMES NO LIABILITY FOR CONTRACTOR'S PRACTICES AND PROCEDURES. CODES AND CONDITIONS MAY VARY WITH LOCATION. A LOCAL DESIGNER, ARCHITECT, OR ENGINEER SHOULD BE CONSULTED BEFORE CONSTRUCTION. THESE DRAWINGS ARE INSTRUMENTS OF SERVICE AND AS SUCH SHALL REMAIN PROPERTY OF THE DESIGNER.

SECOND FLOOR PLAN

SINCLAIR

HAYNES WEAVER HOMES
 HOME PLANS, INC.
 P.O. BOX 702, WAKE FOREST, NC 27588 919-435-4180 FAX 919-435-4099

SQUARE FOOTAGE	
HEATED	
FIRST FLOOR	351 SQ. FT.
PLAYROOM	221 SQ. FT.
TOTAL	572 SQ. FT.
HEATED OPTIONAL	
HALF BATH	28 SQ. FT.
TOTAL	29 SQ. FT.
UNHEATED	
RIGHT PORCH	124 SQ. FT.
GARAGE	442 SQ. FT.
REAR PORCH	694 SQ. FT.
TOTAL	694 SQ. FT.
UNHEATED OPTIONAL	
1/2 CAR GARAGE	307 SQ. FT.
TOTAL	307 SQ. FT.

© Copyright 2019 Haynes Home Plans, Inc.

3/6/2020

190320B

PAGE 6 OF 8

3 CAR GARAGE

ROOF TRUSS REQUIREMENTS

TRUSS DESIGN. Trusses to be designed and engineered in accordance with these drawings. Any variation with these drawings must be brought to Haynes Home Plans, Inc. attention before construction begins.
KNEE WALL AND CEILING HEIGHTS. All finished knee wall heights and ceiling heights are shown furred down 10" from roof decking for insulation. If for any reason the truss manufacturer fails to meet or exceed designated heel heights, finished knee wall heights, or finished ceiling heights shown on these drawings the finished square footage may vary. Any discrepancy must be brought to Haynes Home Plans, Inc. attention, so a suitable solution can be reached before construction begins. Any variation due to these conditions not being met is the responsibility of the truss manufacturer.

ANCHORAGE. All required anchors for trusses due to uplift or bearing shall meet the requirements as specified on the truss schematics.
BEARING. All trusses shall be designed for bearing on SPF #2 plates or ledgers unless noted otherwise.

Plate Heights & Floor Systems. See elevation page(s) for plate heights and floor system thicknesses.

- HEEL HEIGHT ABOVE FIRST FLOOR PLATE
- HEEL HEIGHT ABOVE SECOND FLOOR PLATE

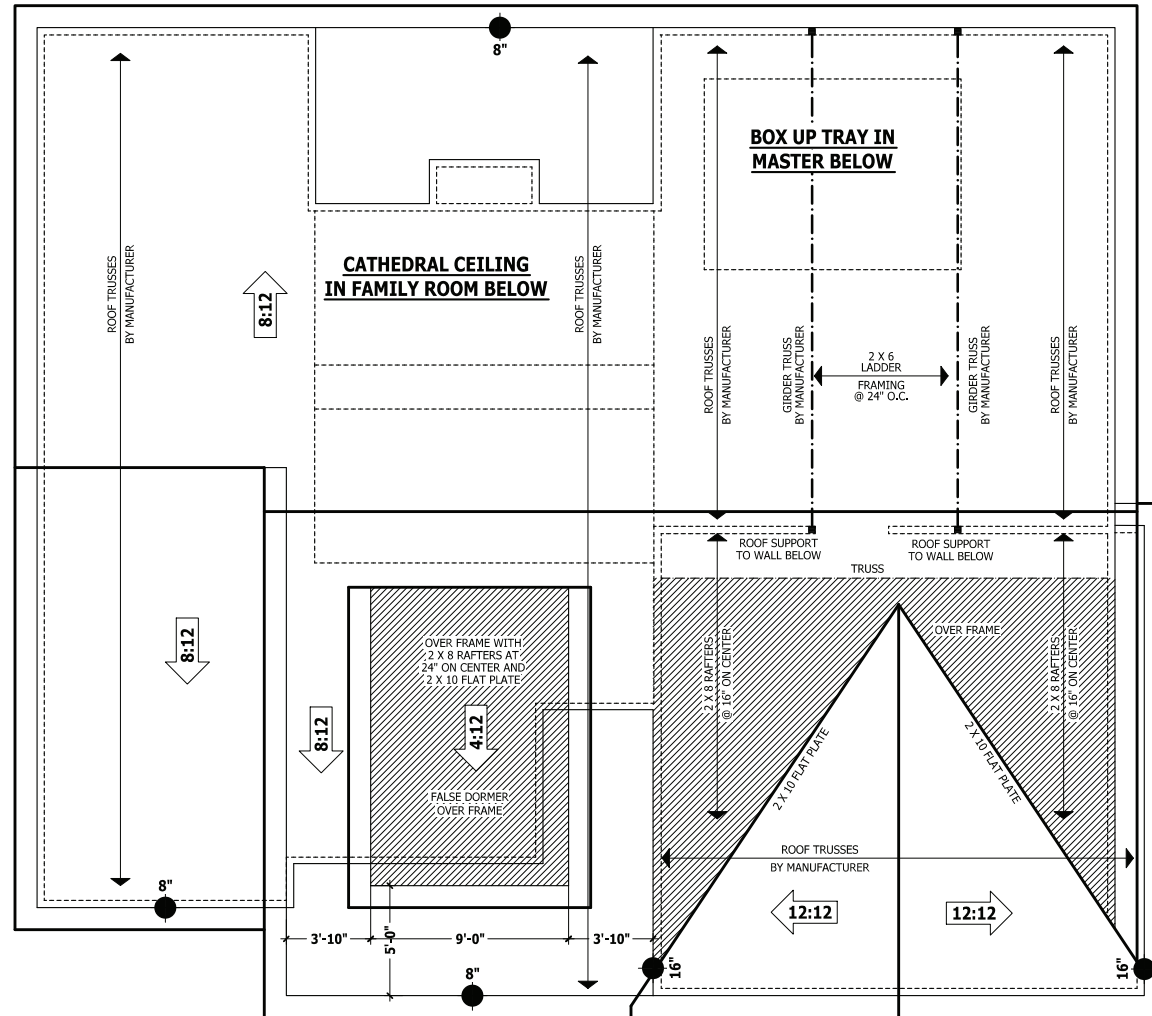

ROOF PLAN

SCALE 1/4" = 1'-0"

PURCHASER MUST VERIFY ALL DIMENSIONS AND CONDITIONS BEFORE CONSTRUCTION BEGINS. HAYNES HOME PLANS, INC. ASSUMES NO LIABILITY FOR CONTRACTORS PRACTICES AND PROCEDURES. CODES AND CONDITIONS MAY VARY WITH LOCALITY. A LOCAL DESIGNER, ARCHITECT OR ENGINEER SHOULD BE CONSULTED BEFORE CONSTRUCTION. THESE DRAWINGS ARE INSTRUMENTS OF SERVICE AND AS SUCH SHALL REMAIN PROPERTY OF THE DESIGNER.

ROOF PLAN
SINCLAIR

WEAVER HOMES
 910.630.2100 • 910.606.4696
250 Weaver Drive, Fayetteville, NC 28404

HAYNES HOME PLANS, INC.
P.O. Box 702, Wake Forest, NC 27588 919.435.4180 Fax 919.435.4099

SQUARE FOOTAGE	
HEATED	3351 SQ.FT.
FIRST FLOOR	221 SQ.FT.
PLAYROOM	222 SQ.FT.
TOTAL	272 SQ.FT.
HEATED OPTIONAL	50 SQ.FT.
HALF BATH	28 SQ.FT.
TOTAL	28 SQ.FT.
UNHEATED	124 SQ.FT.
FRONT PORCH	442 SQ.FT.
REAR PORCH	113 SQ.FT.
TOTAL	694 SQ.FT.
UNHEATED OPTIONAL	30 SQ.FT.
1/2RD GARAGE	307 SQ.FT.
TOTAL	307 SQ.FT.

© Copyright 2019
 Haynes Home Plans, Inc.
3/6/2020
190320B
PAGE 7 OF 8

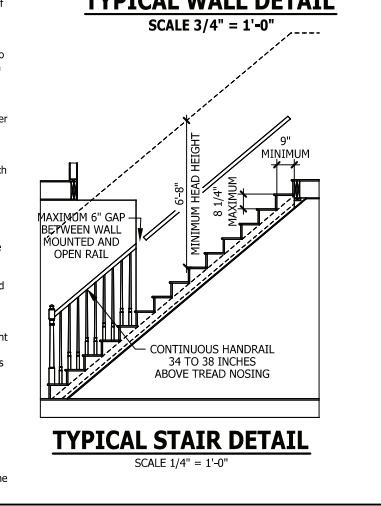
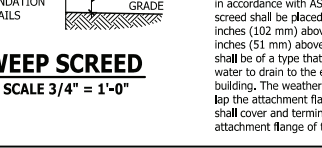
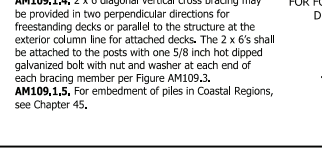
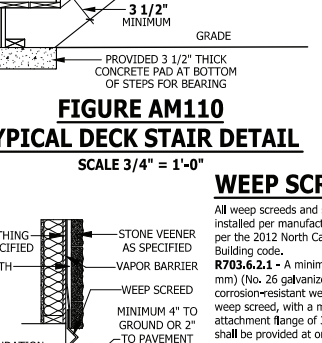
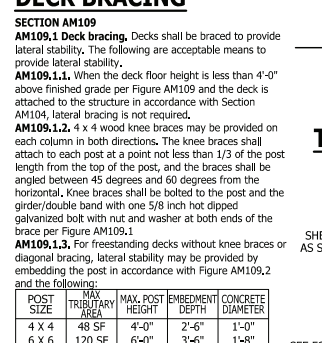
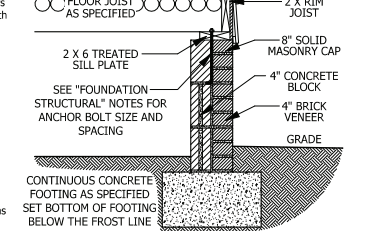
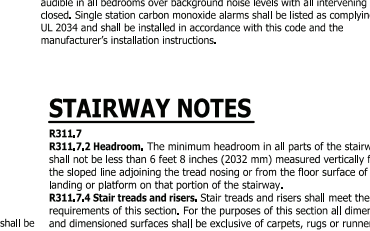
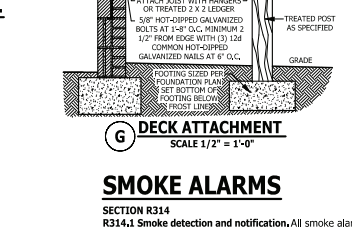
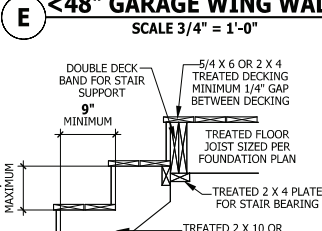
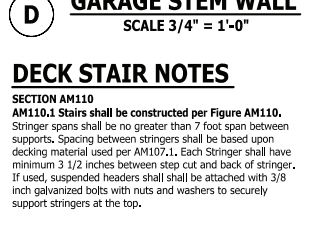
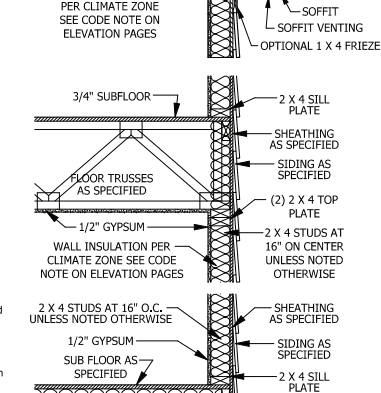
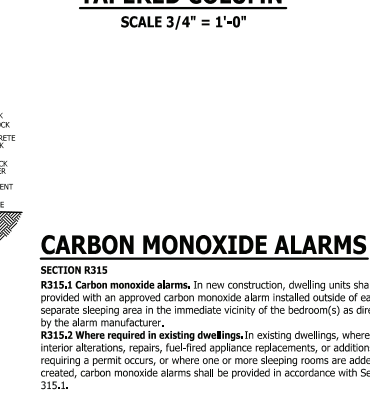
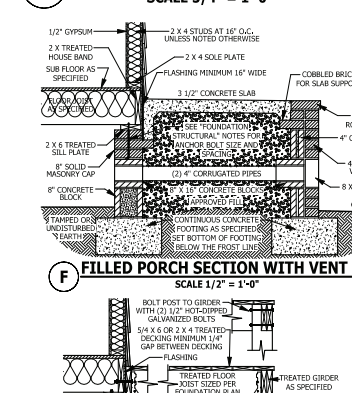
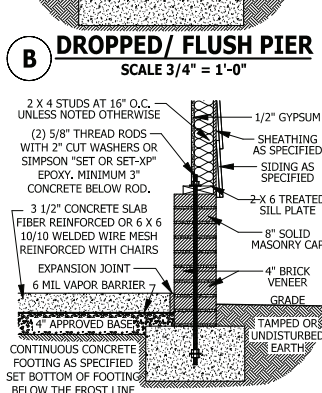
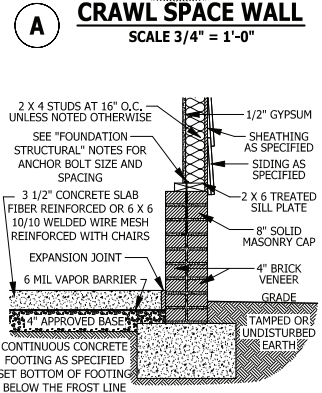
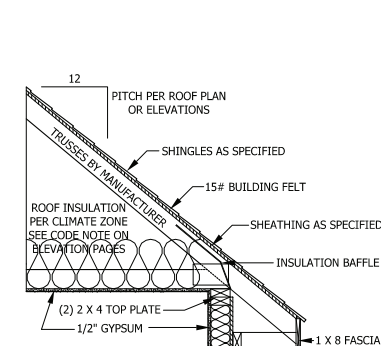
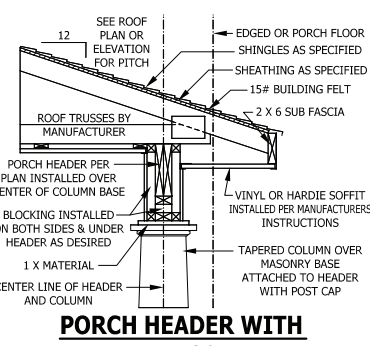
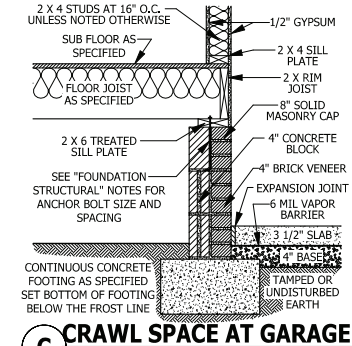
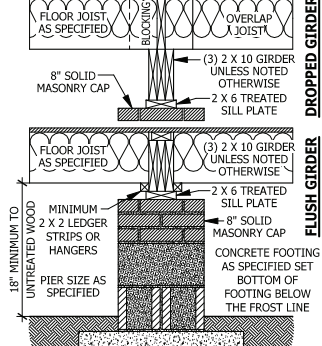
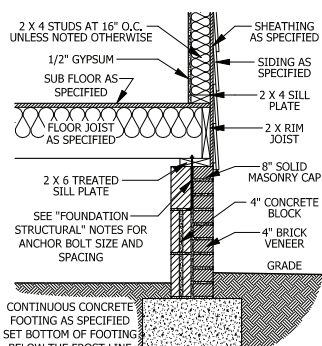

PURCHASER MUST VERIFY ALL DIMENSIONS AND CONDITIONS BEFORE CONSTRUCTION BEGINS. HAYNES HOME PLANS, INC. ASSUMES NO LIABILITY FOR CONTRACTORS PRACTICES AND PROCEDURES. CODES AND CONDITIONS MAY VARY WITH LOCATION. A LOCAL DESIGNER, ARCHITECT OR ENGINEER SHOULD BE CONSULTED BEFORE CONSTRUCTION. THESE DRAWINGS ARE INSTRUMENTS OF SERVICE AND AS SUCH SHALL REMAIN PROPERTY OF THE DESIGNER.

TYPICAL DETAILS
SINCLAIR

HAYNES WE AVER HOMES

HAYNES HOME PLANS, INC.
P.O. BOX 702, WAKE FOREST, NC 27588 919-435-8180 1-800-991-9099

SQUARE FOOTAGE HEATED

FIRST FLOOR	1351 SQ.FT.
PLAYROOM	221 SQ.FT.
TOTAL HEATED	1572 SQ.FT.
UNHEATED	
POOR ROOM	28 SQ.FT.
TOTAL	29 SQ.FT.
UNHEATED TOTAL	1601 SQ.FT.
GAZONED	113 SQ.FT.
WALKWAY	69 SQ.FT.
TOTAL	1770 SQ.FT.
UNHEATED TOTAL	307 SQ.FT.

© Copyright 2019 Haynes Home Plans, Inc.
3/6/2020
190320B
PAGE 8 OF 8

