

ELEVATION NOTES:
 GRADE ELEVATIONS SHOWN DO NOT NECESSARILY REFER TO THIS OR ANY OTHER LOT. THEY ARE FOR DIAGNOSTIC PURPOSES ONLY AND MAY VARY. BUILDER IS RESPONSIBLE FOR ADAPTING THIS PLAN TO SUIT THE EXISTING TOPOGRAPHY OF THE SITE.

ROOF VENTILATION TO BE DETERMINED BY BUILDER AS PER CODE.

ALL EGRESS OR RESCUE WINDOWS FROM SLEEPING ROOMS MUST HAVE A MIN. NET CLEAR OPENING OF 4.0 SQ FT. THE MIN NET CLEAR OPENING HEIGHT DIMENSION SHALL BE 27". THE MIN NET CLEAR OPENING WIDTH SHALL BE 20".

EACH EGRESS WINDOW FROM SLEEPING ROOMS MUST HAVE A SILL LIGHT OF NO MORE THAN 44" FROM THE FLOOR. ALL WINDOW SIZES ARE NOMINAL AND ARE TO BE VERIFIED WITH MANUFACTURER FOR AVAILABILITY AND CONFORMITY TO STATE AND LOCAL CODE REQUIREMENTS.

PORCHES, BALCONIES, OR RAISED FLOOR SURFACES LOCATED MORE THAN 30" ABOVE THE FLOOR OR GRADE BELOW SHALL HAVE GUARDRAILS NOT LESS THAN 37" IN HEIGHT.

I ASSUME NO RESPONSIBILITY FOR ANY DISTANCES AFTER START OF CONSTRUCTION. CONTRACTOR/BUILDER SHALL CONSULT WITH HOME OWNER ON ALL INTERIOR AND EXTERIOR HOLDINGS, TRIMS, COLORS, FINISHES, CABINET LAYOUTS, AND MANUFACTURERS BEFORE CONSTRUCTION BEGINS. ALL BEAMS AND FRAMING MEMBERS ARE SIZED BY OTHERS.

1.1 This plan has been drawn to comply with the 2018 NC Building Code

- 1.2 Minimum Design Loads for Building and Other Structures ASCE 7-95B
- 2 Roof Dead Load 115 P&F
 - 3 Roof Live Load 20 P&F
 - 4 Typical Floor Dead Load 10 P&F
 - 5 Floor Live Loads
 - 5.1 Rooms other than sleeping rooms 40 P&F
 - 5.2 Sleeping Rooms 30 P&F
 - 5.3 Stairs 40 P&F
 - 5.4 Decks 40 P&F
 - 5.5 Exterior Balconies 60 P&F
 - 6 Wind Loads
 - 6.1 Ultimate Design Wind Speeds 15 MPH
 - 6.2 Wind Importance Factor, I_w 1.00
 - 6.3 Exposure B
 - 6.4 Walls (Component and Cladding) 25 P&F
 - 6.5 Roofs (Component and Cladding)
 - 6.5.1 Roof Slopes 2.25/12 to 1/12 34.8 P&F
 - 6.5.2 Roof Slopes 1/12 to 12/12 21 P&F

It is the sole responsibility of the Contractor and/or Builder to conform to all standards, provisions, requirements, methods of construction and uses of materials provided in buildings and/or structures as required by NC Uniform Building Code, Local Agencies and in accordance with good engineering practices. Verify all dimensions prior to construction.



FRONT ELEVATION



FRONT ELEVATION WITH OPTIONAL 1 CAR GARAGE

ELEVATION NOTES:
 GRADE ELEVATIONS SHOWN DO NOT NECESSARILY REFER TO THIS OR ANY OTHER LOT. THEY ARE FOR DIAGRAMMATIC PURPOSES ONLY AND MAY VARY. BUILDER IS RESPONSIBLE FOR ADAPTING THIS PLAN TO SUIT THE EXISTING TOPOGRAPHY OF THE SITE.

ROOF VENTILATION TO BE DETERMINED BY BUILDER AS PER CODE.

ALL EGRESS OR RESCUE WINDOWS FROM SLEEPING ROOMS MUST HAVE A MIN. NET CLEAR OPENING OF 4.0 SQ FT. THE MIN NET CLEAR OPENING HEIGHT DIMENSION SHALL BE 20". THE MIN NET CLEAR OPENING WIDTH SHALL BE 20".

EACH EGRESS WINDOW FROM SLEEPING ROOMS MUST HAVE A SILL HEIGHT OF NO MORE THAN 44" FROM THE FLOOR. ALL WINDOW SIZES ARE NOMINAL AND ARE TO BE VERIFIED WITH MANUFACTURER FOR AVAILABILITY AND CONFORMITY TO STATE AND LOCAL CODE REQUIREMENTS.

PORCHES, BALCONIES, OR RAISED FLOOR SURFACES LOCATED MORE THAN 30" ABOVE THE FLOOR OR GRADE BELOW SHALL HAVE GUARDRAILS NOT LESS THAN 36" IN HEIGHT.

I ASSUME NO RESPONSIBILITY FOR ANY DISTANCES AFTER START OF CONSTRUCTION. CONTRACTOR/BUILDER SHALL CONSULT WITH HOME OWNER ON ALL INTERIOR AND EXTERIOR MOLDINGS, TRIMS, COLORS, FINISHES, CABINET LAYOUTS, AND MANUFACTURERS BEFORE CONSTRUCTION BEGINS. ALL BEAMS AND FRAMING MEMBERS ARE SIZED BY OTHERS.

1.1 This plan has been drawn to comply with the 2018 NC Building Code

- 1.2 Minimum Design Loads for Building and Other Structures ASCE 7-98
- 2 Roof Dead Load 15 P&F
 - 3 Roof Live Load 20 P&F
 - 4 Typical Floor Dead Load 10 P&F
 - 5 Floor Live Loads
 - 5.1 Rooms other than sleeping rooms 40 P&F
 - 5.2 Sleeping Rooms 30 P&F
 - 5.3 Stairs 40 P&F
 - 5.4 Decks 40 P&F
 - 5.5 Exterior Balconies 60 P&F
 - 6 Wind Loads
 - 6.1 Ultimate Design Wind Speeds 15 MPH
 - 6.2 Wind Importance Factor, I_W 1.00
 - 6.3 Exposure B
 - 6.4 Walls (Component and Cladding) 25 P&F
 - 6.5 Roofs (Component and Cladding)
 - 6.5.1 Roof Slopes 2.25/12 to 7/12 34.8 P&F
 - 6.5.2 Roof Slopes 7/12 to 12/12 21 P&F

It is the sole responsibility of the Contractor and/or Builder to conform to all standards, provisions, requirements, methods of construction and uses of materials provided in buildings and/or structures as required by NC Uniform Building Code, Local Agencies and in accordance with good engineering practices. Verify all dimensions prior to construction.



FRONT ELEVATION



FRONT ELEVATION WITH OPTIONAL 1 CAR GARAGE

ELEVATION NOTES:
 GRADE ELEVATIONS SHOWN DO NOT NECESSARILY REFER TO THIS OR ANY OTHER LOT. THEY ARE FOR DIAGRAMMATIC PURPOSES ONLY AND MAY VARY. BUILDER IS RESPONSIBLE FOR ADAPTING THIS PLAN TO SUIT THE EXISTING TOPOGRAPHY OF THE SITE.

ROOF VENTILATION TO BE DETERMINED BY BUILDER AS PER CODE.

ALL EGRESS OR RESCUE WINDOWS FROM SLEEPING ROOMS MUST HAVE A MIN. NET CLEAR OPENING OF 4.0 SQ FT. THE MIN NET CLEAR OPENING HEIGHT DIMENSION SHALL BE 20". THE MIN NET CLEAR OPENING WIDTH SHALL BE 20".

EACH EGRESS WINDOW FROM SLEEPING ROOMS MUST HAVE A SILL HEIGHT OF NO MORE THAN 44" FROM THE FLOOR. ALL WINDOW SIZES ARE NOMINAL AND ARE TO BE VERIFIED WITH MANUFACTURER FOR AVAILABILITY AND CONFORMITY TO STATE AND LOCAL CODE REQUIREMENTS.

PORCHES, BALCONIES, OR RAISED FLOOR SURFACES LOCATED MORE THAN 30" ABOVE THE FLOOR OR GRADE BELOW SHALL HAVE GUARDRAILS NOT LESS THAN 36" IN HEIGHT.

I ASSUME NO RESPONSIBILITY FOR ANY DISTANCES AFTER START OF CONSTRUCTION.
 CONTRACTOR/BUILDER SHALL CONSULT WITH HOME OWNER ON ALL INTERIOR AND EXTERIOR MOLDINGS, TRIMS, COLORS, FINISHES, CABINET LAYOUTS, AND MANUFACTURERS BEFORE CONSTRUCTION BEGINS.
 ALL BEAMS AND FRAMING MEMBERS ARE SIZED BY OTHERS.

1.1 This plan has been drawn to comply with the 2018 NC Building Code

- 1.2 Minimum Design Loads for Building and Other Structures ASCE 7-95
- 2 Roof Dead Load 15 PSF
 - 3 Roof Live Load 20 PSF
 - 4 Typical Floor Dead Load 10 PSF
 - 5 Floor Live Loads
 - 5.1 Rooms other than sleeping rooms 40 PSF
 - 5.2 Sleeping Rooms 30 PSF
 - 5.3 Stairs 40 PSF
 - 5.4 Decks 40 PSF
 - 5.5 Exterior Balconies 60 PSF
 - 6 Wind Loads
 - 6.1 Ultimate Design Wind Speeds 15 MPH
 - 6.2 Wind Importance Factor, I_w 1.00
 - 6.3 Exposure B
 - 6.4 Walls (Component and Cladding) 25 PSF
 - 6.5 Roofs (Component and Cladding)
 - 6.5.1 Roof Slopes 2.25/12 to 1/12 34.8 PSF
 - 6.5.2 Roof Slopes 1/12 to 12/12 21 PSF

It is the sole responsibility of the Contractor and/or Builder to conform to all standards, provisions, requirements, methods of construction and uses of materials provided in buildings and/or structures as required by NC Uniform Building Code, Local Agencies and in accordance with good engineering practices. Verify all dimensions prior to construction.



FRONT ELEVATION



FRONT ELEVATION WITH OPTIONAL 1 CAR GARAGE

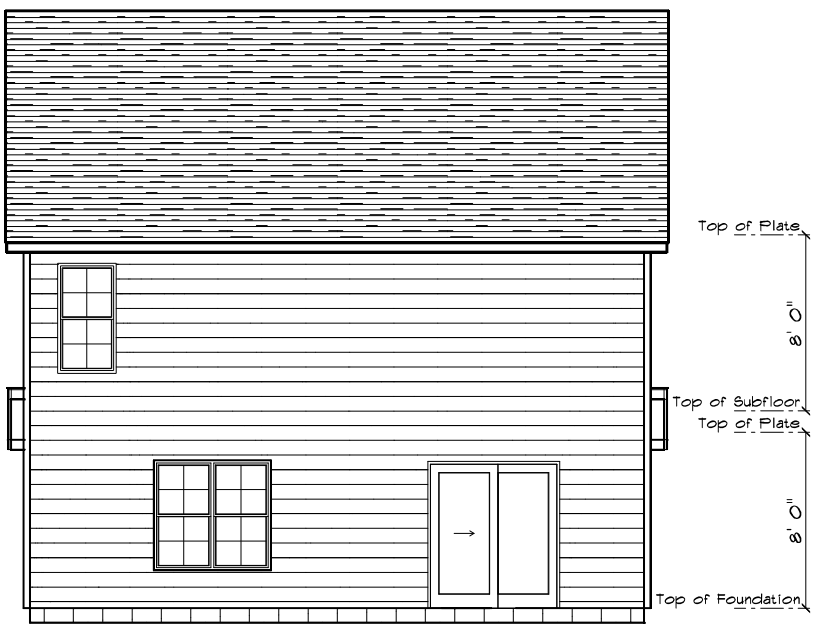

REAR ELEVATION
SCALE: 1" = 1/4"



RIGHT ELEVATION
SCALE: 1" = 1/4"



LEFT ELEVATION
SCALE: 1" = 1/4"

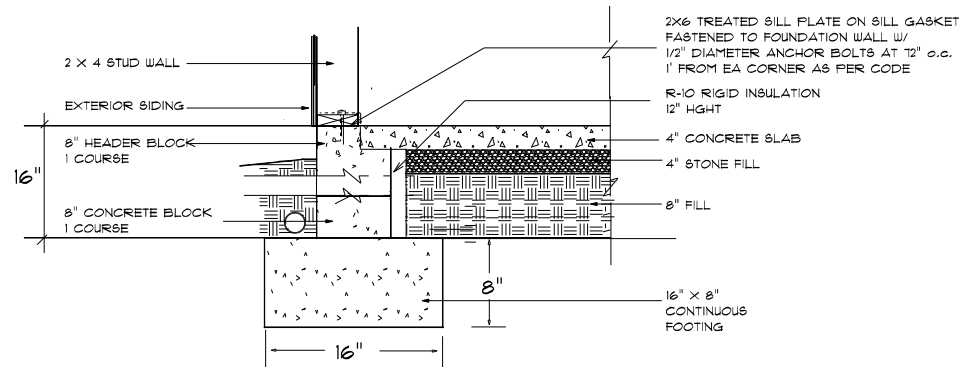

STEM WALL FOUNDATION Detail
not to scale

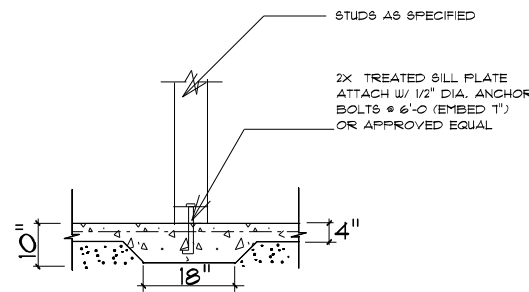

TYPICAL THICKENED SLAB
not to scale

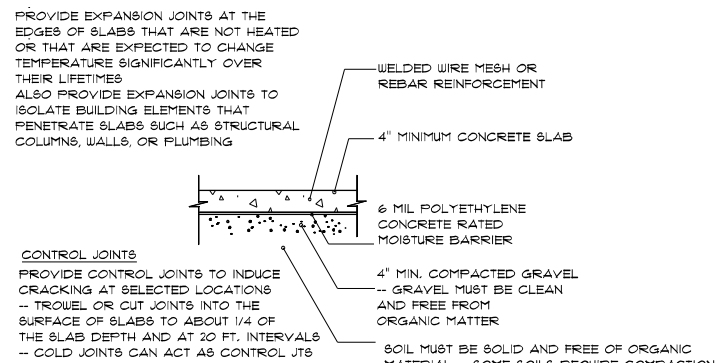

**CONCRETE SLAB
DETAILS / NOTES**
not to scale

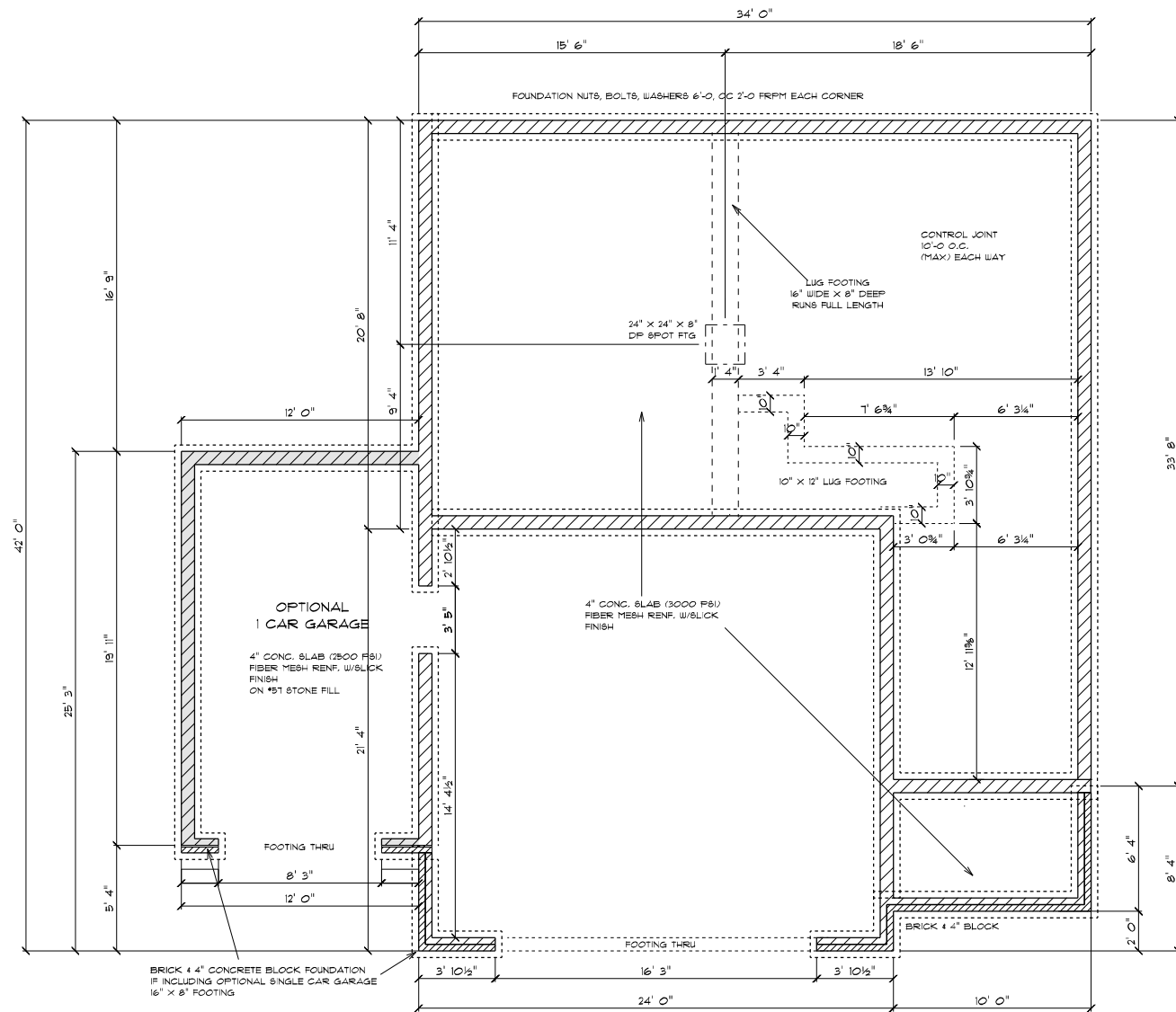

FOUNDATION PLAN
SCALE: 1" = 1/4"

Termite Soil Treatment: Treat entire slab area soil or crawl space surface before vapor barrier is installed and slab is poured with a state approved termiticide. Termiticide should be applied by a licensed and certified pest control professional by the state of North Carolina.

FOUNDATION NOTES:
ALL FOOTINGS SHALL BEAR ON ORIGINAL UNDISTURBED SOIL. THE 28 DAY COMPRESSIVE STRENGTH OF ALL FOOTINGS IS 3000 PSI.
PROVIDE WATER PROOFING AND PERIMETER DRAINS AS REQUIRED.
FOUNDATION CONCRETE MIX TO HAVE 1-1/2" MAX AGGREGATE SIZE. CONCRETE FILL MIX TO HAVE 1/2" MAX AGGREGATE SIZE.
FOOTING WIDTHS ARE BASED ON A LOAD-BEARING SOIL CAPACITY OF 2000 PSI.
PROVIDE 6 MIL POLY VAPOR BARRIER TO COVER GROUND SURFACE IN CRAWL SPACE
ALL ANCHOR BOLTS TO BE 1/2" LONG, 1/2" DIA. 3/8" UNO ANCHOR BOLTS SHALL BE SPACE AT A MAX OF 6' OC AND NO MORE THAN 1' FROM EA CORNER.

TYPICAL WALL: 8" BLOCK W/ 18" X 12" FOOTING
 3-2 X 10'S GIRDER
 2 X 10'S 16" OC JOIST

FOUNDATION NOTES:
 ALL FOOTINGS SHALL BEAR ON ORIGINAL UNDISTURBED SOIL.
 THE 28 DAY COMPRESSIVE STRENGTH OF ALL FOOTINGS IS 3000 PSI
 PROVIDE WATER PROOFING AND PERIMETER DRAINS AS REQUIRED.
 FOUNDATION CONCRETE MIX TO HAVE 1-1/2" MAX AGGREGATE SIZE. CONCRETE FILL MIX TO HAVE 1/2" MAX AGGREGATE SIZE.
 FOOTING WIDTHS ARE BASED ON A LOAD-BEARING SOIL CAPACITY OF 2000 PSI.
 PROVIDE 6 MIL POLY VAPOR BARRIER TO COVER GROUND SURFACE IN CRAWL SPACE
 ALL ANCHOR BOLTS TO BE 12" LONG, 1/2" DIA. A36 UNO ANCHOR BOLTS SHALL BE SPACE AT A MAX OF 6' OC AND NO MORE THAN 1' FROM EA CORNER.

Termite Soil Treatment: Treat entire slab area soil or crawl space surface before vapor barrier is installed and slab is poured with a state approved termiticide. Termiticide should be applied by a licensed and certified pest control professional by the state of North Carolina.

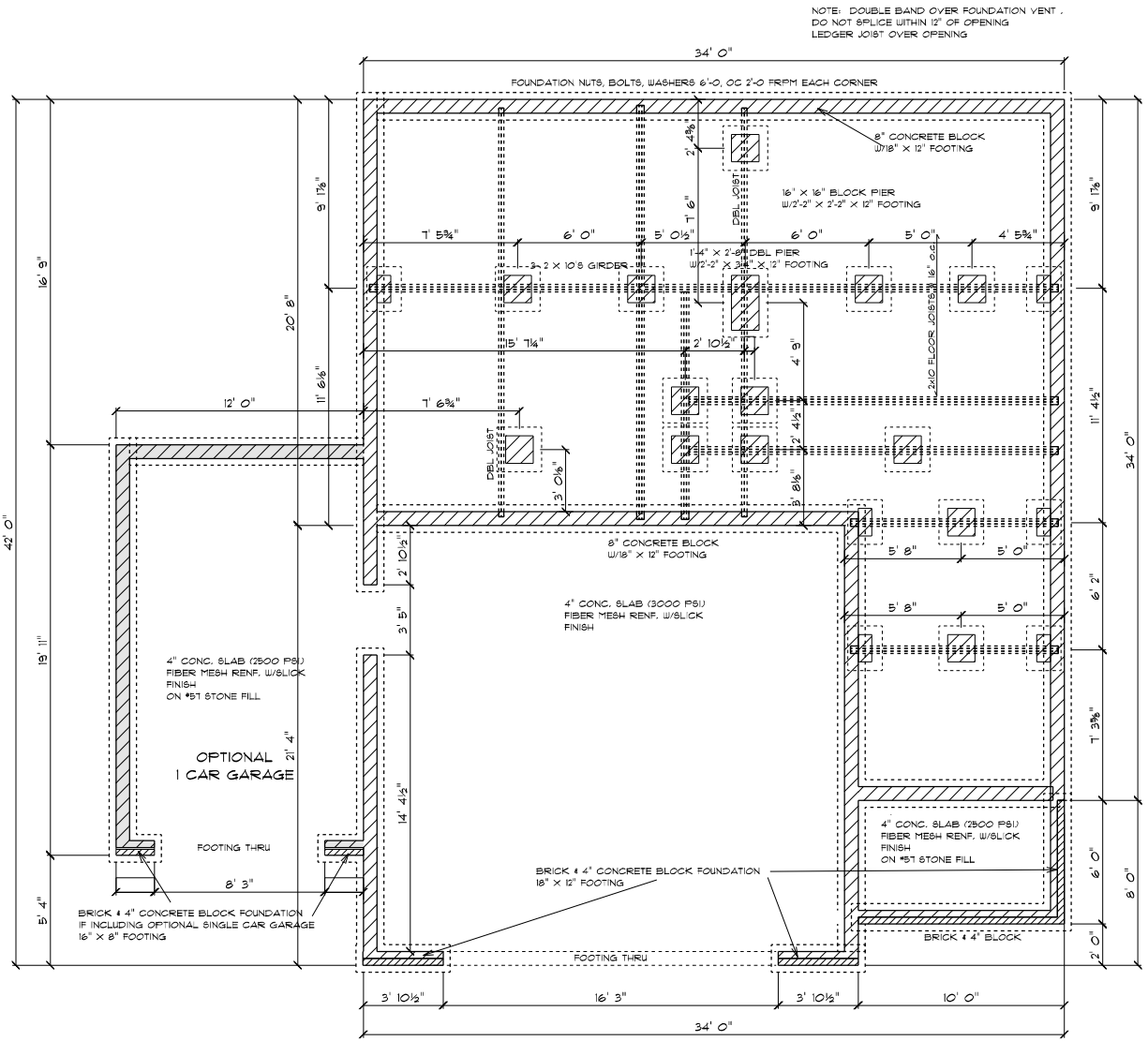
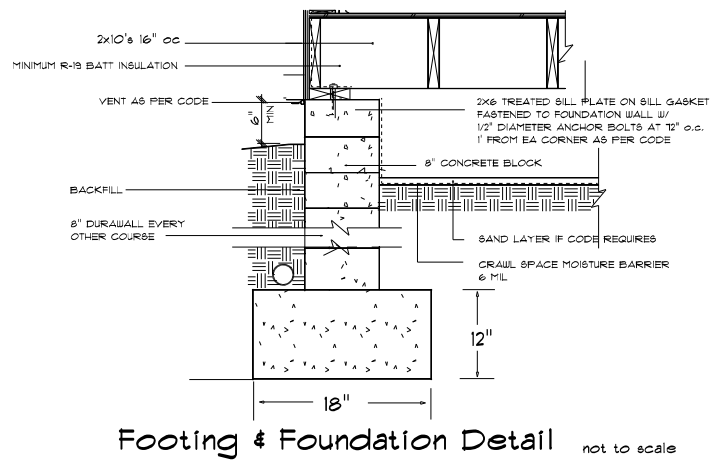
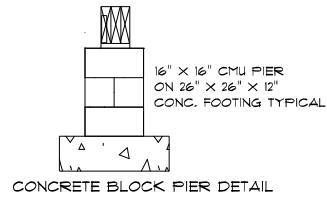

DRD
 Drive Five Design
 6025 Hackwood Lane
 Sanford, N.C. 27332
 919-710-0353
 gofranchisearcher.net

PAGE #:
 30

SCALE: 1" = 1/4"
 DRAWN BY:
 DATE: 9/14/2022

LANCO HOMES

THE JEFFERSON
 LEFT GARAGE

CRAWL SPACE
 FOUNDATION
 PLAN

OPENING SCHEDULE				
R.O. HEIGHT	R.O. WIDTH	LIBRARY NAME	COUNT	SIZE
80-1/2"	72"	Exterior Door\Patio	1	6'-0"
60-1/2"	32"	Window\Double Hung	1	2'-8" x 5'-0"
60-1/2"	64-1/2"	Window\Double Hung	2	2'-8" x 5'-0" Twin

GENERAL FRAMING NOTES:
 ALL LUMBER IN CONTACT WITH CONCRETE OR MASONRY SHALL BE PRESSURE TREATED.
 FRAMING LUMBER SHALL BE SYP #2 GRADE AND/OR SPRUCE PINE FIR #1 AND/OR #2, KILN DRIED.
 WHERE PRE-ENGINEERED JOISTS ARE USED, JOIST MANUFACTURER SHALL PROVIDE SHOP DRAWINGS, WHICH BEAR SEAL OF A N.C. ENGINEER.
 STUDS AND JOISTS SHALL NOT BE CUT TO INSTALL PLUMBING OR WIRING WITHOUT ADDING METAL OR WOOD SIDE PANELS TO STRENGTHEN THE MEMBER TO ITS ORIGINAL CAPACITY.
 NAIL MULTIPLE MEMBERS WITH 2 ROWS OF 16d NAILS STAGGERED 32" OC AN USE 3-16d NAILS 2" IN AT EACH END. DOUBLE ALL STUDS UNDER ROOF POST DOWNS UNO.
 NAIL FLOOR JOISTS TO SILL PLATE WITH 8d TOE NAILS.
 ALL EXPOSED FRAMING ON PORCHES AND DECKS SHALL BE PRESSURE TREATED.
 PROVIDE WATERPROOFING AND DRAINS AS REQUIRED.
 ALL FRAMING TO BE 16" OC UNO. WALL FRAMING DIMENSIONS ARE BASED ON 2 X 4 STUDS UNO, DOUBLE STUDS UNDER ALL HEADERS.
 LVL'S AND TJ'S TO BE SIZED BY OTHERS
 EXTERIOR WALLS IN LIVING AREAS ARE 2 X 4

OPENING SCHEDULE				
R.O. HEIGHT	R.O. WIDTH	LIBRARY NAME	COUNT	SIZE
60-1/2"	32"	Window\Double Hung	5	2'-8" x 5'-0"
36"	24"	Window\Double Hung	1	2'-0" x 3'-0"
60-1/2"	64-1/2"	Window\Double Hung	2	2'-8" x 5'-0" Twin
12"	48"	Window\Transom	1	4'-0" x 1'-0"

GENERAL FRAMING NOTES:
 ALL LUMBER IN CONTACT WITH CONCRETE OR MASONRY SHALL BE PRESSURE TREATED.
 FRAMING LUMBER SHALL BE SYP #2 GRADE AND/OR SPRUCE PINE FIR #1 AND/OR #2, KILN DRIED.
 WHERE PRE-ENGINEERED JOISTS ARE USED, JOIST MANUFACTURER SHALL PROVIDE SHOP DRAWINGS, WHICH BEAR SEAL OF A N.C. ENGINEER.
 STUDS AND JOISTS SHALL NOT BE CUT TO INSTALL PLUMBING OR WIRING WITHOUT ADDING METAL OR WOOD SIDE PANELS TO STRENGTHEN THE MEMBER TO ITS ORIGINAL CAPACITY.
 NAIL MULTIPLE MEMBERS WITH 2 ROWS OF 16d NAILS STAGGERED 32" OC AN USE 3-16d NAILS 2" IN AT EACH END. DOUBLE ALL STUDS UNDER ROOF POST DOWNS UNO.
 NAIL FLOOR JOISTS TO SILL PLATE WITH 8d TOE NAILS.
 ALL EXPOSED FRAMING ON PORCHES AND DECKS SHALL BE PRESSURE TREATED.
 PROVIDE WATERPROOFING AND DRAINS AS REQUIRED.
 ALL FRAMING TO BE 16" OC UNO. WALL FRAMING DIMENSIONS ARE BASED ON 2 X 4 STUDS UNO, DOUBLE STUDS UNDER ALL HEADERS.
 LVL'S AND TJ'S TO BE SIZED BY OTHERS
 EXTERIOR WALLS IN LIVING AREAS ARE 2 X 4

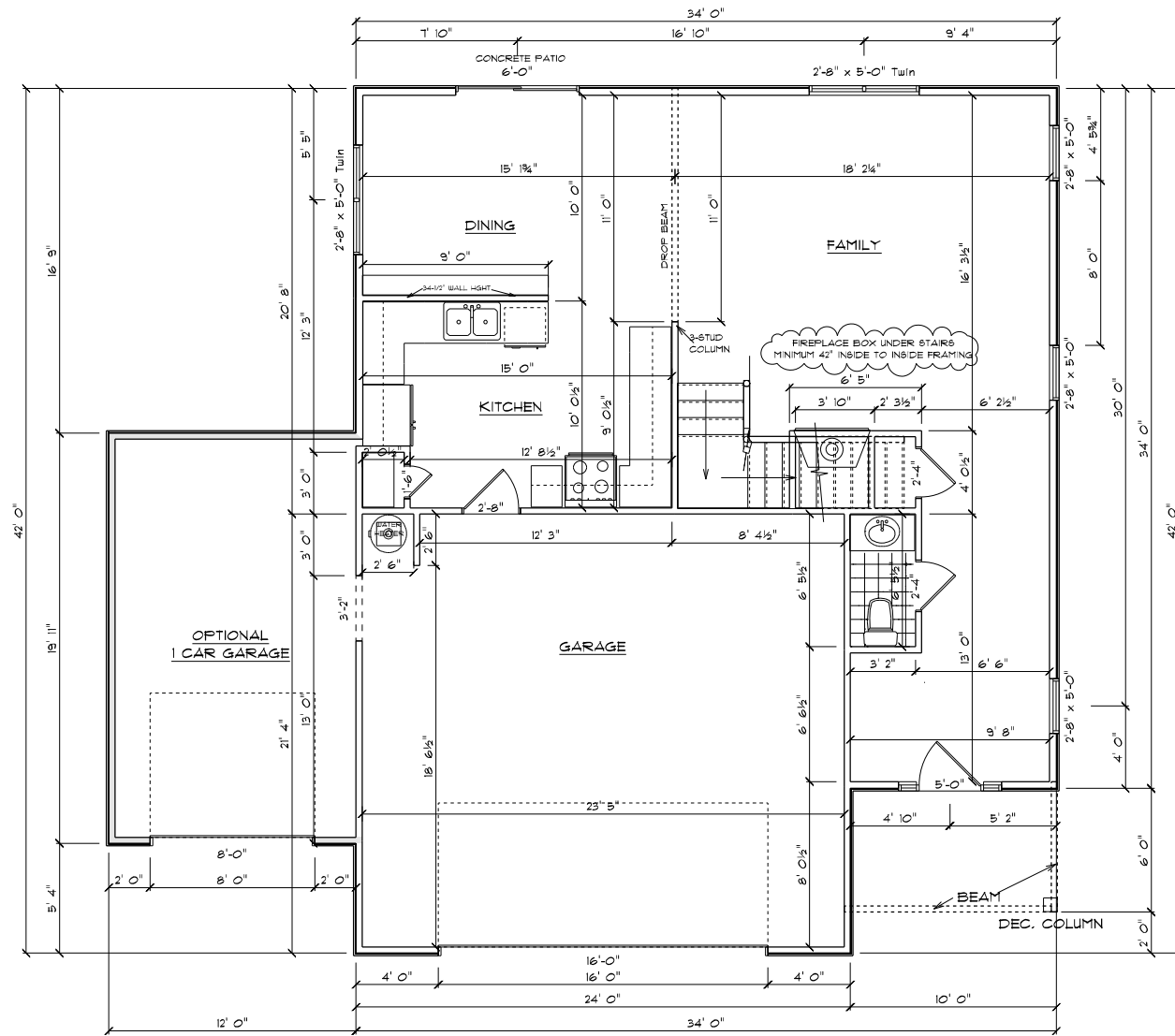

1ST FLOOR PLAN
 SCALE: 1/4"

AREA SCHEDULE	
AREA	NAME
841.2 sq. ft.	Heated
505.8 sq. ft.	Garage
244.5 sq. ft.	Optional 1 Car Garage
58.3 sq. ft.	Covered Porch

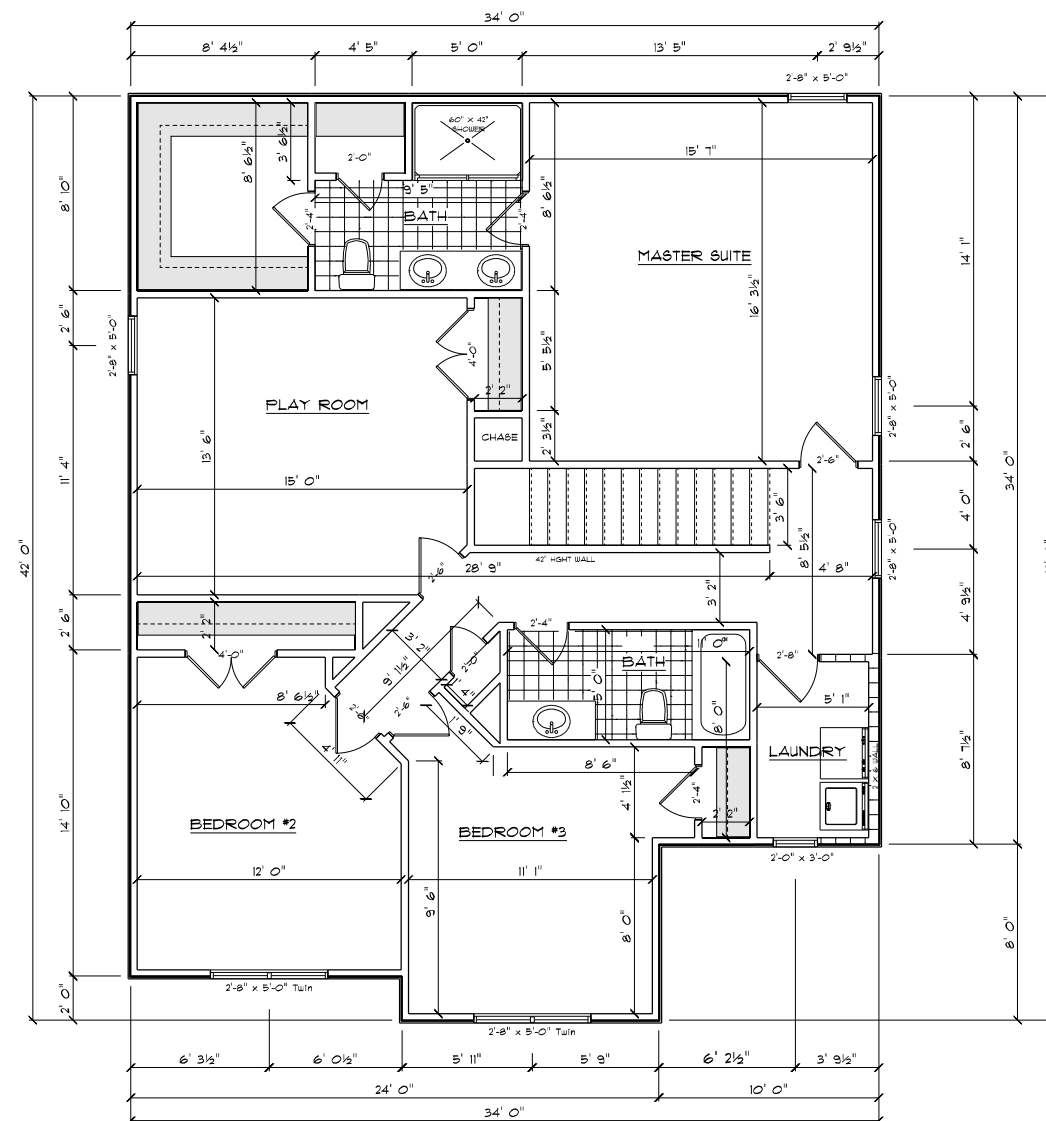

2ND FLOOR PLAN
 SCALE: 1/4"

AREA SCHEDULE	
NAME	AREA
Heated	1302.4 sq. ft.

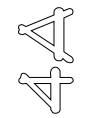

Diene Rivers Designs
 6205 Hickorybird Lane
 Sanford, N.C. 27332
 919-710-0353
 gollucan@charter.net

DRD

SCALE: 1/4" DRAWN BY: DATE: 2/5/2023

LAMCO HOMES

**THE JEFFERSON
 LEFT FRONT LOAD**

FLOOR PLANS

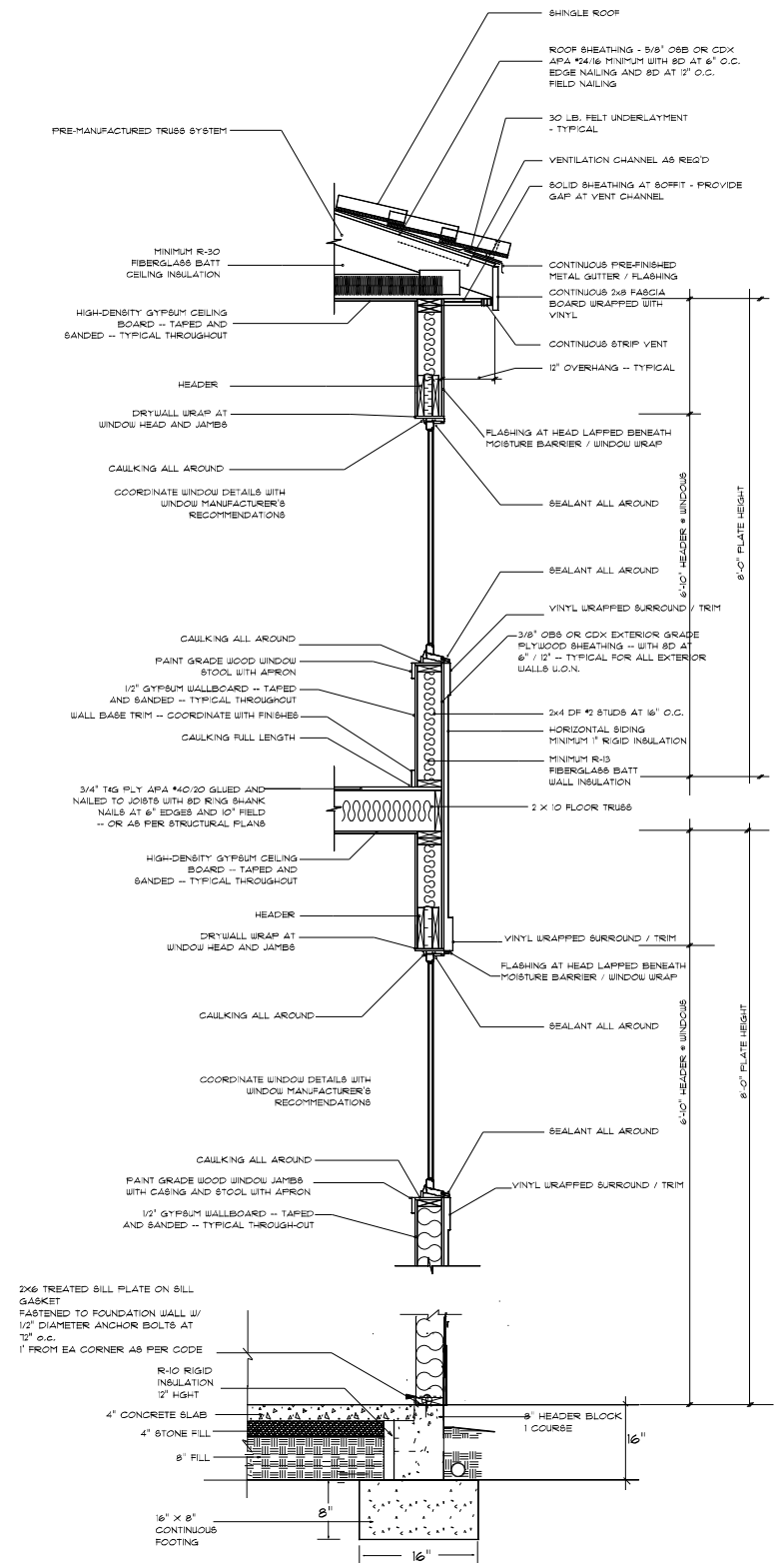

2x4 WITH 8" BLOCK STEM WALL FOUNDATION
not to scale

TYPICAL TRUSS ROOF:
SHINGLES
1/16" ROOFING PLYWOOD c/w
4" CLIPS
BLOCK & BRACE PER TRUSS MGR.
PRE-ENGINEERED TRUSSES @ 24" o.c.
2x4 TRUSS BRACING
R38 BLOWN INSULATION
5/8" CEILING BOARD
TAPED & SANDED

TYPICAL 2x4 SIDING EXTERIOR WALL:
VINYL SIDING
1/16" PLYWOOD SHEATHING
2x4 STUDS @ 16" o.c.
R13 BATT INSULATION
1/2" DRYWALL
TAPED & SANDED

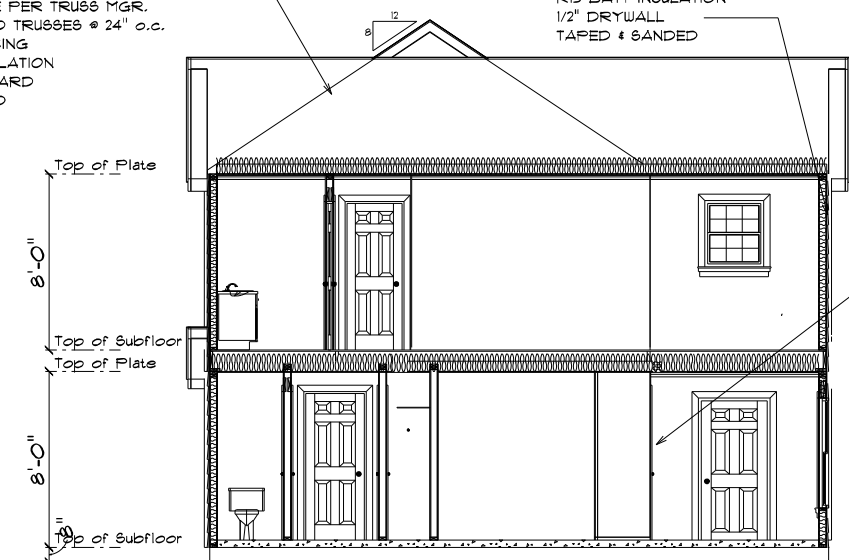

TYPICAL 2x4 WALL:
1/2" DRYWALL
TAPED & SANDED
2x4 STUDS @ 16" o.c.
1/2" DRYWALL
TAPED & SANDED

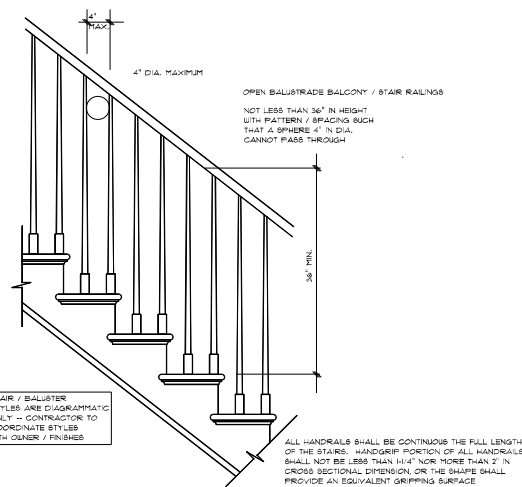

STAIR RAILING

ROOF NOTES:
TRUSSES, BRACINGS, BRIDGING AND CONNECTORS ARE TO BE DESIGNED BY THE TRUSS MANUFACTURER.
IDENTIFY LUMBER BY OFFICIAL GRADE MARKINGS.
DO NOT CUT OR REMOVE CHORDS OR OTHER TRUSS MEMBERS.
DO NOT NOTCH OR DRILL TRUSS MEMBERS.
WHERE PRE-ENGINEERED ROOF TRUSSES ARE USED, TRUSS MANUFACTURER SHALL PROVIDE SHOP DRAWINGS, WHICH BEAR SEAL OF A N. C. REGISTERED ENGINEER.

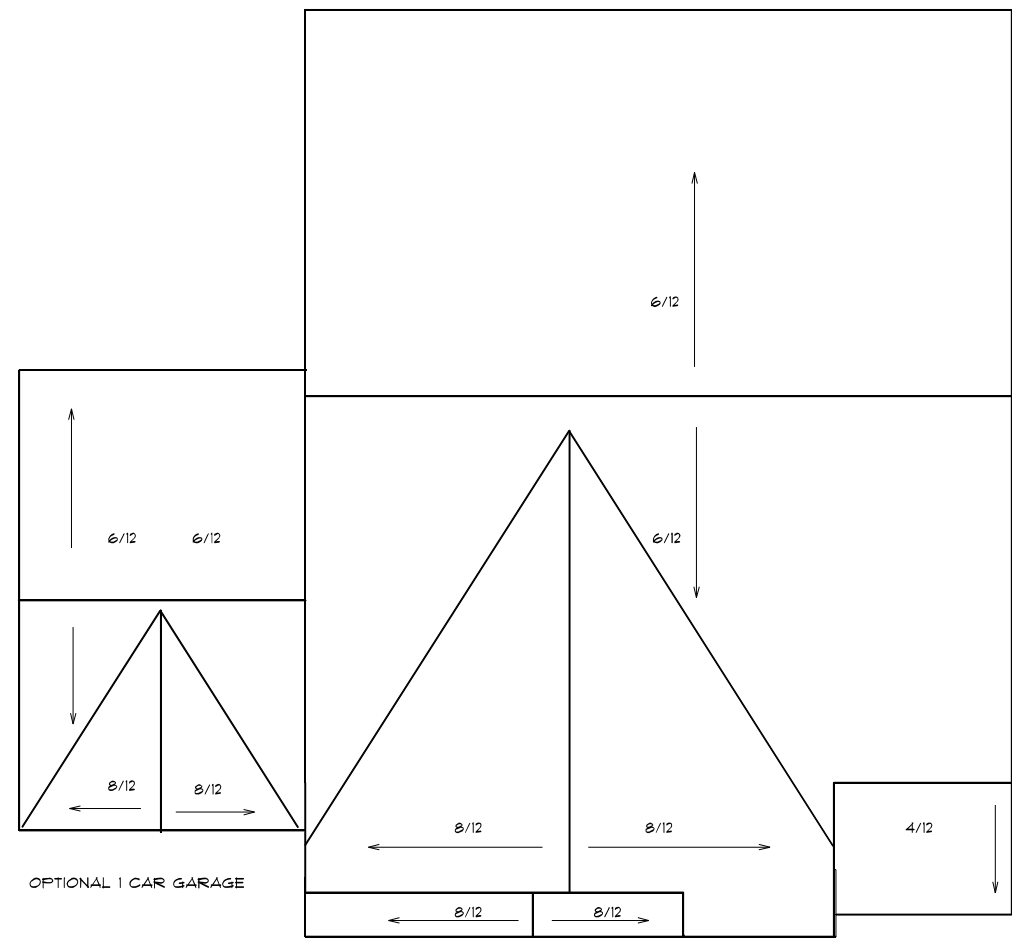

ROOF PLAN
SCALE: 1" = 1/4"

6/12 PITCH MAIN ROOF
8/12 PITCH FRONT GABLES
4/12 PITCH SHED ROOF
12" OH ALL

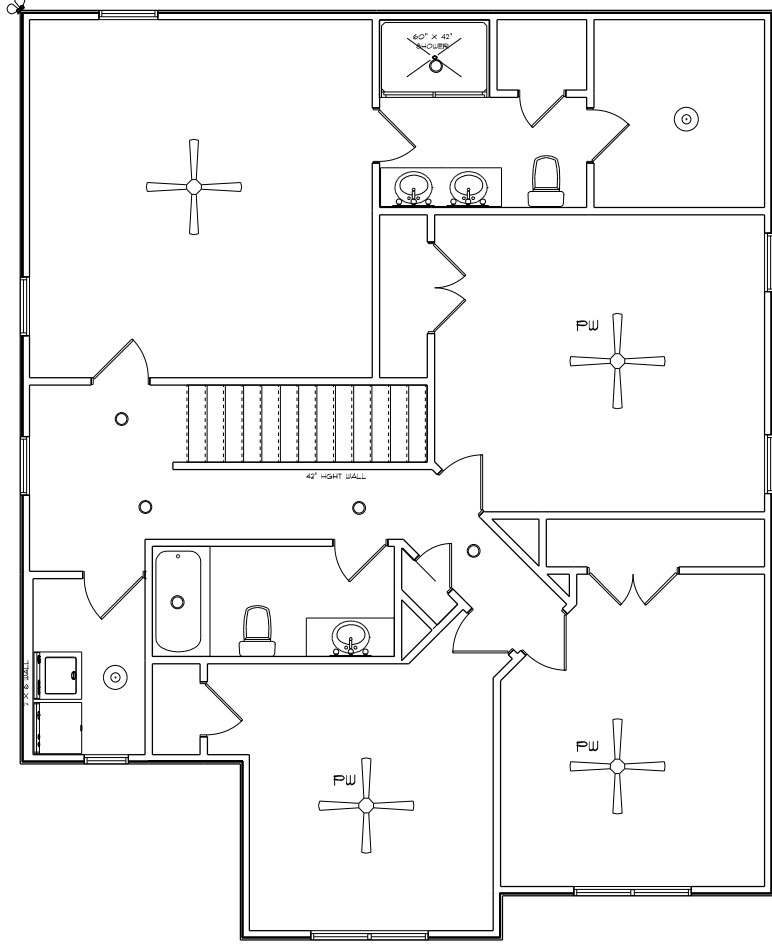

ELECTRICAL LEGEND		
SYMBOL	COUNT	ELECTRICAL
	1	ceiling fan
	6	7 inch led light
	2	10 inch led light
	1	flood light
	3	vanity light

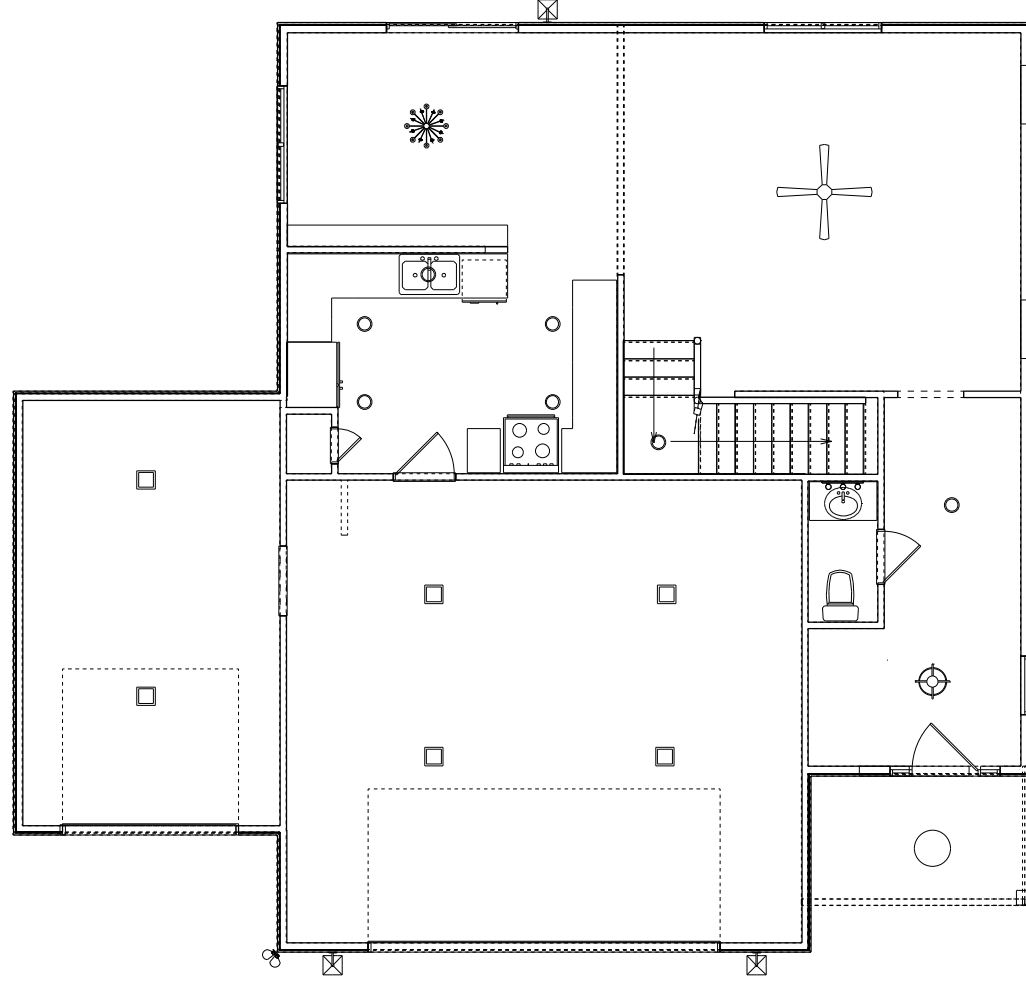

ELECTRICAL LEGEND		
SYMBOL	COUNT	ELECTRICAL
	1	ceiling fan
	7	7 inch led light
	1	dinning room light
	6	10 inch led light
	1	out door ceiling light
	1	foyer light
	3	coach light
	1	flood light
	1	vanity light