

RE: J1023-6083
Lot A Hobby Rd

Trenco
818 Soundside Rd
Edenton, NC 27932

Site Information:

Customer: Project Name: J1023-6083
Lot/Block: Model:
Address: Subdivision:
City: State:

General Truss Engineering Criteria & Design Loads (Individual Truss Design Drawings Show Special Loading Conditions):

Design Code: IRC2015/TPI2014 Design Program: MiTek 20/20 8.4
Wind Code: N/A Wind Speed: N/A mph
Roof Load: N/A psf Floor Load: 55.0 psf

This package includes 8 individual, dated Truss Design Drawings and 0 Additional Drawings.

No.	Seal#	Truss Name	Date
1	I59138480	F01	6/23/2023
2	I59138481	F02	6/23/2023
3	I59138482	F03	6/23/2023
4	I59138483	F04	6/23/2023
5	I59138484	F05	6/23/2023
6	I59138485	FW01	6/23/2023
7	I59138486	FW02	6/23/2023
8	I59138487	FW03	6/23/2023

The truss drawing(s) referenced above have been prepared by Truss Engineering Co. under my direct supervision based on the parameters provided by Comtech, Inc - Fayetteville.

Truss Design Engineer's Name: Gilbert, Eric

My license renewal date for the state of North Carolina is December 31, 2023.

North Carolina COA: C-0844

IMPORTANT NOTE: The seal on these truss component designs is a certification that the engineer named is licensed in the jurisdiction(s) identified and that the designs comply with ANSI/TPI 1. These designs are based upon parameters shown (e.g., loads, supports, dimensions, shapes and design codes), which were given to TRENCO. Any project specific information included is for TRENCO customers file reference purpose only, and was not taken into account in the preparation of these designs. TRENCO has not independently verified the applicability of the design parameters or the designs for any particular building. Before use, the building designer should verify applicability of design parameters and properly incorporate these designs into the overall building design per ANSI/TPI 1, Chapter 2.

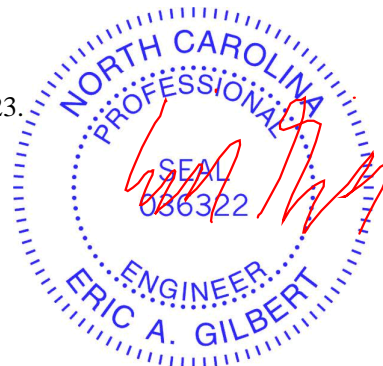

June 23, 2023

Job J1023-6083	Truss F01	Truss Type FLOOR	Qty 4	Ply 1	Lot A Hobby Rd I59138480
-------------------	--------------	---------------------	----------	----------	-----------------------------

Comtech, Inc. Fayetteville, NC - 28314,

8.430 s Jan 6 2022 MiTek Industries, Inc. Thu Jun 22 18:12:01 2023 Page 1
ID:wAaOiCu?enbzDlvzeiq6d3zFzeT-RfC?PsB70Hq3NSgPqnL8w3uITXbGKWrCDoi7J4zJC?f

0-1-8

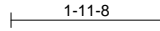
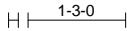

0-1-8
Scale = 1:29.5

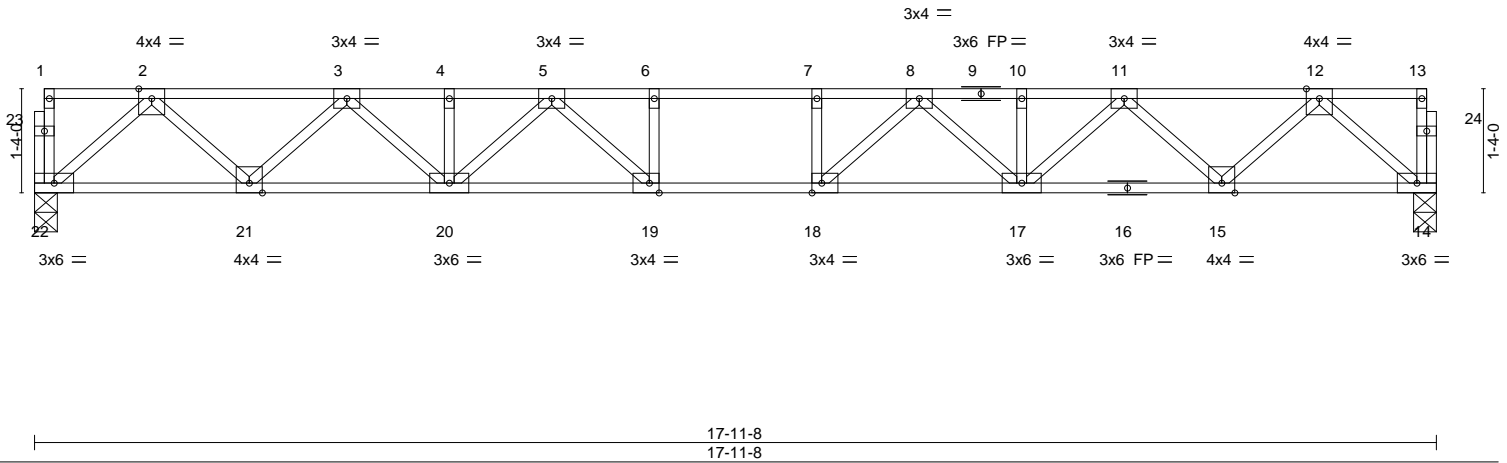

Plate Offsets (X,Y)--	[18:0-1-8,Edge], [19:0-1-8,Edge]							
LOADING (psf)	SPACING- 2-0-0	CSI.	DEFL. in (loc) l/defl L/d	PLATES	GRIP			
TCLL 40.0	Plate Grip DOL 1.00	TC 0.53	Vert(LL) -0.22 18-19 >976 480	MT20	244/190			
TCDL 10.0	Lumber DOL 1.00	BC 0.75	Vert(CT) -0.30 18-19 >710 360					
BCLL 0.0	Rep Stress Incr YES	WB 0.48	Horz(CT) 0.06 14 n/a n/a					
BCDL 5.0	Code IRC2015/TPI2014	Matrix-S						
								Weight: 95 lb FT = 20%F, 11%E

LUMBER-		BRACING-	
TOP CHORD 2x4 SP No.1(flat)		TOP CHORD	Structural wood sheathing directly applied or 6-0-0 oc purlins, except end verticals.
BOT CHORD 2x4 SP No.1(flat)		BOT CHORD	Rigid ceiling directly applied or 10-0-0 oc bracing.
WEBS 2x4 SP No.3(flat)			

REACTIONS. (size) 22=0-3-8, 14=0-3-8
Max Grav 22=968(LC 1), 14=968(LC 1)

FORCES. (lb) - Max. Comp./Max. Ten. - All forces 250 (lb) or less except when shown.
TOP CHORD 2-3=-1772/0, 3-4=-2955/0, 4-5=-2955/0, 5-6=-3534/0, 6-7=-3534/0, 7-8=-3534/0, 8-10=-2955/0, 10-11=-2955/0, 11-12=-1772/0
BOT CHORD 21-22=0/1050, 20-21=0/2464, 19-20=0/3311, 18-19=0/3534, 17-18=0/3311, 15-17=0/2464, 14-15=0/1050
WEBS 2-22=-1395/0, 2-21=0/1004, 3-21=-963/0, 3-20=0/668, 12-14=-1395/0, 12-15=0/1004, 11-15=-963/0, 11-17=0/668, 8-17=-483/0, 8-18=-63/605, 7-18=-303/0, 5-20=-483/0, 5-19=-63/605, 6-19=-303/0

- NOTES-**
- 1) Unbalanced floor live loads have been considered for this design.
 - 2) All plates are 1.5x3 MT20 unless otherwise indicated.
 - 3) Plates checked for a plus or minus 1 degree rotation about its center.
 - 4) Recommend 2x6 strongbacks, on edge, spaced at 10-0-0 oc and fastened to each truss with 3-10d (0.131" X 3") nails. Strongbacks to be attached to walls at their outer ends or restrained by other means.



Job J1023-6083	Truss F02	Truss Type Floor	Qty 8	Ply 1	Lot A Hobby Rd I59138481
-------------------	--------------	---------------------	----------	----------	-----------------------------

Comtech, Inc. Fayetteville, NC - 28314,

8.430 s Jan 6 2022 MiTek Industries, Inc. Thu Jun 22 18:12:02 2023 Page 1
ID:wAaOiCu?enbzdIvzeiq6d3zFzeT-RfC?PsB70Hq3NSgPqnL8w3uITXbGKWrCDoi7J4zJC?f

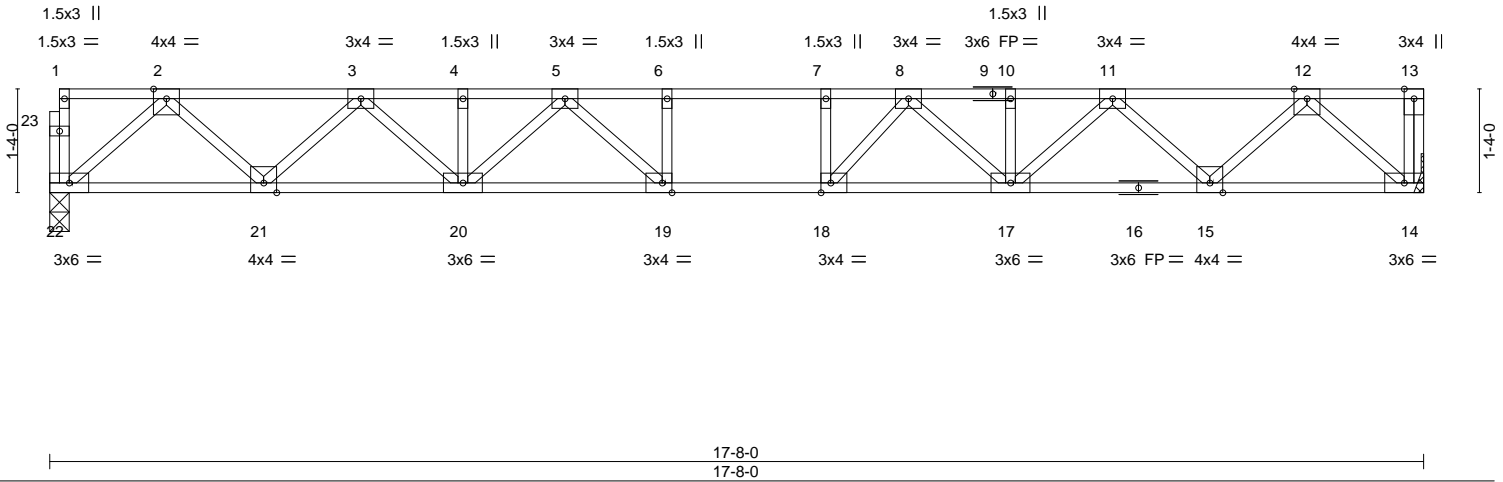
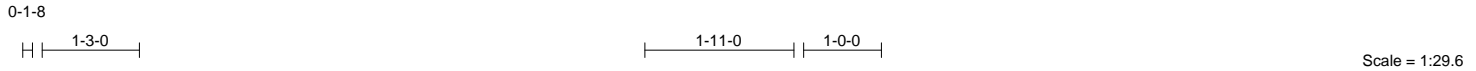

Plate Offsets (X, Y)--	[18:0-1-8,Edge], [19:0-1-8,Edge]				
LOADING (psf)	SPACING- 2-0-0	CSI.	DEFL. in (loc) l/defl L/d	PLATES	GRIP
TCLL 40.0	Plate Grip DOL 1.00	TC 0.53	Vert(LL) -0.21 19 >999 480	MT20	244/190
TCDL 10.0	Lumber DOL 1.00	BC 0.74	Vert(CT) -0.28 19 >735 360		
BCLL 0.0	Rep Stress Incr YES	WB 0.47	Horz(CT) 0.06 14 n/a n/a		
BCDL 5.0	Code IRC2015/TPI2014	Matrix-S			
				Weight: 94 lb	FT = 20%F, 11%E

LUMBER-	BRACING-
TOP CHORD 2x4 SP No.1(flat)	TOP CHORD Structural wood sheathing directly applied or 6-0-0 oc purlins, except end verticals.
BOT CHORD 2x4 SP No.1(flat)	BOT CHORD Rigid ceiling directly applied or 10-0-0 oc bracing.
WEBS 2x4 SP No.3(flat)	

REACTIONS. (size) 22=0-3-0, 14=Mechanical
Max Grav 22=952(LC 1), 14=958(LC 1)

FORCES. (lb) - Max. Comp./Max. Ten. - All forces 250 (lb) or less except when shown.
TOP CHORD 2-3=-1737/0, 3-4=-2887/0, 4-5=-2887/0, 5-6=-3418/0, 6-7=-3418/0, 7-8=-3418/0, 8-10=-2886/0, 10-11=-2886/0, 11-12=-1738/0
BOT CHORD 21-22=0/1032, 20-21=0/2413, 19-20=0/3225, 18-19=0/3418, 17-18=0/3224, 15-17=0/2412, 14-15=0/1033
WEBS 2-22=-1371/0, 2-21=0/981, 3-21=-941/0, 3-20=0/644, 5-20=-459/0, 5-19=-81/563, 6-19=-283/0, 12-14=-1375/0, 12-15=0/980, 11-15=-938/0, 11-17=0/644, 8-17=-460/0, 8-18=-71/590, 7-18=-332/0

- NOTES-**
- 1) Unbalanced floor live loads have been considered for this design.
 - 2) Plates checked for a plus or minus 1 degree rotation about its center.
 - 3) Refer to girder(s) for truss to truss connections.
 - 4) Recommend 2x6 strongbacks, on edge, spaced at 10-0-0 oc and fastened to each truss with 3-10d (0.131" X 3") nails. Strongbacks to be attached to walls at their outer ends or restrained by other means.
 - 5) CAUTION, Do not erect truss backwards.

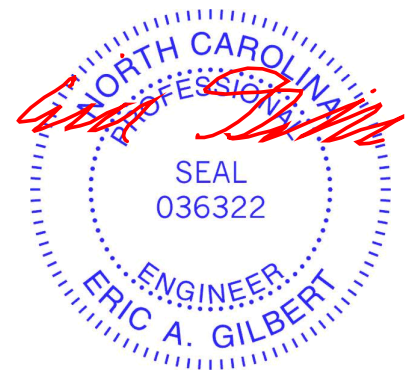

Job J1023-6083	Truss F04	Truss Type Floor	Qty 1	Ply 1	Lot A Hobby Rd I59138483
-------------------	--------------	---------------------	----------	----------	-----------------------------

Comtech, Inc. Fayetteville, NC - 28314,

8.430 s Jan 6 2022 MiTek Industries, Inc. Thu Jun 22 18:12:05 2023 Page 1
ID:wAaOiCu?enbzDlvzeiq6d3zFzeT-RfC?PsB70Hq3NSgPqnL8w3uITXbGKWrCDoi7J4zJC?f

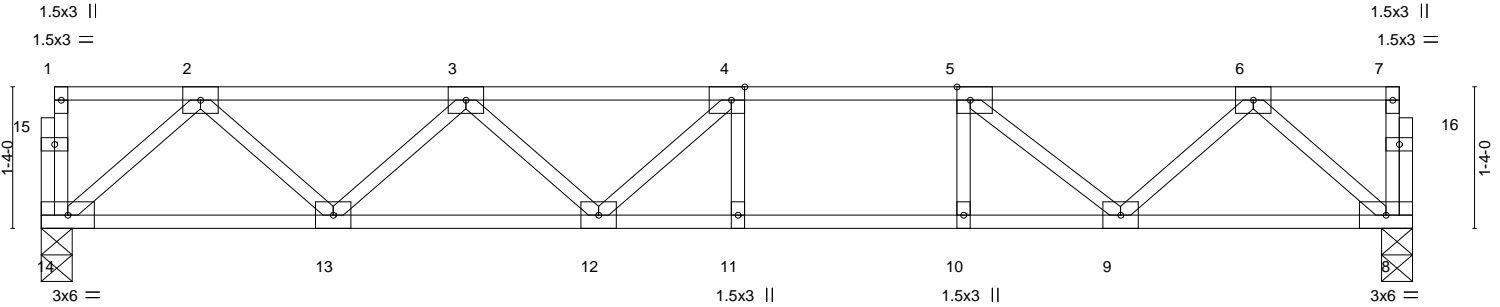
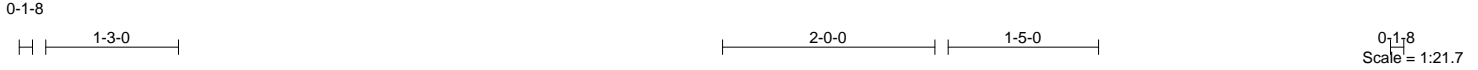

12-11-0
12-11-0

Plate Offsets (X,Y)-- [4:0-1-8,Edge], [5:0-1-8,Edge]

LOADING (psf)	SPACING-	CSI.	DEFL.	PLATES	GRIP
TCLL 40.0	2-0-0	TC 0.51	in (loc) l/defl L/d	MT20	244/190
TCDL 10.0	Plate Grip DOL 1.00	BC 0.84	Vert(LL) -0.14 11-12 >999 480		
BCLL 0.0	Lumber DOL 1.00	WB 0.30	Vert(CT) -0.19 11-12 >808 360		
BCDL 5.0	Rep Stress Incr YES	Matrix-S	Horz(CT) 0.02 8 n/a n/a		
	Code IRC2015/TPI2014			Weight: 67 lb	FT = 20%F, 11%E

LUMBER-	BRACING-
TOP CHORD 2x4 SP No.1(flat)	TOP CHORD Structural wood sheathing directly applied or 6-0-0 oc purlins, except end verticals.
BOT CHORD 2x4 SP No.1(flat)	BOT CHORD Rigid ceiling directly applied or 10-0-0 oc bracing.
WEBS 2x4 SP No.3(flat)	

REACTIONS. (size) 14=0-3-8, 8=0-3-8
Max Grav 14=690(LC 1), 8=690(LC 1)

FORCES. (lb) - Max. Comp./Max. Ten. - All forces 250 (lb) or less except when shown.
TOP CHORD 2-3=-1178/0, 3-4=-1725/0, 4-5=-1745/0, 5-6=-1168/0
BOT CHORD 13-14=0/726, 12-13=0/1608, 11-12=0/1745, 10-11=0/1745, 9-10=0/1745, 8-9=0/721
WEBS 2-14=-963/0, 2-13=0/629, 3-13=-599/0, 3-12=0/252, 4-12=-252/128, 6-8=-957/0, 6-9=0/622, 5-9=-745/0

- NOTES-**
- 1) Unbalanced floor live loads have been considered for this design.
 - 2) All plates are 3x4 MT20 unless otherwise indicated.
 - 3) Plates checked for a plus or minus 1 degree rotation about its center.
 - 4) Recommend 2x6 strongbacks, on edge, spaced at 10-0-0 oc and fastened to each truss with 3-10d (0.131" X 3") nails. Strongbacks to be attached to walls at their outer ends or restrained by other means.



WARNING - Verify design parameters and READ NOTES ON THIS AND INCLUDED MITEK REFERENCE PAGE MII-7473 rev. 1/2/2023 BEFORE USE.
Design valid for use only with MiTek® connectors. This design is based only upon parameters shown, and is for an individual building component, not a truss system. Before use, the building designer must verify the applicability of design parameters and properly incorporate this design into the overall building design. Bracing indicated is to prevent buckling of individual truss web and/or chord members only. Additional temporary and permanent bracing is always required for stability and to prevent collapse with possible personal injury and property damage. For general guidance regarding the fabrication, storage, delivery, erection and bracing of trusses and truss systems, see **ANSI/TPH Quality Criteria and DSB-22** available from Truss Plate Institute (www.tpinst.org) and **BCSI Building Component Safety Information** available from the Structural Building Component Association (www.sbcacomponents.com)



818 Soundside Road
Edenton, NC 27932

Job J1023-6083	Truss F05	Truss Type GABLE	Qty 1	Ply 1	Lot A Hobby Rd Job Reference (optional)	I59138484
-------------------	--------------	---------------------	----------	----------	--	-----------

Comtech, Inc. Fayetteville, NC - 28314,

8.430 s Jan 6 2022 MiTek Industries, Inc. Thu Jun 22 18:12:06 2023 Page 1
ID:wAaOiCu?enbzdIvzeiq6d3zFzeT-RfC?PsB70Hq3NSgPqnL8w3uITXbGKWrCDoi7J4zJC?f

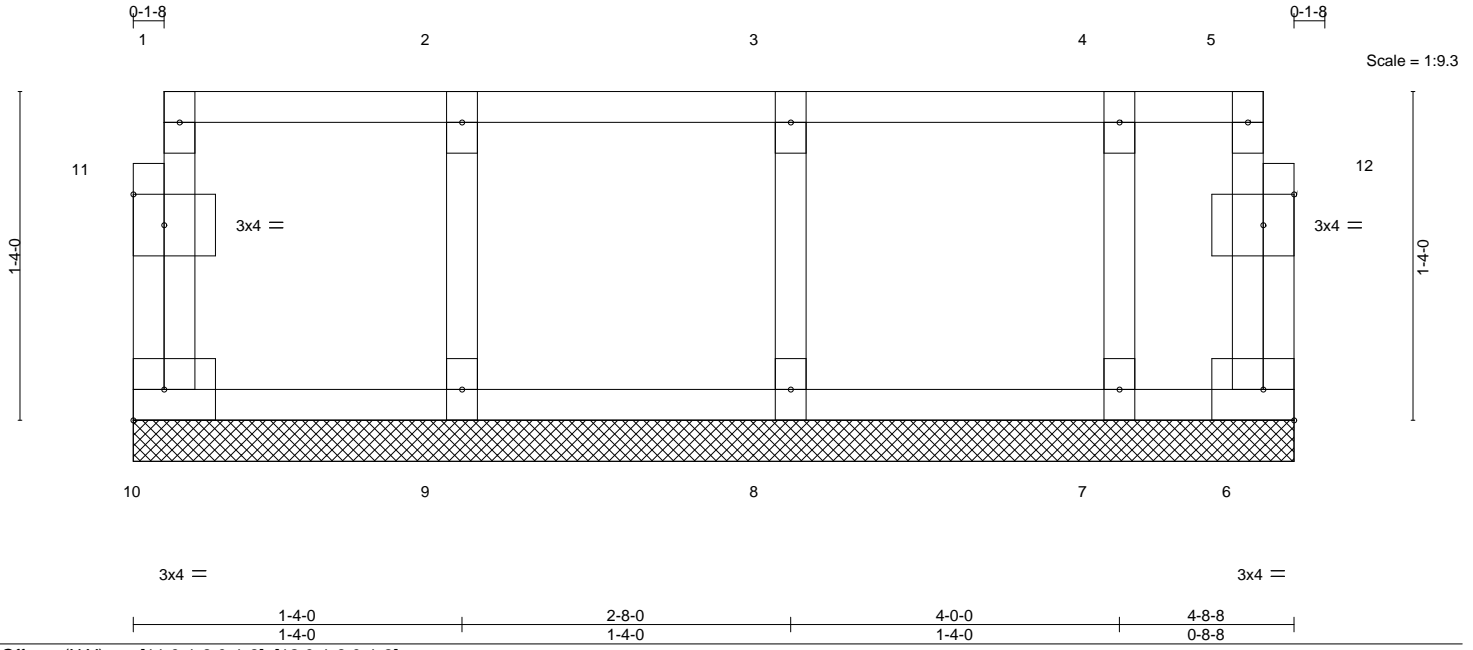

LOADING (psf)	SPACING-	2-0-0	CSI.	DEFL.	in (loc)	l/defl	L/d	PLATES	GRIP
TCLL 40.0	Plate Grip DOL	1.00	TC 0.06	Vert(LL)	n/a	-	n/a	MT20	244/190
TCDL 10.0	Lumber DOL	1.00	BC 0.01	Vert(CT)	n/a	-	n/a		
BCLL 0.0	Rep Stress Incr	YES	WB 0.03	Horz(CT)	0.00	6	n/a		
BCDL 5.0	Code IRC2015/TPI2014		Matrix-R						
								Weight: 24 lb	FT = 20%F, 11%E

LUMBER-	BRACING-
TOP CHORD 2x4 SP No.1(flat)	TOP CHORD Structural wood sheathing directly applied or 4-8-8 oc purlins, except end verticals.
BOT CHORD 2x4 SP No.1(flat)	BOT CHORD Rigid ceiling directly applied or 10-0-0 oc bracing.
WEBS 2x4 SP No.3(flat)	
OTHERS 2x4 SP No.3(flat)	

REACTIONS. All bearings 4-8-8.
(lb) - Max Grav All reactions 250 lb or less at joint(s) 10, 6, 9, 8, 7

FORCES. (lb) - Max. Comp./Max. Ten. - All forces 250 (lb) or less except when shown.

- NOTES-**
- 1) All plates are 1.5x3 MT20 unless otherwise indicated.
 - 2) Plates checked for a plus or minus 1 degree rotation about its center.
 - 3) Gable requires continuous bottom chord bearing.
 - 4) Truss to be fully sheathed from one face or securely braced against lateral movement (i.e. diagonal web).
 - 5) Gable studs spaced at 1-4-0 oc.
 - 6) Recommend 2x6 strongbacks, on edge, spaced at 10-0-0 oc and fastened to each truss with 3-10d (0.131" X 3") nails. Strongbacks to be attached to walls at their outer ends or restrained by other means.

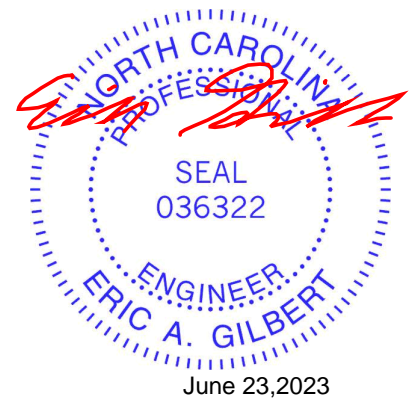

Job	Truss	Truss Type	Qty	Ply	Lot A Hobby Rd	I59138485
J1023-6083	FW01	GABLE	1	1	Job Reference (optional)	

Comtech, Inc. Fayetteville, NC - 28314,

8.430 s Jan 6 2022 MiTek Industries, Inc. Thu Jun 22 18:12:07 2023 Page 1
 ID:wAaOiCu?enbzdIvzeiq6d3zFzeT-RfC?PsB70Hq3NSgPqnL8w3uITXbGKWrCDoi7J4zJC?f

0-1-8

Scale = 1:29.4

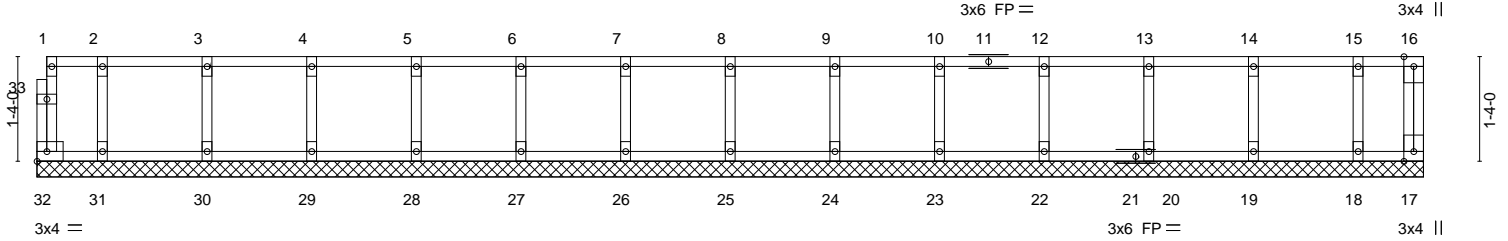

0-10-0	2-2-0	3-6-0	4-10-0	6-2-0	7-6-0	8-10-0	10-2-0	11-6-0	12-10-0	14-2-0	15-6-0	16-10-0	17-8-0
0-10-0	1-4-0	1-4-0	1-4-0	1-4-0	1-4-0	1-4-0	1-4-0	1-4-0	1-4-0	1-4-0	1-4-0	1-4-0	0-10-0

LOADING (psf)	SPACING-	2-0-0	CSI.	DEFL.	in (loc)	l/defl	L/d	PLATES	GRIP
TCLL 40.0	Plate Grip DOL	1.00	TC 0.06	Vert(LL)	n/a	-	n/a	MT20	244/190
TCDL 10.0	Lumber DOL	1.00	BC 0.01	Vert(CT)	n/a	-	n/a		
BCLL 0.0	Rep Stress Incr	YES	WB 0.03	Horz(CT)	0.00	17	n/a		
BCDL 5.0	Code IRC2015/TPI2014		Matrix-R						
								Weight: 79 lb	FT = 20%F, 11%E

LUMBER-
 TOP CHORD 2x4 SP No.1(flat)
 BOT CHORD 2x4 SP No.1(flat)
 WEBS 2x4 SP No.3(flat)
 OTHERS 2x4 SP No.3(flat)

BRACING-
 TOP CHORD Structural wood sheathing directly applied or 6-0-0 oc purlins, except end verticals.
 BOT CHORD Rigid ceiling directly applied or 10-0-0 oc bracing.

REACTIONS. All bearings 17-8-0.
 (lb) - Max Grav All reactions 250 lb or less at joint(s) 17, 32, 25, 26, 27, 28, 29, 30, 31, 24, 23, 22, 20, 19, 18

FORCES. (lb) - Max. Comp./Max. Ten. - All forces 250 (lb) or less except when shown.

- NOTES-**
- 1) All plates are 1.5x3 MT20 unless otherwise indicated.
 - 2) Plates checked for a plus or minus 1 degree rotation about its center.
 - 3) Gable requires continuous bottom chord bearing.
 - 4) Truss to be fully sheathed from one face or securely braced against lateral movement (i.e. diagonal web).
 - 5) Gable studs spaced at 1-4-0 oc.
 - 6) Recommend 2x6 strongbacks, on edge, spaced at 10-0-0 oc and fastened to each truss with 3-10d (0.131" X 3") nails. Strongbacks to be attached to walls at their outer ends or restrained by other means.
 - 7) CAUTION, Do not erect truss backwards.



June 23, 2023

WARNING - Verify design parameters and READ NOTES ON THIS AND INCLUDED MITEK REFERENCE PAGE MII-7473 rev. 1/2/2023 BEFORE USE.
 Design valid for use only with MiTek® connectors. This design is based only upon parameters shown, and is for an individual building component, not a truss system. Before use, the building designer must verify the applicability of design parameters and properly incorporate this design into the overall building design. Bracing indicated is to prevent buckling of individual truss web and/or chord members only. Additional temporary and permanent bracing is always required for stability and to prevent collapse with possible personal injury and property damage. For general guidance regarding the fabrication, storage, delivery, erection and bracing of trusses and truss systems, see **ANSI/TPH Quality Criteria and DSB-22** available from Truss Plate Institute (www.tpinst.org) and **BCSI Building Component Safety Information** available from the Structural Building Component Association (www.sbcacomponents.com)



818 Soundside Road
 Edenton, NC 27932

Job J1023-6083	Truss FW02	Truss Type GABLE	Qty 1	Ply 1	Lot A Hobby Rd I59138486
-------------------	---------------	---------------------	----------	----------	-----------------------------

Comtech, Inc. Fayetteville, NC - 28314,

8.430 s Jan 6 2022 MiTek Industries, Inc. Thu Jun 22 18:12:09 2023 Page 1
ID:wAaOiCu?enbzdIvzeiq6d3zFzeT-RfC?PsB70Hq3NSgPqnL8w3uITXbGKWrCDoi7J4zJC?f

0-1-8

0-1-8

Scale = 1:29.8

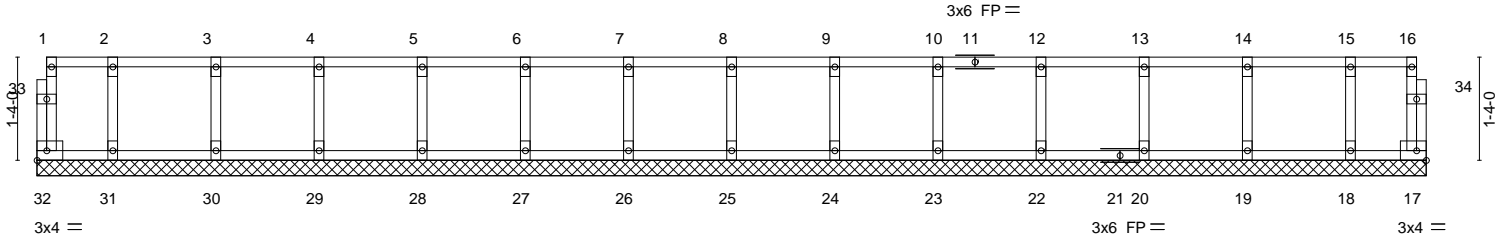

0-11-12	2-3-12	3-7-12	4-11-12	6-3-12	7-7-12	8-11-12	10-3-12	11-7-12	12-11-12	14-3-12	15-7-12	16-11-12	17-11-8
0-11-12	1-4-0	1-4-0	1-4-0	1-4-0	1-4-0	1-4-0	1-4-0	1-4-0	1-4-0	1-4-0	1-4-0	1-4-0	0-11-12

LOADING (psf)	SPACING-	2-0-0	CSI.	DEFL.	in (loc)	l/defl	L/d	PLATES	GRIP	
TCLL 40.0	Plate Grip DOL	1.00	TC 0.06	Vert(LL)	n/a	-	n/a	999	MT20	244/190
TCDL 10.0	Lumber DOL	1.00	BC 0.01	Vert(CT)	n/a	-	n/a	999		
BCLL 0.0	Rep Stress Incr	YES	WB 0.03	Horz(CT)	0.00	17	n/a	n/a		
BCDL 5.0	Code IRC2015/TPI2014		Matrix-R						Weight: 80 lb	FT = 20%F, 11%E

LUMBER-	BRACING-
TOP CHORD 2x4 SP No.1(flat)	TOP CHORD Structural wood sheathing directly applied or 6-0-0 oc purlins, except end verticals.
BOT CHORD 2x4 SP No.1(flat)	BOT CHORD Rigid ceiling directly applied or 10-0-0 oc bracing.
WEBS 2x4 SP No.3(flat)	
OTHERS 2x4 SP No.3(flat)	

REACTIONS. All bearings 17-11-8.
(lb) - Max Grav All reactions 250 lb or less at joint(s) 32, 17, 25, 26, 27, 28, 29, 30, 31, 24, 23, 22, 20, 19, 18

FORCES. (lb) - Max. Comp./Max. Ten. - All forces 250 (lb) or less except when shown.

- NOTES-**
- 1) All plates are 1.5x3 MT20 unless otherwise indicated.
 - 2) Plates checked for a plus or minus 1 degree rotation about its center.
 - 3) Gable requires continuous bottom chord bearing.
 - 4) Truss to be fully sheathed from one face or securely braced against lateral movement (i.e. diagonal web).
 - 5) Gable studs spaced at 1-4-0 oc.
 - 6) Recommend 2x6 strongbacks, on edge, spaced at 10-0-0 oc and fastened to each truss with 3-10d (0.131" X 3") nails. Strongbacks to be attached to walls at their outer ends or restrained by other means.

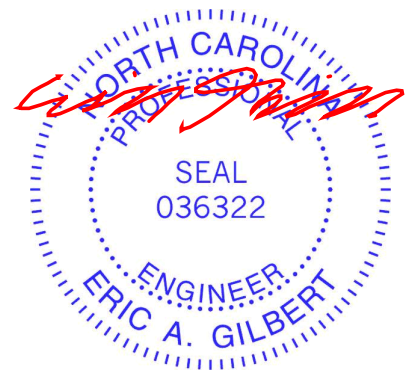

Job J1023-6083	Truss FW03	Truss Type GABLE	Qty 1	Ply 1	Lot A Hobby Rd I59138487
-------------------	---------------	---------------------	----------	----------	-----------------------------

Comtech, Inc. Fayetteville, NC - 28314,

8.430 s Jan 6 2022 MiTek Industries, Inc. Thu Jun 22 18:12:10 2023 Page 1
ID:wAaOiCu?enbzDIvzeiq6d3zFzeT-RfC?PsB70Hq3NSgPqnL8w3uITXbGKWrCDoi7J4zJC?f

0-1-8

0-1-8

Scale = 1:21.4

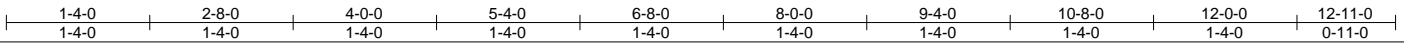
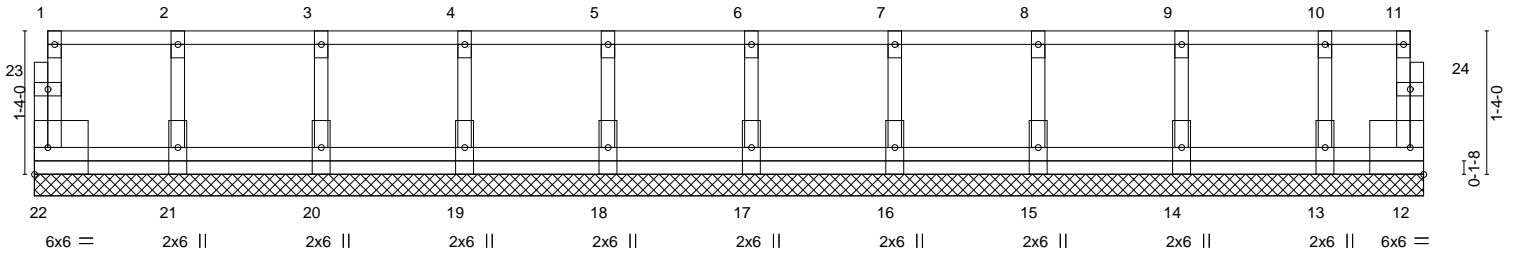

LOADING (psf)	SPACING-	2-0-0	CSI.	DEFL.	in (loc)	l/defl	L/d	PLATES	GRIP	
TCLL 40.0	Plate Grip DOL	1.00	TC 0.06	Vert(LL)	n/a	-	n/a	999	MT20	244/190
TCDL 10.0	Lumber DOL	1.00	BC 0.01	Vert(CT)	n/a	-	n/a	999		
BCLL 0.0	Rep Stress Incr	YES	WB 0.03	Horz(CT)	0.00	12	n/a	n/a		
BCDL 5.0	Code IRC2015/TPI2014		Matrix-R						Weight: 75 lb	FT = 20%F, 11%E

LUMBER-
TOP CHORD 2x4 SP No.1(flat)
BOT CHORD 2x4 SP No.1(flat)
WEBS 2x4 SP No.3(flat)
OTHERS 2x4 SP No.3(flat)

BRACING-
TOP CHORD Structural wood sheathing directly applied or 6-0-0 oc purlins, except end verticals.
BOT CHORD Rigid ceiling directly applied or 10-0-0 oc bracing.

REACTIONS. All bearings 12-11-0.
(lb) - Max Grav All reactions 250 lb or less at joint(s) 22, 12, 21, 20, 19, 18, 17, 16, 15, 14, 13

FORCES. (lb) - Max. Comp./Max. Ten. - All forces 250 (lb) or less except when shown.

- NOTES-**
- 1) All plates are 1.5x3 MT20 unless otherwise indicated.
 - 2) Plates checked for a plus or minus 1 degree rotation about its center.
 - 3) Gable requires continuous bottom chord bearing.
 - 4) Truss to be fully sheathed from one face or securely braced against lateral movement (i.e. diagonal web).
 - 5) Gable studs spaced at 1-4-0 oc.
 - 6) Recommend 2x6 strongbacks, on edge, spaced at 10-0-0 oc and fastened to each truss with 3-10d (0.131" X 3") nails. Strongbacks to be attached to walls at their outer ends or restrained by other means.



June 23, 2023

WARNING - Verify design parameters and READ NOTES ON THIS AND INCLUDED MITEK REFERENCE PAGE MII-7473 rev. 1/2/2023 BEFORE USE.
Design valid for use only with MiTek® connectors. This design is based only upon parameters shown, and is for an individual building component, not a truss system. Before use, the building designer must verify the applicability of design parameters and properly incorporate this design into the overall building design. Bracing indicated is to prevent buckling of individual truss web and/or chord members only. Additional temporary and permanent bracing is always required for stability and to prevent collapse with possible personal injury and property damage. For general guidance regarding the fabrication, storage, delivery, erection and bracing of trusses and truss systems, see **ANSI/TP1 Quality Criteria and DSB-22** available from Truss Plate Institute (www.tpinst.org) and **BCSI Building Component Safety Information** available from the Structural Building Component Association (www.sbcacomponents.com)

ENGINEERING BY
TRENCO
A MiTek Affiliate
818 Soundside Road
Edenton, NC 27932

Symbols

PLATE LOCATION AND ORIENTATION

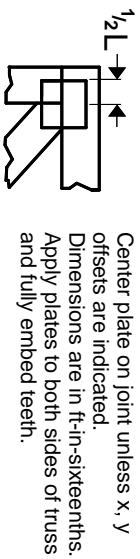

Center plate on joint unless x, y offsets are indicated. Dimensions are in ft-in-sixteenths. Apply plates to both sides of truss and fully embed teeth.

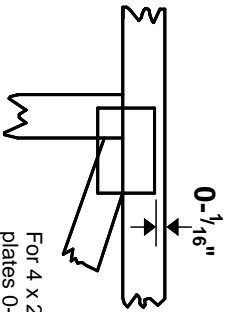

For 4 x 2 orientation, locate plates 0- 1/16\" from outside edge of truss.



This symbol indicates the required direction of slots in connector plates.

* Plate location details available in MITek software or upon request.

PLATE SIZE

4 X 4

The first dimension is the plate width measured perpendicular to slots. Second dimension is the length parallel to slots.

LATERAL BRACING LOCATION



Indicated by symbol shown and/or by text in the bracing section of the output. Use T or I bracing if indicated.

BEARING

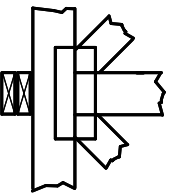

Indicates location where bearings (supports) occur. Icons vary but reaction section indicates joint number/letter where bearings occur. Min size shown is for crushing only.

Industry Standards:

ANSI/TP1: National Design Specification for Metal Plate Connected Wood Truss Construction.
DSB-22: Design Standard for Bracing.
BCSI: Building Component Safety Information, Guide to Good Practice for Handling, Installing, Restraining & Bracing of Metal Plate Connected Wood Trusses.

Numbering System

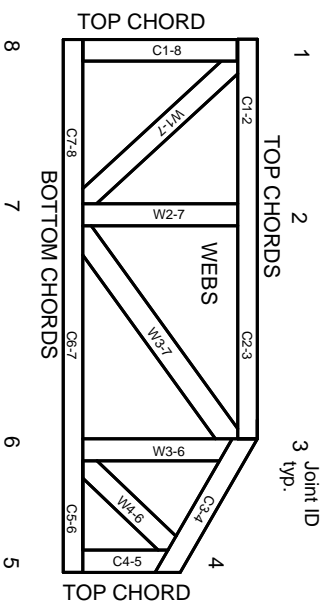

JOINTS ARE GENERALLY NUMBERED/LETTERED CLOCKWISE AROUND THE TRUSS STARTING AT THE JOINT FARTHEST TO THE LEFT.

CHORDS AND WEBS ARE IDENTIFIED BY END JOINT NUMBERS/LETTERS.

Product Code Approvals

ICC-ES Reports:

ESR-1988, ESR-2362, ESR-2685, ESR-3282
ESR-4722, ESL-1388

Design General Notes

Trusses are designed for wind loads in the plane of the truss unless otherwise shown.

Lumber design values are in accordance with ANSI/TP1 section 6.3. These truss designs rely on lumber values established by others.

© 2023 MITek® All Rights Reserved

MITek

ENGINEERING BY
TRENGO
A MITek Affiliate

MITek Engineering Reference Sheet: MIL-7473 rev. 1/2/2023

General Safety Notes

Failure to Follow Could Cause Property Damage or Personal Injury

1. Additional stability/bracing for truss system, e.g. diagonal or X-bracing, is always required. See BCSI.
2. Truss bracing must be designed by an engineer. For wide truss spacing, individual lateral braces themselves may require bracing, or alternative Tor I bracing should be considered.
3. Never exceed the design loading shown and never stack materials on inadequately braced trusses.
4. Provide copies of this truss design to the building designer, erection supervisor, property owner and all other interested parties.
5. Cut members to bear tightly against each other.
6. Place plates on each face of truss at each joint and embed fully. Knots and wane at joint locations are regulated by ANSI/TP1 1.
7. Design assumes trusses will be suitably protected from the environment in accord with ANSI/TP1 1.
8. Unless otherwise noted, moisture content of lumber shall not exceed 19% at time of fabrication.
9. Unless expressly noted, this design is not applicable for use with fire retardant, preservative treated, or green lumber.
10. Camber is a non-structural consideration and is the responsibility of truss fabricator. General practice is to camber for dead load deflection.
11. Plate type, size, orientation and location dimensions indicated are minimum plating requirements.
12. Lumber used shall be of the species and size, and in all respects, equal to or better than that specified.
13. Top chords must be sheathed or purlins provided at spacing indicated on design.
14. Bottom chords require lateral bracing at 10 ft. spacing, or less, if no ceiling is installed, unless otherwise noted.
15. Connections not shown are the responsibility of others.
16. Do not cut or alter truss member or plate without prior approval of an engineer.
17. Install and load vertically unless indicated otherwise.
18. Use of green or treated lumber may pose unacceptable environmental, health or performance risks. Consult with project engineer before use.
19. Review all portions of this design (front, back, words and pictures) before use. Reviewing pictures alone is not sufficient.
20. Design assumes manufacture in accordance with ANSI/TP1 1 Quality Criteria.
21. The design does not take into account any dynamic or other loads other than those expressly stated.