

Trenco
818 Soundside Rd
Edenton, NC 27932

Re: J1123-6664
Lot 17 Heritage @ NC

The truss drawing(s) referenced below have been prepared by Truss Engineering Co. under my direct supervision based on the parameters provided by Comtech, Inc - Fayetteville.

Pages or sheets covered by this seal: I62214232 thru I62214247

My license renewal date for the state of North Carolina is December 31, 2023.

North Carolina COA: C-0844



November 28, 2023

Gilbert, Eric

IMPORTANT NOTE: The seal on these truss component designs is a certification that the engineer named is licensed in the jurisdiction(s) identified and that the designs comply with ANSI/TPI 1. These designs are based upon parameters shown (e.g., loads, supports, dimensions, shapes and design codes), which were given to MiTek or TRENCO. Any project specific information included is for MiTek's or TRENCO's customers file reference purpose only, and was not taken into account in the preparation of these designs. MiTek or TRENCO has not independently verified the applicability of the design parameters or the designs for any particular building. Before use, the building designer should verify applicability of design parameters and properly incorporate these designs into the overall building design per ANSI/TPI 1, Chapter 2.

Job J1123-6664	Truss F01	Truss Type Floor	Qty 4	Ply 1	Lot 17 Heritage @ NC 162214232
-------------------	--------------	---------------------	----------	----------	-----------------------------------

Comtech, Inc. Fayetteville, NC - 28314,

8.430 s Jan 6 2022 MiTek Industries, Inc. Mon Nov 27 16:15:26 2023 Page 1
ID:JQb1igK2ne3CQdqy3dwnCxyStrD-RfC?PsB70Hq3NSgPqnL8w3uITXbGKWrCDoi7J4zJC?f

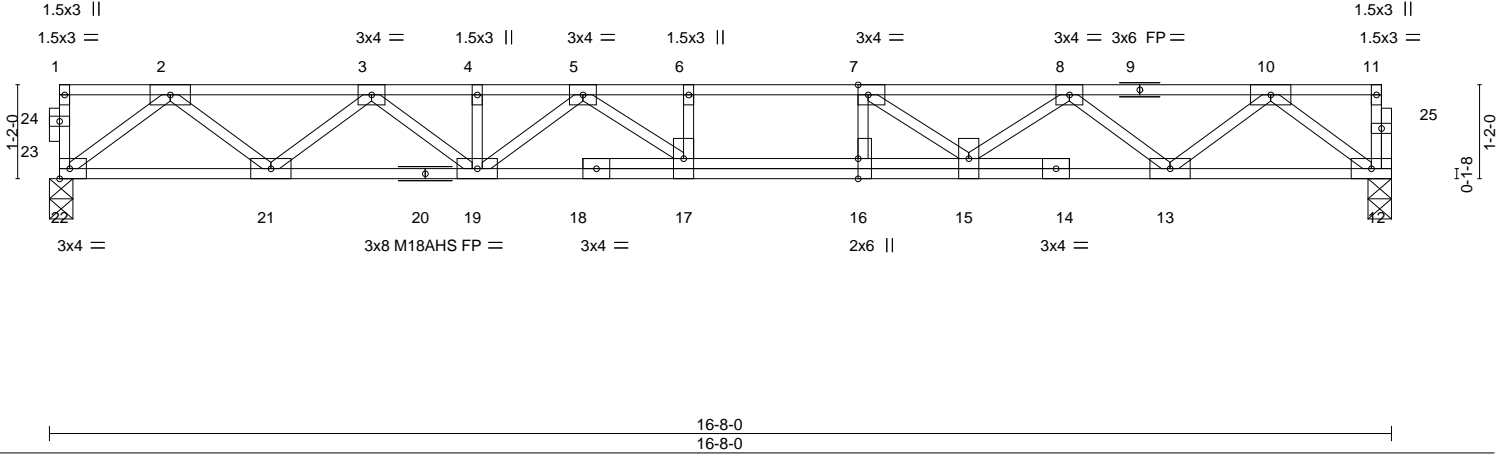
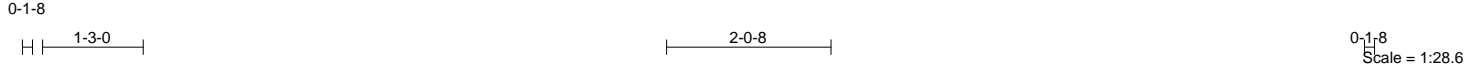

Plate Offsets (X,Y)--	[7:0-1-8,Edge], [16:0-3-0,Edge]				
LOADING (psf)	SPACING- 2-0-0	CSI.	DEFL. in (loc) l/defl L/d	PLATES	GRIP
TCLL 40.0	Plate Grip DOL 1.00	TC 0.41	Vert(LL) -0.20 16-17 >997 480	MT20 244/190	
TCDL 10.0	Lumber DOL 1.00	BC 0.71	Vert(CT) -0.27 16-17 >724 360	M18AHS 186/179	
BCLL 0.0	Rep Stress Incr YES	WB 0.47	Horz(CT) 0.05 12 n/a n/a		
BCDL 5.0	Code IRC2015/TPI2014	Matrix-S			Weight: 91 lb FT = 20%F, 11%E

LUMBER-	BRACING-
TOP CHORD 2x4 SP No.1(flat)	TOP CHORD Structural wood sheathing directly applied or 6-0-0 oc purlins, except end verticals.
BOT CHORD 2x4 SP No.1(flat)	BOT CHORD Rigid ceiling directly applied or 10-0-0 oc bracing.
WEBS 2x4 SP No.3(flat)	

REACTIONS. (size) 22=0-3-8, 12=0-3-8
Max Grav 22=899(LC 1), 12=893(LC 1)

FORCES. (lb) - Max. Comp./Max. Ten. - All forces 250 (lb) or less except when shown.
 TOP CHORD 2-3=-1833/0, 3-4=-3019/0, 4-5=-3019/0, 5-6=-3644/0, 6-7=-3644/0, 7-8=-3099/0, 8-10=-1861/0
 BOT CHORD 21-22=0/1076, 19-21=0/2545, 17-19=0/3409, 16-17=0/3644, 15-16=0/3644, 13-15=0/2622, 12-13=0/1109
 WEBS 2-22=-1374/0, 2-21=0/985, 3-21=-927/0, 3-19=0/605, 10-12=-1389/0, 10-13=0/979, 8-13=-991/0, 8-15=0/605, 7-15=-853/0, 7-16=-95/331, 5-19=-498/0, 5-17=0/550

- NOTES-**
- 1) Unbalanced floor live loads have been considered for this design.
 - 2) All plates are MT20 plates unless otherwise indicated.
 - 3) All plates are 3x6 MT20 unless otherwise indicated.
 - 4) Plates checked for a plus or minus 1 degree rotation about its center.
 - 5) Recommend 2x6 strongbacks, on edge, spaced at 10-0-0 oc and fastened to each truss with 3-10d (0.131" X 3") nails. Strongbacks to be attached to walls at their outer ends or restrained by other means.

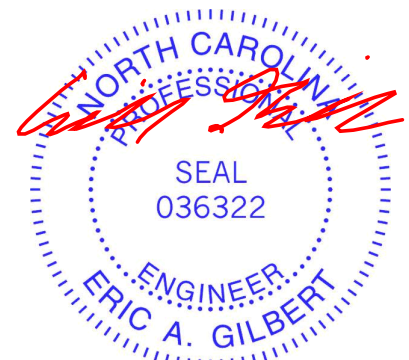

November 28, 2023

Job J1123-6664	Truss F02	Truss Type FLOOR	Qty 3	Ply 1	Lot 17 Heritage @ NC 62214233
-------------------	--------------	---------------------	----------	----------	----------------------------------

Comtech, Inc. Fayetteville, NC - 28314,

8.430 s Jan 6 2022 MiTek Industries, Inc. Mon Nov 27 16:15:27 2023 Page 1
ID:JQb1igK2ne3CQdqy3dwnCxyStrD-RfC?PsB70Hq3NSgPqnL8w3ulTXbGKWrCDoi7J4zJC?f

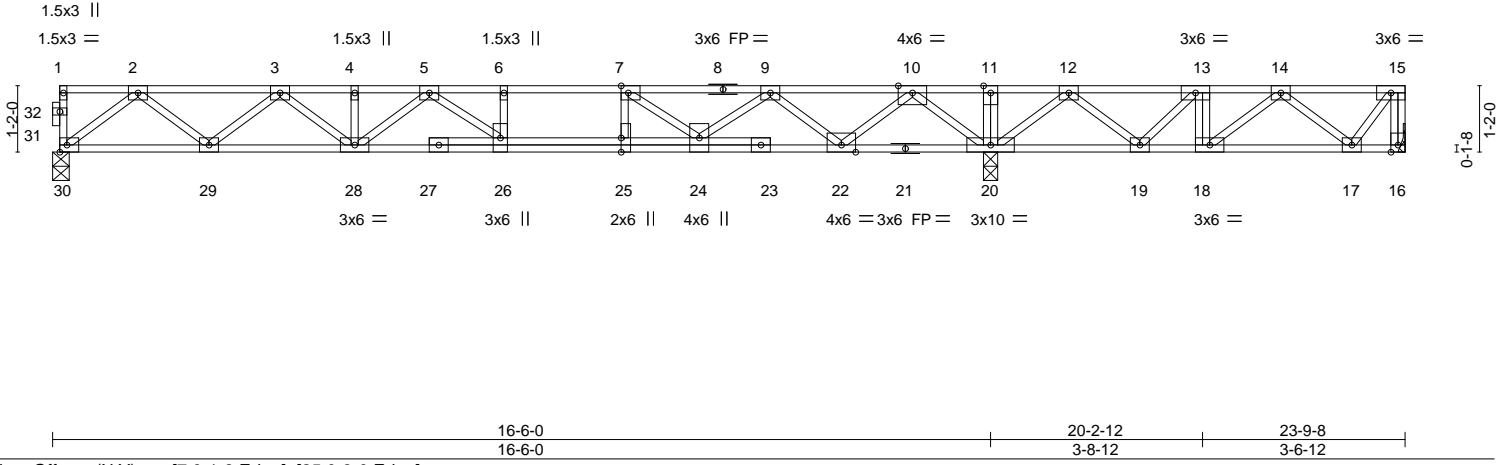

LOADING (psf)	SPACING-	CSI.	DEFL.	PLATES	GRIP
TCLL 40.0	2-0-0	TC 0.52	in (loc) l/defl L/d	MT20	244/190
TCDL 10.0	Plate Grip DOL 1.00	BC 0.61	Vert(LL) -0.16 26-28 >999 480		
BCLL 0.0	Lumber DOL 1.00	WB 0.56	Vert(CT) -0.22 26-28 >905 360		
BCDL 5.0	Rep Stress Incr YES	Matrix-S	Horz(CT) 0.03 20 n/a n/a		
	Code IRC2015/TPI2014			Weight: 131 lb	FT = 20%F, 11%E

LUMBER-	BRACING-
TOP CHORD 2x4 SP No.1(flat)	TOP CHORD Structural wood sheathing directly applied or 6-0-0 oc purlins, except end verticals.
BOT CHORD 2x4 SP No.1(flat)	BOT CHORD Rigid ceiling directly applied or 6-0-0 oc bracing.
WEBS 2x4 SP No.3(flat)	

REACTIONS. (size) 16=Mechanical, 30=0-3-8, 20=0-3-0
 Max Uplift 16=185(LC 3)
 Max Grav 16=290(LC 4), 30=769(LC 3), 20=1741(LC 1)

FORCES. (lb) - Max. Comp./Max. Ten. - All forces 250 (lb) or less except when shown.
 TOP CHORD 15-16=-292/183, 2-3=-1508/0, 3-4=-2396/0, 4-5=-2396/0, 5-6=-2504/0, 6-7=-2504/0, 7-9=-1669/0, 10-11=0/2111, 11-12=0/2111, 12-13=-146/1105, 13-14=-367/766
 BOT CHORD 29-30=0/909, 28-29=0/2076, 26-28=0/2563, 25-26=0/2504, 24-25=0/2504, 22-24=0/1052, 20-22=-842/0, 19-20=-1502/0, 18-19=-766/367, 17-18=-424/377
 WEBS 13-18=0/280, 2-30=-1161/0, 2-29=0/779, 3-29=-740/0, 3-28=0/408, 10-20=-1592/0, 10-22=0/1180, 9-22=-1150/0, 9-24=0/796, 7-24=-1099/0, 7-25=0/453, 12-20=-1049/0, 12-19=0/671, 13-19=-609/0, 14-18=-430/0, 14-17=-283/349, 15-17=-254/259

- NOTES-**
- 1) Unbalanced floor live loads have been considered for this design.
 - 2) All plates are 3x4 MT20 unless otherwise indicated.
 - 3) Plates checked for a plus or minus 1 degree rotation about its center.
 - 4) Refer to girder(s) for truss to truss connections.
 - 5) Provide mechanical connection (by others) of truss to bearing plate capable of withstanding 100 lb uplift at joint(s) except (jt=lb) 16=185.
 - 6) Recommend 2x6 strongbacks, on edge, spaced at 10-0-0 oc and fastened to each truss with 3-10d (0.131" X 3") nails. Strongbacks to be attached to walls at their outer ends or restrained by other means.
 - 7) CAUTION, Do not erect truss backwards.

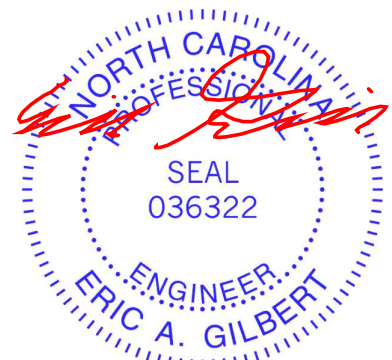

November 28, 2023

<p>WARNING - Verify design parameters and READ NOTES ON THIS AND INCLUDED MITEK REFERENCE PAGE MII-7473 rev. 1/2/2023 BEFORE USE.</p> <p>Design valid for use only with MiTek® connectors. This design is based only upon parameters shown, and is for an individual building component, not a truss system. Before use, the building designer must verify the applicability of design parameters and properly incorporate this design into the overall building design. Bracing indicated is to prevent buckling of individual truss web and/or chord members only. Additional temporary and permanent bracing is always required for stability and to prevent collapse with possible personal injury and property damage. For general guidance regarding the fabrication, storage, delivery, erection and bracing of trusses and truss systems, see ANSI/TPH Quality Criteria and DSB-22 available from Truss Plate Institute (www.tpinst.org) and BCSI Building Component Safety Information available from the Structural Building Component Association (www.sbcacomponents.com)</p>	<p>ENGINEERING BY</p> <p>A MiTek Affiliate</p> <p>818 Soundside Road Edenton, NC 27932</p>
--	--

Job J1123-6664	Truss F03	Truss Type FLOOR	Qty 3	Ply 1	Lot 17 Heritage @ NC 162214234
-------------------	--------------	---------------------	----------	----------	-----------------------------------

Comtech, Inc. Fayetteville, NC - 28314,

8.430 s Jan 6 2022 MiTek Industries, Inc. Mon Nov 27 16:15:29 2023 Page 1
ID:JQb1gk2ne3CQdqy3dwnCxyStrD-RfC?PsB70Hq3NSgPqnL8w3uITXbGKWrCDoi7J4zJC?f



Scale = 1:45.4

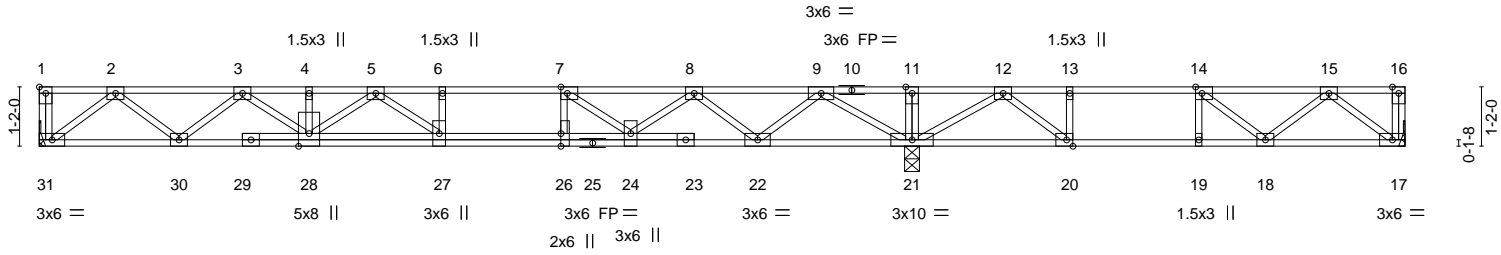

Plate Offsets (X, Y)--	[1:Edge,0-1-8], [7:0-1-8,Edge], [14:0-1-8,Edge], [26:0-3-0,Edge]
------------------------	--

LOADING (psf)	SPACING- 1-7-3	CSI.	DEFL. in (loc) l/defl L/d	PLATES	GRIP
TCLL 40.0	Plate Grip DOL 1.00	TC 0.59	Vert(LL) -0.17 27-28 >999 480	MT20	244/190
TCDL 10.0	Lumber DOL 1.00	BC 0.59	Vert(CT) -0.23 27-28 >878 360		
BCLL 0.0	Rep Stress Incr YES	WB 0.42	Horz(CT) 0.04 17 n/a n/a		
BCDL 5.0	Code IRC2015/TP12014	Matrix-S			
				Weight: 145 lb	FT = 20%F, 11%E

LUMBER-	BRACING-
TOP CHORD 2x4 SP No.1(flat)	TOP CHORD Structural wood sheathing directly applied or 6-0-0 oc purlins, except end verticals.
BOT CHORD 2x4 SP No.1(flat)	BOT CHORD Rigid ceiling directly applied or 10-0-0 oc bracing, Except: 6-0-0 oc bracing: 20-21,19-20,18-19.
WEBS 2x4 SP No.3(flat)	

REACTIONS. (size) 31=Mechanical, 21=0-3-8, 17=Mechanical
Max Grav 31=706(LC 10), 21=1322(LC 1), 17=395(LC 4)

FORCES. (lb) - Max. Comp./Max. Ten. - All forces 250 (lb) or less except when shown.
TOP CHORD 2-3=-1449/0, 3-4=-2485/0, 4-5=-2485/0, 5-6=-2806/0, 6-7=-2806/0, 7-8=-2250/0, 8-9=-1182/0, 9-11=0/1057, 11-12=0/1057, 12-13=-797/230, 13-14=-797/230, 14-15=-675/43
BOT CHORD 30-31=0/872, 28-30=0/2051, 27-28=0/2730, 26-27=0/2806, 24-26=0/2806, 22-24=0/1823, 21-22=0/528, 20-21=-555/405, 19-20=-230/797, 18-19=-230/797, 17-18=0/483
WEBS 2-31=-1094/0, 2-30=0/752, 3-30=-784/0, 3-28=0/541, 5-28=-323/0, 5-27=-119/336, 9-21=-1448/0, 9-22=0/883, 8-22=-864/0, 8-24=0/576, 7-24=-817/0, 7-26=-21/322, 12-21=-859/0, 12-20=0/714, 15-17=-606/0, 15-18=-94/251, 13-20=-327/0

- NOTES-**
- 1) Unbalanced floor live loads have been considered for this design.
 - 2) All plates are 3x4 MT20 unless otherwise indicated.
 - 3) Plates checked for a plus or minus 1 degree rotation about its center.
 - 4) Refer to girder(s) for truss to truss connections.
 - 5) Recommend 2x6 strongbacks, on edge, spaced at 10-0-0 oc and fastened to each truss with 3-10d (0.131" X 3") nails. Strongbacks to be attached to walls at their outer ends or restrained by other means.
 - 6) CAUTION, Do not erect truss backwards.

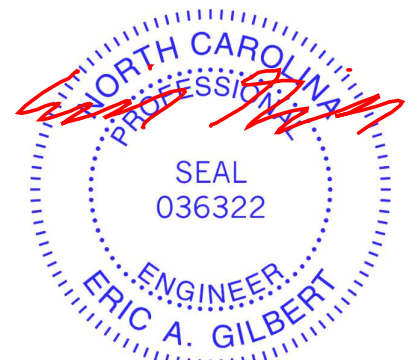

November 28, 2023

<p>WARNING - Verify design parameters and READ NOTES ON THIS AND INCLUDED MITEK REFERENCE PAGE MII-7473 rev. 1/2/2023 BEFORE USE.</p> <p>Design valid for use only with MiTek® connectors. This design is based only upon parameters shown, and is for an individual building component, not a truss system. Before use, the building designer must verify the applicability of design parameters and properly incorporate this design into the overall building design. Bracing indicated is to prevent buckling of individual truss web and/or chord members only. Additional temporary and permanent bracing is always required for stability and to prevent collapse with possible personal injury and property damage. For general guidance regarding the fabrication, storage, delivery, erection and bracing of trusses and truss systems, see ANSI/TP1 Quality Criteria and DSB-22 available from Truss Plate Institute (www.tpinst.org) and BCSI Building Component Safety Information available from the Structural Building Component Association (www.sbcacomponents.com)</p>	<p>818 Soundside Road Edenton, NC 27932</p>
--	---

Job J1123-6664	Truss F04	Truss Type FLOOR	Qty 3	Ply 1	Lot 17 Heritage @ NC 62214235
-------------------	--------------	---------------------	----------	----------	----------------------------------

Comtech, Inc. Fayetteville, NC - 28314,

8.430 s Jan 6 2022 MiTek Industries, Inc. Mon Nov 27 16:15:30 2023 Page 1
ID:JQb1gK2ne3CQdqy3dwnCxyStrD-RfC?PsB70Hq3NSgPqnL8w3ulTXbGKWrCDoi7J4zJC?f



Scale = 1:45.4

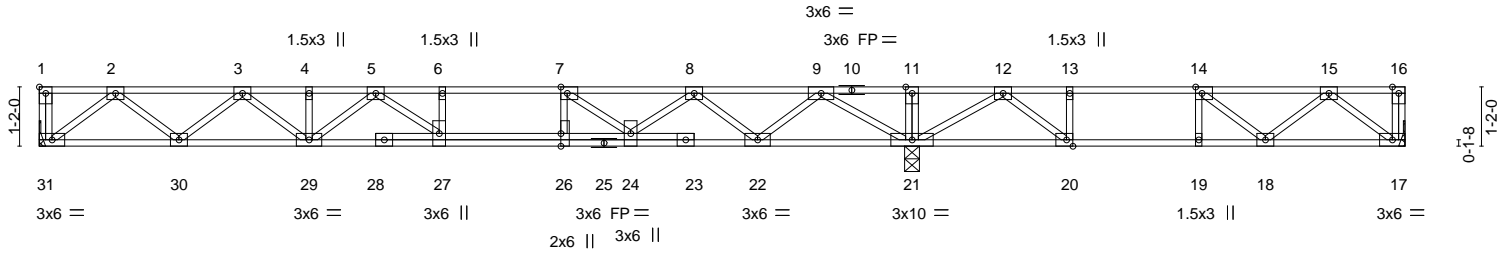

Plate Offsets (X, Y)--	[1:Edge,0-1-8], [7:0-1-8,Edge], [14:0-1-8,Edge], [26:0-3-0,Edge]
------------------------	--

LOADING (psf)	SPACING-	1-7-3	CSI.	DEFL.	in (loc)	l/defl	L/d	PLATES	GRIP	
TCLL 40.0	Plate Grip DOL	1.00	TC 0.60	Vert(LL)	-0.17	27	>999	480	MT20	244/190
TCDL 10.0	Lumber DOL	1.00	BC 0.60	Vert(CT)	-0.23	27	>888	360		
BCLL 0.0	Rep Stress Incr	YES	WB 0.42	Horz(CT)	0.04	17	n/a	n/a		
BCDL 5.0	Code IRC2015/TP12014		Matrix-S							

Weight: 142 lb FT = 20%F, 11%E

LUMBER-	BRACING-
TOP CHORD 2x4 SP No.1(flat)	TOP CHORD Structural wood sheathing directly applied or 6-0-0 oc purlins, except end verticals.
BOT CHORD 2x4 SP No.1(flat)	BOT CHORD Rigid ceiling directly applied or 10-0-0 oc bracing, Except: 6-0-0 oc bracing: 20-21,19-20,18-19.
WEBS 2x4 SP No.3(flat)	

REACTIONS. (size) 31=Mechanical, 21=0-3-8, 17=Mechanical
Max Grav 31=704(LC 10), 21=1328(LC 1), 17=394(LC 4)

FORCES. (lb) - Max. Comp./Max. Ten. - All forces 250 (lb) or less except when shown.
TOP CHORD 2-3=-1456/0, 3-4=-2361/0, 4-5=-2361/0, 5-6=-2767/0, 6-7=-2767/0, 7-8=-2226/0, 8-9=-1155/0, 9-11=0/1086, 11-12=0/1086, 12-13=-792/248, 13-14=-792/248, 14-15=-673/52
BOT CHORD 30-31=0/876, 29-30=0/2005, 27-29=0/2631, 26-27=0/2767, 24-26=0/2767, 22-24=0/1799, 21-22=0/497, 20-21=-581/398, 19-20=-248/792, 18-19=-248/792, 17-18=0/482
WEBS 2-31=-1099/0, 2-30=0/755, 3-30=-714/0, 3-29=0/455, 5-29=-344/0, 5-27=-53/378, 9-21=-1451/0, 9-22=0/887, 8-22=-868/0, 8-24=0/576, 7-24=-808/0, 7-26=-23/320, 12-21=-866/0, 12-20=0/725, 15-17=-605/0, 14-18=-152/250, 13-20=-332/0

- NOTES-**
- 1) Unbalanced floor live loads have been considered for this design.
 - 2) All plates are 3x4 MT20 unless otherwise indicated.
 - 3) Plates checked for a plus or minus 1 degree rotation about its center.
 - 4) Refer to girder(s) for truss to truss connections.
 - 5) Recommend 2x6 strongbacks, on edge, spaced at 10-0-0 oc and fastened to each truss with 3-10d (0.131" X 3") nails. Strongbacks to be attached to walls at their outer ends or restrained by other means.
 - 6) CAUTION, Do not erect truss backwards.



November 28, 2023

<p>WARNING - Verify design parameters and READ NOTES ON THIS AND INCLUDED MITEK REFERENCE PAGE MII-7473 rev. 1/2/2023 BEFORE USE.</p> <p>Design valid for use only with MiTek® connectors. This design is based only upon parameters shown, and is for an individual building component, not a truss system. Before use, the building designer must verify the applicability of design parameters and properly incorporate this design into the overall building design. Bracing indicated is to prevent buckling of individual truss web and/or chord members only. Additional temporary and permanent bracing is always required for stability and to prevent collapse with possible personal injury and property damage. For general guidance regarding the fabrication, storage, delivery, erection and bracing of trusses and truss systems, see ANSI/TP1 Quality Criteria and DSB-22 available from Truss Plate Institute (www.tpinst.org) and BCSI Building Component Safety Information available from the Structural Building Component Association (www.sbcacomponents.com)</p>	<p>818 Soundside Road Edenton, NC 27932</p>
--	---

Job J1123-6664	Truss F05	Truss Type FLOOR	Qty 3	Ply 1	Lot 17 Heritage @ NC 162214236
-------------------	--------------	---------------------	----------	----------	-----------------------------------

Comtech, Inc. Fayetteville, NC - 28314,

8.430 s Jan 6 2022 MiTek Industries, Inc. Mon Nov 27 16:15:32 2023 Page 1
ID:JQb1gK2ne3CQdqy3dwnCxyStrD-RfC?PsB70Hq3NSgPqnL8w3ulTXbGKWrCDoi7J4zJC?f



Scale = 1:45.4

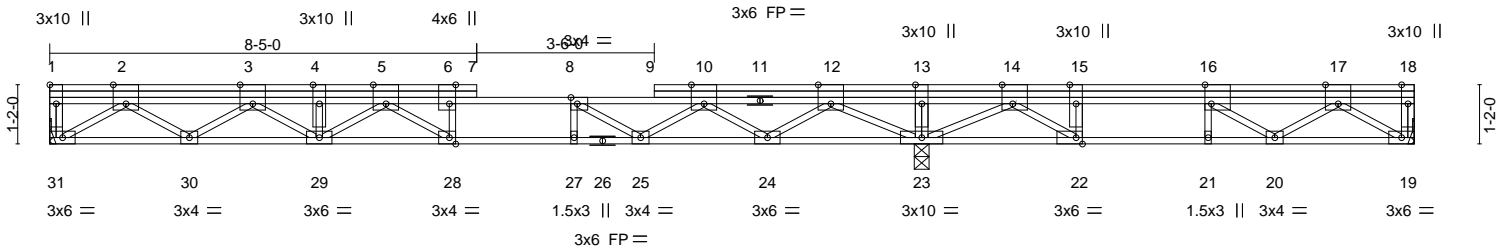

Plate Offsets (X,Y)--	[1:Edge,0-1-8], [2:0-3-0,Edge], [3:0-3-0,Edge], [5:0-3-0,Edge], [6:0-4-8,Edge], [8:0-1-8,Edge], [10:0-3-0,Edge], [12:0-3-0,Edge], [14:0-2-8,Edge], [16:0-1-8,Edge], [17:0-3-0,Edge], [22:0-1-8,Edge], [28:0-1-8,Edge]
-----------------------	---

LOADING (psf)	SPACING-	1-7-3	CSI.	DEFL.	in	(loc)	l/defl	L/d	PLATES	GRIP
TCLL 40.0	Plate Grip DOL	1.00	TC 0.52	Vert(LL)	-0.15	28	>999	480	MT20	244/190
TCDL 10.0	Lumber DOL	1.00	BC 0.52	Vert(CT)	-0.20	28	>999	360		
BCLL 0.0	Rep Stress Incr	YES	WB 0.61	Horz(CT)	0.03	23	n/a	n/a		
BCDL 5.0	Code IRC2015/TPI2014		Matrix-S						Weight: 195 lb	FT = 20%F, 11%E

LUMBER-	BRACING-
TOP CHORD 2x4 SP No.1(flat)	TOP CHORD Structural wood sheathing directly applied or 6-0-0 oc purlins, except end verticals.
BOT CHORD 2x4 SP No.1(flat)	BOT CHORD Rigid ceiling directly applied or 6-0-0 oc bracing.
WEBS 2x4 SP No.3(flat)	

REACTIONS. (size) 31=Mechanical, 19=Mechanical, 23=0-3-8
Max Uplift 19=95(LC 3)
Max Grav 31=632(LC 3), 19=346(LC 4), 23=1522(LC 1)

FORCES. (lb) - Max. Comp./Max. Ten. - All forces 250 (lb) or less except when shown.
TOP CHORD 2-3=-1384/0, 3-4=-2261/0, 4-5=-2261/0, 5-6=-2402/0, 6-8=-2413/0, 8-10=-1620/0, 12-13=0/2117, 13-14=0/2117, 14-15=-611/863, 15-16=-611/863, 16-17=-557/444
BOT CHORD 30-31=0/848, 29-30=0/1891, 28-29=0/2316, 27-28=0/2402, 25-27=0/2402, 24-25=0/945, 23-24=-775/0, 22-23=-1573/0, 21-22=-863/611, 20-21=-863/611, 19-20=-93/466
WEBS 2-31=-1019/0, 2-30=0/665, 3-30=-628/0, 3-29=0/452, 5-28=-126/335, 12-23=-1543/0, 12-24=0/1019, 10-24=-970/0, 10-25=0/833, 8-25=-967/0, 17-19=-560/111, 17-20=-435/113, 16-20=-66/511, 14-23=-979/0, 14-22=0/1284, 15-22=-682/0, 13-23=-359/0

- NOTES-**
- 1) Unbalanced floor live loads have been considered for this design.
 - 2) All plates are 6x6 MT20 unless otherwise indicated.
 - 3) Plates checked for a plus or minus 1 degree rotation about its center.
 - 4) Refer to girder(s) for truss to truss connections.
 - 5) Provide mechanical connection (by others) of truss to bearing plate capable of withstanding 100 lb uplift at joint(s) 19.
 - 6) Recommend 2x6 strongbacks, on edge, spaced at 10-0-0 oc and fastened to each truss with 3-10d (0.131" X 3") nails. Strongbacks to be attached to walls at their outer ends or restrained by other means.
 - 7) CAUTION, Do not erect truss backwards.

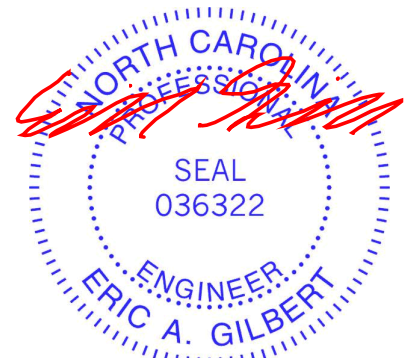

November 28, 2023

WARNING - Verify design parameters and READ NOTES ON THIS AND INCLUDED MITEK REFERENCE PAGE MII-7473 rev. 1/2/2023 BEFORE USE.
Design valid for use only with MiTek® connectors. This design is based only upon parameters shown, and is for an individual building component, not a truss system. Before use, the building designer must verify the applicability of design parameters and properly incorporate this design into the overall building design. Bracing indicated is to prevent buckling of individual truss web and/or chord members only. Additional temporary and permanent bracing is always required for stability and to prevent collapse with possible personal injury and property damage. For general guidance regarding the fabrication, storage, delivery, erection and bracing of trusses and truss systems, see **ANSI/TPH Quality Criteria and DSB-22** available from Truss Plate Institute (www.tpinst.org) and **BCSI Building Component Safety Information** available from the Structural Building Component Association (www.sbcacomponents.com)



818 Soundside Road
Edenton, NC 27932

Job J1123-6664	Truss F06	Truss Type Floor	Qty 4	Ply 1	Lot 17 Heritage @ NC 62214237
-------------------	--------------	---------------------	----------	----------	----------------------------------

Comtech, Inc. Fayetteville, NC - 28314,

8.430 s Jan 6 2022 MiTek Industries, Inc. Mon Nov 27 16:15:34 2023 Page 1
ID:JQb1igK2ne3CQdqy3dwnCxyStrD-RfC?PsB70Hq3NSgPqnL8w3ulTXbGKWrCDoi7J4zJC?f

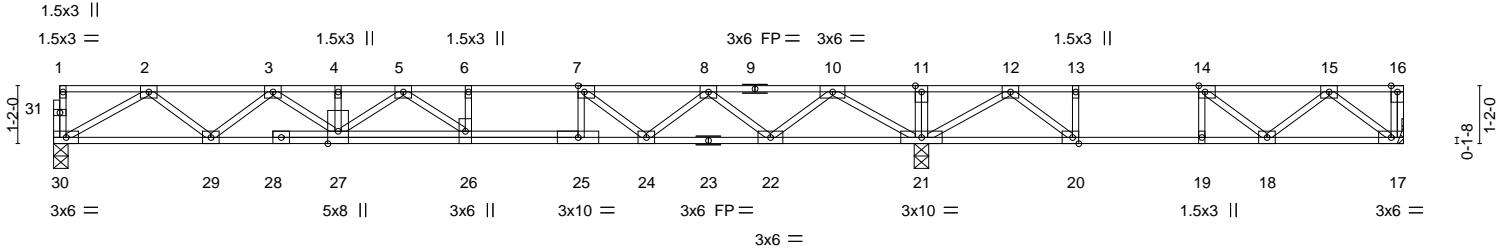

Plate Offsets (X,Y)--	[7:0-1-8,Edge], [14:0-1-8,Edge], [20:0-1-8,Edge]				
LOADING (psf)	SPACING- 1-7-3	CSI.	DEFL. in (loc) l/defl L/d	PLATES	GRIP
TCLL 40.0	Plate Grip DOL 1.00	TC 0.59	Vert(LL) -0.22 26-27 >931 480	MT20	244/190
TCDL 10.0	Lumber DOL 1.00	BC 0.98	Vert(CT) -0.31 26-27 >678 360		
BCLL 0.0	Rep Stress Incr YES	WB 0.43	Horz(CT) 0.04 17 n/a n/a		
BCDL 5.0	Code IRC2015/TPI2014	Matrix-S			
				Weight: 142 lb	FT = 20%F, 11%E

LUMBER-	BRACING-
TOP CHORD 2x4 SP No.1(flat)	TOP CHORD Structural wood sheathing directly applied or 6-0-0 oc purlins, except end verticals.
BOT CHORD 2x4 SP No.1(flat)	BOT CHORD Rigid ceiling directly applied or 2-2-0 oc bracing.
WEBS 2x4 SP No.3(flat)	

REACTIONS. (size) 30=0-3-8, 21=0-3-8, 17=Mechanical
Max Grav 30=714(LC 10), 21=1337(LC 1), 17=394(LC 4)

FORCES. (lb) - Max. Comp./Max. Ten. - All forces 250 (lb) or less except when shown.
TOP CHORD 2-3=-1666/0, 3-4=-2669/0, 4-5=-2669/0, 5-6=-2760/0, 6-7=-2760/0, 7-8=-2231/0, 8-10=-1211/0, 10-11=0/1075, 11-12=0/1075, 12-13=-794/239, 13-14=-794/239, 14-15=-674/47
BOT CHORD 29-30=0/1117, 27-29=0/2254, 26-27=0/2833, 25-26=0/2758, 24-25=0/2760, 22-24=0/1830, 21-22=0/541, 20-21=-569/401, 19-20=-239/794, 18-19=-239/794, 17-18=0/482
WEBS 2-30=-1289/0, 2-29=0/715, 3-29=-764/0, 3-27=0/518, 10-21=-1483/0, 10-22=0/902, 8-22=-842/0, 8-24=0/560, 7-24=-757/0, 7-25=-16/262, 5-27=-272/0, 5-26=-300/248, 12-21=-865/0, 12-20=0/720, 13-20=-329/0, 15-17=-605/0

- NOTES-**
- 1) Unbalanced floor live loads have been considered for this design.
 - 2) All plates are 3x4 MT20 unless otherwise indicated.
 - 3) Plates checked for a plus or minus 1 degree rotation about its center.
 - 4) Refer to girder(s) for truss to truss connections.
 - 5) Recommend 2x6 strongbacks, on edge, spaced at 10-0-0 oc and fastened to each truss with 3-10d (0.131" X 3") nails. Strongbacks to be attached to walls at their outer ends or restrained by other means.
 - 6) CAUTION, Do not erect truss backwards.

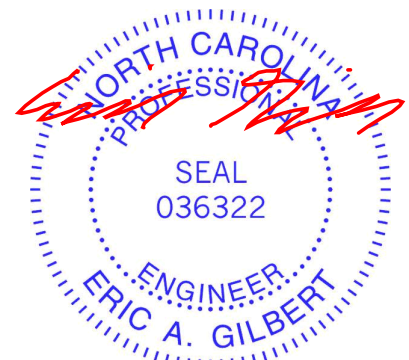

November 28, 2023

<p>WARNING - Verify design parameters and READ NOTES ON THIS AND INCLUDED MITEK REFERENCE PAGE MII-7473 rev. 1/2/2023 BEFORE USE.</p> <p>Design valid for use only with MiTek® connectors. This design is based only upon parameters shown, and is for an individual building component, not a truss system. Before use, the building designer must verify the applicability of design parameters and properly incorporate this design into the overall building design. Bracing indicated is to prevent buckling of individual truss web and/or chord members only. Additional temporary and permanent bracing is always required for stability and to prevent collapse with possible personal injury and property damage. For general guidance regarding the fabrication, storage, delivery, erection and bracing of trusses and truss systems, see ANSI/TPH Quality Criteria and DSB-22 available from Truss Plate Institute (www.tpinst.org) and BCSI Building Component Safety Information available from the Structural Building Component Association (www.sbcacomponents.com)</p>	<p>818 Soundside Road Edenton, NC 27932</p>
--	---

Job J1123-6664	Truss F07	Truss Type Floor	Qty 3	Ply 1	Lot 17 Heritage @ NC 62214238
-------------------	--------------	---------------------	----------	----------	----------------------------------

Comtech, Inc. Fayetteville, NC - 28314,

8.430 s Jan 6 2022 MiTek Industries, Inc. Mon Nov 27 16:15:35 2023 Page 1
ID:JQb1igK2ne3CQdqy3dwnCxyStrD-RfC?PsB70Hq3NSgPqnL8w3ulTXbGKWrCDoi7J4zJC?f

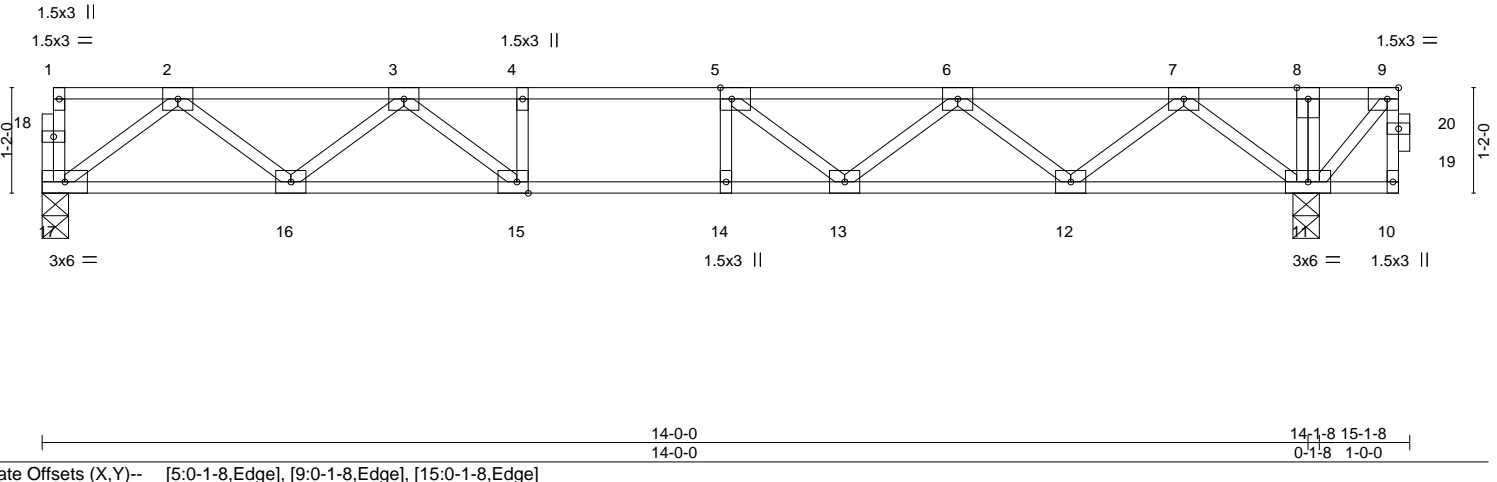

Plate Offsets (X,Y)--	[5:0-1-8,Edge], [9:0-1-8,Edge], [15:0-1-8,Edge]	14-0-0 14-0-0	14-1-8 15-1-8 0-1-8 1-0-0
LOADING (psf)	SPACING- 2-0-0	CSI.	DEFL. in (loc) l/defl L/d
TCLL 40.0	Plate Grip DOL 1.00	TC 0.50	Vert(LL) -0.14 13-14 >999 480
TCDL 10.0	Lumber DOL 1.00	BC 0.74	Vert(CT) -0.18 13-14 >919 360
BCLL 0.0	Rep Stress Incr NO	WB 0.40	Horz(CT) 0.03 11 n/a n/a
BCDL 5.0	Code IRC2015/TPI2014	Matrix-S	
			PLATES MT20
			GRIP 244/190
			Weight: 77 lb FT = 20%F, 11%E

LUMBER-
TOP CHORD 2x4 SP No.1(flat)
BOT CHORD 2x4 SP No.1(flat)
WEBS 2x4 SP No.3(flat)

BRACING-
TOP CHORD Structural wood sheathing directly applied or 6-0-0 oc purlins, except end verticals.
BOT CHORD Rigid ceiling directly applied or 10-0-0 oc bracing, Except: 6-0-0 oc bracing: 11-12.

REACTIONS. (size) 17=0-3-8, 11=0-3-8
Max Grav 17=721(LC 3), 11=1405(LC 1)

FORCES. (lb) - Max. Comp./Max. Ten. - All forces 250 (lb) or less except when shown.
TOP CHORD 2-3=-1426/0, 3-4=-2264/0, 4-5=-2264/0, 5-6=-2030/0, 6-7=-1140/0, 7-8=0/484, 8-9=0/484
BOT CHORD 16-17=0/892, 15-16=0/1941, 14-15=0/2264, 13-14=0/2264, 12-13=0/1751, 11-12=-203/506
WEBS 2-17=-1117/0, 2-16=0/695, 3-16=-670/0, 3-15=0/595, 7-11=-1196/0, 7-12=0/830, 6-12=-800/0, 6-13=0/451, 5-13=-521/0, 4-15=-256/0, 9-11=-718/0

- NOTES-**
- 1) Unbalanced floor live loads have been considered for this design.
 - 2) All plates are 3x4 MT20 unless otherwise indicated.
 - 3) Plates checked for a plus or minus 1 degree rotation about its center.
 - 4) Magnitude of user added load(s) on this truss have been applied uniformly across all gravity load cases with no adjustments.
 - 5) Recommend 2x6 strongbacks, on edge, spaced at 10-0-0 oc and fastened to each truss with 3-10d (0.131" X 3") nails. Strongbacks to be attached to walls at their outer ends or restrained by other means.
 - 6) CAUTION, Do not erect truss backwards.

LOAD CASE(S) Standard
1) Dead + Floor Live (balanced): Lumber Increase=1.00, Plate Increase=1.00
Uniform Loads (plf)
Vert: 10-17=-10, 1-9=-100
Concentrated Loads (lb)
Vert: 9=500

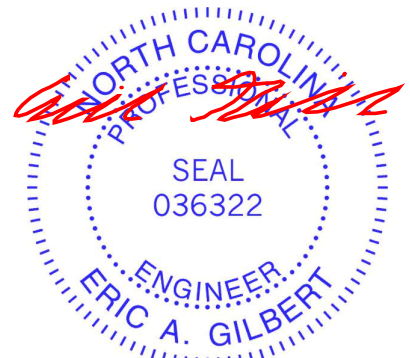

November 28, 2023

WARNING - Verify design parameters and READ NOTES ON THIS AND INCLUDED MITEK REFERENCE PAGE MII-7473 rev. 1/2/2023 BEFORE USE.
Design valid for use only with MiTek® connectors. This design is based only upon parameters shown, and is for an individual building component, not a truss system. Before use, the building designer must verify the applicability of design parameters and properly incorporate this design into the overall building design. Bracing indicated is to prevent buckling of individual truss web and/or chord members only. Additional temporary and permanent bracing is always required for stability and to prevent collapse with possible personal injury and property damage. For general guidance regarding the fabrication, storage, delivery, erection and bracing of trusses and truss systems, see **ANSI/TPH Quality Criteria and DSB-22** available from Truss Plate Institute (www.tpinst.org) and **BCSI Building Component Safety Information** available from the Structural Building Component Association (www.sbcacomponents.com)



818 Soundside Road
Edenton, NC 27932

Job J1123-6664	Truss F08	Truss Type Floor	Qty 1	Ply 1	Lot 17 Heritage @ NC Job Reference (optional)	162214239
-------------------	--------------	---------------------	----------	----------	--	-----------

Comtech, Inc. Fayetteville, NC - 28314,

8.430 s Jan 6 2022 MiTek Industries, Inc. Mon Nov 27 16:15:36 2023 Page 1
ID:JQb1igK2ne3CQdqy3dwnCxyStrD-RfC?PsB70Hq3NSgPqnL8w3uITXbGKWrCDoi7J4zJC?f

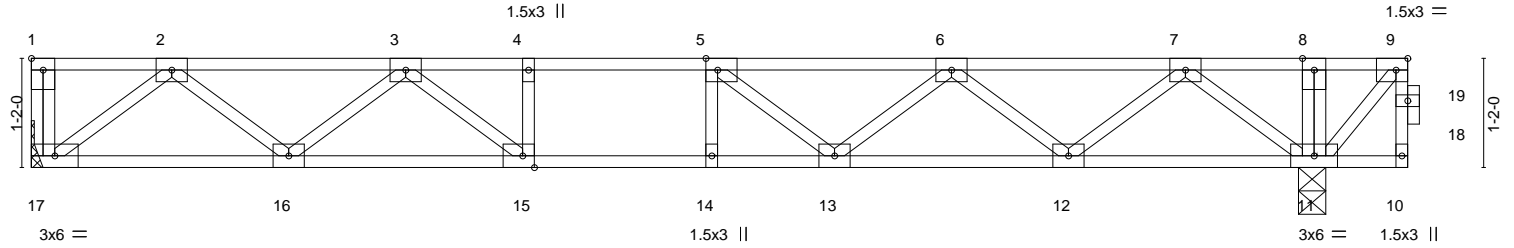

Plate Offsets (X, Y)--	[1:Edge,0-1-8], [5:0-1-8,Edge], [9:0-1-8,Edge], [15:0-1-8,Edge]
------------------------	---

LOADING (psf)	SPACING-	2-0-0	CSI.	DEFL.	in (loc)	l/defl	L/d	PLATES	GRIP
TCLL 40.0	Plate Grip DOL	1.00	TC 0.42	Vert(LL)	-0.12 13-14	>999	480	MT20	244/190
TCDL 10.0	Lumber DOL	1.00	BC 0.68	Vert(CT)	-0.15 13-14	>999	360		
BCLL 0.0	Rep Stress Incr	NO	WB 0.38	Horz(CT)	0.03 11	n/a	n/a		
BCDL 5.0	Code IRC2015/TPI2014		Matrix-S						
								Weight: 76 lb	FT = 20%F, 11%E

LUMBER-	BRACING-
TOP CHORD 2x4 SP No.1(flat)	TOP CHORD Structural wood sheathing directly applied or 6-0-0 oc purlins, except end verticals.
BOT CHORD 2x4 SP No.1(flat)	BOT CHORD Rigid ceiling directly applied or 10-0-0 oc bracing, Except: 6-0-0 oc bracing: 11-12.
WEBS 2x4 SP No.3(flat)	

REACTIONS. (size) 17=Mechanical, 11=0-3-8
Max Grav 17=710(LC 3), 11=1390(LC 1)

FORCES. (lb) - Max. Comp./Max. Ten. - All forces 250 (lb) or less except when shown.
TOP CHORD 2-3=-1385/0, 3-4=-2168/0, 4-5=-2168/0, 5-6=-1955/0, 6-7=-1102/0, 7-8=0/484, 8-9=0/484
BOT CHORD 16-17=0/870, 15-16=0/1880, 14-15=0/2168, 13-14=0/2168, 12-13=0/1696, 11-12=-208/485
WEBS 2-17=-1092/0, 2-16=0/670, 3-16=-644/0, 3-15=0/542, 7-11=-1171/0, 7-12=0/807, 6-12=-777/0, 6-13=0/423, 5-13=-482/0, 9-11=-718/0

- NOTES-**
- 1) Unbalanced floor live loads have been considered for this design.
 - 2) All plates are 3x4 MT20 unless otherwise indicated.
 - 3) Plates checked for a plus or minus 1 degree rotation about its center.
 - 4) Refer to girder(s) for truss to truss connections.
 - 5) Magnitude of user added load(s) on this truss have been applied uniformly across all gravity load cases with no adjustments.
 - 6) Recommend 2x6 strongbacks, on edge, spaced at 10-0-0 oc and fastened to each truss with 3-10d (0.131" X 3") nails. Strongbacks to be attached to walls at their outer ends or restrained by other means.
 - 7) CAUTION, Do not erect truss backwards.

LOAD CASE(S) Standard
1) Dead + Floor Live (balanced): Lumber Increase=1.00, Plate Increase=1.00
Uniform Loads (plf)
Vert: 10-17=-10, 1-9=-100
Concentrated Loads (lb)
Vert: 9=500

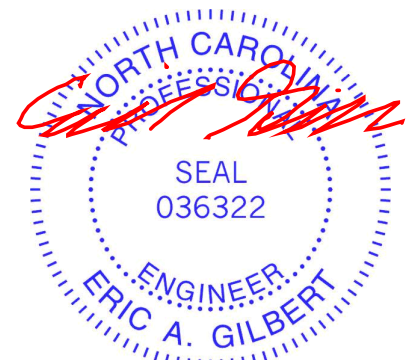

November 28, 2023

<p>WARNING - Verify design parameters and READ NOTES ON THIS AND INCLUDED MITEK REFERENCE PAGE MII-7473 rev. 1/2/2023 BEFORE USE.</p> <p>Design valid for use only with MiTek® connectors. This design is based only upon parameters shown, and is for an individual building component, not a truss system. Before use, the building designer must verify the applicability of design parameters and properly incorporate this design into the overall building design. Bracing indicated is to prevent buckling of individual truss web and/or chord members only. Additional temporary and permanent bracing is always required for stability and to prevent collapse with possible personal injury and property damage. For general guidance regarding the fabrication, storage, delivery, erection and bracing of trusses and truss systems, see ANSI/TPH Quality Criteria and DSB-22 available from Truss Plate Institute (www.tpinst.org) and BCSI Building Component Safety Information available from the Structural Building Component Association (www.sbcacomponents.com)</p>	<p>ENGINEERING BY TRENCO A MITEK Affiliate</p> <p>818 Soundside Road Edenton, NC 27932</p>
--	---

Job J1123-6664	Truss F09	Truss Type Floor	Qty 3	Ply 1	Lot 17 Heritage @ NC Job Reference (optional)	162214240
-------------------	--------------	---------------------	----------	----------	--	-----------

Comtech, Inc., Fayetteville, NC - 28314,

8.430 s Jan 6 2022 MiTek Industries, Inc. Mon Nov 27 16:15:37 2023 Page 1
ID:JQb1igK2ne3CQdqy3dwnCxyStrD-RfC?PsB70Hq3NSgPqnL8w3ulTXbGKWrCDoi7J4zJC?f

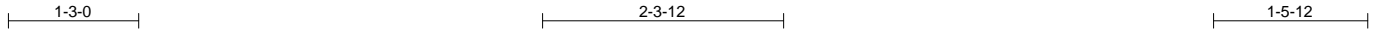

Scale = 1:22.1

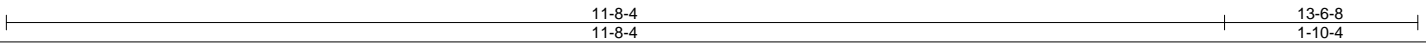
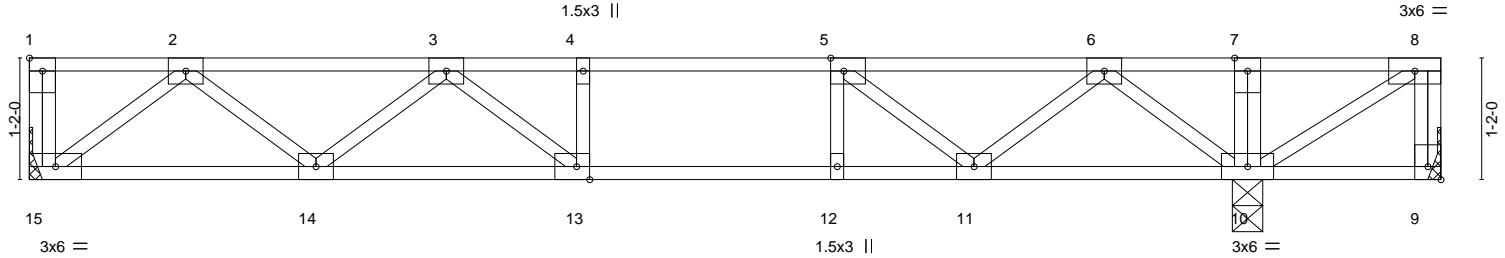

Plate Offsets (X, Y)--	[1:Edge,0-1-8], [5:0-1-8,Edge], [9:Edge,0-1-8], [13:0-1-8,Edge]				
LOADING (psf)	SPACING- 2-0-0	CSI.	DEFL. in (loc) l/defl L/d	PLATES	GRIP
TCLL 40.0	Plate Grip DOL 1.00	TC 0.48	Vert(LL) -0.12 13-14 >999 480	MT20	244/190
TCDL 10.0	Lumber DOL 1.00	BC 0.62	Vert(CT) -0.16 13-14 >886 360		
BCLL 0.0	Rep Stress Incr YES	WB 0.31	Horz(CT) 0.02 9 n/a n/a		
BCDL 5.0	Code IRC2015/TPI2014	Matrix-S		Weight: 70 lb	FT = 20%F, 11%E

LUMBER-

TOP CHORD 2x4 SP No.1(flat)
BOT CHORD 2x4 SP No.1(flat)
WEBS 2x4 SP No.3(flat)

BRACING-

TOP CHORD Structural wood sheathing directly applied or 6-0-0 oc purlins, except end verticals.
BOT CHORD Rigid ceiling directly applied or 10-0-0 oc bracing.

REACTIONS.

(size) 9=Mechanical, 15=Mechanical, 10=0-3-8
Max Uplift 9=282(LC 8)
Max Grav 9=138(LC 7), 15=604(LC 3), 10=1070(LC 8)

FORCES.

(lb) - Max. Comp./Max. Ten. - All forces 250 (lb) or less except when shown.
TOP CHORD 8-9=-135/283, 2-3=-1138/0, 3-4=-1507/0, 4-5=-1507/0, 5-6=-934/0, 6-7=-110/581, 7-8=-109/582
BOT CHORD 14-15=0/735, 13-14=0/1474, 12-13=0/1507, 11-12=0/1507, 10-11=0/497
WEBS 2-15=-922/0, 2-14=0/525, 3-14=-437/0, 6-10=-966/0, 6-11=0/650, 5-11=-735/0, 8-10=-680/127

NOTES-

- 1) Unbalanced floor live loads have been considered for this design.
- 2) All plates are 3x4 MT20 unless otherwise indicated.
- 3) Plates checked for a plus or minus 1 degree rotation about its center.
- 4) Refer to girder(s) for truss to truss connections.
- 5) Provide mechanical connection (by others) of truss to bearing plate capable of withstanding 100 lb uplift at joint(s) except (jt=lb) 9=282.
- 6) Recommend 2x6 strongbacks, on edge, spaced at 10-0-0 oc and fastened to each truss with 3-10d (0.131" X 3") nails. Strongbacks to be attached to walls at their outer ends or restrained by other means.
- 7) CAUTION, Do not erect truss backwards.

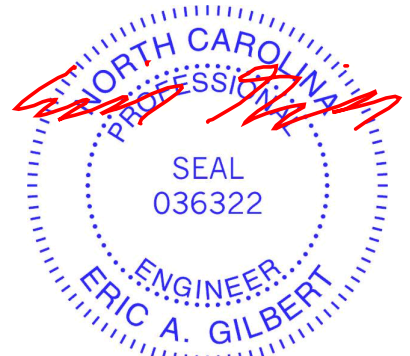

November 28, 2023

WARNING - Verify design parameters and READ NOTES ON THIS AND INCLUDED MITEK REFERENCE PAGE MII-7473 rev. 1/2/2023 BEFORE USE.

Design valid for use only with MiTek® connectors. This design is based only upon parameters shown, and is for an individual building component, not a truss system. Before use, the building designer must verify the applicability of design parameters and properly incorporate this design into the overall building design. Bracing indicated is to prevent buckling of individual truss web and/or chord members only. Additional temporary and permanent bracing is always required for stability and to prevent collapse with possible personal injury and property damage. For general guidance regarding the fabrication, storage, delivery, erection and bracing of trusses and truss systems, see **ANSI/TPI1 Quality Criteria and DSB-22** available from Truss Plate Institute (www.tpinst.org) and **BCSI Building Component Safety Information** available from the Structural Building Component Association (www.sbcacomponents.com)



818 Soundside Road
Edenton, NC 27932

Job J1123-6664	Truss F10	Truss Type FLOOR	Qty 5	Ply 1	Lot 17 Heritage @ NC 162214241
-------------------	--------------	---------------------	----------	----------	-----------------------------------

Comtech, Inc. Fayetteville, NC - 28314,

8.430 s Jan 6 2022 MiTek Industries, Inc. Mon Nov 27 16:15:38 2023 Page 1
ID:JQb1igK2ne3CQdqy3dwnCxyStrD-RfC?PsB70Hq3NSgPqnL8w3ulTXbGKWrCDoi7J4zJC?f

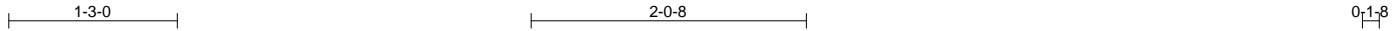

Scale = 1:17.1

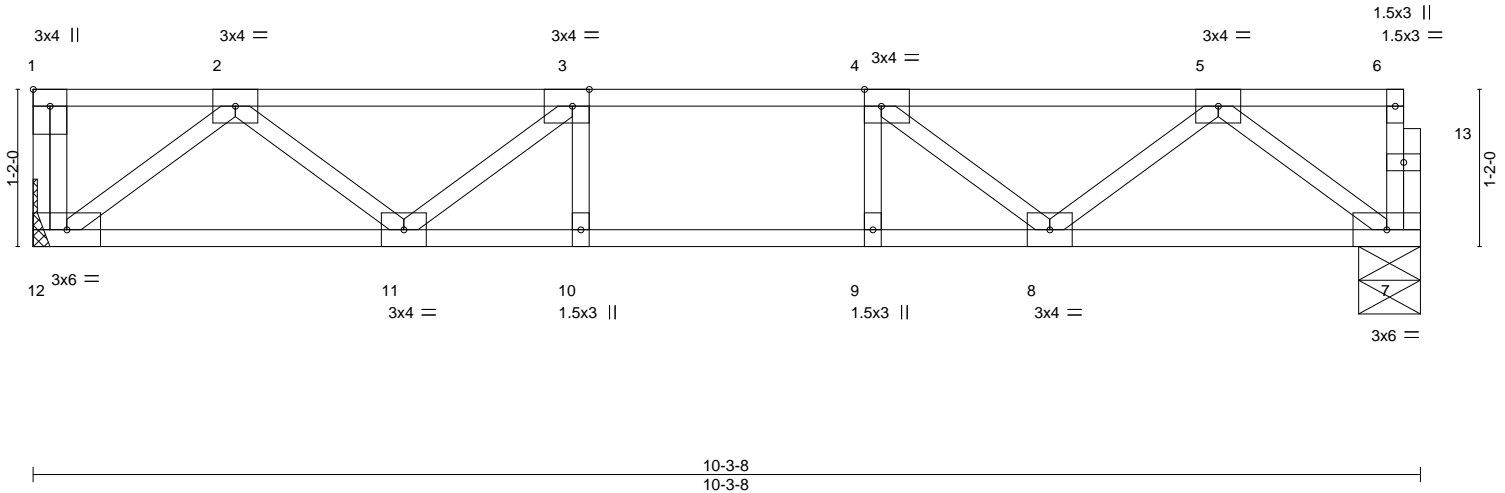

Plate Offsets (X,Y)--	[1:Edge,0-1-8], [3:0-1-8,Edge], [4:0-1-8,Edge]				
LOADING (psf)	SPACING- 1-7-3	CSI.	DEFL. in (loc) l/defl L/d	PLATES	GRIP
TCLL 40.0	Plate Grip DOL 1.00	TC 0.19	Vert(LL) -0.05 9 >999 480	MT20	244/190
TCDL 10.0	Lumber DOL 1.00	BC 0.33	Vert(CT) -0.06 9 >999 360		
BCLL 0.0	Rep Stress Incr YES	WB 0.16	Horz(CT) 0.01 7 n/a n/a		
BCDL 5.0	Code IRC2015/TPI2014	Matrix-S		Weight: 52 lb	FT = 20%F, 11%E

LUMBER-	BRACING-
TOP CHORD 2x4 SP No.1(flat)	TOP CHORD Structural wood sheathing directly applied or 6-0-0 oc purlins, except end verticals.
BOT CHORD 2x4 SP No.1(flat)	BOT CHORD Rigid ceiling directly applied or 10-0-0 oc bracing.
WEBS 2x4 SP No.3(flat)	

REACTIONS. (size) 12=Mechanical, 7=0-5-8
Max Grav 12=442(LC 1), 7=437(LC 1)

FORCES. (lb) - Max. Comp./Max. Ten. - All forces 250 (lb) or less except when shown.
TOP CHORD 2-3=-795/0, 3-4=-1047/0, 4-5=-794/0
BOT CHORD 11-12=0/531, 10-11=0/1047, 9-10=0/1047, 8-9=0/1047, 7-8=0/530
WEBS 2-12=-666/0, 2-11=0/343, 3-11=-355/0, 5-7=-663/0, 5-8=0/344, 4-8=-355/0

- NOTES-**
- 1) Unbalanced floor live loads have been considered for this design.
 - 2) Plates checked for a plus or minus 1 degree rotation about its center.
 - 3) Refer to girder(s) for truss to truss connections.
 - 4) Recommend 2x6 strongbacks, on edge, spaced at 10-0-0 oc and fastened to each truss with 3-10d (0.131" X 3") nails. Strongbacks to be attached to walls at their outer ends or restrained by other means.
 - 5) CAUTION, Do not erect truss backwards.

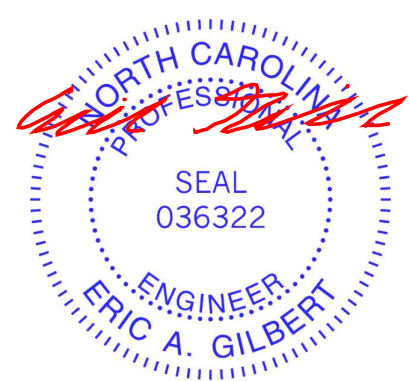

<p>WARNING - Verify design parameters and READ NOTES ON THIS AND INCLUDED MITEK REFERENCE PAGE MII-7473 rev. 1/2/2023 BEFORE USE.</p> <p>Design valid for use only with MiTek® connectors. This design is based only upon parameters shown, and is for an individual building component, not a truss system. Before use, the building designer must verify the applicability of design parameters and properly incorporate this design into the overall building design. Bracing indicated is to prevent buckling of individual truss web and/or chord members only. Additional temporary and permanent bracing is always required for stability and to prevent collapse with possible personal injury and property damage. For general guidance regarding the fabrication, storage, delivery, erection and bracing of trusses and truss systems, see ANSI/TP1 Quality Criteria and DSB-22 available from Truss Plate Institute (www.tpinst.org) and BCSI Building Component Safety Information available from the Structural Building Component Association (www.sbcacomponents.com)</p>	<p>ENGINEERING BY TRENCO A MiTek Affiliate</p> <p>818 Soundside Road Edenton, NC 27932</p>
--	---

Job J1123-6664	Truss F11	Truss Type Floor	Qty 5	Ply 1	Lot 17 Heritage @ NC 162214242
-------------------	--------------	---------------------	----------	----------	-----------------------------------

Comtech, Inc. Fayetteville, NC - 28314,

8.430 s Jan 6 2022 MiTek Industries, Inc. Mon Nov 27 16:15:39 2023 Page 1
ID:JQb1igK2ne3CQdqy3dwnCxyStrD-RfC?PsB70Hq3NSgPqnL8w3ulTXbGKWrCDoi7J4zJC?f



Scale = 1:18.7

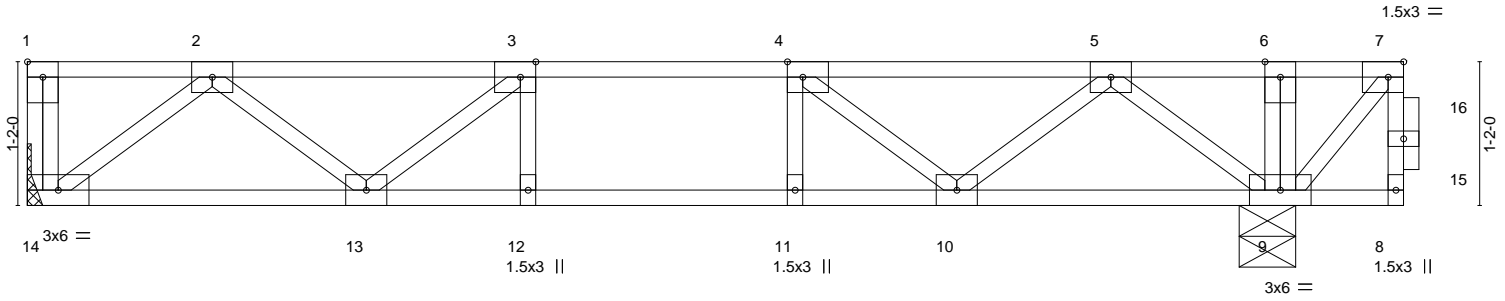

Plate Offsets (X,Y)--	[1:Edge,0-1-8], [3:0-1-8,Edge], [4:0-1-8,Edge], [7:0-1-8,Edge]
-----------------------	--

LOADING (psf)	SPACING-	2-0-0	CSI.	DEFL.	in (loc)	l/defl	L/d	PLATES	GRIP
TCLL 40.0	Plate Grip DOL 1.00		TC 0.43	Vert(LL) -0.07	12-13	>999	480	MT20	244/190
TCDL 10.0	Lumber DOL 1.00		BC 0.58	Vert(CT) -0.09	12-13	>999	360		
BCLL 0.0	Rep Stress Incr NO		WB 0.25	Horz(CT) 0.01	9	n/a	n/a		
BCDL 5.0	Code IRC2015/TPI2014		Matrix-S						
								Weight: 59 lb	FT = 20%F, 11%E

LUMBER-	BRACING-
TOP CHORD 2x4 SP No.1(flat)	TOP CHORD Structural wood sheathing directly applied or 6-0-0 oc purlins, except end verticals.
BOT CHORD 2x4 SP No.1(flat)	BOT CHORD Rigid ceiling directly applied or 10-0-0 oc bracing, Except: 6-0-0 oc bracing: 9-10.
WEBS 2x4 SP No.3(flat)	
REACTIONS. (size) 14=Mechanical, 9=0-5-8 Max Grav 14=503(LC 3), 9=1208(LC 1)	

FORCES. (lb) - Max. Comp./Max. Ten. - All forces 250 (lb) or less except when shown.
 TOP CHORD 2-3=-868/0, 3-4=-1073/0, 4-5=-641/96, 5-6=0/480, 6-7=0/479
 BOT CHORD 13-14=0/608, 12-13=0/1073, 11-12=0/1073, 10-11=0/1073, 9-10=-269/247
 WEBS 2-14=-763/0, 2-13=0/338, 3-13=-302/50, 5-9=-872/0, 5-10=0/520, 4-10=-603/0, 7-9=-711/0

- NOTES-**
- 1) Unbalanced floor live loads have been considered for this design.
 - 2) All plates are 3x4 MT20 unless otherwise indicated.
 - 3) Plates checked for a plus or minus 1 degree rotation about its center.
 - 4) Refer to girder(s) for truss to truss connections.
 - 5) Magnitude of user added load(s) on this truss have been applied uniformly across all gravity load cases with no adjustments.
 - 6) Recommend 2x6 strongbacks, on edge, spaced at 10-0-0 oc and fastened to each truss with 3-10d (0.131" X 3") nails. Strongbacks to be attached to walls at their outer ends or restrained by other means.
 - 7) CAUTION, Do not erect truss backwards.

LOAD CASE(S) Standard
 1) Dead + Floor Live (balanced): Lumber Increase=1.00, Plate Increase=1.00
 Uniform Loads (plf)
 Vert: 8-14=-10, 1-7=-100
 Concentrated Loads (lb)
 Vert: 7=-500

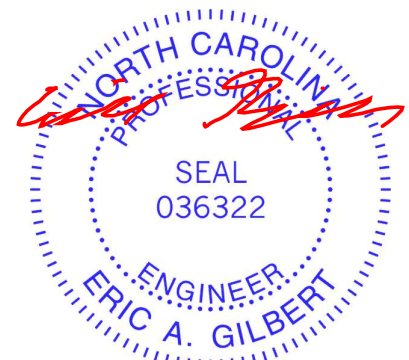

November 28, 2023

<p>WARNING - Verify design parameters and READ NOTES ON THIS AND INCLUDED MITEK REFERENCE PAGE MII-7473 rev. 1/2/2023 BEFORE USE. Design valid for use only with MiTek® connectors. This design is based only upon parameters shown, and is for an individual building component, not a truss system. Before use, the building designer must verify the applicability of design parameters and properly incorporate this design into the overall building design. Bracing indicated is to prevent buckling of individual truss web and/or chord members only. Additional temporary and permanent bracing is always required for stability and to prevent collapse with possible personal injury and property damage. For general guidance regarding the fabrication, storage, delivery, erection and bracing of trusses and truss systems, see ANSI/TPH Quality Criteria and DSB-22 available from Truss Plate Institute (www.tpinst.org) and BCSI Building Component Safety Information available from the Structural Building Component Association (www.sbcacomponents.com)</p>	<p>ENGINEERING BY TRENCO A MITEK Affiliate</p> <p>818 Soundside Road Edenton, NC 27932</p>
--	--

Job J1123-6664	Truss FKW1	Truss Type Floor Supported Gable	Qty 1	Ply 1	Lot 17 Heritage @ NC Job Reference (optional)	162214243
-------------------	---------------	-------------------------------------	----------	----------	--	-----------

Comtech, Inc. Fayetteville, NC - 28314,

8.430 s Jan 6 2022 MiTek Industries, Inc. Mon Nov 27 16:15:40 2023 Page 1
ID:JQb1igK2ne3CQdqy3dwnCxyStrD-RfC?PsB70Hq3NSgPqnL8w3ulTXbGKWrCDoi7J4zJC?f

0-1/8

0-1/8

Scale = 1:27.6

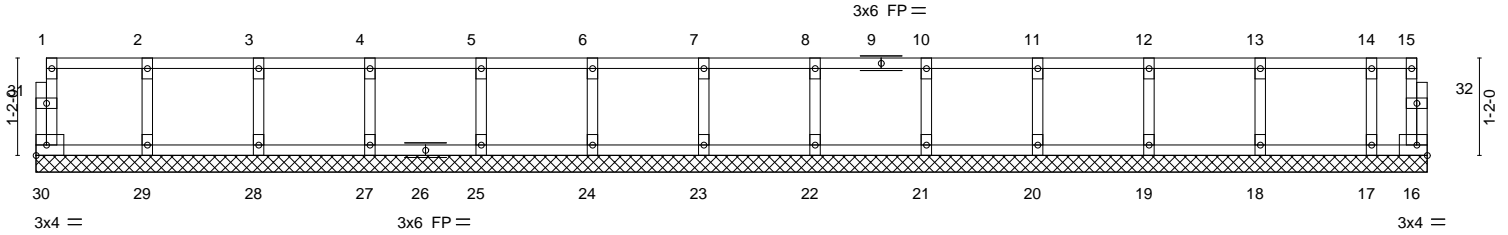

LOADING (psf)		SPACING-		CSI.		DEFL.		PLATES		GRIP	
TCLL	40.0	Plate Grip DOL	1.00	TC	0.06	Vert(LL)	n/a	MT20	244/190	Weight: 70 lb FT = 20%F, 11%E	
TCDL	10.0	Lumber DOL	1.00	BC	0.01	Vert(CT)	n/a				
BCLL	0.0	Rep Stress Incr	YES	WB	0.03	Horz(CT)	0.00				
BCDL	5.0	Code	IRC2015/TPI2014	Matrix-R							

LUMBER-
TOP CHORD 2x4 SP No.1(flat)
BOT CHORD 2x4 SP No.1(flat)
WEBS 2x4 SP No.3(flat)
OTHERS 2x4 SP No.3(flat)

BRACING-
TOP CHORD Structural wood sheathing directly applied or 6-0-0 oc purlins, except end verticals.
BOT CHORD Rigid ceiling directly applied or 10-0-0 oc bracing.

REACTIONS. All bearings 16-8-0.
(lb) - Max Grav All reactions 250 lb or less at joint(s) 30, 16, 29, 28, 27, 25, 24, 23, 22, 21, 20, 19, 18, 17

FORCES. (lb) - Max. Comp./Max. Ten. - All forces 250 (lb) or less except when shown.

NOTES-

- 1) All plates are 1.5x3 MT20 unless otherwise indicated.
- 2) Plates checked for a plus or minus 1 degree rotation about its center.
- 3) Gable requires continuous bottom chord bearing.
- 4) Truss to be fully sheathed from one face or securely braced against lateral movement (i.e. diagonal web).
- 5) Gable studs spaced at 1-4-0 oc.
- 6) Recommend 2x6 strongbacks, on edge, spaced at 10-0-0 oc and fastened to each truss with 3-10d (0.131" X 3") nails. Strongbacks to be attached to walls at their outer ends or restrained by other means.



November 28, 2023

WARNING - Verify design parameters and READ NOTES ON THIS AND INCLUDED MITEK REFERENCE PAGE MII-7473 rev. 1/2/2023 BEFORE USE.
Design valid for use only with MiTek® connectors. This design is based only upon parameters shown, and is for an individual building component, not a truss system. Before use, the building designer must verify the applicability of design parameters and properly incorporate this design into the overall building design. Bracing indicated is to prevent buckling of individual truss web and/or chord members only. Additional temporary and permanent bracing is always required for stability and to prevent collapse with possible personal injury and property damage. For general guidance regarding the fabrication, storage, delivery, erection and bracing of trusses and truss systems, see **ANSI/TP1 Quality Criteria and DSB-22** available from Truss Plate Institute (www.tpinst.org) and **BCSI Building Component Safety Information** available from the Structural Building Component Association (www.sbcacomponents.com)



818 Soundside Road
Edenton, NC 27932

Job J1123-6664	Truss FKW2	Truss Type Floor Supported Gable	Qty 1	Ply 1	Lot 17 Heritage @ NC Job Reference (optional)	162214244
-------------------	---------------	-------------------------------------	----------	----------	--	-----------

Comtech, Inc. Fayetteville, NC - 28314,

8.430 s Jan 6 2022 MiTek Industries, Inc. Mon Nov 27 16:15:41 2023 Page 1
ID:JQb1igK2ne3CQdqy3dwnCxyStrD-RfC?PsB70Hq3NSgPqnL8w3ulTXbGKWrCDoi7J4zJC?f

0-1-8

0-1-8

Scale = 1:45.4

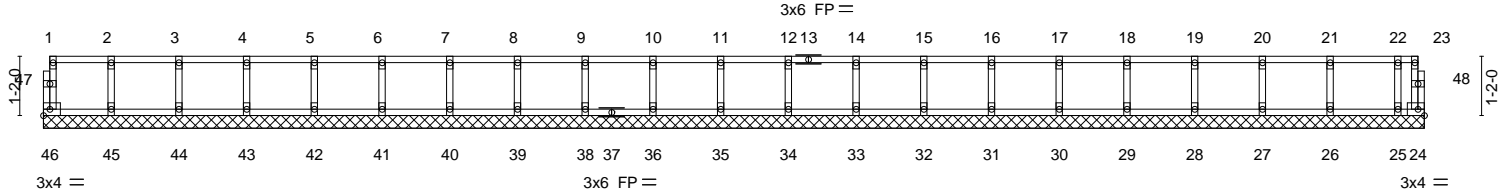

LOADING (psf)	SPACING-	CSI.	DEFL.	in (loc)	l/defl	L/d	PLATES	GRIP
TCLL 40.0	2-0-0 Plate Grip DOL 1.00	TC 0.06	Vert(LL)	n/a	-	n/a	MT20	244/190
TCDL 10.0	Lumber DOL 1.00	BC 0.01	Vert(CT)	n/a	-	n/a		
BCLL 0.0	Rep Stress Incr YES	WB 0.03	Horz(CT)	0.00	24	n/a		
BCDL 5.0	Code IRC2015/TPI2014	Matrix-R					Weight: 113 lb	FT = 20%F, 11%E

LUMBER-
 TOP CHORD 2x4 SP No.1(flat)
 BOT CHORD 2x4 SP No.1(flat)
 WEBS 2x4 SP No.3(flat)
 OTHERS 2x4 SP No.3(flat)

BRACING-
 TOP CHORD Structural wood sheathing directly applied or 6-0-0 oc purlins, except end verticals.
 BOT CHORD Rigid ceiling directly applied or 10-0-0 oc bracing.

REACTIONS. All bearings 27-2-4.
 (lb) - Max Grav All reactions 250 lb or less at joint(s) 46, 24, 45, 44, 43, 42, 41, 40, 39, 38, 36, 35, 34, 33, 32, 31, 30, 29, 28, 27, 26, 25

FORCES. (lb) - Max. Comp./Max. Ten. - All forces 250 (lb) or less except when shown.

- NOTES-**
- All plates are 1.5x3 MT20 unless otherwise indicated.
 - Plates checked for a plus or minus 1 degree rotation about its center.
 - Gable requires continuous bottom chord bearing.
 - Truss to be fully sheathed from one face or securely braced against lateral movement (i.e. diagonal web).
 - Gable studs spaced at 1-4-0 oc.
 - Recommend 2x6 strongbacks, on edge, spaced at 10-0-0 oc and fastened to each truss with 3-10d (0.131" X 3") nails. Strongbacks to be attached to walls at their outer ends or restrained by other means.

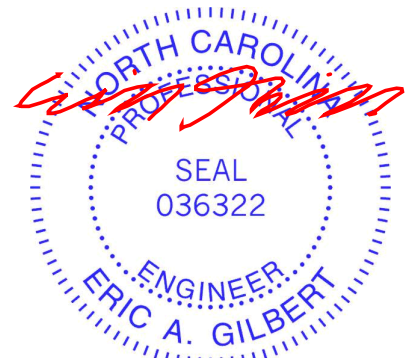

November 28, 2023

WARNING - Verify design parameters and READ NOTES ON THIS AND INCLUDED MITEK REFERENCE PAGE MII-7473 rev. 1/2/2023 BEFORE USE.
 Design valid for use only with MiTek® connectors. This design is based only upon parameters shown, and is for an individual building component, not a truss system. Before use, the building designer must verify the applicability of design parameters and properly incorporate this design into the overall building design. Bracing indicated is to prevent buckling of individual truss web and/or chord members only. Additional temporary and permanent bracing is always required for stability and to prevent collapse with possible personal injury and property damage. For general guidance regarding the fabrication, storage, delivery, erection and bracing of trusses and truss systems, see **ANSI/TPH Quality Criteria and DSB-22** available from Truss Plate Institute (www.tpinst.org) and **BCSI Building Component Safety Information** available from the Structural Building Component Association (www.sbcacomponents.com)



818 Soundside Road
 Edenton, NC 27932

Job	Truss	Truss Type	Qty	Ply	Lot 17 Heritage @ NC
J1123-6664	FKW3	Floor Supported Gable	1	1	62214245
					Job Reference (optional)

Comtech, Inc. Fayetteville, NC - 28314,

8.430 s Jan 6 2022 MiTek Industries, Inc. Mon Nov 27 16:15:42 2023 Page 1
 ID:JQb1igK2ne3CQdqy3dwnCxyStrD-RfC?PsB70Hq3NSgPqnL8w3ulTXbGKWrCDoi7J4zJC?f

9-11-0

0-9-0 0-1-8

Scale = 1:18.4

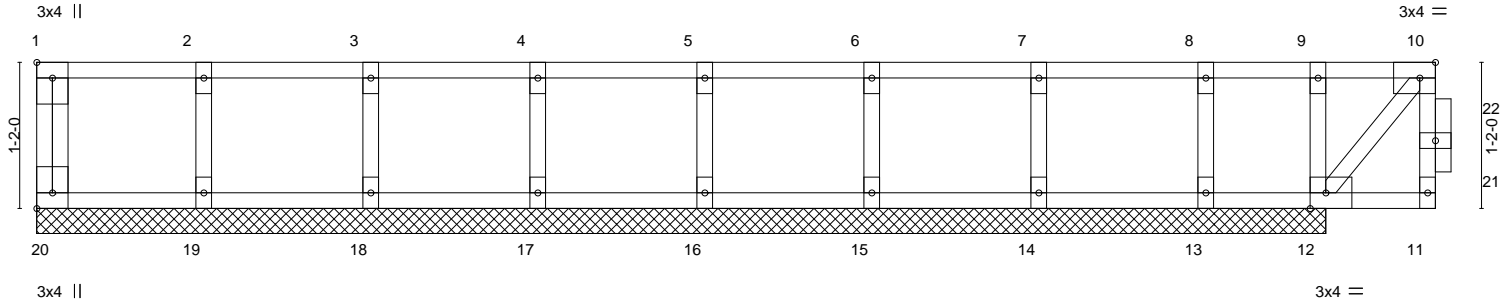

Plate Offsets (X, Y)--	[1:Edge,0-1-8], [10:0-1-8,Edge], [12:0-1-8,Edge], [20:Edge,0-1-8]
------------------------	---

LOADING (psf)	SPACING-	2-0-0	CSI.	DEFL.	in (loc)	l/defl	L/d	PLATES	GRIP
TCLL 40.0	Plate Grip DOL	1.00	TC 0.34	Vert(LL)	n/a	-	n/a	MT20	244/190
TCDL 10.0	Lumber DOL	1.00	BC 0.29	Vert(CT)	n/a	-	n/a		
BCLL 0.0	Rep Stress Incr	NO	WB 0.07	Horz(CT)	-0.00	12	n/a		
BCDL 5.0	Code IRC2015/TPI2014		Matrix-S						
								Weight: 51 lb	FT = 20%F, 11%E

LUMBER-	BRACING-
TOP CHORD 2x4 SP No.1(flat)	TOP CHORD Structural wood sheathing directly applied or 10-0-0 oc purlins, except end verticals.
BOT CHORD 2x4 SP No.1(flat)	BOT CHORD Rigid ceiling directly applied or 10-0-0 oc bracing.
WEBS 2x4 SP No.3(flat)	
OTHERS 2x4 SP No.3(flat)	

REACTIONS. All bearings 10-3-8.
 (lb) - Max Uplift All uplift 100 lb or less at joint(s) except 13=-171(LC 4)
 Max Grav All reactions 250 lb or less at joint(s) 20, 19, 18, 17, 16, 15, 14 except 12=483(LC 1)

FORCES. (lb) - Max. Comp./Max. Ten. - All forces 250 (lb) or less except when shown.
 WEBS 9-12=-321/0

- NOTES-**
- 1) Unbalanced floor live loads have been considered for this design.
 - 2) All plates are 1.5x3 MT20 unless otherwise indicated.
 - 3) Plates checked for a plus or minus 1 degree rotation about its center.
 - 4) Truss to be fully sheathed from one face or securely braced against lateral movement (i.e. diagonal web).
 - 5) Gable studs spaced at 1-4-0 oc.
 - 6) Provide mechanical connection (by others) of truss to bearing plate capable of withstanding 171 lb uplift at joint 13.
 - 7) Non Standard bearing condition. Review required.
 - 8) Magnitude of user added load(s) on this truss have been applied uniformly across all gravity load cases with no adjustments.
 - 9) Recommend 2x6 strongbacks, on edge, spaced at 10-0-0 oc and fastened to each truss with 3-10d (0.131" X 3") nails. Strongbacks to be attached to walls at their outer ends or restrained by other means.
 - 10) CAUTION, Do not erect truss backwards.

LOAD CASE(S) Standard
 1) Dead + Floor Live (balanced): Lumber Increase=1.00, Plate Increase=1.00
 Uniform Loads (plf)
 Vert: 11-20=-10, 1-9=-100, 9-10=-250
 Concentrated Loads (lb)
 Vert: 10=40

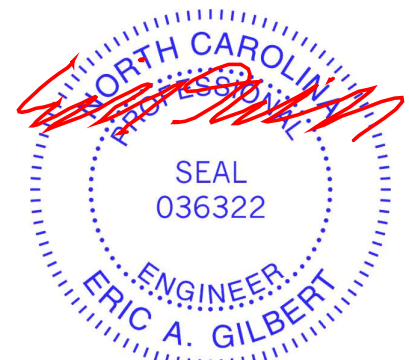

November 28, 2023

Job J1123-6664	Truss FKW4	Truss Type Floor Supported Gable	Qty 1	Ply 1	Lot 17 Heritage @ NC Job Reference (optional)	I62214246
-------------------	---------------	-------------------------------------	----------	----------	--	-----------

Comtech, Inc. Fayetteville, NC - 28314,

8.430 s Jan 6 2022 MiTek Industries, Inc. Mon Nov 27 16:15:43 2023 Page 1
ID:JQb1igK2ne3CQdqy3dwnCxyStrD-RfC?PsB70Hq3NSgPqnL8w3ulTXbGKWrCDoi7J4zJC?f

0.1-8

Scale = 1:18.2

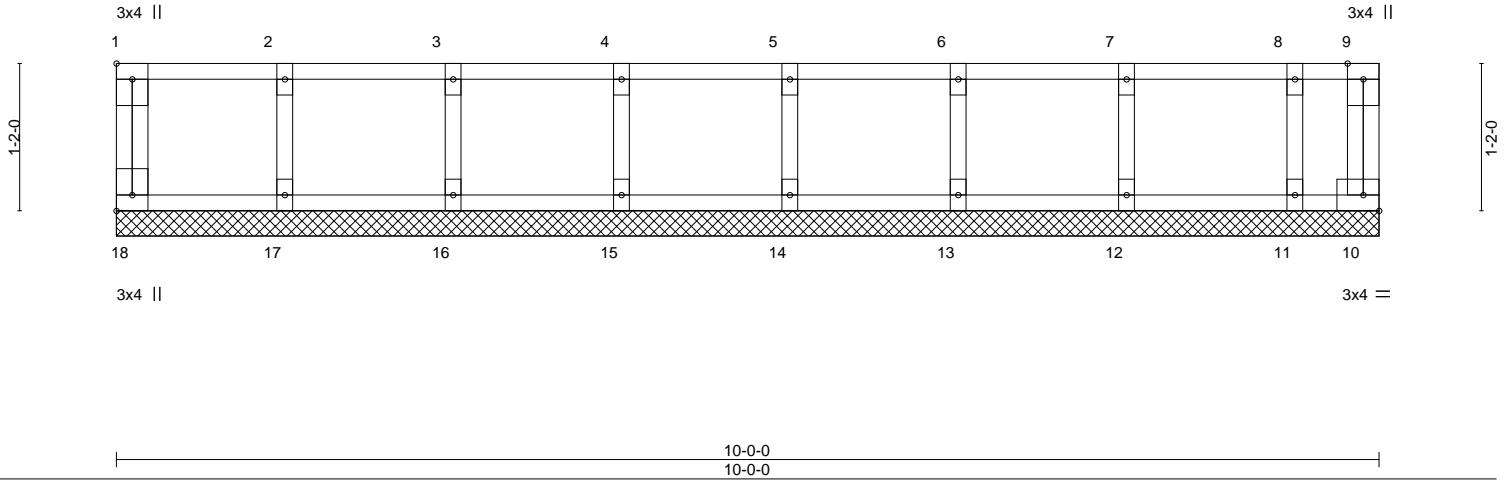

LOADING (psf)	SPACING-	2-0-0	CSI.	DEFL.	in (loc)	l/defl	L/d	PLATES	GRIP
TCLL 40.0	Plate Grip DOL	1.00	TC 0.06	Vert(LL)	n/a	-	n/a	MT20	244/190
TCDL 10.0	Lumber DOL	1.00	BC 0.01	Vert(CT)	n/a	-	n/a		
BCLL 0.0	Rep Stress Incr	YES	WB 0.03	Horz(CT)	0.00	10	n/a		
BCDL 5.0	Code IRC2015/TPI2014		Matrix-R						
								Weight: 45 lb	FT = 20%F, 11%E

LUMBER-	BRACING-
TOP CHORD 2x4 SP No.1(flat)	TOP CHORD Structural wood sheathing directly applied or 6-0-0 oc purlins, except end verticals.
BOT CHORD 2x4 SP No.1(flat)	BOT CHORD Rigid ceiling directly applied or 10-0-0 oc bracing.
WEBS 2x4 SP No.3(flat)	
OTHERS 2x4 SP No.3(flat)	

REACTIONS. All bearings 10-0-0.
(lb) - Max Grav All reactions 250 lb or less at joint(s) 18, 10, 17, 16, 15, 14, 13, 12, 11

FORCES. (lb) - Max. Comp./Max. Ten. - All forces 250 (lb) or less except when shown.

- NOTES-**
- All plates are 1.5x3 MT20 unless otherwise indicated.
 - Plates checked for a plus or minus 1 degree rotation about its center.
 - Gable requires continuous bottom chord bearing.
 - Truss to be fully sheathed from one face or securely braced against lateral movement (i.e. diagonal web).
 - Gable studs spaced at 1-4-0 oc.
 - Recommend 2x6 strongbacks, on edge, spaced at 10-0-0 oc and fastened to each truss with 3-10d (0.131" X 3") nails. Strongbacks to be attached to walls at their outer ends or restrained by other means.
 - CAUTION, Do not erect truss backwards.



November 28, 2023

<p>WARNING - Verify design parameters and READ NOTES ON THIS AND INCLUDED MITEK REFERENCE PAGE MII-7473 rev. 1/2/2023 BEFORE USE.</p> <p>Design valid for use only with MiTek® connectors. This design is based only upon parameters shown, and is for an individual building component, not a truss system. Before use, the building designer must verify the applicability of design parameters and properly incorporate this design into the overall building design. Bracing indicated is to prevent buckling of individual truss web and/or chord members only. Additional temporary and permanent bracing is always required for stability and to prevent collapse with possible personal injury and property damage. For general guidance regarding the fabrication, storage, delivery, erection and bracing of trusses and truss systems, see ANSI/TP1 Quality Criteria and DSB-22 available from Truss Plate Institute (www.tpinst.org) and BCSI Building Component Safety Information available from the Structural Building Component Association (www.sbcacomponents.com)</p>	<p>ENGINEERING BY</p>  <p>A MITTEK Affiliate</p> <p>818 Soundside Road Edenton, NC 27932</p>
--	---

Job J1123-6664	Truss FKW5	Truss Type Floor Supported Gable	Qty 1	Ply 1	Lot 17 Heritage @ NC Job Reference (optional)	162214247
-------------------	---------------	-------------------------------------	----------	----------	--	-----------

Comtech, Inc. Fayetteville, NC - 28314,

8.430 s Jan 6 2022 MiTek Industries, Inc. Mon Nov 27 16:15:44 2023 Page 1
ID:JQb1igK2ne3CQdqy3dwnCxyStrD-RfC?PsB70Hq3NSgPqnL8w3ulTXbGKWrCDoi7J4zJC?f

0-1/8

0-1/8

Scale = 1:24.9

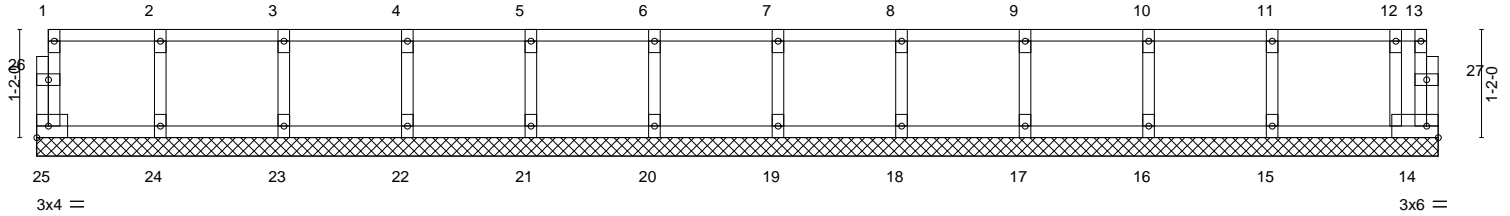

LOADING (psf)		SPACING-		CSI.		DEFL.				PLATES	GRIP
TCLL	40.0	Plate Grip DOL	1.00	TC	0.08	in	(loc)	l/defl	L/d	MT20	244/190
TCDL	10.0	Lumber DOL	1.00	BC	0.02	Vert(LL)	n/a	-	n/a		
BCLL	0.0	Rep Stress Incr	YES	WB	0.03	Vert(CT)	n/a	-	n/a		
BCDL	5.0	Code	IRC2015/TPI2014	Matrix-R		Horz(CT)	0.00	14	n/a		
										Weight: 65 lb	FT = 20%F, 11%E

LUMBER-
TOP CHORD 2x4 SP No.1(flat)
BOT CHORD 2x4 SP No.1(flat)
WEBS 2x4 SP No.3(flat)
OTHERS 2x4 SP No.3(flat)

BRACING-
TOP CHORD Structural wood sheathing directly applied or 6-0-0 oc purlins, except end verticals.
BOT CHORD Rigid ceiling directly applied or 10-0-0 oc bracing.

REACTIONS. All bearings 15-1-8.
(lb) - Max Grav All reactions 250 lb or less at joint(s) 25, 14, 24, 23, 22, 21, 20, 19, 18, 17, 16, 15

FORCES. (lb) - Max. Comp./Max. Ten. - All forces 250 (lb) or less except when shown.

- NOTES-**
- 1) All plates are 1.5x3 MT20 unless otherwise indicated.
 - 2) Plates checked for a plus or minus 1 degree rotation about its center.
 - 3) Gable requires continuous bottom chord bearing.
 - 4) Truss to be fully sheathed from one face or securely braced against lateral movement (i.e. diagonal web).
 - 5) Gable studs spaced at 1-4-0 oc.
 - 6) Recommend 2x6 strongbacks, on edge, spaced at 10-0-0 oc and fastened to each truss with 3-10d (0.131" X 3") nails. Strongbacks to be attached to walls at their outer ends or restrained by other means.

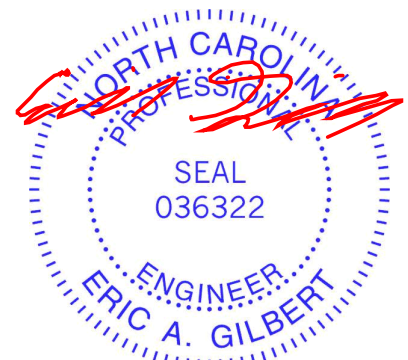

November 28, 2023

WARNING - Verify design parameters and READ NOTES ON THIS AND INCLUDED MITEK REFERENCE PAGE MII-7473 rev. 1/2/2023 BEFORE USE.
Design valid for use only with MiTek® connectors. This design is based only upon parameters shown, and is for an individual building component, not a truss system. Before use, the building designer must verify the applicability of design parameters and properly incorporate this design into the overall building design. Bracing indicated is to prevent buckling of individual truss web and/or chord members only. Additional temporary and permanent bracing is always required for stability and to prevent collapse with possible personal injury and property damage. For general guidance regarding the fabrication, storage, delivery, erection and bracing of trusses and truss systems, see **ANSI/TPH Quality Criteria and DSB-22** available from Truss Plate Institute (www.tpinst.org) and **BCSI Building Component Safety Information** available from the Structural Building Component Association (www.sbcacomponents.com)



818 Soundside Road
Edenton, NC 27932

Symbols

PLATE LOCATION AND ORIENTATION

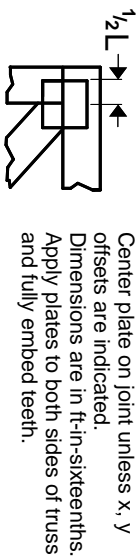

Center plate on joint unless x, y offsets are indicated. Dimensions are in ft-in-sixteenths. Apply plates to both sides of truss and fully embed teeth.

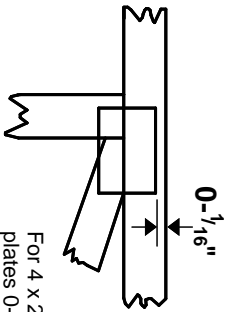

For 4 x 2 orientation, locate plates 0- 1/16\" from outside edge of truss.

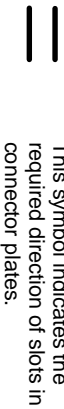

* Plate location details available in MITek software or upon request.

PLATE SIZE

4 X 4

The first dimension is the plate width measured perpendicular to slots. Second dimension is the length parallel to slots.

LATERAL BRACING LOCATION



Indicated by symbol shown and/or by text in the bracing section of the output. Use T or I bracing if indicated.

BEARING

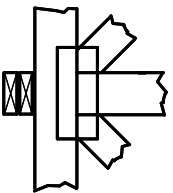

Indicates location where bearings (supports) occur. Icons vary but reaction section indicates joint number/letter where bearings occur. Min size shown is for crushing only.

Industry Standards:

ANSI/TP1: National Design Specification for Metal Plate Connected Wood Truss Construction.
DSB-22: Design Standard for Bracing.
BCSI: Building Component Safety Information, Guide to Good Practice for Handling, Installing, Restraining & Bracing of Metal Plate Connected Wood Trusses.

Numbering System

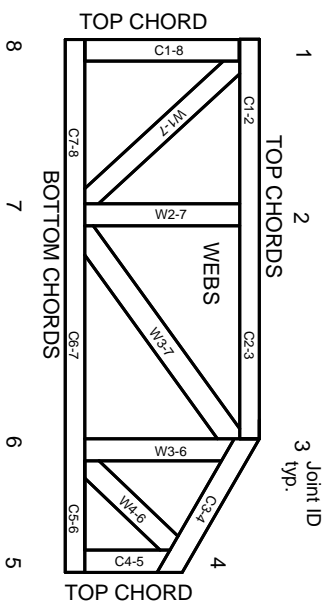

JOINTS ARE GENERALLY NUMBERED/LETTERED CLOCKWISE AROUND THE TRUSS STARTING AT THE JOINT FARTHEST TO THE LEFT.

CHORDS AND WEBS ARE IDENTIFIED BY END JOINT NUMBERS/LETTERS.

Product Code Approvals

ICC-ES Reports:

ESR-1988, ESR-2362, ESR-2685, ESR-3282
ESR-4722, ESL-1388

Design General Notes

Trusses are designed for wind loads in the plane of the truss unless otherwise shown.

Lumber design values are in accordance with ANSI/TP1 section 6.3. These truss designs rely on Lumber values established by others.

© 2023 MITek® All Rights Reserved

MITek

ENGINEERING BY
TRENGO
A MITek Affiliate

MITek Engineering Reference Sheet: MIL-7473 rev. 1/2/2023

General Safety Notes

Failure to Follow Could Cause Property Damage or Personal Injury

1. Additional stability/bracing for truss system, e.g. diagonal or X-bracing, is always required. See BCSI.
2. Truss bracing must be designed by an engineer. For wide truss spacing, individual lateral braces themselves may require bracing, or alternative Tor I bracing should be considered.
3. Never exceed the design loading shown and never stack materials on inadequately braced trusses.
4. Provide copies of this truss design to the building designer, erection supervisor, property owner and all other interested parties.
5. Cut members to bear tightly against each other.
6. Place plates on each face of truss at each joint and embed fully. Knots and wane at joint locations are regulated by ANSI/TP1 1.
7. Design assumes trusses will be suitably protected from the environment in accord with ANSI/TP1 1.
8. Unless otherwise noted, moisture content of lumber shall not exceed 19% at time of fabrication.
9. Unless expressly noted, this design is not applicable for use with fire retardant, preservative treated, or green lumber.
10. Camber is a non-structural consideration and is the responsibility of truss fabricator. General practice is to camber for dead load deflection.
11. Plate type, size, orientation and location dimensions indicated are minimum plating requirements.
12. Lumber used shall be of the species and size, and in all respects, equal to or better than that specified.
13. Top chords must be sheathed or purlins provided at spacing indicated on design.
14. Bottom chords require lateral bracing at 10 ft. spacing, or less, if no ceiling is installed, unless otherwise noted.
15. Connections not shown are the responsibility of others.
16. Do not cut or alter truss member or plate without prior approval of an engineer.
17. Install and load vertically unless indicated otherwise.
18. Use of green or treated lumber may pose unacceptable environmental, health or performance risks. Consult with project engineer before use.
19. Review all portions of this design (front, back, words and pictures) before use. Reviewing pictures alone is not sufficient.
20. Design assumes manufacture in accordance with ANSI/TP1 1 Quality Criteria.
21. The design does not take into account any dynamic or other loads other than those expressly stated.