

**Davidson Homes
Lot 58 Prince Place Subdivision**

Flow Reduction Request

Harnett County, North Carolina

Project Number: A79722.00

Date of Preparation: August 25, 2023

PROJECT MANAGEMENT



**Supporting Information &
Technical Specifications Prepared By:**
MacConnell & Associates, P.C.
Full-Service Consulting Engineers

501 Cascade Pointe Lane, Ste 103
Cary, North Carolina 27513

Post Office Box 129
Morrisville, North Carolina 27560

Telephone: (919) 467-1239

Fax: (919) 319-6510



P.O. Box 129
Morrisville, NC 27560



MacCONNELL & Associates, P.C.
"Engineering Today For Tomorrow's Future"

501 Cascade Pointe Lane
Suite 103

Cary, NC 27513

www.macconnellandassoc.com

(919) 467-1239

Technical Memorandum

To: Harnett County Health Department
Client: Davidson Homes
Subject: Prince Place Subdivision Lot 58

Date: August 25, 2023
From: David C. Barcal, P.E.
Project No.: A79722.00

This technical memorandum is a request for a design daily flow exemption to a residential dwelling using low flow fixtures as provided for in Session Law 2013-413 (House Bill 74) and Session Law 2014-120 Section 53 which relates to Rule 15A NCAC 18A .1949. Neither the State nor local health department shall be liable for any damages caused by an engineered system approved or permitted pursuant to Session Law 2014-120 Section 53.

Davidson Homes is developing the property located at Lot 58 of Prince Place Subdivision in Harnett County, NC. A copy of the deed and septic proposal can be found in the Existing Information portion of this application package. MacConnell & Associates, P.C. (M&A) is requesting a 25 percent flow reduction, using low-flow fixtures, to be incorporated into the design so that the home may be permitted as a 4-bedroom without needing to increase the size of the drainfield. The proposed treatment system is sized for the unadjusted flow of 480-GPD. The proposed initial and repair drainfields are sized for the reduced design flow of 360-GPD.

This request is for a flow reduction per provisions provided in Session Law 2013-413 and Session Law 2014-120. Typically, the basis for the design flow is provided in 15A NCAC 18A and prior regulations. The applicable regulations which preceded the 15A NCAC 18A rules and which served as the basis in determining flow in the 15A NCAC 18A rules: dates well before The Energy Policy Act of 1992 which established maximum flow rates for various fixtures in a nationwide effort to reduce both energy and water use. The flows which were established in the Act have recently been further reduced through the WaterSense program, which allows for labeling of fixtures which meet minimum criteria and conserve water.

Specifications for each fixture model can be found in the Proposed Fixtures section of this application package. A summary of the fixtures and flow rates can be found below in Table 1. A washing machine will be installed by the Owner in the future, so to calculate flow rates, M&A has elected to go with the base-rule flow to provide a conservative estimate

Table 1. Flow rates of proposed fixtures installed by builder.

Fixtures	No.	Manufacturers	Flow Rate	Units
Kitchen Faucet	1	Moen Integra 67315	1.50	GPM
Bathroom Faucet	7	Moen Chateau L4625	1.50	GPM
Master Bath Showerhead	1	Moen Chateau TL182	2.50	GPM
Showerhead	4	Moen Chateau TL183	2.50	GPM
Toilets	5	Gerber Maxwell MX29-990	1.60	GPF

Table 2 identifies the type of fixture, flows for fixtures based on the 15A NCAC 18A rules (Flow A), and flows for proposed fixtures (Flow B). The savings or water conservation from both the rule-based flows and proposed conditions are presented in both flow and percent below (Table 2).

Table 2. Savings of water from rule-based flows with the proposed fixtures.

Fixture	No.	Units	Base/Rule Flow A	Proposed Flow B	A to B Savings	A to B % Savings
Kitchen Faucet	1	GPM	3.0	1.5	1.5	50%
Bathroom Faucet	7	GPM	3.0	1.5	1.5	50%
Showerhead	4	GPM	5.5	2.5	3.0	55%
Toilet	5	GPF	3.5	1.60	1.9	54%
Clothes Washer	1	GPL	32.0	32.0	0.0	0%

Documentation for the above values is presented at the end of this discussion. The documentation includes:

1. Rule basis of flow and effective dates of rule.
2. Typical indoor water use.
3. Proposed fixtures.
4. Supporting documentation including historical flow rates for fixtures.
5. Technical Advisory Council Report for Wastewater Flows from Single Family Dwellings
6. Existing Information.

The projected flows using rule-based design flowrates would be:

Unadjusted Design Flow per Rule (15A NCAC 18A and prior regulations)

<u>Description</u>	<u>No.</u>	<u>Flow/Unit</u>	<u>Total</u>
Bedrooms	4	120 GPD	480 GPD
Total			480 GPD

Using the information presented above on flow A and B, the projected water use is presented in Table 3 below. The savings presented are from fixture rates when the rules were made effective in comparison to the flow rates with the proposed fixtures.

Table 3. Proposed Fixtures Useage.

Fixture	% Use	Base Flow GPD	% Savings	Savings GPD	Adjusted GPD	
Kitchen Faucet	6%	29	50%	15	14	
Bathroom Faucet	10%	48	50%	24	24	
Showerhead*	19%	91	55%	50	41	
Toilet	28%	134	54%	73	61	
Clothes Washer	22%	106	0%	0	106	
Leaks & Other	15%	72	0%	0	72	
Total	100%	480	34%	162	318	66%

The projected flow of 318 GPD is approximately sixty-six percent of the design flow which we have found to be typical of homes with water conscious fixtures. We are requesting a 25 percent reduction or a design flow for subsurface disposal of 360 GPD.

Analysis of wastewater shows that with the flow reduction, the waste is not considered high strength at presented below:

	Base Flow Concentration	Reduced Flow Concentration (220/1-.25)	High Strength
BOD₅	220 mg/l	293 mg/l	350 mg/l
TSS	220 mg/l	293 mg/l	350 mg/l

Thus, the effluent from the septic tank is expected to be similar to a non-reduced flow effluent. Based on this analysis, the use of low-flow fixtures provides sufficient remaining capacity. We respectfully ask for acceptance of this proposal.

Table of Contents

1. Rule basis of flow and effective dates of rule.
2. Typical indoor water use.
3. Proposed fixtures.
4. Supporting documentation including historical flow rates for fixtures and washer.
5. Technical Advisory Council Report for Wastewater Flows from Single Family Dwellings.
6. Existing information.

1. Rule basis of flow and effective dates of rule.

15A NCAC 18A .1949 SEWAGE FLOW RATES FOR DESIGN UNITS

(a) In determining the volume of sewage from dwelling units, the flow rate shall be 120 gallons per day per bedroom. The minimum volume of sewage from each dwelling unit shall be 240 gallons per day and each additional bedroom above two bedrooms shall increase the volume of sewage by 120 gallons per day. In determining the number of bedrooms in a dwelling unit, each bedroom and any other room or addition that can reasonably be expected to function as a bedroom shall be considered a bedroom for design purposes. When the occupancy of a dwelling unit exceeds two persons per bedroom, the volume of sewage shall be determined by the maximum occupancy at a rate of 60 gallons per person per day.

(b) Table No. I shall be used to determine the minimum design daily flow of sewage required in calculating the design volume of sanitary sewage systems to serve selected types of establishments. The minimum design volume of sewage from any establishment shall be 100 gallons per day. Design of sewage treatment and disposal systems for establishments not identified in this Rule shall be determined using available flow data, water-using fixtures, occupancy or operation patterns, and other measured data.

TABLE NO. 1

TYPE OF ESTABLISHMENT	DAILY FLOW FOR DESIGN
Airports (Also R.R. stations, bus terminals --not including food service facilities)	5 gal/passenger
Barber Shops	50 gal/chair
Bars, Cocktail Lounges (Not including food service)	20 gal/seat
Beauty Shops (Style Shops)	125 gal/chair
Bowling Lanes	50 gal/lane
Businesses (other than those listed elsewhere in this table)	25 gal/employee
Camps	
Construction or Work Camps	60 gal/person
	40 gal/person (with chemical toilets)
Summer Camps	60 gal/person
Campgrounds -- With Comfort Station (Without water and sewer hookups)	100 gal/campsite
Travel Trailer/Recreational Vehicle Park (With water and sewer hookups)	120 gal/space
Churches (Not including a Kitchen, Food Service Facility, Day Care or Camp)	3 gal/seat
Churches (With a Kitchen but, not including a Food Service Facility, Day Care, or Camp)	5 gal/seat
Country Clubs	20 gal/member
Day Care Facilities	15 gal/person
Factories (Exclusive of industrial waste)	25 gal/person/shift
Add for showers	10 gal/person/shift
Food Service Facilities	
Restaurants	40 gal/seat or 40 gal/15 ft ² of dining area, whichever is greater
24-hour Restaurant	75 gal/seat
Food Stands	
(1) Per 100 square feet of food stand floor space	50 gal
(2) Add per food employee	25 gal
Other Food Service Facilities	5 gal/meal
Hospitals	300 gal/bed
Marinas	10 gal/boat slip
With bathhouse	30 gal/boat slip
Meat Markets	

(1) Per 100 square feet of market floor space	50 gal
(2) Add per market employee	25 gal
Motels/Hotels	120 gal/room
With cooking facilities	175 gal/room
Offices (per shift)	25 gal/person
Residential Care Facilities	60 gal/person
Rest Homes and Nursing Homes	
With laundry	120 gal/bed
Without laundry	60 gal/bed
Schools	
Day Schools	
With cafeteria, gym, and showers	15 gal/student
With cafeteria only	12 gal/student
With neither cafeteria nor showers	10 gal/student
Boarding Schools	60 gal/person
Service Stations	250 gal/water closet or urinal
24-hour Service Stations	325 gal/water closet
Stores, Shopping Centers, and Malls (Exclusive of food service and meat markets)	120 gal/1000 ft ² of retail sales area
Stadium, Auditorium, Theater, Drive-in	5 gal/seat or space
Swimming Pools, Spas, and Bathhouses	10 gal/person

(c) An adjusted design daily sewage flow may be granted by the local health department upon a showing as specified in Subparagraphs (c)(1) through (c)(2) that a sewage system is adequate to meet actual daily water consumption from a facility included in Paragraph (b) of this Rule.

- (1) Documented data from that facility or a comparable facility justifying a flow rate reduction shall be submitted to the local health department and the State. The submitted data shall consist of at least 12 previous consecutive monthly total water consumption readings and at least 30 consecutive daily water consumption readings. The daily readings shall be taken during a projected normal or above normal sewage flow month. A peaking factor shall be derived by dividing the highest monthly flow as indicated from the 12 monthly readings by the sum of the 30 consecutive daily water consumption readings. The adjusted design daily sewage flow shall be determined by taking the numerical average of the greatest ten percent of the daily readings and multiplying by the peaking factor. Further adjustments shall be made in design sewage flow rate used for sizing nitrification fields and pretreatment systems when the sampled or projected wastewater characteristics exceed those of domestic sewage, such as wastewater from restaurants or meat markets.
- (2) An adjusted daily sewage flow rate may be granted contingent upon use of extreme water-conserving fixtures, such as toilets which use 1.6 gallons per flush or less, spring-loaded faucets with flow rates of one gallon per minute or less, and showerheads with flow rates of two gallons per minute or less. The amount of sewage flow rate reduction shall be determined by the local health department and the State based upon the type of fixtures and documentation of the amount of flow reduction to be expected from the proposed facility. Adjusted daily flow rates based upon use of water-conserving fixtures shall apply only to design capacity requirements of dosing and distribution systems and nitrification fields. Minimum pretreatment capacities shall be determined by the design flow rate of Table I of this Rule.

History Note: Authority G.S. 130A-335(e);
Eff. July 1, 1982;
Amended Eff. January 1, 1990; January 1, 1984.

2. Typical indoor water use.

Indoor Water Use at Home

 gracelinks.org/124/indoor-water-use-at-home



Shutterstock.com

Fortunately, when we want fresh, clean water, all most of us have to do is turn on a faucet. On average, our direct indoor water use (water you use from your tap, toilet, dishwasher, etc.) adds up to about 60 gallons of water a day per person.

Here's how indoor water use breaks down:

- Toilets (28 percent)
- Washing Machines (22 percent)
- Showers and Baths (19 percent)
- Sinks (16 percent)
- Household Leaks (14 percent)

That last number is surprising – it's almost 10 gallons of water per person per day lost to leaky toilets and faucets.

Conserving Water with Water-Efficient Toilets, Showerheads and More

Fortunately, saving water around the house is easier today than ever before. Newer (low-flow) toilets, showerheads and faucets are designed to be more efficient than older models and can save your household gallons every day. For example, older toilets use up to 7 gallons per flush, whereas low-flow toilets use 1.5 gallons or less.

Likewise, older showerheads flow over 4 gallons per minute, while low-flow models can flow as low as 1.5 gallons per minute. Be careful what showerhead you purchase, though, because some fixtures, especially those with multiple nozzles, exceed the federal limit of 2.5 gallons per minute. If you use one of those, consider cutting back your shower time.

Check out EPA's WaterSense website for water- and energy- saving products. In addition, you can find energy- and water-saving appliances like dishwashers and washing machines through DOE's ENERGY STAR label. By switching to water-saving fixtures and appliances you can reduce your indoor water use by a third on average.

Heating is a Water and Energy Hog!

In most households water heating is a huge energy user, after indoor heating and cooling, appliances, electronics and lighting. So sadly, long hot showers waste both water and energy! Although modern fixtures and appliances are a great way to save gallons, it's still important to simply turn off the tap.

By taking simple steps to reduce your water use at home you can save gallons, energy and dollars every day! To find lots of ways to save water and energy visit the [Water Saving Tips](#) page.

...

Did You Know? Washing dishes by hand takes about 20 gallons per load but Energy Star dishwashers only use 4 to 6 gallons. Even standard machines use only 6 to 8 gallons. If you do wash dishes by hand, turn off the tap until you're ready to rinse.

3. Proposed fixtures.

Prince Place - Lot 58

Location	Fixture	Qty	Manufacture	Model
Kitchen	Sink Faucet	1	Moen	Integra 67315
Guest Bath	Sink Faucet	1	Moen	Chateau L4625
Guest Bath	Shower	1	Moen	Chateau TL182
Guest Bath	Toilet	1	Gerber	Maxwell MX28-990 Tank
Bath 2	Sink Faucet	2	Moen	Chateau L4625
Bath 2	Tub/Shower	1	Moen	Chateau TL183
Bath 2	Toilet	1	Gerber	Maxwell MX28-990 Tank
Bath 3	Sink Faucet	1	Moen	Chateau L4625
Bath 3	Tub/Shower	1	Moen	Chateau TL183
Bath 3	Toilet	1	Gerber	Maxwell MX28-990 Tank
3rd Floor Bath	Sink Faucet	1	Moen	Chateau L4625
3rd Floor Bath	Tub/Shower	1	Moen	Chateau TL183
3rd Floor Bath	Toilet	1	Gerber	Maxwell MX28-990 Tank
Owner's Bath	Sink Faucet	2	Moen	Chateau L4625
Owner's Bath	Shower	1	Moen	Chateau TL182
Owner's Bath	Soaker Tub	1	Moen	Chateau T994 w/4793 Valve
Owner's Bath	Toilet	1	Gerber	Maxwell MX28-990 Tank
Laundry Room	Sink Fixture	1	Moen	Chateau 74998

MOEN®

There is more than one version of this model.
Page down to identify the version you have.

DESCRIPTION

- Metal construction with various finishes identified by suffix
- Pullout spray with 59" braided hose
- Flexible supplies with 3/8" compression fittings

OPERATION

- Lever style handle
- Temperature controlled by 100° arc of handle travel
- Spout rotation is 120°
- Operates with less than 5lbs. of force
- Operates in stream or spray mode in the pullout or retracted position

FLOW

- Flow is limited to 1.5 gpm (5.7 L/min) at 60 psi

CARTRIDGE

- 1255™ Duralast™ cartridge

STANDARDS

- Third party certified to IAPMO Green, ASME A112.18.1/CSA B-125.1 and all applicable requirements referenced therein including NSF 61/9 & 372
- Meets CalGreen and Georgia SB370 requirements
- Complies with California Proposition 65 and with the Federal Safe Drinking Water Act
- The backflow protection system in the device consists of two independently operating check valves, a primary and a secondary which prevent backflow
- **ADA**  for lever handle

WARRANTY

- Lifetime limited warranty against leaks, drips and finish defects to the original homeowner
 - 10 year limited warranty when used in a multifamily installation
 - 5 year limited warranty when used in a commercial installation
- Visit www.moen.com/support for complete details and limitations

Specifications

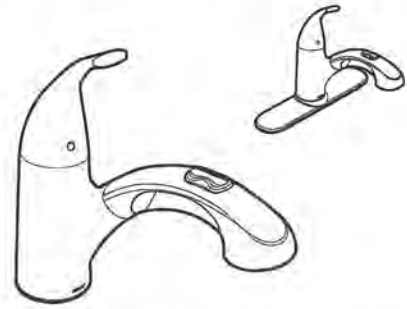

Integra® Single Control Kitchen Faucet

Models: 67315 series

NOTE: DESIGNED TO INSTALL
THROUGH 1 OR 3 HOLES 1-1/2" (38mm) DIA.

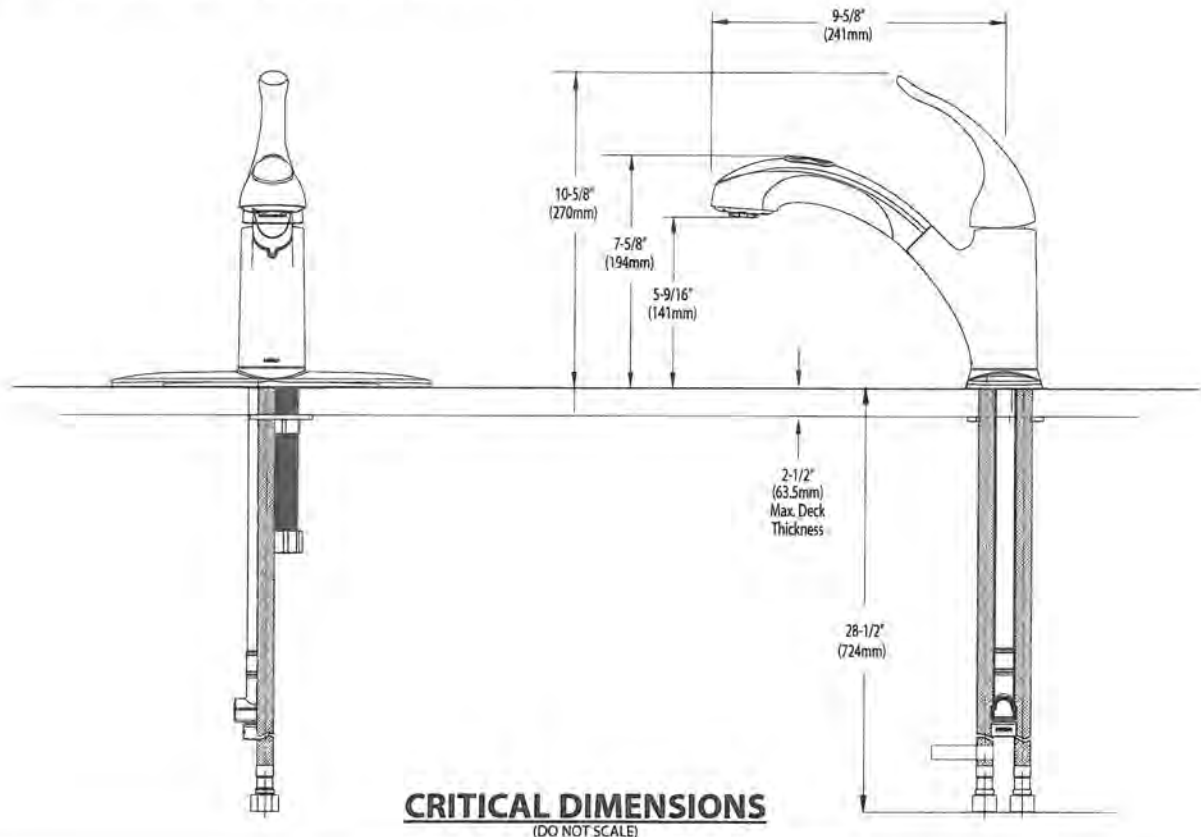

There is more than 1 version of this model.
Page down to identify the version you have.

DESCRIPTION

- Metal construction with various finishes identified by suffix
- Flexible supplies with 3/8" compression fittings
- Includes metal or 50/50 pop-up type waste assembly where noted

OPERATION

- Pivot action lever style handle
- Temperature controlled through 100° degree arc of handle travel

FLOW

- Water usage is limited to these maximum flow rates as indicated by the corresponding product markings
- ° 1.2 gpm max (4.5L/min) at 60 psi
- ° 1.5 gpm max (5.7L/min) at 60 psi

CARTRIDGE

- 1255™ Duralast™ cartridge
- Nonmetallic/nonferrous and stainless steel material

STANDARDS

- Third party certified to WaterSense®, ASME A112.18.1/CSA B125.1 and all applicable requirements referenced therein
- Certified to NSF 61/9 & 372
- Products marked with 1.2 gpm are compliant with California water efficiency regulations
- Complies with California Proposition 65 and with the Federal Safe Drinking Water Act
- **ADA**  for lever handle

WARRANTY

- Lifetime limited warranty against leaks, drips and finish defects to the original consumer purchaser
- 5 year warranty if used in commercial installations



CHATEAU® Single-Handle Lavatory Faucet

with Metal Waste Assembly

Model: L4625 series

L4631BC

Bulk Packed (12 per carton):
L64624 series

with 50/50 Waste Assembly

Bulk Packed (12 per carton):
L64625 series

Less Waste

Bulk Packed (12 per carton):
L64600 series

NOTE: THIS FAUCET IS DESIGNED TO BE
INSTALLED THRU 3-1" DIA. HOLES, 2" ON CENTER

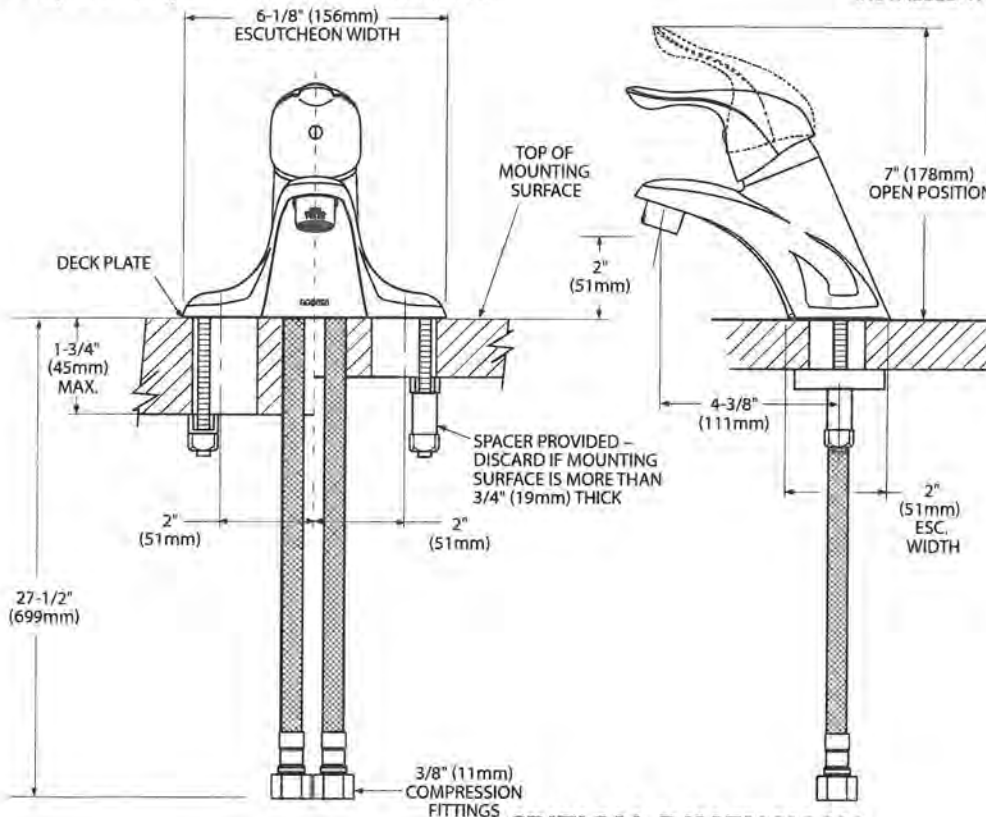

CRITICAL DIMENSIONS (DO NOT SCALE)



Buy it for looks. Buy it for life.®

There is more than 1 version of this model.
Page down to identify the version you have.

DESCRIPTION

- Metal construction with various finishes identified by suffix
- Includes non-metallic showerhead, arm, flange and non-metallic diverter tub spout

OPERATION

- Handle operates counterclockwise through a 270° arc with off at 6 o'clock and maximum hot at the 9 o'clock position. Shut off in clockwise direction
- Adjustable temperature limit stop to control maximum hot water temperature
- Pressure balancing mechanism maintains selected discharge temperature to ± 3°

FLOW

- Showerhead is limited to 2.5 gpm (9.5 L/min) at 80 psi
- EP suffix models are limited to 1.75 gpm (6.6 L/min) at 80 psi
- NH suffix models contain no showerhead

CARTRIDGE

- 1222 cartridge design
- Accommodates back to back installations
- Nonmetallic/nonferrous and stainless steel material

STANDARDS

- Third party certified to meet ASME A112.18.1/CSA B125.1 and all applicable requirements referenced therein
- EP suffix models are third party certified to WaterSense®

- ADA for lever handle

WARRANTY

- Lifetime limited warranty against leaks, drips and finish defects to the original consumer purchaser
- 5 year warranty if used in commercial installations

Specifications



**CHATEAU® POSI-TEMP®
Single-Handle Tub/Shower Trim Kit**

- Models:** TL181 series - valve trim only
(Bulk Packed 12 per carton)
TL182 series - shower trim only
(Bulk Packed 12 per carton)
TL183 series - tub/shower trim
(Bulk Packed 12 per carton)

- Valves:** 62300 series
2500 series

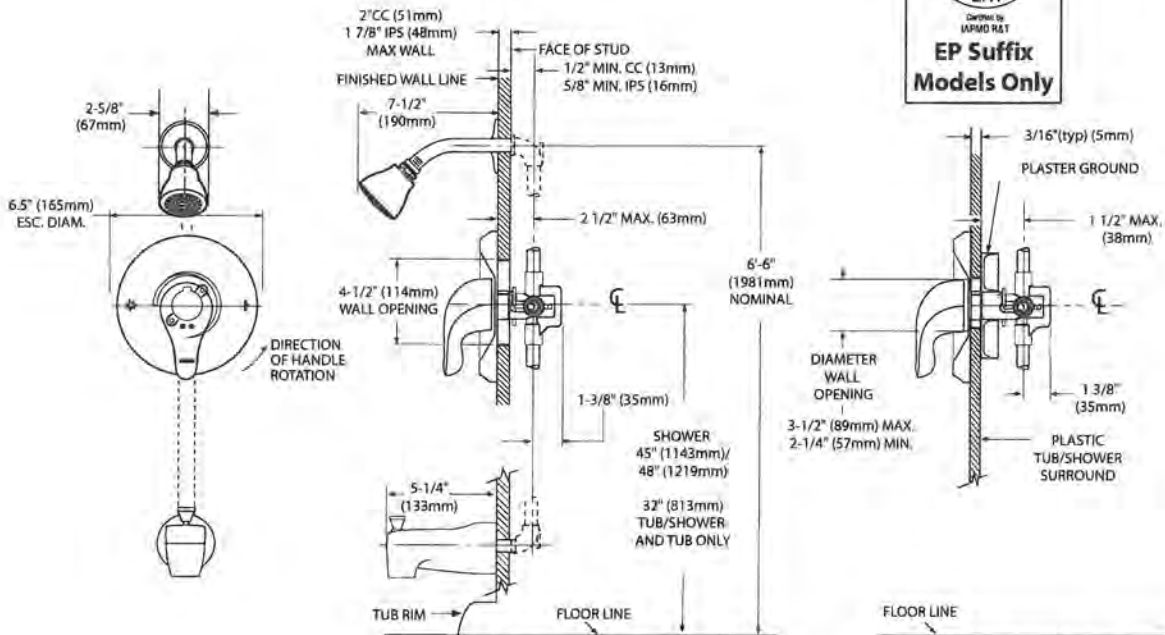

THICK WALL APPLICATION
CRITICAL DIMENSIONS
(DO NOT SCALE)



GERBER

www.gerberonline.com

Maxwell® 1.6 GPF Elongated Toilet

12" Rough-in

Features:

□ MX-21-412

- Vitreous china
- Combination bowl and tank
- 3" Flush valve
- 12" Rough-in
- Elongated bowl
- Dual-fed siphon jet action bowl (no splashing)
- 2" Fully Glazed trapway for effective waste removal
- Color matched metal tank lever
- 6 point tank to bowl connection for tank stability
- Sanitary bead for easy cleaning
- Color matched Bolt caps included
- Toilet seat not included



Technical Information:

Included Components:

- Combination MX-21-412
- Bowl 21-962
- Tank MX-28-990

Other Tank Options: (bowl to be purchased separately)

- Insulated Tank MX-28-992
- Tank with Right Hand Lever MX-28-990-97

Fixtures:

Configuration	Two-piece, elongated
Water per Flush	1.6 gpf (6 lpf)
Rough-In	12"
Height	28"
Width	17 1/2"
Depth	28 1/8"
Trapway	2"
Large Water Surface	10 7/8" x 7 1/2"
Shipping Weight	79.5 lbs

Accessories:

Soft Close Toilet Seat	99-213
------------------------	--------

Colors/Finishes:

- White
- Other: Refer to Price Book for additional colors/finishes

Warranty:

- Limited lifetime warranty

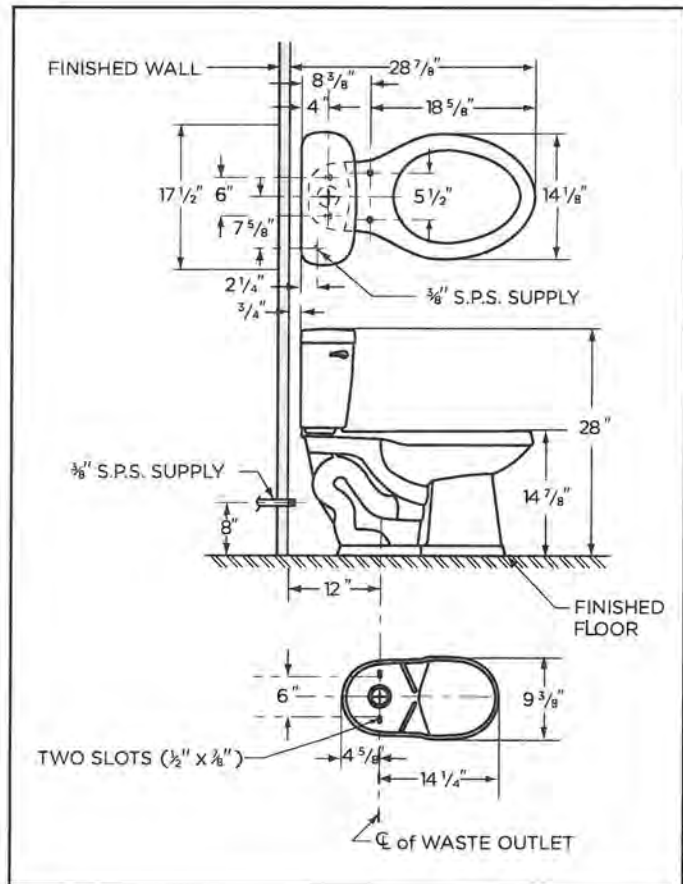

NOTES: All dimensions are in inches. Illustrations may not be drawn to scale.

IMPORTANT:

Dimensions of fixtures are nominal and may vary within the range of tolerances established by ASME standard A 112.19.2 THIS FIXTURE QUALIFIES ACCORDING TO ASME TEST PROCEDURES AS A HIGH EFFICIENCY WATER CLOSET WITH AN AVERAGE CONSUMPTION OF 1.28 gpf (4.8 Lpf) OR LESS.



4. Supporting documentation including historical flow rates for fixtures and washer.

WaterSense® High-Efficiency Lavatory Faucet Specification

Supporting Statement

I. Introduction

The WaterSense program released its High-Efficiency Lavatory¹ Faucet Specification (specification) on October 1, 2007, to promote and enhance the market for water-efficient lavatory faucets. The goal of this specification is to allow consumers to identify and differentiate products in the marketplace that meet this specification's criteria for water efficiency and performance.

This specification addresses lavatory faucets and lavatory faucet accessories² in private use, such as those found in residences, and private restrooms in hotels and hospitals. Since these types of faucets are used primarily for hand washing and other sanitary activities, such as face washing and razor rinsing, WaterSense believes that maximum flow rates can be reduced enough to impact national water consumption while at the same time not negatively impacting user satisfaction. This specification is not intended to address kitchen faucets, which have a very different set of uses and performance criteria, or public restroom faucets (e.g., airports, theaters, arenas, stadiums, offices, and restaurants), which already have national performance standards and criteria to which they should conform.

II. Current Status of Faucets

WaterSense estimates that currently there are 222 million residential lavatory faucets in the United States. This estimate is based on an assumed one-to-one ratio of lavatory faucets to residential bathrooms.³ In addition to the existing stock, approximately 25 million new faucets are sold each year for installation in new homes or replacement of aging fixtures in existing homes.⁴ Of these 25 million faucets, roughly two-thirds of those are lavatory faucets (approximately 17 million units). Residential lavatory and kitchen faucets account for

¹ Lavatory is the terminology used in the Energy Policy Act of 1992 and ASME A112.18.1 to describe the types of faucets to which the standards apply. In this specification, lavatory means any bathroom sink faucets intended for private use.

² Accessory, as defined in ASME 112.18.1, means a component that can, at the discretion of the user, be readily added, removed, or replaced, and that, when removed, will not prevent the fitting from fulfilling its primary function. For the purpose of this specification, an accessory can include, but is not limited to lavatory faucet flow restrictors, flow regulators, aerator devices, laminar devices, and pressure compensating devices.

³ U.S. Census Bureau, American Housing Surveys for the United States, 1970-2003.

⁴ Business Trend Analysts, 2006. "2005/2006 Outlook for the U.S. Plumbing Fixtures and Fittings Industry." <www.mindbranch.com/catalog/print_product_page.jsp?code=R225-358>

approximately 15.7 percent of indoor residential water use in the United States⁵—equivalent to more than 1.1 trillion gallons of water used each year.

The Energy Policy Act of 1992 originally set the maximum flow rate for both lavatory and kitchen faucets at 2.5 gallons per minute (gpm) at 80 pounds per square inch (psi) static pressure. In 1994, American Society of Mechanical Engineers (ASME) A112.18.1M-1994–Plumbing Supply Fittings set the maximum flow rate for lavatory faucets at 2.2 gpm at 60 psi. In response to industry requests for conformity with a single standard, in 1998, the U.S. Department of Energy adopted the 2.2 gpm at 60 psi maximum flow rate standard for all faucets (see 63 FR 13307; March 18, 1998). This national standard is codified in the *U.S. Code of Federal Regulations* at 10 CFR Part 430.32. As a point of reference, the maximum flow rates of many of the pre-1992 faucets range from 3 to 7 gpm. Other than the aforementioned maximum flow rate standards, there currently are no universally accepted performance tests or specifications (e.g., rinsing or wetting performance standards) for faucets.

III. WaterSense High-Efficiency Lavatory Faucet Specification

Scope

The WaterSense program developed this specification to address criteria for improvement and recognition of water-efficient and high-performance lavatory faucets and lavatory faucet accessories. WaterSense labeled lavatory faucet accessories can be incorporated into the design of new faucets to control the flow rate and provide the mechanism for meeting this specification's criteria, or can be purchased separately and retrofit onto existing older faucets to provide water efficiency and performance. This specification focuses solely on the category of lavatory faucets intended for private use because of the differences in the uses and performance expectations between private lavatory faucets and kitchen or public restroom faucets. Lavatory faucets are used primarily for hand washing and other sanitary activities, such as teeth brushing, face washing, and shaving. For these activities, discussions with faucet manufacturers and water utility representatives provided a general consensus that a reduction in the maximum flow rate from 2.2 gpm (the current federal water-efficiency standard) to 1.5 gpm, as established by this specification, is not very noticeable for most users. The most noticeable differences are increased wait times when filling the basin or waiting for hot water. While decreasing a faucet's maximum flow rate increases user wait time for these activities, WaterSense determined the potential water savings gained from the primary use of lavatory faucets (i.e., washing and rinsing) outweigh any potential inconvenience caused by increased wait times and will not negatively impact overall user satisfaction.

Kitchen sink faucets were excluded from this specification because the different uses and user expectations require other considerations for defining performance. One major performance consideration is a kitchen faucet's ability to effectively rinse dishes. Kitchen faucets also are commonly used for pot or container filling, and significantly increased wait times might not be acceptable to most users. WaterSense determined that reducing the maximum flow rates of kitchen faucets would create issues of user satisfaction and be counter to its program goals of

⁵ Mayer, Peter W. and William B. DeOreo. Residential End Uses of Water. Aquacraft, Inc. Water Engineering and Management. American Water Works Association. 1998.

increasing efficiency while maintaining or improving performance. In order to maintain user satisfaction and ensure a high level of performance, a maximum flow rate greater than what is suitable for lavatory faucets might need to be considered for kitchen faucets. Some type of wetting or rinsing performance test also might need to be included. In addition, there is an emerging area of research and development in multiposition control lever faucet technologies that offer users “high” and “low” settings for different activities. While performance data are not yet available, these technologies might prove to be effective in using water more efficiently. For these reasons, WaterSense intends to evaluate the possibility of developing a WaterSense specification for kitchen faucets at a later date.

Public restroom and metering faucets (faucets that are set to discharge a specific amount of water or run for a specified period of time for each use) also were excluded from this specification because of their differing uses and performance expectations and because standards governing their maximum flow rate already exist. Public restroom faucets, for example, are used almost exclusively for hand washing or simple rinsing, compared to lavatory faucets in homes and in other private bathrooms that face a myriad of uses. As a consequence, the maximum flow rate for these public restroom and metering fixtures can be set significantly lower than the flow rate for private lavatory faucets without negatively impacting user satisfaction. Also, a separate set of standards already apply to these types of fixtures. Codified in the *U.S. Code of Federal Regulations* at 10 CFR Part 430 (specifically §430.32(o) Faucets) are standards setting the maximum flow rate for metering faucets at 0.25 gallons/cycle. Section 5.4.1 and Table 1 of ASME A112.18.1/CSA B125.1—Plumbing Supply Fittings also establish the maximum flow rates for public lavatory (other than metering) faucets at 0.5 gpm. As a consequence, this category of faucet is not covered by the current specification. If WaterSense decides to address water efficiency and performance for these types of faucets, it will do so under a separate specification at a later time.

Water-Efficiency and Performance Criteria

The water-efficiency component of this specification establishes a maximum flow rate of 1.5 gpm at an inlet pressure of 60 psi. Lowering the maximum flow rate from 2.2 gpm to 1.5 gpm (both at 60 psi) represents a 32 percent reduction, which is consistent with WaterSense’s stated goal of improving efficiency by at least 20 percent. Even when installed in systems with high water pressure (up to 80 psi), faucets designed to this specification will have maximum flow rates of approximately 1.75 gpm, which still represents a greater than 20 percent increase in efficiency. WaterSense chose to specify a test pressure of 60 psi to maintain consistency with the current industry standard (ASME A112.18.1—Plumbing Supply Fittings) to which all faucets sold in the United States must comply.

The requirements of this specification are also in harmony with other international standards. The Joint Standards Australia/Standards New Zealand Committee established standards for the rating and labeling of water-efficient products (AS/NZS 6400:2005). As part of the standard, water-efficient faucets are rated on a scale of 1 to 6 based on maximum flow rates. Under this system, comparable 1.5 gpm WaterSense labeled lavatory faucets would receive a 5 out of 6 star rating, meeting criteria for maximum flow rates between 4.5 liters per minute (L/min) (1.2 gpm) and 6.0 L/min (1.6 gpm).

Meeting or exceeding user expectations via the establishment of performance criteria for WaterSense labeled products is an important aspect of the WaterSense program. From the outset of discussions with interested parties, WaterSense was aware that performance of water-efficient lavatory faucets is affected by low water pressures. To ensure user satisfaction with WaterSense labeled lavatory faucets or lavatory faucet accessories across a range of possible user conditions, WaterSense has established a minimum flow rate of 0.8 gpm at 20 psi in the specification.

In developing these water-efficiency and performance criteria, WaterSense evaluated comments received during the draft specification's public forum and public comment period (see *Response to Issues Raised During Public Comment on February 2007 Draft Specification for WaterSenseSM Labeling of High-Efficiency Lavatory Faucets*). WaterSense also considered user satisfaction data generated from four high-efficiency lavatory faucet retrofit studies and the impact of pressure changes on product flow rates for various types of lavatory faucet accessories.

WaterSense established a maximum flow rate of 1.5 gpm at 60 psi because interested parties that provided comments on the draft specification generally agreed that a flow rate of 1.5 gpm would provide no noticeable difference for most users. In addition, data collected from retrofit studies demonstrate a high level of user satisfaction with high-efficiency lavatory faucets that have maximum flow rates of 1.0 and 1.5 gpm. Aquacraft, Inc. conducted retrofit studies in Seattle, Washington (2000)⁶ and East Bay Municipal Utility District (EBMUD), California (2003)⁷ in which they replaced existing lavatory faucet aerators with 1.5 gpm pressure compensating aerators. In the Seattle study, 58 percent of the participants felt their faucets with the new aerators performed the same or better than their old faucet fixtures and 50 percent stated they would recommend these aerators to others. In the EBMUD study, 80 percent of the participants felt their faucets with the new aerators performed the same or better than their old faucet fixtures, and 67 percent stated they would recommend these aerators to others. A third Aquacraft, Inc. retrofit study conducted in Tampa, Florida (2004)⁸ replaced existing lavatory faucet aerators with 1.0 gpm pressure compensating aerators. The participants in this study were receptive to an even higher-efficiency fixture, with 89 percent saying their new aerators performed the same or better than their old faucet fixtures and would recommend them to others. Seattle Public Utilities also provided WaterSense with survey results of customer use and satisfaction with 1.0 gpm pressure compensating aerators distributed through the utility's direct-mail showerhead and faucet aerator pilot program. According to its survey, 94 percent of the participants that received the free aerators installed them and only 2 percent disliked the aerators and removed them.⁹

⁶ Seattle Home Water Conservation Study: The Impacts of High-Efficiency Plumbing Fixture Retrofits in Single-Family Homes, December 2000.

⁷ Water Conservation Study: Evaluation of High-Efficiency Indoor Plumbing Fixture Retrofits in Single-Family Homes in the East Bay Municipal Utility District Service Area, July 2003.

⁸ Tampa Water Department Residential Water Conservation Study: The Impacts of High-Efficiency Plumbing Fixture Retrofits in Single-Family Homes, January 2004.

⁹ Seattle Public Utilities. "Showerhead/Aerator Pilot Program Summary." Unpublished.

WaterSense established a minimum flow rate of 0.8 gpm at 20 psi for several reasons. First, WaterSense felt this minimum flow rate was reasonable to ensure user satisfaction in homes with low water pressure based on comments that were received regarding the draft specification. Second, WaterSense received comments from several utilities regarding programs in which 1.0 gpm lavatory faucet aerators are provided to customers. These products have shown a high level of user satisfaction, and WaterSense wants to recognize these products and the efforts of the utilities to ensure that additional water savings can be achieved through such programs. Third, WaterSense wants to avoid restricting design options to the extent possible. The specification leaves open the possibility for the use of fixed orifice flow control devices (with a maximum flow rate of 1.5 gpm) instead of restricting manufacturers to the use of pressure compensating devices. Under the specification, a 1.5 gpm maximum flow rate fixed orifice aerator could qualify for use of the label (according to currently available product specifications and flow curves). Pressure compensating devices with maximum flow rates between 1.5 and 1.0 gpm could also qualify for the use of the WaterSense label (according to currently available product specifications and flow curves). WaterSense believes that this approach allows for the greatest degree of design freedom for manufacturers and supports existing utility programs, while still ensuring a high level of performance and user satisfaction.

In order for high-efficiency lavatory faucets to effectively emerge in the market following the release of the final version of this specification, the market must ideally be equipped to produce the faucets or faucet technology that the specification requires. WaterSense is not currently aware of any lavatory faucets on the market with a maximum flow rate of 1.5 gpm. There are, however, several types and models of faucet components and accessories currently available that have the capability to control the flow to the level that is required by this specification. As a result, WaterSense is confident that faucets and faucet accessories that meet the requirements of this specification can be readily brought to market.

Potential Water and Energy Savings

To estimate water and energy savings that can be achieved by products that meet this specification, WaterSense examined the Seattle (2000) and EBMUD (2003) Aquacraft retrofit studies, which provided actual water consumption reductions generated by the installation of high-efficiency, pressure-compensating 1.5 gpm aerators on lavatory faucets. WaterSense expects the results under this specification to be similar to what was found in these two studies. These studies indicate that installing high-efficiency aerators can yield significant reductions in household water consumption. Post faucet retrofit, the weighted average daily per capita reduction in water consumption achieved was 0.6 gallons per capita per day (gcpd). It is important to note that in both of these studies, kitchen faucets in each household were retrofitted with 2.2 gpm pressure compensating aerators. While these retrofits contributed in part to overall reductions in household water consumption, the retrofits simply brought those kitchen sink faucets up to current water-efficiency standards, therefore, WaterSense decided to set aside this confounding influence in order to estimate the water savings. Assuming the average household consists of 2.6 people, this equates to an average annual household savings of approximately 570 gallons of water (see Calculation 1).

Calculation 1. Average Household Water Savings

$$0.6 \text{ gpcd} \cdot 2.6 \text{ people/household} \cdot 365 \text{ days} = 570 \text{ gallons annually}$$

Extrapolated to the national level, potential estimated water savings could be as great as 61 billion gallons annually (see Calculation 2). These estimates clearly demonstrate the significant water savings potential of high-efficiency lavatory faucets and accessories.

Calculation 2. National Water Savings

$$570 \text{ gal/year} \cdot 107,574,000^{10} \text{ occupied residences w/ plumbing fixtures} = 61 \text{ billion gallons}$$

Based upon these estimates, the average household could save more than 70 kWh of electricity (see Calculation 3) or 350 cubic feet of natural gas (see Calculation 4) each year. National savings could exceed 3 billion kWh hours and 20 billion cubic feet (Bcf) of natural gas each year (see Calculations 5 and 6).

Calculation 3. Electricity Saving Per Household

$$(570 \text{ gal/year} \cdot 0.70) \cdot (176.5 \text{ kWh of electricity/1,000 gal}) = 70 \text{ kWh of electricity per year}$$

Calculation 4. Natural Gas Savings Per Household

$$(570 \text{ gal/year} \cdot 0.70) \cdot (0.8784 \text{ Mcf of natural gas/1,000 gal}) = 0.35 \text{ Mcf (350 cubic feet) of natural gas per year}$$

Calculation 5. National Electricity Savings Potential

$$(61,000,000,000 \text{ gal} \cdot 0.70 \cdot 0.40) \cdot (176.5 \text{ kWh of electricity/1,000 gal}) = 3 \text{ billion kWh of electricity nationwide}$$

Calculation 6. National Natural Gas Savings Potential

$$(61,000,000,000 \text{ gal} \cdot 0.70 \cdot 0.56) \cdot (0.8784 \text{ Mcf of natural gas/1,000 gal}) = 20 \text{ million Mcf of natural gas nationwide} = 20 \text{ Bcf of natural gas nationwide}$$

These calculations are based upon the following assumptions:

- Approximately 70 percent of faucet water used in a household is hot water (Tampa and Seattle Aquacraft studies).
- 42,788,000 (approximately 40 percent) of occupied residences in the United States heat their water using electricity.¹¹
- 60,222,000 (approximately 56 percent) of occupied residences in the United States heat their water using natural gas.¹²

¹⁰ U.S. Department of Housing and Urban Development and U.S. Census Bureau. American Housing Survey for the United States 2005. Table 1A-4 page 5.

¹¹ U.S. Department of Housing and Urban Development and U.S. Census Bureau. American Housing Survey for the United States 2005. Table 1A-5, page 6.

¹² U.S. Department of Housing and Urban Development and U.S. Census Bureau. American Housing Survey for the United States 2005. Table 1A-5, page 6.

- Water heating consumes 0.1765 kWh of electricity per gallon of water heated assuming:
 - Specific heat of water = 1.0 BTU/lb · ° F
 - 1 gallon of water = 8.34 lbs
 - 1 kWh = 3,412 BTUs
 - Incoming water temperature is raised from 55° F to 120° F (Δ 65 ° F).
 - Water heating process is 90 percent efficient, electric hot water heater.

Calculation 7.

$$[(1 \text{ gal} \cdot 1.0 \text{ BTU/lbs} \cdot ^\circ \text{F}) (1\text{kWh}/3,412 \text{ BTUs}) / (1 \text{ gallon}/8.34 \text{ lbs}) \cdot 65^\circ \text{F}] / 0.90 = 0.1765 \text{ kWh/gal}$$

- Water heating consumes 0.8784 Mcf of natural gas per 1,000 gallons of water heated assuming:
 - Specific heat of water = 1.0 BTU/lb · ° F
 - 1 gallon of water = 8.34 lbs
 - 1 Therm = 99,976 BTUs
 - Incoming water temperature is raised from 55° F to 120° F (Δ 65 ° F)
 - Water heating process is 60 percent efficient, natural gas hot water heater

Calculation 8.

$$[(1 \text{ gal} \cdot 1.0 \text{ BTU/lbs} \cdot ^\circ \text{F}) (1\text{Therm}/99,976 \text{ BTUs}) / (1 \text{ gallon}/8.34 \text{ lbs}) \cdot 65^\circ \text{F}] / 0.60 = 0.009053 \text{ Therms/gal}$$

Calculation 9.

$$0.010428 \text{ Therms/gal} \cdot 1,000 \text{ gal} \cdot 1\text{Mcf}/10.307 \text{ Therms} = 0.8784 \text{ Mcf/kgal}$$

Cost Effectiveness and Payback Period

The average homeowner retrofitting their lavatory faucets with WaterSense labeled high-efficiency lavatory faucet accessories (e.g., aerator, laminar flow device, flow restrictor) will realize accompanying \$3.26 savings on water and wastewater cost annually due to lower water consumption (see Calculation 10).

Calculation 10. Annual Water and Wastewater Cost Savings

$$570 \text{ gallons/year} \cdot \$5.72/1,000 \text{ gallons}^{13} = \$3.26/\text{year}$$

Factoring in the accompanying energy savings, the average household with electric water heating may save an additional \$6.65 (70 kWh/year · \$.095/kWh), for a combined annual savings of \$9.91. The average household with natural gas water heating, may save an additional \$4.56 (0.35 Mcf/year · \$13.04/Mcf), for a combined annual savings of \$7.82.

¹³ Raftelis Financial Consulting. Water and Wastewater Rate Survey. American Water Works Association. 2004.

Assuming that the average household has two lavatory faucets¹⁴, replacing the aerators in each lavatory faucet with a WaterSense labeled aerator would save \$1.63 per faucet on annual water and wastewater costs. The average payback period for the replacement of two lavatory faucet aerators would be approximately 10 months for those with electric water heating and 12 months for those heating with natural gas (See Calculations 11 and 12).

Calculation 11. Average Payback Period (Electric Water Heating)
 $\$8.00 / [\$3.26/\text{year} + (70 \text{ kWh}/\text{year} \cdot \$0.095/\text{kWh})] = 0.8 \text{ years } (\sim 10 \text{ months})$

Calculation 12. Average Payback Period (Natural Gas Water Heating)
 $\$8.00 / [\$3.26/\text{year} + (0.35 \text{ Mcf}/\text{year} \cdot \$13.04 /\text{Mcf})] = 1.0 \text{ years } (\sim 12 \text{ months})$

These calculations are based upon the following assumptions:

- WaterSense labeled retrofit devices retail for \$4.00 each.
- Average cost of electricity is \$0.095/kWh¹⁵.
- Average cost of natural gas is \$13.04/Mcf¹⁶.

Unit Abbreviations:

Bcf = billion cubic feet

BTU = British thermal unit

F = Fahrenheit

gal = gallon

gpcd = gallons per capita per day

gpm = gallons per minute

kgal = kilogallons

kWh = kilowatt hour

lbs = pounds

L/min = liters per minute

Mcf = thousand cubic feet

psi = pressure per square inch

WaterSense assumes that the cost of new faucets manufactured and sold as WaterSense labeled fixtures will not increase significantly since in many cases the manufacturer will simply need to substitute the current flow regulating device with a similar, more efficient rated device. In many cases this will be as simple as switching from the current 2.2 gpm aerator or laminar flow device to a comparable 1.5 gpm WaterSense labeled device

¹⁴ U.S. Department of Housing and Urban Development and U.S. Census Bureau. American Housing Survey for the United States 2005. Table 1A-3 page 4.

¹⁵ Average Retail Price of Electricity to Ultimate Customers by End-Use Sector, Energy Information Administration. <www.eia.doe.gov/cneaf/electricity/epa/epat7p4.html>

¹⁶ Short-Term Energy Outlook, Energy Information Administration. <www.eia.doe.gov/steo>

WaterSense® Specification for Showerheads

1.0 Scope and Objective

This specification establishes the criteria for showerheads labeled under the U.S. Environmental Protection Agency's (EPA's) WaterSense® program. It is applicable to showerhead fixture fittings, inclusive of:

- Fixed showerheads that direct water onto a user (excluding body sprays) for bathing purposes; and
- Hand-held showers, a subset of showerheads that are moveable devices for directing water onto a user. Hand-held showers can be installed on a support to function as a fixed showerhead.

When used in this document the term "showerhead" shall also include hand-held showers.

This specification is designed to ensure sustainable, efficient water use and a high level of user satisfaction with showerhead performance.

2.0 General Requirements

- 2.1 The showerhead shall conform to applicable requirements in ASME A112.18.1/CSA B125.1.¹
- 2.2 If the showerhead has more than one mode, all modes must meet the maximum flow rate requirement outlined in Section 3.1.1 and at least one of the modes, as specified by the manufacturer, must meet all of the requirements outlined in this specification.
- 2.3 The showerhead shall not be packaged, marked, or provided with instructions directing the user to an alternative water-use setting that would override the maximum flow rate, as established by this specification. Any instruction related to the maintenance of the product, including changing or cleaning showerhead components, shall direct the user on how to return the product to its intended maximum flow rate.

3.0 Water-Efficiency Criteria

- 3.1 The flow rate of the showerhead shall be tested in accordance with the procedures in ASME A112.18.1/CSA B125.1 and shall meet the following criteria:
 - 3.1.1 The manufacturer shall specify a maximum flow rate value (rated flow) of the showerhead. This specified value must be equal to or less than 2.0 gallons per minute (gpm) (7.6 liters per minute [L/min]).

¹ References to this and other standards apply to the most current version of those standards.

- 3.1.2 The maximum flow rate shall be the highest value obtained through testing at flowing pressures of 20, 45, and 80 ± 1 pounds per square inch (psi) ($140, 310, \text{ and } 550 \pm 7$ kilopascal [kPa]), when evaluated in accordance with 10 CFR 430 Subpart F, Appendix B, Step 6(b). This maximum flow rate shall not exceed the maximum flow rate value specified in Section 3.1.1.
- 3.1.3 The minimum flow rate, determined through testing at a flowing pressure of 20 ± 1 psi (140 ± 7 kPa) and when evaluated in accordance with 10 CFR 430 Subpart F, Appendix B, Step 6(a), shall not be less than 60 percent of the maximum flow rate value specified in Section 3.1.1.
- 3.1.4 The minimum flow rate shall be the lowest value obtained through testing at flowing pressures of 45 and 80 ± 1 psi ($310 \text{ and } 550 \pm 7$ kPa), when evaluated in accordance with 10 CFR 430 Subpart F, Appendix B, Step 6(a). This minimum flow rate shall not be less than 75 percent of the maximum flow rate value specified in Section 3.1.1.

4.0 Spray Force Criteria

- 4.1 The spray force of the showerhead shall be tested in accordance with the procedures outlined in Appendix A and shall meet the following criteria:
 - 4.1.1 The minimum spray force shall not be less than 2.0 ounces (0.56 newtons [N]) at a pressure of 20 ± 1 psi (140 ± 7 kPa) at the inlet when water is flowing.

5.0 Spray Coverage Criteria

- 5.1 The spray coverage of the showerhead shall be tested in accordance with the procedures outlined in Appendix B and shall meet the following criteria:
 - 5.1.1 The total combined maximum volume of water collected in the 2- and 4-inch [in.] (50-, 101-millimeter [mm]) annular rings shall not exceed 75 percent of the total volume of water collected, and;
 - 5.1.2 The total combined minimum volume of water collected in the 2-, 4-, and 6-in. (50-, 101-, 152-mm) annular rings shall not be less than 25 percent of the total volume of water collected.

6.0 Marking

In addition to the marking requirements in ASME A112.18.1/CSA B125.1, the following markings shall apply:

- 6.1 The product shall be marked with the maximum flow rate value in gpm and L/min as specified by the manufacturer, verified through testing and in compliance with this specification.
- 6.2 The product packaging shall be marked with the maximum flow rate value in gpm and L/min as specified by the manufacturer, verified through testing and in compliance with this specification.
- 6.3 The product packaging shall be marked with the minimum flow rate value in gpm and L/min at 45 psi, calculated in Section 3.1.4 as 75 percent of the manufacturer's specified maximum flow rate value, verified through testing and in compliance with this specification.
- 6.4 Flow rate marking shall be in gpm and L/min in two or three digit resolutions (e.g., 2.0 gpm [7.6 L/min]).

7.0 Effective Date

This specification is effective on February 9, 2010.

8.0 Future Specification Revisions

EPA reserves the right to revise this specification should technological and/or market changes affect its usefulness to consumers, industry, or the environment. Revisions to the specification would be made following discussions with industry partners and other interested stakeholders.

9.0 Definitions

Definitions within ASME A112.18.1/CSA B125.1 are included by reference

ASME – American Society of Mechanical Engineers

ASME PTC – American Society of Mechanical Engineers Performance Test Codes

ANSI – American National Standards Institute

CFR – Code of Federal Regulations

CSA – Canadian Standards Association

ISA – International Society of Automation

WaterSense® Specification for Showerheads Supporting Statement

I. Introduction

Showering is one of the leading uses of water inside the home, representing approximately 17 percent of annual residential indoor water use in the United States. This translates into more than 1.2 trillion gallons of water consumed each year^{1, 2}. The WaterSense program released its final specification for showerheads on March 4, 2010, to capitalize on this opportunity to further improve the nation's water and energy efficiency by raising consumer awareness and promoting the use of more efficient showerheads. The intent of this specification is to help consumers identify those products that have met EPA's criteria for water efficiency and performance.

WaterSense collaborated with the American Society of Mechanical Engineers (ASME)/Canadian Standards Association (CSA) Joint Harmonization Task Force to develop the specification criteria for high-efficiency showerheads. This task force is open to the public and comprises a wide variety of stakeholders, including showerhead manufacturers, water and energy utilities, testing laboratories, consultants, and other water-efficiency and conservation specialists. Their participation, resources, and expertise enabled WaterSense to evaluate showerhead efficiency and performance and develop meaningful testing protocols that can effectively differentiate showerhead performance.

Prior to the task force's work there were no universally accepted criteria for measuring showerhead performance. Federal water-efficiency legislation and national performance standards only establish product flow rates that dictate water consumption—they do not address what makes a satisfactory, or unsatisfactory, shower. Now, with this specification, WaterSense and the task force have bridged this consumer information gap by incorporating performance requirements for products seeking to earn the WaterSense label. The requirements address flow rates across a range of pressures, spray force, and spray coverage, three key attributes of showerhead performance, according to consumer testing. These new requirements are designed to ensure a high level of performance and user satisfaction with high-efficiency showerheads.

II. Current Status of Showerheads

With nearly 110 million occupied housing units in the United States³ and an average of two showerheads per household⁴, WaterSense estimates that there are 220 million showerheads

¹ Assumes a per capita shower use of 11.6 gallons. See Mayer, Peter W. and William B. DeOreo. *Residential End Uses of Water*. Aquacraft, Inc. Water Engineering and Management. American Water Works Association. 1998. Page 102.

² According to the U.S. Census Bureau, there are 300 million persons in the United States.

³ See U.S. Census Bureau and the U.S. Department of Housing and Urban Development's *American Housing Survey for the United States*. 2007.

⁴ Mayer and DeOreo, op. cit., 99.

currently installed in homes across the United States. WaterSense also estimates that approximately 10 percent of the existing 220 million showerheads are replaced each year due to wear, remodeling, or other reasons. This means that the vast majority of these existing showerheads have flow rates equal to or less than the federal standard of 2.5 gallons per minute (gpm), which was mandated by the Energy Policy Act (EPAct) of 1992. With normal replacements and units sold for new construction, WaterSense estimates that approximately 25.6 million⁵ new showerheads are sold each year. Since Congress enacted the federal requirements in the early 1990s, manufacturers have gone on to develop showerheads that use significantly less water than the flow rates set in EPAct 1992. These high-efficiency showerheads can save at least 20 percent compared to standard fixtures, resulting in a potential savings of more than 1,200 gallons per showerhead per year.

III. WaterSense Specification for Showerheads

Scope

This specification applies to showerheads and hand-held showers. Showerheads are fixed devices for directing water onto a user for bathing purposes. Hand-held showers, a subset of showerheads, are moveable devices for directing water onto a user. Hand-held showers can be installed on a support to function as a showerhead.

Multiple showerheads are eligible to receive the WaterSense label provided the showerheads are sold in combination in a single device intended to be connected to a single shower outlet. Further, each showerhead must meet all of the requirements of the specification and the entire multiple-head system must meet the maximum flow rate requirement of the specification in all possible operating modes.

Body sprays are excluded from this specification because their function and design are wholly different than that of a showerhead or hand-held shower. Retrofit devices, including aftermarket flow control devices, are also excluded because the intent of the specification is to recognize and label complete, fully functioning fixtures or fittings, and not individual components.

General Requirements

Many showerheads are sold with multiple modes to provide the user with options for different spray types (e.g., misting, massaging, or pause). WaterSense wants to maintain manufacturing flexibility and consumer choice for multiple mode showerheads, thus the specification addresses these types of showerheads by requiring all modes to meet the maximum flow rate requirement (i.e., no mode can exceed 2.0 gallons per minute [gpm]) and at least one of the modes, as specified by the manufacturer, must meet all of the requirements contained in the specification, including the maximum and minimum flow rates, spray force, and spray coverage requirements.

Water-Efficiency Criteria

⁵ Units sold for replacement is based upon a 10 percent natural replacement rate. Units sold for new construction is based on 1,797,000 new housing starts per year based on the average number of new housing starts from 2003–2007 from U.S. Census. 2007 American Housing Survey, Table 1A-1. www.census.gov/prod/2008pubs/h150-07.pdf.

The water-efficiency component of this specification establishes a maximum flow rate of 2.0 gpm (7.6 liter per minute [L/min]). WaterSense settled on this flow rate after examining the range of products currently available on the market. This maximum flow rate represents a 20 percent reduction from the current federally allowable maximum flow rate of 2.5 gpm established by EPA Act 1992, which is consistent with WaterSense’s stated water-efficiency goal.

The specification also includes minimum flow rate requirements at 80, 45, and 20 pounds per square inch (psi) of pressure (the upper, mid, and lower range of potential household pressures) to ensure performance and user satisfaction under a variety of household conditions. Specifically, at 45 and 80 psi the tested flow rate cannot be less than 75 percent of the showerhead’s maximum “rated”⁶ flow rate value. This minimum requirement is specified at both 45 and 80 psi because some showerheads that are designed to compensate and adjust for changes in water pressure will actually produce maximum flow at 45 psi and not at 80 psi. As a result, WaterSense wants to ensure that this minimum flow rate requirement is met at both pressures. Likewise, at 20 psi the tested flow rate cannot be less than 60 percent of the showerhead’s maximum rated flow rate value. Table 1 below provides some examples of the allowable minimum flow rates for showerheads with various rated flow rates. Defining minimum flow rate requirements in this manner ensures that the showerhead is designed to provide consistent flow across a range of pressures.

Table 1. Example Minimum Flow Rates

Showerhead Rated Flow Rate	Minimum Allowable Flow Rate		
	80 psi	45 psi	20 psi
2.0 gpm	1.5 gpm	1.5 gpm	1.2 gpm
1.75 gpm	1.3 gpm	1.3 gpm	1.1 gpm
1.5 gpm	1.1 gpm	1.1 gpm	0.9 gpm
1.0 gpm	0.8 gpm	0.8 gpm	0.6 gpm

WaterSense is requiring both the maximum and minimum flow rates of the showerhead to meet the testing and verification protocols for sampling outlined in the *Code of Federal Regulations* (see 10 CFR 430 Subpart F, Appendix B, Steps 6[b] and 6[a], respectively). The U.S. Department of Energy currently uses the sampling plan outlined in the CFR for assessing compliance of showerhead flow rates with EPA Act 1992 requirements, and thus referencing it in this specification provides specific and familiar guidance to third-party certifying bodies for determining whether a showerhead meets the flow rate requirements established by WaterSense.

Performance Criteria

Establishing performance-based criteria for WaterSense labeled showerheads is critical to ensuring user satisfaction and maintaining the integrity of the WaterSense label. Prior to this specification, however, there were no universally agreed-upon testing protocols for showerhead performance or measures that adequately defined user satisfaction. WaterSense worked with

⁶ The “rated” flow rate is the showerhead’s maximum flow rate, as specified by the manufacturer, verified through testing, and in compliance with this specification.

the task force to determine, through its expertise and supported by consumer testing, the key performance attributes of showerheads.

To measure those attributes in a laboratory setting, the task force undertook an intensive effort to develop test protocols. The spray force and spray coverage requirements contained in the specification are a result of these efforts. Both test protocols subsequently underwent several iterations of round robin testing in various laboratories by multiple manufacturers and independent third-party certifiers in order to ensure that the procedures are repeatable and the results reproducible. Laboratory test data were then compared back to the consumer test data for a variety of showerheads to determine the specific performance levels that are included in the specification. These performance levels define the boundaries for user satisfaction for both spray force and spray coverage.

The spray force component of the specification requires a showerhead's spray force to be at least 2.0 ounces (0.56 newtons [N]) at an inlet pressure of 20 psi when the water is flowing. The testing procedure, described in Appendix A of the specification, is a pass/fail test that assesses the relative force of the shower spray through the use of a force balance fixture. The force balance fixture is equipped with a force target on one side that receives the shower spray and counterbalancing weights on the other side, set to the specified force (i.e., 2.0 ounces). As the shower spray hits the force target, the force balance fixture measures the rotation angle of the balance at the pivot point of the two sides (the spray and counterbalancing weights).

If the shower spray force is greater than the specified minimum, it will overcome, or move, the counterbalancing weights to or beyond the point of balance, achieved when the angle rotates within 0.1° of zero or past it. Under this scenario the showerhead would pass the force requirements. If the showerhead's force is less than the specified minimum, it will not overcome the counterbalancing weights and the angle of balance will not rotate within 0.1° of zero or past it. Under this scenario, the showerhead would fail the force requirements. The target force of 2.0 ounces specified in the specification represents the lower bounds of user satisfaction based on results from consumer tests using a variety of showerheads.

The spray coverage component of the specification, as described in Appendix B of the specification, requires the use of an annular ring gauge consisting of a series of concentric rings, starting with a 2-inch diameter center ring and each successive ring increasing in diameter by 2 inches out to 20 inches. The showerhead is positioned and turned on directly above the surface of the annular ring gauge. The relative amount of water captured in each set of concentric rings provides a representation of the distribution of the spray pattern and can be used to evaluate the showerhead's spray coverage.

Simultaneous to the development of the test apparatus, WaterSense gathered consumer test data to determine user preferences with respect to spray coverage. Data showed general dissatisfaction with showerheads that spray with a hollow spot in the center or that have too much water flowing in the center to form a very narrow beam. Thus the criteria contained in the specification were crafted to capture and disqualify showerheads with these types of coverage characteristics. Specifically, to meet the spray coverage requirement, the total volume of water collected in the two center rings (out to 4 inches) cannot exceed 75 percent of the total collected water volume (i.e., the showerhead cannot deliver all its water through a narrow beam in the center). In addition, the total combined volume of water collected in the three center rings (out to

6 inches) must be at least 25 percent of the total collected water volume (i.e., the showerhead cannot have a hollow spot in the center).

Marking

With this specification, WaterSense has adopted a new approach to product and package flow rate marking. The requirements are designed to clarify and clearly indicate which maximum flow rate value the manufacturer is to use. At the outset of certification, the manufacturer specifies a maximum flow rate value ("rated" flow rate), not to exceed 2.0 gpm, which is subsequently verified through testing. WaterSense requires the manufacturer to mark the product and product packaging with this rated flow rate value, so that the information provided to the consumer is both informative and accurate.

In addition to marking the product and packaging with the maximum rated flow rate, the product packaging (but not the product itself) must also be marked with the showerhead's minimum flow rate at 45 psi. This minimum flow rate is calculated as 75 percent of the manufacturer's specified maximum flow rate value and is subsequently verified through testing. The purpose of this marking requirement is to assist installers in properly matching showerheads and automatic-compensating mixing valves for installation in order to provide protection against thermal shock and scalding events (see Section V below for more information).

Potential Water and Energy Savings

Note: Refer to Appendix A for the assumptions and calculations used to derive these estimates.

Showerheads with a flow rate of 2.0 gpm or less have the potential to save significant amounts of water both individually and at the national level. Replacing standard showerheads with WaterSense labeled showerheads could save more than 1,200 gallons per showerhead or 2,300 gallons of water per household per year. Based upon the amount of water saved, the average household could save 300 kilowatt hours (kWh) of electricity or 1,500 cubic feet of natural gas that would otherwise be required to heat the water.

Nationwide, if WaterSense labeled showerheads were purchased for all normal showerhead replacements and installed in all new construction, WaterSense estimates that water savings could reach 30.3 billion gallons per year. National energy savings could exceed 1.6 billion kWh of electricity and 10.9 million cubic feet (Mcf) of natural gas each year.

Cost-Effectiveness

Note: Refer to Appendix A for the assumptions and calculations used to derive these estimates.

The average homeowner retrofitting his or her showerheads with WaterSense labeled showerheads will realize an accompanying \$14 savings on water and wastewater costs annually due to lower water consumption. Factoring in the accompanying energy savings, the average household with electric water heating may save an additional \$36, for a combined annual savings of \$50. The average household with natural gas water heating may save an additional \$18 for a combined annual savings of \$32.

If the average showerhead costs \$30 retail, the average payback period for the replacement of two standard showerheads per household with WaterSense labeled models would be approximately 14 months for those with electric water heating and about two years for those heating with natural gas.

IV. Certification and Labeling

WaterSense has established an independent third-party product certification process, described on the WaterSense Web site at www.epa.gov/watersense/partners/certification.html. Under this process, products are certified to conform to applicable WaterSense specifications by accredited third-party licensed certifying bodies. Manufacturers are then authorized to use the WaterSense label in conjunction with certified products.

V. Other Issues

Detailed Drawings for the Force Balance Test Apparatus

As the specification indicates, the spray force performance requirement is measured via a force balance test apparatus. This force balance test apparatus was developed by the task force specifically for the purpose of determining a showerhead's compliance with the specification's force requirements; therefore it is not a readily available or mass-produced piece of testing equipment. In addition, the test apparatus needs to be manufactured with very specific tolerances to ensure the results are repeatable and reproducible in any laboratory setting. WaterSense has made available the specification drawings to facilitate the construction of this test equipment. Detailed drawings for the force balance test apparatus are available on the WaterSense Web site at www.epa.gov/watersense/products/showerheads.html.

Health and Safety

In developing this specification, WaterSense and the task force considered potential negative impacts of reducing the flow rate on consumer satisfaction, including potential health and safety issues once these products are installed in the plumbing system. Of particular concern is the potential for increasing the risk of thermal shock or scalding as shower flow rates are reduced. Thermal shock or scalding can be caused when a hot- or cold-water-using device is activated (e.g., flushing the toilet or running the dishwasher) while the shower is running. Water is diverted away from the shower, causing a pressure drop in either the hot or cold water supply line to the shower. As a consequence, the balance of hot and cold water is shifted either to a hotter or colder temperature mix. This sudden change in temperature can either cause a user to abruptly move away from the shower stream, potentially resulting in an injury or fall, or if the temperature increase is severe enough, scalding can occur.

To mitigate the risks of temperature-related shower injuries, most U.S. plumbing codes require showers to be outfitted with individual automatic-compensating mixing valves that comply with either the American Society of Sanitary Engineers (ASSE) 1016 or ASME A112.18.1/CSA B125.1 standards. An automatic-compensating mixing valve is a device that is installed as part of the shower's flow control that helps to regulate water temperature; it is not part of the showerhead itself. The valve works either through balancing the incoming hot and cold water

pressures or through controlling the mixed outlet temperature with a thermostatic element that can maintain water temperature to within +/- 3.6°F.

Despite advances in plumbing codes and mixing valve technology, thermal shock and scalding risks are still present under two scenarios. First, automatic-compensating mixing valves are currently only required to be tested and certified at a flow rate of 2.5 gpm at 45 psi. When these devices are outfitted with a showerhead that has a lower flow rate, there may not be adequate assurance that the valve is sensitive enough to provide the required protection. This is potentially true for all showerheads, as standard showerheads are currently tested and certified at a flow rate of 2.5 gpm at 80 psi. Second, not all homes are equipped with an automatic-compensating mixing valve. The risks are of particular concern for showerhead retrofits in homes built prior to 1987.

As a part of the development of the criteria for showerheads, WaterSense and the task force evaluated the link between flow rate and temperature deviations associated with pressure and temperature changes. The task force gathered and presented data to compare the temperature profiles that result from a drop in hot and cold water pressure for both standard and high-efficiency showerheads under the two risk scenarios: (1) installation with various types of automatic-compensating mixing valves (thermostatic, pressure balancing, or combination) designed for a flow rate of 2.5 gpm at 45 psi and (2) installation without the protection of an automatic-compensating mixing valve. The data showed that the risks are present for showerheads of all flow rates, but that more efficient showerheads are more sensitive to sudden changes in water pressure. As a consequence, a temperature change in water exiting the shower may be amplified when the pressure within the cold water or hot water supply plumbing suddenly changes.

Ultimately, WaterSense and the task force came to the conclusion that the thermal shock and scalding risks cannot be fully addressed through the specification for showerheads. First, there is a clear disconnect between the showerhead and automatic-compensating mixing valve compatibility, as the products are tested at different pressures (80 psi and 45 psi, respectively) and currently automatic-compensating mixing valves are only tested at a flow rate of 2.5 gpm. Second, the potential temperature of the hot water is controlled by the design of the hot water heater and delivery system, which can discharge water well in excess of the code required 140°F due to "layering" and the location of the thermostat at a point that is not necessarily the location of the hottest water. Because of the interrelated nature of these three components in the plumbing system, the control of the risks cannot solely rest on the design of the showerhead. In fact, the showerhead itself has very little, if any, control over the outlet water temperature.

To the extent possible, WaterSense has addressed this issue in the specification by requiring manufacturers to mark the product packaging with the minimum flow rate at 45 psi as determined by testing at that pressure. This is a vital step toward providing the information necessary to "match" the showerhead with a compatible automatic-compensating mixing valve that is rated to perform at the same flow rate and tested pressure. In addition, industry is currently working to harmonize automatic-compensating mixing valve standards and showerhead standards to address potential incompatibilities of these plumbing system components. This will go a long way toward addressing the risks of thermal shock and scalding associated with the installation of a WaterSense labeled showerhead, indeed with all

showerheads, particularly in new construction. WaterSense is also educating consumers and program partners regarding the issue and associated risks so that consumers can continue to make informed purchasing decisions.

Appendix A: Calculations and Key Assumptions

Potential Water Savings Calculations

Assumptions:

- Average actual flow rate for an existing showerhead is 2.22 gpm⁷ (the average flow rate is less than the standard rated flow rate of 2.5 gpm most likely because the products are rated at 80 psi, but installed in homes with less pressure)
- Average shower duration is 8.2 minutes¹¹
- The average person takes 0.67 showers per day⁸
- A WaterSense labeled showerhead reduces the flow rate by 20 percent
- An estimated 10 percent of existing showerheads are replaced each year due to wear, remodeling, or other reasons
- There are an estimated 1,797,000 new housing starts per year based on the average number of new housing starts from 2003–2007⁹

Equation 1. Annual Water Savings Potential from Replacing a 2.5 gpm Rated Showerhead

$$((2.22 \text{ gpm} - (2.22 \text{ gpm} \times (1-0.2))) \times 8.2 \text{ minutes/shower} \times 0.67 \text{ showers/person/day} \times 2.6 \text{ people/household} \times 365 \text{ days/year}) = 2,300 \text{ gal/household/year}$$

$(2,300 \text{ gal/household/year} / 2 \text{ showerheads/household}) = 1,200 \text{ gal/showerhead/year}$

Equation 2. Annual National Water Savings Potential from Replacing All Existing 2.5 gpm Showerheads

$(1,200 \text{ gal/showerhead/year} \times 220 \text{ million existing showerheads}) = 260 \text{ billion gal/year}$

Equation 3. Annual National Water Savings Potential from Natural Replacement with WaterSense Labeled Showerheads

$(1,200 \text{ gal/showerhead/year} \times 220 \text{ million showerheads} \times 0.10) = 26 \text{ billion gal/year}$

Equation 4. Annual National Water Savings Potential from Installation of WaterSense Labeled Showerheads in New Construction

$(1,200 \text{ gal/showerhead/year} \times 1,797,000 \text{ annual new housing starts} \times 2 \text{ showerheads/household}) = 4.3 \text{ billion gal/year}$

Unit Abbreviations:

gal = gallon

gpm = gallons per minute

psi = pressure per square inch

Potential Energy Savings Calculations

⁷ Mayer and DeOreo, Op. cit., 102.

⁸ Calculated based upon an assumed 17.2 gallons per shower and 11.6 gallons per day for showering. (Ibid.)

⁹ U.S. Census. 2007 American Housing Survey, Table 1A-1. www.census.gov/prod/2008pubs/h150-07.pdf.

Assumptions:

- Approximately 73 percent of showerhead water used in a household is hot water¹⁰
- 42,239,000 (approximately 40 percent) of occupied residences in the United States heat their water using electricity¹¹
- 60,998,000 (approximately 56 percent) of occupied residences in the United States heat their water using natural gas^{11,12}
- Water heating consumes 0.18 kWh of electricity per gallon of water heated assuming:
 - Specific heat of water = 1.0 Btu/lb x ° F
 - 1 gallon of water = 8.34 lbs
 - 1 kWh = 3,412 Btus
 - Incoming water temperature is raised from 55° F to 120° F (Δ 65° F)
 - Water heating process is 90 percent efficient for electric hot water heaters
- Water heating consumes 0.88 Mcf of natural gas per 1,000 gallons of water heated assuming:
 - Specific heat of water = 1.0 Btu/lb x ° F
 - 1 gallon of water = 8.34 lbs
 - 1 Therm = 99,976 Btus
 - Incoming water temperature is raised from 55° F to 120° F (Δ 65° F)
 - Water heating process is 60 percent efficient for natural gas hot water heaters

Electricity

Equation 5. kWh Required to Raise 1 Gallon of Water 65° F

$$[(1.0 \text{ Btu/lbs} \times \text{° F}) (1\text{kWh}/3,412 \text{ Btus}) / (1 \text{ gal}/8.34 \text{ lbs}) \times 65\text{° F}] / 0.90 = 0.18 \text{ kWh/gal}$$

Equation 6. Electricity Saving Potential per Household

$$(2,300 \text{ gal/year} \times 0.73) \times (180 \text{ kWh of electricity}/1,000 \text{ gal}) = 300 \text{ kWh of electricity per year}$$

Equation 7. National Electricity Savings Potential from Replacing All Existing 2.5 gpm Showerheads

$$(260 \text{ billion gal/year} \times 0.73 \times 0.40) \times (180 \text{ kWh of electricity}/1,000 \text{ gal}) = 14 \text{ billion kWh of electricity nationwide}$$

Equation 8. National Electricity Savings Potential from Natural Replacement with WaterSense Labeled Showerheads

$$(26 \text{ billion gal/year} \times 0.73 \times 0.40) \times (180 \text{ kWh of electricity}/1,000 \text{ gal}) = 1.4 \text{ billion kWh of electricity nationwide}$$

Equation 9. National Electricity Savings Potential from Installation of WaterSense Labeled Showerheads in New Construction

¹⁰ DeOreo, William B., and Peter W. Mayer. *The End Uses of Hot Water in Single Family Homes From Flow Trace Analysis*. 2000. Aquacraft, Inc.

¹¹ U.S. Department of Housing and Urban Development and U.S. Census Bureau. *American Housing Survey for the United States: 2007*. 2008. Table 1A-5, page 7.

¹² Ibid.

$(4.3 \text{ billion gal/year} \times 0.73 \times 0.40) \times (180 \text{ kWh of electricity/1,000 gal}) = 230 \text{ million kWh of electricity nationwide}$

Natural Gas

Equation 9. Therms Required to Raise 1 Gallon of Water 65° F
 $[(1.0 \text{ Btu/lbs} \times ^\circ \text{ F}) (1 \text{ Therm/99,976 Btus}) / (1 \text{ gal/8.34 lbs}) \times 65^\circ \text{ F}] / 0.60 = 0.009 \text{ Therms/gal}$

Equation 10. Converting Therms to Mcf
 $0.009 \text{ Therms/gal} \times 1,000 \text{ gal/kgal} \times 1 \text{ Mcf/10.307 Therms} = 0.88 \text{ Mcf/kgal}$

Equation 11. Natural Gas Savings Potential per Household
 $(2,300 \text{ gal/year} \times 0.73) \times (0.88 \text{ Mcf of natural gas/1,000 gal}) = 1.5 \text{ Mcf (1,500 cubic feet) of natural gas per year}$

Equation 12. National Natural Gas Savings Potential from Replacing All 2.5 gpm Showerheads
 $(260 \text{ billion gal} \times 0.73 \times 0.56) \times (0.88 \text{ Mcf of natural gas/1,000 gal}) = 94 \text{ million Mcf of natural gas nationwide}$

Equation 13. National Natural Gas Savings Potential from Natural Replacement with WaterSense Labeled Showerheads
 $(26 \text{ billion gal} \times 0.73 \times 0.56) \times (0.88 \text{ Mcf of natural gas/1,000 gal}) = 9.4 \text{ million Mcf of natural gas nationwide}$

Equation 14. National Natural Gas Savings Potential from Installation of WaterSense Labeled Showerheads in New Construction
 $(4.3 \text{ billion gal/year} \times 0.73 \times 0.56) \times (0.88 \text{ Mcf of natural gas/1,000 gal}) = 1.5 \text{ million Mcf of natural gas nationwide}$

Unit Abbreviations:

Bcf = billion cubic feet
 Btu = British thermal unit
 F = Fahrenheit
 kgal = kilogallons
 kWh = kilowatt hour
 lbs = pounds
 Mcf = thousand cubic feet

Cost-Effectiveness Calculations

Assumptions:

- Price of water and wastewater is \$6.06/1000 gallons¹³
- 2009 Price of electricity is \$0.12/kWh¹⁴
- 2009 Price of natural gas is \$11.98/Mcf¹⁵

¹³ Raftelis Financial Consulting. *Water and Wastewater Rate Survey*. American Water Works Association. 2006.

¹⁴ U.S. Department of Energy, www.eia.doe.gov/cneaf/electricity/epm/table5_3.html.

Equation 15. Annual Household Water and Wastewater Cost Savings
 $2,300 \text{ gallons/year} \times \$6.06/1,000 \text{ gallons} = \$14/\text{year}$

Equation 16. Annual Household Electricity Savings
 $(300 \text{ kWh/household/year} \times \$0.12/\text{kWh}) = \$36/\text{year}$

Equation 17. Annual Household Natural Gas Savings
 $(1.5 \text{ Mcf/household/year} \times \$11.98/\text{Mcf}) = \$18/\text{year}$

Equation 18. Annual Water, Wastewater, and Electricity Savings
 $(\$14/\text{year} + \$36/\text{year}) = \$50/\text{year}$

Equation 19. Annual Water, Wastewater, and Natural Gas Savings
 $(\$14/\text{year} + \$18/\text{year}) = \$32/\text{year}$

Equation 11. Average Full Payback Period (Electric Water Heating)
 $(\$30/\text{showerhead} \times 2 \text{ showerheads/household}) / \$50/\text{year} = 1.2 \text{ years} (\sim 14 \text{ months})$

Equation 12. Average Full Payback Period (Natural Gas Water Heating)
 $(\$30/\text{showerhead} \times 2 \text{ showerheads/household}) / \$32/\text{year} = 1.9 \text{ years} (\sim 23 \text{ months})$

¹⁵ U.S. Department of Energy, www.eia.doe.gov/stec.



WaterSense® Specification for Tank-Type Toilets

Version 1.2

June 2, 2014

WaterSense® Specification for Tank-Type Toilets

1.0 Scope and Objective

This specification establishes the criteria for a tank-type high-efficiency toilet under the U.S. Environmental Protection Agency's (EPA's) WaterSense program. It is applicable to:

- Single-flush, tank-type gravity toilets
- Dual-flush, tank-type gravity toilets
- Dual-flush, tank-type flushometer tank (pressure-assist) toilets
- Tank-type, flushometer tank (pressure-assist) toilets
- Tank-type electrohydraulic toilets
- Any other tank-type technologies that meet these performance specifications

The specification is designed to ensure both sustainable, efficient water use and a high level of user satisfaction with flushing performance.

2.0 General Requirements

- 2.1 The toilet shall conform to applicable water closet requirements in ASME A112.19.2/CSA B45.1,¹ except as otherwise indicated in this specification.
- 2.2 If the toilet has dual-flush capabilities, it shall conform to requirements in ASME A112.19.14.

3.0 Water Efficiency Criteria

- 3.1 Single-flush toilets: The effective flush volume shall not exceed 1.28 gallons (4.8 liters) when evaluated in accordance with the sampling plan contained in 10 CFR 429.30. For single-flush toilets, the effective flush volume is the average flush volume when tested in accordance with ASME A112.19.2/CSA B45.1.
- 3.2 Dual-flush toilets: The effective flush volume shall not exceed 1.28 gallons (4.8 liters) when evaluated in accordance with the sampling plan contained in 10 CFR 429.30. For dual-flush toilets, the effective flush volume is the average flush volume of two reduced flushes and one full flush. Flush volumes shall be tested in accordance with ASME A112.19.2/CSA B45.1 and ASME A112.19.14.
- 3.3 Samples with average flush volume in excess of 0.10 gallon (0.4 liter) greater than their rated flush volume shall be deemed to fail testing requirements due to excessive flush volume.²

¹ References to this and other standards apply to the most current version of that standard.

² For example, fixtures rated at 1.28 gallons per flush (the maximum flush volume) but flushing at greater than 1.38 gallons (5.2 liter) when adjusted in accordance with the water consumption test procedure in ASME A112.19.2/CSA B45.1 shall be deemed to have "failed" the requirements of this specification.

- 3.4 Samples with average flush volumes less than or equal to 0.10 gallon (0.4 liter) greater than their rated flush volume shall be adjusted, if possible, to their rated flush volume prior to performance testing.
- 3.5 Samples with average flush volumes less than their rated flush volume shall be tested at measured volume and this volume shall be recorded on the test report.

4.0 Flush Performance Criteria

- 4.1 Toilet model performance is identified as either a "pass" or "fail" depending upon whether it can successfully and completely clear all test media from the fixture in a single flush in at least four of five attempts. Flush performance testing shall be conducted in accordance with the waste extraction test protocol provided in ASME A112.19.2/CSA B45.1.

5.0 Product Marking

- 5.1 Toilet fixtures shall be marked in accordance with requirements in ASME A112.19.2/CSA B45.1 with the exception identified in Section 5.1.1 below.
 - 5.1.1 Toilet bowls intended to be used with tanks of varying consumption levels (e.g., 1.6 and 1.28 gallons per flush) shall be marked with a dual consumption marking or a consumption range, as indicated in ASME A112.19.2/CSA B45.1; however, toilet bowls shall not be marked with the words "or less" to indicate compatibility with tanks of varying consumption levels.
- 5.2 Toilet tanks shall not be packaged, marked, nor provided with instructions directing the user to an alternative water use setting that would override the rated flush volume, as established by this specification. Any instruction related to the maintenance of the product shall direct the user on how to return the product to its rated flush volume.

6.0 Effective Date

This specification is effective on June 2, 2014.

7.0 Future Specification Revisions

EPA reserves the right to revise this specification should technological and/or market changes affect its usefulness to consumers, industry, or the environment. Revisions to the specification would be made following discussions with industry partners and other interested stakeholders.

8.0 Definitions

Definitions within ASME A112.19.2/CSA B45.1 and ASME A112.19.14 are included by reference.

- **Pressure-assist toilet:** A water closet that uses a flushometer tank as a flushing device, as defined in ASME A112.19.2/CSA B45.1.
- **Rated flush volume:** The maximum flush volume, as specified by the manufacturer, verified through testing and in compliance with this specification.

Appendix A: Requirements for WaterSense Labeling

The following requirements must be met for products to bear the WaterSense label.

1.0 WaterSense Partnership

The manufacturer³ of the product must have a signed partnership agreement in place with EPA.

2.0 Conformity Assessment

Conformance to this specification must be certified by an EPA licensed certifying body accredited for this specification in accordance with the *WaterSense Product Certification System*.

3.0 Clarifications

3.1 Adjustability

Toilet tanks with adjustable water use settings that can be identified and activated by a user or plumbing professional to override the rated flush volume, as established by this specification, do not comply with the intent of this specification or the WaterSense program and do not qualify for use of the WaterSense label.

3.2 Tanks and Bowls Manufactured and Sold by Different Companies

WaterSense requires every combination tank and bowl to be tested and certified for conformance to this specification in order to ensure that the toilet as a whole provides the expected water efficiency and performance. Wall-hung bowls and in-wall carrier systems manufactured and sold by different companies can earn the WaterSense label, provided that the combination unit is tested and certified. However, since these products might not necessarily be sold as a unit, WaterSense has established some additional certification requirements that these products must meet in order to earn the WaterSense label. Both manufacturers must agree to have their products tested and certified together in order for the tank and bowl combination to receive the WaterSense label.

Certification Listing

In order to control the use of the WaterSense label, EPA is requiring each manufacturer (e.g., the tank manufacturer and the bowl manufacturer) to obtain a certification listing with one of EPA's licensed certifying bodies to show that the toilet, formed by the combination tank and bowl, was certified for conformance to the specification. The listings must identify both components, along with the respective manufacturers' names,

³ Manufacturer, as defined in the WaterSense program guidelines, means: "Any organization that produces a product for market that might be eligible to meet WaterSense criteria for efficiency and performance. Manufacturers can also produce 'private label' products that are sold under the brand name of a separate organization, which is treated as a separate partner/application from the original product manufacturer." In the case of private labeling, the private labeling organization that ultimately brands the product for sale must have a signed WaterSense partnership agreement in place with EPA.

brand names, model names, and model numbers by which the products are identified and sold. Separate listings will allow the licensed certifying body to directly authorize each manufacturer to use the WaterSense label on their tanks or bowls. Note that though a certification listing is required for each manufacturer, WaterSense is not requiring the combination toilet to be tested more than once. The licensed certifying body must ensure that the listing information is complete prior to issuing the certification and the WaterSense label to either manufacturer.

As an alternative to separate listings, and at the discretion of the licensed certifying body, the manufacturer of one of the components (e.g., either the tank or bowl manufacturer) can become listed as an additional company under the certification listing of the manufacturer of the corresponding component (e.g., the bowl or tank). However, both components, along with the respective manufacturer's names, brand names, model names, and model numbers by which the products are identified and sold, must be identified under both the certification file owner's listing and the additional company's listing. This will ensure that there is no confusion about which products were certified in combination to earn the WaterSense label.

3.3 *Product Packaging Marking and Labeling*

Though every combination tank and bowl must be tested and certified for conformance to this specification in order to ensure that the toilet as a whole provides the expected water efficiency and performance, in some cases the tank and bowl might be packaged individually and/or sold separately. To ensure that it is clear to the purchaser that a particular combination tank and bowl is labeled, EPA is providing clarification regarding how the packaging must be marked and how the WaterSense label must be used. These marking and labeling requirements apply to tanks and bowls made by the same company and those made by different companies, as is the case for some wall-hung bowls and in-wall carrier systems.

Manufacturers must adhere to the following product packaging marking and labeling requirements for toilet tanks and bowls packaged and sold individually:

- In all cases, the toilet tank and toilet bowl packaging must bear the WaterSense label.
- Toilet bowl packaging must indicate all of the specific brand names, model names, and model numbers, as applicable, of the counterpart tanks it can be used with to form a WaterSense labeled tank-type toilet. For example, the toilet bowl packaging might say:

“This [insert description of bowl] is WaterSense labeled when used with [list brand names, model names, and model numbers, as applicable, of the tank(s) that the bowl can be used with to form a WaterSense labeled tank-type toilet].”

- Product specification sheets or other product documentation for both the toilet tank and bowl must indicate all of the specific brand names, model names, and model numbers, as applicable, of the counterpart products (e.g., the bowl or tank) that the product can be used with to form a WaterSense labeled tank-type toilet.

Note that for toilet tanks and bowls packaged and sold together as a unit, the packaging must bear the WaterSense label.

Summary of Revisions to the WaterSense® Specification for Tank-Type Toilets Version 1.2

The U.S. Environmental Protection Agency's (EPA's) WaterSense program is announcing the release of Version 1.2 of its *WaterSense Specification for Tank-Type Toilets* (specification). The purpose of this document is to summarize the revisions made to the specification, share the reasoning for the changes, and provide a timeline for compliance with the new requirements.

It is important to note that EPA considers the revisions made in Version 1.2 of the specification to be minor in nature. The revisions are meant to provide clarification of the existing requirements and do not materially affect the scope, performance, or efficiency requirements. The revisions also do not affect the status of existing certified, WaterSense labeled tank-type toilets.

Background

WaterSense released its initial *Tank-Type High-Efficiency Toilet Specification* in January 2007 and issued the first revision to the specification in May 2011. Since that time, the American Society of Mechanical Engineers (ASME) and Canadian Standards Association (CSA) have revised ASME A112.19.2/CSA B45.1 *Ceramic Plumbing Fixtures* to include the waste media extraction test, fill valve integrity test, and tank trim adjustability test protocols established in the *WaterSense Specification for Tank-Type Toilets*. To align with the revised ASME A112.19.2/CSA B45.1 standard, to the extent possible, WaterSense is issuing Version 1.2 of the specification. The changes to the specification, described in this document, will ensure consistency and reduce redundancy in toilet testing for manufacturers seeking the WaterSense label. WaterSense has also taken this opportunity to make some additional minor revisions to the specification to align it with the other WaterSense product specifications. All of the revisions contained in Version 1.2 will ensure that tank-type toilets receiving the WaterSense label are certified and labeled consistently, in accordance with EPA's intent, and will continue to meet consumer expectations for efficiency and performance.

Section 2.0 General Requirements

EPA has revised the title of the section from "Summary of Criteria" to "General Requirements." This change does not affect the specification's original scope of objective, but rather aligns the organization of the specification with other WaterSense product specifications.

Similarly, to align with other WaterSense product specifications, EPA has revised the content of Section 2.0 to provide the general and overarching requirements that products must meet to earn the WaterSense label, rather than a summary of the specification requirements. This section now indicates that all tank-type toilets shall conform to the applicable water closet requirements in ASME A112.19.2/CSA B45.1, and all dual-flush tank-type toilets must conform to applicable requirements within ASME A112.19.14 *Six-Liter Water Closets Equipped With a*

Dual Flushing Device. This change now more fully and clearly aligns the specification with the requirements of the guiding national standards for tank-type toilets.

Section 3.0 Water Efficiency Criteria

Flush Volume Measurement Requirements

The majority of the fixture performance testing protocol, originally provided in Appendix A of the specification, is included in the recent revisions to the ASME A112.19.2/CSA B45.1 standard. The fixture performance testing protocol is now incorporated by reference in Section 2.0 of the specification. However, the ASME/CSA standard does not address the average flush volume limits that dictate whether a toilet is deemed to pass or fail the flush volume test or whether the flush volume should be adjusted to complete the test. As a result, WaterSense has retained these requirements in the specification. As discussed below, Appendix A was removed from the specification because a majority of the requirements are now redundant with the A112.19.2/CSA B45.1 standard; therefore, WaterSense moved these flush volume limit requirements to *Section 3.0 Water Efficiency Criteria*. This change does not affect the specification's original requirements or intent.

Section 4.0 Flush Performance Criteria

Testing Protocol Reference

In Version 1.1 of the specification, the fixture performance testing protocol was identified in Appendix A. Since the protocol is now included in the recent revisions to the ASME A112.19.2/CSA B45.1 standard, WaterSense has updated *Section 4.0 Flush Performance Criteria* to reference compliance with the standard rather than Appendix A (Appendix A has been subsequently deleted). In addition, under Version 1.1, this section summarized the test media requirements. It also stipulated that the protocol was only applicable to single-flush toilets and to the full flush option of dual-flush toilets. These requirements are also covered in the referenced standards and, therefore, WaterSense removed them from this section to minimize redundancy.

In addition, in the development of the revised ASME A112.19.2/CSA B45.1 standard, there was consensus that the casing used for the test media did not materially affect the results of the test. Either cased or uncased media were deemed acceptable for performance testing. In view of this decision and because of the desire for the WaterSense specification to be consistent with the standard, EPA has determined that performance testing using cased or uncased media is acceptable under this specification. This allowance is included by reference to the standard.

Section 5.0 Supplementary Requirements for Flush Volume Adjustability (Version 1.1)

Section Removal

In Version 1.1 of the specification, *Section 5.0 Supplementary Requirements for Flush Volume Adjustability* included testing protocols intended to limit the flush volume adjustability of certified tank-type toilets. These testing protocols included the fill valve integrity test protocol (Appendix B of Version 1.1 of the specification) and the tank trim adjustability testing protocol (Appendix C of Version 1.1 of the specification). These testing protocols were adopted by the ASME A112.19.2/CSA B45.1 standard, which is now incorporated by reference in Section 2.0 of the specification. Therefore, WaterSense removed these requirements from the specification to minimize redundancy. This change does not affect the specification's original requirements or intent.

Section 5.0 Product Marking

Tank Marking Requirements

Toilet tank marking requirements identified in ASME A112.19.5 *Flush valves and spuds for water closets, urinals, and tanks* (referenced in Version 1.1 of the specification) require manufacturers to permanently mark or label the tank with information pertaining to the appropriate flush valve replacement parts. These requirements have subsequently been incorporated into ASME A112.19.2/CSA B45.1. Therefore, WaterSense updated the specification to reference compliance with the toilet fixture marking requirements identified in the ASME A112.19.2/CSA B45.1 standard.

Bowl Marking

Version 1.1 of the specification allowed toilet bowls to be marked in a manner that indicated compatibility with flush volumes below 1.6 gallons per flush (gpf). This requirement was intended to alleviate confusion because many manufacturers were marking their toilet bowls with a 1.6 gpf flush volume despite compatibility and certification with tanks that flush at lower volumes (e.g., 1.28 gpf). The revisions to ASME A112.19.2/CSA B45.1 now include provisions clarifying the marking requirements for bowls that are compatible with lower (or varying) flush volumes. Specifically, the standard allows toilet bowls to be marked using the words "or less," a dual consumption marking, or a consumption range.

WaterSense is incorporating by reference the bowl marking requirements from the ASME/CSA standard, which will provide clarity on the appropriate ways to mark bowls that are compatible with a range of flush volumes. However, WaterSense is taking exception to the allowance for the use of the words "or less." Placing a marking on the bowl that identifies a maximum flush volume along with the words "or less" could imply that the bowl is compatible with tanks of any flush volume, potentially below the minimum the flush volumes with which the bowl was certified to perform.

Section 8.0 Definitions

Referenced Standards

WaterSense has removed the reference to ASME A112.19.5, as the marking requirements have been incorporated into ASME A112.19.2/CSA B45.1.

Definitions

WaterSense has removed the definition of an electrohydraulic toilet because it is incorporated by reference in ASME A112.19.2/CSA B45.1.

WaterSense has revised the definition of a pressure-assist toilet to use language consistent with definitions included in ASME A112.19.2/CSA B45.1.

WaterSense has revised the definition of rated flush volume to be consistent with the definition included in other WaterSense product specifications. The new definition clarifies that the rated flush volume is specified by the manufacturer and verified through testing to ensure compliance with the specification.

Appendix A: Fixture Performance Testing Protocol (Version 1.1)

Section Removal

As mentioned previously, a majority of the fixture performance testing protocol, originally provided in Appendix A of Version 1.1 of the specification, is now incorporated by reference in the ASME A112.19.2/CSA B45.1 standard. One exception is the flush volume measurement limits that dictate whether the toilet passes, fails, or should be readjusted for testing. To reduce redundancy with the standard, WaterSense has subsequently moved these requirements to Section 3.0 and has removed the entirety of Appendix A from the specification. This change does not affect the specification's original requirements or intent.

Appendix B: Fill Valve Integrity Test Protocol (Version 1.1)

Section Removal

As mentioned previously, the fill valve integrity test protocol, originally provided in Appendix B of Version 1.1 of the specification, is now incorporated by reference in the ASME A112.19.2/CSA B45.1 standard. To reduce redundancy with the standard, WaterSense has subsequently removed the entirety of Appendix B from the specification. This change does not affect the specification's original requirements or intent.

Appendix C: Tank Trim Adjustability Testing Protocol (Version 1.1)

Section Removal

As mentioned previously, the tank trim adjustability testing protocol, originally provided in Appendix C of Version 1.1 of the specification, is now incorporated by reference in the ASME A112.19.2/CSA B45.1 standard. To reduce redundancy with the standard, WaterSense has

subsequently removed the entirety of Appendix C from the specification. This change does not affect the specification's original requirements or intent.

Appendix A: Requirements for WaterSense Labeling

Section 3.3 Product Packaging Marking and Labeling

Section 3.3 of Appendix A provides additional product packaging marking and labeling requirements for toilet tanks and bowls that are packaged and sold individually. Version 1.1 prohibited the WaterSense label on toilet bowl packaging that indicated compatibility with flush volumes greater than the rated flush volume identified in this specification. WaterSense developed that requirement to prevent confusion about whether a bowl with an advertised flush volume higher than the maximum allowed by the specification was actually labeled.

The new bowl marking requirements identified in ASME A112.19.2/CSA B45.1, and now incorporated by reference in the specification, should eliminate this confusion as toilet bowls can be marked with a dual consumption marking or a consumption range to indicate compatibility with multiple flush volumes. Therefore, EPA is now requiring the toilet tank and bowl packaging, in all cases, to bear the WaterSense label.

Timeline for Compliance with Version 1.2 of the Specification

Version 1.2 of this specification goes into effect June 2, 2014. EPA is providing manufacturers with a six-month grace period to begin complying with the new requirements. By December 2, 2014 all certification activities must be completed in accordance with Version 1.2 of this specification, in order for tank-type toilets to earn the WaterSense label. The existing licensing agreements between EPA and the licensed certifying body will remain in full force and effect.

Clothes Washer

Terms of Use

Water Calculator

Water Conservation
Tips

Indoor Water Use

Toilets

Clothes Washer

Showers

Faucet

Dishwasher

Leaks

DIY - Installation

How to Read Your
Water Meter

Landscape & Irrigation

Water & Energy

About Us



Crisp, Clean Clothes Without the Waste

Washing laundry is a significant use of water in the average home, accounting for 15% to 40% of the overall water consumption inside the typical household of four persons. The average American family washes almost 400 loads of laundry each year.

Water Factor

Because washers come in various sizes and capacity, the water efficiency of clothes washers is rated using the term "Water Factor" to accurately compare water use. Water Factor (WF) is measured by the quantity of water (gallons) used to wash each cubic foot of laundry.

Older Washers

An old school washer will use approximately 40 to 45 gallons (151.4 L to 170.3 L) of water per load and have a water factor of 10 or higher. A family of four using a standard clothes washer will generate more than 300 loads per year, consuming 12,000 gallons (45.4 m³) of water annually.

High Efficiency Washers

New, High-Efficiency Washers (HEW) (front loading or top loading machines are available) can use 14 to 25 gallons (53 L to 94.6 L) of water per load and will have a water factor of 8 or less. Replacing an old and inefficient clothes washer can reduce this water use by more than 6,000 gallons per year (22.7 m³), save energy, clean the clothes better, and reduce fabric wear.

Clothes Washer Water Saving Tips

1. Run full loads only, even if the washer has an adjustable load setting. A full load is the most efficient way to wash clothes.
2. Replace the old inefficient clothes washer with a new high-efficiency model to save water and energy.

More Information About Clothes Washers

Standard Washers

The standard top loading clothes washer, using a vertical-axis drum, has changed little from General Electric's design in 1947. The vertical axis design requires enough water in the drum to suspend the fabric in the soapy water while the agitator churns the clothes to help remove dirt and stains. The large amount of water required to suspend the fabric in the tub limits the ability for this type of washer to efficiently use water. Historically, vertical axis washers consumed 45 gallons per load (170 L), though newer models of the past few years have reduced this to less than 40 gallons per load (151.4 L). Even the best designs manufactured today require more than 9 gallons (34.1 L) of water per cubic foot of capacity (28.31 L).



High-Efficiency Washers

High-efficiency front or top loading washers facilitate greater efficiency because they use less water and energy. These high-tech machines are proven to be more effective in cleaning the clothes with less water, and is gentler on the fabric when compared to old-school vertical axis washers. Additional benefits of lower water use are: a) less laundry detergent is required; and, b) less water needs to be heated resulting in energy conservation. Most high-efficiency washers use only 15 to 30 gallons (56.8 to 113.6 L) of water to wash the same amount of clothes as older washers (29 to 45 gallons per load (109.7 to 170 L)). The most efficient washers use less than 5 gallons (18.9 L) per cubic foot of capacity.



Water Efficiency of Washers

The smaller the water factor rating, the more water efficient the clothes washer. A typical residential clothes washer has a capacity of approximately 3 cubic foot, though sizes range from 1.7 cubic feet (48.13 L) to more than 4.2 cubic feet (118.9 L) for the extra large capacity machines. The Water Factor provides a means to directly compare water efficiency of different sized machines.

Efficiency Example

Washer A uses 32 gallons of water per load (wash and rinse cycles) with a 4 cubic foot capacity of laundry; thus, has a Water Factor rating of 8 ($32 \div 4 = 8$).

Washer B uses 30 gallons of water (wash and rinse cycles) with a 2.5 cubic foot capacity; thus, has a Water Factor rating of 12 ($30 \div 2.5 = 12$).

Washer A uses water more efficiently ($WF=8$) than Washer B ($WF=12$). While Washer A uses slightly more water per load, it can clean 40% more clothes per load.

Looking for a New Water Efficient Washer?

When buying a new machine, finding the Water Factor rating of a clothes washer is not always easy. Though manufacturers measure Water Factors for each model of washer, manufacturers are not required to display the rating on the machine. Fortunately, the Energy Star Program reports **Water Factors and energy use for nearly every HEW in the market.**

Listing of High Efficiency Clothes Washers

Are you in the market for a new clothes washer? The most recent listings of high-efficiency clothes washers are provided here:

- [CEE Residential Clothes Washers Qualifying Product List](#)

CLOTHES WASHERS

[For Partners](#)

OVERVIEW

SPECIFICATION

BUYING GUIDANCE

PROMOTIONS

The average American family washes about 300 loads of laundry each year. ENERGY STAR can help families cut their related energy and water costs. ENERGY STAR certified clothes washers use about 25% less energy and 33% less water than regular washers. Over the lifetime of the product, models that have earned the ENERGY STAR can save \$380 in energy costs.

They have a greater tub capacity which means you can wash fewer loads to clean the same amount of laundry. They are available in front-load and top-load models from brands including Blomberg, Asko, GE, Kenmore, LG, Samsung, Whirlpool, and many more. ENERGY STAR top-load models utilize new technologies that do not require the tub to fill with water. They clean using sophisticated wash systems to flip or spin clothes through a stream of water. Many have sensors to monitor incoming water levels and temperature. They also rinse clothes with repeated high-pressure spraying instead of soaking them in a full tub of water.

Consider the following:

- **Use less energy.** On average, a new ENERGY STAR certified clothes washer uses 316 kWh of electricity and can save you about \$35 a year on your utility bills compared to a standard model.
- **Use less water.** A full-sized ENERGY STAR certified clothes washer uses 14 gallons of water per load, compared to the 20 gallons used by a standard machine. That's a savings of more than 2,000 gallons of water, per year!!
- **Is your washer over 10 years old?** It's estimated that there are 74 million top-loading washers and 24 million front-loading washers - 26 million of which are at least 10 years old, still in use across the country. Washers that are approximately 10 years old are significantly less efficient than newer models. Together, these inefficient washers cost consumers about \$4.7 billion each year in energy and water. If you have a standard clothes washer that is approximately 10 years old, it's costing you, on average \$185 a year.

If every clothes washer purchased in the U.S. was ENERGY STAR certified, we could save more than \$3.3 billion each year and prevent more than 19 billion pounds of annual greenhouse gas emissions, equal to the emissions from more than 1.8 million vehicles.



5. Technical Advisory Council Report for Wastewater Flows from
Single Family Dwellings.



Executive Summary Wastewater Flows from Single Family Dwellings

Study done for the Michigan Technical Advisory Council for Onsite Wastewater Treatment

Danielle N. McEachin and Ted L. Loudon
Student Intern and Professor, respectively,
Agricultural Engineering Department
Michigan State University

The purpose of this study was to collect, organize and present what is known about the amount of wastewater that can be expected to flow from dwellings. The goal is to provide designers and regulators with an actual flow based data set from which to develop design flow numbers for sizing systems. The data in this document comes from a variety of sources. Most were found on the Internet, some were found in the library, and others were provided from file data collected by entities in Michigan. The study was restricted to data collected during the years 1980-2000, so that the values determined would be representative of life styles of the present generation. In fact, only two numbers in the data tables are from before 1987.

A group of studies providing metered home water use rates presented in units of gpd per capita from around the country were reviewed and summarized. When averages were weighted based on the number of homes per study, the overall weighted average per capita daily water use was just under 51 gpd (Table 1). The value of this data is limited by the fact that much of the data was total use, including outdoor water use, and had to have a correction factor applied. Numerous sources containing recommended per capita design flows were reviewed. Most recommendations are in the 50-70 gpd/c range (Table 4).

Perhaps the most valuable data is data gathered in Michigan. A study of metered data from 700 homes in southern Michigan showed an average daily use per home of 214.3 gallons. The three bedroom home average was 221.3 gpd (74 gpd/br) and the four bedroom average was 285.5 gpd (71 gpd/br). A study of measured flows from 66 homes in Jackson County showed flows of 56 gpd per bedroom.

Average per person flows, averaged over large numbers of people, appear to be in the 50-55 gpd/c range. Average flows expressed per bedroom, for 3-4 bedroom homes appear to be in the 70-75 gpd/br range. While bedrooms do not generate flow, people do, it is common to design on the basis of number of bedrooms since occupancy varies. For large clusters of homes, designing on the basis of 75 gpd/br would appear to be supported by the data available. For an individual home design, a significant safety or peaking factor must be applied. Many of the references consulted suggest a factor of 2 or even 2.5. Use of a high design flow for individual homes helps to compensate for the state of the art in site evaluation and the occasional high water use occupancy.

The Technical Advisory Council will produce a companion guidance document providing recommendations for applying this data in design recommendations.

Wastewater Flows from Single Family Dwellings

Study done for the Michigan Technical Advisory Council for Onsite Wastewater Treatment

Danielle N. McEachin and Ted L. Loudon
Student Intern and Professor, respectively,
Agricultural Engineering Department
Michigan State University

Purpose: Rational design of wastewater treatment and dispersal systems is based on the flow that the system must be able to handle. This is usually expressed on a daily flow basis and typically includes a factor of safety which is large for individual home systems and may be reduced as systems are clustered together. The purpose of this study was to collect, organize and present what is known about the amount of wastewater that can be expected to flow from dwellings. The goal is to provide designers and regulators with an actual flow based data set from which to develop design flow numbers for sizing systems.

The data in this document comes from a variety of sources. Most were found on the Internet, some were found in the library, and others were provided from file data collected by entities in Michigan. Every effort was made to ensure that the data reflect indoor water use, which eliminates most consumptive uses and represents the flow that would be expected in the wastewater system. Because consumptive uses are hard to eliminate completely, particularly in arid climates, we restricted our data to the more humid states. One exception is that a study from Denver, CO is included in which a significant effort was made to eliminate outdoor consumptive uses in the design of the study. The numbers in the Colorado study are higher than those from more humid states but we cannot determine exactly what the reason for this might be. Wherever total water use numbers were encountered they were multiplied by a factor of 0.70 to give indoor water use only. These values are indicated by a *. This factor is based on the findings of multiple studies which measured both indoor and outdoor usage. We restricted our selection of data to include only data collected during the years 1980-2000, so that the values determined would be representative of life styles of the present generation. In fact, only two numbers in the data tables are from before 1987, and these are from a study deemed to be sufficiently reliable that we did not wish to exclude it.

The data are divided into four tables. Table 1 contains data from literature and internal sources that were obtained through actual measurement. This means that the numbers were derived from meter readings at occupied residences. These numbers are from studies where multiple homes were metered and the indoor water use was determined. Only some of these studies reported indoor water use only. For those where the reported values were total use, the 0.70 factor was used to obtain indoor water use numbers. See footnotes following the tabulated data for the basis of this factor. The study done by the American

Water Works Association Research Foundation metered 1188 homes to obtain their data. The Denver Board of Water Commissioners metered 5649 homes in the city and county of Denver.

The U.S. Department of Housing and Urban Development has conducted many studies on residential water use. In some of their work, they designed studies to obtain as diverse a group of homes as possible by gathering data on each household through issuing a questionnaire to each resident. Their study entitled "Water Saved by Low-flow Fixtures" included water meter data from over 200 homes. They also conducted a study of flow from apartment buildings in which they collected data from 23 buildings. The apartments were noted to be especially leaky and they found unusually high per capita water use. The U.S. Geological Survey published a table with water use values for every state. We selected data from the more humid states and applied the 0.70 factor to obtain indoor water use values. Data were collected from homes where the water supply was from both self-supplied (SS) and public-supplied (PS) sources.

Table 2 contains data that was found through actual measurement but is presented as gallons per day per home. The Michigan study done by Equinox Inc. for use in the design of the Mill Valley Condominium Subdivision metered over 700 homes in Livingston and Oakland counties and determined average water use per dwelling. The first 7 entries in Table 2 represent flows averaged over multiple single family dwellings and would be representative of flows to be expected from a cluster of homes. The average flow equals 159 GPD/home over 640 homes. The Michigan Department of Environmental Quality study involved determination of metered flows from over 500 homes in Oakland County and Highland Township. Both of these Michigan studies are believed to be highly reliable but resulted in per home flows that were higher.

Table 3 contains data found through actual measurement but the values were presented in the original studies in units of gallons per day per bedroom. This data is from a study done by the Michigan Department of Environmental Quality. In this study, 66 homes were metered in Jackson County and the size of home determined so that the data could be presented in terms of a per bedroom water use average.

Table 4 contains data from publications which give representative numbers that are recommended for design of wastewater systems. These are not well referenced so it is unclear whether they originally came from actual use studies or are estimates, possibly including a safety factor, that are simply repeated from another publication. These sources were mostly found on the Internet.

After the tables are a set of statements and observations gleaned from literature. The effect of income level and household size on water use is analyzed. Our reasons for using the 0.70 factor are given, a comparison of self-supplied and public-supplied water use is given. Typical times of peak water use are analyzed as are the effects of metering and water pressure.

Conclusions that can be drawn:

From Table 1, the per capita metered indoor water use data from nationwide studies show an average value of 69 gallons per person per day. The per capita data obtained by applying the 0.70 factor to total water use data found in humid climates shows an average value of 55.2 gallons per day, with a self-supplied average of 50.5, a public-supplied average of 57.7 and a range of 35-86.8. The weighted average per capita water use data for all homes in Table 1 show an overall average use of 50.7 gallons per day, with a self-supplied use of 51.1 and a public-supplied use of 50.47.

The per home metered indoor data in Table 2 shows an average of 214.3, with a 3 bedroom average of 221.3, a 4 bedroom average of 285.5 and a range of 140-327. The first 7 entries in Table 2 represents measured flow data from 640 Michigan homes and shows an average of 159 GPD/home.

The nationwide data sets show somewhat higher per capita water use. Humid region data suggest that average per capita indoor water use averages between 50 and 70 gpd. Total water use per home averages between 160 and 285 GPD with the larger figure for larger homes.

This should be considered a work in progress. We would like to include additional data. If the reader has or is aware of additional data that could be included, we would like to receive it. This summary will be modified if additional data are received or otherwise located.

Residential Water Consumption Data, From a Variety of Sources

Report by: Danielle McEachin

Table 1: Sources whose data was found by actual measurement, measured in GPD/Person

Sponsor	Source	Study	Area of Study	Time Period	Indoor use or Total use?	Type of Dwelling	Per capita daily water use
AWWA Research Foundation	http://www.awwarf.com/exsums/90781.htm	Residential End Uses of Water [Project#241]	12 study sites, across the U.S.	Copyright 1999	Indoor	1,188 Single-family homes	69.3, Including Leakage
Denver Board of Water Commissioners	Litke and Kauffman, "Analysis of Residential Use of Water in the Denver Metropolitan Area, CO, 1980-87"		16 groups of homes in the city and county of Denver	Data From 1980-87	Indoor	5,649 Single-family homes	64-119 Mean = 85.6
Rhode Island Governor's Office of Housing, Energy, and Intergovernmental Relations	M. A. Horn, P.A. Craft & Lisa Bratton, "Estimation of Water Withdrawal and Distribution, Water Use, and Wastewater Collection and Return Flow in Cumberland, Rhode Island, 1988"		Cumberland, Rhode Island	Data From 1988	Indoor and Total	Single-family homes	70 SS (Total) 77 PS (Indoor) & 90 PS (Total)
U.S. Department of Housing and Urban Development, Office	Brown and Caldwell, "Residential Water Conservation Projects, Summary Report", 1984	Water Saved by Low-flow Fixtures	Nationwide	Data from 1983	Indoor	200 Single-family homes	66.2

of Policy Development and Research		Retrofit of Apartment Buildings	Washington, D. C.	Data From 1981	Indoor	23 Apartment buildings	100** Including Leakage
------------------------------------	--	---------------------------------	-------------------	----------------	--------	------------------------	-------------------------

Table 1. (cont.)

Sponsor	Source	Study	Area of Study	Time Period	Indoor use or Total use?	Type of Dwelling	Per capita daily water use
United States Geological Survey	http://water.usgs.gov/watuse/tables/dotab.st.html	Table 12. Domestic Freshwater Use by State (States chosen with humidity similar to that of Michigan)	Alabama	Data From 1990	Indoor	Single-family homes	52.5* SS 70* PS
			Arkansas	Data From 1990	Indoor	Single-family homes	61.6* SS 74.2* PS
			Connecticut	Data From 1990	Indoor	Single-family homes	52.5* SS 49* PS
			Delaware	Data From 1990	Indoor	Single-family homes	55.3* SS 54.6* PS
			Georgia	Data From 1990	Indoor	Single-family homes	52.5* SS 80.5* PS
			Illinois	Data From 1990	Indoor	Single-family homes	58.8* SS 63* PS
			Indiana	Data From 1990	Indoor	Single-family homes	53.2* SS 53.2* PS
			Kentucky	Data From 1990	Indoor	Single-family homes	35* SS 49* PS
			Louisiana	Data From 1990	Indoor	Single-family homes	58.1* SS 86.8* PS
			Maine	Data From 1990	Indoor	Single-family homes	63* SS 40.6* PS
			Maryland	Data From 1990	Indoor	Single-family homes	58.1* SS 73.5* PS
			Massachusetts	Data From 1990	Indoor	Single-family homes	50.4* SS 46.2* PS
			Michigan	Data From 1990	Indoor	Single-family homes	51.1* SS 53.9* PS
			Mississippi	Data From 1990	Indoor	Single-family homes	35* SS 86.1* PS

Table 1. (cont.)

Sponsor	Source	Study	Area of Study	Time Period	Indoor use or Total use?	Type of Dwelling	Per capita daily water use
United States Geological Survey	http://water.usgs.gov/watuse/tables/dotab.st.html	Table 12. Domestic Freshwater Use by State (States chosen with humidity similar to that of Michigan) (cont.)	Missouri	Data From 1990	Indoor	Single-family homes	42* SS 59.5* PS
			New Hampshire	Data From 1990	Indoor	Single-family homes	45.5* SS 49.7* PS
			New Jersey	Data From 1990	Indoor	Single-family homes	52.5* SS 52.5* PS
			New York	Data From 1990	Indoor	Single-family homes	40.6* SS 83.3* PS
			North Carolina	Data From 1990	Indoor	Single-family homes	38.5* SS 39.9* PS

			Ohio	Data From 1990	Indoor	Single-family homes	52.5* SS 37.5* PS
			Pennsylvania	Data From 1990	Indoor	Single-family homes	36.4* SS 43.4* PS
			Rhode Island	Data From 1990	Indoor	Single-family homes	49* SS 46.9* PS
			South Carolina	Data From 1990	Indoor	Single-family homes	52.5* SS 53.2* PS
			Tennessee	Data From 1990	Indoor	Single-family homes	45.5* SS 59.5* PS
			Vermont	Data From 1990	Indoor	Single-family homes	50.4* SS 56* PS
			Virginia	Data From 1990	Indoor	Single-family homes	52.5* SS 52.5* PS
			West Virginia	Data From 1990	Indoor	Single-family homes	56* SS 51.8* PS
			Wisconsin	Data From 1990	Indoor	Single-family homes	42.7* SS 36.4* PS

Table 1. (cont.)

Sponsor	Source	Study	Area of Study	Time Period	Indoor use or Total use?	Type of Dwelling	Per capita daily water use
United States Geological Survey	http://oh.water.usgs.gov/water_use/95huc.html	Estimated Water Use for Ohio, 1995, by Hydrologic Cataloging Unit	Ohio	Data From 1995	Indoor	Single-family homes	70 SS* 50 PS*
Michigan Department of Public Health		Oakland County Water Use/Population Study	Oakland County, MI	Data From 1991	Total	151 2 bedroom homes	56.7*
						445 3 bedroom homes	49*
						186 4 bedroom homes	51.8*
						30 5 bedroom homes	57.4*

SS = Self-supplied

PS = Public-supplied

*Converted to Indoor Use From Total Use by using the formula Indoor Use = (0.70) Total Use

** This study stated these apartments to have an especially large amount of leakage and therefore the numbers from these apartments were not used in any averages

Average per capita indoor water use = 50.76

SS average per capita indoor water use = 51.1

PS average per capita indoor water use = 50.47

Range of per capita water use = 35-100

Table 2. Sources whose data was found by actual measurement, measured in GPD/Home

Sponsor	Study	Area of Study	Time Period	Indoor use or Total use?	Type of Dwelling	GPD/Home
Equinox, Inc., Stephens Consulting, Inc.	Daniel C. Schrauben and David R. Beschke, "Basis of Design, Flow Adjustment, Wastewater System, Mill Valley Condominium Subdivision", June 17, 1999.	Deer Creek	Data From 1990	Indoor	3 single-family homes	148
		Greenock Hills No. 3	Data From 1990	Indoor	20 single-family homes	158
		Lake Tyrone	Data From 1990	Indoor	182 single-family homes	165
		Portage Bay	Data From 1990	Indoor	20 single family homes	140
		Runyan Lake	Data From 1990	Indoor	274 single-family homes	164
		Sandy Creek	Data From 1990	Indoor	5 single-family homes	154
		Tanglewood	??	Indoor	136 single-family	145

				homes	
		City of Novi	Data From 1990-1992	Indoor	4 bedroom home 327
		City of Novi	Data From 1990-1992	Indoor	3 bedroom home 234
		Eagle Ravine	Data From 1990	Indoor	8 Single-family homes 270
		Milford Bluffs	Data From 1990	Indoor	3 bedroom home 222
		Milford Bluffs	Data From 1990	Indoor	4 bedroom home 255
		Settler's Pointe	Data From 1990	Indoor	3 bedroom home 213

Table 2. (cont.)

Sponsor	Study	Area of Study	Time Period	Indoor use or Total use?	Type of Dwelling	GPD/Home
Equinox, Inc., Stephens Consulting, Inc.	Daniel C. Schrauben and David R. Beschke, "Basis of Design, Flow Adjustment, Wastewater System, Mill Valley Condominium Subdivision", June 17, 1999. (cont.)	Settler's Pointe	Data From 1990	Indoor	4 bedroom home	281
		Village of Milford	??	Indoor	4 bedroom home	209
		Village of Milford	??	Indoor	3 bedroom home	206
Michigan Department of Public Health	Oakland County Water Use/Population Study	Oakland County, MI	Data From 1991	Total	3 Bedroom home	197
					4 Bedroom home	257
	Highland Township, Four Bedroom and Three Bedroom Water Usage Comparison	Highland Township	Data From 1993	Total	3 Bedroom home	256
					4 Bedroom home	284

Average per home indoor water use (all homes) = 214.3
Average indoor water use (3 bedroom homes) = 221.3
Average indoor water use (4 bedroom homes) = 285.5
Range of indoor water use (all homes) = 140-327

Table 3. Sources whose data was found by actual measurement, measured in GPD/BR

Sponsor	Study	Area of Study	Time Period	Indoor use or Total use?	Type of Dwelling	GPD/Bedroom
Michigan Department of Public Health	Engineering Company Review of One Subdivision, Jackson County	Jackson County	Data From 1991	Total	66 single-family homes (3 & 4 bedrooms)	56

Table 4. Sources using published numbers (recommended for design use)

Sponsor	Source	Study	Area of Study	Time Period	Indoor use or Total use?	Type of Dwelling	Per capita daily water use
Auburn University	http://hermes.ecn.purdue.edu/cgi/convertwq?7696	Conserving Water, Developing Water-Conserving Habits: A Checklist	Alabama	Data From 1995	Indoor	Single-family homes	50-70
Domestic Wastewater Systems & Pump Talk, R.L. Peeks Pump Sales	http://freshosting1.at.webjump.com/6eba64886/pw/pumpman-webjump/plan.htm	Planning Your Water System	N/A	Last Modified May 2000	Indoor	Single-family homes	75
Individual Sewage Treatment System (ISTS), Scott County	http://www.co.scott.mn.us/EH/ISTS/septic.htm	Water Usage and Your On-Site Sewage Treatment System	Minnesota	Data From 1990	Indoor	Single-family homes	52.5*-70*
Kennewick Public Works Department	http://www.ci.kennewick.wa.us/pw/watercon.htm	32 Tips on Water Conservation	Washington	Last Modified June 2000	Indoor	Single-family homes	63.75
Michigan State	http://hermes.ecn.purdue.edu/cgi/convertwq?25373	How to Conserve	Michigan	Data from	Indoor	Single-family	50-70

University, Extension		Water in Your Home and Yard		1987		homes	
Missouri Department of Natural Resources, Energy Center	http://www.dnr.state.mo.us/de/residential/waterusage.htm	Residential Energy Efficiency, Water Usage	Missouri	Last Modified Mar. 2000	Indoor	Single-family homes	50
North Carolina Cooperative Extension Services	http://www.bae.ncsu.edu/bae/programs/extension/publicat/wqwm/he250.html	Focus on Residential Water Conservation	North Carolina	Last Modified Mar. 1996	Indoor	Single-family homes	52.5*
Polk County, Department of Water Conservation	http://www.co.polk.ia.us/departments/conserv/kids.asp.html	Water Conservation for Kids	Iowa	Last Modified June 2000	Indoor	Single-family homes	50

Sponsor	Source	Study	Area of Study	Time Period	Indoor use or Total use?	Type of Dwelling	Per capita daily water use
Prairie Water News, Vol. 12, no. 1	http://www.quantumlynx.com/water/back/vol12no1/v21_st2.html	Bill Anderson, "Water Use Trends on the Prairies"	Saskatchewan	Spring, 1992	Indoor	Single-family homes	50 SS
Ron Crites and George Tchobanoglous, "Small and Decentralized Wastewater Management Systems, 1999.			N/A	Copyright, 1999	Indoor	High rise	55
						Low rise	55
						Hotel	40
						Newer home	70
						Older home	50
						Summer cottage	40
						Motel w/kitchen	100
						Motel w/o kitchen	95
						Trailer park	40
United States Environmental Protection Agency (EPA), Office of Water	http://www.epa.gov/OGWDW/wot/howmuch.html	How Much Drinking Water Do We Use in Our Homes	N/A	Last Modified June 2000	Indoor	Single-family homes	54.5
United States Geological Survey	http://water.usgs.gov/outreach/poster3/grade_school/Page7.html	Water Resources Outreach Program	N/A	Last Modified Mar. 2000	Indoor	Single-family homes	79
University of Arkansas	http://hermes.ecn.purdue.edu/cgi/convertwq?7541	Home Water Use Management	Arkansas	Data From 1992	Indoor	Single-family homes	63.75
University of Georgia	http://hermes.ecn.purdue.edu/cgi/convertwq?6229	Conserving Water at Home	Georgia	Data From 1991	Indoor	Single-family homes	50-75
University of Maine	http://hermes.ecn.purdue.edu/cgi/convertwq?6453	Conserving Water at Home	Maine	Data From 1991	Indoor	Single-family homes	45-50

Sponsor	Source	Study	Area of Study	Time Period	Indoor use or Total use?	Type of Dwelling	Per capita daily water use
University of Maryland	http://hermes.ecn.purdue.edu/cgi/convertwq?5321	Margaret T. Ordonez, "Water Conservation	Maryland	??	Indoor	Single-family homes	50-75

		In the Home."					
University of Minnesota	http://www.extension.umn.edu/distribution/youthdevelopment/components/0328-05.html	Water Use and Conservation	Minnesota	Last Modified June 2000	Indoor	Single-family homes	50
University of Rhode Island	http://hermes.ecn.purdue.edu/cgi/convertwq?6425	Alyson McCann and Thomas P. Husband, "Water Conservation In and Around the Home.", 1999.	Rhode Island	Data From 1991	Indoor	Single-family homes	50-75

SS = Self-supplied

PS = Public-supplied

*Converted to indoor use from total use by using the formula Indoor Use = (0.70) Total Use

Range of per capita water use for homes = 40-79

Interesting Observations on the Effects of Some Factors on Water Use

- Water-conserving toilets were shown to leak more often than non-conserving ones in the "Water Saved by Low-flow Fixtures" study done by the U.S. Department of Housing and Urban Development.
- Effects of income level and household size on water use:
 - To determine the effects of income on residential water use, the study "Water Saved by Low-flow Fixtures" by the U.S. Department of Housing and Urban Development compared the average interior water use in gallons per capita-day for each household with the average income range for that household. The scatter plot of this data showed a wide variation of per capita water use within each income range.
 - The average interior water use values for each income bracket were also compared, and showed little or no correlation between income and water use.
 - In this same study, the average interior water use in gpcd was compared with household size. A wide variation of water usage within each household size was observed. However, the comparison of average interior water use for each group of household sizes did show a decreasing trend in per capita use as the number of people in the house increased.
 - If outside use were also included in this study, a correlation between income and water use would most likely be observed, due to bigger yard size and pools.
 - In the study, "Analysis of Residential Use of Water in the Denver Metropolitan Area, Co", it was found that Indoor water use correlated best with persons per household and that correlation with assessed value was very low.
 - The Oakland County Water Use/Population Study also showed little or no correlation between assessed value and water use.
 - It is interesting to note, however, that homes with low incomes may not have washing machines or dishwashers, while homes with higher incomes usually do. This could have a great effect on water use.
- Indoor water use as a function of total water use:
 - Indoor water use is said to be about seventy-five percent of total water use in the document, "Focus on Residential Water Conservation" by the North Carolina Cooperative Extension Service.
 - The book "Small and Decentralized Wastewater Management Systems" states that, "If a community has a water system but not a wastewater collection system, the average wastewater flow-rate can be estimated by multiplying the water use by a factor of sixty-eighty percent, depending on the landscaping." This is approximately equivalent to saying that base water use is sixty-eighty percent of total water use.
 - The Oakland County Water Use/Population Study shows a difference between winter and summer water use of sixty-six percent.
 - Based on these observations some of the total water use data in the above table was multiplied by a factor of 0.70 to get the indoor water use.
 - The study "Analysis of Residential use of Water in the Denver Metropolitan Area, Co" states that, "Water used to grow lawns in Denver is forty-two percent of water consumption." This is because Colorado is a very dry state.
- Times of peak water use:
 - In the study, "Analysis of Residential Use of Water in the Denver Metropolitan Area, Co", it is stated that, "more water is used in the summer, on Sundays, and from 7 a.m.- 9 a.m."
 - On the EPA's website "How Much Drinking Water Do We Use In Our Homes?", it states that
 - The lowest rate of use is from 11:30 p.m. to 5:00 a.m.
 - There is a sharp rise in use from 5:00 a.m. to noon, with a peak hourly use from 7:00 a.m. to 8:00 a.m.
 - There is a moderate use from noon to 5:00 p.m., with a lull around 3:00 p.m.
 - There is an increase in use in the evening from 5:00 to 11:00 p.m., with the second minor peak from 6:00 to 8:00 p.m.
- Metered versus flat rate customers:
 - The study, "Water Saved by Metering", done by the U.S. Department of Housing and Urban Development compares metered customers' water use with that of flat rate customers.
 - Denver is unique because it has both metered and flat rate customers. Since 1957, all new homes have been required to be metered. In spite of this, most customers are flat rate because they pre-existed this policy. Because of this, nearly identical homes in the same area can have different billing systems.
 - To study the effect of metering, one group of twenty-five metered homes and two groups of flat-rate homes (forty-two homes total) were identified, and their water use data collected for a period of three-years.
 - The test groups were selected so those factors such as fire hydrants and downstream water uses were eliminated.
 - Over the three-year period of data collection, water use in metered homes averaged about 453 gallons per day (total, 42% is yard watering), and water use in flat-rate homes averaged about 566 gpd. Thus, metered homes used twenty-percent less water than flat-rate homes.
 - The basic effect of metering is to reduce the amount of water used for irrigation. Therefore, water use would be reduced more in a dry area such as Denver than a more humid area.
- Effect of water pressure on water use:
 - Reducing water pressure can be one means of reducing water use. A decrease in water pressure causes a decrease in water flow related to the square root of pressure drop.

- Many water use appliances regulate the volume of water they use, eliminating the effect of water pressure. Water pressure does, however, have an effect on water leakage and outdoor water use.
- The U. S. Department of Housing and Urban Development did a study on water pressure entitled, "Effect of Water Pressure on Water Use", in which they studied different pressure zones in Denver, Los Angeles, and Atlanta. They found a difference of about two-three percent in the water use of homes with high compared to low pressure (difference of about 35 psi).
- Equations Related to Water Use
 - The book, "Small and Decentralized Wastewater Management Systems", states that the equation for flow from a residence can be given as: Flow, gal/home*day = 40 gal/home*day + 35 gal/person*day x (number of persons/home).
 - The document, "Water Use", given to me by Larry Stephens describes three types of residences, with separate equations for estimating water use.
 - In a Type I residence the total floor area of the residence divided by the number of bedrooms is more than 800 square feet, or more than two of the following water-use appliances are installed: automatic washer, dishwasher. In a Type I residence the estimated water use is equal to 150 gpd/bedroom. This assumes an occupancy of two people per bedroom, each using 75 gpd.
 - In a Type II residence the total floor area of the residence divided by the number of bedrooms is more than 500 square feet and there are no more than two water-use appliances. Water use in a Type II residence is obtained by multiplying 75 times a factor equal to the number of bedrooms plus one.
 - In a Type III residence the total floor area of the residence divided by the number of bedrooms is more than 500 square feet and there are no more than two water-use appliances. Water use in a Type III residence is obtained from the formula: 66+38(number of bedrooms +1).

References

- Anderson, Bill. 2000. Water Use Trends on the Prairies. Prairie Water News Vol. 12, No. 1 (1992) August 2000. <http://www.quantumlynx.com/water/back/vol2no1/v21_st2.html>.
- AWWA Research Foundation Webpage. 2000. "Residential End Uses of Water [Project#241]" June 2000 <<http://www.awwarf.com/exsums/90781.htm>>.
- Brown and Caldwell. 1984. Residential Water Conservation Projects, Summary Report. USDHUD.
- University of Georgia. August 2000. Conserving Water At Home. <<http://hermes.ecn.purdue.edu/cgi/convertwq?6229>>.
- University of Maine. August 2000. Conserving Water At Home. <<http://hermes.ecn.purdue.edu/cgi/convertwq?6453>>.
- Auburn University. August 2000. Conserving Water, Developing Water-Conserving Habits: A Checklist. <<http://hermes.ecn.purdue.edu/cgi/convertwq?7696>>.
- Crites, Ron and Tchobanoglous, George, "Small and Decentralized Wastewater Management Systems", 1999.
- R. L. Peeks Pump Sales. July 2000. Domestic Wastewater Systems and Pump Talk. <<http://freehosting1.at.we.bjump.com/6eba64886/pu/pumpmanwebjump/plan.htm>>.
- United States Geological Survey. August 2000. Estimated Use of Water in the U. S. in 1990. <<http://water.usgs.gov/watuse/tables/dotab.st.html>>.
- United States Geological Survey. August 2000. Estimated Water Use for Ohio, 1995. <http://oh.water.usgs.gov/water_use/95huc.html>.
- North Carolina Cooperative Extension Service. August 2000. Focus on Residential Water Conservation. <<http://www.bae.ncsu.edu/bae/programs/extension/publicat/wqwm/he250.html>>.
- University of Arkansas. August 2000. Home Water Use Management. <<http://hermes.ecn.purdue.edu/cgi/convertwq?7541>>.
- Horn, M.A., Craft, P.A., Bratton, Lisa. 1988. Estimation of Water Withdrawal and Distribution, Water Use, and Wastewater Collection and Return Flow in Cumberland, Rhode Island. Rhode Island's Governor's Office of Housing, Energy and Intergovernmental Relations.
- United States Environmental Protection Agency (EPA), Office of Water. August 2000. How Much Drinking Water Do We Use in Our Homes. <<http://www.epa.gov/OGWDW/wot/howmuch.html>>.
- Michigan State University Extension. July 2000. How to Conserve Water in Your Home and Yard. <<http://hermes.ecn.purdue.edu/cgi/convertwq?5373>>.
- Litke and Kauffman. 1988. Analysis of Residential use of Water in the Denver Metropolitan Area. Denver Board of Water Commissioners.
- Michigan Department of Environmental Quality. 1999. Oakland County Water Use/Population Study, 1991, Highland Township Water Use Data, 1993, and Jackson County Sanitary Flow Comparison.
- Missouri Department of Natural Resources Energy Center. August 2000. Residential Energy Efficiency. <<http://www.dnr.state.mo.us/de/residential/waterusage.htm>>.
- Schrauben, Daniel and David Beschke. 1999. Basis of Design Flow Adjustment, Wastewater System Mill Valley Condominium Subdivision. Equinox Inc. June 1999.

Polk County, Department of Water Conservation. August 2000. Water Conservation For Kids.
<<http://www.co.polk.ia.us/departments/conserv/kids.asp.html>>

U of Rhode Island. August 2000. Water Conservation In and Around the Home.
<<http://hermes.ecn.purdue.edu/cgi/convertwq?6425>>

University of Maryland. August 2000. Water Conservation In the Home.
<<http://hermes.ecn.purdue.edu/cgi/convertwq?5321>>

Unites States Geological Survey. August, 2000. Water Resources Outreach Program Page.
<http://water.usgs.gov/outreach/poster3/grade_school/Page7.html>

Water Usage and Your Onsite Sewage Treatment System. Individual Sewage Treatment System (ISTS), Scott County, MN. July 2000.
<<http://www.co.scott.mn.us/EH/ISTS/septic.htm>>

University of Minnesota. August 2000. Water Use and Conservation.
<<http://www.extension.umn.edu/distribution/youthdevelopment/components/0328-05.html>>

Kennewick Public Works Department. July, 2000. 32 Tips on Water Conservation <<http://www.ci.kennewick.wa.us/pw/watercom.htm>>

6. Existing information.

Matthew S. Willis Register of Deeds
 Harnett County, NC
 Electronically Recorded
 06/16/2023 04:00:06 PM NC Rev Stamp: \$3,040.00
 Book: 4196 Page: 2144 - 2146 (3) Fee: \$26.00
 Instrument Number: 2023009751

HARNETT COUNTY TAX ID #
 050633 0104 02 & 15 OTHERS

06-16-2023 BY: SM

NORTH CAROLINA SPECIAL WARRANTY DEED

Excise Tax:	\$3,040.00
Parcel ID:	050633 0104 02; 050633 0104 03; 050633 0104 08; 050633 0104 09; 050633 0104 11; 050633 0104 12; 050633 0104 13; 050633 0104 14; 050633 0104 15; 050633 0104 16; 050633 0104 18; 050633 0104 19; 050633 0104 20; 050633 0104 21; 050633 0104 22; & 050633 0104 23
Mail/Box to:	GRANTEE
Prepared by:	Adcock Law Firm, P.A., PO Box 1478, Fuquay-Varina, NC 27526 <i>Without title exam, closing or tax advice. Delinquent taxes, if any, to be paid by the closing attorney to the county tax collector upon disbursement of closing proceeds.</i>
Brief description for the Index:	Prince Place Phase 2, Map No. 2023 Page 240

THIS SPECIAL WARRANTY DEED ("Deed") is made on the 16th day of June 2023, by and between:

GRANTOR	GRANTEE
KIPLING PROPERTIES, LLC A North Carolina limited liability company 8615 Mt. Pleasant Church Rd. Willow Spring, NC 27592	DFC VILLAGE AT TOWNE LAKE, LLC A Florida limited liability company 1300 Sawgrass Village Circle, Bldg. 5, Suite 2 Ponte Vedra Beach, FL 32082

FOR VALUABLE CONSIDERATION paid by Grantee, the receipt and legal sufficiency of which is acknowledged, Grantor by this Deed does hereby grant, bargain, sell and convey to Grantee, in fee simple, all that certain lot, parcel of land or condominium unit in the City of _____, HECTOR'S CREEK Township, HARNETT County, North Carolina and more particularly described as follows (the "Property"):

BEING all of those parcels or lots identified as 37, 38, 43, 44, 46, 47, 48, 49, 50, 51, 53, 54, 55, 56, 57 and 58 shown on that plat entitled "PRINCE PLACE - PHASE 2", recorded at Map Number 2023, pages 240 & 241, Harnett County Registry, reference to which is hereby made for greater certainty of description.

All or a portion of the Property was acquired by Grantor by instrument recorded in Book 3965 page 440.

All or a portion of the Property includes or does not include the primary residence of a Grantor.

A map showing the Property is recorded in Plat Book 2023 page 240 & 241.

TO HAVE AND TO HOLD the Property and all privileges and appurtenances thereto belonging to Grantee in fee simple. Grantor covenants with Grantee that Grantor has done nothing to impair such title as Grantor received, and Grantor shall warrant and defend the title against the lawful claims of all persons claiming by, under or through Grantor, other than the following exceptions:

See Exhibit A, attached hereto and incorporated herein by reference.

IN WITNESS WHEREOF, Grantor has duly executed this North Carolina Special Warranty Deed, if an entity by its duly authorized representative.

KIPLING PROPERTIES, LLC
By: [Signature]
Name: HUGH SURLS
Title: MANAGING MEMBER

STATE OF NORTH CAROLINA, COUNTY OF WAKE

I, John B. Adcock, the undersigned Notary of the above state and county, certify that the following person(s) personally appeared before me on the 15th day of June 2023, each acknowledging to me that he or she signed the foregoing document, in the capacity represented and identified therein (if any): HUGH SURLS.

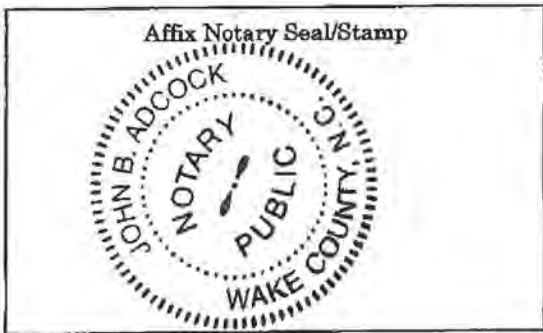

[Signature]
Notary Public (Official Signature)
My commission expires: January 25, 2026

EXHIBIT A
EXCEPTIONS

1. Taxes for year 2023, and subsequent years, not yet due and payable
2. All matters shown on the following plats recorded in the Harnett County Registry:

Map Number 2023, Pages 240-241;
Map Number 2009, Page 631;
Map Number 2020, Page 341;
Map Number 2010, Page 584;
3. Easement to Duke Energy Progress, LLC recorded at Book 4173, Page 588.
4. Declaration of Covenants, Conditions and Restrictions, Prince Place Subdivision recorded at Book 4051, Page 141; as amended by that Amendment to Declaration of Covenants, Conditions and Restrictions, Prince Place Subdivision recorded at Book 4122, Page 141; and as amended by that Supplement and Amendment to Declaration of Covenants, Conditions and Restrictions Prince Place Subdivision recorded at Book 4196, Page 2131 in the Harnett County Registry.
5. Zoning ordinances and land use regulations affecting the property.
6. Right-of-way to NCDOT recorded at Book 2084, Page 337, Harnett County Registry.

MAXIMUM IMPERVIOUS SURFACE COVERAGE ALLOWED PER LOT IS NOT TO EXCEED 4208 SQUARE FEET.

m3

BE 100' FROM NE CORNER OF ADJACENT LOT TO PROPERTY LINE
 BE 100' FROM NE CORNER OF ADJACENT LOT TO PROPERTY LINE
 BE 100' FROM NE CORNER OF ADJACENT LOT TO PROPERTY LINE

JAMES H. MOAYER
 D.B. 3102, PC.881

IRIEL R. ARNOLD
 ANNETTE N. ARNOLD
 D.B. 2608, PC.85

JOHN W. JONES
 JANET A. JONES
 D.B. 2702, PC.800
 M.B. 89, PC.253

TOMMY R. ARNOLD
 PATTY W. ARNOLD
 D.B. 1358, PC.333
 M.B. 89, PC.255

RUBY R. EGGE
 MARSHA F. BOWLES
 D.B. 3880, PC.220

RODNEY W. TROSBON
 LYNN H. TROSBON
 D.B. 3474, PC.818
 M.B. 2017, PC.007

PRIMOJENIA MUSHONKA
 MICOLE MUSHONKA
 D.B. 3880, PC.220
 M.B. 2017, PC.081

HORACE L. WHEELER
 D.B. 3102, PC.881
 M.B. 2017, PC.007

WILLIAM H. GREEN
 LINDA P. GREEN
 D.B. 3141, PC.370
 P.O. BOX 1070

HORACE L. WHEELER
 D.B. 3102, PC.881
 M.B. 2017, PC.007



Lot #	Area (Sq. Ft.)	Area (Acres)
37	30640	0.716
38	27864	0.638
39	25302	0.584
40	101398	2.327
41	29082	0.667
42	44459	1.020
43	40384	0.927
44	29205	0.670
45	29245	0.672
46	50671	1.161
47	29860	0.682
48	45745	1.050
49	26539	0.605
50	30791	0.706
51	32528	0.746
52	30444	0.698

Chart	Length	Chart	Offset Bear.
1	100.00	1	100.00
2	100.00	2	100.00
3	100.00	3	100.00
4	100.00	4	100.00
5	100.00	5	100.00
6	100.00	6	100.00
7	100.00	7	100.00
8	100.00	8	100.00
9	100.00	9	100.00
10	100.00	10	100.00
11	100.00	11	100.00
12	100.00	12	100.00
13	100.00	13	100.00
14	100.00	14	100.00
15	100.00	15	100.00
16	100.00	16	100.00
17	100.00	17	100.00
18	100.00	18	100.00
19	100.00	19	100.00
20	100.00	20	100.00
21	100.00	21	100.00
22	100.00	22	100.00
23	100.00	23	100.00
24	100.00	24	100.00
25	100.00	25	100.00
26	100.00	26	100.00
27	100.00	27	100.00
28	100.00	28	100.00
29	100.00	29	100.00
30	100.00	30	100.00
31	100.00	31	100.00
32	100.00	32	100.00
33	100.00	33	100.00
34	100.00	34	100.00
35	100.00	35	100.00
36	100.00	36	100.00
37	100.00	37	100.00
38	100.00	38	100.00
39	100.00	39	100.00
40	100.00	40	100.00
41	100.00	41	100.00
42	100.00	42	100.00
43	100.00	43	100.00
44	100.00	44	100.00
45	100.00	45	100.00
46	100.00	46	100.00
47	100.00	47	100.00
48	100.00	48	100.00
49	100.00	49	100.00
50	100.00	50	100.00
51	100.00	51	100.00
52	100.00	52	100.00
53	100.00	53	100.00
54	100.00	54	100.00
55	100.00	55	100.00
56	100.00	56	100.00
57	100.00	57	100.00
58	100.00	58	100.00
59	100.00	59	100.00
60	100.00	60	100.00
61	100.00	61	100.00
62	100.00	62	100.00
63	100.00	63	100.00
64	100.00	64	100.00
65	100.00	65	100.00
66	100.00	66	100.00
67	100.00	67	100.00
68	100.00	68	100.00
69	100.00	69	100.00
70	100.00	70	100.00
71	100.00	71	100.00
72	100.00	72	100.00
73	100.00	73	100.00
74	100.00	74	100.00
75	100.00	75	100.00
76	100.00	76	100.00
77	100.00	77	100.00
78	100.00	78	100.00
79	100.00	79	100.00
80	100.00	80	100.00
81	100.00	81	100.00
82	100.00	82	100.00
83	100.00	83	100.00
84	100.00	84	100.00
85	100.00	85	100.00
86	100.00	86	100.00
87	100.00	87	100.00
88	100.00	88	100.00
89	100.00	89	100.00
90	100.00	90	100.00
91	100.00	91	100.00
92	100.00	92	100.00
93	100.00	93	100.00
94	100.00	94	100.00
95	100.00	95	100.00
96	100.00	96	100.00
97	100.00	97	100.00
98	100.00	98	100.00
99	100.00	99	100.00
100	100.00	100	100.00

SHEET 2 OF 2

OWNER:
 KIPJUNG PROPERTIES LLC
 126 BRANDON DRIVE
 DUBLIN, N.C. 27546

**SUBDIVISION MAP FOR:
 PRINCE PLACE - PHASE 2**

HECTORS CREEK TOWNSHIP, HARNETT COUNTY, NORTH CAROLINA
 SCALE 1" = 120' NOVEMBER 9, 2022

MAULDIN - WATKINS SURVEYING, P.A.
 P.O. BOX 444 / 139 N. MAIN STREET
 FOGUAY VARNER, NORTH CAROLINA 27526
 (919) 552-9326 C-4929



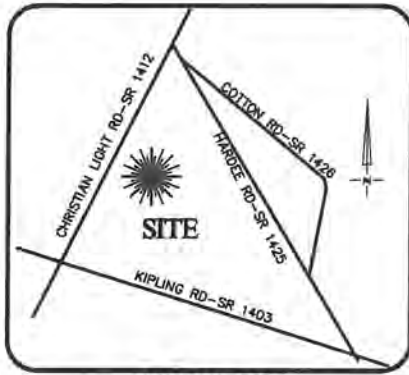

VICINITY MAP
Not To Scale



IMPERVIOUS SURFACE AREA	
DESCRIPTION	AREA
HOUSE w/ PORCH	1,808 S.F.
CV PORCH/HVAC	135 S.F.
DRIVEWAY & WALKS	772 S.F.
TOTAL (PROPOSED)=	2,715 S.F.
*TOTAL (ALLOWED)=	4,208 S.F.

*PB 2023 PG 241



SETBACKS: (PB 2023 PG 240)

FRONT: 35' FROM R/W
REAR: 25'
SIDE: 10'
CORNER LOT SIDE: 20'



CURVE	RADIUS	ARC LENGTH	CH LENGTH	CH BEARING
C1	205.00'	43.03'	42.95'	N80°03'40"E

THIS PROPERTY MAY BE SUBJECT TO ANY AND ALL APPLICABLE DEED RESTRICTIONS, EASEMENTS, RIGHT-OF-WAY, UTILITIES AND RESTRICTIVE COVENANTS WHICH MAY BE OF RECORD OR IMPLIED

THIS DRAWING DOES NOT REFLECT AS-BUILT INFORMATION

PRELIMINARY PLAT
NOT FOR RECORDATION, CONVEYANCES, OR SALES

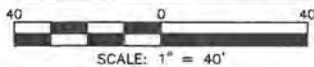

**RESIDENTIAL
LAND SERVICES, PLLC.**

1917 Evans Road
Cory, North Carolina 27513
Phone (919) 378-9316
Firm License # P-0873

HOUSE LOCATION PLOT PLAN

FOR
#270 CASTLE POND WAY
LOT 49, PRINCE PLACE, PHASE 2
Hectors Creek Township, Harnett County, North Carolina
PROPERTY OF: DAVIDSON HOMES
PLAT BOOK 2023 PAGE 240-241 DEED REFERENCE _____

DRAWN: JLS SURVEYED: N/A CHECKED: JWW DATE: AUGUST 8, 2023

Prince Place - Phase II
 4-Bedroom Septic Design
 Lot # 49
 Harnett County

Preliminary Septic Plan - NOT A PERMIT or Final Design

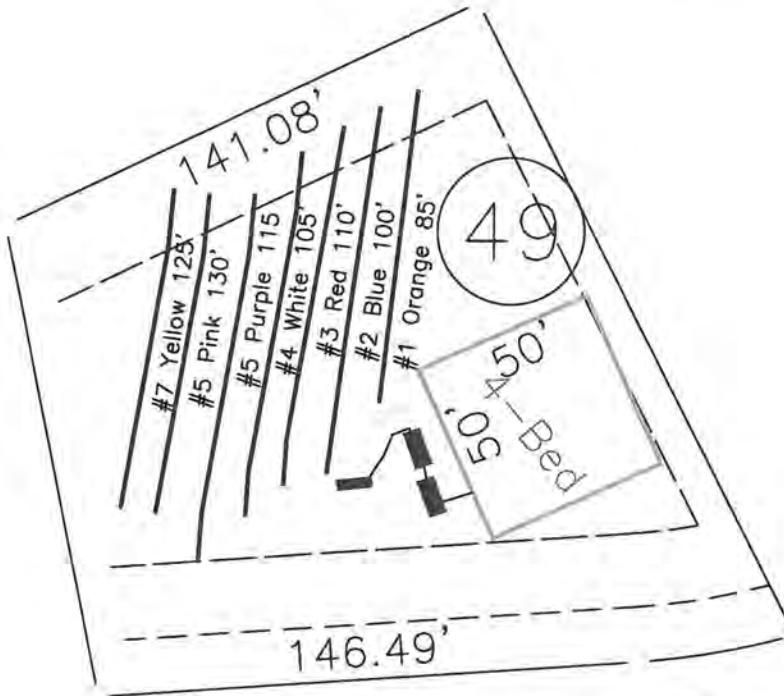

CASTE POND WAY

System: Pressure Manifold
 Lines: 1-4 (360+)
 0.35 LTAR
 18" Max Trench Bottom
 Accepted Status System
 Repair: Pressure Manifold
 Lines: 5-7 (360')
 0.35 LTAR
 18" Max Trench Bottom
 Accepted Status System

*House footprint to be field staked by surveyor and system verified prior to any construction

**Septic area must not be altered by construction activities.

***No cuts of 2' or greater within 15' of septic area

**** Recommend protective barrier around septic field during construction.

preliminary septic plan made prior to final construction activities. A revised plan may need to be reworked at time of permitting.

Adams
 Soil Consulting
 919-414-6761
 Job #479
 3-10-23

GRAPHIC SCALE
 1" = 50'



02/24/2022	FIX WINDOW SIZE TO 2626 PX ON D
3/30/2021	REVISION TO WH & GARAGE DOORS
11/6/2020	ADD OPT PORCHS TO OPT EXT FAMILY
10/23/2020	ADDED GAR SWH DR & OPT EXT FAMILY
7/1/2020	UPDATED SHOWER OPTIONS
03/05/2020	ADDED BASEMENT FOUNDATIONS
	REVISION NUMBER



 MAIN STREET DESIGN
 1000 NORTH DAVENPORT AVENUE, SUITE 100
 ALBANY, GA 31707
 (706) 526-3372
 WWW.MAINSTREETDESIGN.COM

 DAVIDSON
 HOMES
 THE COMMUNITY CHOICE

OPTION NO.	
PROJECT NUMBER	
RELEASE DATE	08-21-2019

OPTION DESCRIPTION	
DRAWING TITLE	COVER SHEET
MODEL	WILLOW

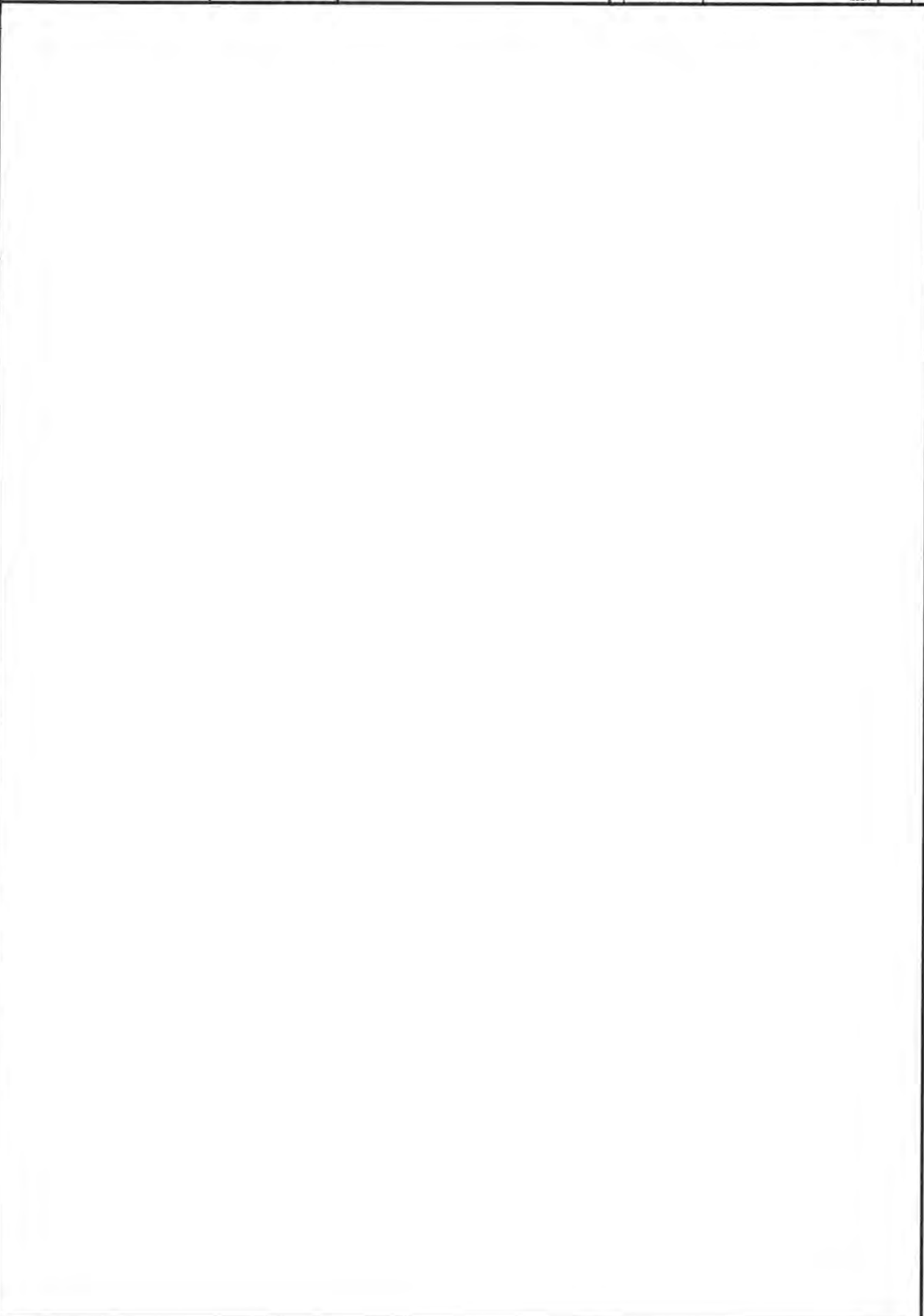
SHEET NO.
CS-1.0



02/24/2022	FIX WINDOW SIZE TO 2626 PX ON 0
03/25/2021	REVISION TO WH & GARAGE DOORS
11/15/2020	ADD OPT PORCHS TO OPT EXT FAMILY
10/23/2020	ADDED GAR WH DR & OPT EXT FAMILY
7/1/2020	UPDATED SHOWER OPTIONS
03/05/2020	ADDED BASEMENT FOUNDATIONS
	REVISION NUMBER

DAVIDSON HOMES
 3000 Boyd Blvd., Suite 100
 Alpharetta, GA 30007
 (404) 996-2722
 davidsonhomes.com

DAVIDSON HOMES
 Your Community Builder

OPTION NO.	08-21-2019
PROJECT NUMBER	1/8" = 1'-0"
RELEASE DATE	

MODEL	WILLOW
DRAWING TITLE	FIRST FLOOR PLAN
ELEVATION - B	

SHEET NO. **A-1.0B**

ELEVATION "A - C"

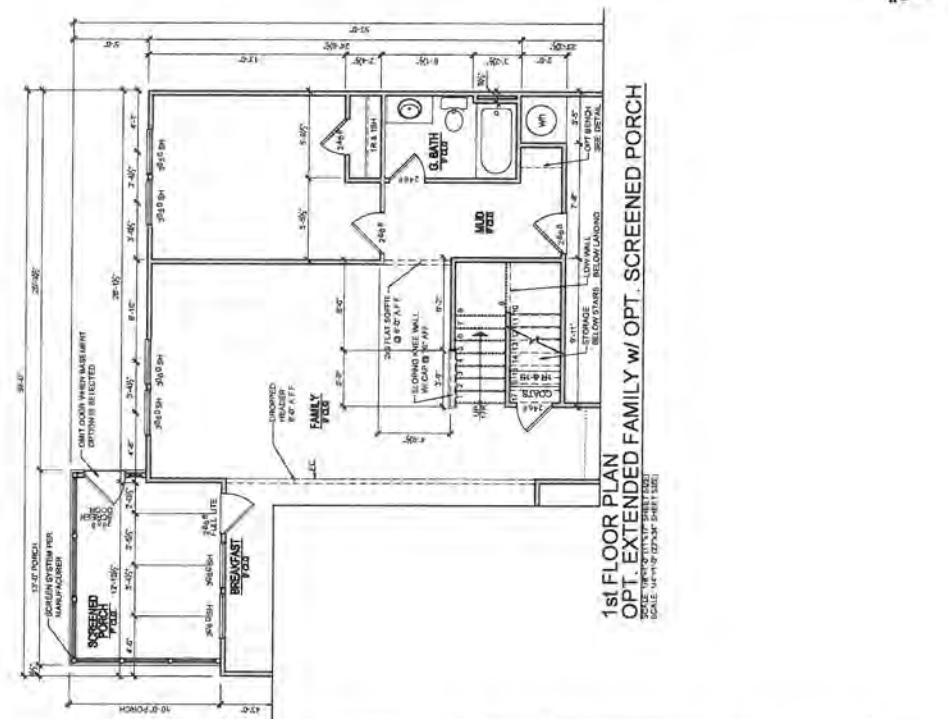

**1st FLOOR PLAN
 OPT. EXTENDED FAMILY w/ OPT. SCREENED PORCH**
 SCALE: 1/8" = 1'-0" (SEE SHEET 102)

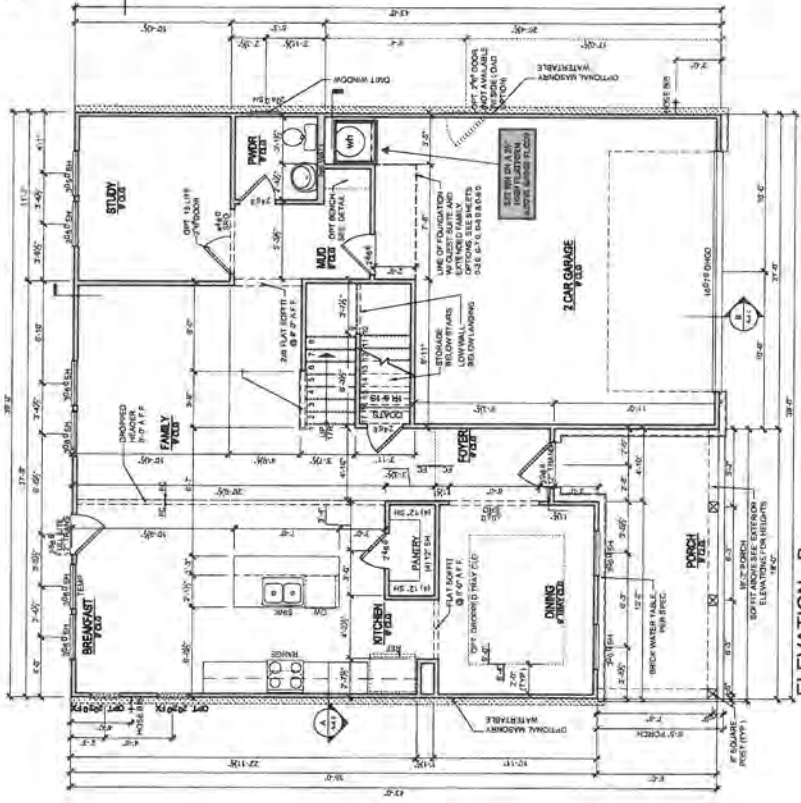

**ELEVATION - B
 1st FLOOR PLAN
 OPT. GOURMET KITCHEN**
 SCALE: 1/8" = 1'-0" (SEE SHEET 102)



**1st FLOOR PLAN
 OPT. GOURMET KITCHEN**
 SCALE: 1/8" = 1'-0" (SEE SHEET 102)

02/24/2023	FIX WINDOW SIZE TO 2826 FX ON B
11/30/2021	REVISION TO WH & GARAGE DOORS
11/6/2020	ADD OPT PORCHES TO OPT EXT FAMILY
10/23/2020	ADDED GYM SPA DR & OPT EXT FAMILY
7/1/2020	UPDATED SHOWER OPTIONS
03/05/2020	ADDED BASEMENT FOUNDATIONS
	REVISION NUMBER

DAVIDSON HOMES
 1000 WEST 10TH AVENUE, SUITE 100
 DENVER, CO 80202
 (303) 733-7777
 ARCHITECT: DAVIDSON HOMES, LLC

DAVIDSON HOMES
 THE CHAMPION BUILDERS

08-21-2019	RELEASE DATE
	PROJECT NUMBER
	DRAWING TITLE
SECOND FLOOR PLAN	OPTION DESCRIPTION
ELEVATION - B	

SHEET NO
A-2.0B

ELEVATION "A - C"

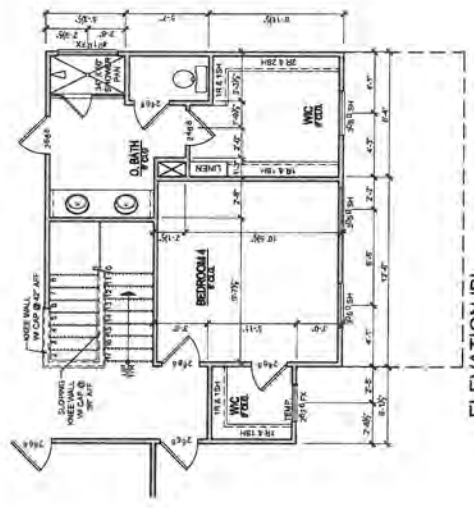
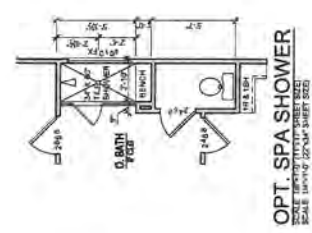
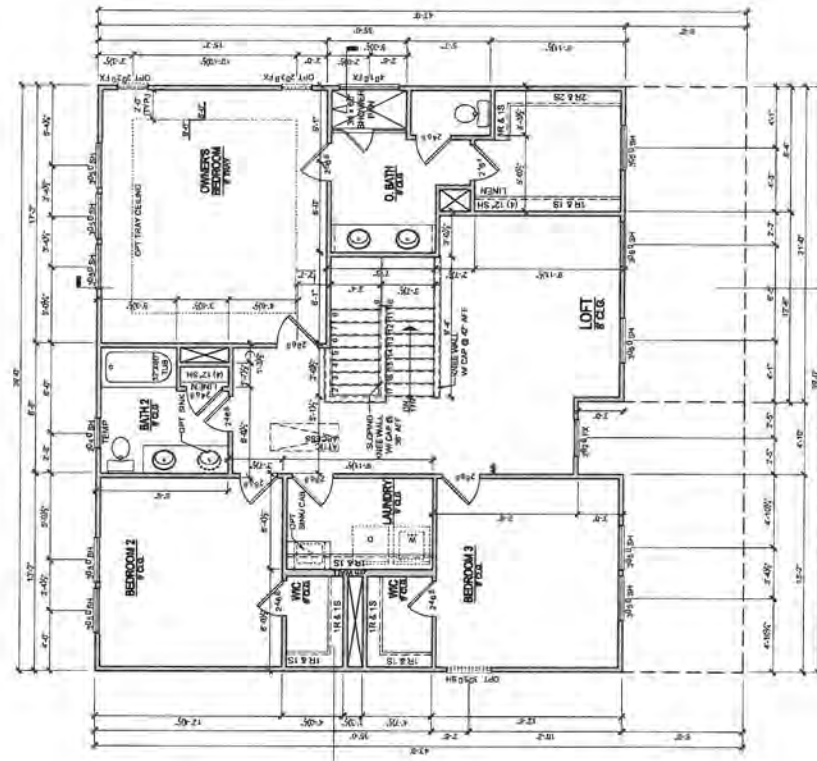

02/24/2022	FIX WINDOW SIZE TO 2026 FX ON D
3/30/2021	REVISION TO WH & GARAGE DOORS
11/6/2020	ADD OPT PORCHS TO OPT FAMILY
10/22/2020	ADDED GAR SVR DR & OPT EXT FAMILY
7/1/2020	UPDATED SHOWER OPTIONS
03/05/2020	ADDED BASEMENT FOUNDATIONS
	REVISION NUMBER

DAVIDSON HOMES
 Your Community Builder
 2009 Royal Blvd, Suite 300, 153
 Pittsburgh, PA 15222
 (412) 998-2722
 www.davidsonhomes.com
 Main Street Design of Chicago, LLC

08-21-2019	RELEASE DATE
	PROJECT NUMBER
	OPTION NO.

ELEVATION - B	OPTION DESCRIPTION
WILLOW	DRAWING TITLE
A-3.1B	SHEET NO.

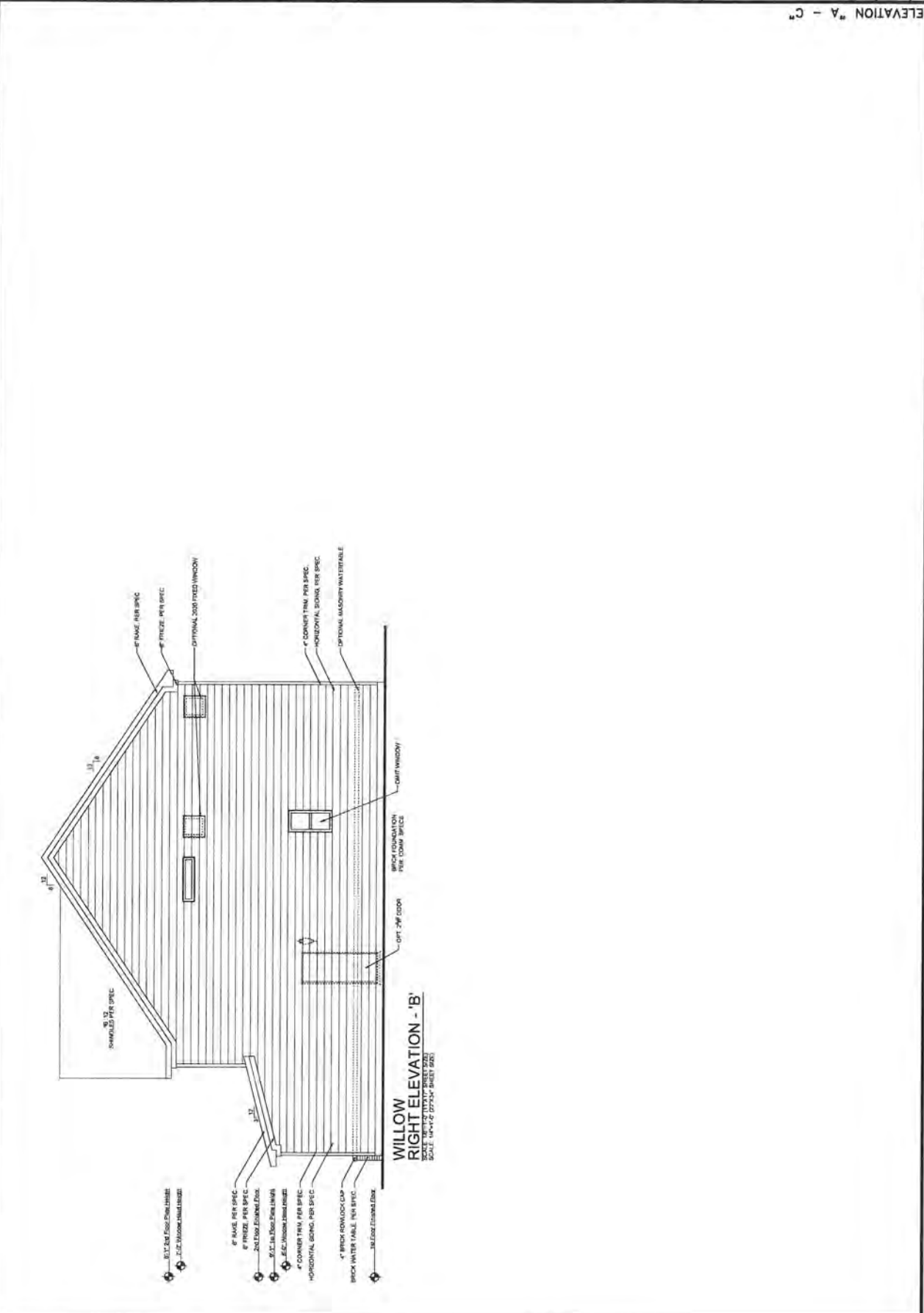

WILLOW
RIGHT ELEVATION - 'B'
 SCALE: 1/8" = 1'-0"
 DATE: 08-21-2019

ELEVATION "A - C"

02/24/2022	FIX WINDOW SIZE TO 2626 FX ON 0
3/30/2021	REVISION TO WH & GARAGE DOORS
11/8/2020	ADD OPT PORCHS TO OPT EXT FAMILY
10/23/2020	ADDED GAR SVR DR & OPT EXT FAMILY
7/1/2020	UPDATED SHOWER OPTIONS
03/03/2020	ADDED BASEMENT FOUNDATIONS
	REVISION NUMBER

DAVIDSON HOMES
 3000 Blvd 19th St, Suite 100
 Minneapolis, MN 55425
 Main Street Design & Design, LLC
 1000 Main Street
 St. Paul, MN 55102

DAVIDSON HOMES
 YOUR COMPASSIONATE BUILDER

OPTION NO. ELEVATION - B
 PROJECT NUMBER 1ST FLOOR ELEC. PLAN
 RELEASE DATE 08-21-2019
 SCALE 1/8" = 1'-0"

MODEL	WILLOW
DRAWING TITLE	1ST FLOOR ELEC. PLAN
OPTION DESCRIPTION	ELEVATION - B
SHEET NO.	E-1.0B

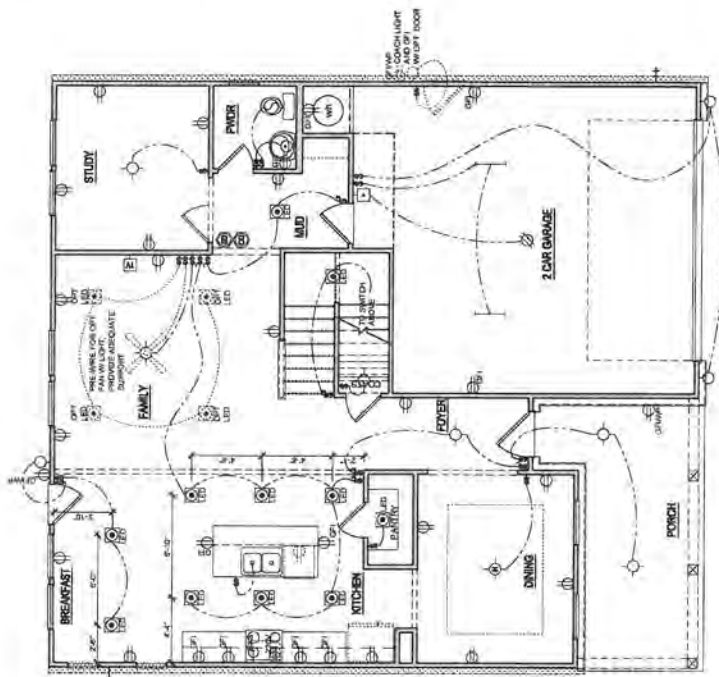

ELEVATION - B
 FIRST FLOOR ELECTRICAL PLAN
 SCALE 1/8" = 1'-0" (NOT TO SCALE)

ELECTRICAL KEY	
	CEILING RECEPT
	TOPPLER RECEPT
	SPUT SWITCHED RECEPT
	FLOOR RECEPT
	DUPLEX RECEPT
	GROUND FAULT RECEPT
	WEATHER PROOF RECEPT
	20A RECEPT
	EXHAUST FAN LIGHT
	EXHAUST FAN HEAT LIGHT
	LED
	WATER PROTECTED LIGHT
	CEILING LIGHT
	HANGING CEILING LIGHT
	WALL LIGHT
	WALL FLOOD LIGHT
	SINGLE SWITCH
	3-WAY SWITCH
	4-WAY SWITCH
	DIMMER SWITCH
	CABLE TV JACK
	PISTON
	PHONE JACK
	DIRECT WIRE
	SECURITY SYSTEM PHONE JACK
	SMOKE DETECTOR
	CARBON MONOXIDE DETECTOR
	ELECTRICAL PANEL
	DISCONNECT SWITCH
	ELECTRIC METER
	TYPE FLUORESCENT
	3 TUBE FLUORESCENT
	FLOOR LIGHT
	CHIMNEY
	CEILING FAN
	CEILING FAN W/ LIGHT

02/24/2022	PK WINDOW SIZE TO 2626 PX ON D
3/30/2021	REVISION TO WH & GARAGE DOORS
11/8/2020	ADD OPT PORCHS TO OPT FAMILY
10/23/2020	ADDED GYM SYS OR # OPT EXT FAMILY
7/1/2020	UPDATED SHOWN OPTIONS
03/05/2020	ADDED BASEMENT FOUNDATIONS
	REVISION NUMBER

DAVIDSON HOMES
 Your Community Builder
 10000 Davidson Blvd, Suite 3000
 Atlanta, GA 30328
 (404) 941-0222
 Home Sweet Homes of Georgia, LLC

OPTION NO.	OPTION DESCRIPTION
PROJECT NUMBER	PROJECT DESCRIPTION
RELEASE DATE	PROJECT NUMBER
1/8/21-0	08-21-2019

MODEL	ELEVATION - B
SHEET NO.	E-2.0B
DRAWING TITLE	SECOND FLOOR PLAN
PROJECT NUMBER	WILLOW

ELEVATION "A - C"

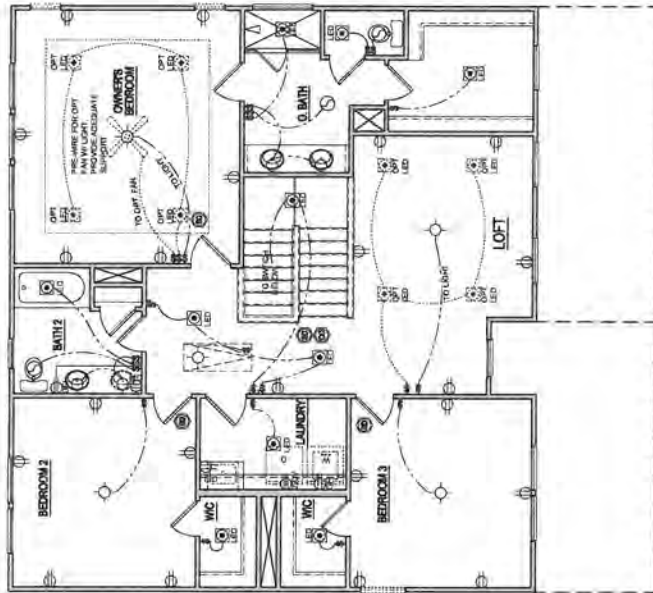

**ELEVATION - B
 SECOND FLOOR ELECTRICAL PLAN**
 SCALE: 1/8" = 1'-0" (SHEET SIZE)

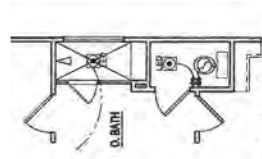

OPT. SPA SHOWER
 SCALE: 1/8" = 1'-0" (SHEET SIZE)

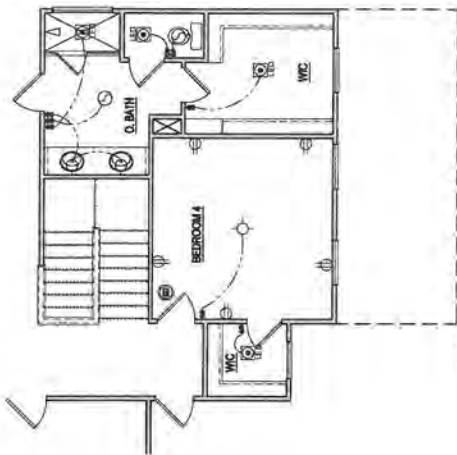

**ELEVATION 'B'
 OPT. BEDROOM 4 LAYOUT**
 SCALE: 1/8" = 1'-0" (SHEET SIZE)

SCALE NOTE:
LARGE PRINT FIGURES ARE TO SCALE AS NOTED.
IF A 1/4" PRINT IS NOTED, THE FIGURE IS TO SCALE AS NOTED.
IF A 1/8" PRINT IS NOTED, THE FIGURE IS TO SCALE AS NOTED.



1/3/2023

J.S. THOMPSON
ENGINEERING, INC.
605 WADSWORTH AVENUE, SUITE 100
FLAHERTY, NC 27631
N.C. LICENSE NO. CE133

WILLOW
DAVIDSON HOMES

THE FOLLOWING MATERIALS, DIMENSIONS AND NOTES
SHOULD BE USED UNLESS OTHERWISE NOTED
ON THE DRAWING.
1. DIMENSIONS SHALL BE AS SHOWN UNLESS OTHERWISE NOTED.
2. DIMENSIONS SHALL BE AS SHOWN UNLESS OTHERWISE NOTED.
3. DIMENSIONS SHALL BE AS SHOWN UNLESS OTHERWISE NOTED.
4. DIMENSIONS SHALL BE AS SHOWN UNLESS OTHERWISE NOTED.
5. DIMENSIONS SHALL BE AS SHOWN UNLESS OTHERWISE NOTED.
6. DIMENSIONS SHALL BE AS SHOWN UNLESS OTHERWISE NOTED.
7. DIMENSIONS SHALL BE AS SHOWN UNLESS OTHERWISE NOTED.
8. DIMENSIONS SHALL BE AS SHOWN UNLESS OTHERWISE NOTED.
9. DIMENSIONS SHALL BE AS SHOWN UNLESS OTHERWISE NOTED.
10. DIMENSIONS SHALL BE AS SHOWN UNLESS OTHERWISE NOTED.
11. DIMENSIONS SHALL BE AS SHOWN UNLESS OTHERWISE NOTED.
12. DIMENSIONS SHALL BE AS SHOWN UNLESS OTHERWISE NOTED.
13. DIMENSIONS SHALL BE AS SHOWN UNLESS OTHERWISE NOTED.
14. DIMENSIONS SHALL BE AS SHOWN UNLESS OTHERWISE NOTED.
15. DIMENSIONS SHALL BE AS SHOWN UNLESS OTHERWISE NOTED.
16. DIMENSIONS SHALL BE AS SHOWN UNLESS OTHERWISE NOTED.
17. DIMENSIONS SHALL BE AS SHOWN UNLESS OTHERWISE NOTED.
18. DIMENSIONS SHALL BE AS SHOWN UNLESS OTHERWISE NOTED.
19. DIMENSIONS SHALL BE AS SHOWN UNLESS OTHERWISE NOTED.
20. DIMENSIONS SHALL BE AS SHOWN UNLESS OTHERWISE NOTED.

STRUCTURAL NOTES:
1. ALL REINFORCING BARS SHALL BE 60,000 PSI YIELD STRENGTH.
2. ALL REINFORCING BARS SHALL BE 1/2" DIA. UNLESS OTHERWISE NOTED.
3. ALL REINFORCING BARS SHALL BE 1/4" DIA. UNLESS OTHERWISE NOTED.
4. ALL REINFORCING BARS SHALL BE 3/8" DIA. UNLESS OTHERWISE NOTED.
5. ALL REINFORCING BARS SHALL BE 1/2" DIA. UNLESS OTHERWISE NOTED.
6. ALL REINFORCING BARS SHALL BE 1/4" DIA. UNLESS OTHERWISE NOTED.
7. ALL REINFORCING BARS SHALL BE 3/8" DIA. UNLESS OTHERWISE NOTED.
8. ALL REINFORCING BARS SHALL BE 1/2" DIA. UNLESS OTHERWISE NOTED.
9. ALL REINFORCING BARS SHALL BE 1/4" DIA. UNLESS OTHERWISE NOTED.
10. ALL REINFORCING BARS SHALL BE 3/8" DIA. UNLESS OTHERWISE NOTED.
11. ALL REINFORCING BARS SHALL BE 1/2" DIA. UNLESS OTHERWISE NOTED.
12. ALL REINFORCING BARS SHALL BE 1/4" DIA. UNLESS OTHERWISE NOTED.
13. ALL REINFORCING BARS SHALL BE 3/8" DIA. UNLESS OTHERWISE NOTED.
14. ALL REINFORCING BARS SHALL BE 1/2" DIA. UNLESS OTHERWISE NOTED.
15. ALL REINFORCING BARS SHALL BE 1/4" DIA. UNLESS OTHERWISE NOTED.
16. ALL REINFORCING BARS SHALL BE 3/8" DIA. UNLESS OTHERWISE NOTED.
17. ALL REINFORCING BARS SHALL BE 1/2" DIA. UNLESS OTHERWISE NOTED.
18. ALL REINFORCING BARS SHALL BE 1/4" DIA. UNLESS OTHERWISE NOTED.
19. ALL REINFORCING BARS SHALL BE 3/8" DIA. UNLESS OTHERWISE NOTED.
20. ALL REINFORCING BARS SHALL BE 1/2" DIA. UNLESS OTHERWISE NOTED.

100% SHALL BE USED
SCALE 1/4" = 1'-0"
DATE 1/19/23
DRAWN BY J.S. THOMPSON
CHECKED BY J.S. THOMPSON

S.J.I.
STRUCTURAL ENGINEERING
100 W. 10TH ST. SUITE 100
RICHMOND, VA 23224

SCALE NOTE:
LARGE PRINT FRONT ARE TO SCALE AS NOTED.
IF 1/4" PRINTS ARE ONE HALF THE NOTED SCALE.



1/3/2023

J.S. THOMPSON
ENGINEERING, INC.
100 W. WILLOW AVE. SUITE 100
RALEIGH, NC 27603
TEL: 919.876.1111
FAX: 919.876.1112
N.C. LICENSE NO. 0173

WILLOW
DAVIDSON HOMES

DATE: JANUARY 1, 2023
SCALE: 1/4" = 1'-0"
DRAWN BY: J.S. THOMPSON
CHECKED BY: J.S. THOMPSON

S-318
BRANDED SHEET
FRANKLIN, MA

BRACED WALL DESIGN NOTES:

1. BRACED WALL DESIGN PER SECTION 905.4.1 OF THE IBC.
2. ALL BRACED WALLS SHALL BE CONSTRUCTED IN ACCORDANCE WITH THE IBC AND ALL APPLICABLE LOCAL CODES.
3. ALL BRACED WALLS SHALL BE CONSTRUCTED WITH 2x4 STUDS AND 2x6 BRACES. BRACES SHALL BE INSTALLED AT 4 FT ON CENTER AND SHALL BE FULLY BRACED TO THE FOUNDATION.
4. BRACED WALL DESIGN APPLIED TO ALL ZONES UP TO 10 FT HIGH. FOR HIGH RISE ZONES, BRACE WALLS ARE TO BE CONSTRUCTED IN ACCORDANCE WITH SECTION 905.4.2 OF THE IBC.
5. SEE NOTES AND DETAIL SHEETS FOR ADDITIONAL BRACED WALL INFORMATION.

BRACED WALL DESIGN

RECTANGLE A	RECTANGLE B
SIZE (H x W) (FOOT)	SIZE (H x W) (FOOT)
PERIOD (SECS)	PERIOD (SECS)
TOTAL PROVIDED LENGTH (FT)	TOTAL PROVIDED LENGTH (FT)
REQUIRED LENGTH (FT)	REQUIRED LENGTH (FT)
SIZE (H x W) (FOOT)	SIZE (H x W) (FOOT)
TOTAL PROVIDED LENGTH (FT)	TOTAL PROVIDED LENGTH (FT)
REQUIRED LENGTH (FT)	REQUIRED LENGTH (FT)
PERIOD (SECS)	PERIOD (SECS)
TOTAL PROVIDED LENGTH (FT)	TOTAL PROVIDED LENGTH (FT)
REQUIRED LENGTH (FT)	REQUIRED LENGTH (FT)
PERIOD (SECS)	PERIOD (SECS)
TOTAL PROVIDED LENGTH (FT)	TOTAL PROVIDED LENGTH (FT)
REQUIRED LENGTH (FT)	REQUIRED LENGTH (FT)

STRUCTURAL NOTES:

1. ALL BRACED WALLS TO BE 4x4 OR 4x6 OR 6x6 (NO. 1). ALL BRACED WALLS TO BE 4x4 OR 4x6 OR 6x6 (NO. 1).
2. ALL LONG BEARING WALLS TO BE 12" x 8" OR 12" x 10" OR 12" x 12" (NO. 1). ALL LONG BEARING WALLS TO BE 12" x 8" OR 12" x 10" OR 12" x 12" (NO. 1).
3. ALL WALLS SHALL BE FULLY BRACED TO THE FOUNDATION. ALL BRACED WALLS SHALL BE FULLY BRACED TO THE FOUNDATION.
4. ALL WALLS SHALL BE FULLY BRACED TO THE FOUNDATION. ALL BRACED WALLS SHALL BE FULLY BRACED TO THE FOUNDATION.
5. ALL WALLS SHALL BE FULLY BRACED TO THE FOUNDATION. ALL BRACED WALLS SHALL BE FULLY BRACED TO THE FOUNDATION.
6. ALL WALLS SHALL BE FULLY BRACED TO THE FOUNDATION. ALL BRACED WALLS SHALL BE FULLY BRACED TO THE FOUNDATION.
7. ALL WALLS SHALL BE FULLY BRACED TO THE FOUNDATION. ALL BRACED WALLS SHALL BE FULLY BRACED TO THE FOUNDATION.
8. ALL WALLS SHALL BE FULLY BRACED TO THE FOUNDATION. ALL BRACED WALLS SHALL BE FULLY BRACED TO THE FOUNDATION.
9. ALL WALLS SHALL BE FULLY BRACED TO THE FOUNDATION. ALL BRACED WALLS SHALL BE FULLY BRACED TO THE FOUNDATION.
10. ALL WALLS SHALL BE FULLY BRACED TO THE FOUNDATION. ALL BRACED WALLS SHALL BE FULLY BRACED TO THE FOUNDATION.

"TYP" INDICATES TYPICAL END POCKET BETWEEN JOISTS UNITS.

TABLE 1: NUMBER OF BRACED WALLS AT EACH END OF MEMBER IN EXTERIOR WALLS

MEMBER NO.	MEMBER TYPE	MEMBER LENGTH (FEET)	MEMBER HEIGHT (FEET)	MEMBER WIDTH (FEET)	MEMBER THICK (FEET)	MEMBER AREA (SQ FT)	MEMBER VOLUME (CU FT)
1	1	1	1	1	1	1	1
2	1	1	1	1	1	1	1
3	1	1	1	1	1	1	1
4	1	1	1	1	1	1	1
5	1	1	1	1	1	1	1
6	1	1	1	1	1	1	1
7	1	1	1	1	1	1	1
8	1	1	1	1	1	1	1
9	1	1	1	1	1	1	1
10	1	1	1	1	1	1	1

NOTE:
THIS TABLE IS FOR INFORMATION ONLY. THE NUMBER OF BRACED WALLS AT EACH END OF MEMBER IN EXTERIOR WALLS SHALL BE DETERMINED BY THE DESIGNER AND SHALL BE INDICATED ON THE PLANS.

SCALE NOTE
 DIMENSIONS ARE TO SCALE AS NOTED
 IF A 1/4" PRINT IS ONE HALF THE NOTED SCALE



1/3/2023

J.S. THOMPSON ENGINEERING, INC.
 2901 E. HIGHWAY 491, SUITE 100, KENNESAW, NC 28641
 NC LICENSE NO. C173

WILLOW
 DAVIDSON HOMES

DATE ISSUED: 1/30/23
 DATE: 1/27/23
 DRAWN BY: JST/STP/PLD
 PROJECT NO: 284

S-4a
 WILLOW
 STRUCTURAL

- BRANCHED WALL DESIGN NOTE:**
- BRANCHED WALL DESIGN REFERENCE INCLUDES THE NOSE OF THE WALL.
 - BRANCHED WALL DESIGN TO CONTAINERS AND TIES, AS SHOWN ON STRUCTURAL PANEL CONTRACTOR IS TO INSTALL 1/4" x 1/4" x 1/4" ON ALL EXTERIOR WALLS ATTACHED TO BRANCHED WALLS. BRANCHED WALLS SHALL BE CONSTRUCTED WITH 1/4" x 1/4" x 1/4" ON ALL EXTERIOR WALLS ATTACHED TO BRANCHED WALLS. BRANCHED WALLS SHALL BE CONSTRUCTED WITH 1/4" x 1/4" x 1/4" ON ALL EXTERIOR WALLS ATTACHED TO BRANCHED WALLS.
 - BRANCHED WALL DESIGN TO CONTAINERS AND TIES, AS SHOWN ON STRUCTURAL PANEL CONTRACTOR IS TO INSTALL 1/4" x 1/4" x 1/4" ON ALL EXTERIOR WALLS ATTACHED TO BRANCHED WALLS. BRANCHED WALLS SHALL BE CONSTRUCTED WITH 1/4" x 1/4" x 1/4" ON ALL EXTERIOR WALLS ATTACHED TO BRANCHED WALLS.
 - BRANCHED WALL DESIGN TO CONTAINERS AND TIES, AS SHOWN ON STRUCTURAL PANEL CONTRACTOR IS TO INSTALL 1/4" x 1/4" x 1/4" ON ALL EXTERIOR WALLS ATTACHED TO BRANCHED WALLS. BRANCHED WALLS SHALL BE CONSTRUCTED WITH 1/4" x 1/4" x 1/4" ON ALL EXTERIOR WALLS ATTACHED TO BRANCHED WALLS.
 - BRANCHED WALL DESIGN TO CONTAINERS AND TIES, AS SHOWN ON STRUCTURAL PANEL CONTRACTOR IS TO INSTALL 1/4" x 1/4" x 1/4" ON ALL EXTERIOR WALLS ATTACHED TO BRANCHED WALLS. BRANCHED WALLS SHALL BE CONSTRUCTED WITH 1/4" x 1/4" x 1/4" ON ALL EXTERIOR WALLS ATTACHED TO BRANCHED WALLS.

- NOTE:**
- FOR ALL WALLS, THE POINT OF THE BRANCHED WALL SHALL BE THE POINT OF THE BRANCHED WALL. THE POINT OF THE BRANCHED WALL SHALL BE THE POINT OF THE BRANCHED WALL.
 - FOR ALL WALLS, THE POINT OF THE BRANCHED WALL SHALL BE THE POINT OF THE BRANCHED WALL. THE POINT OF THE BRANCHED WALL SHALL BE THE POINT OF THE BRANCHED WALL.

- STRUCTURAL NOTES:**
- ALL BRANCHED WALLS TO BE 8" SIP ON 8" SIP (N/A)
 - ALL LOAD BEARING MEMBERS TO BE SUPPORTED BY FOUNDATION. WALLS TO BE SUPPORTED BY FOUNDATION. WALLS TO BE SUPPORTED BY FOUNDATION.
 - WALLS AND DOOR HEADS TO BE SUPPORTED BY FOUNDATION. WALLS TO BE SUPPORTED BY FOUNDATION. WALLS TO BE SUPPORTED BY FOUNDATION.
 - WALLS AND DOOR HEADS TO BE SUPPORTED BY FOUNDATION. WALLS TO BE SUPPORTED BY FOUNDATION. WALLS TO BE SUPPORTED BY FOUNDATION.
 - WALLS AND DOOR HEADS TO BE SUPPORTED BY FOUNDATION. WALLS TO BE SUPPORTED BY FOUNDATION. WALLS TO BE SUPPORTED BY FOUNDATION.
 - WALLS AND DOOR HEADS TO BE SUPPORTED BY FOUNDATION. WALLS TO BE SUPPORTED BY FOUNDATION. WALLS TO BE SUPPORTED BY FOUNDATION.
 - WALLS AND DOOR HEADS TO BE SUPPORTED BY FOUNDATION. WALLS TO BE SUPPORTED BY FOUNDATION. WALLS TO BE SUPPORTED BY FOUNDATION.
 - WALLS AND DOOR HEADS TO BE SUPPORTED BY FOUNDATION. WALLS TO BE SUPPORTED BY FOUNDATION. WALLS TO BE SUPPORTED BY FOUNDATION.
 - WALLS AND DOOR HEADS TO BE SUPPORTED BY FOUNDATION. WALLS TO BE SUPPORTED BY FOUNDATION. WALLS TO BE SUPPORTED BY FOUNDATION.
 - WALLS AND DOOR HEADS TO BE SUPPORTED BY FOUNDATION. WALLS TO BE SUPPORTED BY FOUNDATION. WALLS TO BE SUPPORTED BY FOUNDATION.

TABLE REACTS

NUMBER OF FULL-HEIGHT STUDS AT EACH END OF MEMBER IN EXTERIOR WALLS

MEMBER NO.	TABLE REACTS
1	3
2	3
3	3
4	3
5	3
6	3
7	3
8	3
9	3
10	3
11	3
12	3
13	3
14	3
15	3
16	3
17	3
18	3
19	3
20	3
21	3
22	3
23	3
24	3
25	3
26	3
27	3
28	3
29	3
30	3
31	3
32	3
33	3
34	3
35	3
36	3
37	3
38	3
39	3
40	3
41	3
42	3
43	3
44	3
45	3
46	3
47	3
48	3
49	3
50	3
51	3
52	3
53	3
54	3
55	3
56	3
57	3
58	3
59	3
60	3
61	3
62	3
63	3
64	3
65	3
66	3
67	3
68	3
69	3
70	3
71	3
72	3
73	3
74	3
75	3
76	3
77	3
78	3
79	3
80	3
81	3
82	3
83	3
84	3
85	3
86	3
87	3
88	3
89	3
90	3
91	3
92	3
93	3
94	3
95	3
96	3
97	3
98	3
99	3
100	3

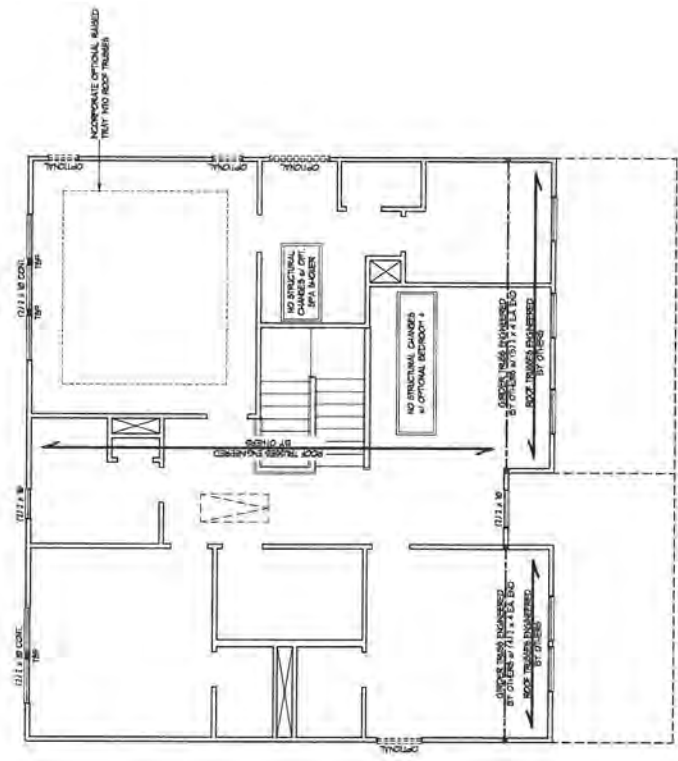

ELEVATION B

SCALE NOTE:
 DIMENSIONS ARE TO SCALE AS NOTED.
 1/4" = 1'-0" POINTS ARE ONE HALF THE NOTED SCALE.



1/3/2023

I.S. THOMPSON
ENGINEERING, INC.
 4500 N. SHELBY ST. SUITE 100
 CARRIEDBORO, N.C. 27514
 PHONE: (919) 368-1234
 FAX: (919) 368-1235
 N.C. LICENSE NO. 01713

- STRUCTURAL NOTES:
1. ALL TRAPPING NUMBERS TO BE 9" UNLESS NOTED OTHERWISE.
 2. ROOF TRAP LAYOUT AS SHOWN.
 3. HAVEN FLAT VALLEYS TO BE 2" X 4" UNLESS NOTED OTHERWISE. HAVEN FLAT VALLEYS TO BE 2" X 4" UNLESS NOTED OTHERWISE.
 4. REFER TO SECTION A6001 OF THE DRAWINGS FOR HAVEN FLAT VALLEY DETAIL.
 5. REFER TO NOTES AND DETAIL DRAWINGS FOR HAVEN FLAT VALLEY INFORMATION.

WILLOW
 DAVIDSON HOMES

DATE: 1/3/2023
DRAWN BY: ZACH
CHECKED BY: ZACH
PROJECT: 23-001

S-31a
 ROOF TRAPPING PLAN

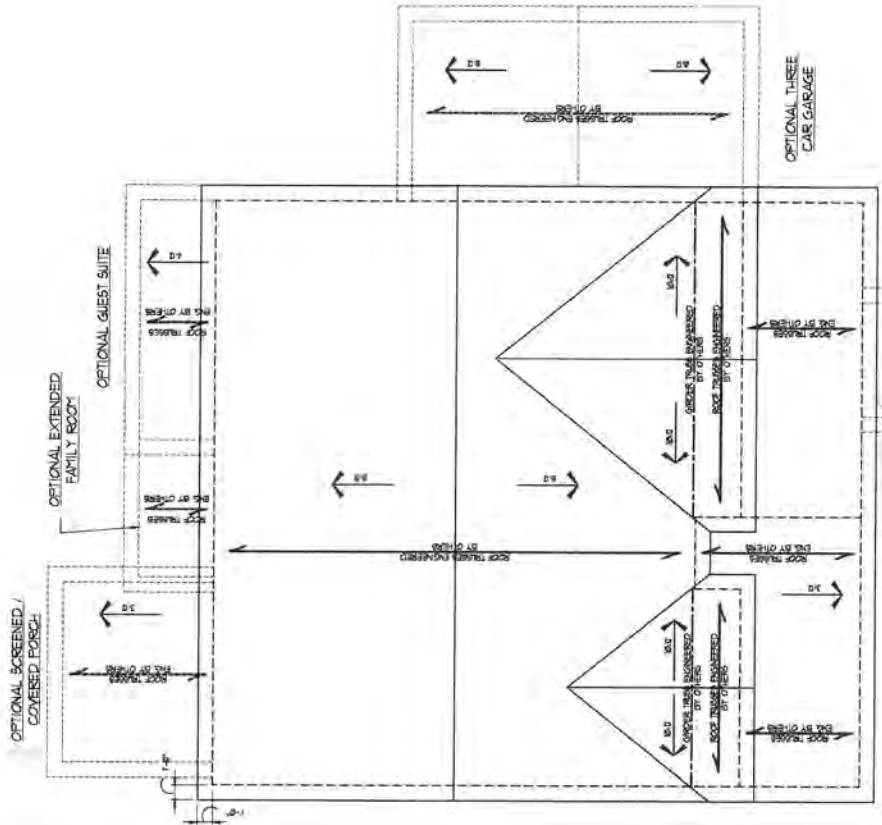

OPTIONAL SCREENED / COVERED PORCH
 6'-0" x 6'-0" x 6'-0" x 6'-0" x 6'-0" x 6'-0"
 6'-0" x 6'-0" x 6'-0" x 6'-0" x 6'-0" x 6'-0"
 6'-0" x 6'-0" x 6'-0" x 6'-0" x 6'-0" x 6'-0"

ELEVATION B

GENERAL WALL BRACING NOTES:

1. WALL BRACING SYSTEMS IN ACCORDANCE WITH CHAPTER 6 OF THE 2021 NC RESIDENTIAL BUILDING CODE (RBC).
2. SEE THE PLAN FOR GENERAL DETAILS. REFER TO THE 2021 RBC FOR ADDITIONAL INFORMATION AS NEEDED.
3. BRACING SYSTEMS SHALL BE INSTALLED IN ACCORDANCE WITH THE 2021 RBC FOR ADDITIONAL INFORMATION AS NEEDED.
4. ALL BRACING SYSTEMS SHALL BE INSTALLED IN ACCORDANCE WITH THE 2021 RBC FOR ADDITIONAL INFORMATION AS NEEDED.
5. ALL BRACING SYSTEMS SHALL BE INSTALLED IN ACCORDANCE WITH THE 2021 RBC FOR ADDITIONAL INFORMATION AS NEEDED.
6. ALL BRACING SYSTEMS SHALL BE INSTALLED IN ACCORDANCE WITH THE 2021 RBC FOR ADDITIONAL INFORMATION AS NEEDED.
7. ALL BRACING SYSTEMS SHALL BE INSTALLED IN ACCORDANCE WITH THE 2021 RBC FOR ADDITIONAL INFORMATION AS NEEDED.
8. ALL BRACING SYSTEMS SHALL BE INSTALLED IN ACCORDANCE WITH THE 2021 RBC FOR ADDITIONAL INFORMATION AS NEEDED.
9. ALL BRACING SYSTEMS SHALL BE INSTALLED IN ACCORDANCE WITH THE 2021 RBC FOR ADDITIONAL INFORMATION AS NEEDED.
10. ALL BRACING SYSTEMS SHALL BE INSTALLED IN ACCORDANCE WITH THE 2021 RBC FOR ADDITIONAL INFORMATION AS NEEDED.

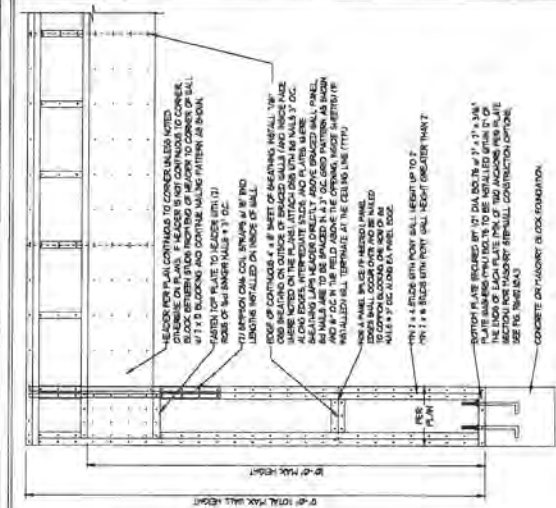

METHOD FF-PORTAL FRAME DETAIL ①

OVER RAISED WOOD FLOOR - BRACING, ANCHOR OPTION
 - 1\"/>

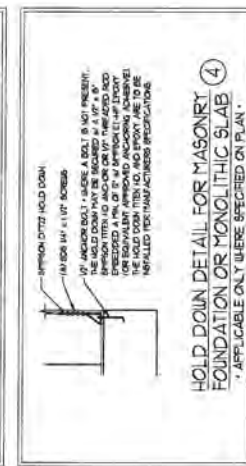
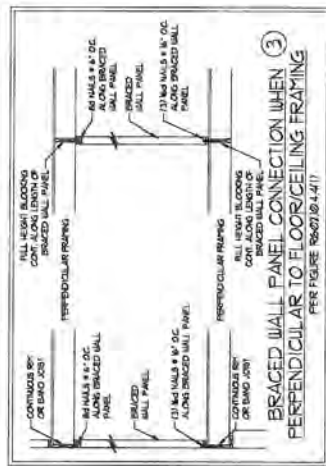
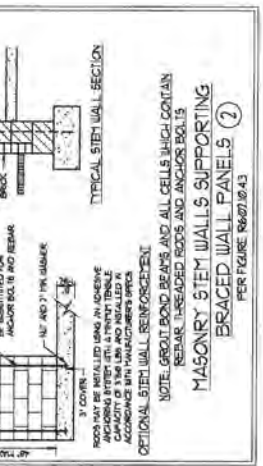
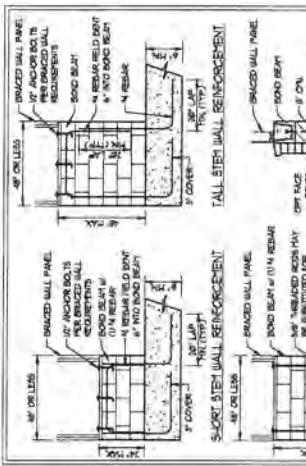

HOLD DOWN DETAIL FOR MASONRY FOUNDATION OR MONOLITHIC SLAB (4)
 - APPLICABLE ONLY WHERE SPECIFIED ON PLAN.

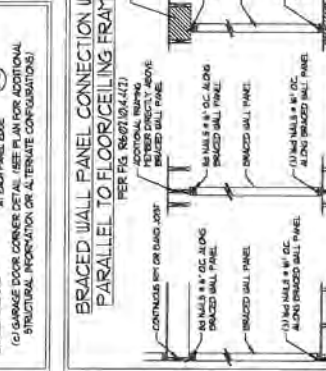
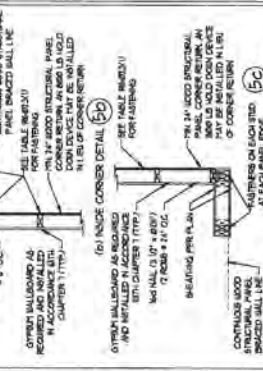
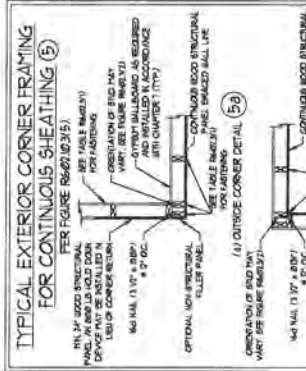

BRACED WALL PANEL CONNECTION TO PERPENDICULAR ROOF TRUSSES (9)
 (OR ALTERNATIVE FIGURE R607.10.4(2))

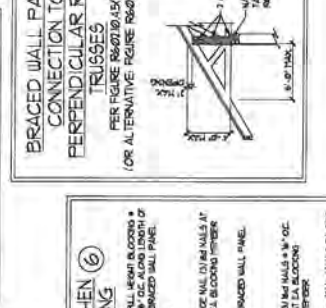
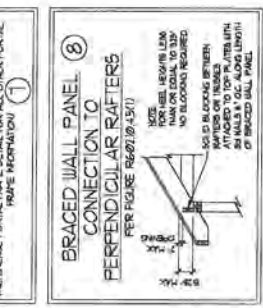
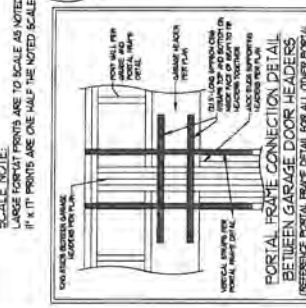

BRACED WALL PANEL CONNECTION TO PERPENDICULAR RAFTERS (8)
 PER FIGURE R607.10.4(1)

J.S. THOMPSON ENGINEERING, INC.
 800 W. WILLOW STREET, SUITE 100, WILLOW, NC 27178
 P: 704.255.1111 FAX: 704.255.1112
 LICENSE NO. 01723

WILLOW DAVIDSON HOMES

WILLOW DAVIDSON HOMES

H. CARROLL HAYES ENGINEERS ARCHITECTS
 52324
 1/3/2023

D4
 ALL AND CONC.
 NOTED DETAILS

SCALE NOTE
 ALL DIMENSIONS ARE TO SCALE UNLESS NOTED
 1/4" = 1'-0" FOR ALL DIMENSIONS UNLESS NOTED OTHERWISE (IND.)

FRAMING NOTES

- ALL WALLS SHALL BE 8" CMU WITH 1/2" REINFORCING BARS AT 16" ON CENTER. ALL REINFORCING BARS SHALL BE #4 UNLESS OTHERWISE NOTED OTHERWISE (IND.)
- UNFINISHED INTERIORS SHALL HAVE THE FOLLOWING FINISH PROPERTIES: 1/2" GYPSUM BOARD ON 2x4 STUDS @ 16" ON CENTER. FINISH SHALL BE 5/8" GYPSUM BOARD ON 2x4 STUDS @ 16" ON CENTER. UNLESS OTHERWISE NOTED OTHERWISE (IND.)
- UNFINISHED EXTERIORS SHALL HAVE THE FOLLOWING FINISH PROPERTIES: 1/2" GYPSUM BOARD ON 2x4 STUDS @ 16" ON CENTER. FINISH SHALL BE 5/8" GYPSUM BOARD ON 2x4 STUDS @ 16" ON CENTER. UNLESS OTHERWISE NOTED OTHERWISE (IND.)
- ALL CONNECTIONS SHALL BE MADE IN ACCORDANCE WITH THE MANUFACTURER'S SPECIFICATIONS.

- STRUCTURAL STEEL SHALL CONFORM TO THE FOLLOWING ASTM SPECIFICATIONS:
 - A. CHANNELS AND ANGLES: ASTM A992
 - B. CHANNELS AND BARS: ASTM A36
 - C. PLATES AND BARS: ASTM A36
 - D. HOLLOW STRUCTURAL SECTIONS: ASTM A500 GRADE B
 - E. STEEL PIPE: ASTM A53 GRADE B, TYPE E OR S

- STEEL BEAMS SHALL BE SUPPORTED AT EACH END WITH A MINIMUM BEARING LENGTH OF 3'-0" AND SHALL BE PLACED WITHIN 1/4" OF THE END OF THE BEARING SURFACE. BEAMS SHALL BE ATTACHED AT THE BOTTOM FLANGE TO EACH SUPPORT AS FOLLOWS (IND.):
 - A. WOOD FRAMING: (1) 1/2" DIA. x 4" LONG LAG SCREWS
 - B. CONCRETE: (1) 1/2" DIA. x 4" WEDGE ANCHORS
 - C. MASONRY (FULLY GROUTED): (1) 1/2" DIA. x 4" LONG SIMPSON TITEN-10 ANCHORS

- ALL LOAD BEARING MEMBERS SHALL BE CONSIDERED PROVIDING THE JOINTS ARE TO BE MAILED TO THE 3/4" WELDER ON TOP OF THE STEEL BEAM, AND THE WELDER IS TO BE MAILED TO THE 3/4" WELDER ON EACH END OF THE STEEL BEAM. (1) RODS OF SELF-TAPPING SCREWS #8 @ 12" ON CENTER OR (2) RODS OF 1/2" DIAMETER BOLT #8 @ 12" ON CENTER ARE USED TO FASTEN THE WELDER. THE STEEL BEAM SHALL BE FABRICATED WITH RODS OF 3/4" DIAMETER WELDER #8 @ 12" ON CENTER.

- MAINTAIN CLEARANCE FROM ALL OBSTRUCTIONS TO SUPPORTS TO MAINTAIN UNOBSTRUCTED PASSAGE OF AIR AND WATER. PROVIDE SLOPED DRAINAGE FROM ABOVE WHICH REQUIRE SOLID BLOCKING TO SUPPORTS TO MAINTAIN UNOBSTRUCTED PASSAGE OF AIR AND WATER.

- ALL LOAD BEARING MEMBERS SHALL BE CONSIDERED PROVIDING THE JOINTS ARE TO BE MAILED TO THE 3/4" WELDER ON TOP OF THE STEEL BEAM, AND THE WELDER IS TO BE MAILED TO THE 3/4" WELDER ON EACH END OF THE STEEL BEAM. (1) RODS OF SELF-TAPPING SCREWS #8 @ 12" ON CENTER OR (2) RODS OF 1/2" DIAMETER BOLT #8 @ 12" ON CENTER ARE USED TO FASTEN THE WELDER. THE STEEL BEAM SHALL BE FABRICATED WITH RODS OF 3/4" DIAMETER WELDER #8 @ 12" ON CENTER.

- ALL LOAD BEARING MEMBERS SHALL BE CONSIDERED PROVIDING THE JOINTS ARE TO BE MAILED TO THE 3/4" WELDER ON TOP OF THE STEEL BEAM, AND THE WELDER IS TO BE MAILED TO THE 3/4" WELDER ON EACH END OF THE STEEL BEAM. (1) RODS OF SELF-TAPPING SCREWS #8 @ 12" ON CENTER OR (2) RODS OF 1/2" DIAMETER BOLT #8 @ 12" ON CENTER ARE USED TO FASTEN THE WELDER. THE STEEL BEAM SHALL BE FABRICATED WITH RODS OF 3/4" DIAMETER WELDER #8 @ 12" ON CENTER.

- ALL LOAD BEARING MEMBERS SHALL BE CONSIDERED PROVIDING THE JOINTS ARE TO BE MAILED TO THE 3/4" WELDER ON TOP OF THE STEEL BEAM, AND THE WELDER IS TO BE MAILED TO THE 3/4" WELDER ON EACH END OF THE STEEL BEAM. (1) RODS OF SELF-TAPPING SCREWS #8 @ 12" ON CENTER OR (2) RODS OF 1/2" DIAMETER BOLT #8 @ 12" ON CENTER ARE USED TO FASTEN THE WELDER. THE STEEL BEAM SHALL BE FABRICATED WITH RODS OF 3/4" DIAMETER WELDER #8 @ 12" ON CENTER.

- ALL LOAD BEARING MEMBERS SHALL BE CONSIDERED PROVIDING THE JOINTS ARE TO BE MAILED TO THE 3/4" WELDER ON TOP OF THE STEEL BEAM, AND THE WELDER IS TO BE MAILED TO THE 3/4" WELDER ON EACH END OF THE STEEL BEAM. (1) RODS OF SELF-TAPPING SCREWS #8 @ 12" ON CENTER OR (2) RODS OF 1/2" DIAMETER BOLT #8 @ 12" ON CENTER ARE USED TO FASTEN THE WELDER. THE STEEL BEAM SHALL BE FABRICATED WITH RODS OF 3/4" DIAMETER WELDER #8 @ 12" ON CENTER.

- ALL LOAD BEARING MEMBERS SHALL BE CONSIDERED PROVIDING THE JOINTS ARE TO BE MAILED TO THE 3/4" WELDER ON TOP OF THE STEEL BEAM, AND THE WELDER IS TO BE MAILED TO THE 3/4" WELDER ON EACH END OF THE STEEL BEAM. (1) RODS OF SELF-TAPPING SCREWS #8 @ 12" ON CENTER OR (2) RODS OF 1/2" DIAMETER BOLT #8 @ 12" ON CENTER ARE USED TO FASTEN THE WELDER. THE STEEL BEAM SHALL BE FABRICATED WITH RODS OF 3/4" DIAMETER WELDER #8 @ 12" ON CENTER.

- ALL LOAD BEARING MEMBERS SHALL BE CONSIDERED PROVIDING THE JOINTS ARE TO BE MAILED TO THE 3/4" WELDER ON TOP OF THE STEEL BEAM, AND THE WELDER IS TO BE MAILED TO THE 3/4" WELDER ON EACH END OF THE STEEL BEAM. (1) RODS OF SELF-TAPPING SCREWS #8 @ 12" ON CENTER OR (2) RODS OF 1/2" DIAMETER BOLT #8 @ 12" ON CENTER ARE USED TO FASTEN THE WELDER. THE STEEL BEAM SHALL BE FABRICATED WITH RODS OF 3/4" DIAMETER WELDER #8 @ 12" ON CENTER.

- ALL LOAD BEARING MEMBERS SHALL BE CONSIDERED PROVIDING THE JOINTS ARE TO BE MAILED TO THE 3/4" WELDER ON TOP OF THE STEEL BEAM, AND THE WELDER IS TO BE MAILED TO THE 3/4" WELDER ON EACH END OF THE STEEL BEAM. (1) RODS OF SELF-TAPPING SCREWS #8 @ 12" ON CENTER OR (2) RODS OF 1/2" DIAMETER BOLT #8 @ 12" ON CENTER ARE USED TO FASTEN THE WELDER. THE STEEL BEAM SHALL BE FABRICATED WITH RODS OF 3/4" DIAMETER WELDER #8 @ 12" ON CENTER.

- ALL LOAD BEARING MEMBERS SHALL BE CONSIDERED PROVIDING THE JOINTS ARE TO BE MAILED TO THE 3/4" WELDER ON TOP OF THE STEEL BEAM, AND THE WELDER IS TO BE MAILED TO THE 3/4" WELDER ON EACH END OF THE STEEL BEAM. (1) RODS OF SELF-TAPPING SCREWS #8 @ 12" ON CENTER OR (2) RODS OF 1/2" DIAMETER BOLT #8 @ 12" ON CENTER ARE USED TO FASTEN THE WELDER. THE STEEL BEAM SHALL BE FABRICATED WITH RODS OF 3/4" DIAMETER WELDER #8 @ 12" ON CENTER.

- ALL LOAD BEARING MEMBERS SHALL BE CONSIDERED PROVIDING THE JOINTS ARE TO BE MAILED TO THE 3/4" WELDER ON TOP OF THE STEEL BEAM, AND THE WELDER IS TO BE MAILED TO THE 3/4" WELDER ON EACH END OF THE STEEL BEAM. (1) RODS OF SELF-TAPPING SCREWS #8 @ 12" ON CENTER OR (2) RODS OF 1/2" DIAMETER BOLT #8 @ 12" ON CENTER ARE USED TO FASTEN THE WELDER. THE STEEL BEAM SHALL BE FABRICATED WITH RODS OF 3/4" DIAMETER WELDER #8 @ 12" ON CENTER.

- ALL LOAD BEARING MEMBERS SHALL BE CONSIDERED PROVIDING THE JOINTS ARE TO BE MAILED TO THE 3/4" WELDER ON TOP OF THE STEEL BEAM, AND THE WELDER IS TO BE MAILED TO THE 3/4" WELDER ON EACH END OF THE STEEL BEAM. (1) RODS OF SELF-TAPPING SCREWS #8 @ 12" ON CENTER OR (2) RODS OF 1/2" DIAMETER BOLT #8 @ 12" ON CENTER ARE USED TO FASTEN THE WELDER. THE STEEL BEAM SHALL BE FABRICATED WITH RODS OF 3/4" DIAMETER WELDER #8 @ 12" ON CENTER.

- ALL LOAD BEARING MEMBERS SHALL BE CONSIDERED PROVIDING THE JOINTS ARE TO BE MAILED TO THE 3/4" WELDER ON TOP OF THE STEEL BEAM, AND THE WELDER IS TO BE MAILED TO THE 3/4" WELDER ON EACH END OF THE STEEL BEAM. (1) RODS OF SELF-TAPPING SCREWS #8 @ 12" ON CENTER OR (2) RODS OF 1/2" DIAMETER BOLT #8 @ 12" ON CENTER ARE USED TO FASTEN THE WELDER. THE STEEL BEAM SHALL BE FABRICATED WITH RODS OF 3/4" DIAMETER WELDER #8 @ 12" ON CENTER.

- ALL LOAD BEARING MEMBERS SHALL BE CONSIDERED PROVIDING THE JOINTS ARE TO BE MAILED TO THE 3/4" WELDER ON TOP OF THE STEEL BEAM, AND THE WELDER IS TO BE MAILED TO THE 3/4" WELDER ON EACH END OF THE STEEL BEAM. (1) RODS OF SELF-TAPPING SCREWS #8 @ 12" ON CENTER OR (2) RODS OF 1/2" DIAMETER BOLT #8 @ 12" ON CENTER ARE USED TO FASTEN THE WELDER. THE STEEL BEAM SHALL BE FABRICATED WITH RODS OF 3/4" DIAMETER WELDER #8 @ 12" ON CENTER.

- ALL LOAD BEARING MEMBERS SHALL BE CONSIDERED PROVIDING THE JOINTS ARE TO BE MAILED TO THE 3/4" WELDER ON TOP OF THE STEEL BEAM, AND THE WELDER IS TO BE MAILED TO THE 3/4" WELDER ON EACH END OF THE STEEL BEAM. (1) RODS OF SELF-TAPPING SCREWS #8 @ 12" ON CENTER OR (2) RODS OF 1/2" DIAMETER BOLT #8 @ 12" ON CENTER ARE USED TO FASTEN THE WELDER. THE STEEL BEAM SHALL BE FABRICATED WITH RODS OF 3/4" DIAMETER WELDER #8 @ 12" ON CENTER.

- ALL LOAD BEARING MEMBERS SHALL BE CONSIDERED PROVIDING THE JOINTS ARE TO BE MAILED TO THE 3/4" WELDER ON TOP OF THE STEEL BEAM, AND THE WELDER IS TO BE MAILED TO THE 3/4" WELDER ON EACH END OF THE STEEL BEAM. (1) RODS OF SELF-TAPPING SCREWS #8 @ 12" ON CENTER OR (2) RODS OF 1/2" DIAMETER BOLT #8 @ 12" ON CENTER ARE USED TO FASTEN THE WELDER. THE STEEL BEAM SHALL BE FABRICATED WITH RODS OF 3/4" DIAMETER WELDER #8 @ 12" ON CENTER.

- ALL LOAD BEARING MEMBERS SHALL BE CONSIDERED PROVIDING THE JOINTS ARE TO BE MAILED TO THE 3/4" WELDER ON TOP OF THE STEEL BEAM, AND THE WELDER IS TO BE MAILED TO THE 3/4" WELDER ON EACH END OF THE STEEL BEAM. (1) RODS OF SELF-TAPPING SCREWS #8 @ 12" ON CENTER OR (2) RODS OF 1/2" DIAMETER BOLT #8 @ 12" ON CENTER ARE USED TO FASTEN THE WELDER. THE STEEL BEAM SHALL BE FABRICATED WITH RODS OF 3/4" DIAMETER WELDER #8 @ 12" ON CENTER.

GENERAL NOTES

- ENGINEER SEAL APPLIES ONLY TO STRUCTURAL COMPONENTS INCLUDING ROOF BRACINGS, WALLS, VALLETS, RIDGES, E-GOBS, WALLS, BEAMS, JOISTS, COLLARS, CANTILEVERS, OFFSET LOAD BEARING WALLS, PERMS, ROOFER SYSTEMS, AND FOOTING. ENGINEER SEAL DOES NOT CERTIFY DEFENSIBLE ACCURACY OF ARCHITECTURAL LAYOUT INCLUDING ROOF. ENGINEER SEAL DOES NOT APPLY TO L-BOARDS OR FLOOR/ROOF TRUSSES LAYOUT DESIGN AND ACCURACY.

- ALL CONSTRUCTION SHALL CONFORM TO THE LATEST REQUIREMENTS OF THE NORTH CAROLINA RESIDENTIAL CODE (NCCIRC) 2018 EDITION PLUS LOCAL ORDINANCES. THE STRUCTURAL ENGINEER IS NOT RESPONSIBLE FOR AND WILL NOT HAVE CONTROL OF CONSTRUCTION WORK. PERMS, TOLERANCES, SCHEDULES, AND OTHER REQUIREMENTS IN CONNECTION WITH THE CONSTRUCTION SHALL BE THE RESPONSIBILITY OF THE CONTRACTOR. FAILURE TO COMPLY WITH THE CONSTRUCTION WORK IN ACCORDANCE WITH THE CONTRACT DOCUMENTS.

- STRUCTURAL DESIGN BASED ON THE PROVISIONS OF THE NCCIRC 2018 EDITION (TABLE 1 - ROOF):

DESIGN CRITERIA	LIVE LOAD (PSF)	DEAD LOAD (PSF)	DEFLECTION (IN)
ATTIC WITH LIMITED STORAGE	20	10	L/360 (UNLESS OTHERWISE FINISHED)
ATTIC WITHOUT STORAGE	10	10	L/360
DECK	40	10	L/360
EXTERIOR BALCONIES	40	10	L/360
FIRE ESCAPES	40	10	L/360
HANDICAPPED MATERIALS	200 LB OR 30 (F.U.)	10	L/360
PASSENGER VEHICLE GARAGE	50	10	L/360
ROOFS OTHER THAN SLEEPING ROOF	40	10	L/360
SLEEPING ROOFS	30	10	L/360
WIND LOAD	(BASED ON TABLE 603.2(4) WIND ZONE AND EXPOSURE)		L/360
GROUND SNOW LOAD (PS)	30 (PSF)		

- 1- FLOOR TRUSSES DEBRASSED WITH 8" PER DEAD LOAD AND DEFLECTION (IN) OF L/360
- 2- FLOOR TRUSSES DEBRASSED WITH 15" PER DEAD LOAD

- FOR IS AND 100 MPH WIND ZONES, FOUNDATION ANCHORAGE IS TO COMPLY WITH SECTION 606.1 OF THE NCCIRC 2018 EDITION. FOR 120 MPH, 140 MPH, AND 160 MPH WIND ZONES, FOUNDATION ANCHORAGE IS TO COMPLY WITH SECTION 606.2 OF THE NCCIRC 2018 EDITION.

- ENERGY EFFICIENCY COMPLIANCE AND INSULATION VALUES OF THE BUILDING TO BE IN ACCORDANCE WITH CHAPTER 8 OF THE NCCIRC 2018 EDITION.

FOOTING AND FOUNDATION NOTES

- FOUNDATION DESIGN BASED ON A MINIMUM ALLOWABLE BEARING CAPACITY OF 2000 PSF. CONTACT GEOTECHNICAL ENGINEER IF BEARING CAPACITY IS NOT ACHIEVED.

- FOR ALL CONCRETE SLABS AND FOOTINGS, THE AREA WITHIN THE FOOTPRINT OF THE BUILDING ENVELOPE SHALL HAVE ALL VEGETATION, TOP SOIL, AND FERTILIZER REMOVED. FILL MATERIAL SHALL BE FREE OF VEGETATION AND FOREIGN MATERIAL. THE FILL SHALL BE COMPACTED TO THE PROPOSED FINISH GRADE. ALL EXPOSED SURFACES SHALL BE FINISHED WITH A FINISH THAT IS ACCEPTABLE TO THE OWNER. ALL EXPOSED SURFACES SHALL BE FINISHED WITH A FINISH THAT IS ACCEPTABLE TO THE OWNER.

- FOR ALL CONCRETE SLABS AND FOOTINGS, THE AREA WITHIN THE FOOTPRINT OF THE BUILDING ENVELOPE SHALL HAVE ALL VEGETATION, TOP SOIL, AND FERTILIZER REMOVED. FILL MATERIAL SHALL BE FREE OF VEGETATION AND FOREIGN MATERIAL. THE FILL SHALL BE COMPACTED TO THE PROPOSED FINISH GRADE. ALL EXPOSED SURFACES SHALL BE FINISHED WITH A FINISH THAT IS ACCEPTABLE TO THE OWNER. ALL EXPOSED SURFACES SHALL BE FINISHED WITH A FINISH THAT IS ACCEPTABLE TO THE OWNER.

- FOR ALL CONCRETE SLABS AND FOOTINGS, THE AREA WITHIN THE FOOTPRINT OF THE BUILDING ENVELOPE SHALL HAVE ALL VEGETATION, TOP SOIL, AND FERTILIZER REMOVED. FILL MATERIAL SHALL BE FREE OF VEGETATION AND FOREIGN MATERIAL. THE FILL SHALL BE COMPACTED TO THE PROPOSED FINISH GRADE. ALL EXPOSED SURFACES SHALL BE FINISHED WITH A FINISH THAT IS ACCEPTABLE TO THE OWNER. ALL EXPOSED SURFACES SHALL BE FINISHED WITH A FINISH THAT IS ACCEPTABLE TO THE OWNER.

- FOR ALL CONCRETE SLABS AND FOOTINGS, THE AREA WITHIN THE FOOTPRINT OF THE BUILDING ENVELOPE SHALL HAVE ALL VEGETATION, TOP SOIL, AND FERTILIZER REMOVED. FILL MATERIAL SHALL BE FREE OF VEGETATION AND FOREIGN MATERIAL. THE FILL SHALL BE COMPACTED TO THE PROPOSED FINISH GRADE. ALL EXPOSED SURFACES SHALL BE FINISHED WITH A FINISH THAT IS ACCEPTABLE TO THE OWNER. ALL EXPOSED SURFACES SHALL BE FINISHED WITH A FINISH THAT IS ACCEPTABLE TO THE OWNER.

- FOR ALL CONCRETE SLABS AND FOOTINGS, THE AREA WITHIN THE FOOTPRINT OF THE BUILDING ENVELOPE SHALL HAVE ALL VEGETATION, TOP SOIL, AND FERTILIZER REMOVED. FILL MATERIAL SHALL BE FREE OF VEGETATION AND FOREIGN MATERIAL. THE FILL SHALL BE COMPACTED TO THE PROPOSED FINISH GRADE. ALL EXPOSED SURFACES SHALL BE FINISHED WITH A FINISH THAT IS ACCEPTABLE TO THE OWNER. ALL EXPOSED SURFACES SHALL BE FINISHED WITH A FINISH THAT IS ACCEPTABLE TO THE OWNER.

- FOR ALL CONCRETE SLABS AND FOOTINGS, THE AREA WITHIN THE FOOTPRINT OF THE BUILDING ENVELOPE SHALL HAVE ALL VEGETATION, TOP SOIL, AND FERTILIZER REMOVED. FILL MATERIAL SHALL BE FREE OF VEGETATION AND FOREIGN MATERIAL. THE FILL SHALL BE COMPACTED TO THE PROPOSED FINISH GRADE. ALL EXPOSED SURFACES SHALL BE FINISHED WITH A FINISH THAT IS ACCEPTABLE TO THE OWNER. ALL EXPOSED SURFACES SHALL BE FINISHED WITH A FINISH THAT IS ACCEPTABLE TO THE OWNER.

- FOR ALL CONCRETE SLABS AND FOOTINGS, THE AREA WITHIN THE FOOTPRINT OF THE BUILDING ENVELOPE SHALL HAVE ALL VEGETATION, TOP SOIL, AND FERTILIZER REMOVED. FILL MATERIAL SHALL BE FREE OF VEGETATION AND FOREIGN MATERIAL. THE FILL SHALL BE COMPACTED TO THE PROPOSED FINISH GRADE. ALL EXPOSED SURFACES SHALL BE FINISHED WITH A FINISH THAT IS ACCEPTABLE TO THE OWNER. ALL EXPOSED SURFACES SHALL BE FINISHED WITH A FINISH THAT IS ACCEPTABLE TO THE OWNER.

- FOR ALL CONCRETE SLABS AND FOOTINGS, THE AREA WITHIN THE FOOTPRINT OF THE BUILDING ENVELOPE SHALL HAVE ALL VEGETATION, TOP SOIL, AND FERTILIZER REMOVED. FILL MATERIAL SHALL BE FREE OF VEGETATION AND FOREIGN MATERIAL. THE FILL SHALL BE COMPACTED TO THE PROPOSED FINISH GRADE. ALL EXPOSED SURFACES SHALL BE FINISHED WITH A FINISH THAT IS ACCEPTABLE TO THE OWNER. ALL EXPOSED SURFACES SHALL BE FINISHED WITH A FINISH THAT IS ACCEPTABLE TO THE OWNER.

- FOR ALL CONCRETE SLABS AND FOOTINGS, THE AREA WITHIN THE FOOTPRINT OF THE BUILDING ENVELOPE SHALL HAVE ALL VEGETATION, TOP SOIL, AND FERTILIZER REMOVED. FILL MATERIAL SHALL BE FREE OF VEGETATION AND FOREIGN MATERIAL. THE FILL SHALL BE COMPACTED TO THE PROPOSED FINISH GRADE. ALL EXPOSED SURFACES SHALL BE FINISHED WITH A FINISH THAT IS ACCEPTABLE TO THE OWNER. ALL EXPOSED SURFACES SHALL BE FINISHED WITH A FINISH THAT IS ACCEPTABLE TO THE OWNER.

L.S. THOMPSON ENGINEERING, INC.
 805 AVENUE SOUTH, SUITE 100
 WILLOW, NC 27177
 N.C. LICENSE NO. 01723

WILLOW DAVIDSON HOMES



1/3/2023

This sealed paper is to be used in conjunction with a full plan set prepared and sealed by the Engineer. The only use of this professional seal is to certify that the work was prepared by or under the direct supervision of the Engineer under N.C. Statute § 89C23.

D-5
 STRUCTURAL NOTES