

RE: J0523-2576  
 Lot 56 Liberty Meadow

**Trenco**  
 818 Soundside Rd  
 Edenton, NC 27932

**Site Information:**

Customer: Project Name: J0523-2576  
 Lot/Block: Model:  
 Address: Subdivision:  
 City: State:

**General Truss Engineering Criteria & Design Loads (Individual Truss Design Drawings Show Special Loading Conditions):**

Design Code: IRC2015/TPI2014 Design Program: MiTek 20/20 8.4  
 Wind Code: ASCE 7-10 Wind Speed: 130 mph  
 Roof Load: 40.0 psf Floor Load: N/A psf

This package includes 23 individual, dated Truss Design Drawings and 0 Additional Drawings.

No.	Seal#	Truss Name	Date	No.	Seal#	Truss Name	Date
1	I56917876	A1	3/1/2023	21	I56917896	V4	3/1/2023
2	I56917877	A1GE	3/1/2023	22	I56917897	V5	3/1/2023
3	I56917878	A2	3/1/2023	23	I56917898	V6	3/1/2023
4	I56917879	A3	3/1/2023				
5	I56917880	A3GE	3/1/2023				
6	I56917881	B1GE	3/1/2023				
7	I56917882	B2	3/1/2023				
8	I56917883	C1	3/1/2023				
9	I56917884	C1-GR	3/1/2023				
10	I56917885	C1GE	3/1/2023				
11	I56917886	G1	3/1/2023				
12	I56917887	G1GE	3/1/2023				
13	I56917888	J1	3/1/2023				
14	I56917889	J2	3/1/2023				
15	I56917890	J2GE	3/1/2023				
16	I56917891	J3	3/1/2023				
17	I56917892	J3GE	3/1/2023				
18	I56917893	V1	3/1/2023				
19	I56917894	V2	3/1/2023				
20	I56917895	V3	3/1/2023				

The truss drawing(s) referenced above have been prepared by Truss Engineering Co. under my direct supervision based on the parameters provided by Comtech, Inc - Fayetteville.  
 Truss Design Engineer's Name: Gilbert, Eric  
 My license renewal date for the state of North Carolina is December 31, 2023.  
 North Carolina COA: C-0844

IMPORTANT NOTE: The seal on these truss component designs is a certification that the engineer named is licensed in the jurisdiction(s) identified and that the designs comply with ANSI/TPI 1. These designs are based upon parameters shown (e.g., loads, supports, dimensions, shapes and design codes), which were given to TRENCO. Any project specific information included is for TRENCO customers file reference purpose only, and was not taken into account in the preparation of these designs. TRENCO has not independently verified the applicability of the design parameters or the designs for any particular building. Before use, the building designer should verify applicability of design parameters and properly incorporate these designs into the overall building design per ANSI/TPI 1, Chapter 2.

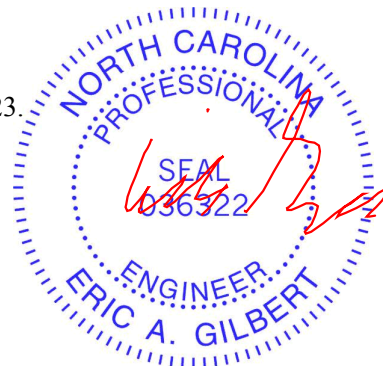

March 01, 2023

Job J0523-2576	Truss A1	Truss Type COMMON	Qty 6	Ply 1	Lot 56 Liberty Meadow I56917876
-------------------	-------------	----------------------	----------	----------	------------------------------------

Comtech, Inc. Fayetteville, NC - 28314,

8.430 s Jan 6 2022 MiTek Industries, Inc. Wed Mar 1 09:54:40 2023 Page 1

ID:aTXuLo?nW09qtpROz2WQ0wydkZW-?BnmiPHT79Oqh0F54W?GM76zyEMuwtqpU7eeV9zfKaz

Job Reference (optional)

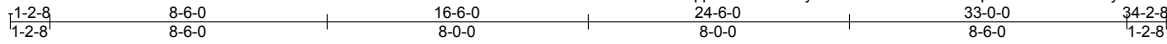

5x5 =

Scale = 1:70.6

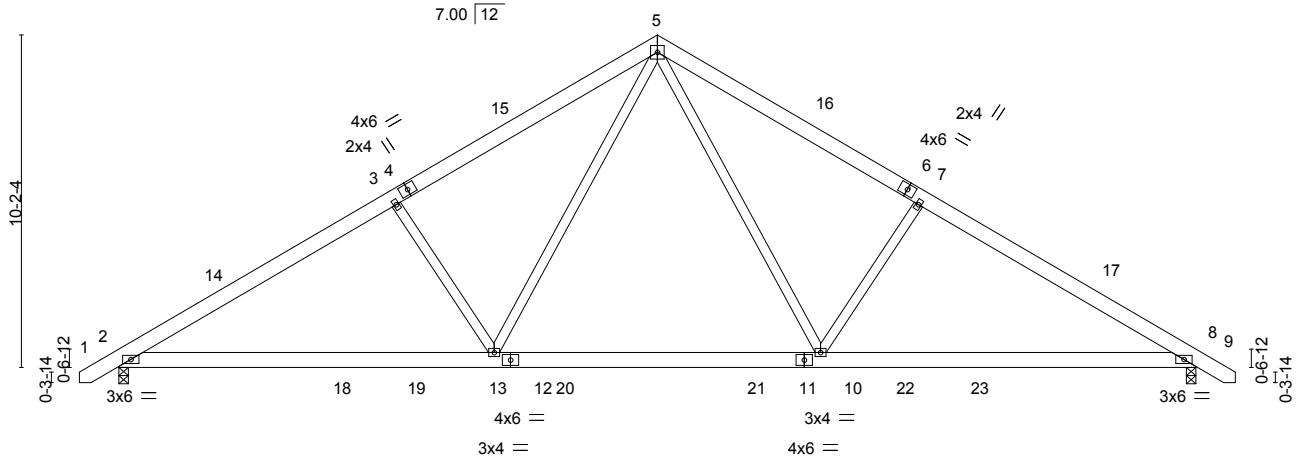

LOADING (psf)	SPACING-	2-0-0	CSI.	DEFL.	in (loc)	l/defl	L/d	PLATES	GRIP
TCLL 20.0	Plate Grip DOL	1.15	TC 0.30	Vert(LL)	-0.15 10-13	>999	360	MT20	244/190
TCDL 10.0	Lumber DOL	1.15	BC 0.53	Vert(CT)	-0.26 8-10	>999	240		
BCLL 0.0 *	Rep Stress Incr	YES	WB 0.31	Horz(CT)	0.05 8	n/a	n/a		
BCDL 10.0	Code IRC2015/TPI2014		Matrix-S	Wind(LL)	0.05 2-13	>999	240		
								Weight: 221 lb	FT = 20%

**LUMBER-**  
 TOP CHORD 2x6 SP No.1  
 BOT CHORD 2x6 SP No.1  
 WEBS 2x4 SP No.2

**BRACING-**  
 TOP CHORD Structural wood sheathing directly applied or 4-11-2 oc purlins.  
 BOT CHORD Rigid ceiling directly applied or 10-0-0 oc bracing.

**REACTIONS.** (size) 2=0-3-8, 8=0-3-8  
 Max Horz 2=245(LC 11)  
 Max Uplift 2=91(LC 12), 8=91(LC 13)  
 Max Grav 2=1525(LC 19), 8=1525(LC 20)

**FORCES.** (lb) - Max. Comp./Max. Ten. - All forces 250 (lb) or less except when shown.  
 TOP CHORD 2-3=-2295/423, 3-5=-2090/464, 5-7=-2091/464, 7-8=-2296/423  
 BOT CHORD 2-13=-222/2070, 10-13=-9/1347, 8-10=-233/1886  
 WEBS 3-13=-544/300, 5-13=-140/991, 5-10=-139/991, 7-10=-544/300

**NOTES-**

- 1) Unbalanced roof live loads have been considered for this design.
- 2) Wind: ASCE 7-10; Vult=130mph Vasd=103mph; TCDL=6.0psf; BCDL=6.0psf; h=15ft; Cat. II; Exp C; Enclosed; MWFRS (envelope) and C-C Exterior(2) -1-0-6 to 3-4-7, Interior(1) 3-4-7 to 16-6-0, Exterior(2) 16-6-0 to 20-10-13, Interior(1) 20-10-13 to 34-0-6 zone; C-C for members and forces & MWFRS for reactions shown; Lumber DOL=1.60 plate grip DOL=1.60
- 3) This truss has been designed for a 10.0 psf bottom chord live load nonconcurrent with any other live loads.
- 4) \* This truss has been designed for a live load of 30.0psf on the bottom chord in all areas where a rectangle 3-6-0 tall by 2-0-0 wide will fit between the bottom chord and any other members, with BCDL = 10.0psf.
- 5) Provide mechanical connection (by others) of truss to bearing plate capable of withstanding 91 lb uplift at joint 2 and 91 lb uplift at joint 8.

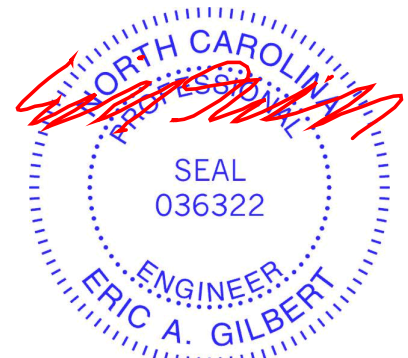

March 1, 2023

**WARNING - Verify design parameters and READ NOTES ON THIS AND INCLUDED MITEK REFERENCE PAGE MII-7473 rev. 1/2/2023 BEFORE USE.**

Design valid for use only with MiTek® connectors. This design is based only upon parameters shown, and is for an individual building component, not a truss system. Before use, the building designer must verify the applicability of design parameters and properly incorporate this design into the overall building design. Bracing indicated is to prevent buckling of individual truss web and/or chord members only. Additional temporary and permanent bracing is always required for stability and to prevent collapse with possible personal injury and property damage. For general guidance regarding the fabrication, storage, delivery, erection and bracing of trusses and truss systems, see **ANSI/TPI1 Quality Criteria and DSB-22** available from Truss Plate Institute (www.tpinst.org) and **BCSI Building Component Safety Information** available from the Structural Building Component Association (www.sbcacomponents.com)



818 Soundside Road  
 Edenton, NC 27932

Job J0523-2576	Truss A1GE	Truss Type GABLE	Qty 1	Ply 1	Lot 56 Liberty Meadow I56917877
-------------------	---------------	---------------------	----------	----------	------------------------------------

Comtech, Inc. Fayetteville, NC - 28314,

8.430 s Jan 6 2022 MiTek Industries, Inc. Wed Mar 1 09:54:43 2023 Page 1

ID:aTXuLo?nW09qtpROz2WQ0wydkZW-QmTvlQKMP4mPYU\_gmfZz\_mkYHSVZ7GJFA5t5UzfKAw



5x5 =

Scale = 1:67.2

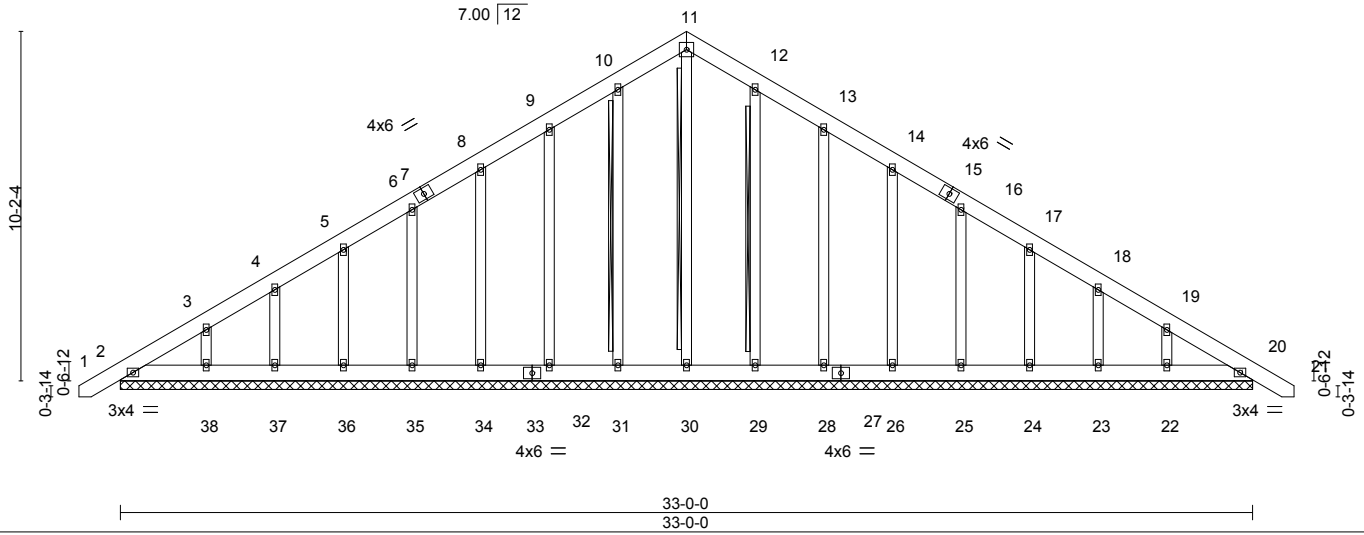

<b>LOADING</b> (psf)	<b>SPACING-</b>	2-0-0	<b>CSI.</b>	<b>DEFL.</b>	in (loc)	l/defl	L/d	<b>PLATES</b>	<b>GRIP</b>
TCLL 20.0	Plate Grip DOL	1.15	TC 0.04	Vert(LL)	-0.00	20	n/r	MT20	244/190
TCDL 10.0	Lumber DOL	1.15	BC 0.02	Vert(CT)	0.00	20	n/r		
BCLL 0.0 *	Rep Stress Incr	YES	WB 0.13	Horz(CT)	0.01	20	n/a		
BCDL 10.0	Code IRC2015/TPI2014		Matrix-S						
								Weight: 283 lb	FT = 20%

**LUMBER-**  
TOP CHORD 2x6 SP No.1  
BOT CHORD 2x6 SP No.1  
OTHERS 2x4 SP No.2

**BRACING-**  
TOP CHORD Structural wood sheathing directly applied or 6-0-0 oc purlins.  
BOT CHORD Rigid ceiling directly applied or 10-0-0 oc bracing.  
WEBS T-Brace: 2x4 SPF No.2 - 11-30, 10-31, 12-29  
Fasten (2X) T and I braces to narrow edge of web with 10d (0.131"x3") nails, 6in o.c., with 3in minimum end distance.  
Brace must cover 90% of web length.

**REACTIONS.** All bearings 33-0-0.  
(lb) - Max Horz 2=306(LC 11)  
Max Uplift All uplift 100 lb or less at joint(s) 2, 20, 31, 32, 34, 35, 36, 37, 38, 29, 28, 26, 25, 24, 23, 22  
Max Grav All reactions 250 lb or less at joint(s) 2, 20, 30, 31, 32, 34, 35, 36, 37, 38, 29, 28, 26, 25, 24, 23, 22

**FORCES.** (lb) - Max. Comp./Max. Ten. - All forces 250 (lb) or less except when shown.  
TOP CHORD 2-3=-277/226, 10-11=-242/277, 11-12=-242/277

- NOTES-**
- Unbalanced roof live loads have been considered for this design.
  - Wind: ASCE 7-10; Vult=130mph Vasd=103mph; TC DL=6.0psf; BCDL=6.0psf; h=15ft; Cat. II; Exp C; Enclosed; MWFRS (envelope) gable end zone and C-C Exterior(2) zone; C-C for members and forces & MWFRS for reactions shown; Lumber DOL=1.60 plate grip DOL=1.60
  - Truss designed for wind loads in the plane of the truss only. For studs exposed to wind (normal to the face), see Standard Industry Gable End Details as applicable, or consult qualified building designer as per ANSI/TPI 1.
  - All plates are 2x4 MT20 unless otherwise indicated.
  - Gable requires continuous bottom chord bearing.
  - Gable studs spaced at 2-0-0 oc.
  - This truss has been designed for a 10.0 psf bottom chord live load nonconcurrent with any other live loads.
  - \* This truss has been designed for a live load of 30.0psf on the bottom chord in all areas where a rectangle 3-6-0 tall by 2-0-0 wide will fit between the bottom chord and any other members.
  - Provide mechanical connection (by others) of truss to bearing plate capable of withstanding 100 lb uplift at joint(s) 2, 20, 31, 32, 34, 35, 36, 37, 38, 29, 28, 26, 25, 24, 23, 22.
  - Warning: Additional permanent and stability bracing for truss system (not part of this component design) is always required.

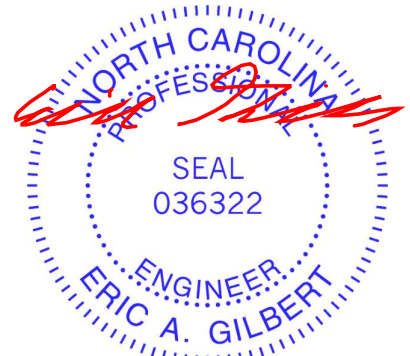

March 1, 2023

**WARNING - Verify design parameters and READ NOTES ON THIS AND INCLUDED MITEK REFERENCE PAGE MII-7473 rev. 1/2/2023 BEFORE USE.**

Design valid for use only with MiTek® connectors. This design is based only upon parameters shown, and is for an individual building component, not a truss system. Before use, the building designer must verify the applicability of design parameters and properly incorporate this design into the overall building design. Bracing indicated is to prevent buckling of individual truss web and/or chord members only. Additional temporary and permanent bracing is always required for stability and to prevent collapse with possible personal injury and property damage. For general guidance regarding the fabrication, storage, delivery, erection and bracing of trusses and truss systems, see **ANSI/TPI1 Quality Criteria and DSB-22** available from Truss Plate Institute (www.tpinst.org) and **BCSI Building Component Safety Information** available from the Structural Building Component Association (www.sbcacomponents.com)



818 Soundside Road  
Edenton, NC 27932

Job J0523-2576	Truss A2	Truss Type COMMON	Qty 4	Ply 1	Lot 56 Liberty Meadow I56917878
-------------------	-------------	----------------------	----------	----------	------------------------------------

Comtech, Inc. Fayetteville, NC - 28314,

8.430 s Jan 6 2022 MiTek Industries, Inc. Wed Mar 1 09:54:45 2023 Page 1

ID:aTXuLo?nW09qtpROz2WQ0wydkZW-M8af6Lcx16nn73t3bR3BqkLF2yb73YePMPAMzfKAU

Job Reference (optional)



5x5 =

Scale = 1:70.6

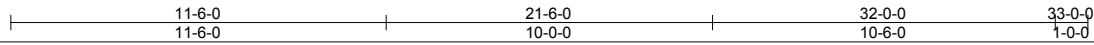
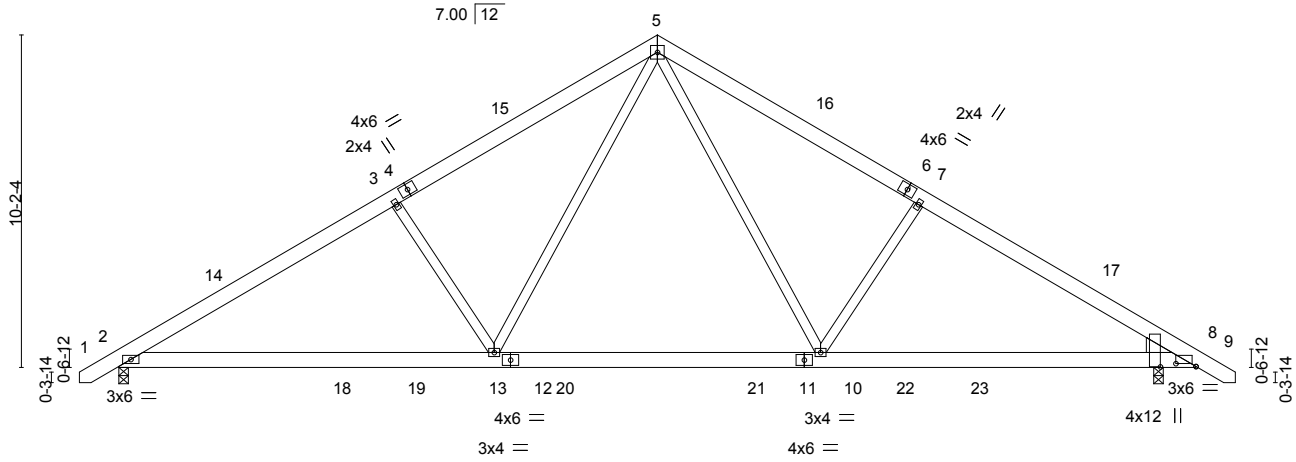

Plate Offsets (X,Y)-- [8:0-7-6,0-1-1], [8:0-0-2,1-1-1]

LOADING (psf)	SPACING-	CSI.	DEFL.	PLATES	GRIP
TCLL 20.0	2-0-0	TC 0.65	in (loc) l/defl L/d	MT20	244/190
TCDL 10.0	Plate Grip DOL 1.15	BC 0.60	Vert(LL) -0.15 10-13 >999 360		
BCLL 0.0 *	Lumber DOL 1.15	WB 0.31	Vert(CT) -0.26 8-10 >999 240		
BCDL 10.0	Rep Stress Incr YES	Matrix-S	Horz(CT) 0.05 8 n/a n/a		
	Code IRC2015/TPI2014		Wind(LL) 0.05 2-13 >999 240	Weight: 223 lb	FT = 20%

**LUMBER-**  
 TOP CHORD 2x6 SP No.1  
 BOT CHORD 2x6 SP No.1  
 WEBS 2x4 SP No.2  
 WEDGE  
 Right: 2x6 SP No.1

**BRACING-**  
 TOP CHORD Structural wood sheathing directly applied or 4-11-2 oc purlins.  
 BOT CHORD Rigid ceiling directly applied or 10-0-0 oc bracing.

**REACTIONS.** (size) 2=0-3-8, 8=0-3-8  
 Max Horz 2=245(LC 11)  
 Max Uplift 2=-91(LC 12), 8=-91(LC 13)  
 Max Grav 2=1525(LC 19), 8=1525(LC 20)

**FORCES.** (lb) - Max. Comp./Max. Ten. - All forces 250 (lb) or less except when shown.  
 TOP CHORD 2-3=-2295/423, 3-5=-2090/464, 5-7=-2091/464, 7-8=-2296/423  
 BOT CHORD 2-13=-222/2070, 10-13=-9/1347, 8-10=-233/1886  
 WEBS 3-13=-544/300, 5-13=-140/991, 5-10=-139/991, 7-10=-544/300

- NOTES-**
- 1) Unbalanced roof live loads have been considered for this design.
  - 2) Wind: ASCE 7-10; Vult=130mph Vasd=103mph; TCDL=6.0psf; BCDL=6.0psf; h=15ft; Cat. II; Exp C; Enclosed; MWFRS (envelope) and C-C Exterior(2) -1-0-6 to 3-4-7, Interior(1) 3-4-7 to 16-6-0, Exterior(2) 16-6-0 to 20-10-13, Interior(1) 20-10-13 to 34-0-6 zone; cantilever right exposed ;C-C for members and forces & MWFRS for reactions shown; Lumber DOL=1.60 plate grip DOL=1.60
  - 3) This truss has been designed for a 10.0 psf bottom chord live load nonconcurrent with any other live loads.
  - 4) \* This truss has been designed for a live load of 30.0psf on the bottom chord in all areas where a rectangle 3-6-0 tall by 2-0-0 wide will fit between the bottom chord and any other members, with BCDL = 10.0psf.
  - 5) Provide mechanical connection (by others) of truss to bearing plate capable of withstanding 100 lb uplift at joint(s) 2, 8.

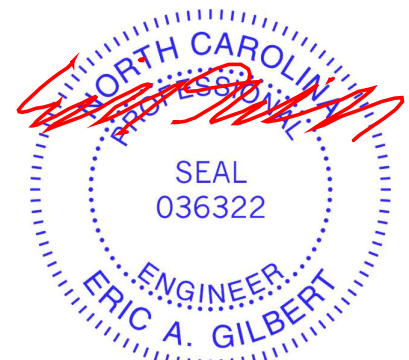

March 1, 2023

**WARNING - Verify design parameters and READ NOTES ON THIS AND INCLUDED MITEK REFERENCE PAGE MII-7473 rev. 1/2/2023 BEFORE USE.**  
 Design valid for use only with MiTek® connectors. This design is based only upon parameters shown, and is for an individual building component, not a truss system. Before use, the building designer must verify the applicability of design parameters and properly incorporate this design into the overall building design. Bracing indicated is to prevent buckling of individual truss web and/or chord members only. Additional temporary and permanent bracing is always required for stability and to prevent collapse with possible personal injury and property damage. For general guidance regarding the fabrication, storage, delivery, erection and bracing of trusses and truss systems, see **ANSI/TPI1 Quality Criteria and DSB-22** available from Truss Plate Institute (www.tpinst.org) and **BCSI Building Component Safety Information** available from the Structural Building Component Association (www.sbcacomponents.com)





Job J0523-2576	Truss A3GE	Truss Type GABLE	Qty 1	Ply 1	Lot 56 Liberty Meadow I56917880
-------------------	---------------	---------------------	----------	----------	------------------------------------

Comtech, Inc. Fayetteville, NC - 28314,

8.430 s Jan 6 2022 MiTek Industries, Inc. Wed Mar 1 09:54:48 2023 Page 1

ID:aTXuLo?nW09qtpROz2WQ0wydkZW-mjGoO8OUEdPheFseYC98hpSP1TDjoWZ\_KNa3nhzfKAr



5x5 =

Scale = 1:65.8

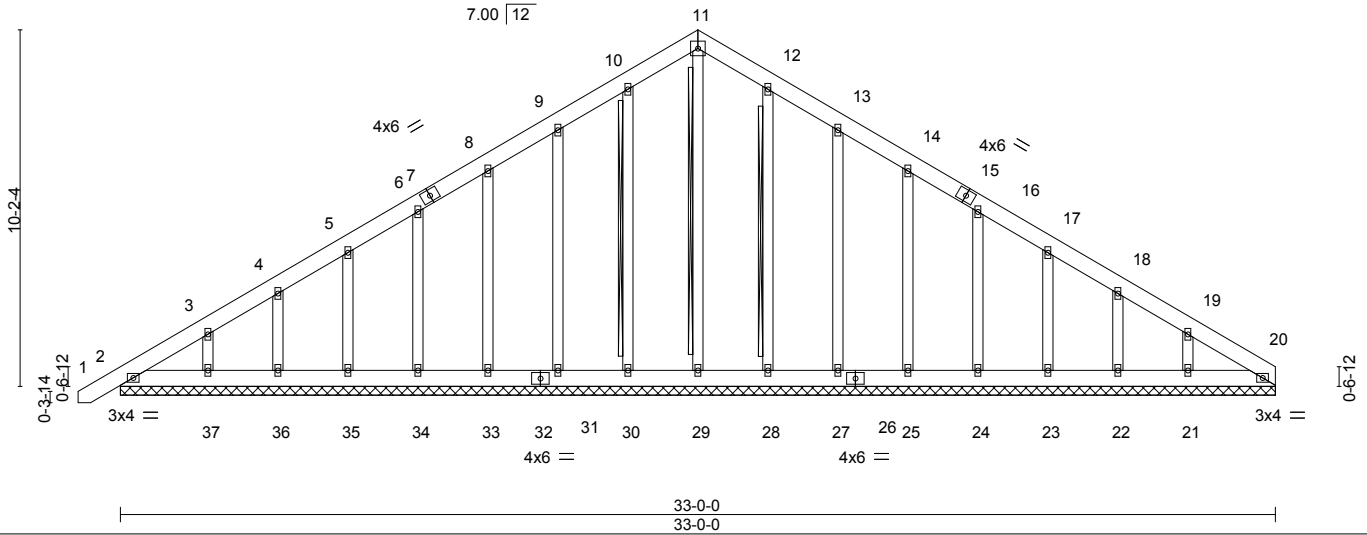

LOADING (psf)	SPACING-	2-0-0	CSI.	DEFL.	in (loc)	l/defl	L/d	PLATES	GRIP
TCLL 20.0	Plate Grip DOL	1.15	TC 0.04	Vert(LL)	-0.00	1	n/r	MT20	244/190
TCDL 10.0	Lumber DOL	1.15	BC 0.02	Vert(CT)	0.00	1	n/r		
BCLL 0.0 *	Rep Stress Incr	YES	WB 0.13	Horz(CT)	0.01	20	n/a		
BCDL 10.0	Code IRC2015/TPI2014		Matrix-S					Weight: 280 lb	FT = 20%

**LUMBER-**  
 TOP CHORD 2x6 SP No.1  
 BOT CHORD 2x6 SP No.1  
 OTHERS 2x4 SP No.2

**BRACING-**  
 TOP CHORD Structural wood sheathing directly applied or 6-0-0 oc purlins.  
 BOT CHORD Rigid ceiling directly applied or 10-0-0 oc bracing.  
 WEBS T-Brace: 2x4 SPF No.2 - 11-29, 10-30, 12-28  
 Fasten (2X) T and I braces to narrow edge of web with 10d (0.131"x3") nails, 6in o.c., with 3in minimum end distance.  
 Brace must cover 90% of web length.

**REACTIONS.** All bearings 33-0-0.  
 (lb) - Max Horz 2=301(LC 9)  
 Max Uplift All uplift 100 lb or less at joint(s) 2, 20, 30, 31, 33, 34, 35, 36, 37, 28, 27, 25, 24, 23, 22 except 21=-107(LC 13)  
 Max Grav All reactions 250 lb or less at joint(s) 2, 20, 29, 30, 31, 33, 34, 35, 36, 37, 28, 27, 25, 24, 23, 22, 21

**FORCES.** (lb) - Max. Comp./Max. Ten. - All forces 250 (lb) or less except when shown.  
 TOP CHORD 2-3=-280/222, 10-11=-236/265, 11-12=-236/265

- NOTES-**
- 1) Unbalanced roof live loads have been considered for this design.
  - 2) Wind: ASCE 7-10; Vult=130mph Vasd=103mph; TCDL=6.0psf; BCDL=6.0psf; h=15ft; Cat. II; Exp C; Enclosed; MWFRS (envelope) gable end zone and C-C Exterior(2) zone; C-C for members and forces & MWFRS for reactions shown; Lumber DOL=1.60 plate grip DOL=1.60
  - 3) Truss designed for wind loads in the plane of the truss only. For studs exposed to wind (normal to the face), see Standard Industry Gable End Details as applicable, or consult qualified building designer as per ANSI/TPI 1.
  - 4) All plates are 2x4 MT20 unless otherwise indicated.
  - 5) Gable requires continuous bottom chord bearing.
  - 6) Gable studs spaced at 2-0-0 oc.
  - 7) This truss has been designed for a 10.0 psf bottom chord live load nonconcurrent with any other live loads.
  - 8) \* This truss has been designed for a live load of 30.0psf on the bottom chord in all areas where a rectangle 3-6-0 tall by 2-0-0 wide will fit between the bottom chord and any other members.
  - 9) Provide mechanical connection (by others) of truss to bearing plate capable of withstanding 100 lb uplift at joint(s) 2, 20, 30, 31, 33, 34, 35, 36, 37, 28, 27, 25, 24, 23, 22 except (jt=lb) 21=107.
  - 10) Warning: Additional permanent and stability bracing for truss system (not part of this component design) is always required.



March 1, 2023

**WARNING - Verify design parameters and READ NOTES ON THIS AND INCLUDED MITEK REFERENCE PAGE MII-7473 rev. 1/2/2023 BEFORE USE.**  
 Design valid for use only with MiTek® connectors. This design is based only upon parameters shown, and is for an individual building component, not a truss system. Before use, the building designer must verify the applicability of design parameters and properly incorporate this design into the overall building design. Bracing indicated is to prevent buckling of individual truss web and/or chord members only. Additional temporary and permanent bracing is always required for stability and to prevent collapse with possible personal injury and property damage. For general guidance regarding the fabrication, storage, delivery, erection and bracing of trusses and truss systems, see **ANSI/TPI1 Quality Criteria and DSB-22** available from Truss Plate Institute (www.tpinst.org) and **BCSI Building Component Safety Information** available from the Structural Building Component Association (www.sbcacomponents.com)

ENGINEERING BY  
**TRENCO**  
 A MiTek Affiliate  
 818 Soundside Road  
 Edenton, NC 27932



Job J0523-2576	Truss B1GE	Truss Type GABLE	Qty 1	Ply 1	Lot 56 Liberty Meadow I56917881
Comtech, Inc. Fayetteville, NC - 28314,					Job Reference (optional)

8.430 s Jan 6 2022 MiTek Industries, Inc. Wed Mar 1 09:54:50 2023 Page 1  
 ID:aTXuLo?nW09qtpROz2WQ0wydkZW-j6OYpqPlmEfpUz00gdBcmEXj\_GsaGRmHng3ArazfkAp

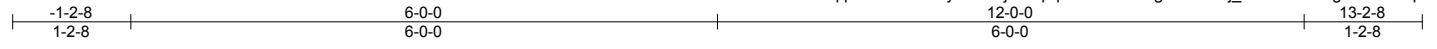

Scale = 1:23.6

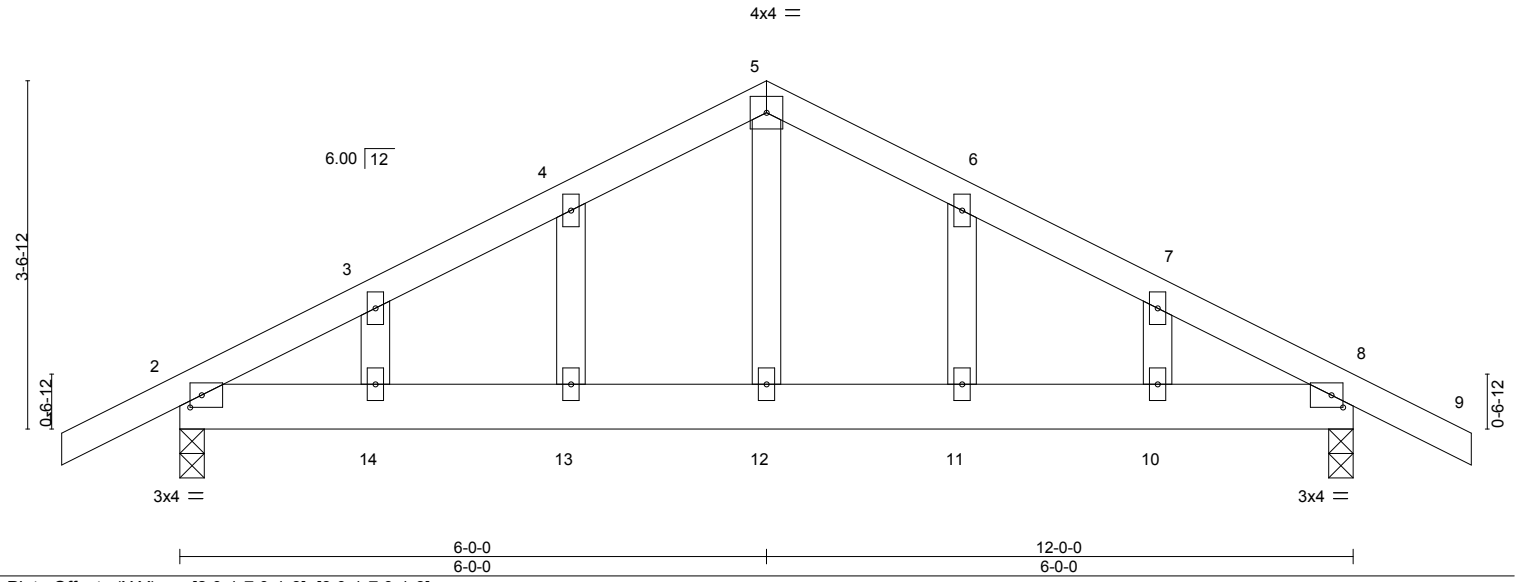

Plate Offsets (X,Y)-- [2:0-1-7,0-1-8], [8:0-1-7,0-1-8]

LOADING (psf)	SPACING-	CSI.	DEFL.	PLATES	GRIP
TCLL 20.0	2-0-0	TC 0.14	in (loc) l/defl L/d	MT20	244/190
TCDL 10.0	Plate Grip DOL 1.15	BC 0.19	Vert(LL) -0.02 10-11 >999 360		
BCLL 0.0 *	Lumber DOL 1.15	WB 0.09	Vert(CT) -0.03 10-11 >999 240		
BCDL 10.0	Rep Stress Incr YES	Matrix-S	Horz(CT) 0.01 8 n/a n/a		
	Code IRC2015/TPI2014		Wind(LL) 0.03 10-11 >999 240	Weight: 65 lb	FT = 20%

LUMBER-	BRACING-
TOP CHORD 2x4 SP No.1	TOP CHORD Structural wood sheathing directly applied or 6-0-0 oc purlins.
BOT CHORD 2x6 SP No.1	BOT CHORD Rigid ceiling directly applied or 10-0-0 oc bracing.
WEBS 2x4 SP No.2	
OTHERS 2x4 SP No.2	

**REACTIONS.** (size) 2=0-3-0, 8=0-3-0  
 Max Horz 2=-73(LC 17)  
 Max Uplift 2=-143(LC 9), 8=-143(LC 8)  
 Max Grav 2=550(LC 1), 8=550(LC 1)

**FORCES.** (lb) - Max. Comp./Max. Ten. - All forces 250 (lb) or less except when shown.  
 TOP CHORD 2-3=-617/666, 3-4=-570/687, 4-5=-561/740, 5-6=-561/740, 6-7=-570/688, 7-8=-617/666  
 BOT CHORD 2-14=-494/491, 13-14=-494/491, 12-13=-494/491, 11-12=-494/491, 10-11=-494/491,  
 8-10=-494/491  
 WEBS 5-12=-513/328

- NOTES-**
- 1) Unbalanced roof live loads have been considered for this design.
  - 2) Wind: ASCE 7-10; Vult=130mph Vasd=103mph; TCDL=6.0psf; BCDL=6.0psf; h=15ft; Cat. II; Exp C; Enclosed; MWFRS (envelope) gable end zone and C-C Exterior(2) zone; porch left and right exposed; C-C for members and forces & MWFRS for reactions shown; Lumber DOL=1.60 plate grip DOL=1.60
  - 3) Truss designed for wind loads in the plane of the truss only. For studs exposed to wind (normal to the face), see Standard Industry Gable End Details as applicable, or consult qualified building designer as per ANSI/TPI 1.
  - 4) All plates are 2x4 MT20 unless otherwise indicated.
  - 5) Gable studs spaced at 2-0-0 oc.
  - 6) This truss has been designed for a 10.0 psf bottom chord live load nonconcurrent with any other live loads.
  - 7) \* This truss has been designed for a live load of 30.0psf on the bottom chord in all areas where a rectangle 3-6-0 tall by 2-0-0 wide will fit between the bottom chord and any other members.
  - 8) Provide mechanical connection (by others) of truss to bearing plate capable of withstanding 100 lb uplift at joint(s) except (jt=lb) 2=143, 8=143.

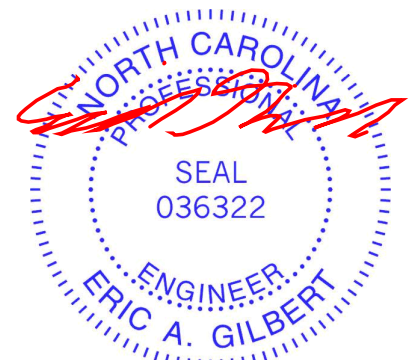

March 1, 2023

Job J0523-2576	Truss B2	Truss Type COMMON	Qty 4	Ply 1	Lot 56 Liberty Meadow 156917882
-------------------	-------------	----------------------	----------	----------	------------------------------------

Comtech, Inc. Fayetteville, NC - 28314,

8.430 s Jan 6 2022 MiTek Industries, Inc. Wed Mar 1 09:54:51 2023 Page 1

ID:aTXuLo?nW09qtpROz2WQ0wydkZW-Blxw09QNXynGVibDEKIrJS4rMgCN?uKR0KpiN0zfKAO

Job Reference (optional)



Scale = 1:23.7

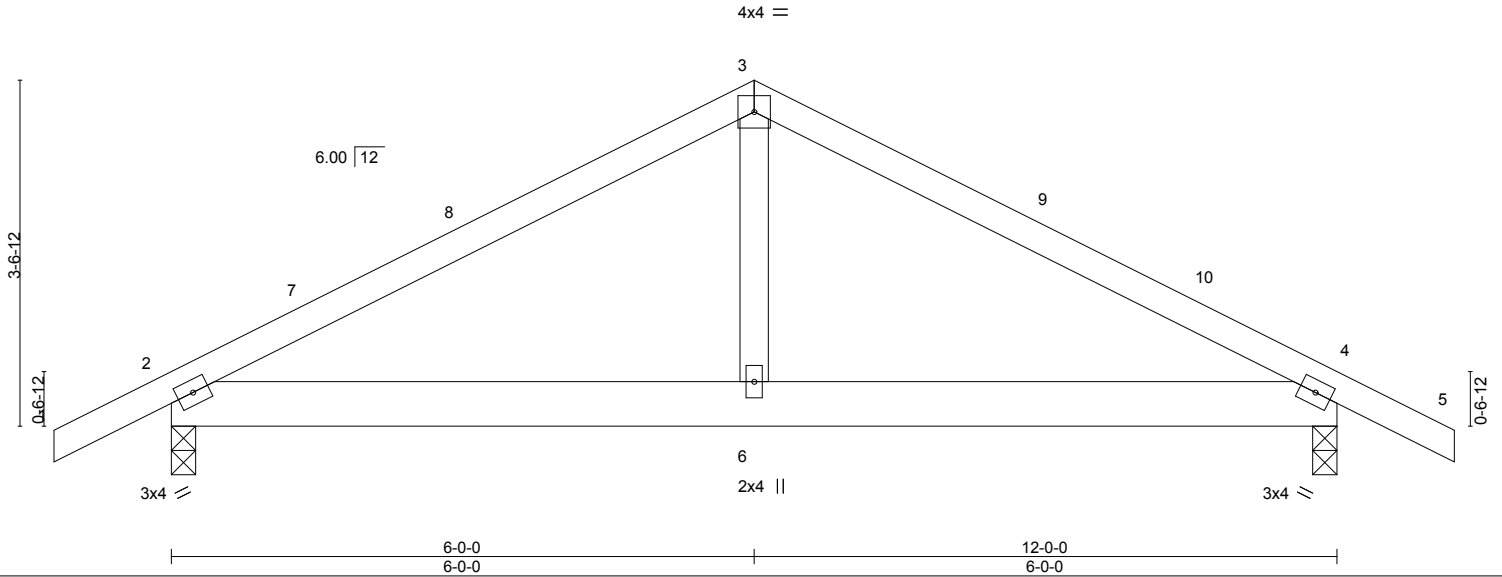

LOADING (psf)	SPACING-	CSI.	DEFL.	in (loc)	l/defl	L/d	PLATES	GRIP
TCLL 20.0	2-0-0	TC 0.29	Vert(LL)	-0.01	4-6	>999	MT20	244/190
TCDL 10.0	Plate Grip DOL 1.15	BC 0.15	Vert(CT)	-0.02	4-6	>999		
BCLL 0.0 *	Lumber DOL 1.15	WB 0.07	Horz(CT)	0.01	4	n/a		
BCDL 10.0	Rep Stress Incr YES	Matrix-S	Wind(LL)	0.03	4-6	>999		
	Code IRC2015/TPI2014						Weight: 57 lb	FT = 20%

**LUMBER-**  
 TOP CHORD 2x4 SP No.1  
 BOT CHORD 2x6 SP No.1  
 WEBS 2x4 SP No.2

**BRACING-**  
 TOP CHORD Structural wood sheathing directly applied or 6-0-0 oc purlins.  
 BOT CHORD Rigid ceiling directly applied or 10-0-0 oc bracing.

**REACTIONS.** (size) 2=0-3-0, 4=0-3-0  
 Max Horz 2=-47(LC 10)  
 Max Uplift 2=-109(LC 9), 4=-109(LC 8)  
 Max Grav 2=550(LC 1), 4=550(LC 1)

**FORCES.** (lb) - Max. Comp./Max. Ten. - All forces 250 (lb) or less except when shown.  
 TOP CHORD 2-3=-640/667, 3-4=-640/667  
 BOT CHORD 2-6=-457/485, 4-6=-457/485  
 WEBS 3-6=-394/296

**NOTES-**

- 1) Unbalanced roof live loads have been considered for this design.
- 2) Wind: ASCE 7-10; Vult=130mph Vasd=103mph; TC DL=6.0psf; BCDL=6.0psf; h=15ft; Cat. II; Exp C; Enclosed; MWFRS (envelope) and C-C Exterior(2) -1-2-8 to 3-2-5, Interior(1) 3-2-5 to 6-0-0, Exterior(2) 6-0-0 to 10-4-13, Interior(1) 10-4-13 to 13-2-8 zone; porch left and right exposed; C-C for members and forces & MWFRS for reactions shown; Lumber DOL=1.60 plate grip DOL=1.60
- 3) This truss has been designed for a 10.0 psf bottom chord live load nonconcurrent with any other live loads.
- 4) \* This truss has been designed for a live load of 30.0psf on the bottom chord in all areas where a rectangle 3-6-0 tall by 2-0-0 wide will fit between the bottom chord and any other members.
- 5) Provide mechanical connection (by others) of truss to bearing plate capable of withstanding 100 lb uplift at joint(s) except (jt=lb) 2=109, 4=109.



March 1, 2023

**WARNING - Verify design parameters and READ NOTES ON THIS AND INCLUDED MITEK REFERENCE PAGE MII-7473 rev. 1/2/2023 BEFORE USE.**

Design valid for use only with MiTek® connectors. This design is based only upon parameters shown, and is for an individual building component, not a truss system. Before use, the building designer must verify the applicability of design parameters and properly incorporate this design into the overall building design. Bracing indicated is to prevent buckling of individual truss web and/or chord members only. Additional temporary and permanent bracing is always required for stability and to prevent collapse with possible personal injury and property damage. For general guidance regarding the fabrication, storage, delivery, erection and bracing of trusses and truss systems, see **ANSI/TP1 Quality Criteria and DSB-22** available from Truss Plate Institute (www.tpinst.org) and **BCSI Building Component Safety Information** available from the Structural Building Component Association (www.sbcacomponents.com)



818 Soundside Road  
 Edenton, NC 27932



Job J0523-2576	Truss C1	Truss Type COMMON	Qty 5	Ply 1	Lot 56 Liberty Meadow 156917883
-------------------	-------------	----------------------	----------	----------	------------------------------------

Comtech, Inc. Fayetteville, NC - 28314,

8.430 s Jan 6 2022 MiTek Industries, Inc. Wed Mar 1 09:54:52 2023 Page 1

ID:aTXuLo?nW09qtpROz2WQ0wydkZW-fVVJDVR?Irv77sAPn2D4rfcz\_4SakKkaF\_YHwSzfKAn

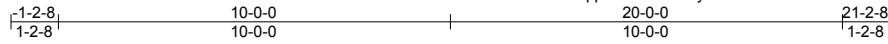

5x8 ||

Scale = 1:58.8

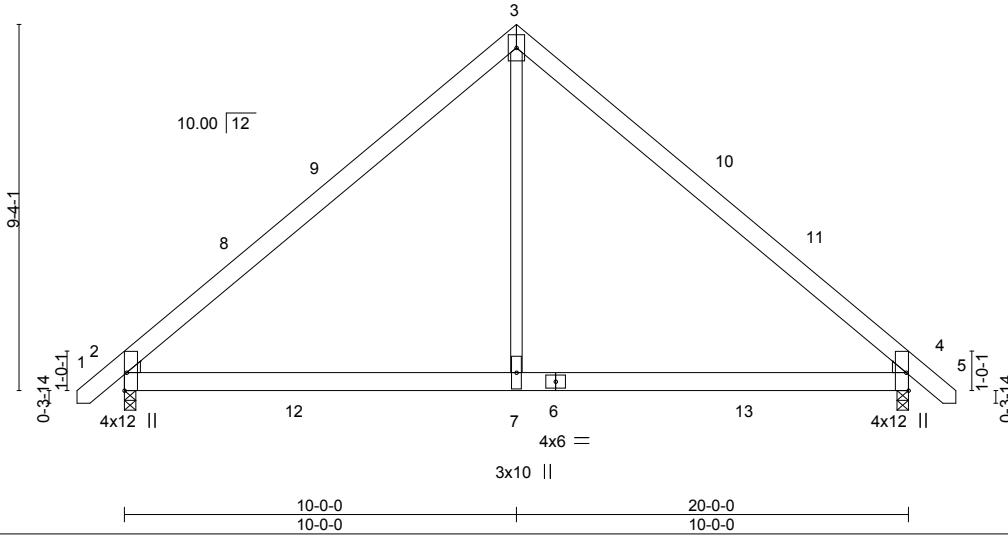

Plate Offsets (X,Y)-- [2:Edge,0-0-11], [4:Edge,0-0-11]

LOADING (psf)	SPACING-	CSI.	DEFL.	PLATES	GRIP
TCLL 20.0	2-0-0	TC 0.49	in (loc) l/defl L/d	MT20	244/190
TCDL 10.0	Plate Grip DOL 1.15	BC 0.54	Vert(LL) -0.10 4-7 >999 360		
BCLL 0.0 *	Lumber DOL 1.15	WB 0.19	Vert(CT) -0.17 4-7 >999 240		
BCDL 10.0	Rep Stress Incr YES	Matrix-S	Horz(CT) 0.01 4 n/a n/a		
	Code IRC2015/TPI2014		Wind(LL) 0.06 2-7 >999 240	Weight: 129 lb	FT = 20%

LUMBER-	BRACING-
TOP CHORD 2x6 SP No.1	TOP CHORD Structural wood sheathing directly applied or 6-0-0 oc purlins.
BOT CHORD 2x6 SP No.1	BOT CHORD Rigid ceiling directly applied or 10-0-0 oc bracing.
WEBS 2x4 SP No.2	
WEDGE	
Left: 2x4 SP No.3 , Right: 2x4 SP No.3	

**REACTIONS.** (size) 4=0-3-8, 2=0-3-8  
 Max Horz 2=-221(LC 10)  
 Max Uplift 4=-48(LC 13), 2=-48(LC 12)  
 Max Grav 4=1044(LC 20), 2=1044(LC 19)

**FORCES.** (lb) - Max. Comp./Max. Ten. - All forces 250 (lb) or less except when shown.  
 TOP CHORD 2-3=-1118/210, 3-4=-1118/210  
 BOT CHORD 2-7=0/784, 4-7=0/784  
 WEBS 3-7=0/822

- NOTES-**
- 1) Unbalanced roof live loads have been considered for this design.
  - 2) Wind: ASCE 7-10; Vult=130mph Vasd=103mph; TCDL=6.0psf; BCDL=6.0psf; h=15ft; Cat. II; Exp C; Enclosed; MWFRS (envelope) and C-C Exterior(2) -1-0-8 to 3-4-4, Interior(1) 3-4-4 to 10-0-0, Exterior(2) 10-0-0 to 14-4-13, Interior(1) 14-4-13 to 21-0-8 zone; C-C for members and forces & MWFRS for reactions shown; Lumber DOL=1.60 plate grip DOL=1.60
  - 3) This truss has been designed for a 10.0 psf bottom chord live load nonconcurrent with any other live loads.
  - 4) \* This truss has been designed for a live load of 30.0psf on the bottom chord in all areas where a rectangle 3-6-0 tall by 2-0-0 wide will fit between the bottom chord and any other members, with BCDL = 10.0psf.
  - 5) Provide mechanical connection (by others) of truss to bearing plate capable of withstanding 100 lb uplift at joint(s) 4, 2.

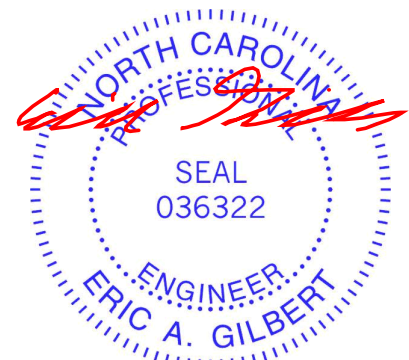

March 1, 2023

<p><b>WARNING - Verify design parameters and READ NOTES ON THIS AND INCLUDED MITEK REFERENCE PAGE MII-7473 rev. 1/2/2023 BEFORE USE.</b></p> <p>Design valid for use only with MiTek® connectors. This design is based only upon parameters shown, and is for an individual building component, not a truss system. Before use, the building designer must verify the applicability of design parameters and properly incorporate this design into the overall building design. Bracing indicated is to prevent buckling of individual truss web and/or chord members only. Additional temporary and permanent bracing is always required for stability and to prevent collapse with possible personal injury and property damage. For general guidance regarding the fabrication, storage, delivery, erection and bracing of trusses and truss systems, see <b>ANSI/TP1 Quality Criteria and DSB-22</b> available from Truss Plate Institute (www.tpinst.org) and <b>BCSI Building Component Safety Information</b> available from the Structural Building Component Association (www.sbcacomponents.com)</p>	<p>ENGINEERING BY</p>  <p>A MiTek Affiliate</p> <p>818 Soundside Road Edenton, NC 27932</p>
--	--

Job J0523-2576	Truss C1-GR	Truss Type COMMON GIRDER	Qty 1	Ply 2	Lot 56 Liberty Meadow I56917884
-------------------	----------------	-----------------------------	----------	----------	------------------------------------

Comtech, Inc. Fayetteville, NC - 28314,

8.430 s Jan 6 2022 MiTek Industries, Inc. Wed Mar 1 09:54:56 2023 Page 1

ID:aTXuLo?nW09qtpROz2WQ0wydkZW-XGlp3tUVM4PYcUTA0tI00Vnd5hqgqzOA9cWU3DzfkAJ



5x8 ||

Scale = 1:58.8

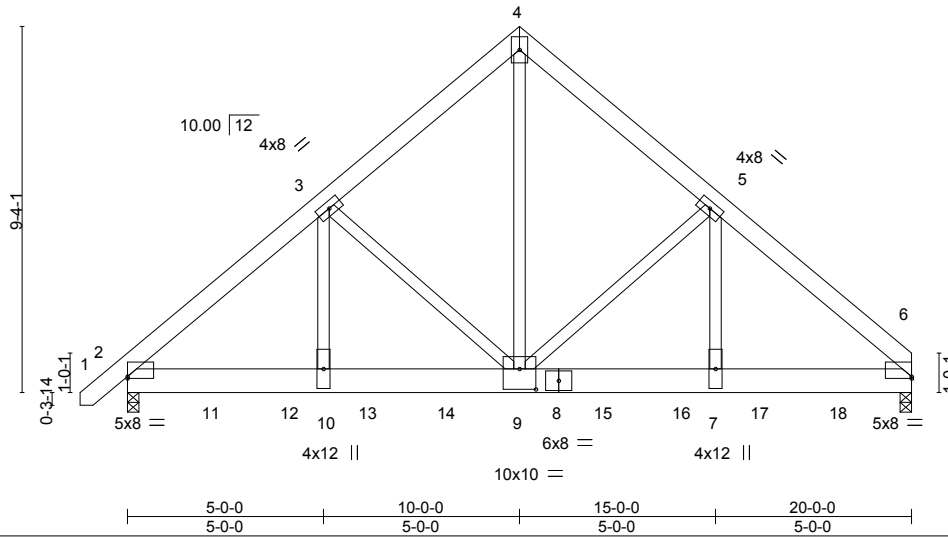

Plate Offsets (X,Y)-- [2:0-0-0,0-0-9], [6:Edge,0-0-9], [9:0-5-0,0-6-4]

LOADING (psf)	SPACING-	CSI.	DEFL.	PLATES	GRIP
TCLL 20.0	2-0-0	TC 0.61	in (loc) l/defl L/d	MT20	244/190
TCDL 10.0	Plate Grip DOL 1.15	BC 0.45	Vert(LL) -0.07 9-10 >999 360		
BCLL 0.0 *	Lumber DOL 1.15	WB 0.85	Vert(CT) -0.13 9-10 >999 240		
BCDL 10.0	Rep Stress Incr NO	Matrix-S	Horz(CT) 0.03 6 n/a n/a		
	Code IRC2015/TPI2014		Wind(LL) 0.05 9-10 >999 240	Weight: 341 lb	FT = 20%

**LUMBER-**

TOP CHORD 2x6 SP No.1  
 BOT CHORD 2x8 SP 2400F 2.0E  
 WEBS 2x4 SP No.2

**BRACING-**

TOP CHORD Structural wood sheathing directly applied or 5-7-9 oc purlins.  
 BOT CHORD Rigid ceiling directly applied or 10-0-0 oc bracing.

**REACTIONS.**

(size) 6=0-3-8, 2=0-3-8  
 Max Horz 2=217(LC 26)  
 Max Uplift 6=-424(LC 9), 2=-437(LC 8)  
 Max Grav 6=6844(LC 2), 2=6838(LC 2)

**FORCES.** (lb) - Max. Comp./Max. Ten. - All forces 250 (lb) or less except when shown.

TOP CHORD 2-3=-8399/550, 3-4=-5693/462, 4-5=-5691/461, 5-6=-8413/547  
 BOT CHORD 2-10=-410/6080, 9-10=-410/6081, 7-9=-340/6084, 6-7=-340/6083  
 WEBS 4-9=-485/6901, 5-9=-2367/286, 5-7=-162/3485, 3-9=-2363/282, 3-10=-164/3461

**NOTES-**

- 2-ply truss to be connected together with 10d (0.131"x3") nails as follows:  
 Top chords connected as follows: 2x6 - 2 rows staggered at 0-9-0 oc.  
 Bottom chords connected as follows: 2x8 - 2 rows staggered at 0-7-0 oc.  
 Webs connected as follows: 2x4 - 1 row at 0-9-0 oc.
- All loads are considered equally applied to all plies, except if noted as front (F) or back (B) face in the LOAD CASE(S) section. Ply to ply connections have been provided to distribute only loads noted as (F) or (B), unless otherwise indicated.
- Unbalanced roof live loads have been considered for this design.
- Wind: ASCE 7-10; Vult=130mph Vasd=103mph; TC DL=6.0psf; BCDL=6.0psf; h=15ft; Cat. II; Exp C; Enclosed; MWFRS (envelope); Lumber DOL=1.60 plate grip DOL=1.60
- This truss has been designed for a 10.0 psf bottom chord live load nonconcurrent with any other live loads.
- \* This truss has been designed for a live load of 30.0psf on the bottom chord in all areas where a rectangle 3-6-0 tall by 2-0-0 wide will fit between the bottom chord and any other members.
- Provide mechanical connection (by others) of truss to bearing plate capable of withstanding 100 lb uplift at joint(s) except (jt=lb) 6=424, 2=437.
- Hanger(s) or other connection device(s) shall be provided sufficient to support concentrated load(s) 1360 lb down and 95 lb up at 2-0-12, 1360 lb down and 95 lb up at 4-0-12, 1360 lb down and 95 lb up at 6-0-12, 1360 lb down and 95 lb up at 8-0-12, 1360 lb down and 95 lb up at 10-0-12, 1360 lb down and 95 lb up at 12-0-12, 1360 lb down and 95 lb up at 14-0-12, and 1360 lb down and 95 lb up at 16-0-12, and 1360 lb down and 95 lb up at 18-0-12 on bottom chord. The design/selection of such connection device(s) is the responsibility of others.

**LOAD CASE(S)** Standard

1) Dead + Roof Live (balanced): Lumber Increase=1.15, Plate Increase=1.15  
 Uniform Loads (plf)  
 Vert: 1-4=-60, 4-6=-60, 2-6=-20



March 1, 2023

Continued on page 2

**WARNING - Verify design parameters and READ NOTES ON THIS AND INCLUDED MITEK REFERENCE PAGE MII-7473 rev. 1/2/2023 BEFORE USE.**

Design valid for use only with MiTek® connectors. This design is based only upon parameters shown, and is for an individual building component, not a truss system. Before use, the building designer must verify the applicability of design parameters and properly incorporate this design into the overall building design. Bracing indicated is to prevent buckling of individual truss web and/or chord members only. Additional temporary and permanent bracing is always required for stability and to prevent collapse with possible personal injury and property damage. For general guidance regarding the fabrication, storage, delivery, erection and bracing of trusses and truss systems, see **ANSI/TP1 Quality Criteria and DSB-22** available from Truss Plate Institute (www.tpinst.org) and **BCSI Building Component Safety Information** available from the Structural Building Component Association (www.sbccomponents.com)



818 Soundside Road  
 Edenton, NC 27932

Job J0523-2576	Truss C1-GR	Truss Type COMMON GIRDER	Qty 1	Ply <b>2</b>	Lot 56 Liberty Meadow I56917884 Job Reference (optional)
-------------------	----------------	-----------------------------	----------	-----------------	--

Comtech, Inc. Fayetteville, NC - 28314,

8.430 s Jan 6 2022 MiTek Industries, Inc. Wed Mar 1 09:54:56 2023 Page 2  
ID:aTXuLo?nW09qtpROz2WQ0wydkZW-XGlp3tUVM4PYcUTA0tI00Vnd5hqqgzOA9cWU3DzfKAj

**LOAD CASE(S)** Standard

Concentrated Loads (lb)

Vert: 9=-1290(F) 11=-1290(F) 12=-1290(F) 13=-1290(F) 14=-1290(F) 15=-1290(F) 16=-1290(F) 17=-1290(F) 18=-1290(F)

**WARNING - Verify design parameters and READ NOTES ON THIS AND INCLUDED MITEK REFERENCE PAGE MII-7473 rev. 1/2/2023 BEFORE USE.**

Design valid for use only with MiTek® connectors. This design is based only upon parameters shown, and is for an individual building component, not a truss system. Before use, the building designer must verify the applicability of design parameters and properly incorporate this design into the overall building design. Bracing indicated is to prevent buckling of individual truss web and/or chord members only. Additional temporary and permanent bracing is always required for stability and to prevent collapse with possible personal injury and property damage. For general guidance regarding the fabrication, storage, delivery, erection and bracing of trusses and truss systems, see **ANSI/TP1 Quality Criteria and DSB-22** available from Truss Plate Institute ([www.tpinst.org](http://www.tpinst.org)) and **BCSI Building Component Safety Information** available from the Structural Building Component Association ([www.sbcacomponents.com](http://www.sbcacomponents.com))



818 Soundside Road  
Edenton, NC 27932

Job J0523-2576	Truss C1GE	Truss Type GABLE	Qty 1	Ply 1	Lot 56 Liberty Meadow I56917885
-------------------	---------------	---------------------	----------	----------	------------------------------------

Comtech, Inc. Fayetteville, NC - 28314,

8.430 s Jan 6 2022 MiTek Industries, Inc. Wed Mar 1 09:54:54 2023 Page 1

ID:aTXuLo7nW09qtpROz2WQ0wydkZW-btd3eBSFqT9rMAJovSFYx4hN?tAECAttil1O\_LzfKA1

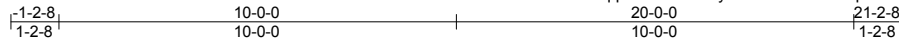

5x8 ||

Scale = 1:58.0

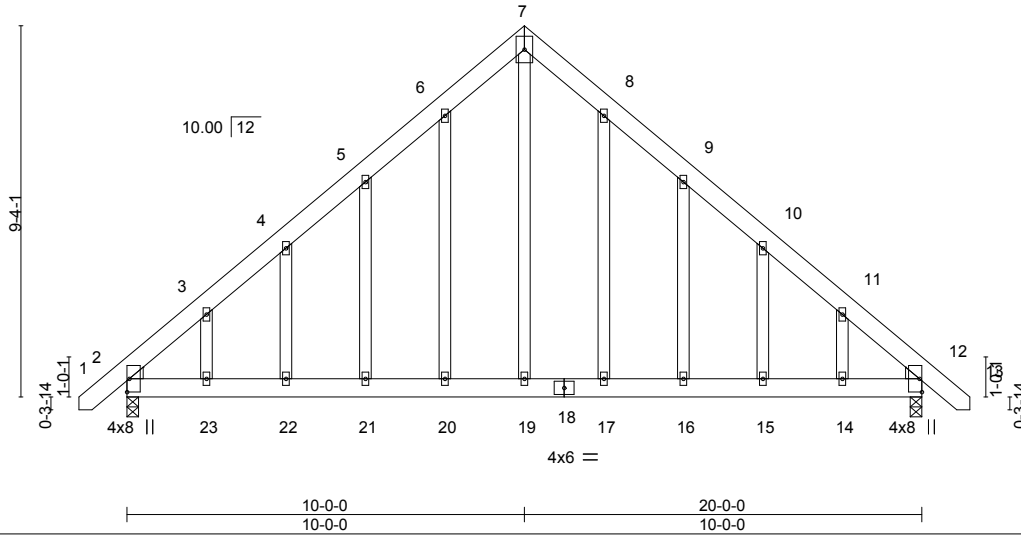

<b>LOADING</b> (psf)	<b>SPACING-</b>	2-0-0	<b>CSI.</b>	<b>DEFL.</b>	in (loc)	l/defl	L/d	<b>PLATES</b>	<b>GRIP</b>
TCLL 20.0	Plate Grip DOL	1.15	TC 0.20	Vert(LL)	-0.09 15-16	>999	360	MT20	244/190
TCDL 10.0	Lumber DOL	1.15	BC 0.40	Vert(CT)	-0.14 15-16	>999	240		
BCLL 0.0 *	Rep Stress Incr	YES	WB 0.40	Horz(CT)	0.01 12	n/a	n/a		
BCDL 10.0	Code IRC2015/TPI2014		Matrix-S	Wind(LL)	0.15 21-22	>999	240		
								Weight: 180 lb	FT = 20%

**LUMBER-**  
 TOP CHORD 2x6 SP No.1  
 BOT CHORD 2x6 SP No.1  
 WEBS 2x4 SP No.2  
 OTHERS 2x4 SP No.2  
 WEDGE  
 Left: 2x4 SP No.3 , Right: 2x4 SP No.3

**BRACING-**  
 TOP CHORD Structural wood sheathing directly applied or 6-0-0 oc purlins.  
 BOT CHORD Rigid ceiling directly applied or 10-0-0 oc bracing.

**REACTIONS.** (size) 12=0-3-8, 2=0-3-8  
 Max Horz 2=-276(LC 10)  
 Max Uplift 12=-169(LC 13), 2=-169(LC 12)  
 Max Grav 12=860(LC 1), 2=860(LC 1)

**FORCES.** (lb) - Max. Comp./Max. Ten. - All forces 250 (lb) or less except when shown.  
 TOP CHORD 2-3=-870/130, 3-4=-749/172, 4-5=-705/231, 5-6=-739/304, 6-7=-776/383, 7-8=-776/383,  
 8-9=-739/304, 9-10=-705/231, 10-11=-749/172, 11-12=-870/129  
 BOT CHORD 2-23=-39/567, 22-23=-39/567, 21-22=-39/567, 20-21=-39/567, 19-20=-39/567,  
 17-19=-39/567, 16-17=-39/567, 15-16=-39/567, 14-15=-39/567, 12-14=-39/567  
 WEBS 7-19=-309/660

- NOTES-**
- Unbalanced roof live loads have been considered for this design.
  - Wind: ASCE 7-10; Vult=130mph Vasd=103mph; TC DL=6.0psf; BCDL=6.0psf; h=15ft; Cat. II; Exp C; Enclosed; MWFRS (envelope) gable end zone and C-C Exterior(2) zone; C-C for members and forces & MWFRS for reactions shown; Lumber DOL=1.60 plate grip DOL=1.60
  - Truss designed for wind loads in the plane of the truss only. For studs exposed to wind (normal to the face), see Standard Industry Gable End Details as applicable, or consult qualified building designer as per ANSI/TPI 1.
  - All plates are 2x4 MT20 unless otherwise indicated.
  - Gable studs spaced at 2-0-0 oc.
  - This truss has been designed for a 10.0 psf bottom chord live load nonconcurrent with any other live loads.
  - \* This truss has been designed for a live load of 30.0psf on the bottom chord in all areas where a rectangle 3-6-0 tall by 2-0-0 wide will fit between the bottom chord and any other members.
  - Provide mechanical connection (by others) of truss to bearing plate capable of withstanding 100 lb uplift at joint(s) except (jt=lb) 12=169, 2=169.



March 1, 2023

**WARNING - Verify design parameters and READ NOTES ON THIS AND INCLUDED MITEK REFERENCE PAGE MII-7473 rev. 1/2/2023 BEFORE USE.**  
 Design valid for use only with MiTek® connectors. This design is based only upon parameters shown, and is for an individual building component, not a truss system. Before use, the building designer must verify the applicability of design parameters and properly incorporate this design into the overall building design. Bracing indicated is to prevent buckling of individual truss web and/or chord members only. Additional temporary and permanent bracing is always required for stability and to prevent collapse with possible personal injury and property damage. For general guidance regarding the fabrication, storage, delivery, erection and bracing of trusses and truss systems, see **ANSI/TPI1 Quality Criteria and DSB-22** available from Truss Plate Institute (www.tpinst.org) and **BCSI Building Component Safety Information** available from the Structural Building Component Association (www.sbcacomponents.com)





Job J0523-2576	Truss G1GE	Truss Type COMMON SUPPORTED GAB	Qty 1	Ply 1	Lot 56 Liberty Meadow I56917887
-------------------	---------------	------------------------------------	----------	----------	------------------------------------

Comtech, Inc. Fayetteville, NC - 28314,

8.430 s Jan 6 2022 MiTek Industries, Inc. Wed Mar 1 09:55:00 2023 Page 1

ID:aTXuLo?nW09qtpROz2WQ0wydkZW-Q1\_KvEX0PJw\_45nxFjMyALxRZIJPcyol4EUIc?zfkAf

Job Reference (optional)

1-2-8	23-0-0	46-0-0	47-2-8
1-2-8	23-0-0	23-0-0	1-2-8

Scale = 1:81.7

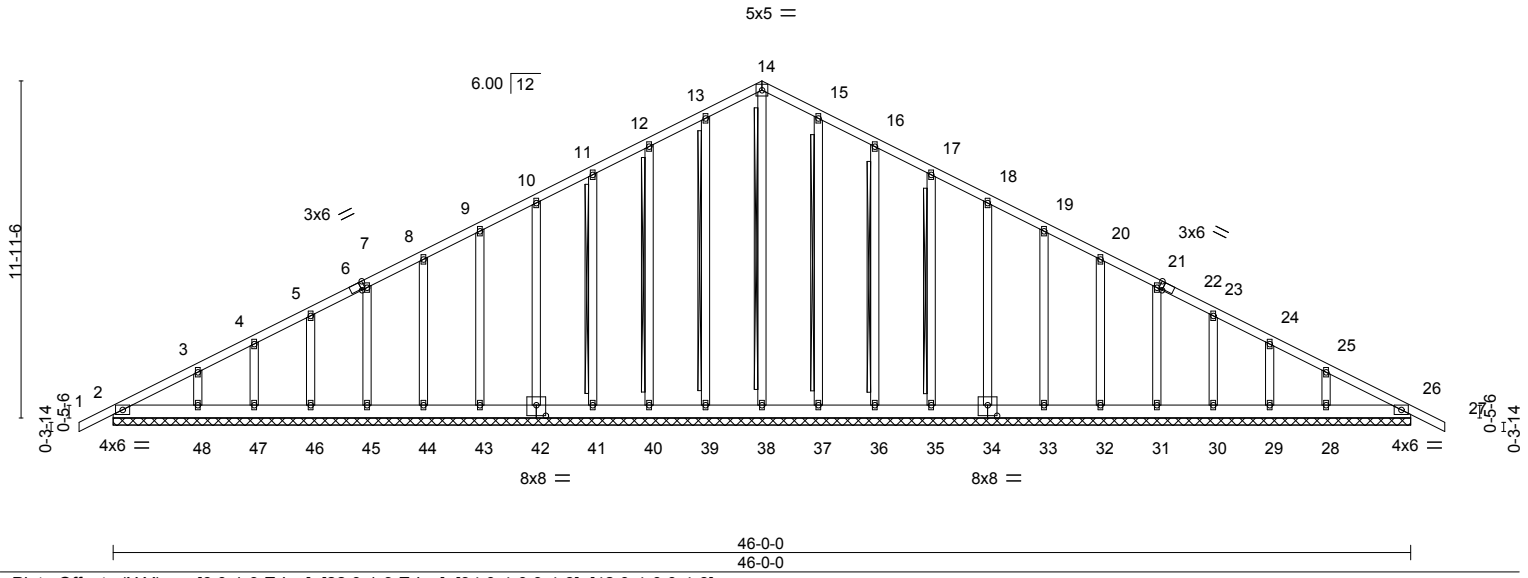

Plate Offsets (X,Y)--	[6:0-1-9,Edge], [22:0-1-9,Edge], [34:0-4-0,0-4-8], [42:0-4-0,0-4-8]				
<b>LOADING</b> (psf)	<b>SPACING-</b> 2-0-0	<b>CSI.</b>	<b>DEFL.</b> in (loc) l/defl L/d	<b>PLATES</b>	<b>GRIP</b>
TCLL 20.0	Plate Grip DOL 1.15	TC 0.07	Vert(LL) -0.00 27 n/r 120	MT20	244/190
TCDL 10.0	Lumber DOL 1.15	BC 0.03	Vert(CT) -0.00 27 n/r 120		
BCLL 0.0 *	Rep Stress Incr YES	WB 0.18	Horz(CT) 0.01 26 n/a n/a		
BCDL 10.0	Code IRC2015/TPI2014	Matrix-S			
				Weight: 376 lb	FT = 20%

<b>LUMBER-</b>	<b>BRACING-</b>
TOP CHORD 2x4 SP No.1	TOP CHORD Structural wood sheathing directly applied or 6-0-0 oc purlins.
BOT CHORD 2x6 SP No.1	BOT CHORD Rigid ceiling directly applied or 10-0-0 oc bracing.
OTHERS 2x4 SP No.2	WEBS T-Brace: 2x4 SPF No.2 - 14-38, 13-39, 12-40, 11-41, 15-37, 16-36, 17-35
	Fasten (2X) T and I braces to narrow edge of web with 10d (0.131"x3") nails, 6in o.c., with 3in minimum end distance.
	Brace must cover 90% of web length.

**REACTIONS.** All bearings 46-0-0.  
 (lb) - Max Horz 2=245(LC 16)  
 Max Uplift All uplift 100 lb or less at joint(s) 2, 39, 40, 41, 42, 43, 44, 45, 46, 47, 48, 37, 36, 35, 34, 33, 32, 31, 30, 29, 28, 26  
 Max Grav All reactions 250 lb or less at joint(s) 2, 38, 39, 40, 41, 42, 43, 44, 45, 46, 47, 48, 37, 36, 35, 34, 33, 32, 31, 30, 29, 28, 26

**FORCES.** (lb) - Max. Comp./Max. Ten. - All forces 250 (lb) or less except when shown.  
 TOP CHORD 2-3=-322/96, 11-12=-106/275, 12-13=-127/337, 13-14=-146/387, 14-15=-146/387, 15-16=-127/337, 16-17=-106/275  
 BOT CHORD 2-48=-82/271, 47-48=-82/271, 46-47=-82/271, 45-46=-82/271, 44-45=-82/271, 43-44=-82/271, 42-43=-82/271, 41-42=-82/271, 40-41=-82/271, 39-40=-82/271, 38-39=-82/271, 37-38=-82/271, 36-37=-82/271, 35-36=-82/271, 34-35=-82/271, 33-34=-82/271, 32-33=-82/271, 31-32=-82/271, 30-31=-82/271, 29-30=-82/271, 28-29=-82/271, 26-28=-82/271

- NOTES-**
- 1) Unbalanced roof live loads have been considered for this design.
  - 2) Wind: ASCE 7-10; Vult=130mph Vasd=103mph; TC DL=6.0psf; BCDL=6.0psf; h=15ft; Cat. II; Exp C; Enclosed; MWFRS (envelope) gable end zone and C-C Exterior(2) zone; C-C for members and forces & MWFRS for reactions shown; Lumber DOL=1.60 plate grip DOL=1.60
  - 3) Truss designed for wind loads in the plane of the truss only. For studs exposed to wind (normal to the face), see Standard Industry Gable End Details as applicable, or consult qualified building designer as per ANSI/TPI 1.
  - 4) All plates are 2x4 MT20 unless otherwise indicated.
  - 5) Gable requires continuous bottom chord bearing.
  - 6) Gable studs spaced at 2-0-0 oc.
  - 7) This truss has been designed for a 10.0 psf bottom chord live load nonconcurrent with any other live loads.
  - 8) \* This truss has been designed for a live load of 30.0psf on the bottom chord in all areas where a rectangle 3-6-0 tall by 2-0-0 wide will fit between the bottom chord and any other members.
  - 9) Provide mechanical connection (by others) of truss to bearing plate capable of withstanding 100 lb uplift at joint(s) 2, 39, 40, 41, 42, 43, 44, 45, 46, 47, 48, 37, 36, 35, 34, 33, 32, 31, 30, 29, 28, 26.
  - 10) Warning: Additional permanent and stability bracing for truss system (not part of this component design) is always required.

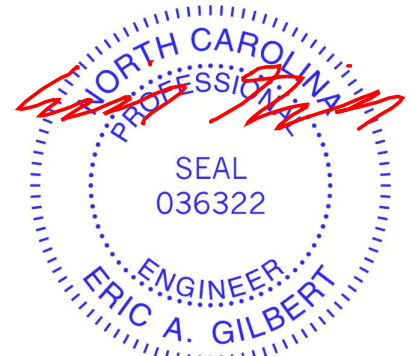

March 1, 2023

**WARNING - Verify design parameters and READ NOTES ON THIS AND INCLUDED MITEK REFERENCE PAGE MII-7473 rev. 1/2/2023 BEFORE USE.**  
 Design valid for use only with MiTek® connectors. This design is based only upon parameters shown, and is for an individual building component, not a truss system. Before use, the building designer must verify the applicability of design parameters and properly incorporate this design into the overall building design. Bracing indicated is to prevent buckling of individual truss web and/or chord members only. Additional temporary and permanent bracing is always required for stability and to prevent collapse with possible personal injury and property damage. For general guidance regarding the fabrication, storage, delivery, erection and bracing of trusses and truss systems, see **ANSI/TPI1 Quality Criteria and DSB-22** available from Truss Plate Institute (www.tpinst.org) and **BCSI Building Component Safety Information** available from the Structural Building Component Association (www.sbcacomponents.com)



818 Soundside Road  
 Edenton, NC 27932



Job J0523-2576	Truss J1	Truss Type MONO TRUSS	Qty 4	Ply 1	Lot 56 Liberty Meadow I56917888
-------------------	-------------	--------------------------	----------	----------	------------------------------------

Comtech, Inc. Fayetteville, NC - 28314,

8.430 s Jan 6 2022 MiTek Industries, Inc. Wed Mar 1 09:55:02 2023 Page 1

ID:aTXuLo?nW09qtpROz2WQ0wydkZW-MQ64KwYGxwAikPxKN8PQFm1j6zP4t52YzpzGtzfKAd



Scale = 1:14.8

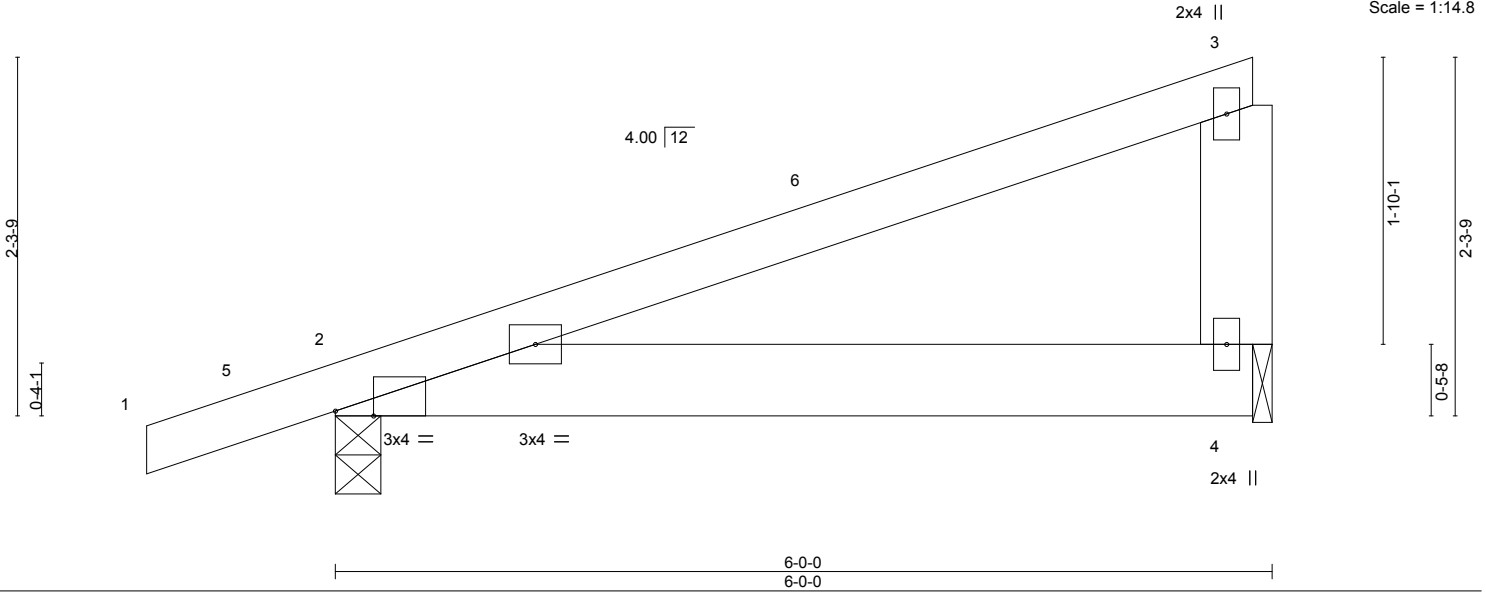

Plate Offsets (X,Y)--	[2:0-2-15,Edge]
-----------------------	-----------------

LOADING (psf)	SPACING-	2-0-0	CSI.	DEFL.	in (loc)	l/defl	L/d	PLATES	GRIP
TCLL 20.0	Plate Grip DOL	1.15	TC 0.41	Vert(LL)	-0.01	2-4	>999	MT20	244/190
TCDL 10.0	Lumber DOL	1.15	BC 0.12	Vert(CT)	-0.03	2-4	>999		
BCLL 0.0 *	Rep Stress Incr	YES	WB 0.00	Horz(CT)	0.00	n/a	n/a		
BCDL 10.0	Code IRC2015/TPI2014		Matrix-P	Wind(LL)	0.03	2-4	>999	Weight: 29 lb	FT = 20%

LUMBER-	BRACING-
TOP CHORD 2x4 SP No.1	TOP CHORD Structural wood sheathing directly applied or 6-0-0 oc purlins, except end verticals.
BOT CHORD 2x6 SP No.1	BOT CHORD Rigid ceiling directly applied or 10-0-0 oc bracing.
WEBS 2x6 SP No.1	

**REACTIONS.** (size) 2=0-3-8, 4=0-1-8  
 Max Horz 2=83(LC 8)  
 Max Uplift 2=-132(LC 8), 4=-90(LC 8)  
 Max Grav 2=316(LC 1), 4=215(LC 1)

**FORCES.** (lb) - Max. Comp./Max. Ten. - All forces 250 (lb) or less except when shown.

- NOTES-**
- 1) Wind: ASCE 7-10; Vult=130mph Vasd=103mph; TCDL=6.0psf; BCDL=6.0psf; h=15ft; Cat. II; Exp C; Enclosed; MWFRS (envelope) and C-C Exterior(2) -1-2-8 to 3-2-5, Interior(1) 3-2-5 to 5-9-4 zone; porch left exposed; C-C for members and forces & MWFRS for reactions shown; Lumber DOL=1.60 plate grip DOL=1.60
  - 2) This truss has been designed for a 10.0 psf bottom chord live load nonconcurrent with any other live loads.
  - 3) \* This truss has been designed for a live load of 30.0psf on the bottom chord in all areas where a rectangle 3-6-0 tall by 2-0-0 wide will fit between the bottom chord and any other members.
  - 4) Bearing at joint(s) 4 considers parallel to grain value using ANSI/TPI 1 angle to grain formula. Building designer should verify capacity of bearing surface.
  - 5) Provide mechanical connection (by others) of truss to bearing plate at joint(s) 4.
  - 6) Provide mechanical connection (by others) of truss to bearing plate capable of withstanding 100 lb uplift at joint(s) 4 except (jt=lb) 2=132.



March 1, 2023

Job J0523-2576	Truss J2	Truss Type MONOPIITCH	Qty 6	Ply 1	Lot 56 Liberty Meadow I56917889
-------------------	-------------	--------------------------	----------	----------	------------------------------------

Comtech, Inc. Fayetteville, NC - 28314,

8.430 s Jan 6 2022 MiTek Industries, Inc. Wed Mar 1 09:55:03 2023 Page 1

ID:aTXuLo?nW09qtpROz2WQ0wydkZW-qcgTXGZuiEIzYzVWxrwo\_ZvtWJHpKLCmCjMpJzfkAc



Scale = 1:12.5

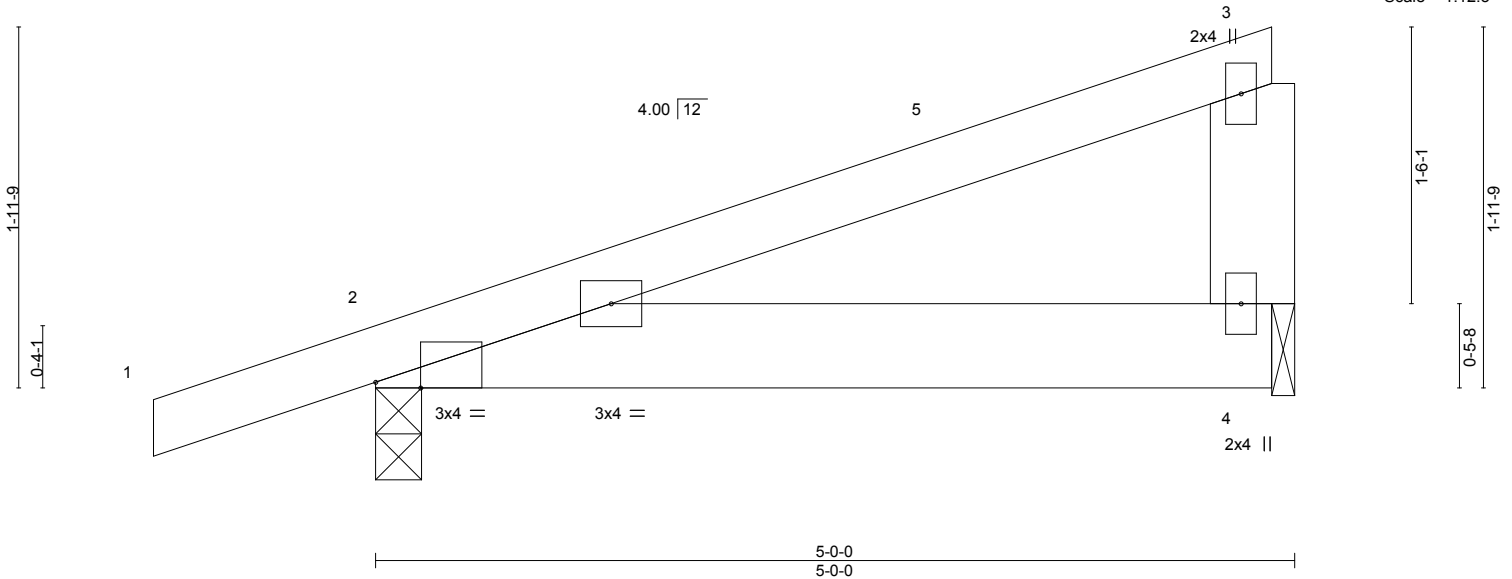

Plate Offsets (X,Y)-- [2:0-2-15,Edge]		CSI.		DEFL.		PLATES		GRIP	
LOADING (psf)	SPACING- 2-0-0	TC	0.26	in (loc)	l/defl	L/d	MT20	244/190	
TCLL 20.0	Plate Grip DOL 1.15	BC	0.08	Vert(LL) -0.01	2-4 >999	360			
TCDL 10.0	Lumber DOL 1.15	WB	0.00	Vert(CT) -0.01	2-4 >999	240			
BCLL 0.0 *	Rep Stress Incr YES	Matrix-P		Horz(CT) 0.00	n/a n/a				
BCDL 10.0	Code IRC2015/TPI2014			Wind(LL) 0.01	2-4 >999	240	Weight: 24 lb	FT = 20%	

LUMBER-		BRACING-	
TOP CHORD	2x4 SP No.1	TOP CHORD	Structural wood sheathing directly applied or 5-0-0 oc purlins, except end verticals.
BOT CHORD	2x6 SP No.1	BOT CHORD	Rigid ceiling directly applied or 10-0-0 oc bracing.
WEBS	2x6 SP No.1		

**REACTIONS.** (size) 2=0-3-0, 4=0-1-8  
 Max Horz 2=72(LC 8)  
 Max Uplift 2=-119(LC 8), 4=-72(LC 8)  
 Max Grav 2=277(LC 1), 4=174(LC 1)

**FORCES.** (lb) - Max. Comp./Max. Ten. - All forces 250 (lb) or less except when shown.

**NOTES-**

- 1) Wind: ASCE 7-10; Vult=130mph Vasd=103mph; TCDL=6.0psf; BCDL=6.0psf; h=15ft; Cat. II; Exp C; Enclosed; MWFRS (envelope) and C-C Exterior(2) -1-2-8 to 3-2-5, Interior(1) 3-2-5 to 4-9-4 zone; porch left exposed; C-C for members and forces & MWFRS for reactions shown; Lumber DOL=1.60 plate grip DOL=1.60
- 2) This truss has been designed for a 10.0 psf bottom chord live load nonconcurrent with any other live loads.
- 3) \* This truss has been designed for a live load of 30.0psf on the bottom chord in all areas where a rectangle 3-6-0 tall by 2-0-0 wide will fit between the bottom chord and any other members.
- 4) Bearing at joint(s) 4 considers parallel to grain value using ANSI/TPI 1 angle to grain formula. Building designer should verify capacity of bearing surface.
- 5) Provide mechanical connection (by others) of truss to bearing plate at joint(s) 4.
- 6) Provide mechanical connection (by others) of truss to bearing plate capable of withstanding 100 lb uplift at joint(s) 4 except (jt=lb) 2=119.

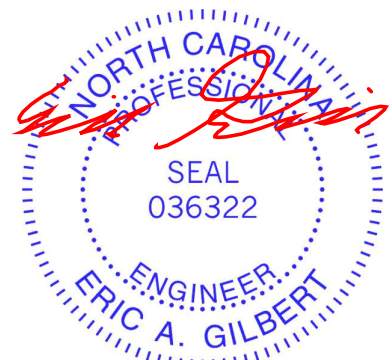

March 1, 2023

<p><b>WARNING - Verify design parameters and READ NOTES ON THIS AND INCLUDED MITEK REFERENCE PAGE MII-7473 rev. 1/2/2023 BEFORE USE.</b></p> <p>Design valid for use only with MiTek® connectors. This design is based only upon parameters shown, and is for an individual building component, not a truss system. Before use, the building designer must verify the applicability of design parameters and properly incorporate this design into the overall building design. Bracing indicated is to prevent buckling of individual truss web and/or chord members only. Additional temporary and permanent bracing is always required for stability and to prevent collapse with possible personal injury and property damage. For general guidance regarding the fabrication, storage, delivery, erection and bracing of trusses and truss systems, see <b>ANSI/TPI1 Quality Criteria and DSB-22</b> available from Truss Plate Institute (www.tpinst.org) and <b>BCSI Building Component Safety Information</b> available from the Structural Building Component Association (www.sbcacomponents.com)</p>	<p>818 Soundside Road Edenton, NC 27932</p>
---	---

Job J0523-2576	Truss J2GE	Truss Type MONOPITCH SUPPORTED	Qty 1	Ply 1	Lot 56 Liberty Meadow Job Reference (optional)	156917890
-------------------	---------------	-----------------------------------	----------	----------	---	-----------

Comtech, Inc. Fayetteville, NC - 28314,

8.430 s Jan 6 2022 MiTek Industries, Inc. Wed Mar 1 09:55:05 2023 Page 1

ID:aTXuLo?nW09qtpROz2WQ0wydkZW-m?oDyyb9ErYHBSfv2Gy7tPflJ0hHEMVEWCTtCzfkAa

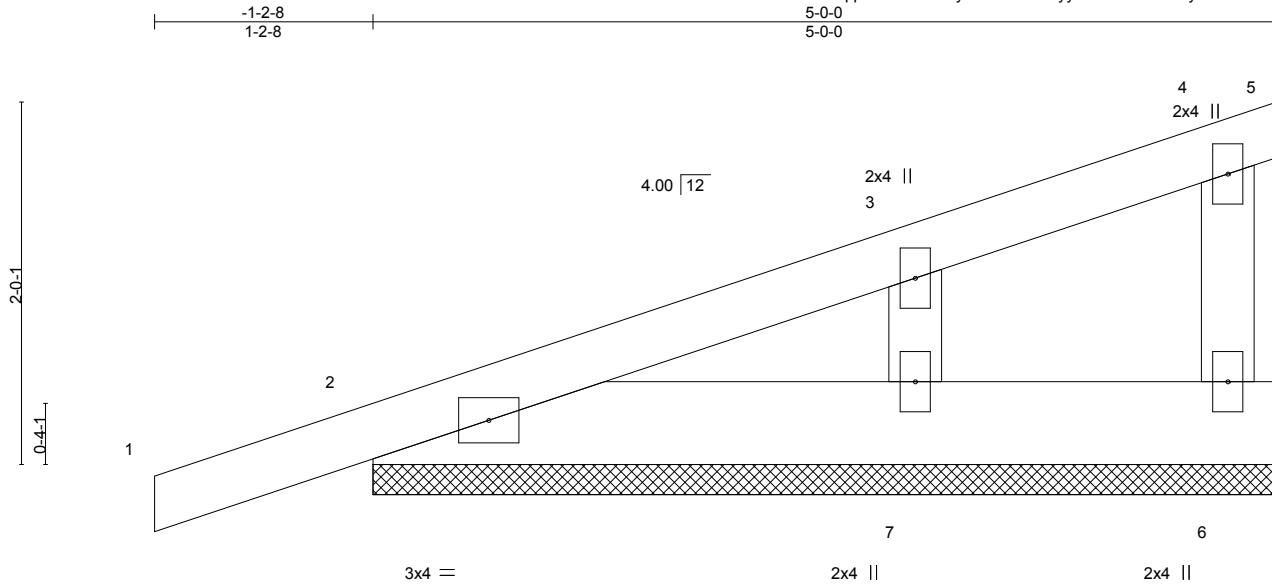

Scale = 1:12.7

LOADING (psf)	SPACING-	2-0-0	CSI.	DEFL.	in (loc)	l/defl	L/d	PLATES	GRIP
TCLL 20.0	Plate Grip DOL	1.15	TC 0.07	Vert(LL)	0.00	1	n/r	MT20	244/190
TCDL 10.0	Lumber DOL	1.15	BC 0.02	Vert(CT)	0.00	1	n/r		
BCLL 0.0 *	Rep Stress Incr	YES	WB 0.03	Horz(CT)	-0.00	5	n/a		
BCDL 10.0	Code IRC2015/TPI2014		Matrix-P					Weight: 24 lb	FT = 20%

**LUMBER-**  
TOP CHORD 2x4 SP No.1  
BOT CHORD 2x6 SP No.1  
WEBS 2x4 SP No.2  
OTHERS 2x4 SP No.2

**BRACING-**  
TOP CHORD Structural wood sheathing directly applied or 5-0-0 oc purlins, except end verticals.  
BOT CHORD Rigid ceiling directly applied or 10-0-0 oc bracing.

**REACTIONS.** All bearings 5-0-0.  
(lb) - Max Horz 2=104(LC 8)  
Max Uplift All uplift 100 lb or less at joint(s) 5, 6, 2, 7  
Max Grav All reactions 250 lb or less at joint(s) 5, 6, 2, 7

**FORCES.** (lb) - Max. Comp./Max. Ten. - All forces 250 (lb) or less except when shown.

**NOTES-**

- 1) Wind: ASCE 7-10; Vult=130mph Vasd=103mph; TC DL=6.0psf; BCDL=6.0psf; h=15ft; Cat. II; Exp C; Enclosed; MWFRS (envelope) gable end zone and C-C Exterior(2) zone; C-C for members and forces & MWFRS for reactions shown; Lumber DOL=1.60 plate grip DOL=1.60
- 2) Truss designed for wind loads in the plane of the truss only. For studs exposed to wind (normal to the face), see Standard Industry Gable End Details as applicable, or consult qualified building designer as per ANSI/TPI 1.
- 3) Gable requires continuous bottom chord bearing.
- 4) Gable studs spaced at 2-0-0 oc.
- 5) This truss has been designed for a 10.0 psf bottom chord live load nonconcurrent with any other live loads.
- 6) \* This truss has been designed for a live load of 30.0psf on the bottom chord in all areas where a rectangle 3-6-0 tall by 2-0-0 wide will fit between the bottom chord and any other members.
- 7) Provide mechanical connection (by others) of truss to bearing plate capable of withstanding 100 lb uplift at joint(s) 5, 6, 2, 7.
- 8) Beveled plate or shim required to provide full bearing surface with truss chord at joint(s) 2.

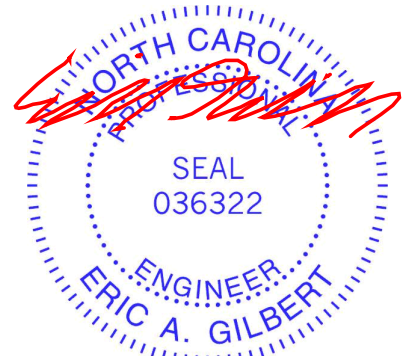

March 1, 2023

**WARNING - Verify design parameters and READ NOTES ON THIS AND INCLUDED MITEK REFERENCE PAGE MII-7473 rev. 1/2/2023 BEFORE USE.**

Design valid for use only with MiTek® connectors. This design is based only upon parameters shown, and is for an individual building component, not a truss system. Before use, the building designer must verify the applicability of design parameters and properly incorporate this design into the overall building design. Bracing indicated is to prevent buckling of individual truss web and/or chord members only. Additional temporary and permanent bracing is always required for stability and to prevent collapse with possible personal injury and property damage. For general guidance regarding the fabrication, storage, delivery, erection and bracing of trusses and truss systems, see **ANSI/TPI1 Quality Criteria and DSB-22** available from Truss Plate Institute ([www.tpinst.org](http://www.tpinst.org)) and **BCSI Building Component Safety Information** available from the Structural Building Component Association ([www.sbcacomponents.com](http://www.sbcacomponents.com))



818 Soundside Road  
Edenton, NC 27932

Job J0523-2576	Truss J3	Truss Type MONOPICH	Qty 9	Ply 1	Lot 56 Liberty Meadow Job Reference (optional)	I56917891
-------------------	-------------	------------------------	----------	----------	---	-----------

Comtech, Inc. Fayetteville, NC - 28314,

8.430 s Jan 6 2022 MiTek Industries, Inc. Wed Mar 1 09:55:06 2023 Page 1

ID:aTXuLo?nW09qtpROz2WQ0wydkZW-FBMb9Icn?9g8p0E5c\_TMqcbTmjMk0h\_eTAX0PezfKAZ



Scale = 1:10.1

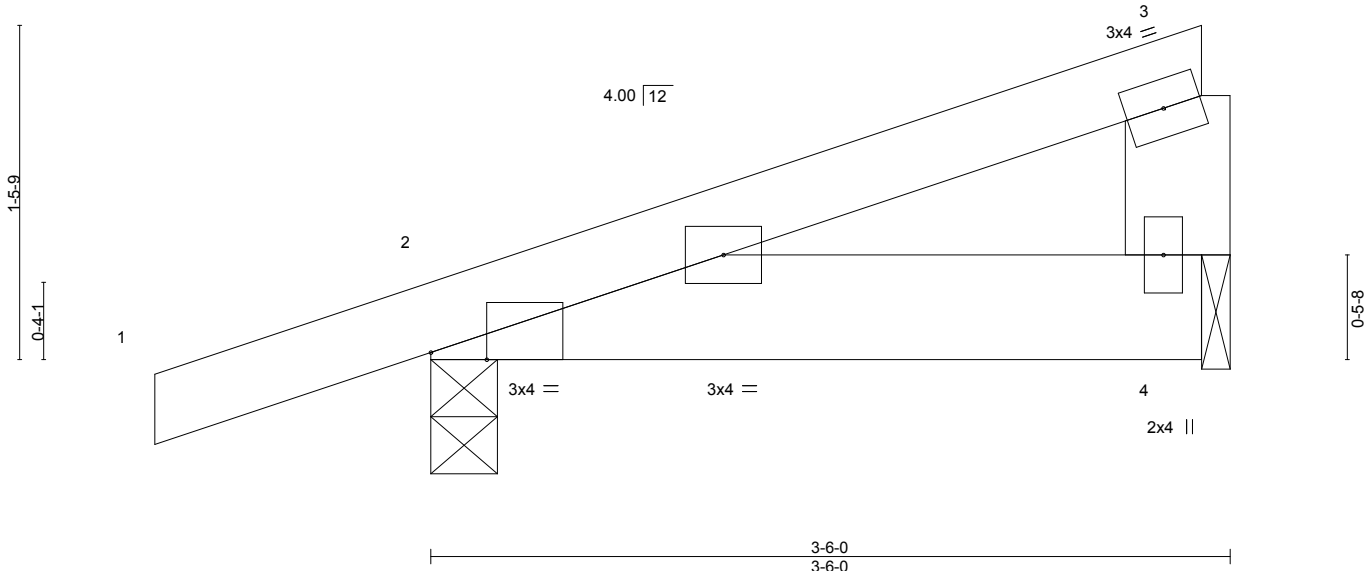

LOADING (psf)	SPACING-	2-0-0	CSI.	DEFL.	in (loc)	l/defl	L/d	PLATES	GRIP
TCLL 20.0	Plate Grip DOL	1.15	TC 0.09	Vert(LL)	-0.00	2-4	>999	MT20	244/190
TCDL 10.0	Lumber DOL	1.15	BC 0.03	Vert(CT)	-0.00	2-4	>999		
BCLL 0.0 *	Rep Stress Incr	YES	WB 0.01	Horz(CT)	0.00	n/a	n/a		
BCDL 10.0	Code IRC2015/TPI2014		Matrix-P	Wind(LL)	0.00	2	****	Weight: 17 lb	FT = 20%

LUMBER-	BRACING-
TOP CHORD 2x4 SP No.1	TOP CHORD Structural wood sheathing directly applied or 3-6-0 oc purlins.
BOT CHORD 2x6 SP No.1	BOT CHORD Rigid ceiling directly applied or 10-0-0 oc bracing.
WEBS 2x6 SP No.1	

**REACTIONS.** (size) 2=0-3-8, 4=0-1-8  
 Max Horz 2=56(LC 8)  
 Max Uplift 2=-69(LC 8), 4=-14(LC 12)  
 Max Grav 2=224(LC 1), 4=107(LC 1)

**FORCES.** (lb) - Max. Comp./Max. Ten. - All forces 250 (lb) or less except when shown.

**NOTES-**

- 1) Wind: ASCE 7-10; Vult=130mph Vasd=103mph; TCDL=6.0psf; BCDL=6.0psf; h=15ft; Cat. II; Exp C; Enclosed; MWFRS (envelope) and C-C Exterior(2) zone; C-C for members and forces & MWFRS for reactions shown; Lumber DOL=1.60 plate grip DOL=1.60
- 2) This truss has been designed for a 10.0 psf bottom chord live load nonconcurrent with any other live loads.
- 3) \* This truss has been designed for a live load of 30.0psf on the bottom chord in all areas where a rectangle 3-6-0 tall by 2-0-0 wide will fit between the bottom chord and any other members.
- 4) Bearing at joint(s) 4 considers parallel to grain value using ANSI/TPI 1 angle to grain formula. Building designer should verify capacity of bearing surface.
- 5) Provide mechanical connection (by others) of truss to bearing plate at joint(s) 4.
- 6) Provide mechanical connection (by others) of truss to bearing plate capable of withstanding 100 lb uplift at joint(s) 2, 4.

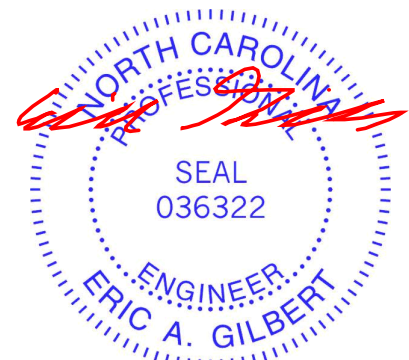

March 1, 2023

Job J0523-2576	Truss J3GE	Truss Type MONOPITCH SUPPORTED	Qty 2	Ply 1	Lot 56 Liberty Meadow 156917892
-------------------	---------------	-----------------------------------	----------	----------	------------------------------------

Comtech, Inc. Fayetteville, NC - 28314,

8.430 s Jan 6 2022 MiTek Industries, Inc. Wed Mar 1 09:55:07 2023 Page 1

ID:aTXuLo?nW09qtpROz2WQ0wydkZW-jNvzNecPmSo?QApHAh\_byqkdo7iBI84nhqhay5zfrKAY

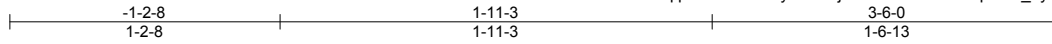

Scale = 1:10.3

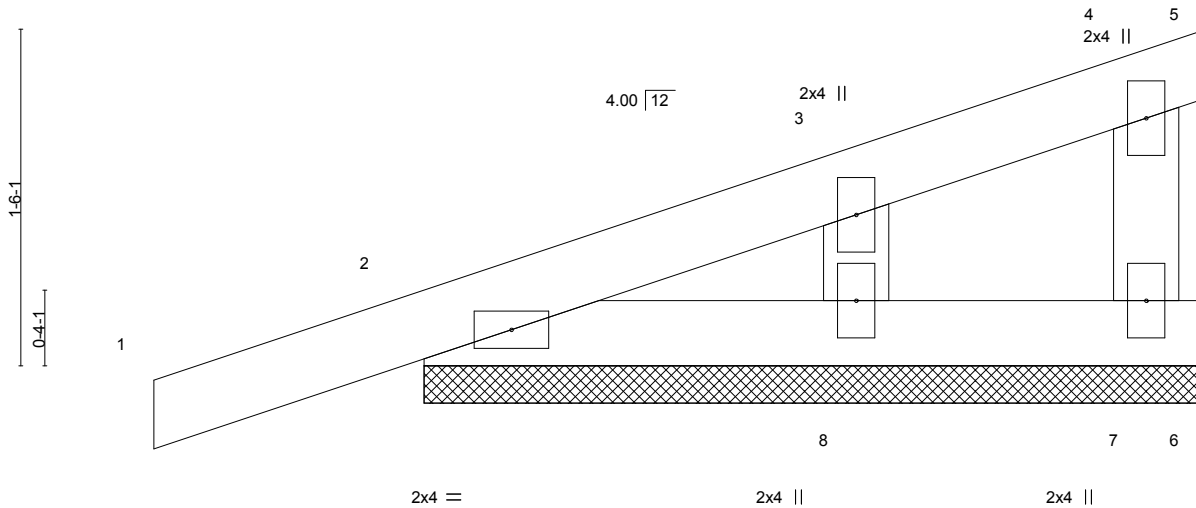

LOADING (psf)	SPACING-	2-0-0	CSI.	DEFL.	in (loc)	l/defl	L/d	PLATES	GRIP	
TCLL 20.0	Plate Grip DOL	1.15	TC 0.07	Vert(LL)	0.00	4	n/r	120	MT20	244/190
TCDL 10.0	Lumber DOL	1.15	BC 0.02	Vert(CT)	0.00	4	n/r	120		
BCLL 0.0 *	Rep Stress Incr	YES	WB 0.02	Horz(CT)	0.00		n/a	n/a		
BCDL 10.0	Code IRC2015/TPI2014		Matrix-P							
								Weight: 15 lb	FT = 20%	

**LUMBER-**  
 TOP CHORD 2x4 SP No.1  
 BOT CHORD 2x4 SP No.1  
 WEBS 2x4 SP No.2

**BRACING-**  
 TOP CHORD Structural wood sheathing directly applied or 3-6-0 oc purlins, except end verticals.  
 BOT CHORD Rigid ceiling directly applied or 10-0-0 oc bracing.

**REACTIONS.** (size) 7=3-6-0, 2=3-6-0, 8=3-6-0  
 Max Horz 2=79(LC 8)  
 Max Uplift 7=-26(LC 8), 2=-91(LC 8), 8=-38(LC 12)  
 Max Grav 7=52(LC 1), 2=164(LC 1), 8=125(LC 1)

**FORCES.** (lb) - Max. Comp./Max. Ten. - All forces 250 (lb) or less except when shown.

**NOTES-**

- 1) Wind: ASCE 7-10; Vult=130mph Vasd=103mph; TCCL=6.0psf; BCDL=6.0psf; h=15ft; Cat. II; Exp C; Enclosed; MWFRS (envelope) gable end zone and C-C Exterior(2) zone; C-C for members and forces & MWFRS for reactions shown; Lumber DOL=1.60 plate grip DOL=1.60
- 2) Truss designed for wind loads in the plane of the truss only. For studs exposed to wind (normal to the face), see Standard Industry Gable End Details as applicable, or consult qualified building designer as per ANSI/TPI 1.
- 3) Gable requires continuous bottom chord bearing.
- 4) Gable studs spaced at 2-0-0 oc.
- 5) This truss has been designed for a 10.0 psf bottom chord live load nonconcurrent with any other live loads.
- 6) \* This truss has been designed for a live load of 30.0psf on the bottom chord in all areas where a rectangle 3-6-0 tall by 2-0-0 wide will fit between the bottom chord and any other members.
- 7) Provide mechanical connection (by others) of truss to bearing plate capable of withstanding 100 lb uplift at joint(s) 7, 2, 8.

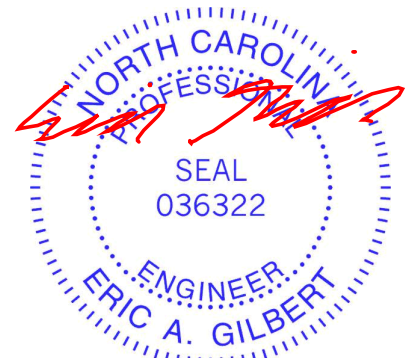

March 1, 2023

**WARNING - Verify design parameters and READ NOTES ON THIS AND INCLUDED MITEK REFERENCE PAGE MII-7473 rev. 1/2/2023 BEFORE USE.**

Design valid for use only with MiTek® connectors. This design is based only upon parameters shown, and is for an individual building component, not a truss system. Before use, the building designer must verify the applicability of design parameters and properly incorporate this design into the overall building design. Bracing indicated is to prevent buckling of individual truss web and/or chord members only. Additional temporary and permanent bracing is always required for stability and to prevent collapse with possible personal injury and property damage. For general guidance regarding the fabrication, storage, delivery, erection and bracing of trusses and truss systems, see **ANSI/TPI1 Quality Criteria and DSB-22** available from Truss Plate Institute (www.tpinst.org) and **BCSI Building Component Safety Information** available from the Structural Building Component Association (www.sbcacomponents.com)



818 Soundside Road  
 Edenton, NC 27932

Job J0523-2576	Truss V1	Truss Type VALLEY	Qty 1	Ply 1	Lot 56 Liberty Meadow 156917893
-------------------	-------------	----------------------	----------	----------	------------------------------------

Comtech, Inc. Fayetteville, NC - 28314,

8.430 s Jan 6 2022 MiTek Industries, Inc. Wed Mar 1 09:55:08 2023 Page 1

ID:aTXuLo?nW09qtpROz2WQ0wydkZW-BaTMazd1Xmwr2KOUjPVqV1Hm3X0zUZWxwUQ7UXzfkAX

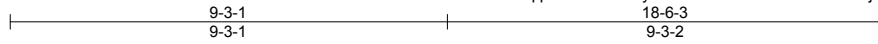

4x4 =

Scale = 1:48.8

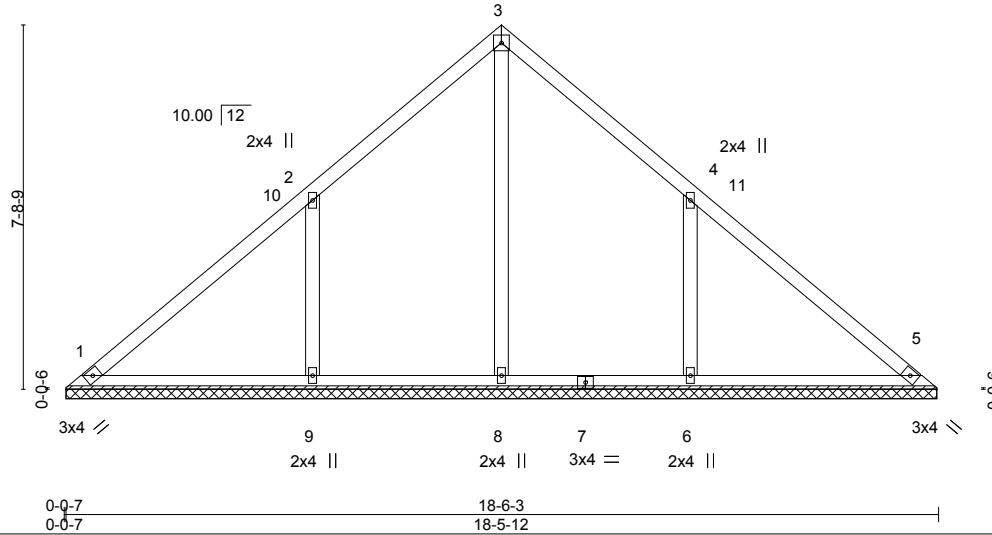

Plate Offsets (X,Y)--	[4:0-0-0,0-0-0]
-----------------------	-----------------

<b>LOADING</b> (psf)	<b>SPACING-</b> 2-0-0	<b>CSI.</b>	<b>DEFL.</b> in (loc) l/defl L/d	<b>PLATES</b>	<b>GRIP</b>
TCLL 20.0	Plate Grip DOL 1.15	TC 0.23	Vert(LL) n/a - n/a 999	MT20	244/190
TCDL 10.0	Lumber DOL 1.15	BC 0.18	Vert(CT) n/a - n/a 999		
BCLL 0.0 *	Rep Stress Incr YES	WB 0.13	Horz(CT) 0.00 5 n/a n/a		
BCDL 10.0	Code IRC2015/TPI2014	Matrix-S		Weight: 84 lb	FT = 20%

<b>LUMBER-</b>	<b>BRACING-</b>
TOP CHORD 2x4 SP No.1	TOP CHORD Structural wood sheathing directly applied or 6-0-0 oc purlins.
BOT CHORD 2x4 SP No.1	BOT CHORD Rigid ceiling directly applied or 10-0-0 oc bracing.
OTHERS 2x4 SP No.2	

**REACTIONS.** All bearings 18-5-5.  
 (lb) - Max Horz 1=177(LC 11)  
 Max Uplift All uplift 100 lb or less at joint(s) 1 except 9=-172(LC 12), 6=-172(LC 13)  
 Max Grav All reactions 250 lb or less at joint(s) 1, 5 except 8=411(LC 22), 9=560(LC 19), 6=560(LC 20)

**FORCES.** (lb) - Max. Comp./Max. Ten. - All forces 250 (lb) or less except when shown.  
 WEBS 2-9=-428/293, 4-6=-428/292

- NOTES-**
- 1) Unbalanced roof live loads have been considered for this design.
  - 2) Wind: ASCE 7-10; Vult=130mph Vasd=103mph; TCDL=6.0psf; BCDL=6.0psf; h=15ft; Cat. II; Exp C; Enclosed; MWFRS (envelope) and C-C Exterior(2) 0-4-13 to 4-9-10, Interior(1) 4-9-10 to 9-3-1, Exterior(2) 9-3-1 to 13-7-14, Interior(1) 13-7-14 to 18-1-6 zone; C-C for members and forces & MWFRS for reactions shown; Lumber DOL=1.60 plate grip DOL=1.60
  - 3) Gable requires continuous bottom chord bearing.
  - 4) This truss has been designed for a 10.0 psf bottom chord live load nonconcurrent with any other live loads.
  - 5) \* This truss has been designed for a live load of 30.0psf on the bottom chord in all areas where a rectangle 3-6-0 tall by 2-0-0 wide will fit between the bottom chord and any other members, with BCDL = 10.0psf.
  - 6) Provide mechanical connection (by others) of truss to bearing plate capable of withstanding 100 lb uplift at joint(s) 1 except (jt=lb) 9=172, 6=172.

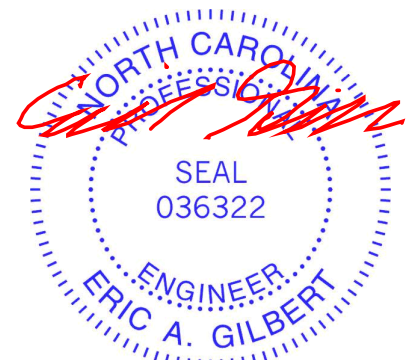

March 1, 2023

<p><b>WARNING - Verify design parameters and READ NOTES ON THIS AND INCLUDED MITEK REFERENCE PAGE MII-7473 rev. 1/2/2023 BEFORE USE.</b></p> <p>Design valid for use only with MiTek® connectors. This design is based only upon parameters shown, and is for an individual building component, not a truss system. Before use, the building designer must verify the applicability of design parameters and properly incorporate this design into the overall building design. Bracing indicated is to prevent buckling of individual truss web and/or chord members only. Additional temporary and permanent bracing is always required for stability and to prevent collapse with possible personal injury and property damage. For general guidance regarding the fabrication, storage, delivery, erection and bracing of trusses and truss systems, see <b>ANSI/TP1 Quality Criteria and DSB-22</b> available from Truss Plate Institute (www.tpinst.org) and <b>BCSI Building Component Safety Information</b> available from the Structural Building Component Association (www.sbcacomponents.com)</p>	<p>ENGINEERING BY</p> <p><b>TRENCO</b></p> <p>A MiTek Affiliate</p> <p>818 Soundside Road Edenton, NC 27932</p>
--	---



Job J0523-2576	Truss V2	Truss Type VALLEY	Qty 1	Ply 1	Lot 56 Liberty Meadow I56917894
-------------------	-------------	----------------------	----------	----------	------------------------------------

Comtech, Inc. Fayetteville, NC - 28314,

8.430 s Jan 6 2022 MiTek Industries, Inc. Wed Mar 1 09:55:10 2023 Page 1

ID:aTXuLo?nW09qtpROz2WQ0wydkZW-7yb6?ffl3NAZHdYsrqYlaSM7mKhayUWENovEYPzfKAV



4x4 =

Scale = 1:41.4

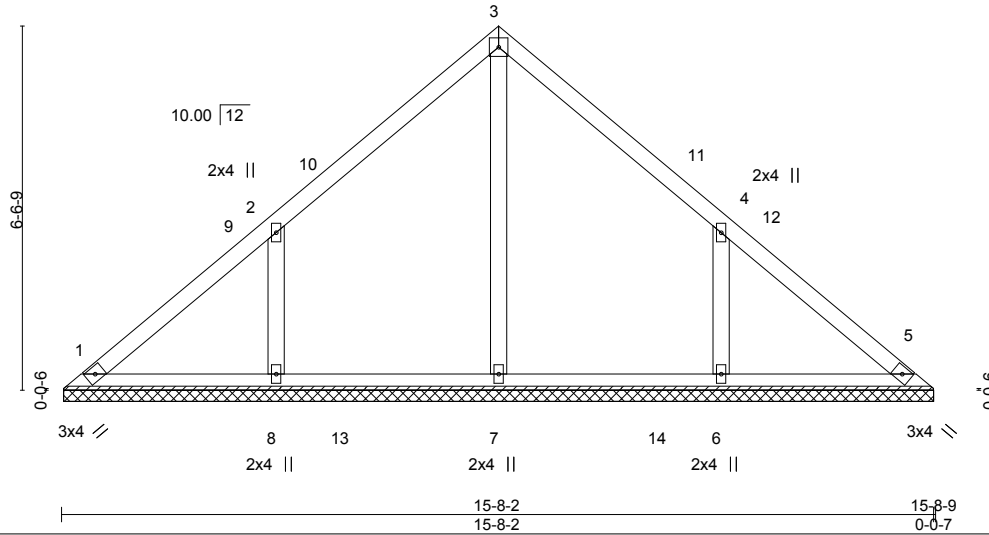

Plate Offsets (X,Y)-- [4:0-0-0,0-0-0]

<b>LOADING</b> (psf)	<b>SPACING-</b> 2-0-0	<b>CSI.</b>	<b>DEFL.</b> in (loc) l/defl L/d	<b>PLATES</b>	<b>GRIP</b>
TCLL 20.0	Plate Grip DOL 1.15	TC 0.15	Vert(LL) n/a - n/a 999	MT20	244/190
TCDL 10.0	Lumber DOL 1.15	BC 0.17	Vert(CT) n/a - n/a 999		
BCLL 0.0 *	Rep Stress Incr YES	WB 0.10	Horz(CT) 0.00 5 n/a n/a		
BCDL 10.0	Code IRC2015/TPI2014	Matrix-S		Weight: 69 lb	FT = 20%

**LUMBER-**  
TOP CHORD 2x4 SP No.1  
BOT CHORD 2x4 SP No.1  
OTHERS 2x4 SP No.2

**BRACING-**  
TOP CHORD Structural wood sheathing directly applied or 6-0-0 oc purlins.  
BOT CHORD Rigid ceiling directly applied or 10-0-0 oc bracing.

**REACTIONS.** All bearings 15-7-11.  
(lb) - Max Horz 1=-149(LC 8)  
Max Uplift All uplift 100 lb or less at joint(s) 1 except 8=-143(LC 12), 6=-142(LC 13)  
Max Grav All reactions 250 lb or less at joint(s) 1, 5 except 7=411(LC 19), 8=429(LC 19), 6=429(LC 20)

**FORCES.** (lb) - Max. Comp./Max. Ten. - All forces 250 (lb) or less except when shown.  
**WEBS** 2-8=-356/254, 4-6=-356/254

- NOTES-**
- Unbalanced roof live loads have been considered for this design.
  - Wind: ASCE 7-10; Vult=130mph Vasd=103mph; TCDL=6.0psf; BCDL=6.0psf; h=15ft; Cat. II; Exp C; Enclosed; MWFRS (envelope) and C-C Exterior(2) 0-4-13 to 4-9-10, Interior(1) 4-9-10 to 7-10-5, Exterior(2) 7-10-5 to 12-3-1, Interior(1) 12-3-1 to 15-3-12 zone; C-C for members and forces & MWFRS for reactions shown; Lumber DOL=1.60 plate grip DOL=1.60
  - Gable requires continuous bottom chord bearing.
  - This truss has been designed for a 10.0 psf bottom chord live load nonconcurrent with any other live loads.
  - \* This truss has been designed for a live load of 30.0psf on the bottom chord in all areas where a rectangle 3-6-0 tall by 2-0-0 wide will fit between the bottom chord and any other members, with BCDL = 10.0psf.
  - Provide mechanical connection (by others) of truss to bearing plate capable of withstanding 100 lb uplift at joint(s) 1 except (jt=lb) 8=143, 6=142.

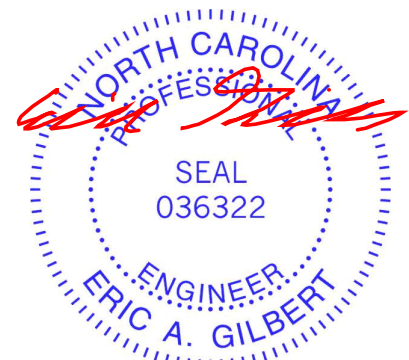

March 1, 2023

Job J0523-2576	Truss V3	Truss Type VALLEY	Qty 1	Ply 1	Lot 56 Liberty Meadow I56917895
-------------------	-------------	----------------------	----------	----------	------------------------------------

Comtech, Inc. Fayetteville, NC - 28314,

8.430 s Jan 6 2022 MiTek Industries, Inc. Wed Mar 1 09:55:11 2023 Page 1

ID:aTXuLo?nW09qtpROz2WQ0wydkZW-b99UD?fwphiQvn73PX3X7gvlsk22hxFNcSfn5szfKAU

Job Reference (optional)

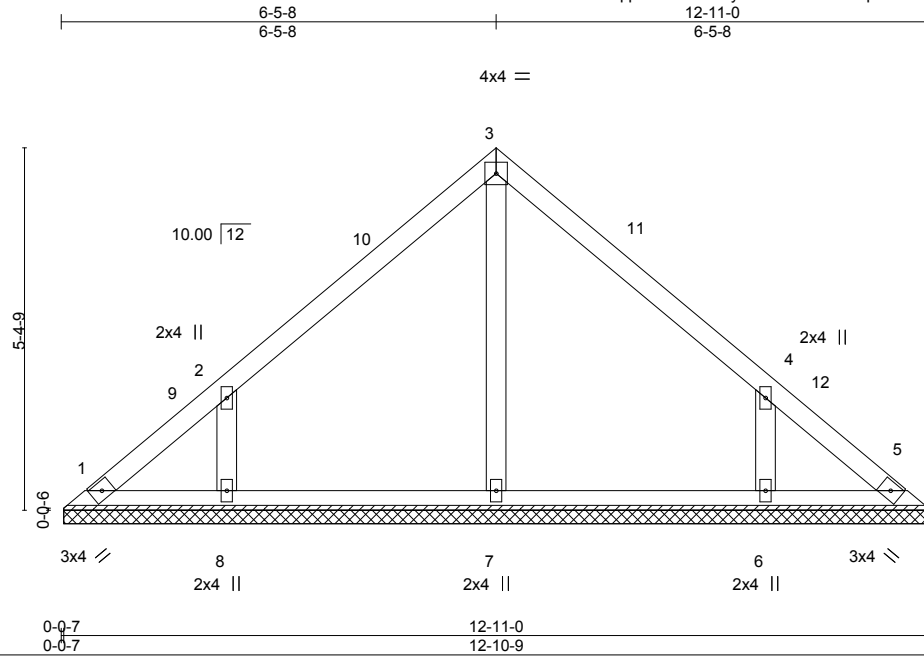

Scale = 1:34.2

Plate Offsets (X,Y)--	[4:0-0-0,0-0-0]				
<b>LOADING</b> (psf)	<b>SPACING-</b> 2-0-0	<b>CSI.</b>	<b>DEFL.</b> in (loc) l/defl L/d	<b>PLATES</b>	<b>GRIP</b>
TCLL 20.0	Plate Grip DOL 1.15	TC 0.13	Vert(LL) n/a - n/a 999	MT20	244/190
TCDL 10.0	Lumber DOL 1.15	BC 0.09	Vert(CT) n/a - n/a 999		
BCLL 0.0 *	Rep Stress Incr YES	WB 0.07	Horz(CT) 0.00 5 n/a n/a		
BCDL 10.0	Code IRC2015/TPI2014	Matrix-S		Weight: 54 lb	FT = 20%

**LUMBER-**  
 TOP CHORD 2x4 SP No.1  
 BOT CHORD 2x4 SP No.1  
 OTHERS 2x4 SP No.2

**BRACING-**  
 TOP CHORD Structural wood sheathing directly applied or 6-0-0 oc purlins.  
 BOT CHORD Rigid ceiling directly applied or 10-0-0 oc bracing.

**REACTIONS.** All bearings 12-10-1.  
 (lb) - Max Horz 1=-121(LC 8)  
 Max Uplift All uplift 100 lb or less at joint(s) 1, 5 except 8=-124(LC 12), 6=-124(LC 13)  
 Max Grav All reactions 250 lb or less at joint(s) 1, 5, 7 except 8=330(LC 19), 6=330(LC 20)

**FORCES.** (lb) - Max. Comp./Max. Ten. - All forces 250 (lb) or less except when shown.  
 WEBS 2-8=-314/239, 4-6=-314/239

- NOTES-**
- 1) Unbalanced roof live loads have been considered for this design.
  - 2) Wind: ASCE 7-10; Vult=130mph Vasd=103mph; TC DL=6.0psf; BC DL=6.0psf; h=15ft; Cat. II; Exp C; Enclosed; MWFRS (envelope) and C-C Exterior(2) 0-4-13 to 4-9-10, Interior(1) 4-9-10 to 6-5-8, Exterior(2) 6-5-8 to 10-10-5, Interior(1) 10-10-5 to 12-6-3 zone; C-C for members and forces & MWFRS for reactions shown; Lumber DOL=1.60 plate grip DOL=1.60
  - 3) This truss has been designed for a 10.0 psf bottom chord live load nonconcurrent with any other live loads.
  - 4) \* This truss has been designed for a live load of 30.0psf on the bottom chord in all areas where a rectangle 3-6-0 tall by 2-0-0 wide will fit between the bottom chord and any other members.
  - 5) Provide mechanical connection (by others) of truss to bearing plate capable of withstanding 100 lb uplift at joint(s) 1, 5 except (jt=lb) 8=124, 6=124.
  - 6) Non Standard bearing condition. Review required.

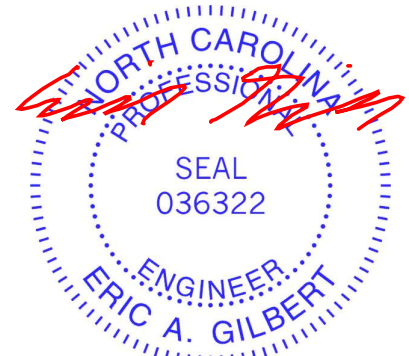

March 1, 2023

**WARNING - Verify design parameters and READ NOTES ON THIS AND INCLUDED MITEK REFERENCE PAGE MII-7473 rev. 1/2/2023 BEFORE USE.**  
 Design valid for use only with MiTek® connectors. This design is based only upon parameters shown, and is for an individual building component, not a truss system. Before use, the building designer must verify the applicability of design parameters and properly incorporate this design into the overall building design. Bracing indicated is to prevent buckling of individual truss web and/or chord members only. Additional temporary and permanent bracing is always required for stability and to prevent collapse with possible personal injury and property damage. For general guidance regarding the fabrication, storage, delivery, erection and bracing of trusses and truss systems, see **ANSI/TP1 Quality Criteria and DSB-22** available from Truss Plate Institute (www.tpinst.org) and **BCSI Building Component Safety Information** available from the Structural Building Component Association (www.sbcacomponents.com)



818 Soundside Road  
 Edenton, NC 27932

Job J0523-2576	Truss V4	Truss Type VALLEY	Qty 1	Ply 1	Lot 56 Liberty Meadow I56917896
-------------------	-------------	----------------------	----------	----------	------------------------------------

Comtech, Inc. Fayetteville, NC - 28314,

8.430 s Jan 6 2022 MiTek Industries, Inc. Wed Mar 1 09:55:13 2023 Page 1

ID:aTXuLo?nW09qtpROz2WQ0wydkZW-XXHFehhALIY885GRWy5?C5\_dqYjP9szg4m8u9kzfkAS

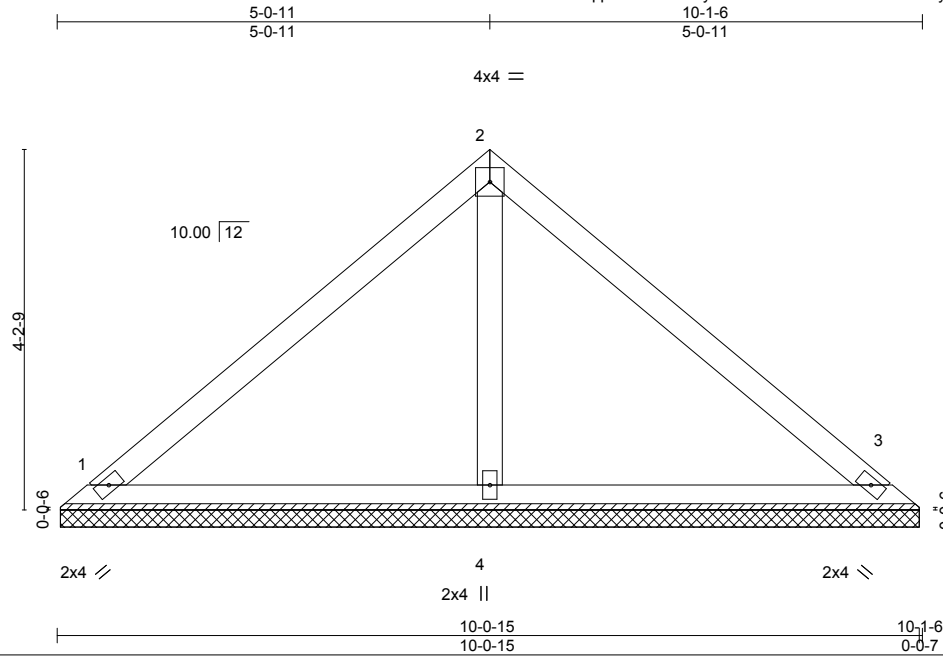

Scale = 1:26.9

LOADING (psf)	SPACING-	CSI.	DEFL.	in (loc)	l/defl	L/d	PLATES	GRIP
TCLL 20.0	2-0-0	TC 0.23	Vert(LL)	n/a	-	n/a	MT20	244/190
TCDL 10.0	Plate Grip DOL 1.15	BC 0.16	Vert(CT)	n/a	-	n/a		
BCLL 0.0 *	Lumber DOL 1.15	WB 0.06	Horz(CT)	0.00	3	n/a		
BCDL 10.0	Rep Stress Incr YES	Matrix-S					Weight: 38 lb	FT = 20%
	Code IRC2015/TPI2014							

LUMBER-	BRACING-
TOP CHORD 2x4 SP No.1	TOP CHORD Structural wood sheathing directly applied or 6-0-0 oc purlins.
BOT CHORD 2x4 SP No.1	BOT CHORD Rigid ceiling directly applied or 10-0-0 oc bracing.
OTHERS 2x4 SP No.2	

**REACTIONS.** (size) 1=10-0-8, 3=10-0-8, 4=10-0-8  
 Max Horz 1=93(LC 11)  
 Max Uplift 1=22(LC 13), 3=30(LC 13)  
 Max Grav 1=199(LC 1), 3=199(LC 1), 4=347(LC 1)

**FORCES.** (lb) - Max. Comp./Max. Ten. - All forces 250 (lb) or less except when shown.

- NOTES-**
- 1) Unbalanced roof live loads have been considered for this design.
  - 2) Wind: ASCE 7-10; Vult=130mph Vasd=103mph; TCCL=6.0psf; BCDL=6.0psf; h=15ft; Cat. II; Exp C; Enclosed; MWFRS (envelope) and C-C Exterior(2) zone; C-C for members and forces & MWFRS for reactions shown; Lumber DOL=1.60 plate grip DOL=1.60
  - 3) Gable requires continuous bottom chord bearing.
  - 4) This truss has been designed for a 10.0 psf bottom chord live load nonconcurrent with any other live loads.
  - 5) \* This truss has been designed for a live load of 30.0psf on the bottom chord in all areas where a rectangle 3-6-0 tall by 2-0-0 wide will fit between the bottom chord and any other members.
  - 6) Provide mechanical connection (by others) of truss to bearing plate capable of withstanding 100 lb uplift at joint(s) 1, 3.

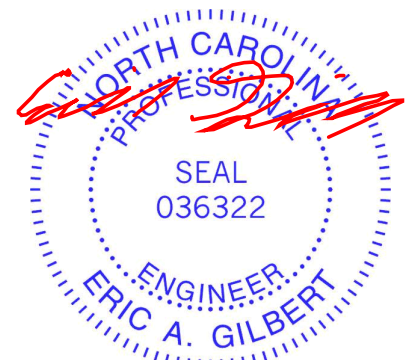

March 1, 2023

Job J0523-2576	Truss V5	Truss Type VALLEY	Qty 1	Ply 1	Lot 56 Liberty Meadow I56917897
-------------------	-------------	----------------------	----------	----------	------------------------------------

Comtech, Inc. Fayetteville, NC - 28314,

8.430 s Jan 6 2022 MiTek Industries, Inc. Wed Mar 1 09:55:14 2023 Page 1  
ID:aTXuLo?nW09qtpROz2WQ0wydkZW-0jqdr1io6cg?mFre4fcEkIxpjx4vuJlPltRiBzfkAR



4x4 =

Scale = 1:20.8

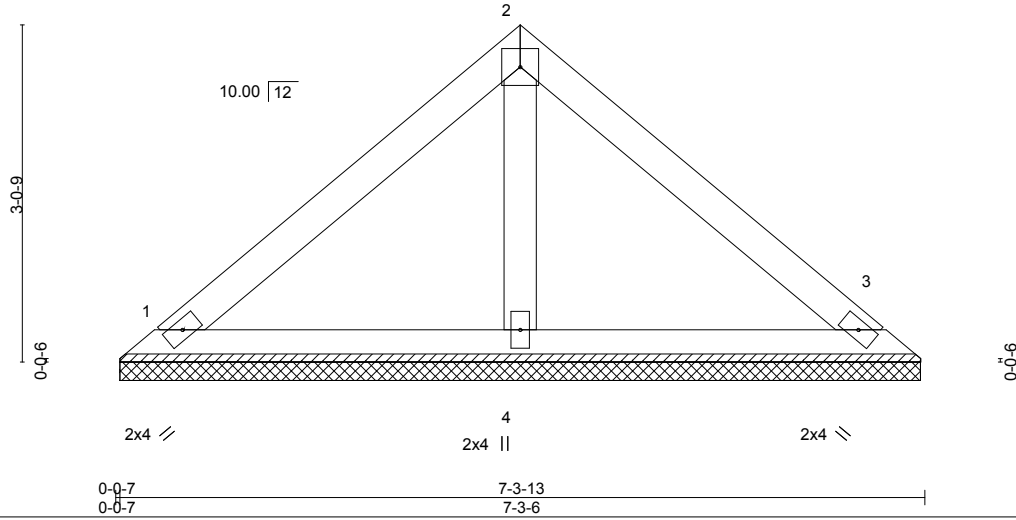

LOADING (psf)	SPACING-	CSI.	DEFL.	in (loc)	l/defl	L/d	PLATES	GRIP
TCLL 20.0	2-0-0	TC 0.15	Vert(LL)	n/a	-	n/a	MT20	244/190
TCDL 10.0	Plate Grip DOL 1.15	BC 0.08	Vert(CT)	n/a	-	n/a		
BCLL 0.0 *	Lumber DOL 1.15	WB 0.02	Horz(CT)	0.00	3	n/a		
BCDL 10.0	Rep Stress Incr YES	Matrix-P					Weight: 27 lb	FT = 20%
	Code IRC2015/TPI2014							

**LUMBER-**  
 TOP CHORD 2x4 SP No.1  
 BOT CHORD 2x4 SP No.1  
 OTHERS 2x4 SP No.2

**BRACING-**  
 TOP CHORD Structural wood sheathing directly applied or 6-0-0 oc purlins.  
 BOT CHORD Rigid ceiling directly applied or 10-0-0 oc bracing.

**REACTIONS.** (size) 1=7-2-14, 3=7-2-14, 4=7-2-14  
 Max Horz 1=-65(LC 8)  
 Max Uplift 1=-23(LC 13), 3=-29(LC 13)  
 Max Grav 1=151(LC 1), 3=151(LC 1), 4=220(LC 1)

**FORCES.** (lb) - Max. Comp./Max. Ten. - All forces 250 (lb) or less except when shown.

**NOTES-**

- 1) Unbalanced roof live loads have been considered for this design.
- 2) Wind: ASCE 7-10; Vult=130mph Vasd=103mph; TCCL=6.0psf; BCDL=6.0psf; h=15ft; Cat. II; Exp C; Enclosed; MWFRS (envelope) and C-C Exterior(2) zone; C-C for members and forces & MWFRS for reactions shown; Lumber DOL=1.60 plate grip DOL=1.60
- 3) This truss has been designed for a 10.0 psf bottom chord live load nonconcurrent with any other live loads.
- 4) \* This truss has been designed for a live load of 30.0psf on the bottom chord in all areas where a rectangle 3-6-0 tall by 2-0-0 wide will fit between the bottom chord and any other members.
- 5) Provide mechanical connection (by others) of truss to bearing plate capable of withstanding 100 lb uplift at joint(s) 1, 3.
- 6) Non Standard bearing condition. Review required.



March 1, 2023

**WARNING - Verify design parameters and READ NOTES ON THIS AND INCLUDED MITEK REFERENCE PAGE MII-7473 rev. 1/2/2023 BEFORE USE.**

Design valid for use only with MiTek® connectors. This design is based only upon parameters shown, and is for an individual building component, not a truss system. Before use, the building designer must verify the applicability of design parameters and properly incorporate this design into the overall building design. Bracing indicated is to prevent buckling of individual truss web and/or chord members only. Additional temporary and permanent bracing is always required for stability and to prevent collapse with possible personal injury and property damage. For general guidance regarding the fabrication, storage, delivery, erection and bracing of trusses and truss systems, see **ANSI/TP1 Quality Criteria and DSB-22** available from Truss Plate Institute (www.tpinst.org) and **BCSI Building Component Safety Information** available from the Structural Building Component Association (www.sbcacomponents.com)



818 Soundside Road  
 Edenton, NC 27932

Job J0523-2576	Truss V6	Truss Type VALLEY	Qty 1	Ply 1	Lot 56 Liberty Meadow 156917898
-------------------	-------------	----------------------	----------	----------	------------------------------------

Comtech, Inc. Fayetteville, NC - 28314,

8.430 s Jan 6 2022 MiTek Industries, Inc. Wed Mar 1 09:55:16 2023 Page 1

ID:aTXuLo?nW09qtpROz2WQ0wydkZW-y6yNGjj2eDxj?Y?0B4fjqcBulmCMDQ6mjMYm3zfkKAP

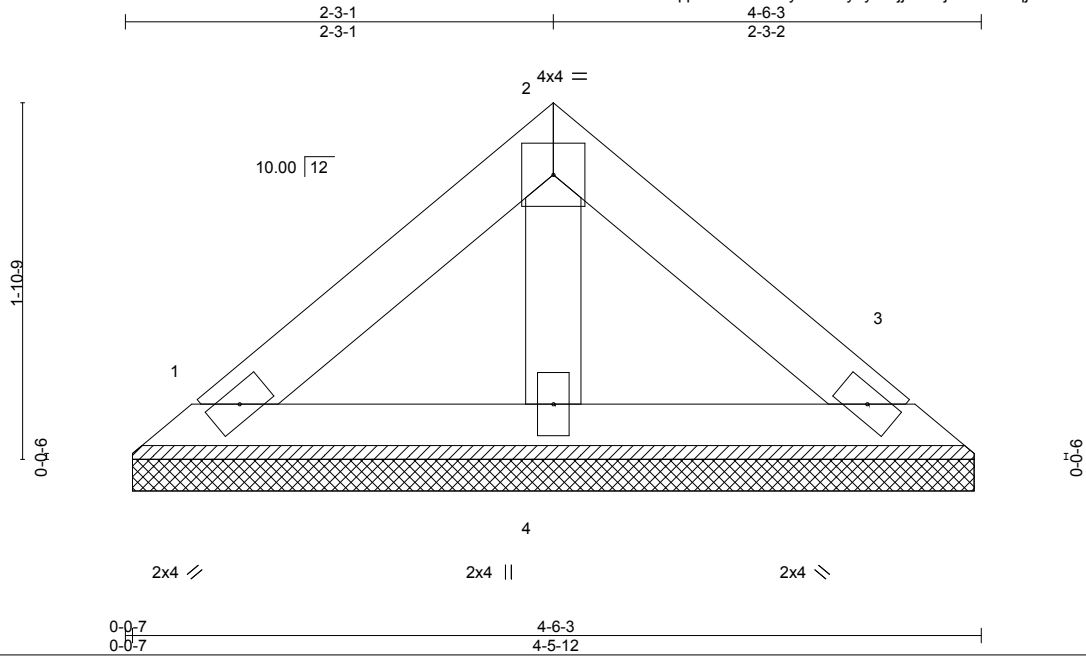

Scale = 1:12.2

LOADING (psf)	SPACING-	CSI.	DEFL.	in (loc)	l/defl	L/d	PLATES	GRIP
TCLL 20.0	2-0-0	TC 0.05	Vert(LL)	n/a	-	n/a	MT20	244/190
TCDL 10.0	Plate Grip DOL 1.15	BC 0.03	Vert(CT)	n/a	-	n/a		
BCLL 0.0 *	Lumber DOL 1.15	WB 0.01	Horz(CT)	0.00	3	n/a		
BCDL 10.0	Rep Stress Incr YES	Matrix-P					Weight: 16 lb	FT = 20%
	Code IRC2015/TPI2014							

**LUMBER-**  
TOP CHORD 2x4 SP No.1  
BOT CHORD 2x4 SP No.1  
OTHERS 2x4 SP No.2

**BRACING-**  
TOP CHORD Structural wood sheathing directly applied or 4-6-3 oc purlins.  
BOT CHORD Rigid ceiling directly applied or 10-0-0 oc bracing.

**REACTIONS.** (size) 1=4-5-5, 3=4-5-5, 4=4-5-5  
Max Horz 1=-37(LC 8)  
Max Uplift 1=-13(LC 13), 3=-16(LC 13)  
Max Grav 1=86(LC 1), 3=86(LC 1), 4=125(LC 1)

**FORCES.** (lb) - Max. Comp./Max. Ten. - All forces 250 (lb) or less except when shown.

**NOTES-**

- 1) Unbalanced roof live loads have been considered for this design.
- 2) Wind: ASCE 7-10; Vult=130mph Vasd=103mph; TCDL=6.0psf; BCDL=6.0psf; h=15ft; Cat. II; Exp C; Enclosed; MWFRS (envelope) and C-C Exterior(2) zone; C-C for members and forces & MWFRS for reactions shown; Lumber DOL=1.60 plate grip DOL=1.60
- 3) Gable requires continuous bottom chord bearing.
- 4) This truss has been designed for a 10.0 psf bottom chord live load nonconcurrent with any other live loads.
- 5) \* This truss has been designed for a live load of 30.0psf on the bottom chord in all areas where a rectangle 3-6-0 tall by 2-0-0 wide will fit between the bottom chord and any other members.
- 6) Provide mechanical connection (by others) of truss to bearing plate capable of withstanding 100 lb uplift at joint(s) 1, 3.

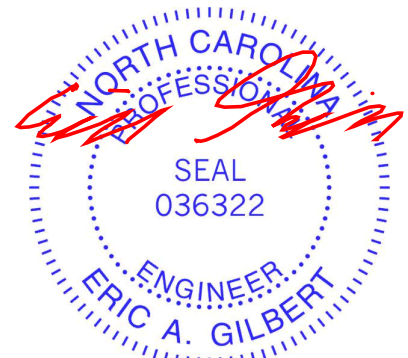

March 1, 2023

**WARNING - Verify design parameters and READ NOTES ON THIS AND INCLUDED MITEK REFERENCE PAGE MII-7473 rev. 1/2/2023 BEFORE USE.**

Design valid for use only with MiTek® connectors. This design is based only upon parameters shown, and is for an individual building component, not a truss system. Before use, the building designer must verify the applicability of design parameters and properly incorporate this design into the overall building design. Bracing indicated is to prevent buckling of individual truss web and/or chord members only. Additional temporary and permanent bracing is always required for stability and to prevent collapse with possible personal injury and property damage. For general guidance regarding the fabrication, storage, delivery, erection and bracing of trusses and truss systems, see **ANSI/TP1 Quality Criteria and DSB-22** available from Truss Plate Institute (www.tpinst.org) and **BCSI Building Component Safety Information** available from the Structural Building Component Association (www.sbcacomponents.com)



818 Soundside Road  
Edenton, NC 27932

# Symbols

## PLATE LOCATION AND ORIENTATION

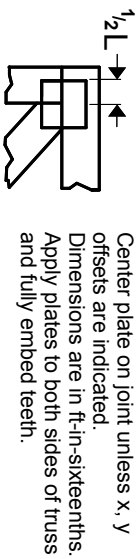

Center plate on joint unless x, y offsets are indicated. Dimensions are in ft-in-sixteenths. Apply plates to both sides of truss and fully embed teeth.

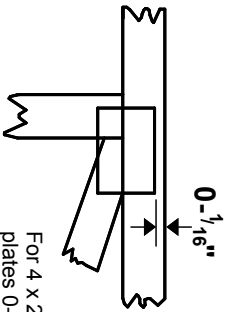

For 4 x 2 orientation, locate plates 0- 1/16" from outside edge of truss.



This symbol indicates the required direction of slots in connector plates.

\* Plate location details available in MITek software or upon request.

## PLATE SIZE

4 X 4

The first dimension is the plate width measured perpendicular to slots. Second dimension is the length parallel to slots.

## LATERAL BRACING LOCATION



Indicated by symbol shown and/or by text in the bracing section of the output. Use T or I bracing if indicated.

## BEARING



Indicates location where bearings (supports) occur. Icons vary but reaction section indicates joint number/letter where bearings occur. Min size shown is for crushing only.

## Industry Standards:

ANSI/TFP 1: National Design Specification for Metal Plate Connected Wood Truss Construction.  
DSB-22: Design Standard for Bracing.  
BCSI: Building Component Safety Information, Guide to Good Practice for Handling, Installing, Restraining & Bracing of Metal Plate Connected Wood Trusses.

# Numbering System

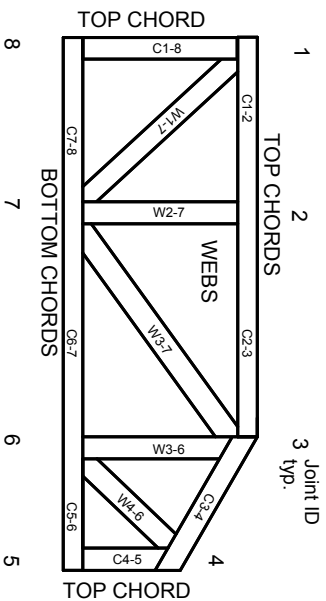

JOINTS ARE GENERALLY NUMBERED/LETTERED CLOCKWISE AROUND THE TRUSS STARTING AT THE JOINT FARTHEST TO THE LEFT.

CHORDS AND WEBS ARE IDENTIFIED BY END JOINT NUMBERS/LETTERS.

## Product Code Approvals

ICC-ES Reports:

ESR-1988, ESR-2362, ESR-2685, ESR-3282  
ESR-4722, ESL-1388

## Design General Notes

Trusses are designed for wind loads in the plane of the truss unless otherwise shown.

Lumber design values are in accordance with ANSI/TFP 1 section 6.3. These truss designs rely on Lumber values established by others.

© 2023 MITek® All Rights Reserved

**MITek**

ENGINEERING BY  
**TRANGO**  
A MITek Affiliate

MITek Engineering Reference Sheet: MI-7473 rev. 1/2/2023

# General Safety Notes

## Failure to Follow Could Cause Property Damage or Personal Injury

1. Additional stability bracing for truss system, e.g. diagonal or X-bracing, is always required. See BCSI.
2. Truss bracing must be designed by an engineer. For wide truss spacing, individual lateral braces themselves may require bracing, or alternative Tor I bracing should be considered.
3. Never exceed the design loading shown and never stack materials on inadequately braced trusses.
4. Provide copies of this truss design to the building designer, erection supervisor, property owner and all other interested parties.
5. Cut members to bear tightly against each other.
6. Place plates on each face of truss at each joint and embed fully. Knots and wane at joint locations are regulated by ANSI/TFP 1.
7. Design assumes trusses will be suitably protected from the environment in accord with ANSI/TFP 1.
8. Unless otherwise noted, moisture content of lumber shall not exceed 19% at time of fabrication.
9. Unless expressly noted, this design is not applicable for use with fire retardant, preservative treated, or green lumber.
10. Camber is a non-structural consideration and is the responsibility of truss fabricator. General practice is to camber for dead load deflection.
11. Plate type, size, orientation and location dimensions indicated are minimum plating requirements.
12. Lumber used shall be of the species and size, and in all respects, equal to or better than that specified.
13. Top chords must be sheathed or purlins provided at spacing indicated on design.
14. Bottom chords require lateral bracing at 10 ft. spacing, or less, if no ceiling is installed, unless otherwise noted.
15. Connections not shown are the responsibility of others.
16. Do not cut or alter truss member or plate without prior approval of an engineer.
17. Install and load vertically unless indicated otherwise.
18. Use of green or treated lumber may pose unacceptable environmental, health or performance risks. Consult with project engineer before use.
19. Review all portions of this design (front, back, words and pictures) before use. Reviewing pictures alone is not sufficient.
20. Design assumes manufacture in accordance with ANSI/TFP 1 Quality Criteria.
21. The design does not take into account any dynamic or other loads other than those expressly stated.



**BM1 Kerto-S LVL 1.750" X 16.000" 2-Ply - PASSED**

Level: Level

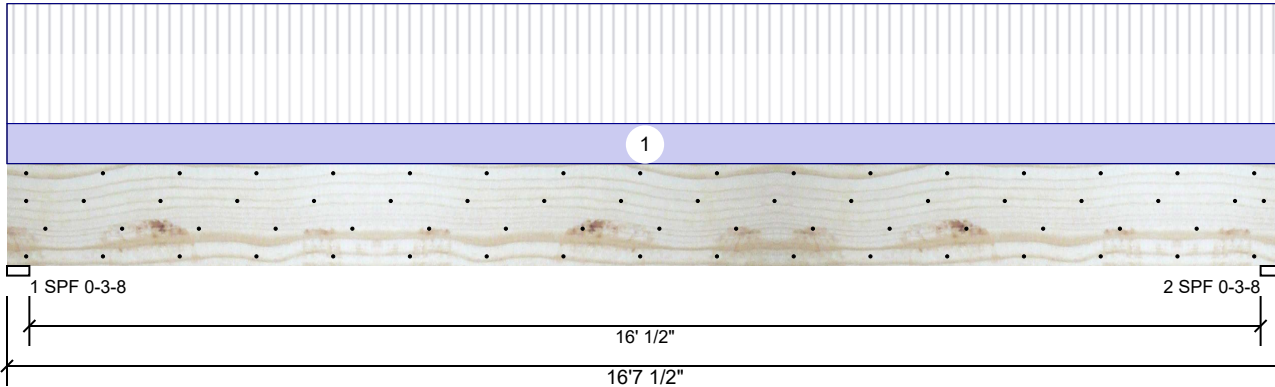

**Member Information**

Type:	Girder
Plies:	2
Moisture Condition:	Dry
Deflection LL:	480
Deflection TL:	240
Importance:	Normal - II
Temperature:	Temp <= 100°F

Application:	Floor
Design Method:	ASD
Building Code:	IBC 2012
Load Sharing:	No
Deck:	Not Checked

**Reactions UNPATTERNED lb (Uplift)**

Brg	Direction	Live	Dead	Snow	Wind	Const
1	Vertical	3333	1217	0	0	0
2	Vertical	3333	1217	0	0	0

**Bearings**

Bearing	Length	Dir.	Cap.	React D/L lb	Total	Ld. Case	Ld. Comb.
1 - SPF	3.500"	Vert	87%	1217 / 3333	4551	L	D+L
2 - SPF	3.500"	Vert	87%	1217 / 3333	4551	L	D+L

**Analysis Results**

Analysis	Actual	Location	Allowed	Capacity	Comb.	Case
Moment	17931 ft-lb	8'3 3/4"	34565 ft-lb	0.519 (52%)	D+L	L
Unbraced	17931 ft-lb	8'3 3/4"	17951 ft-lb	0.999 (100%)	D+L	L
Shear	4391 lb	15'	11947 lb	0.368 (37%)	D+L	L
LL Defl inch	0.286 (L/678)	8'3 13/16"	0.405 (L/480)	0.707 (71%)	L	L
TL Defl inch	0.391 (L/497)	8'3 13/16"	0.809 (L/240)	0.483 (48%)	D+L	L

**Design Notes**

- Provide support to prevent lateral movement and rotation at the end bearings. Lateral support may also be required at the interior bearings by the building code.
- Fasten all plies using 4 rows of 10d Box nails (.128x3") at 12" o.c. Maximum end distance not to exceed 6".
- Refer to last page of calculations for fasteners required for specified loads.
- Girders are designed to be supported on the bottom edge only.
- Top must be laterally braced at a maximum of 6'5 3/4" o.c.
- Bottom must be laterally braced at end bearings.
- Lateral slenderness ratio based on single ply width.

ID	Load Type	Location	Trib Width	Side	Dead 0.9	Live 1	Snow 1.15	Wind 1.6	Const. 1.25	Comments
1	Uniform			Near Face	134 PLF	401 PLF	0 PLF	0 PLF	0 PLF	F4
	Self Weight				12 PLF					

**Notes**

Calculated Structured Designs is responsible only of the structural adequacy of this component based on the design criteria and loadings shown. It is the responsibility of the customer and/or the contractor to ensure the component suitability of the intended application, and to verify the dimensions and loads.

**Lumber**

- Dry service conditions, unless noted otherwise
- LVL not to be treated with fire retardant or corrosive

chemicals

**Handling & Installation**

- LVL beams must not be cut or drilled
- Refer to manufacturer's product information regarding installation requirements, multi-ply fastening details, beam strength values, and code approvals
- Damaged Beams must not be used
- Design assumes top edge is laterally restrained
- Provide lateral support at bearing points to avoid lateral displacement and rotation

6. For flat roofs provide proper drainage to prevent ponding

This design is valid until 5/29/2026

**Manufacturer Info**

Metsä Wood  
 301 Merritt 7 Building, 2nd Floor  
 Norwalk, CT 06851  
 (800) 622-5850  
[www.metsawood.com/us](http://www.metsawood.com/us)

Comtech, Inc.  
 1001 S Reilly Rd., NC  
 28314  
 (910) 864-8787



**BM1 Kerto-S LVL 1.750" X 16.000" 2-Ply - PASSED**

Level: Level

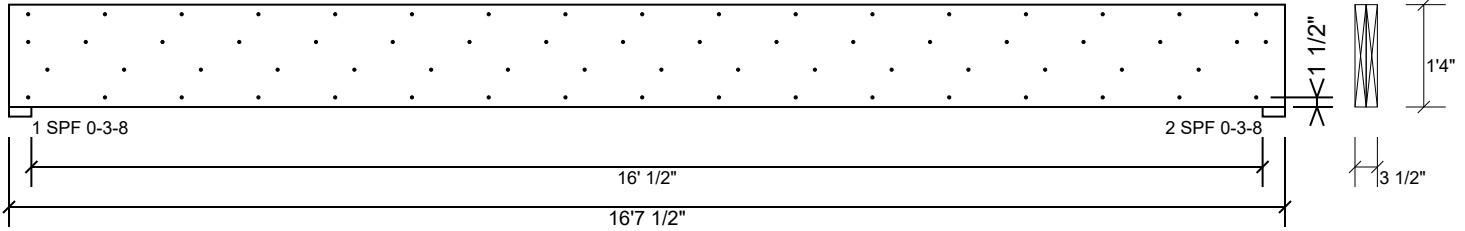

**Multi-Ply Analysis**

Fasten all plies using 4 rows of 10d Box nails (.128x3") at 12" o.c.. Maximum end distance not to exceed 6".

Capacity	81.7 %
Load	267.5 PLF
Yield Limit per Foot	327.4 PLF
Yield Limit per Fastener	81.9 lb.
C <sub>m</sub>	1
Yield Mode	IV
Edge Distance	1 1/2"
Min. End Distance	3"
Load Combination	D+L
Duration Factor	1.00

**Notes**

Calculated Structured Designs is responsible only of the structural adequacy of this component based on the design criteria and loadings shown. It is the responsibility of the customer and/or the contractor to ensure the component suitability of the intended application, and to verify the dimensions and loads.

**Lumber**

1. Dry service conditions, unless noted otherwise
2. LVL not to be treated with fire retardant or corrosive

chemicals

**Handling & Installation**

1. LVL beams must not be cut or drilled
2. Refer to manufacturer's product information regarding installation requirements, multi-ply fastening details, beam strength values, and code approvals
3. Damaged Beams must not be used
4. Design assumes top edge is laterally restrained
5. Provide lateral support at bearing points to avoid lateral displacement and rotation

6. For flat roofs provide proper drainage to prevent ponding

This design is valid until 5/29/2026

**Manufacturer Info**

Metsä Wood  
 301 Merritt 7 Building, 2nd Floor  
 Norwalk, CT 06851  
 (800) 622-5850  
[www.metsawood.com/us](http://www.metsawood.com/us)

Comtech, Inc.  
 1001 S Reilly Rd., NC  
 28314  
 (910) 864-8787



**BM2 Kerto-S LVL 1.750" X 16.000" 2-Ply - PASSED**

Level: Level

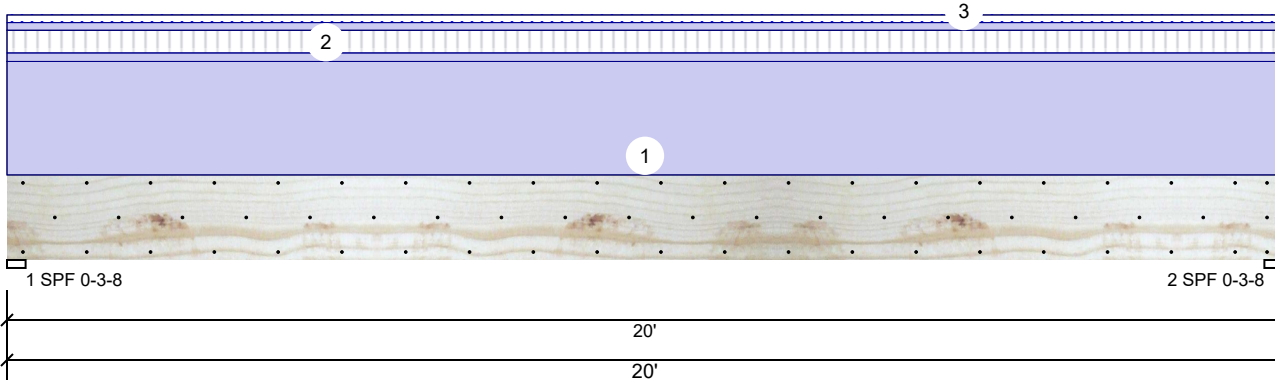

**Member Information**

Type:	Girder	Application:	Floor
Plies:	2	Design Method:	ASD
Moisture Condition:	Dry	Building Code:	IBC 2012
Deflection LL:	480	Load Sharing:	No
Deflection TL:	240	Deck:	Not Checked
Importance:	Normal - II		
Temperature:	Temp <= 100°F		

**Reactions UNPATTERNED lb (Uplift)**

Brg	Direction	Live	Dead	Snow	Wind	Const
1	Vertical	400	2409	135	0	0
2	Vertical	400	2409	135	0	0

**Bearings**

Bearing	Length	Dir.	Cap.	React D/L lb	Total	Ld. Case	Ld. Comb.
1 - SPF	3.500"	Vert	54%	2409 / 401	2811	L	D+0.75(L+S)
2 - SPF	3.500"	Vert	54%	2409 / 401	2811	L	D+0.75(L+S)

**Analysis Results**

Analysis	Actual	Location	Allowed	Capacity	Comb.	Case
Moment	13439 ft-lb	10'	34565 ft-lb	0.389 (39%)	D+L	L
Unbraced	13439 ft-lb	10'	13492 ft-lb	0.996 (100%)	D+L	L
Shear	2461 lb	18'4 1/2"	11947 lb	0.206 (21%)	D+L	L
LL Defl inch	0.059 (L/3960)	10' 1/16"	0.489 (L/480)	0.121 (12%)	0.75(L+S)	L
TL Defl inch	0.415 (L/565)	10' 1/16"	0.978 (L/240)	0.425 (42%)	D+0.75(L+S)	L

**Design Notes**

- Provide support to prevent lateral movement and rotation at the end bearings. Lateral support may also be required at the interior bearings by the building code.
- Fasten all plies using 3 rows of 10d Box nails (.128x3") at 12" o.c. Maximum end distance not to exceed 6".
- Refer to last page of calculations for fasteners required for specified loads.
- Girders are designed to be supported on the bottom edge only.
- Top loads must be supported equally by all plies.
- Top must be laterally braced at a maximum of 8'9 7/16" o.c.
- Bottom must be laterally braced at end bearings.
- Lateral slenderness ratio based on single ply width.

ID	Load Type	Location	Trib Width	Side	Dead 0.9	Live 1	Snow 1.15	Wind 1.6	Const. 1.25	Comments
1	Uniform			Top	200 PLF	0 PLF	0 PLF	0 PLF	0 PLF	Wall Above, C1GE
2	Tie-In	0-0-0 to 20-0-0	1-0-0	Far Face	15 PSF	40 PSF	0 PSF	0 PSF	0 PSF	Floor Load
3	Tie-In	0-0-0 to 20-0-0	0-6-0	Near Face	27 PSF	0 PSF	27 PSF	0 PSF	0 PSF	J3
	Self Weight				12 PLF					

**Notes**

Calculated Structural Designs is responsible only of the structural adequacy of this component based on the design criteria and loadings shown. It is the responsibility of the customer and/or the contractor to ensure the component suitability of the intended application, and to verify the dimensions and loads.

**Lumber**

- Dry service conditions, unless noted otherwise
- LVL not to be treated with fire retardant or corrosive chemicals

**Handling & Installation**

- LVL beams must not be cut or drilled
- Refer to manufacturer's product information regarding installation requirements, multi-ply fastening details, beam strength values, and code approvals
- Damaged Beams must not be used
- Design assumes top edge is laterally restrained
- Provide lateral support at bearing points to avoid lateral displacement and rotation

6. For flat roofs provide proper drainage to prevent ponding

This design is valid until 5/29/2026

**Manufacturer Info**

Metsä Wood  
 301 Merritt 7 Building, 2nd Floor  
 Norwalk, CT 06851  
 (800) 622-5850  
[www.metsawood.com/us](http://www.metsawood.com/us)

Comtech, Inc.  
 1001 S Reilly Rd., NC  
 28314  
 (910) 864-8787



**BM2 Kerto-S LVL 1.750" X 16.000" 2-Ply - PASSED**

Level: Level

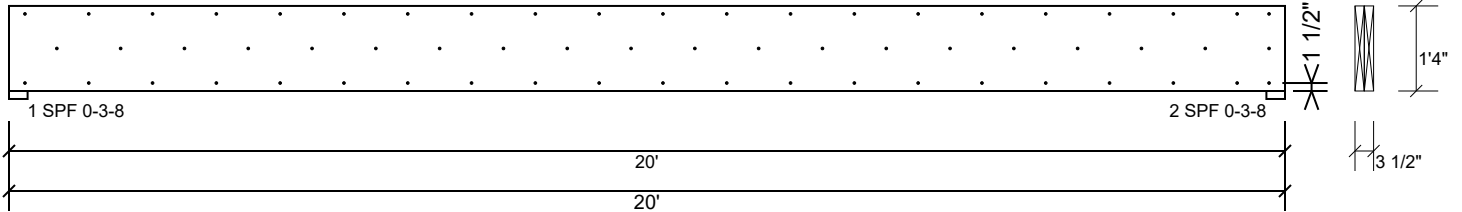

**Multi-Ply Analysis**

Fasten all plies using 3 rows of 10d Box nails (.128x3") at 12" o.c.. Maximum end distance not to exceed 6".

Capacity	11.2 %
Load	27.5 PLF
Yield Limit per Foot	245.6 PLF
Yield Limit per Fastener	81.9 lb.
C <sub>m</sub>	1
Yield Mode	IV
Edge Distance	1 1/2"
Min. End Distance	3"
Load Combination	D+L
Duration Factor	1.00

**Notes**

Calculated Structured Designs is responsible only of the structural adequacy of this component based on the design criteria and loadings shown. It is the responsibility of the customer and/or the contractor to ensure the component suitability of the intended application, and to verify the dimensions and loads.

**Lumber**

1. Dry service conditions, unless noted otherwise
2. LVL not to be treated with fire retardant or corrosive chemicals

**Handling & Installation**

1. LVL beams must not be cut or drilled
2. Refer to manufacturer's product information regarding installation requirements, multi-ply fastening details, beam strength values, and code approvals
3. Damaged Beams must not be used
4. Design assumes top edge is laterally restrained
5. Provide lateral support at bearing points to avoid lateral displacement and rotation

6. For flat roofs provide proper drainage to prevent ponding

This design is valid until 5/29/2026

**Manufacturer Info**

Metsä Wood  
 301 Merritt 7 Building, 2nd Floor  
 Norwalk, CT 06851  
 (800) 622-5850  
[www.metsawood.com/us](http://www.metsawood.com/us)

Comtech, Inc.  
 1001 S Reilly Rd., NC  
 28314  
 (910) 864-8787



**BM3 S-P-F #2 2.000" X 10.000" 2-Ply - PASSED**

Level: Level

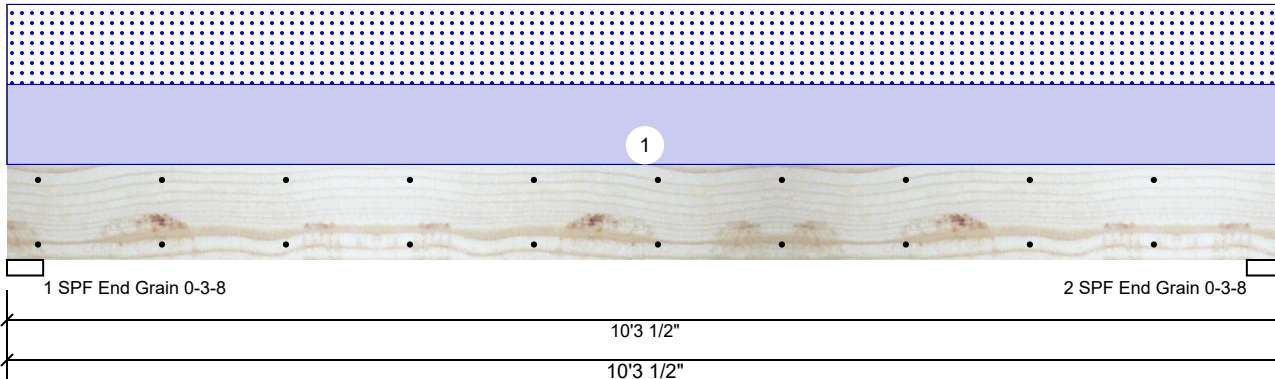

**Member Information**

Type:	Girder	Application:	Floor
Plies:	2	Design Method:	ASD
Moisture Condition:	Dry	Building Code:	IBC 2012
Deflection LL:	480	Load Sharing:	No
Deflection TL:	360	Deck:	Not Checked
Importance:	Normal - II	Ceiling:	Gypsum 1/2"
Temperature:	Temp <= 100°F		

**Reactions UNPATTERNED lb (Uplift)**

Brg	Direction	Live	Dead	Snow	Wind	Const
1	Vertical	0	607	607	0	0
2	Vertical	0	607	607	0	0

**Bearings**

Bearing	Length	Dir.	Cap.	React D/L lb	Total	Ld. Case	Ld. Comb.
1 - SPF End Grain	3.500"	Vert	27%	607 / 607	1214	L	D+S
2 - SPF End Grain	3.500"	Vert	27%	607 / 607	1214	L	D+S

**Analysis Results**

Analysis	Actual	Location	Allowed	Capacity	Comb.	Case
Moment	2852 ft-lb	5'1 3/4"	3946 ft-lb	0.723 (72%)	D+S	L
Unbraced	2852 ft-lb	5'1 3/4"	2937 ft-lb	0.971 (97%)	D+S	L
Shear	964 lb	1' 3/4"	2872 lb	0.336 (34%)	D+S	L
LL Defl inch	0.090 (L/1317)	5'1 3/4"	0.246 (L/480)	0.365 (36%)	S	L
TL Defl inch	0.179 (L/658)	5'1 3/4"	0.328 (L/360)	0.547 (55%)	D+S	L

**Design Notes**

- 1 Provide support to prevent lateral movement and rotation at the end bearings. Lateral support may also be required at the interior bearings by the building code.
- 2 Fasten all plies using 2 rows of 10d Box nails (.128x3") at 12" o.c. Maximum end distance not to exceed 6".
- 3 Refer to last page of calculations for fasteners required for specified loads.
- 4 Girders are designed to be supported on the bottom edge only.
- 5 Top loads must be supported equally by all plies.
- 6 Top must be laterally braced at end bearings.
- 7 Lateral slenderness ratio based on single ply width.

ID	Load Type	Location	Trib Width	Side	Dead 0.9	Live 1	Snow 1.15	Wind 1.6	Const. 1.25	Comments
1	Uniform			Top	118 PLF	0 PLF	118 PLF	0 PLF	0 PLF	B2

**Manufacturer Info**

Comtech, Inc.  
 1001 S Reilly Rd., NC  
 28314  
 (910) 864-8787



This design is valid until 5/29/2026

**BM3 S-P-F #2 2.000" X 10.000" 2-Ply - PASSED**

Level: Level

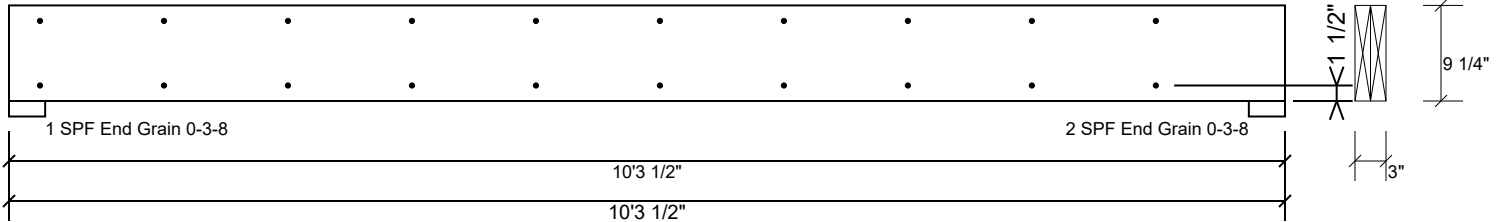

**Multi-Ply Analysis**

Fasten all plies using 2 rows of 10d Box nails (.128x3") at 12" o.c.. Maximum end distance not to exceed 6".

Capacity	0.0 %
Load	0.0 PLF
Yield Limit per Foot	157.4 PLF
Yield Limit per Fastener	78.7 lb.
C <sub>m</sub>	1
Yield Mode	IV
Edge Distance	1 1/2"
Min. End Distance	3"
Load Combination	
Duration Factor	1.00

<b>Manufacturer Info</b>	Comtech, Inc. 1001 S Reilly Rd., NC 28314 (910) 864-8787
	

This design is valid until 5/29/2026



**BM4 Kerto-S LVL 1.750" X 9.250" 2-Ply - PASSED**

Level: Level

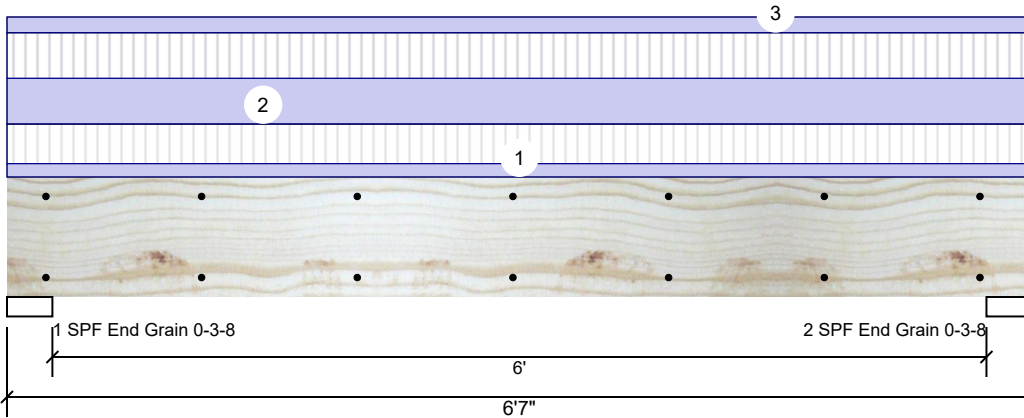

**Member Information**

Type:	Girder	Application:	Floor
Plies:	2	Design Method:	ASD
Moisture Condition:	Dry	Building Code:	IBC 2012
Deflection LL:	480	Load Sharing:	No
Deflection TL:	360	Deck:	Not Checked
Importance:	Normal - II		
Temperature:	Temp <= 100°F		

**Reactions UNPATTERNED lb (Uplift)**

Brg	Direction	Live	Dead	Snow	Wind	Const
1	Vertical	2149	1903	0	0	0
2	Vertical	2149	1903	0	0	0

**Bearings**

Bearing	Length	Dir.	Cap.	React D/L lb	Total	Ld. Case	Ld. Comb.
1 - SPF End Grain	3.500"	Vert	39%	1903 / 2149	4053	L	D+L
2 - SPF End Grain	3.500"	Vert	39%	1903 / 2149	4053	L	D+L

**Analysis Results**

Analysis	Actual	Location	Allowed	Capacity	Comb.	Case
Moment	5774 ft-lb	3' 3/2"	12542 ft-lb	0.460 (46%)	D+L	L
Unbraced	5774 ft-lb	3' 3/2"	9934 ft-lb	0.581 (58%)	D+L	L
Shear	2750 lb	1' 3/4"	6907 lb	0.398 (40%)	D+L	L
LL Defl inch	0.056 (L/1320)	3' 3/2"	0.153 (L/480)	0.364 (36%)	L	L
TL Defl inch	0.105 (L/700)	3' 3/2"	0.204 (L/360)	0.514 (51%)	D+L	L

**Design Notes**

- 1 Provide support to prevent lateral movement and rotation at the end bearings. Lateral support may also be required at the interior bearings by the building code.
- 2 Fasten all plies using 2 rows of 10d Box nails (.128x3") at 12" o.c. Maximum end distance not to exceed 6".
- 3 Refer to last page of calculations for fasteners required for specified loads.
- 4 Girders are designed to be supported on the bottom edge only.
- 5 Top loads must be supported equally by all plies.
- 6 Top must be laterally braced at end bearings.
- 7 Bottom must be laterally braced at end bearings.
- 8 Lateral slenderness ratio based on single ply width.

ID	Load Type	Location	Trib Width	Side	Dead 0.9	Live 1	Snow 1.15	Wind 1.6	Const. 1.25	Comments
1	Uniform			Top	102 PLF	304 PLF	0 PLF	0 PLF	0 PLF	F2
2	Uniform			Top	349 PLF	349 PLF	0 PLF	0 PLF	0 PLF	A1
3	Uniform			Top	120 PLF	0 PLF	0 PLF	0 PLF	0 PLF	Wall Above
	Self Weight				7 PLF					

**Notes**

Calculated Structured Designs is responsible only of the structural adequacy of this component based on the design criteria and loadings shown. It is the responsibility of the customer and/or the contractor to ensure the component suitability of the intended application, and to verify the dimensions and loads.

**Lumber**

1. Dry service conditions, unless noted otherwise
2. LVL not to be treated with fire retardant or corrosive

chemicals

**Handling & Installation**

1. LVL beams must not be cut or drilled
2. Refer to manufacturer's product information regarding installation requirements, multi-ply fastening details, beam strength values, and code approvals
3. Damaged Beams must not be used
4. Design assumes top edge is laterally restrained
5. Provide lateral support at bearing points to avoid lateral displacement and rotation

6. For flat roofs provide proper drainage to prevent ponding

This design is valid until 5/29/2026

**Manufacturer Info**

Metsä Wood  
 301 Merritt 7 Building, 2nd Floor  
 Norwalk, CT 06851  
 (800) 622-5850  
[www.metsawood.com/us](http://www.metsawood.com/us)

Comtech, Inc.  
 1001 S Reilly Rd., NC  
 28314  
 (910) 864-8787



**BM4 Kerto-S LVL 1.750" X 9.250" 2-Ply - PASSED**

Level: Level

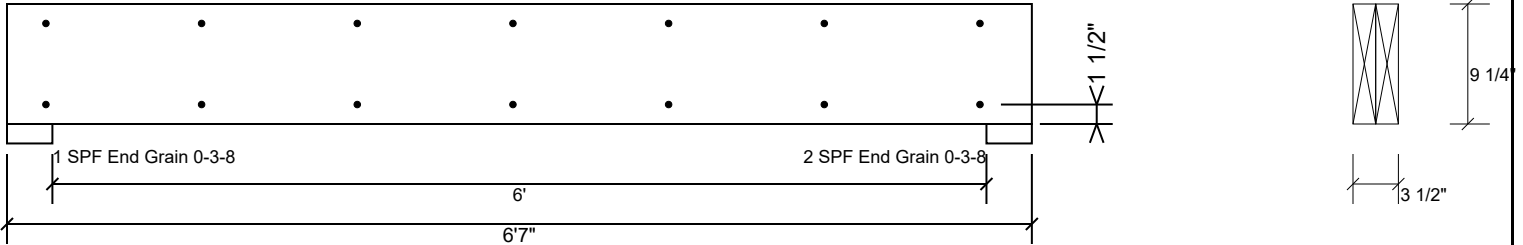

**Multi-Ply Analysis**

Fasten all plies using 2 rows of 10d Box nails (.128x3") at 12" o.c.. Maximum end distance not to exceed 6".

Capacity	0.0 %
Load	0.0 PLF
Yield Limit per Foot	163.7 PLF
Yield Limit per Fastener	81.9 lb.
C <sub>m</sub>	1
Yield Mode	IV
Edge Distance	1 1/2"
Min. End Distance	3"
Load Combination	
Duration Factor	1.00

**Notes**

Calculated Structured Designs is responsible only of the structural adequacy of this component based on the design criteria and loadings shown. It is the responsibility of the customer and/or the contractor to ensure the component suitability of the intended application, and to verify the dimensions and loads.

**Lumber**

1. Dry service conditions, unless noted otherwise
2. LVL not to be treated with fire retardant or corrosive

chemicals

**Handling & Installation**

1. LVL beams must not be cut or drilled
2. Refer to manufacturer's product information regarding installation requirements, multi-ply fastening details, beam strength values, and code approvals
3. Damaged Beams must not be used
4. Design assumes top edge is laterally restrained
5. Provide lateral support at bearing points to avoid lateral displacement and rotation

6. For flat roofs provide proper drainage to prevent ponding

This design is valid until 5/29/2026

**Manufacturer Info**

Metsä Wood  
 301 Merritt 7 Building, 2nd Floor  
 Norwalk, CT 06851  
 (800) 622-5850  
[www.metsawood.com/us](http://www.metsawood.com/us)

Comtech, Inc.  
 1001 S Reilly Rd., NC  
 28314  
 (910) 864-8787



# BM5 Kerto-S LVL 1.750" X 11.875" 2-Ply - PASSED

Level: Level

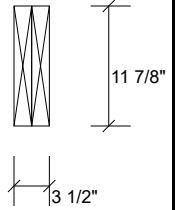
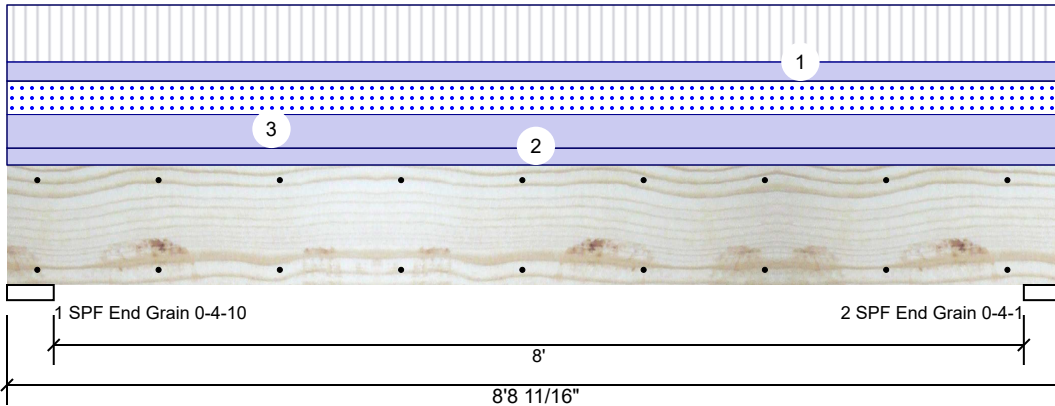

### Member Information

Type:	Girder	Application:	Floor
Plies:	2	Design Method:	ASD
Moisture Condition:	Dry	Building Code:	IBC 2012
Deflection LL:	480	Load Sharing:	No
Deflection TL:	240	Deck:	Not Checked
Importance:	Normal - II		
Temperature:	Temp <= 100°F		

### Reactions UNPATTERNED lb (Uplift)

Brg	Direction	Live	Dead	Snow	Wind	Const
1	Vertical	1772	2203	1044	0	0
2	Vertical	1753	2179	1033	0	0

### Bearings

Bearing	Length	Dir.	Cap.	React D/L lb	Total	Ld. Case	Ld. Comb.
1 - SPF End Grain	4.625"	Vert	32%	2203 / 2112	4314	L	D+0.75(L+S)
2 - SPF End Grain	4.063"	Vert	36%	2179 / 2089	4268	L	D+0.75(L+S)

### Analysis Results

Analysis	Actual	Location	Allowed	Capacity	Comb.	Case
Moment	7478 ft-lb	4'4 5/8"	19911 ft-lb	0.376 (38%)	D+L	L
Unbraced	8118 ft-lb	4'4 5/8"	11006 ft-lb	0.738 (74%)	D+0.75(L+S)	L
Shear	2737 lb	1'4 1/2"	8867 lb	0.309 (31%)	D+L	L
LL Defl inch	0.059 (L/1643)	4'4 11/16"	0.203 (L/480)	0.292 (29%)	0.75(L+S)	L
TL Defl inch	0.121 (L/804)	4'4 11/16"	0.406 (L/240)	0.298 (30%)	D+0.75(L+S)	L

### Design Notes

- Provide support to prevent lateral movement and rotation at the end bearings. Lateral support may also be required at the interior bearings by the building code.
- Fasten all plies using 2 rows of 10d Box nails (.128x3") at 12" o.c. Maximum end distance not to exceed 6".
- Refer to last page of calculations for fasteners required for specified loads.
- Girders are designed to be supported on the bottom edge only.
- Top loads must be supported equally by all plies.
- Top must be laterally braced at end bearings.
- Bottom must be laterally braced at end bearings.
- Lateral slenderness ratio based on single ply width.

ID	Load Type	Location	Trib Width	Side	Dead 0.9	Live 1	Snow 1.15	Wind 1.6	Const. 1.25	Comments
1	Part. Uniform	0-0-0 to 8-8-11		Top	135 PLF	404 PLF	0 PLF	0 PLF	0 PLF	F3
2	Uniform			Top	120 PLF	0 PLF	0 PLF	0 PLF	0 PLF	Wall Above
3	Uniform			Top	238 PLF	0 PLF	238 PLF	0 PLF	0 PLF	C1
	Self Weight				9 PLF					

<b>Notes</b> Calculated Structured Designs is responsible only of the structural adequacy of this component based on the design criteria and loadings shown. It is the responsibility of the customer and/or the contractor to ensure the component suitability of the intended application, and to verify the dimensions and loads.  <b>Lumber</b> 1. Dry service conditions, unless noted otherwise 2. LVL not to be treated with fire retardant or corrosive chemicals	<b>Handling &amp; Installation</b> 1. LVL beams must not be cut or drilled 2. Refer to manufacturer's product information regarding installation requirements, multi-ply fastening details, beam strength values, and code approvals 3. Damaged Beams must not be used 4. Design assumes top edge is laterally restrained 5. Provide lateral support at bearing points to avoid lateral displacement and rotation	6. For flat roofs provide proper drainage to prevent ponding	<b>Manufacturer Info</b> Metsä Wood 301 Merritt 7 Building, 2nd Floor Norwalk, CT 06851 (800) 622-5850 www.metsawood.com/us	Comtech, Inc. 1001 S Reilly Rd., NC 28314 (910) 864-8787
			This design is valid until 5/29/2026	

**BM5 Kerto-S LVL 1.750" X 11.875" 2-Ply - PASSED**

Level: Level

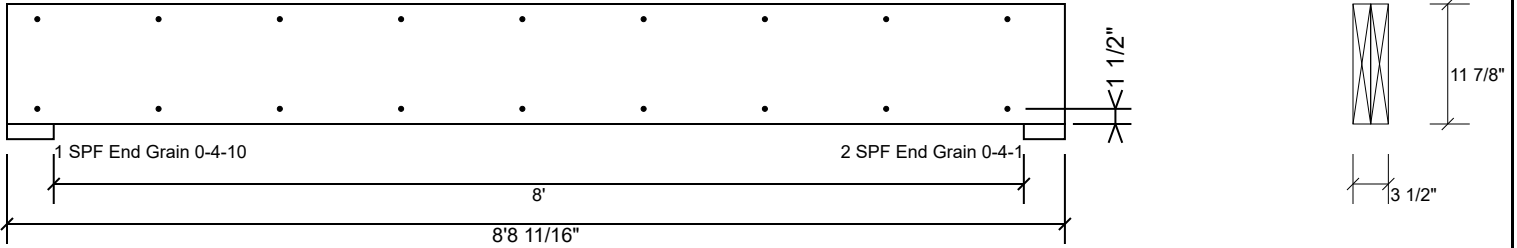

**Multi-Ply Analysis**

Fasten all plies using 2 rows of 10d Box nails (.128x3") at 12" o.c.. Maximum end distance not to exceed 6".

Capacity	0.0 %
Load	0.0 PLF
Yield Limit per Foot	163.7 PLF
Yield Limit per Fastener	81.9 lb.
C <sub>m</sub>	1
Yield Mode	IV
Edge Distance	1 1/2"
Min. End Distance	3"
Load Combination	
Duration Factor	1.00

**Notes**

Calculated Structured Designs is responsible only of the structural adequacy of this component based on the design criteria and loadings shown. It is the responsibility of the customer and/or the contractor to ensure the component suitability of the intended application, and to verify the dimensions and loads.

**Lumber**

1. Dry service conditions, unless noted otherwise
2. LVL not to be treated with fire retardant or corrosive

chemicals

**Handling & Installation**

1. LVL beams must not be cut or drilled
2. Refer to manufacturer's product information regarding installation requirements, multi-ply fastening details, beam strength values, and code approvals
3. Damaged Beams must not be used
4. Design assumes top edge is laterally restrained
5. Provide lateral support at bearing points to avoid lateral displacement and rotation

6. For flat roofs provide proper drainage to prevent ponding

This design is valid until 5/29/2026

**Manufacturer Info**

Metsä Wood  
 301 Merritt 7 Building, 2nd Floor  
 Norwalk, CT 06851  
 (800) 622-5850  
[www.metsawood.com/us](http://www.metsawood.com/us)

Comtech, Inc.  
 1001 S Reilly Rd., NC  
 28314  
 (910) 864-8787



**GDH Kerto-S LVL 1.750" X 11.875" 2-Ply - PASSED**

Level: Level

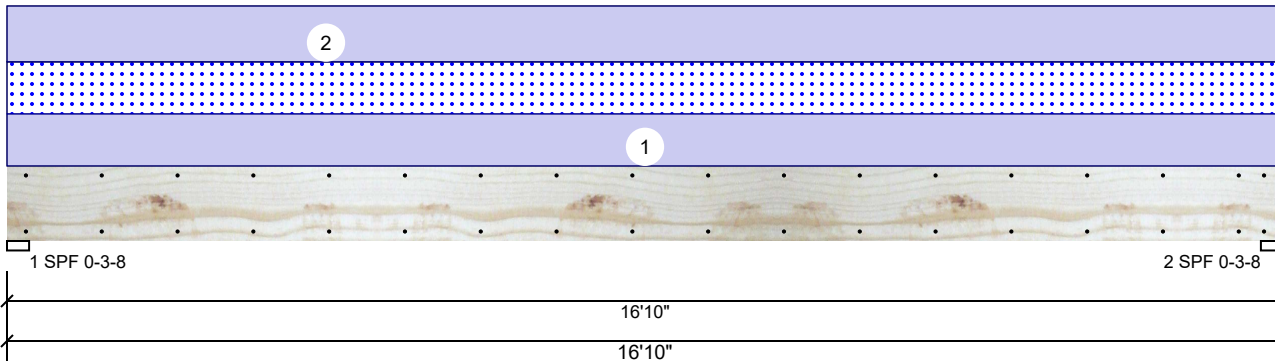

**Member Information**

Type:	Girder	Application:	Floor
Plies:	2	Design Method:	ASD
Moisture Condition:	Dry	Building Code:	IBC 2012
Deflection LL:	480	Load Sharing:	No
Deflection TL:	240	Deck:	Not Checked
Importance:	Normal - II		
Temperature:	Temp <= 100°F		

**Reactions UNPATTERNED lb (Uplift)**

Brg	Direction	Live	Dead	Snow	Wind	Const
1	Vertical	0	1054	471	0	0
2	Vertical	0	1054	471	0	0

**Bearings**

Bearing	Length	Dir.	Cap.	React D/L lb	Total	Ld. Case	Ld. Comb.
1 - SPF	3.500"	Vert	29%	1054 / 471	1525	L	D+S
2 - SPF	3.500"	Vert	29%	1054 / 471	1525	L	D+S

**Analysis Results**

Analysis	Actual	Location	Allowed	Capacity	Comb.	Case
Moment	6075 ft-lb	8'5"	22897 ft-lb	0.265 (27%)	D+S	L
Unbraced	6075 ft-lb	8'5"	6086 ft-lb	0.998 (100%)	D+S	L
Shear	1413 lb	1'3 3/8"	10197 lb	0.139 (14%)	D+S	L
LL Defl inch	0.098 (L/2006)	8'5 1/16"	0.409 (L/480)	0.239 (24%)	S	L
TL Defl inch	0.317 (L/620)	8'5 1/16"	0.819 (L/240)	0.387 (39%)	D+S	L

**Design Notes**

- 1 Provide support to prevent lateral movement and rotation at the end bearings. Lateral support may also be required at the interior bearings by the building code.
- 2 Fasten all plies using 2 rows of 10d Box nails (.128x3") at 12" o.c. Maximum end distance not to exceed 6".
- 3 Refer to last page of calculations for fasteners required for specified loads.
- 4 Girders are designed to be supported on the bottom edge only.
- 5 Top loads must be supported equally by all plies.
- 6 Top must be laterally braced at end bearings.
- 7 Bottom must be laterally braced at end bearings.
- 8 Lateral slenderness ratio based on single ply width.

ID	Load Type	Location	Trib Width	Side	Dead 0.9	Live 1	Snow 1.15	Wind 1.6	Const. 1.25	Comments
1	Uniform			Near Face	56 PLF	0 PLF	56 PLF	0 PLF	0 PLF	J3
2	Uniform			Top	60 PLF	0 PLF	0 PLF	0 PLF	0 PLF	Wall Above
	Self Weight				9 PLF					

**Notes**

Calculated Structural Designs is responsible only of the structural adequacy of this component based on the design criteria and loadings shown. It is the responsibility of the customer and/or the contractor to ensure the component suitability of the intended application, and to verify the dimensions and loads.

**Lumber**

1. Dry service conditions, unless noted otherwise
2. LVL not to be treated with fire retardant or corrosive chemicals

**Handling & Installation**

1. LVL beams must not be cut or drilled
2. Refer to manufacturer's product information regarding installation requirements, multi-ply fastening details, beam strength values, and code approvals
3. Damaged Beams must not be used
4. Design assumes top edge is laterally restrained
5. Provide lateral support at bearing points to avoid lateral displacement and rotation

6. For flat roofs provide proper drainage to prevent ponding

This design is valid until 5/29/2026

**Manufacturer Info**

Metsä Wood  
 301 Merritt 7 Building, 2nd Floor  
 Norwalk, CT 06851  
 (800) 622-5850  
[www.metsawood.com/us](http://www.metsawood.com/us)

Comtech, Inc.  
 1001 S Reilly Rd., NC  
 28314  
 (910) 864-8787



**GDH Kerto-S LVL 1.750" X 11.875" 2-Ply - PASSED**

Level: Level

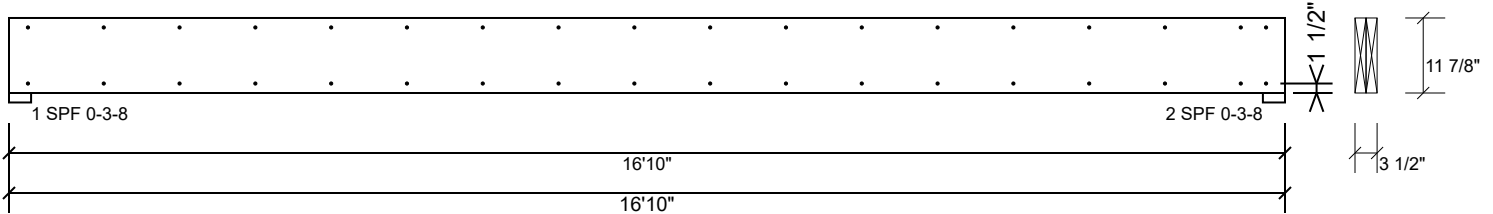

**Multi-Ply Analysis**

Fasten all plies using 2 rows of 10d Box nails (.128x3") at 12" o.c.. Maximum end distance not to exceed 6".

Capacity	29.7 %
Load	56.0 PLF
Yield Limit per Foot	188.3 PLF
Yield Limit per Fastener	94.1 lb.
C <sub>m</sub>	1
Yield Mode	IV
Edge Distance	1 1/2"
Min. End Distance	3"
Load Combination	D+S
Duration Factor	1.15

**Notes**

Calculated Structured Designs is responsible only of the structural adequacy of this component based on the design criteria and loadings shown. It is the responsibility of the customer and/or the contractor to ensure the component suitability of the intended application, and to verify the dimensions and loads.

**Lumber**

1. Dry service conditions, unless noted otherwise
2. LVL not to be treated with fire retardant or corrosive chemicals

**Handling & Installation**

1. LVL beams must not be cut or drilled
2. Refer to manufacturer's product information regarding installation requirements, multi-ply fastening details, beam strength values, and code approvals
3. Damaged Beams must not be used
4. Design assumes top edge is laterally restrained
5. Provide lateral support at bearing points to avoid lateral displacement and rotation

6. For flat roofs provide proper drainage to prevent ponding

This design is valid until 5/29/2026

**Manufacturer Info**

Metsä Wood  
 301 Merritt 7 Building, 2nd Floor  
 Norwalk, CT 06851  
 (800) 622-5850  
[www.metsawood.com/us](http://www.metsawood.com/us)

Comtech, Inc.  
 1001 S Reilly Rd., NC  
 28314  
 (910) 864-8787





**GDH2 S-P-F #2 2.000" X 12.000" 2-Ply - PASSED**

Level: Level

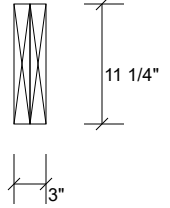
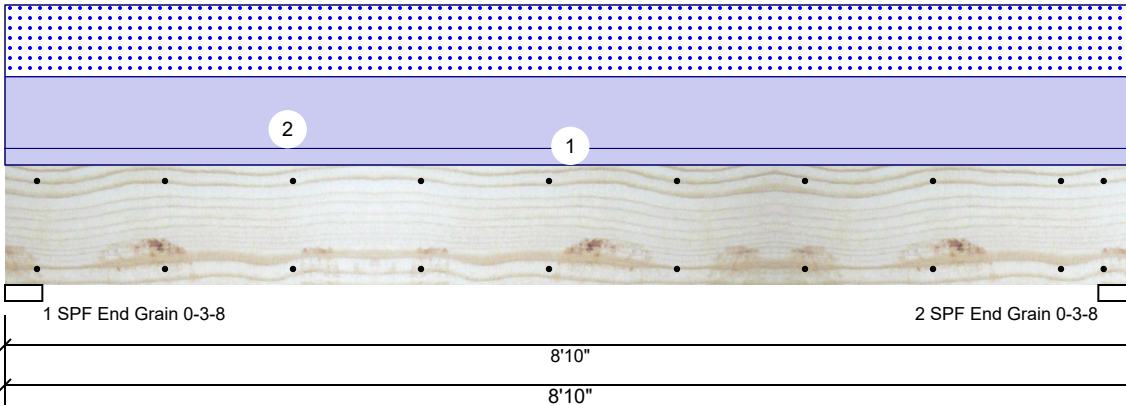

**Member Information**

Type:	Girder
Plies:	2
Moisture Condition:	Dry
Deflection LL:	480
Deflection TL:	360
Importance:	Normal - II
Temperature:	Temp <= 100°F

Application:	Floor
Design Method:	ASD
Building Code:	IBC 2012
Load Sharing:	No
Deck:	Not Checked

**Reactions UNPATTERNED Ib (Uplift)**

Brg	Direction	Live	Dead	Snow	Wind	Const
1	Vertical	0	1413	1148	0	0
2	Vertical	0	1413	1148	0	0

**Bearings**

Bearing	Length	Dir.	Cap.	React D/L Ib	Total	Ld. Case	Ld. Comb.
1 - SPF End Grain	3.500"	Vert	57%	1413 / 1148	2562	L	D+S
2 - SPF End Grain	3.500"	Vert	57%	1413 / 1148	2562	L	D+S

**Analysis Results**

Analysis	Actual	Location	Allowed	Capacity	Comb.	Case
Moment	5085 ft-lb	4'5"	5306 ft-lb	0.958 (96%)	D+S	L
Unbraced	5085 ft-lb	4'5"	5088 ft-lb	0.999 (100%)	D+S	L
Shear	1849 lb	7'7 1/4"	3493 lb	0.529 (53%)	D+S	L
LL Defl inch	0.058 (L/1740)	4'5 1/16"	0.209 (L/480)	0.276 (28%)	S	L
TL Defl inch	0.129 (L/780)	4'5 1/16"	0.279 (L/360)	0.461 (46%)	D+S	L

**Design Notes**

- 1 Provide support to prevent lateral movement and rotation at the end bearings. Lateral support may also be required at the interior bearings by the building code.
- 2 Fasten all plies using 2 rows of 10d Box nails (.128x3") at 12" o.c. Maximum end distance not to exceed 6".
- 3 Refer to last page of calculations for fasteners required for specified loads.
- 4 Girders are designed to be supported on the bottom edge only.
- 5 Top loads must be supported equally by all plies.
- 6 Top must be laterally braced at a maximum of 3'3 5/8" o.c.
- 7 Bottom must be laterally braced at end bearings.
- 8 Lateral slenderness ratio based on single ply width.

ID	Load Type	Location	Trib Width	Side	Dead 0.9	Live 1	Snow 1.15	Wind 1.6	Const. 1.25	Comments
1	Uniform			Top	60 PLF	0 PLF	0 PLF	0 PLF	0 PLF	Wall Above
2	Uniform			Top	260 PLF	0 PLF	260 PLF	0 PLF	0 PLF	G1

**Manufacturer Info**

Comtech, Inc.  
 1001 S Reilly Rd., NC  
 28314  
 (910) 864-8787



This design is valid until 5/29/2026

**GDH2 S-P-F #2 2.000" X 12.000" 2-Ply - PASSED**

Level: Level

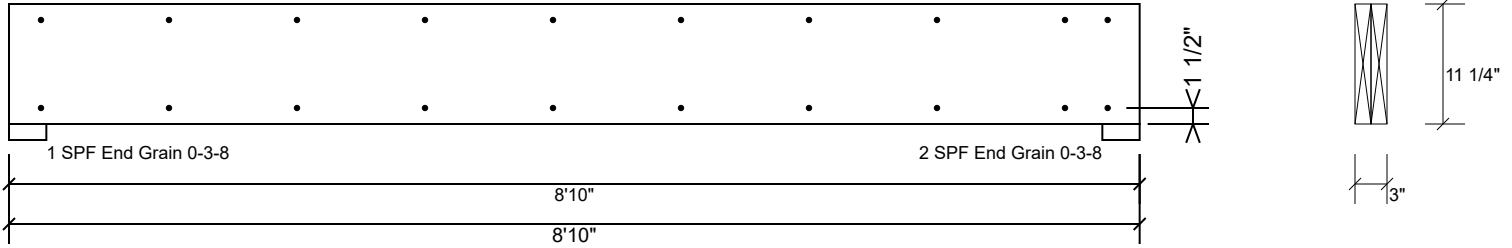

**Multi-Ply Analysis**

Fasten all plies using 2 rows of 10d Box nails (.128x3") at 12" o.c.. Maximum end distance not to exceed 6".

Capacity	0.0 %
Load	0.0 PLF
Yield Limit per Foot	157.4 PLF
Yield Limit per Fastener	78.7 lb.
C <sub>m</sub>	1
Yield Mode	IV
Edge Distance	1 1/2"
Min. End Distance	3"
Load Combination	
Duration Factor	1.00

<b>Manufacturer Info</b>	Comtech, Inc. 1001 S Reilly Rd., NC 28314 (910) 864-8787

This design is valid until 5/29/2026

RE: J0523-2577  
Lot 56 Liberty Meadow

**Trenco**  
818 Soundside Rd  
Edenton, NC 27932

**Site Information:**

Customer: Project Name: J0523-2577  
Lot/Block: Model:  
Address: Subdivision:  
City: State:

**General Truss Engineering Criteria & Design Loads (Individual Truss Design Drawings Show Special Loading Conditions):**

Design Code: IRC2015/TPI2014 Design Program: MiTek 20/20 8.4  
Wind Code: N/A Wind Speed: N/A mph  
Roof Load: N/A psf Floor Load: 55.0 psf

This package includes 10 individual, dated Truss Design Drawings and 0 Additional Drawings.

No.	Seal#	Truss Name	Date
1	I56917899	ET1	3/1/2023
2	I56917900	ET2	3/1/2023
3	I56917901	ET3	3/1/2023
4	I56917902	F1	3/1/2023
5	I56917903	F2	3/1/2023
6	I56917904	F3	3/1/2023
7	I56917905	F4	3/1/2023
8	I56917906	F4A	3/1/2023
9	I56917907	F5	3/1/2023
10	I56917908	FG1	3/1/2023

The truss drawing(s) referenced above have been prepared by Truss Engineering Co. under my direct supervision based on the parameters provided by Comtech, Inc - Fayetteville.

Truss Design Engineer's Name: Gilbert, Eric

My license renewal date for the state of North Carolina is December 31, 2023.

North Carolina COA: C-0844

IMPORTANT NOTE: The seal on these truss component designs is a certification that the engineer named is licensed in the jurisdiction(s) identified and that the designs comply with ANSI/TPI 1. These designs are based upon parameters shown (e.g., loads, supports, dimensions, shapes and design codes), which were given to TRENCO. Any project specific information included is for TRENCO customers file reference purpose only, and was not taken into account in the preparation of these designs. TRENCO has not independently verified the applicability of the design parameters or the designs for any particular building. Before use, the building designer should verify applicability of design parameters and properly incorporate these designs into the overall building design per ANSI/TPI 1, Chapter 2.



March 01, 2023

Job J0523-2577	Truss ET1	Truss Type GABLE	Qty 1	Ply 1	Lot 56 Liberty Meadow I56917899
-------------------	--------------	---------------------	----------	----------	------------------------------------

Comtech, Inc. Fayetteville, NC - 28314,

8.430 s Jan 6 2022 MiTek Industries, Inc. Wed Mar 1 09:54:46 2023 Page 1  
ID:aTXuLo?nW09qtpROz2WQ0wydkZW-vFAMz0lokDfoj\_POPHmBiuM3HfXVKefis35yipzfKAt

0-1/8

0-1/8

Scale = 1:55.0

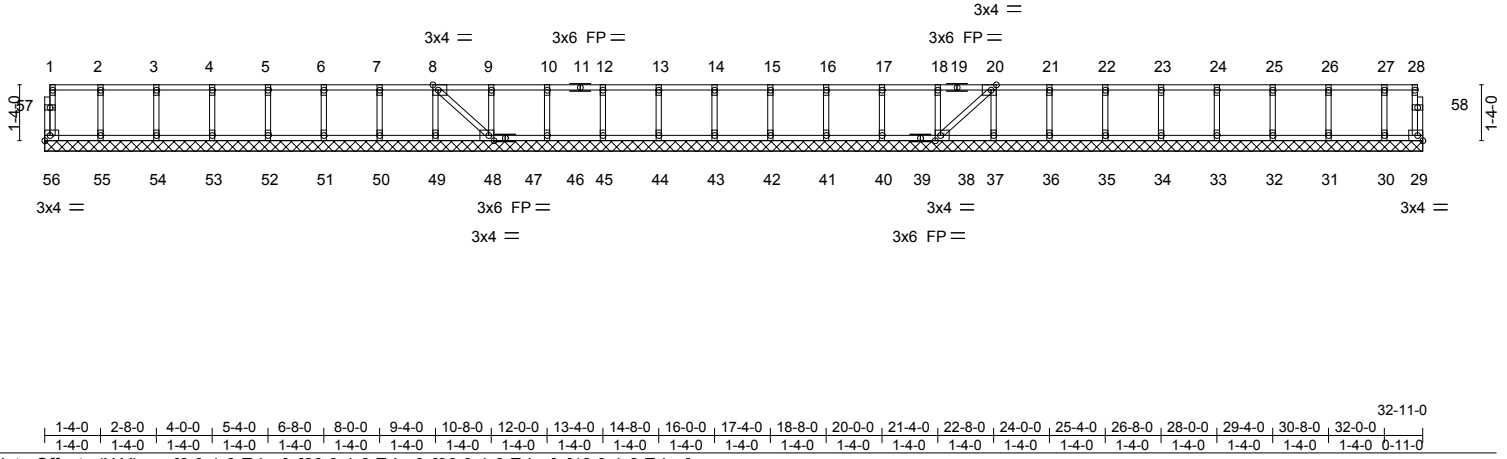

LOADING (psf)	SPACING-	2-0-0	CSI.	DEFL.	in (loc)	l/defl	L/d	PLATES	GRIP
TCLL 40.0	Plate Grip DOL	1.00	TC 0.06	Vert(LL)	n/a	-	n/a	MT20	244/190
TCDL 10.0	Lumber DOL	1.00	BC 0.01	Vert(CT)	n/a	-	n/a		
BCLL 0.0	Rep Stress Incr	YES	WB 0.03	Horz(CT)	-0.00	38	n/a		
BCDL 5.0	Code IRC2015/TPI2014		Matrix-S					Weight: 147 lb	FT = 20%F, 11%E

LUMBER-	BRACING-
TOP CHORD 2x4 SP No.1(flat)	TOP CHORD Structural wood sheathing directly applied or 6-0-0 oc purlins, except end verticals.
BOT CHORD 2x4 SP No.1(flat)	BOT CHORD Rigid ceiling directly applied or 6-0-0 oc bracing.
WEBS 2x4 SP No.3(flat)	
OTHERS 2x4 SP No.3(flat)	

**REACTIONS.** All bearings 32-11-0.  
(lb) - Max Grav All reactions 250 lb or less at joint(s) 56, 29, 55, 54, 53, 52, 51, 50, 49, 48, 46, 45, 44, 43, 42, 41, 40, 38, 37, 36, 35, 34, 33, 32, 31, 30

**FORCES.** (lb) - Max. Comp./Max. Ten. - All forces 250 (lb) or less except when shown.

- NOTES-**
- 1) All plates are 1.5x3 MT20 unless otherwise indicated.
  - 2) Plates checked for a plus or minus 1 degree rotation about its center.
  - 3) Gable requires continuous bottom chord bearing.
  - 4) Truss to be fully sheathed from one face or securely braced against lateral movement (i.e. diagonal web).
  - 5) Gable studs spaced at 1-4-0 oc.
  - 6) Recommend 2x6 strongbacks, on edge, spaced at 10-0-0 oc and fastened to each truss with 3-10d (0.131" X 3") nails. Strongbacks to be attached to walls at their outer ends or restrained by other means.



March 1, 2023

Job J0523-2577	Truss ET2	Truss Type GABLE	Qty 1	Ply 1	Lot 56 Liberty Meadow I56917900
-------------------	--------------	---------------------	----------	----------	------------------------------------

Comtech, Inc. Fayetteville, NC - 28314,

8.430 s Jan 6 2022 MiTek Industries, Inc. Wed Mar 1 09:54:47 2023 Page 1  
ID:aTXuLo?nW09qtpROz2WQ0wydkZW-NRkiAMJQVXnfl8\_az\_HQE6vDv3tj35vr5jrWEFzfkAs

0-1-8

Scale = 1:30.5

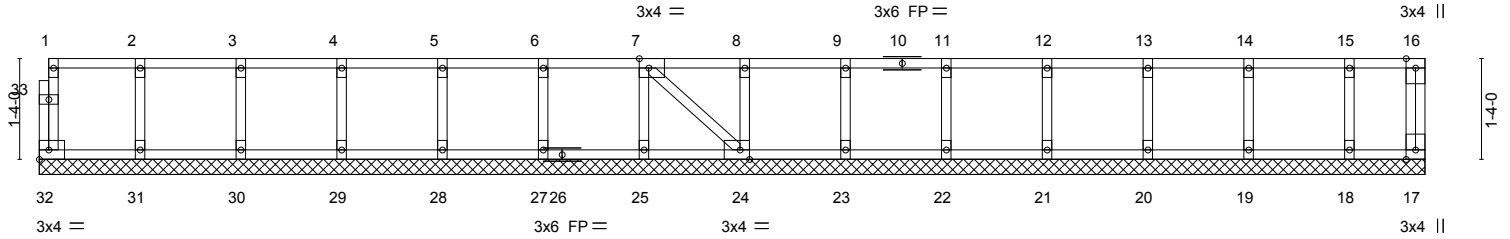

1-4-0	2-8-0	4-0-0	5-4-0	6-8-0	8-0-0	9-4-0	10-8-0	12-0-0	13-4-0	14-8-0	16-0-0	17-4-0	18-4-0
1-4-0	1-4-0	1-4-0	1-4-0	1-4-0	1-4-0	1-4-0	1-4-0	1-4-0	1-4-0	1-4-0	1-4-0	1-4-0	1-0-0

Plate Offsets (X,Y)-- [7:0-1-8,Edge], [24:0-1-8,Edge]											
<b>LOADING</b> (psf)	<b>SPACING-</b>	2-0-0	<b>CSI.</b>	<b>DEFL.</b>	in (loc)	l/defl	L/d	<b>PLATES</b>	<b>GRIP</b>		
TCLL 40.0	Plate Grip DOL	1.00	TC 0.07	Vert(LL)	n/a	-	n/a	MT20	244/190		
TCDL 10.0	Lumber DOL	1.00	BC 0.01	Vert(CT)	n/a	-	n/a				
BCLL 0.0	Rep Stress Incr	NO	WB 0.03	Horz(CT)	0.00	17	n/a				
BCDL 5.0	Code IRC2015/TPI2014		Matrix-S							Weight: 84 lb	FT = 20%F, 11%E

<b>LUMBER-</b>	<b>BRACING-</b>
TOP CHORD 2x4 SP No.1(flat)	TOP CHORD Structural wood sheathing directly applied or 6-0-0 oc purlins, except end verticals.
BOT CHORD 2x4 SP No.1(flat)	BOT CHORD Rigid ceiling directly applied or 10-0-0 oc bracing.
WEBS 2x4 SP No.3(flat)	
OTHERS 2x4 SP No.3(flat)	

**REACTIONS.** All bearings 18-4-0.  
(lb) - Max Grav All reactions 250 lb or less at joint(s) 32, 17, 31, 30, 29, 28, 27, 25, 24, 23, 22, 21, 20, 19, 18

**FORCES.** (lb) - Max. Comp./Max. Ten. - All forces 250 (lb) or less except when shown.

- NOTES-**
- All plates are 1.5x3 MT20 unless otherwise indicated.
  - Plates checked for a plus or minus 1 degree rotation about its center.
  - Gable requires continuous bottom chord bearing.
  - Truss to be fully sheathed from one face or securely braced against lateral movement (i.e. diagonal web).
  - Gable studs spaced at 1-4-0 oc.
  - Recommend 2x6 strongbacks, on edge, spaced at 10-0-0 oc and fastened to each truss with 3-10d (0.131" X 3") nails. Strongbacks to be attached to walls at their outer ends or restrained by other means.
  - CAUTION, Do not erect truss backwards.



March 1, 2023

<p><b>WARNING - Verify design parameters and READ NOTES ON THIS AND INCLUDED MITEK REFERENCE PAGE MII-7473 rev. 1/2/2023 BEFORE USE.</b></p> <p>Design valid for use only with MiTek® connectors. This design is based only upon parameters shown, and is for an individual building component, not a truss system. Before use, the building designer must verify the applicability of design parameters and properly incorporate this design into the overall building design. Bracing indicated is to prevent buckling of individual truss web and/or chord members only. Additional temporary and permanent bracing is always required for stability and to prevent collapse with possible personal injury and property damage. For general guidance regarding the fabrication, storage, delivery, erection and bracing of trusses and truss systems, see <b>ANSI/TP1 Quality Criteria and DSB-22</b> available from Truss Plate Institute (www.tpinst.org) and <b>BCSI Building Component Safety Information</b> available from the Structural Building Component Association (www.sbcacomponents.com)</p>	<p>ENGINEERING BY</p>  <p>A MiTek Affiliate</p> <p>818 Soundside Road Edenton, NC 27932</p>
--	--

Job J0523-2577	Truss ET3	Truss Type GABLE	Qty 1	Ply 1	Lot 56 Liberty Meadow I56917901
-------------------	--------------	---------------------	----------	----------	------------------------------------

Comtech, Inc. Fayetteville, NC - 28314,

8.430 s Jan 6 2022 MiTek Industries, Inc. Wed Mar 1 09:54:48 2023 Page 1  
ID:aTXuLo?nW09qtpROz2WQ0wydkZW-rdl7OiK2GrvWylZnWipfnJSPnTDzoY9\_KNa3nhzfKAR

0-1-8

Scale: 3/8"=1'

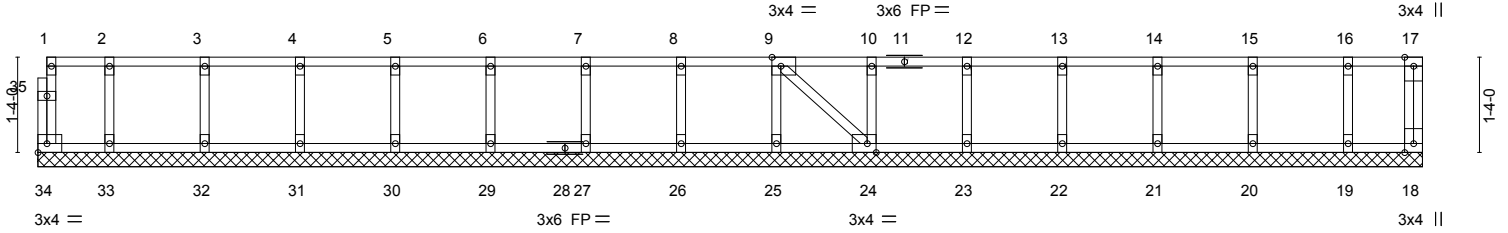

1-0-0	2-4-0	3-8-0	5-0-0	6-4-0	7-8-0	9-0-0	10-4-0	11-8-0	13-0-0	14-4-0	15-8-0	17-0-0	18-4-0	19-4-8
1-0-0	1-4-0	1-4-0	1-4-0	1-4-0	1-4-0	1-4-0	1-4-0	1-4-0	1-4-0	1-4-0	1-4-0	1-4-0	1-4-0	1-0-8

Plate Offsets (X,Y)-- [9:0-1-8,Edge], [24:0-1-8,Edge]						PLATES		GRIP	
<b>LOADING</b> (psf)	<b>SPACING-</b>	2-0-0	<b>CSI.</b>	<b>DEFL.</b>	in (loc)	l/defl	L/d	MT20	244/190
TCLL 40.0	Plate Grip DOL	1.00	TC 0.06	Vert(LL)	n/a	-	n/a		
TCDL 10.0	Lumber DOL	1.00	BC 0.01	Vert(CT)	n/a	-	n/a		
BCLL 0.0	Rep Stress Incr	YES	WB 0.03	Horz(CT)	0.00	18	n/a		
BCDL 5.0	Code IRC2015/TPI2014		Matrix-S					Weight: 89 lb	FT = 20%F, 11%E

<b>LUMBER-</b>	<b>BRACING-</b>
TOP CHORD 2x4 SP No.1(flat)	TOP CHORD Structural wood sheathing directly applied or 6-0-0 oc purlins, except end verticals.
BOT CHORD 2x4 SP No.1(flat)	BOT CHORD Rigid ceiling directly applied or 10-0-0 oc bracing.
WEBS 2x4 SP No.3(flat)	
OTHERS 2x4 SP No.3(flat)	

**REACTIONS.** All bearings 19-4-8.  
(lb) - Max Grav All reactions 250 lb or less at joint(s) 34, 18, 33, 32, 31, 30, 29, 27, 26, 25, 24, 23, 22, 21, 20, 19

**FORCES.** (lb) - Max. Comp./Max. Ten. - All forces 250 (lb) or less except when shown.

- NOTES-**
- 1) All plates are 1.5x3 MT20 unless otherwise indicated.
  - 2) Plates checked for a plus or minus 1 degree rotation about its center.
  - 3) Gable requires continuous bottom chord bearing.
  - 4) Truss to be fully sheathed from one face or securely braced against lateral movement (i.e. diagonal web).
  - 5) Gable studs spaced at 1-4-0 oc.
  - 6) Recommend 2x6 strongbacks, on edge, spaced at 10-0-0 oc and fastened to each truss with 3-10d (0.131" X 3") nails. Strongbacks to be attached to walls at their outer ends or restrained by other means.
  - 7) CAUTION, Do not erect truss backwards.

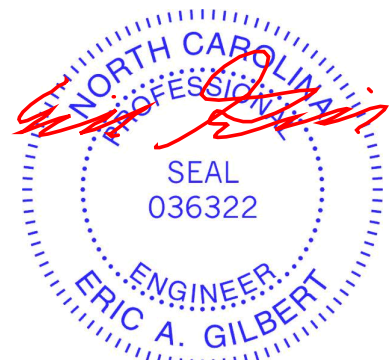

March 1, 2023



Job J0523-2577	Truss F1	Truss Type Floor	Qty 7	Ply 1	Lot 56 Liberty Meadow I56917902
-------------------	-------------	---------------------	----------	----------	------------------------------------

Comtech, Inc. Fayetteville, NC - 28314,

8.430 s Jan 6 2022 MiTek Industries, Inc. Wed Mar 1 09:54:50 2023 Page 1  
ID:aTXuLo?nW09qtpROz2WQ0wydkZW-o0QtpOLJoS9ECcj9e7r7skXcJGIlGJMHng3ArazfKAP

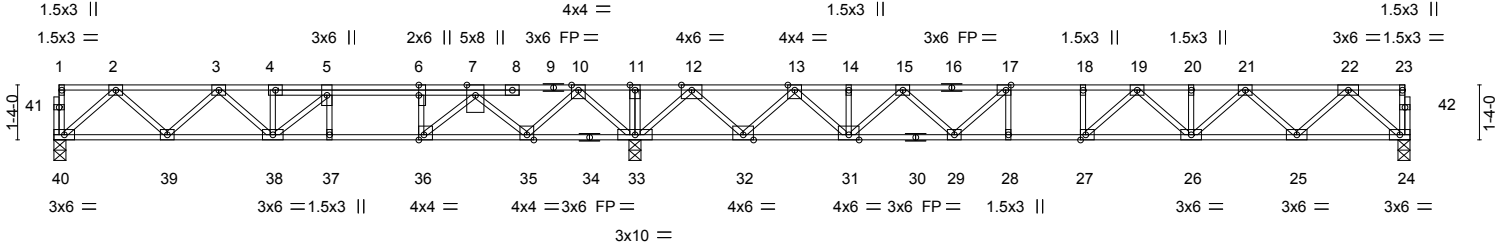

Plate Offsets (X,Y)--	[6:0-3-0,0-0-0], [17:0-1-8,Edge], [27:0-1-8,Edge], [36:0-1-8,Edge]
-----------------------	--

LOADING (psf)	SPACING-	CSI.	DEFL.	PLATES	GRIP
TCLL 40.0	2-0-0	TC 0.63	in (loc) l/defl L/d	MT20	244/190
TCDL 10.0	Plate Grip DOL 1.00	LC 0.82	Vert(LL) -0.20 27 >999 480		
BCLL 0.0	Lumber DOL 1.00	WB 0.63	Vert(CT) -0.27 26-27 >820 360		
BCDL 5.0	Rep Stress Incr YES	Matrix-S	Horz(CT) 0.04 24 n/a n/a		
	Code IRC2015/TPI2014			Weight: 180 lb	FT = 20%F, 11%E

<b>LUMBER-</b>	<b>BRACING-</b>
TOP CHORD 2x4 SP No.1(flat)	TOP CHORD Structural wood sheathing directly applied or 6-0-0 oc purlins, except end verticals.
BOT CHORD 2x4 SP No.1(flat)	BOT CHORD Rigid ceiling directly applied or 6-0-0 oc bracing.
WEBS 2x4 SP No.3(flat)	

**REACTIONS.** (size) 40=0-3-8, 24=0-3-8, 33=0-3-8  
Max Grav 40=662(LC 3), 24=882(LC 4), 33=2190(LC 1)

**FORCES.** (lb) - Max. Comp./Max. Ten. - All forces 250 (lb) or less except when shown.

TOP CHORD 2-3=-1110/36, 3-4=-1659/212, 4-5=-1659/219, 5-6=-1602/621, 6-7=-1602/621, 7-10=-392/1404, 10-11=0/2571, 11-12=0/2571, 12-13=-40/475, 13-14=-1631/0, 14-15=-1631/0, 15-17=-2564/0, 17-18=-2931/0, 18-19=-2931/0, 19-20=-2592/0, 20-21=-2592/0, 21-22=-1586/0

BOT CHORD 39-40=0/704, 38-39=-106/1489, 37-38=-621/1602, 36-37=-621/1602, 35-36=-1086/1024, 33-35=-1709/0, 32-33=-1291/0, 31-32=-200/935, 29-31=0/2220, 28-29=0/2931, 27-28=0/2931, 26-27=0/2856, 25-26=0/2193, 24-25=0/952

WEBS 2-40=935/0, 2-39=-59/564, 3-39=-528/98, 4-38=-325/0, 5-38=0/648, 22-24=-1266/0, 22-25=0/881, 21-25=-845/0, 21-26=0/542, 19-26=-358/0, 19-27=-253/331, 12-33=-1704/0, 12-32=0/1314, 10-33=-1399/0, 10-35=0/993, 7-35=-1033/0, 7-36=0/1214, 6-36=-690/0, 13-32=-1288/0, 13-31=0/991, 15-31=-835/0, 15-29=0/579, 17-29=-718/0

- NOTES-**
- 1) Unbalanced floor live loads have been considered for this design.
  - 2) All plates are 3x4 MT20 unless otherwise indicated.
  - 3) Plates checked for a plus or minus 1 degree rotation about its center.
  - 4) Recommend 2x6 strongbacks, on edge, spaced at 10-0-0 oc and fastened to each truss with 3-10d (0.131" X 3") nails. Strongbacks to be attached to walls at their outer ends or restrained by other means.
  - 5) CAUTION, Do not erect truss backwards.

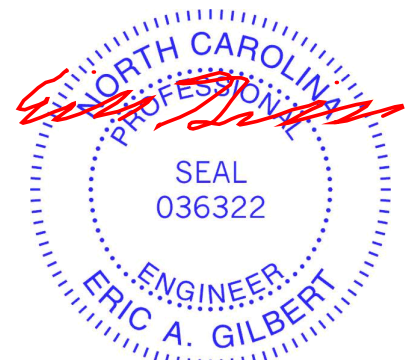

March 1, 2023

<p><b>WARNING - Verify design parameters and READ NOTES ON THIS AND INCLUDED MITEK REFERENCE PAGE MII-7473 rev. 1/2/2023 BEFORE USE.</b></p> <p>Design valid for use only with MiTek® connectors. This design is based only upon parameters shown, and is for an individual building component, not a truss system. Before use, the building designer must verify the applicability of design parameters and properly incorporate this design into the overall building design. Bracing indicated is to prevent buckling of individual truss web and/or chord members only. Additional temporary and permanent bracing is always required for stability and to prevent collapse with possible personal injury and property damage. For general guidance regarding the fabrication, storage, delivery, erection and bracing of trusses and truss systems, see <b>ANSI/TPI1 Quality Criteria and DSB-22</b> available from Truss Plate Institute (www.tpinst.org) and <b>BCSI Building Component Safety Information</b> available from the Structural Building Component Association (www.sbcacomponents.com)</p>	<p>818 Soundside Road Edenton, NC 27932</p>
---	---

Job	Truss	Truss Type	Qty	Ply	Lot 56 Liberty Meadow	I56917903
J0523-2577	F2	Floor	3	1		

Comtech, Inc. Fayetteville, NC - 28314,

8.430 s Jan 6 2022 MiTek Industries, Inc. Wed Mar 1 09:54:52 2023 Page 1  
 ID:aTXuLo?nW09qtpROz2WQ0wydkZW-kPXeD3NZK3PyRvtYIYtbx9ctN4MkEBaF\_YHwSzfKAn

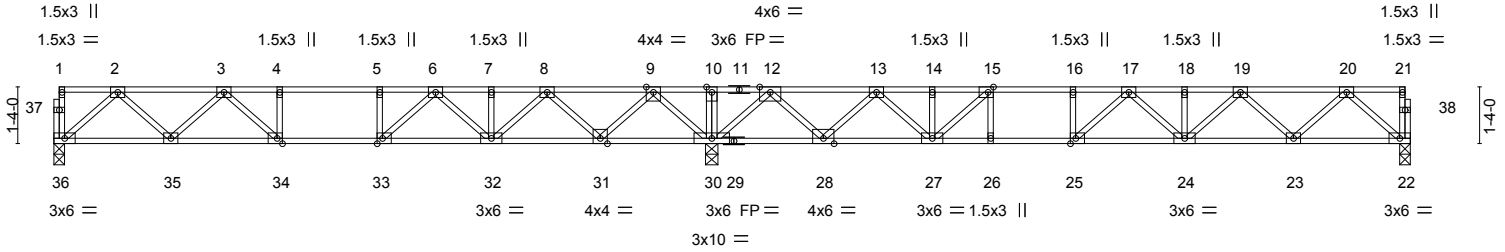

	15-5-12	31-11-0
	15-5-12	16-5-4
Plate Offsets (X, Y)--	[15:0-1-8,Edge], [25:0-1-8,Edge], [33:0-1-8,Edge], [34:0-1-8,Edge]	

LOADING (psf)	SPACING-	CSI.	DEFL.	PLATES	GRIP
TCLL 40.0	2-0-0	TC 0.85	in (loc) l/defl L/d	MT20	244/190
TCDL 10.0	Plate Grip DOL 1.00	BC 0.91	Vert(LL) -0.18 24-25 >999 480		
BCLL 0.0	Lumber DOL 1.00	WB 0.54	Vert(CT) -0.25 24-25 >776 360		
BCDL 5.0	Rep Stress Incr YES	Matrix-S	Horz(CT) 0.04 22 n/a n/a		
	Code IRC2015/TPI2014			Weight: 167 lb	FT = 20%F, 11%E

**LUMBER-**  
 TOP CHORD 2x4 SP No.1(flat)  
 BOT CHORD 2x4 SP No.1(flat)  
 WEBS 2x4 SP No.3(flat)

**BRACING-**  
 TOP CHORD Structural wood sheathing directly applied or 6-0-0 oc purlins, except end verticals.  
 BOT CHORD Rigid ceiling directly applied or 6-0-0 oc bracing.

**REACTIONS.** (size) 36=0-3-0, 30=0-3-8, 22=0-3-0  
 Max Grav 36=719(LC 3), 30=2079(LC 1), 22=795(LC 4)

**FORCES.** (lb) - Max. Comp./Max. Ten. - All forces 250 (lb) or less except when shown.

TOP CHORD 2-3=-1229/0, 3-4=-1941/0, 4-5=-1941/0, 5-6=-1941/0, 6-7=-1408/202, 7-8=-1408/202, 8-9=-241/659, 9-10=0/2218, 10-12=0/2218, 12-13=-523/817, 13-14=-1712/332, 14-15=-1712/332, 15-16=-2291/0, 16-17=-2291/0, 17-18=-2225/0, 18-19=-2225/0, 19-20=-1395/0

BOT CHORD 35-36=0/769, 34-35=0/1668, 33-34=0/1941, 32-33=-35/1748, 31-32=-414/927, 30-31=-1214/0, 28-30=-1129/0, 27-28=-547/1232, 26-27=0/2291, 25-26=0/2291, 24-25=0/2385, 23-24=0/1918, 22-23=0/852

WEBS 2-36=-1022/0, 2-35=0/640, 3-35=-610/0, 3-34=-83/372, 9-30=-1439/0, 9-31=0/1062, 20-22=-1132/0, 20-23=0/755, 19-23=-728/0, 19-24=-1/417, 17-25=-477/33, 12-30=-1508/0, 8-31=-1027/0, 8-32=0/734, 6-32=-547/0, 6-33=0/628, 5-33=-320/0, 12-28=0/1134, 13-28=-1085/0, 13-27=0/740, 15-27=-1088/0, 15-26=0/273

- NOTES-**
- 1) Unbalanced floor live loads have been considered for this design.
  - 2) All plates are 3x4 MT20 unless otherwise indicated.
  - 3) Plates checked for a plus or minus 1 degree rotation about its center.
  - 4) Recommend 2x6 strongbacks, on edge, spaced at 10-0-0 oc and fastened to each truss with 3-10d (0.131" X 3") nails. Strongbacks to be attached to walls at their outer ends or restrained by other means.
  - 5) CAUTION, Do not erect truss backwards.



March 1, 2023

**WARNING - Verify design parameters and READ NOTES ON THIS AND INCLUDED MITEK REFERENCE PAGE MII-7473 rev. 1/2/2023 BEFORE USE.**

Design valid for use only with MiTek® connectors. This design is based only upon parameters shown, and is for an individual building component, not a truss system. Before use, the building designer must verify the applicability of design parameters and properly incorporate this design into the overall building design. Bracing indicated is to prevent buckling of individual truss web and/or chord members only. Additional temporary and permanent bracing is always required for stability and to prevent collapse with possible personal injury and property damage. For general guidance regarding the fabrication, storage, delivery, erection and bracing of trusses and truss systems, see **ANSI/TPI1 Quality Criteria and DSB-22** available from Truss Plate Institute (www.tpinst.org) and **BCSI Building Component Safety Information** available from the Structural Building Component Association (www.sbcacomponents.com)

**ENGINEERING BY**  
**TRENCO**  
 A MiTek Affiliate

818 Soundside Road  
 Edenton, NC 27932

Job J0523-2577	Truss F3	Truss Type Floor	Qty 9	Ply 1	Lot 56 Liberty Meadow I56917904
-------------------	-------------	---------------------	----------	----------	------------------------------------

Comtech, Inc. Fayetteville, NC - 28314,

8.430 s Jan 6 2022 MiTek Industries, Inc. Wed Mar 1 09:54:53 2023 Page 1

ID:aTXuLo?nW09qtpROz2WQ0wydkZW-Cb50RPNB5NXp33RkJFOqUN97gUjPThFjTelqSvzfKAm

0-1-8

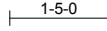
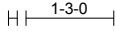

0-1-8  
Scale = 1:32.8

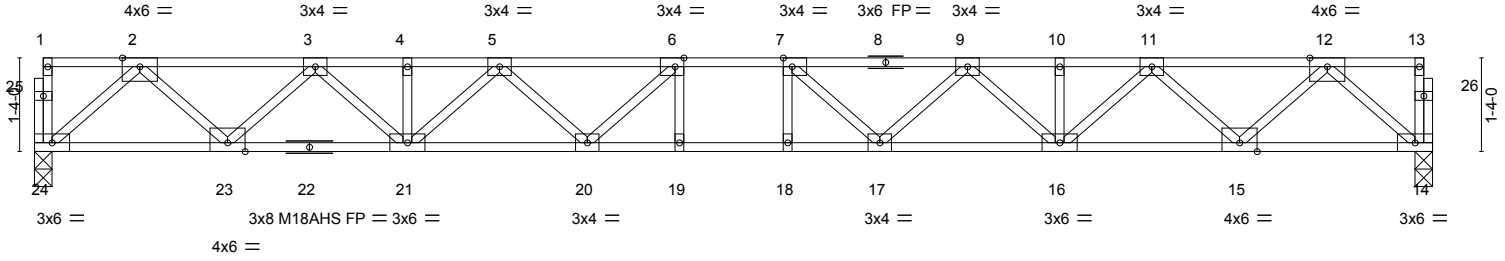

19-11-0  
19-11-0

Plate Offsets (X,Y)-- [6:0-1-8,Edge], [7:0-1-8,Edge]

<b>LOADING</b> (psf)	<b>SPACING-</b>	2-0-0	<b>CSI.</b>	<b>DEFL.</b>	in (loc)	l/defl	L/d	<b>PLATES</b>	<b>GRIP</b>
TCLL 40.0	Plate Grip DOL	1.00	TC 0.56	Vert(LL)	-0.33 18-19	>724	480	MT20	244/190
TCDL 10.0	Lumber DOL	1.00	BC 0.95	Vert(CT)	-0.45 18-19	>526	360	M18AHS	186/179
BCLL 0.0	Rep Stress Incr	YES	WB 0.55	Horz(CT)	0.08 14	n/a	n/a		
BCDL 5.0	Code IRC2015/TP12014		Matrix-S						
								Weight: 106 lb	FT = 20%F, 11%E

<b>LUMBER-</b>	<b>BRACING-</b>
TOP CHORD 2x4 SP No.1(flat)	TOP CHORD Structural wood sheathing directly applied or 5-9-6 oc purlins, except end verticals.
BOT CHORD 2x4 SP No.1(flat)	BOT CHORD Rigid ceiling directly applied or 2-2-0 oc bracing.
WEBS 2x4 SP No.3(flat)	

**REACTIONS.** (size) 24=0-3-0, 14=0-3-0  
Max Grav 24=1075(LC 1), 14=1075(LC 1)

**FORCES.** (lb) - Max. Comp./Max. Ten. - All forces 250 (lb) or less except when shown.  
TOP CHORD 2-3=-2005/0, 3-4=-3408/0, 4-5=-3408/0, 5-6=-4160/0, 6-7=-4391/0, 7-9=-4160/0, 9-10=-3408/0, 10-11=-3408/0, 11-12=-2005/0  
BOT CHORD 23-24=0/1172, 21-23=0/2810, 20-21=0/3918, 19-20=0/4391, 18-19=0/4391, 17-18=0/4391, 16-17=0/3918, 15-16=0/2810, 14-15=0/1172  
WEBS 2-24=-1557/0, 2-23=0/1160, 3-23=-1119/0, 3-21=0/814, 5-21=-693/0, 5-20=0/469, 6-20=-575/87, 12-14=-1557/0, 12-15=0/1160, 11-15=-1119/0, 11-16=0/814, 9-16=-693/0, 9-17=0/469, 7-17=-575/87

- NOTES-**
- 1) Unbalanced floor live loads have been considered for this design.
  - 2) All plates are MT20 plates unless otherwise indicated.
  - 3) All plates are 1.5x3 MT20 unless otherwise indicated.
  - 4) Plates checked for a plus or minus 1 degree rotation about its center.
  - 5) Recommend 2x6 strongbacks, on edge, spaced at 10-0-0 oc and fastened to each truss with 3-10d (0.131" X 3") nails. Strongbacks to be attached to walls at their outer ends or restrained by other means.

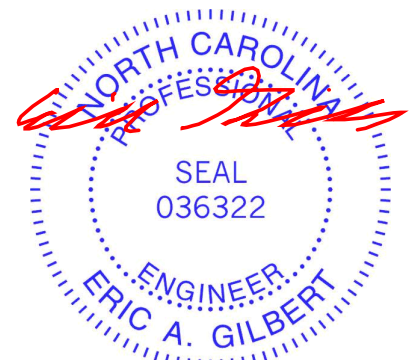

March 1, 2023

<p><b>WARNING - Verify design parameters and READ NOTES ON THIS AND INCLUDED MITEK REFERENCE PAGE MII-7473 rev. 1/2/2023 BEFORE USE.</b></p> <p>Design valid for use only with MiTek® connectors. This design is based only upon parameters shown, and is for an individual building component, not a truss system. Before use, the building designer must verify the applicability of design parameters and properly incorporate this design into the overall building design. Bracing indicated is to prevent buckling of individual truss web and/or chord members only. Additional temporary and permanent bracing is always required for stability and to prevent collapse with possible personal injury and property damage. For general guidance regarding the fabrication, storage, delivery, erection and bracing of trusses and truss systems, see <b>ANSI/TP1 Quality Criteria and DSB-22</b> available from Truss Plate Institute (www.tpinst.org) and <b>BCSI Building Component Safety Information</b> available from the Structural Building Component Association (www.sbcacomponents.com)</p>	<p>ENGINEERING BY <b>TRENCO</b> A MiTek Affiliate</p> <p>818 Soundside Road Edenton, NC 27932</p>
--	---

Job J0523-2577	Truss F4	Truss Type Floor	Qty 10	Ply 1	Lot 56 Liberty Meadow I56917905
-------------------	-------------	---------------------	-----------	----------	------------------------------------

Comtech, Inc. Fayetteville, NC - 28314,

8.430 s Jan 6 2022 MiTek Industries, Inc. Wed Mar 1 09:54:54 2023 Page 1  
ID:aTXuLo?nW09qtpROz2WQ0wydkZW-gnfOelOpshfggD0xytv31ahK0t3hC8etil1O\_LzfKAI

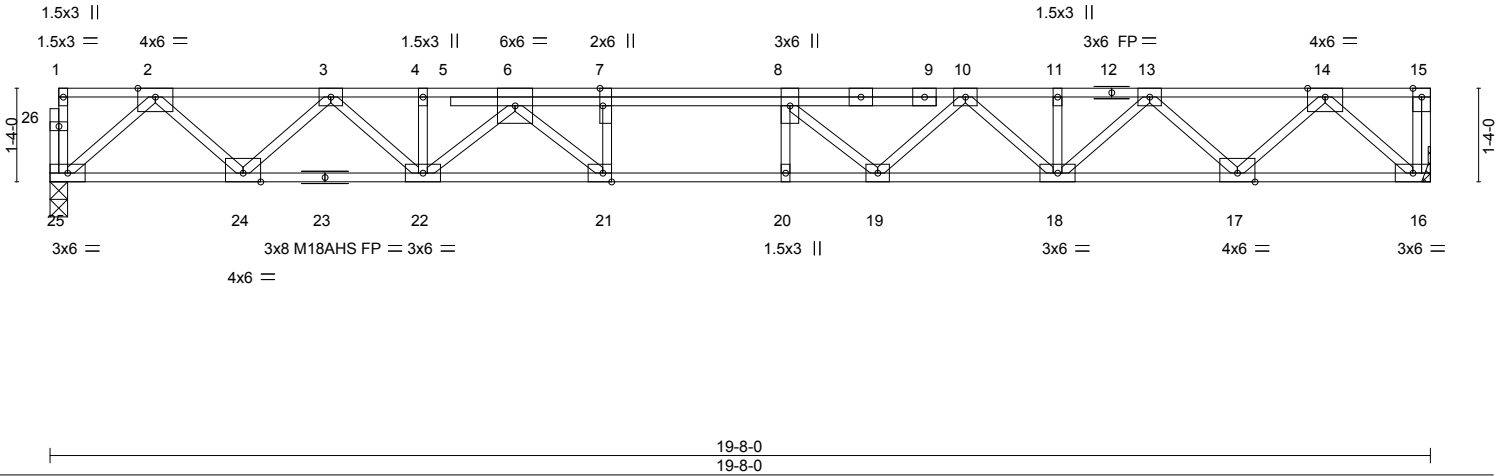

Plate Offsets (X, Y)-- [7:0-3-0,Edge], [21:0-1-8,Edge]										
<b>LOADING</b> (psf)	<b>SPACING-</b>	2-0-0	<b>CSI.</b>	<b>DEFL.</b>	in	(loc)	l/defl	L/d	<b>PLATES</b>	<b>GRIP</b>
TCLL 40.0	Plate Grip DOL	1.00	TC 0.39	Vert(LL)	-0.29	20	>806	480	MT20	244/190
TCDL 10.0	Lumber DOL	1.00	BC 0.88	Vert(CT)	-0.40	20	>587	360	M18AHS	186/179
BCLL 0.0	Rep Stress Incr	YES	WB 0.54	Horz(CT)	0.08	16	n/a	n/a		
BCDL 5.0	Code IRC2015/TP12014		Matrix-S							
									Weight: 112 lb	FT = 20%F, 11%E

<b>LUMBER-</b>	<b>BRACING-</b>
TOP CHORD 2x4 SP No.1(flat)	TOP CHORD Structural wood sheathing directly applied or 6-0-0 oc purlins, except end verticals.
BOT CHORD 2x4 SP No.1(flat)	BOT CHORD Rigid ceiling directly applied or 10-0-0 oc bracing.
WEBS 2x4 SP No.3(flat)	

**REACTIONS.** (size) 25=0-3-0, 16=Mechanical  
Max Grav 25=1062(LC 1), 16=1068(LC 1)

**FORCES.** (lb) - Max. Comp./Max. Ten. - All forces 250 (lb) or less except when shown.  
TOP CHORD 2-3=-1976/0, 3-4=-3346/0, 4-6=-3350/0, 6-7=-4437/0, 7-8=-4437/0, 8-10=-4140/0, 10-11=-3354/0, 11-13=-3354/0, 13-14=-1976/0  
BOT CHORD 24-25=0/1156, 22-24=0/2765, 21-22=0/3951, 20-21=0/4437, 19-20=0/4437, 18-19=0/3823, 17-18=0/2764, 16-17=0/1157  
WEBS 2-25=-1537/0, 2-24=0/1140, 3-24=-1097/0, 3-22=0/790, 6-22=-803/0, 6-21=0/970, 7-21=-557/0, 14-16=-1541/0, 14-17=0/1139, 13-17=-1096/0, 13-18=0/802, 10-18=-637/0, 10-19=0/581, 8-19=-621/0

- NOTES-**
- 1) Unbalanced floor live loads have been considered for this design.
  - 2) All plates are MT20 plates unless otherwise indicated.
  - 3) All plates are 3x4 MT20 unless otherwise indicated.
  - 4) Plates checked for a plus or minus 1 degree rotation about its center.
  - 5) Refer to girder(s) for truss to truss connections.
  - 6) Recommend 2x6 strongbacks, on edge, spaced at 10-0-0 oc and fastened to each truss with 3-10d (0.131" X 3") nails. Strongbacks to be attached to walls at their outer ends or restrained by other means.
  - 7) CAUTION, Do not erect truss backwards.



March 1, 2023

<p><b>WARNING - Verify design parameters and READ NOTES ON THIS AND INCLUDED MITEK REFERENCE PAGE MII-7473 rev. 1/2/2023 BEFORE USE.</b></p> <p>Design valid for use only with MiTek® connectors. This design is based only upon parameters shown, and is for an individual building component, not a truss system. Before use, the building designer must verify the applicability of design parameters and properly incorporate this design into the overall building design. Bracing indicated is to prevent buckling of individual truss web and/or chord members only. Additional temporary and permanent bracing is always required for stability and to prevent collapse with possible personal injury and property damage. For general guidance regarding the fabrication, storage, delivery, erection and bracing of trusses and truss systems, see <b>ANSI/TP1 Quality Criteria and DSB-22</b> available from Truss Plate Institute (www.tpinst.org) and <b>BCSI Building Component Safety Information</b> available from the Structural Building Component Association (www.sbcacomponents.com)</p>	<p>818 Soundside Road Edenton, NC 27932</p>
--	---

Job J0523-2577	Truss F4A	Truss Type Floor	Qty 1	Ply 1	Lot 56 Liberty Meadow Job Reference (optional)	I56917906
-------------------	--------------	---------------------	----------	----------	---	-----------

Comtech, Inc. Fayetteville, NC - 28314,

8.430 s Jan 6 2022 MiTek Industries, Inc. Wed Mar 1 09:54:56 2023 Page 1  
ID:aTXuLo?nW09qtpROz2WQ0wydkZW-cAn83RQ3OlvNwXAJ\_NyX6?ngOhsyg5uA9cWU3DzfKAJ

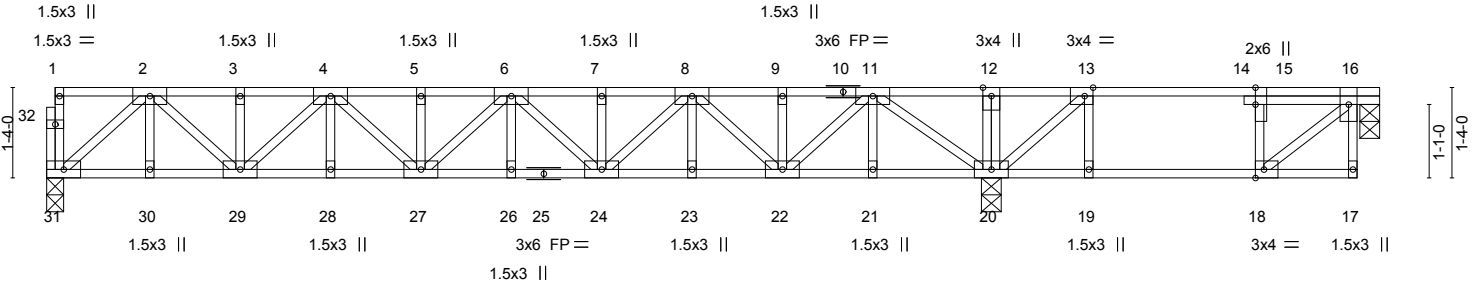

	13-11-4	15-5-4	16-7-10	17-10-0	19-4-0	19-8-0
	13-11-4	1-6-0	1-2-6	1-2-6	1-6-0	0-4-0
Plate Offsets (X,Y)--	[13:0-1-8,Edge], [15:0-3-0,0-0-0], [18:0-1-8,Edge]					

<b>LOADING</b> (psf)	<b>SPACING-</b> 2-0-0	<b>CSI.</b>	<b>DEFL.</b> in (loc) l/defl L/d	<b>PLATES</b>	<b>GRIP</b>
TCLL 40.0	Plate Grip DOL 1.00	TC 0.40	Vert(LL) -0.08 26 >999 480	MT20	244/190
TCDL 10.0	Lumber DOL 1.00	BC 0.38	Vert(CT) -0.11 26 >999 360		
BCLL 0.0	Rep Stress Incr YES	WB 0.37	Horz(CT) 0.03 20 n/a n/a		
BCDL 5.0	Code IRC2015/TPI2014	Matrix-S			
				Weight: 115 lb	FT = 20%F, 11%E

<b>LUMBER-</b>	<b>BRACING-</b>
TOP CHORD 2x4 SP No.1(flat)	TOP CHORD Structural wood sheathing directly applied or 6-0-0 oc purlins, except end verticals.
BOT CHORD 2x4 SP No.1(flat)	BOT CHORD Rigid ceiling directly applied or 10-0-0 oc bracing, Except: 6-0-0 oc bracing: 19-20,18-19.
WEBS 2x4 SP No.3(flat)	

**REACTIONS.** (size) 31=0-3-0, 16=0-3-8, 20=0-3-8  
Max Grav 31=730(LC 8), 16=275(LC 4), 20=1157(LC 7)

**FORCES.** (lb) - Max. Comp./Max. Ten. - All forces 250 (lb) or less except when shown.  
TOP CHORD 2-3=-1331/0, 3-4=-1331/0, 4-5=-1969/0, 5-6=-1969/0, 6-7=-1961/0, 7-8=-1961/0, 8-9=-1306/0, 9-11=-1306/0, 11-12=0/365, 12-13=0/364, 13-15=-276/99, 15-16=-253/96  
BOT CHORD 30-31=0/775, 29-30=0/775, 28-29=0/1732, 27-28=0/1732, 26-27=0/2047, 24-26=0/2047, 23-24=0/1717, 22-23=0/1717, 21-22=0/750, 20-21=0/750, 19-20=-96/253, 18-19=-96/253  
WEBS 16-18=-125/330, 2-31=-1021/0, 2-29=0/751, 4-29=-541/0, 4-27=0/319, 8-24=0/345, 8-22=-569/0, 11-22=0/769, 11-20=-1229/0, 13-20=-575/0

- NOTES-**
- 1) Unbalanced floor live loads have been considered for this design.
  - 2) All plates are 3x6 MT20 unless otherwise indicated.
  - 3) Plates checked for a plus or minus 1 degree rotation about its center.
  - 4) Recommend 2x6 strongbacks, on edge, spaced at 10-0-0 oc and fastened to each truss with 3-10d (0.131" X 3") nails. Strongbacks to be attached to walls at their outer ends or restrained by other means.
  - 5) Gap between inside of top chord bearing and first diagonal or vertical web shall not exceed 0.500in.
  - 6) CAUTION, Do not erect truss backwards.

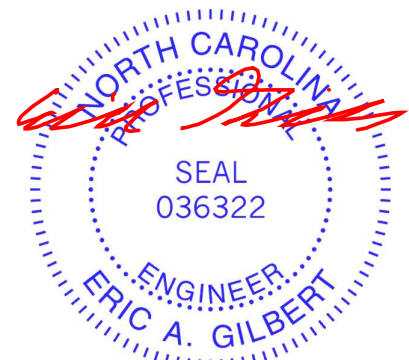

March 1, 2023

<p><b>WARNING - Verify design parameters and READ NOTES ON THIS AND INCLUDED MITEK REFERENCE PAGE MII-7473 rev. 1/2/2023 BEFORE USE.</b></p> <p>Design valid for use only with MiTek® connectors. This design is based only upon parameters shown, and is for an individual building component, not a truss system. Before use, the building designer must verify the applicability of design parameters and properly incorporate this design into the overall building design. Bracing indicated is to prevent buckling of individual truss web and/or chord members only. Additional temporary and permanent bracing is always required for stability and to prevent collapse with possible personal injury and property damage. For general guidance regarding the fabrication, storage, delivery, erection and bracing of trusses and truss systems, see <b>ANSI/TPI1 Quality Criteria and DSB-22</b> available from Truss Plate Institute (www.tpinst.org) and <b>BCSI Building Component Safety Information</b> available from the Structural Building Component Association (www.sbcacomponents.com)</p>	<p>ENGINEERING BY <b>TRENCO</b> A MiTek Affiliate</p> <p>818 Soundside Road Edenton, NC 27932</p>
---	---

Job J0523-2577	Truss F5	Truss Type FLOOR	Qty 1	Ply 1	Lot 56 Liberty Meadow I56917907
-------------------	-------------	---------------------	----------	----------	------------------------------------

Comtech, Inc. Fayetteville, NC - 28314,

8.430 s Jan 6 2022 MiTek Industries, Inc. Wed Mar 1 09:54:57 2023 Page 1

ID:aTXuLo?nW09qtpROz2WQ0wydkZW-4MLWHnRi8c1EXhIVY5TmeDJun5GPPb0JOGG2bgzfKAI

0-1-8

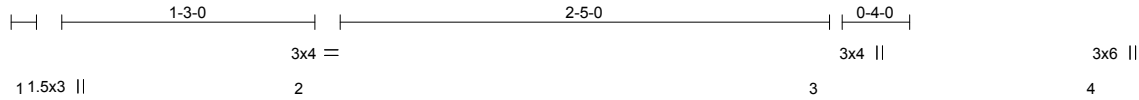

Scale = 1:11.4

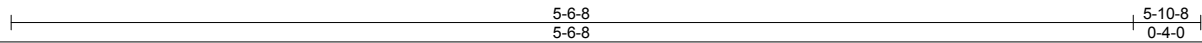
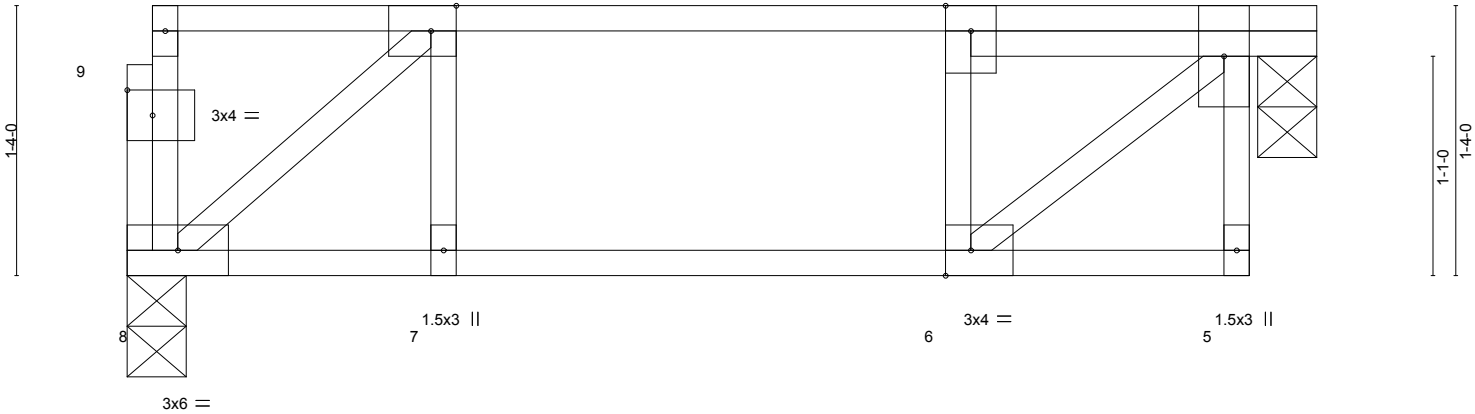

Plate Offsets (X,Y)--	[2:0-1-8,Edge], [6:0-1-8,Edge], [9:0-1-8,0-1-8]				
<b>LOADING</b> (psf)	<b>SPACING-</b> 2-0-0	<b>CSI.</b>	<b>DEFL.</b> in (loc) l/defl L/d	<b>PLATES</b>	<b>GRIP</b>
TCLL 40.0	Plate Grip DOL 1.00	TC 0.23	Vert(LL) -0.01 6 >999 480	MT20	244/190
TCDL 10.0	Lumber DOL 1.00	BC 0.11	Vert(CT) -0.01 6 >999 360		
BCLL 0.0	Rep Stress Incr YES	WB 0.18	Horz(CT) -0.01 4 n/a n/a		
BCDL 5.0	Code IRC2015/TPI2014	Matrix-S		Weight: 32 lb	FT = 20%F, 11%E

<b>LUMBER-</b>	<b>BRACING-</b>
TOP CHORD 2x4 SP No.1(flat)	TOP CHORD Structural wood sheathing directly applied or 5-10-8 oc purlins, except end verticals.
BOT CHORD 2x4 SP No.1(flat)	BOT CHORD Rigid ceiling directly applied or 10-0-0 oc bracing.
WEBS 2x4 SP No.3(flat)	

**REACTIONS.** (size) 8=0-3-8, 4=0-3-8  
Max Grav 8=288(LC 1), 4=294(LC 1)

**FORCES.** (lb) - Max. Comp./Max. Ten. - All forces 250 (lb) or less except when shown.  
TOP CHORD 2-3=-294/0, 3-4=-296/0  
BOT CHORD 7-8=0/294, 6-7=0/294  
WEBS 2-8=-382/0, 4-6=0/383

- NOTES-**
- 1) Unbalanced floor live loads have been considered for this design.
  - 2) Plates checked for a plus or minus 1 degree rotation about its center.
  - 3) Recommend 2x6 strongbacks, on edge, spaced at 10-0-0 oc and fastened to each truss with 3-10d (0.131" X 3") nails. Strongbacks to be attached to walls at their outer ends or restrained by other means.
  - 4) Gap between inside of top chord bearing and first diagonal or vertical web shall not exceed 0.500in.
  - 5) CAUTION, Do not erect truss backwards.



March 1, 2023

<p><b>WARNING - Verify design parameters and READ NOTES ON THIS AND INCLUDED MITEK REFERENCE PAGE MII-7473 rev. 1/2/2023 BEFORE USE.</b></p> <p>Design valid for use only with MiTek® connectors. This design is based only upon parameters shown, and is for an individual building component, not a truss system. Before use, the building designer must verify the applicability of design parameters and properly incorporate this design into the overall building design. Bracing indicated is to prevent buckling of individual truss web and/or chord members only. Additional temporary and permanent bracing is always required for stability and to prevent collapse with possible personal injury and property damage. For general guidance regarding the fabrication, storage, delivery, erection and bracing of trusses and truss systems, see <b>ANSI/TP1 Quality Criteria and DSB-22</b> available from Truss Plate Institute (www.tpinst.org) and <b>BCSI Building Component Safety Information</b> available from the Structural Building Component Association (www.sbcacomponents.com)</p>	<p>ENGINEERING BY</p>  <p>A MiTek Affiliate</p> <p>818 Soundside Road Edenton, NC 27932</p>
--	--



Job J0523-2577	Truss FG1	Truss Type FLOOR	Qty 1	Ply 1	Lot 56 Liberty Meadow Job Reference (optional)	I56917908
-------------------	--------------	---------------------	----------	----------	---	-----------

Comtech, Inc. Fayetteville, NC - 28314,

8.430 s Jan 6 2022 MiTek Industries, Inc. Wed Mar 1 09:54:58 2023 Page 1

ID:aTXuLo?nW09qtpROz2WQ0wydkZW-ZYvU7RKv959qKi6o\_?BQs5FVbp82BTdw?b76zfkAh

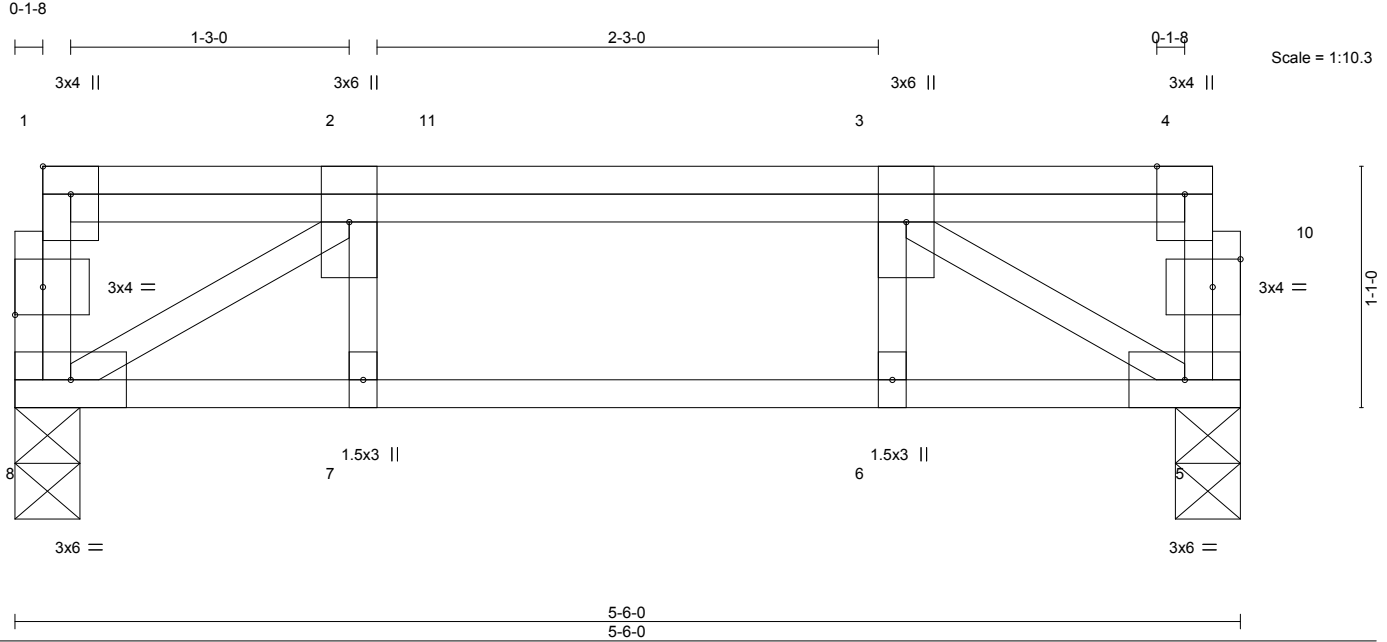

Plate Offsets (X,Y)-- [1:Edge,0-1-8], [9:0-1-8,0-1-8], [10:0-1-8,0-1-8]

LOADING (psf)	SPACING-	2-0-0	CSI.	DEFL.	in (loc)	l/defl	L/d	PLATES	GRIP	
TCLL 40.0	Plate Grip DOL	1.00	TC 0.12	Vert(LL)	-0.01	6	>999	480	MT20	244/190
TCDL 10.0	Lumber DOL	1.00	BC 0.17	Vert(CT)	-0.01	6-7	>999	360		
BCLL 0.0	Rep Stress Incr	NO	WB 0.19	Horz(CT)	0.01	5	n/a	n/a		
BCDL 5.0	Code IRC2015/TP12014		Matrix-S							
									Weight: 34 lb	FT = 20%F, 11%E

LUMBER-	BRACING-
TOP CHORD 2x4 SP No.1(flat)	TOP CHORD Structural wood sheathing directly applied or 5-6-0 oc purlins, except end verticals.
BOT CHORD 2x4 SP No.1(flat)	BOT CHORD Rigid ceiling directly applied or 10-0-0 oc bracing.
WEBS 2x4 SP No.3(flat)	

**REACTIONS.** (size) 8=0-3-8, 5=0-3-8  
Max Grav 8=455(LC 1), 5=476(LC 1)

**FORCES.** (lb) - Max. Comp./Max. Ten. - All forces 250 (lb) or less except when shown.  
TOP CHORD 2-3=-683/0  
BOT CHORD 7-8=0/683, 6-7=0/683, 5-6=0/683  
WEBS 2-8=-802/0, 3-5=-801/0

**NOTES-**  
1) Unbalanced floor live loads have been considered for this design.  
2) Plates checked for a plus or minus 1 degree rotation about its center.  
3) Recommend 2x6 strongbacks, on edge, spaced at 10-0-0 oc and fastened to each truss with 3-10d (0.131" X 3") nails. Strongbacks to be attached to walls at their outer ends or restrained by other means.

**LOAD CASE(S)** Standard  
1) Dead + Floor Live (balanced): Lumber Increase=1.00, Plate Increase=1.00  
Uniform Loads (plf)  
Vert: 5-8=-10, 1-4=-100  
Concentrated Loads (lb)  
Vert: 3=-172 11=-194

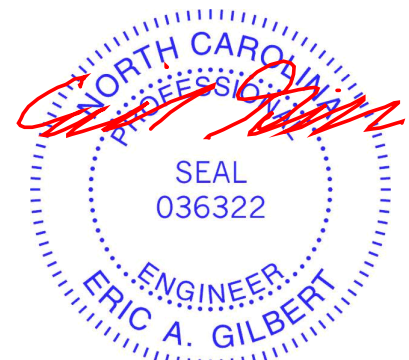

March 1, 2023

# Symbols

## PLATE LOCATION AND ORIENTATION

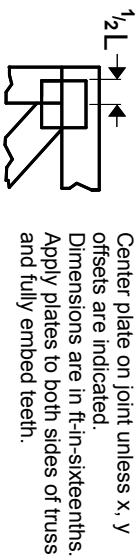

Center plate on joint unless x, y offsets are indicated. Dimensions are in ft-in-sixteenths. Apply plates to both sides of truss and fully embed teeth.

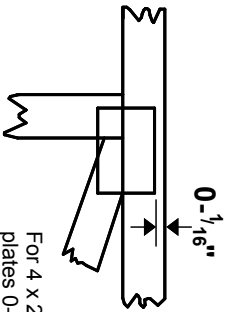

For 4 x 2 orientation, locate plates 0-  $\frac{1}{16}$ \" from outside edge of truss.

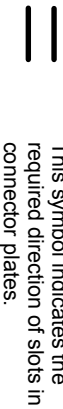

This symbol indicates the required direction of slots in connector plates.

\* Plate location details available in MITek software or upon request.

## PLATE SIZE

4 X 4

The first dimension is the plate width measured perpendicular to slots. Second dimension is the length parallel to slots.

## LATERAL BRACING LOCATION



Indicated by symbol shown and/or by text in the bracing section of the output. Use T or I bracing if indicated.

## BEARING



Indicates location where bearings (supports) occur. Icons vary but reaction section indicates joint number/letter where bearings occur. Min size shown is for crushing only.

## Industry Standards:

ANSI/TFP 1: National Design Specification for Metal Plate Connected Wood Truss Construction.  
DSB-22: Design Standard for Bracing.  
BCSI: Building Component Safety Information, Guide to Good Practice for Handling, Installing, Restraining & Bracing of Metal Plate Connected Wood Trusses.

# Numbering System



1 Joint ID

2 TOP CHORDS

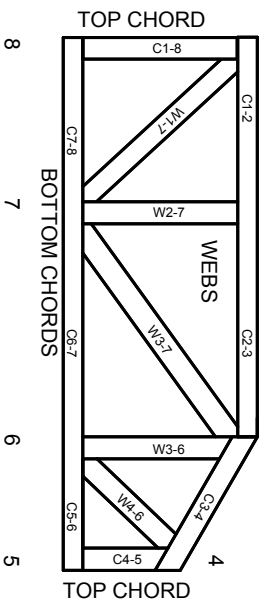

JOINTS ARE GENERALLY NUMBERED/LETTERED CLOCKWISE AROUND THE TRUSS STARTING AT THE JOINT FARTHEST TO THE LEFT.

CHORDS AND WEBS ARE IDENTIFIED BY END JOINT NUMBERS/LETTERS.

# Product Code Approvals

ICC-ES Reports:

ESR-1988, ESR-2362, ESR-2685, ESR-3282  
ESR-4722, ESL-1388

# Design General Notes

Trusses are designed for wind loads in the plane of the truss unless otherwise shown.

Lumber design values are in accordance with ANSI/TFP 1 section 6.3. These truss designs rely on Lumber values established by others.

© 2023 MITek® All Rights Reserved

# General Safety Notes

## Failure to Follow Could Cause Property Damage or Personal Injury

1. Additional stability bracing for truss system, e.g. diagonal or X-bracing, is always required. See BCSI.
2. Truss bracing must be designed by an engineer. For wide truss spacing, individual lateral braces themselves may require bracing, or alternative Tor I bracing should be considered.
3. Never exceed the design loading shown and never stack materials on inadequately braced trusses.
4. Provide copies of this truss design to the building designer, erection supervisor, property owner and all other interested parties.
5. Cut members to bear tightly against each other.
6. Place plates on each face of truss at each joint and embed fully. Knots and wane at joint locations are regulated by ANSI/TFP 1.
7. Design assumes trusses will be suitably protected from the environment in accord with ANSI/TFP 1.
8. Unless otherwise noted, moisture content of lumber shall not exceed 19% at time of fabrication.
9. Unless expressly noted, this design is not applicable for use with fire retardant, preservative treated, or green lumber.
10. Camber is a non-structural consideration and is the responsibility of truss fabricator. General practice is to camber for dead load deflection.
11. Plate type, size, orientation and location dimensions indicated are minimum plating requirements.
12. Lumber used shall be of the species and size, and in all respects, equal to or better than that specified.
13. Top chords must be sheathed or purlins provided at spacing indicated on design.
14. Bottom chords require lateral bracing at 10 ft. spacing, or less, if no ceiling is installed, unless otherwise noted.
15. Connections not shown are the responsibility of others.
16. Do not cut or alter truss member or plate without prior approval of an engineer.
17. Install and load vertically unless indicated otherwise.
18. Use of green or treated lumber may pose unacceptable environmental, health or performance risks. Consult with project engineer before use.
19. Review all portions of this design (front, back, words and pictures) before use. Reviewing pictures alone is not sufficient.
20. Design assumes manufacture in accordance with ANSI/TFP 1 Quality Criteria.
21. The design does not take into account any dynamic or other loads other than those expressly stated.

**MITek**

ENGINEERING BY  
**TRENGO**  
A MITek Affiliate

MITek Engineering Reference Sheet: MI-7473 rev. 1/2/2023