

Trenco  
818 Soundside Rd  
Edenton, NC 27932

Re: Master-120  
DR Horton; Cali; 120; Master.RT

The truss drawing(s) referenced below have been prepared by Truss Engineering Co. under my direct supervision based on the parameters provided by Builders FirstSource-Apex,NC.

Pages or sheets covered by this seal: I58747594 thru I58747631

My license renewal date for the state of North Carolina is December 31, 2023.

North Carolina COA: C-0844



June 6,2023

---

Gilbert, Eric

**IMPORTANT NOTE:** The seal on these truss component designs is a certification that the engineer named is licensed in the jurisdiction(s) identified and that the designs comply with ANSI/TPI 1. These designs are based upon parameters shown (e.g., loads, supports, dimensions, shapes and design codes), which were given to MiTek or TRENCO. Any project specific information included is for MiTek's or TRENCO's customers file reference purpose only, and was not taken into account in the preparation of these designs. MiTek or TRENCO has not independently verified the applicability of the design parameters or the designs for any particular building. Before use, the building designer should verify applicability of design parameters and properly incorporate these designs into the overall building design per ANSI/TPI 1, Chapter 2.

Job	Truss	Truss Type	Qty	Ply	DR Horton; Cali; 120; Master.RT	158747594
MASTER-120	A01	SPECIAL	1	1		

Builders FirstSource (Apex, NC), Apex, NC - 27523, 8.430 s Jan 6 2022 MiTek Industries, Inc. Mon Jun 5 15:53:14 2023 Page 1  
 ID:GkdJTsrewC8FsrdZ9sGJOzzyZcn-RfC?PsB70Hq3NSgPqnL8w3ulTXbGKWrCDoi7J4zJC?f

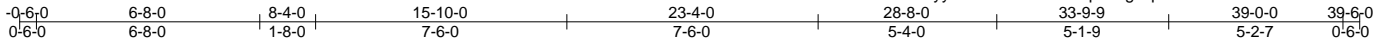

Scale = 1:68.8

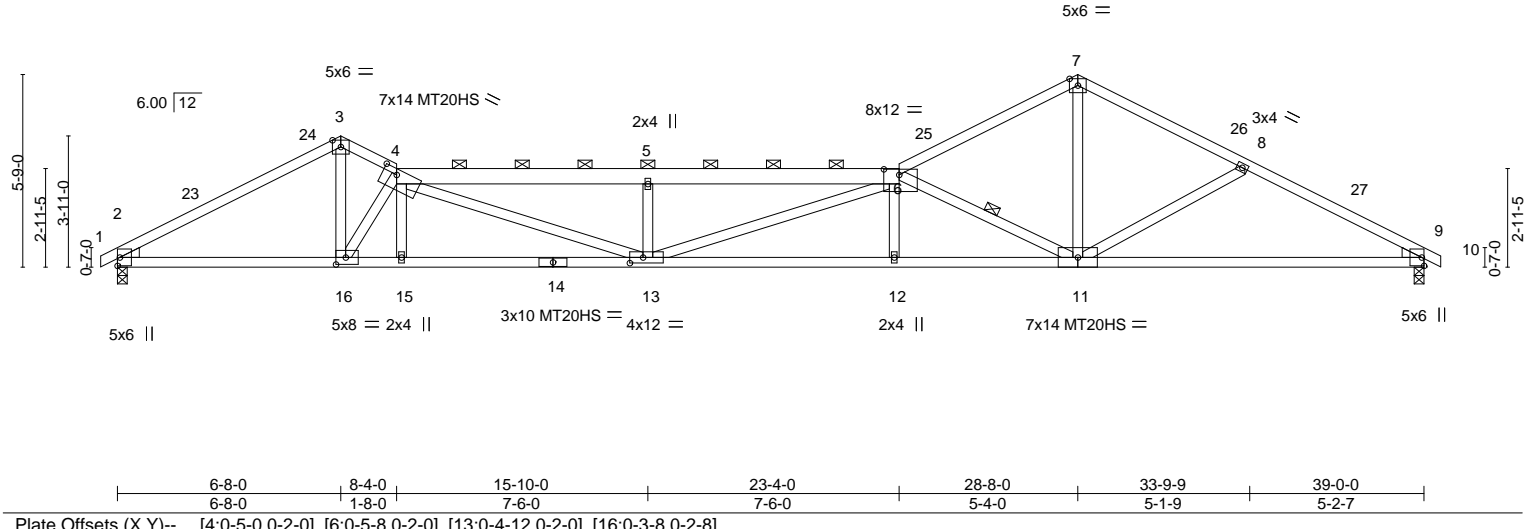

Plate Offsets (X, Y)--	[4:0-5-0,0-2-0], [6:0-5-8,0-2-0], [13:0-4-12,0-2-0], [16:0-3-8,0-2-8]				
<b>LOADING</b> (psf)	<b>SPACING-</b> 2-0-0	<b>CSI.</b>	<b>DEFL.</b> in (loc) l/defl L/d	<b>PLATES</b>	<b>GRIP</b>
TCLL 20.0	Plate Grip DOL 1.15	TC 0.80	Vert(LL) -0.52 12-13 >906 360	MT20	244/190
TCDL 10.0	Lumber DOL 1.15	BC 0.74	Vert(CT) -1.07 12-13 >439 240	MT20HS	187/143
BCLL 0.0 *	Rep Stress Incr YES	WB 0.95	Horz(CT) 0.18 9 n/a n/a		
BCDL 10.0	Code IRC2015/TPI2014	Matrix-MS	Wind(LL) 0.33 12-13 >999 240		Weight: 203 lb FT = 20%

<b>LUMBER-</b>	<b>BRACING-</b>
TOP CHORD 2x4 SP No.2 *Except* 4-6: 2x6 SP No.2	TOP CHORD Structural wood sheathing directly applied or 2-7-11 oc purlins, except
BOT CHORD 2x4 SP No.1 *Except* 11-14: 2x4 SP SS	2-0-0 oc purlins (2-2-1 max.): 4-6.
WEBS 2x4 SP No.3	BOT CHORD Rigid ceiling directly applied or 10-0-0 oc bracing.
WEDGE Left: 2x4 SP No.3, Right: 2x4 SP No.3	WEBS 1 Row at midpt 6-11

**REACTIONS.** (size) 2=0-3-8, 9=0-3-8  
 Max Horz 2=-80(LC 17)  
 Max Uplift 2=-36(LC 12)  
 Max Grav 2=1590(LC 1), 9=1590(LC 1)

**FORCES.** (lb) - Max. Comp./Max. Ten. - All forces 250 (lb) or less except when shown.  
 TOP CHORD 2-3=-2773/244, 3-4=-2740/272, 4-5=-5826/467, 5-6=-5826/467, 6-7=-2554/229,  
 7-8=-2534/243, 8-9=-2801/266  
 BOT CHORD 2-16=-162/2394, 15-16=-257/3809, 13-15=-253/3816, 12-13=-371/5437, 11-12=-374/5431,  
 9-11=-166/2434  
 WEBS 3-16=-136/2286, 4-16=-2697/187, 4-13=-160/2131, 5-13=-708/198, 6-13=-147/548,  
 6-11=-3612/334, 7-11=-96/1910, 8-11=-320/139

- NOTES-**
- Unbalanced roof live loads have been considered for this design.
  - Wind: ASCE 7-10; Vult=120mph Vasd=95mph; TCDL=6.0psf; BCDL=6.0psf; h=32ft; Cat. II; Exp B; Enclosed; MWFRS (envelope) gable end zone and C-C Exterior(2) -0-6-0 to 2-6-0, Interior(1) 2-6-0 to 6-8-0, Exterior(2) 6-8-0 to 8-4-0, Interior(1) 8-4-0 to 28-8-0, Exterior(2) 28-8-0 to 32-10-15, Interior(1) 32-10-15 to 39-6-0 zone; cantilever left and right exposed; end vertical left and right exposed; C-C for members and forces & MWFRS for reactions shown; Lumber DOL=1.60 plate grip DOL=1.60
  - Provide adequate drainage to prevent water ponding.
  - All plates are MT20 plates unless otherwise indicated.
  - This truss has been designed for a 10.0 psf bottom chord live load nonconcurrent with any other live loads.
  - \* This truss has been designed for a live load of 20.0psf on the bottom chord in all areas where a rectangle 3-6-0 tall by 2-0-0 wide will fit between the bottom chord and any other members.
  - Provide mechanical connection (by others) of truss to bearing plate capable of withstanding 36 lb uplift at joint 2.
  - Graphical purlin representation does not depict the size or the orientation of the purlin along the top and/or bottom chord.



Job	Truss	Truss Type	Qty	Ply	DR Horton; Cali; 120; Master.RT	158747595
MASTER-120	A02	SPECIAL	1	1		

Builders FirstSource (Apex, NC), Apex, NC - 27523, 8.430 s Jan 6 2022 MiTek Industries, Inc. Mon Jun 5 15:53:16 2023 Page 1

ID:GkdJTswrc8FsrDZ9sGJOzzyZcn-RfC?PsB70Hq3NSgPqnL8w3ulTXbGKWrCDoi7J4zJC?f

-0-6-0	7-0-0	16-2-0	25-4-0	28-8-0	33-7-9	39-0-0	39-6-0
0-6-0	7-0-0	9-2-0	9-2-0	3-4-0	4-11-9	5-4-7	0-6-0

Scale = 1:68.8

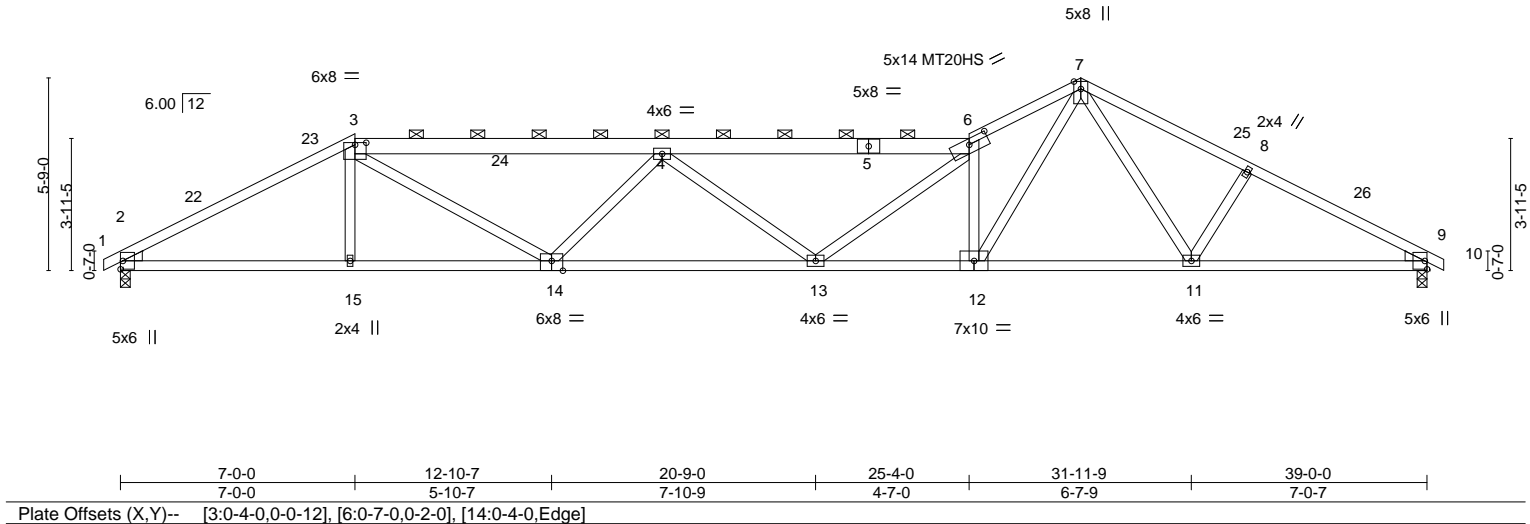

LOADING (psf)	SPACING-	CSI.	DEFL.	PLATES	GRIP
TCLL 20.0	Plate Grip DOL 1.15	TC 0.78	Vert(LL) -0.33 13 >999 360	MT20	244/190
TCDL 10.0	Lumber DOL 1.15	BC 0.98	Vert(CT) -0.70 13-14 >671 240	MT20HS	187/143
BCLL 0.0 *	Rep Stress Incr YES	WB 0.80	Horz(CT) 0.17 9 n/a n/a		
BCDL 10.0	Code IRC2015/TPI2014	Matrix-MS	Wind(LL) 0.22 13 >999 240		
				Weight: 206 lb	FT = 20%

**LUMBER-**  
TOP CHORD 2x4 SP No.2 \*Except\*  
3-5,5-6: 2x6 SP DSS  
BOT CHORD 2x4 SP No.2 \*Except\*  
12-14: 2x4 SP No.1  
WEBS 2x4 SP No.3 \*Except\*  
7-12: 2x4 SP No.2  
WEDGE  
Left: 2x4 SP No.3, Right: 2x4 SP No.3

**BRACING-**  
TOP CHORD Structural wood sheathing directly applied or 2-2-0 oc purlins, except 2-0-0 oc purlins (3-4-14 max.): 3-6.  
BOT CHORD Rigid ceiling directly applied or 10-0-0 oc bracing, Except: 2-2-0 oc bracing: 9-11.

**REACTIONS.** (size) 2=0-3-8, 9=0-3-8  
Max Horz 2=-80(LC 17)  
Max Uplift 2=-36(LC 12)  
Max Grav 2=1590(LC 1), 9=1590(LC 1)

**FORCES.** (lb) - Max. Comp./Max. Ten. - All forces 250 (lb) or less except when shown.  
TOP CHORD 2-3=-2818/252, 3-4=-3701/306, 4-6=-4099/325, 6-7=-4183/404, 7-8=-2685/262, 8-9=-2825/244  
BOT CHORD 2-15=-166/2442, 14-15=-169/2439, 13-14=-314/4284, 12-13=-228/3766, 11-12=-95/2177, 9-11=-163/2451  
WEBS 3-14=-107/1486, 4-14=-867/192, 6-12=-2438/280, 7-12=-254/2953, 7-11=-45/385, 4-13=-313/173, 6-13=-41/506

- NOTES-**
- Unbalanced roof live loads have been considered for this design.
  - Wind: ASCE 7-10; Vult=120mph Vasd=95mph; TCDL=6.0psf; BCDL=6.0psf; h=32ft; Cat. II; Exp B; Enclosed; MWFRS (envelope) gable end zone and C-C Exterior(2) -0-6-0 to 2-6-0, Interior(1) 2-6-0 to 7-0-0, Exterior(2) 7-0-0 to 11-2-15, Interior(1) 11-2-15 to 28-8-0, Exterior(2) 28-8-0 to 32-10-15, Interior(1) 32-10-15 to 39-6-0 zone; cantilever left and right exposed; end vertical left and right exposed; C-C for members and forces & MWFRS for reactions shown; Lumber DOL=1.60 plate grip DOL=1.60
  - Provide adequate drainage to prevent water ponding.
  - All plates are MT20 plates unless otherwise indicated.
  - This truss has been designed for a 10.0 psf bottom chord live load nonconcurrent with any other live loads.
  - \* This truss has been designed for a live load of 20.0psf on the bottom chord in all areas where a rectangle 3-6-0 tall by 2-0-0 wide will fit between the bottom chord and any other members.
  - Provide mechanical connection (by others) of truss to bearing plate capable of withstanding 36 lb uplift at joint 2.
  - Graphical purlin representation does not depict the size or the orientation of the purlin along the top and/or bottom chord.

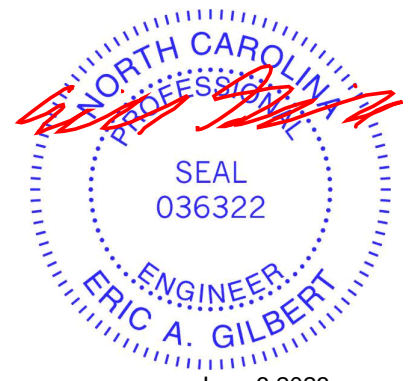

Job	Truss	Truss Type	Qty	Ply	DR Horton; Cali; 120; Master.RT	158747596
MASTER-120	A03	SPECIAL	1	1		

Builders FirstSource (Apex, NC), Apex, NC - 27523,

8.430 s Jan 6 2022 MiTek Industries, Inc. Mon Jun 5 15:53:18 2023 Page 1

ID:GkdJTsrwC8FsrDZ9sGJOzzyZcn-RfC?PsB70Hq3NSgPqnL8w3ulTXbGKWrCDoi7J4zJC?f

-0-6-0	4-8-7	9-0-0	18-2-0	27-4-0	28-8-0	33-7-9	39-0-0	39-6-0
0-6-0	4-8-7	4-3-9	9-2-0	9-2-0	1-4-0	4-11-9	5-4-7	0-6-0

Scale = 1:68.8

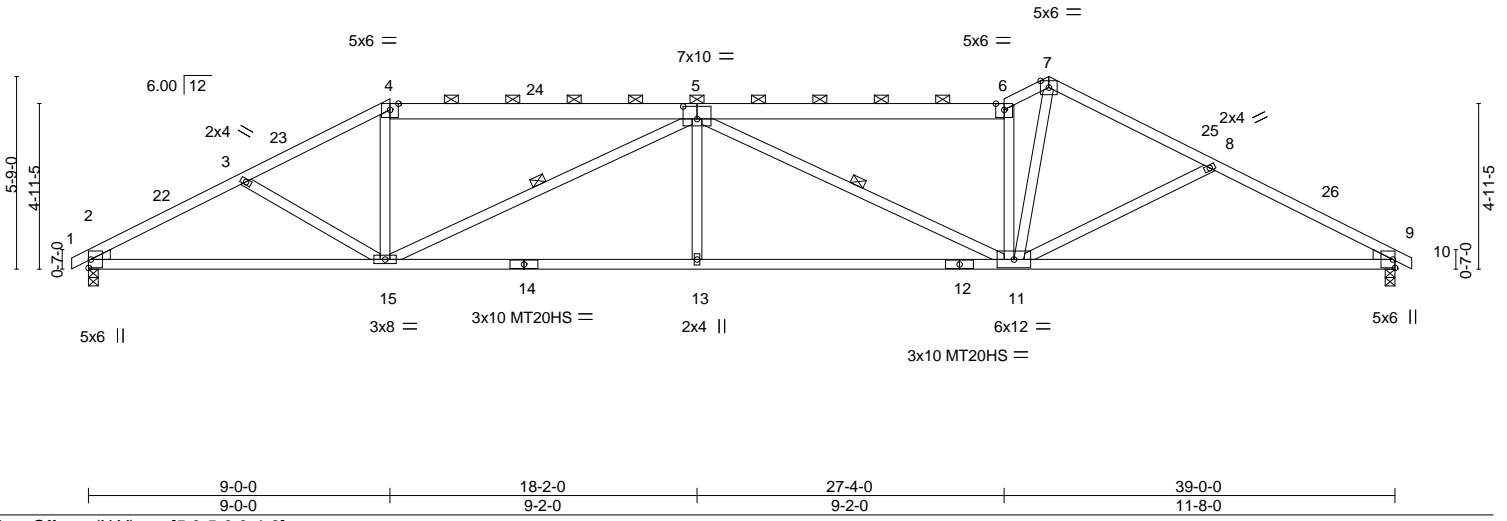

Plate Offsets (X,Y)--	[5:0-5-0,0-4-8]				
<b>LOADING</b> (psf)	<b>SPACING-</b> 2-0-0	<b>CSI.</b>	<b>DEFL.</b> in (loc) l/defl L/d	<b>PLATES</b>	<b>GRIP</b>
TCLL 20.0	Plate Grip DOL 1.15	TC 0.67	Vert(LL) -0.27 11-13 >999 360	MT20	244/190
TCDL 10.0	Lumber DOL 1.15	BC 0.87	Vert(CT) -0.57 11-13 >819 240	MT20HS	187/143
BCLL 0.0 *	Rep Stress Incr YES	WB 0.97	Horz(CT) 0.16 9 n/a n/a		
BCDL 10.0	Code IRC2015/TPI2014	Matrix-MS	Wind(LL) 0.18 11-13 >999 240	Weight: 213 lb	FT = 20%

<b>LUMBER-</b>	<b>BRACING-</b>
TOP CHORD 2x4 SP No.2 *Except* 4-5,5-6: 2x6 SP No.2	TOP CHORD Structural wood sheathing directly applied or 2-9-1 oc purlins, except 2-0-0 oc purlins (3-8-1 max.): 4-6.
BOT CHORD 2x4 SP No.1	BOT CHORD Rigid ceiling directly applied or 10-0-0 oc bracing.
WEBS 2x4 SP No.3	WEBS 1 Row at midpt 5-15, 5-11
WEDGE Left: 2x4 SP No.3 , Right: 2x4 SP No.3	

**REACTIONS.** (size) 2=0-3-8, 9=0-3-8  
 Max Horz 2=-80(LC 13)  
 Max Uplift 2=-36(LC 12), 9=-20(LC 8)  
 Max Grav 2=1590(LC 1), 9=1590(LC 1)

**FORCES.** (lb) - Max. Comp./Max. Ten. - All forces 250 (lb) or less except when shown.  
 TOP CHORD 2-3=-2815/268, 3-4=-2639/235, 4-5=-2327/242, 5-6=-2728/265, 6-7=-2995/298,  
 7-8=-2500/233, 8-9=-2794/278  
 BOT CHORD 2-15=-194/2440, 13-15=-195/3453, 11-13=-195/3453, 9-11=-185/2428  
 WEBS 4-15=0/770, 5-15=-1260/178, 5-13=0/370, 5-11=-922/118, 6-11=-1639/206,  
 7-11=-168/2346, 8-11=-336/142

- NOTES-**
- 1) Unbalanced roof live loads have been considered for this design.
  - 2) Wind: ASCE 7-10; Vult=120mph Vasd=95mph; TCDL=6.0psf; BCDL=6.0psf; h=32ft; Cat. II; Exp B; Enclosed; MWFRS (envelope) gable end zone and C-C Exterior(2) -0-6-0 to 2-6-0, Interior(1) 2-6-0 to 9-0-0, Exterior(2) 9-0-0 to 13-2-15, Interior(1) 13-2-15 to 28-8-0, Exterior(2) 28-8-0 to 32-10-15, Interior(1) 32-10-15 to 39-6-0 zone; cantilever left and right exposed ; end vertical left and right exposed;C-C for members and forces & MWFRS for reactions shown; Lumber DOL=1.60 plate grip DOL=1.60
  - 3) Provide adequate drainage to prevent water ponding.
  - 4) All plates are MT20 plates unless otherwise indicated.
  - 5) This truss has been designed for a 10.0 psf bottom chord live load nonconcurrent with any other live loads.
  - 6) \* This truss has been designed for a live load of 20.0psf on the bottom chord in all areas where a rectangle 3-6-0 tall by 2-0-0 wide will fit between the bottom chord and any other members.
  - 7) Provide mechanical connection (by others) of truss to bearing plate capable of withstanding 36 lb uplift at joint 2 and 20 lb uplift at joint 9.
  - 8) Graphical purlin representation does not depict the size or the orientation of the purlin along the top and/or bottom chord.



June 6, 2023

**WARNING - Verify design parameters and READ NOTES ON THIS AND INCLUDED MITEK REFERENCE PAGE MII-7473 rev. 5/19/2020 BEFORE USE.**  
 Design valid for use only with MiTek® connectors. This design is based only upon parameters shown, and is for an individual building component, not a truss system. Before use, the building designer must verify the applicability of design parameters and properly incorporate this design into the overall building design. Bracing indicated is to prevent buckling of individual truss web and/or chord members only. Additional temporary and permanent bracing is always required for stability and to prevent collapse with possible personal injury and property damage. For general guidance regarding the fabrication, storage, delivery, erection and bracing of trusses and truss systems, see **ANSI/TPI1 Quality Criteria, DSB-89 and BCSI Building Component Safety Information** available from Truss Plate Institute, 2670 Crain Highway, Suite 203 Waldorf, MD 20601

**ENGINEERING BY**  
**TRENCO**  
 A MiTek Affiliate

818 Soundside Road  
 Edenton, NC 27932

Job	Truss	Truss Type	Qty	Ply	DR Horton; Cali; 120; Master.RT	158747598
MASTER-120	A04	HIP	1	1		

Builders FirstSource (Apex, NC), Apex, NC - 27523, 8.430 s Jan 6 2022 MiTek Industries, Inc. Mon Jun 5 15:53:21 2023 Page 1

ID:GkdJTsrewC8FsrzdZ9sGJozyyZcn-RfC?PsB70Hq3NSgPqnL8w3uITXbGKWrCDoi7J4zJC?#

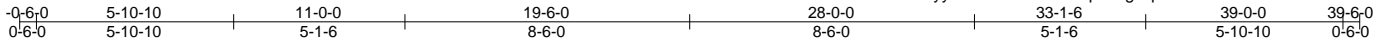

Scale = 1:68.8

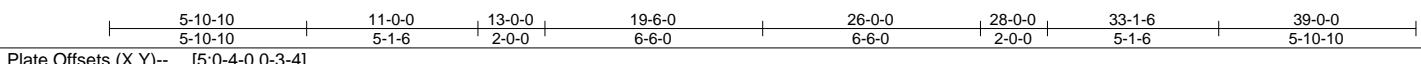
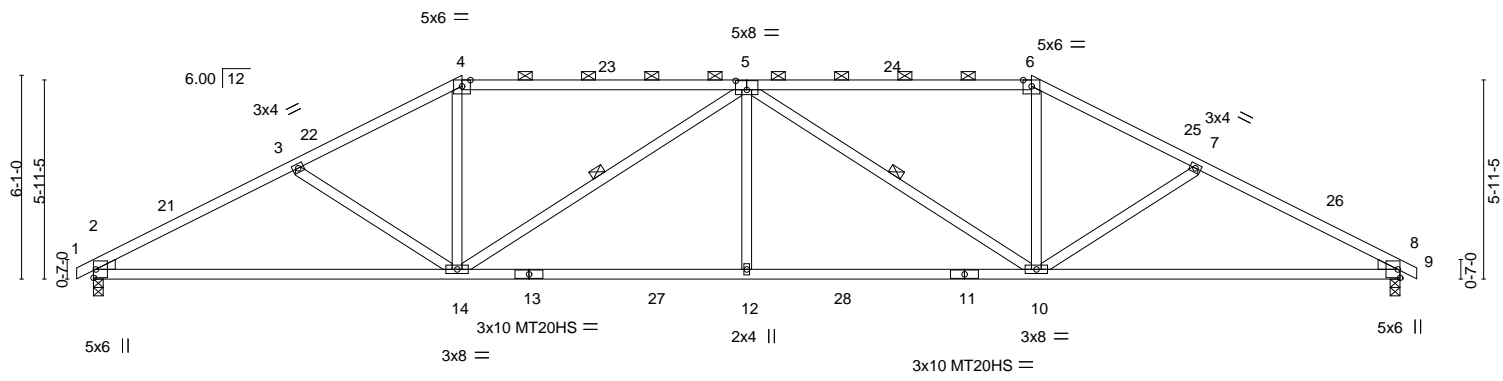

LOADING (psf)	SPACING-	2-0-0	CSI.	DEFL.	in (loc)	l/defl	L/d	PLATES	GRIP
TCLL 20.0	Plate Grip DOL	1.15	TC 0.74	Vert(LL)	-0.21	10-12	>999	MT20	244/190
TCDL 10.0	Lumber DOL	1.15	BC 0.75	Vert(CT)	-0.44	14-17	>999	MT20HS	187/143
BCLL 0.0 *	Rep Stress Incr	YES	WB 0.47	Horz(CT)	0.14	8	n/a		
BCDL 10.0	Code IRC2015/TP12014		Matrix-MS	Wind(LL)	0.14	12	>999		
								Weight: 194 lb	FT = 20%

<b>LUMBER-</b>	<b>BRACING-</b>
TOP CHORD 2x4 SP No.2 *Except* 4-5,5-6: 2x4 SP SS	TOP CHORD Structural wood sheathing directly applied or 3-0-1 oc purlins, except 2-0-0 oc purlins (3-7-7 max.): 4-6.
BOT CHORD 2x4 SP No.1	BOT CHORD Rigid ceiling directly applied or 10-0-0 oc bracing.
WEBS 2x4 SP No.3	WEBS 1 Row at midpt 5-14, 5-10
WEDGE Left: 2x4 SP No.3 , Right: 2x4 SP No.3	

**REACTIONS.** (size) 2=0-3-8, 8=0-3-8  
 Max Horz 2=82(LC 12)  
 Max Uplift 2=-118(LC 12), 8=-118(LC 13)  
 Max Grav 2=1590(LC 1), 8=1590(LC 1)

**FORCES.** (lb) - Max. Comp./Max. Ten. - All forces 250 (lb) or less except when shown.  
 TOP CHORD 2-3=-2784/275, 3-4=-2518/242, 4-5=-2194/251, 5-6=-2194/251, 6-7=-2518/242, 7-8=-2784/275  
 BOT CHORD 2-14=-212/2414, 12-14=-133/2789, 10-12=-133/2789, 8-10=-179/2414  
 WEBS 3-14=-253/146, 5-14=-850/150, 5-10=-850/150, 7-10=-253/146, 5-12=0/371, 4-14=0/713, 6-10=0/713

- NOTES-**
- 1) Unbalanced roof live loads have been considered for this design.
  - 2) Wind: ASCE 7-10; Vult=120mph Vasd=95mph; TCDL=6.0psf; BCDL=6.0psf; h=32ft; Cat. II; Exp B; Enclosed; MWFRS (envelope) gable end zone and C-C Exterior(2) -0-6-0 to 2-6-0, Interior(1) 2-6-0 to 11-0-0, Exterior(2) 11-0-0 to 15-2-15, Interior(1) 15-2-15 to 28-0-0, Exterior(2) 28-0-0 to 32-2-15, Interior(1) 32-2-15 to 39-6-0 zone; cantilever left and right exposed ; end vertical left and right exposed;C-C for members and forces & MWFRS for reactions shown; Lumber DOL=1.60 plate grip DOL=1.60
  - 3) Provide adequate drainage to prevent water ponding.
  - 4) All plates are MT20 plates unless otherwise indicated.
  - 5) This truss has been designed for a 10.0 psf bottom chord live load nonconcurrent with any other live loads.
  - 6) \* This truss has been designed for a live load of 20.0psf on the bottom chord in all areas where a rectangle 3-6-0 tall by 2-0-0 wide will fit between the bottom chord and any other members, with BCDL = 10.0psf.
  - 7) Provide mechanical connection (by others) of truss to bearing plate capable of withstanding 118 lb uplift at joint 2 and 118 lb uplift at joint 8.
  - 8) Graphical purlin representation does not depict the size or the orientation of the purlin along the top and/or bottom chord.



Job	Truss	Truss Type	Qty	Ply	DR Horton; Cali; 120; Master.RT	158747599
MASTER-120	A05	HIP	1	1		

Builders FirstSource (Apex, NC), Apex, NC - 27523, 8.430 s Jan 6 2022 MiTek Industries, Inc. Mon Jun 5 15:53:22 2023 Page 1

ID:GkdJTsrewC8FsrDZ9sGJozzyZcn-RfC?PsB70Hq3NSgPqnL8w3uITXbGKWrCDoi7J4zJC?f

-0-6-0	6-8-7	13-0-0	19-6-0	26-0-0	32-3-9	39-0-0	39-6-0
0-6-0	6-8-7	6-3-9	6-6-0	6-6-0	6-3-9	6-8-7	0-6-0

Scale = 1:67.5

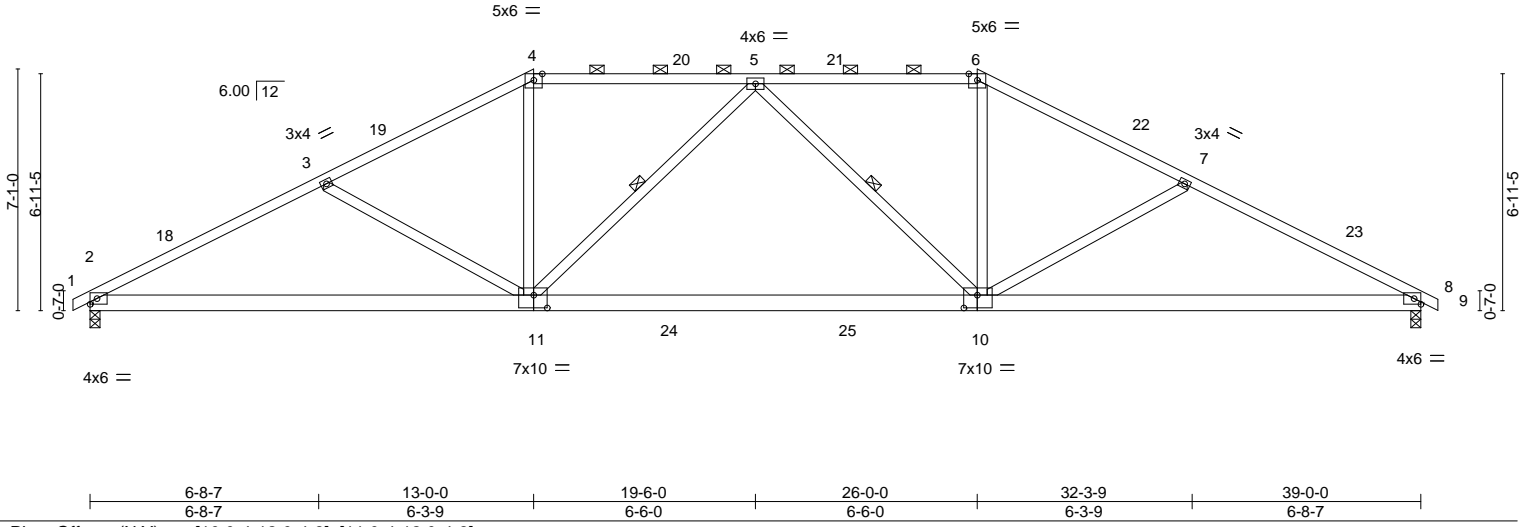

Plate Offsets (X,Y)--	[10:0-4-12,0-4-8], [11:0-4-12,0-4-8]				
<b>LOADING</b> (psf)	<b>SPACING-</b> 2-0-0	<b>CSI.</b>	<b>DEFL.</b> in (loc) l/defl L/d	<b>PLATES</b>	<b>GRIP</b>
TCLL 20.0	Plate Grip DOL 1.15	TC 0.62	Vert(LL) -0.37 10-11 >999 360	MT20	244/190
TCDL 10.0	Lumber DOL 1.15	BC 0.90	Vert(CT) -0.58 10-11 >808 240		
BCLL 0.0 *	Rep Stress Incr YES	WB 0.39	Horz(CT) 0.09 8 n/a n/a		
BCDL 10.0	Code IRC2015/TPI2014	Matrix-MS	Wind(LL) 0.11 10-11 >999 240	Weight: 221 lb	FT = 20%

<b>LUMBER-</b>	<b>BRACING-</b>
TOP CHORD 2x4 SP No.2	TOP CHORD Structural wood sheathing directly applied or 3-0-5 oc purlins, except 2-0-0 oc purlins (3-4-5 max.): 4-6.
BOT CHORD 2x6 SP No.2	BOT CHORD Rigid ceiling directly applied or 10-0-0 oc bracing.
WEBS 2x4 SP No.3	WEBS 1 Row at midpt 5-11, 5-10

**REACTIONS.** (size) 2=0-3-8, 8=0-3-8  
 Max Horz 2=96(LC 13)  
 Max Uplift 2=116(LC 12), 8=116(LC 13)  
 Max Grav 2=1590(LC 1), 8=1590(LC 1)

**FORCES.** (lb) - Max. Comp./Max. Ten. - All forces 250 (lb) or less except when shown.  
 TOP CHORD 2-3=-2818/283, 3-4=-2423/225, 4-5=-2098/239, 5-6=-2098/239, 6-7=-2423/225, 7-8=-2818/283  
 BOT CHORD 2-11=-232/2446, 10-11=-99/2329, 8-10=-184/2446  
 WEBS 3-11=-410/206, 4-11=0/714, 5-11=-459/157, 5-10=-459/157, 6-10=0/714, 7-10=-410/206

- NOTES-**
- 1) Unbalanced roof live loads have been considered for this design.
  - 2) Wind: ASCE 7-10; Vult=120mph Vasd=95mph; TCDL=6.0psf; BCDL=6.0psf; h=32ft; Cat. II; Exp B; Enclosed; MWFRS (envelope) gable end zone and C-C Exterior(2) -0-6-0 to 2-6-0, Interior(1) 2-6-0 to 13-0-0, Exterior(2) 13-0-0 to 17-2-15, Interior(1) 17-2-15 to 26-0-0, Exterior(2) 26-0-0 to 30-2-15, Interior(1) 30-2-15 to 39-6-0 zone; cantilever left and right exposed ; end vertical left and right exposed; C-C for members and forces & MWFRS for reactions shown; Lumber DOL=1.60 plate grip DOL=1.60
  - 3) Provide adequate drainage to prevent water ponding.
  - 4) This truss has been designed for a 10.0 psf bottom chord live load nonconcurrent with any other live loads.
  - 5) \* This truss has been designed for a live load of 20.0psf on the bottom chord in all areas where a rectangle 3-6-0 tall by 2-0-0 wide will fit between the bottom chord and any other members, with BCDL = 10.0psf.
  - 6) Provide mechanical connection (by others) of truss to bearing plate capable of withstanding 116 lb uplift at joint 2 and 116 lb uplift at joint 8.
  - 7) Graphical purlin representation does not depict the size or the orientation of the purlin along the top and/or bottom chord.



**WARNING - Verify design parameters and READ NOTES ON THIS AND INCLUDED MITEK REFERENCE PAGE MII-7473 rev. 5/19/2020 BEFORE USE.**  
 Design valid for use only with MiTek® connectors. This design is based only upon parameters shown, and is for an individual building component, not a truss system. Before use, the building designer must verify the applicability of design parameters and properly incorporate this design into the overall building design. Bracing indicated is to prevent buckling of individual truss web and/or chord members only. Additional temporary and permanent bracing is always required for stability and to prevent collapse with possible personal injury and property damage. For general guidance regarding the fabrication, storage, delivery, erection and bracing of trusses and truss systems, see **ANSI/TPI1 Quality Criteria, DSB-89 and BCSI Building Component Safety Information** available from Truss Plate Institute, 2670 Crain Highway, Suite 203 Waldorf, MD 20601



818 Soundside Road  
 Edenton, NC 27932

Job	Truss	Truss Type	Qty	Ply	DR Horton; Cali; 120; Master.RT	158747600
MASTER-120	A06	HIP	1	1		

Builders FirstSource (Apex, NC), Apex, NC - 27523, 8.430 s Jan 6 2022 MiTek Industries, Inc. Mon Jun 5 15:53:24 2023 Page 1

ID:GkdJTsrewC8FsrDZ9sGJOzzyZcn-RfC?PsB70Hq3NSgPqnL8w3ulTXbGKWrCDoi7J4zJC?f

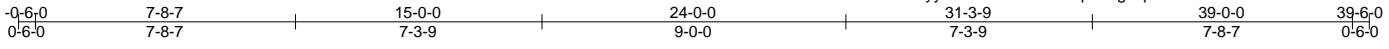

Scale = 1:68.2

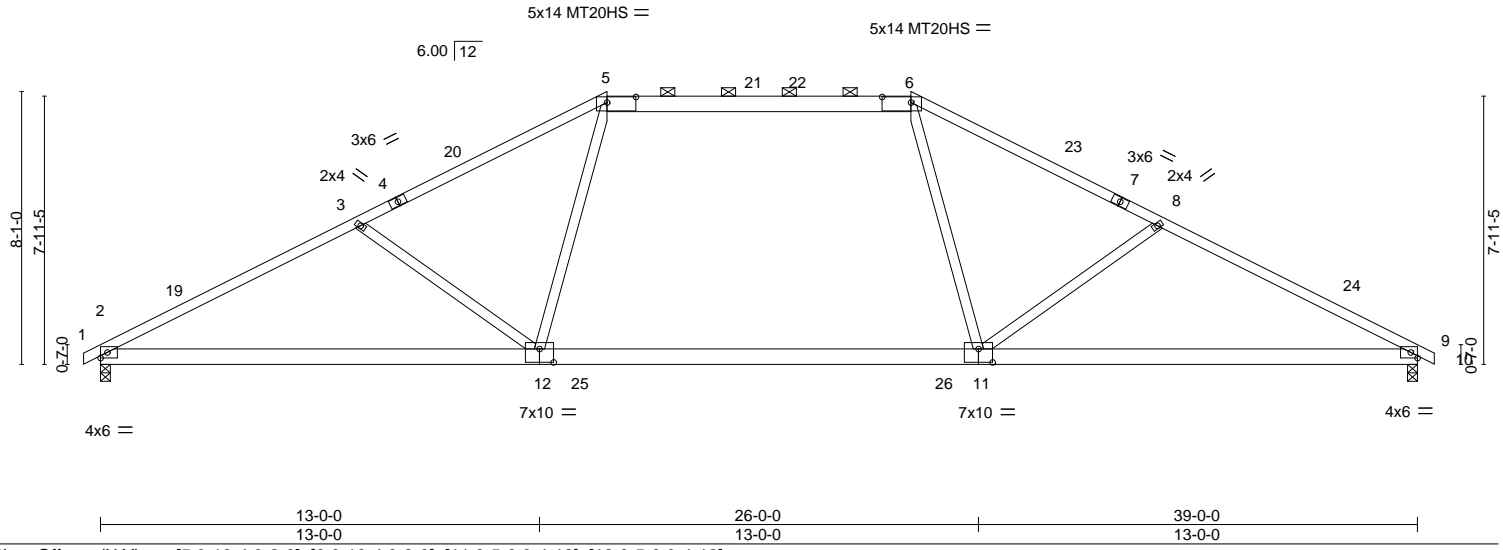

Plate Offsets (X, Y)--	[5:0-10-4,0-2-0], [6:0-10-4,0-2-0], [11:0-5-0,0-4-12], [12:0-5-0,0-4-12]
------------------------	--

LOADING (psf)	SPACING-	CSI.	DEFL.	PLATES	GRIP
TCLL 20.0	2-0-0	TC 0.83	in (loc) l/defl L/d	MT20	244/190
TCDL 10.0	Plate Grip DOL 1.15	BC 0.49	Vert(LL) -0.74 12-15 >629 360	MT20HS	187/143
BCLL 0.0 *	Lumber DOL 1.15	WB 0.43	Vert(CT) -0.88 12-15 >534 240		
BCDL 10.0	Rep Stress Incr YES	Matrix-MS	Horz(CT) 0.07 9 n/a n/a		
	Code IRC2015/TPI2014		Wind(LL) 0.45 12-15 >999 240	Weight: 206 lb	FT = 20%

LUMBER-	BRACING-
TOP CHORD 2x4 SP No.1 *Except*	TOP CHORD Structural wood sheathing directly applied, except
5-6: 2x6 SP No.2, 1-4,7-10: 2x4 SP No.2	2-0-0 oc purlins (3-10-0 max.): 5-6.
BOT CHORD 2x6 SP DSS	BOT CHORD Rigid ceiling directly applied or 10-0-0 oc bracing.
WEBS 2x4 SP No.3	

**REACTIONS.** (size) 2=0-3-8, 9=0-3-8  
 Max Horz 2=111(LC 12)  
 Max Uplift 2=108(LC 12), 9=108(LC 13)  
 Max Grav 2=1590(LC 1), 9=1590(LC 1)

**FORCES.** (lb) - Max. Comp./Max. Ten. - All forces 250 (lb) or less except when shown.  
 TOP CHORD 2-3=-2811/263, 3-5=-2490/233, 5-6=-1987/254, 6-8=-2490/233, 8-9=-2811/263  
 BOT CHORD 2-12=-192/2442, 11-12=-31/1987, 9-11=-156/2442  
 WEBS 3-12=-505/263, 5-12=0/677, 6-11=0/677, 8-11=-505/263

- NOTES-**
- 1) Unbalanced roof live loads have been considered for this design.
  - 2) Wind: ASCE 7-10; Vult=120mph Vasd=95mph; TCDL=6.0psf; BCDL=6.0psf; h=32ft; Cat. II; Exp B; Enclosed; MWFRS (envelope) gable end zone and C-C Exterior(2) -0-6-0 to 2-6-0, Interior(1) 2-6-0 to 15-0-0, Exterior(2) 15-0-0 to 19-2-15, Interior(1) 19-2-15 to 24-0-0, Exterior(2) 24-0-0 to 28-2-15, Interior(1) 28-2-15 to 39-6-0 zone; cantilever left and right exposed ; end vertical left and right exposed;C-C for members and forces & MWFRS for reactions shown; Lumber DOL=1.60 plate grip DOL=1.60
  - 3) Provide adequate drainage to prevent water ponding.
  - 4) All plates are MT20 plates unless otherwise indicated.
  - 5) This truss has been designed for a 10.0 psf bottom chord live load nonconcurrent with any other live loads.
  - 6) \* This truss has been designed for a live load of 20.0psf on the bottom chord in all areas where a rectangle 3-6-0 tall by 2-0-0 wide will fit between the bottom chord and any other members, with BCDL = 10.0psf.
  - 7) Provide mechanical connection (by others) of truss to bearing plate capable of withstanding 108 lb uplift at joint 2 and 108 lb uplift at joint 9.
  - 8) Graphical purlin representation does not depict the size or the orientation of the purlin along the top and/or bottom chord.



Job	Truss	Truss Type	Qty	Ply	DR Horton; Cali; 120; Master.RT	158747601
MASTER-120	A07	HIP	1	1		

Builders FirstSource (Apex, NC), Apex, NC - 27523, 8.430 s Jan 6 2022 MiTek Industries, Inc. Mon Jun 5 15:53:25 2023 Page 1  
 ID:GkdJTsrewC8FsrDZ9sGJOzzyZcn-RfC?PsB70Hq3NSgPqnL8w3ulTXbGKWrCDoi7J4zJC?f

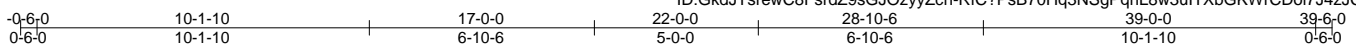

Scale = 1:70.3

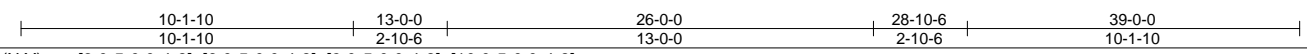
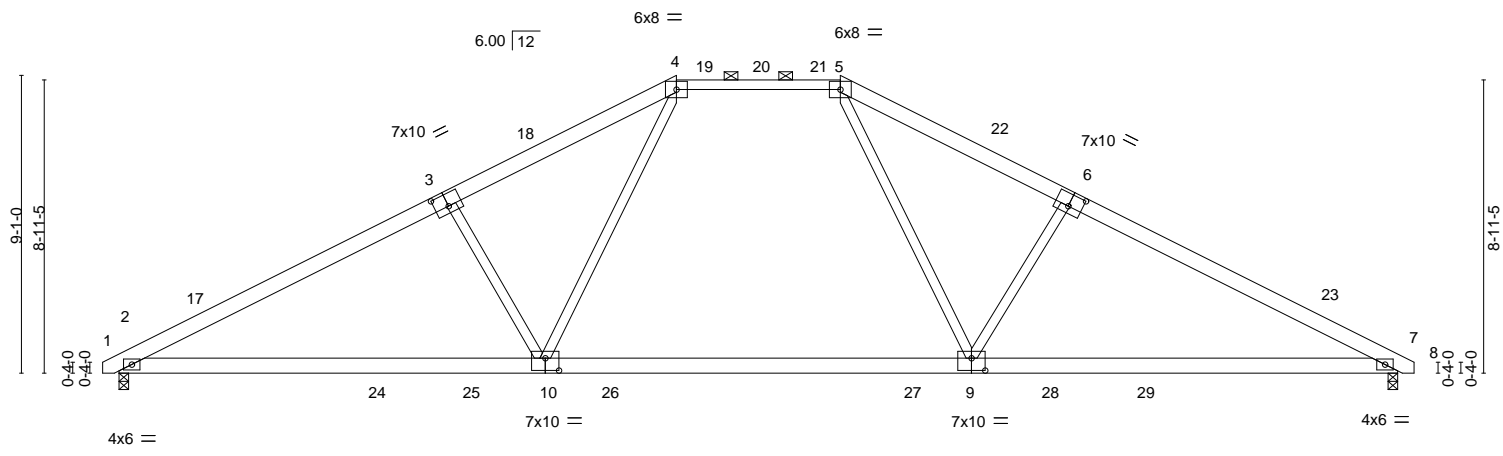

Plate Offsets (X, Y)-- [3:0-5-0,0-4-8], [6:0-5-0,0-4-8], [9:0-5-0,0-4-8], [10:0-5-0,0-4-8]

LOADING (psf)	SPACING-	CSI.	DEFL.	PLATES	GRIP
TCLL 20.0	2-0-0	TC 0.54	in (loc) l/defl L/d	MT20	244/190
TCDL 10.0	Plate Grip DOL 1.15	BC 0.43	Vert(LL) -0.39 10-13 >999 360		
BCLL 0.0 *	Lumber DOL 1.15	WB 0.40	Vert(CT) -0.54 9-16 >864 240		
BCDL 10.0	Rep Stress Incr YES	Matrix-MS	Horz(CT) 0.06 7 n/a n/a		
	Code IRC2015/TPI2014		Wind(LL) 0.25 10-13 >999 240	Weight: 234 lb	FT = 20%

LUMBER-	BRACING-
TOP CHORD 2x6 SP No.2 *Except* 4-5: 2x4 SP SS	TOP CHORD Structural wood sheathing directly applied or 3-9-1 oc purlins, except 2-0-0 oc purlins (4-9-4 max.): 4-5.
BOT CHORD 2x6 SP DSS	BOT CHORD Rigid ceiling directly applied or 10-0-0 oc bracing.
WEBS 2x4 SP No.3	

**REACTIONS.** (size) 2=0-3-8, 7=0-3-8  
 Max Horz 2=125(LC 12)  
 Max Uplift 2=107(LC 12), 7=107(LC 13)  
 Max Grav 2=1606(LC 2), 7=1606(LC 2)

**FORCES.** (lb) - Max. Comp./Max. Ten. - All forces 250 (lb) or less except when shown.  
 TOP CHORD 2-3=-2871/236, 3-4=-2633/261, 4-5=-1868/261, 5-6=-2633/261, 6-7=-2872/236  
 BOT CHORD 2-10=-178/2488, 9-10=-15/1868, 7-9=-111/2489  
 WEBS 3-10=-578/278, 4-10=-62/956, 5-9=-62/958, 6-9=-578/278

- NOTES-**
- 1) Unbalanced roof live loads have been considered for this design.
  - 2) Wind: ASCE 7-10; Vult=120mph Vasd=95mph; TCDL=6.0psf; BCDL=6.0psf; h=32ft; Cat. II; Exp B; Enclosed; MWFRS (envelope) gable end zone and C-C Exterior(2) -0-3-14 to 2-8-2, Interior(1) 2-8-2 to 17-0-0, Exterior(2) 17-0-0 to 21-2-15, Interior(1) 21-2-15 to 22-0-0, Exterior(2) 22-0-0 to 26-2-15, Interior(1) 26-2-15 to 39-3-14 zone; cantilever left and right exposed ; end vertical left and right exposed;C-C for members and forces & MWFRS for reactions shown; Lumber DOL=1.60 plate grip DOL=1.60
  - 3) Provide adequate drainage to prevent water ponding.
  - 4) This truss has been designed for a 10.0 psf bottom chord live load nonconcurrent with any other live loads.
  - 5) \* This truss has been designed for a live load of 20.0psf on the bottom chord in all areas where a rectangle 3-6-0 tall by 2-0-0 wide will fit between the bottom chord and any other members, with BCDL = 10.0psf.
  - 6) Provide mechanical connection (by others) of truss to bearing plate capable of withstanding 107 lb uplift at joint 2 and 107 lb uplift at joint 7.
  - 7) Graphical purlin representation does not depict the size or the orientation of the purlin along the top and/or bottom chord.

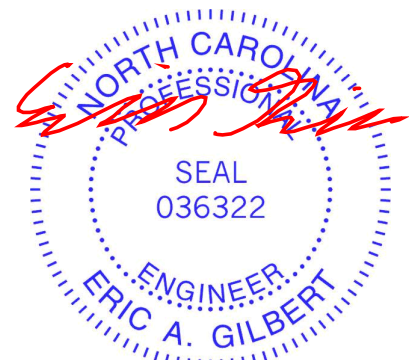

June 6, 2023



Job MASTER-120	Truss A08	Truss Type HIP	Qty 1	Ply 1	DR Horton; Cali; 120; Master.RT 158747602
-------------------	--------------	-------------------	----------	----------	--

Builders FirstSource (Apex, NC), Apex, NC - 27523, 8.430 s Jan 6 2022 MiTek Industries, Inc. Mon Jun 5 15:53:27 2023 Page 1

ID:GkdJTsrwC8FsrDZ9sGJOzzyZcn-RTc?PsB70Hq3NSgPqnL8w3ulTXbGKWRCDoi7J4zJC?f

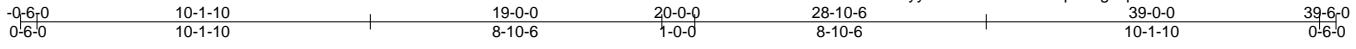

Scale = 1:70.1

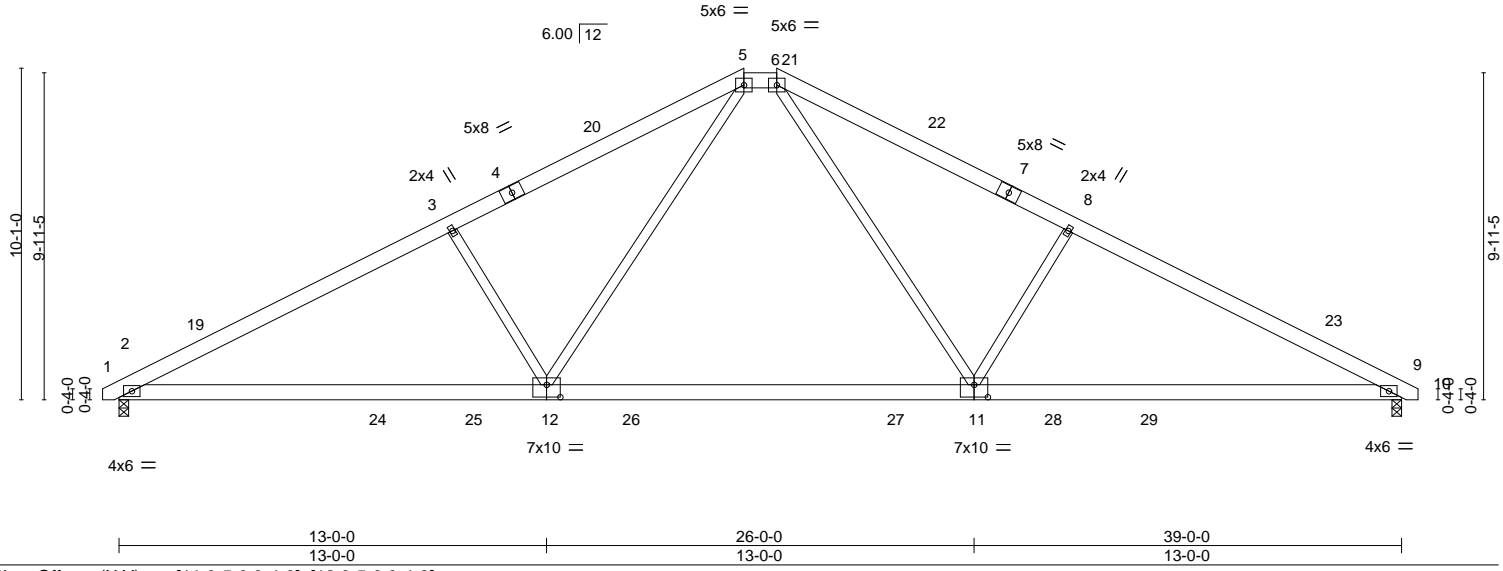

LOADING (psf)	SPACING-	2-0-0	CSI.	DEFL.	in (loc)	l/defl	L/d	PLATES	GRIP
TCLL 20.0	Plate Grip DOL	1.15	TC 0.56	Vert(LL)	-0.33 11-12	>999	360	MT20	244/190
TCDL 10.0	Lumber DOL	1.15	BC 0.96	Vert(CT)	-0.50 11-12	>945	240		
BCLL 0.0 *	Rep Stress Incr	YES	WB 0.44	Horz(CT)	0.08 9	n/a	n/a		
BCDL 10.0	Code IRC2015/TPI2014		Matrix-MS	Wind(LL)	0.12 12-15	>999	240	Weight: 245 lb	FT = 20%

LUMBER-	BRACING-
TOP CHORD 2x6 SP No.2	TOP CHORD Structural wood sheathing directly applied or 3-9-8 oc purlins, except
BOT CHORD 2x6 SP No.2	BOT CHORD 2-0-0 oc purlins (5-6-5 max.): 5-6.
WEBS 2x4 SP No.3	WEBS Rigid ceiling directly applied or 2-2-0 oc bracing.

REACTIONS.	(size)
2=0-3-8, 9=0-3-8	
Max Horz	2=139(LC 12)
Max Uplift	2=-104(LC 12), 9=-104(LC 13)
Max Grav	2=1589(LC 2), 9=1589(LC 2)

FORCES.	(lb) - Max. Comp./Max. Ten. - All forces 250 (lb) or less except when shown.
TOP CHORD	2-3=-2818/210, 3-5=-2602/245, 5-6=-1677/249, 6-8=-2602/245, 8-9=-2818/210
BOT CHORD	2-12=-204/2464, 11-12=-5/1677, 9-11=-87/2464
WEBS	3-12=-590/280, 5-12=-108/1065, 6-11=-109/1065, 8-11=-590/280

- NOTES-**
- Unbalanced roof live loads have been considered for this design.
  - Wind: ASCE 7-10; Vult=120mph Vasd=95mph; TCDL=6.0psf; BCDL=6.0psf; h=32ft; Cat. II; Exp B; Enclosed; MWFRS (envelope) gable end zone and C-C Exterior(2) -0-3-14 to 2-8-2, Interior(1) 2-8-2 to 19-0-0, Exterior(2) 19-0-0 to 24-2-15, Interior(1) 24-2-15 to 39-3-14 zone; cantilever left and right exposed; end vertical left and right exposed; C-C for members and forces & MWFRS for reactions shown; Lumber DOL=1.60 plate grip DOL=1.60
  - Provide adequate drainage to prevent water ponding.
  - This truss has been designed for a 10.0 psf bottom chord live load nonconcurrent with any other live loads.
  - \* This truss has been designed for a live load of 20.0psf on the bottom chord in all areas where a rectangle 3-6-0 tall by 2-0-0 wide will fit between the bottom chord and any other members, with BCDL = 10.0psf.
  - Provide mechanical connection (by others) of truss to bearing plate capable of withstanding 104 lb uplift at joint 2 and 104 lb uplift at joint 9.
  - Graphical purlin representation does not depict the size or the orientation of the purlin along the top and/or bottom chord.

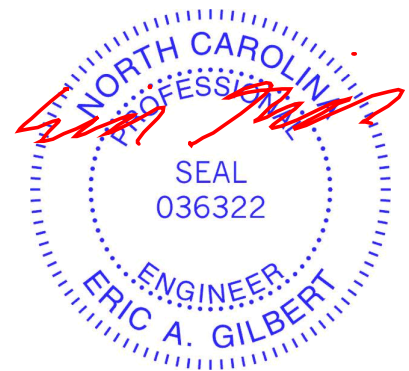

June 6, 2023

Job MASTER-120	Truss A09	Truss Type FAN	Qty 1	Ply 1	DR Horton; Cali; 120; Master.RT	158747603
-------------------	--------------	-------------------	----------	----------	---------------------------------	-----------

Builders FirstSource (Apex, NC), Apex, NC - 27523, 8.430 s Jan 6 2022 MiTek Industries, Inc. Mon Jun 5 15:53:28 2023 Page 1  
 ID:GkdJTsrewC8FsrDZ9sGJOzzyZcn-RfC?PsB70Hq3NSgPqnL8w3ulTXbGKWrCDoi7J4zJC?f

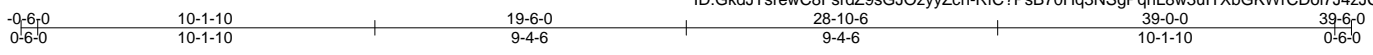

Scale = 1:69.3

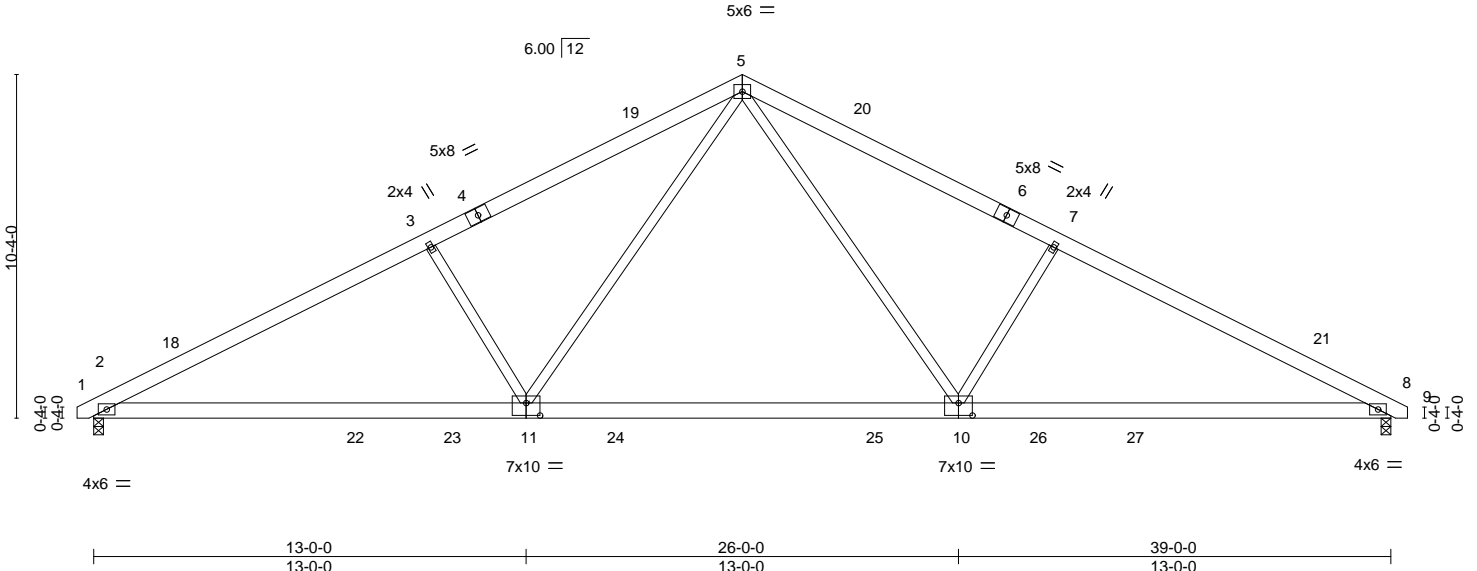

Plate Offsets (X,Y)--	[10:0-5-0,0-4-8], [11:0-5-0,0-4-8]
-----------------------	------------------------------------

LOADING (psf)	SPACING-	2-0-0	CSI.	DEFL.	in (loc)	l/defl	L/d	PLATES	GRIP
TCLL 20.0	Plate Grip DOL	1.15	TC 0.57	Vert(LL)	-0.32 10-11	>999	360	MT20	244/190
TCDL 10.0	Lumber DOL	1.15	BC 0.95	Vert(CT)	-0.49 10-11	>952	240		
BCLL 0.0 *	Rep Stress Incr	YES	WB 0.45	Horz(CT)	0.08 8	n/a	n/a		
BCDL 10.0	Code IRC2015/TPI2014		Matrix-MS	Wind(LL)	0.12 11-14	>999	240	Weight: 247 lb	FT = 20%

LUMBER-	BRACING-
TOP CHORD 2x6 SP No.2	TOP CHORD Structural wood sheathing directly applied or 3-10-0 oc purlins.
BOT CHORD 2x6 SP No.2	BOT CHORD Rigid ceiling directly applied or 2-2-0 oc bracing.
WEBS 2x4 SP No.3	

**REACTIONS.** (size) 2=0-3-8, 8=0-3-8  
 Max Horz 2=144(LC 12)  
 Max Uplift 2=-103(LC 12), 8=-103(LC 13)  
 Max Grav 2=1585(LC 2), 8=1585(LC 2)

**FORCES.** (lb) - Max. Comp./Max. Ten. - All forces 250 (lb) or less except when shown.  
 TOP CHORD 2-3=-2813/196, 3-5=-2596/229, 5-7=-2596/229, 7-8=-2813/197  
 BOT CHORD 2-11=-208/2461, 10-11=-3/1623, 8-10=-64/2461  
 WEBS 5-10=-114/1093, 7-10=-601/281, 5-11=-113/1093, 3-11=-601/281

- NOTES-**
- Unbalanced roof live loads have been considered for this design.
  - Wind: ASCE 7-10; Vult=120mph Vasd=95mph; TCDL=6.0psf; BCDL=6.0psf; h=32ft; Cat. II; Exp B; Enclosed; MWFRS (envelope) gable end zone and C-C Exterior(2) -0-3-14 to 2-8-2, Interior(1) 2-8-2 to 19-6-0, Exterior(2) 19-6-0 to 22-6-0, Interior(1) 22-6-0 to 39-3-14 zone; cantilever left and right exposed; end vertical left and right exposed; C-C for members and forces & MWFRS for reactions shown; Lumber DOL=1.60 plate grip DOL=1.60
  - This truss has been designed for a 10.0 psf bottom chord live load nonconcurrent with any other live loads.
  - \* This truss has been designed for a live load of 20.0psf on the bottom chord in all areas where a rectangle 3-6-0 tall by 2-0-0 wide will fit between the bottom chord and any other members, with BCDL = 10.0psf.
  - Provide mechanical connection (by others) of truss to bearing plate capable of withstanding 103 lb uplift at joint 2 and 103 lb uplift at joint 8.

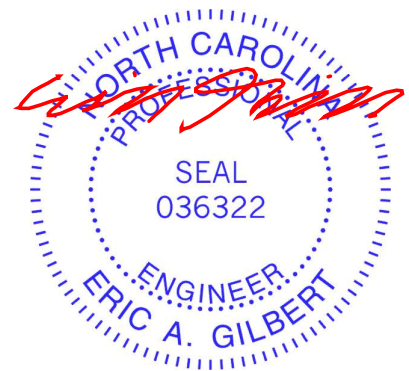

Job MASTER-120	Truss A09C	Truss Type CATHEDRAL	Qty 1	Ply 1	DR Horton; Cali; 120; Master.RT	158747604
-------------------	---------------	-------------------------	----------	----------	---------------------------------	-----------

Builders FirstSource (Apex, NC), Apex, NC - 27523,

8.430 s Jan 6 2022 MiTek Industries, Inc. Mon Jun 5 15:53:30 2023 Page 1

ID:GkdJTsrewC8FsrDZ9sGJOzzyZcn-RfC?PsB70Hq3NSgPqnL8w3uITXbGKWrCdoi7J4zJC?f



Scale = 1:70.5

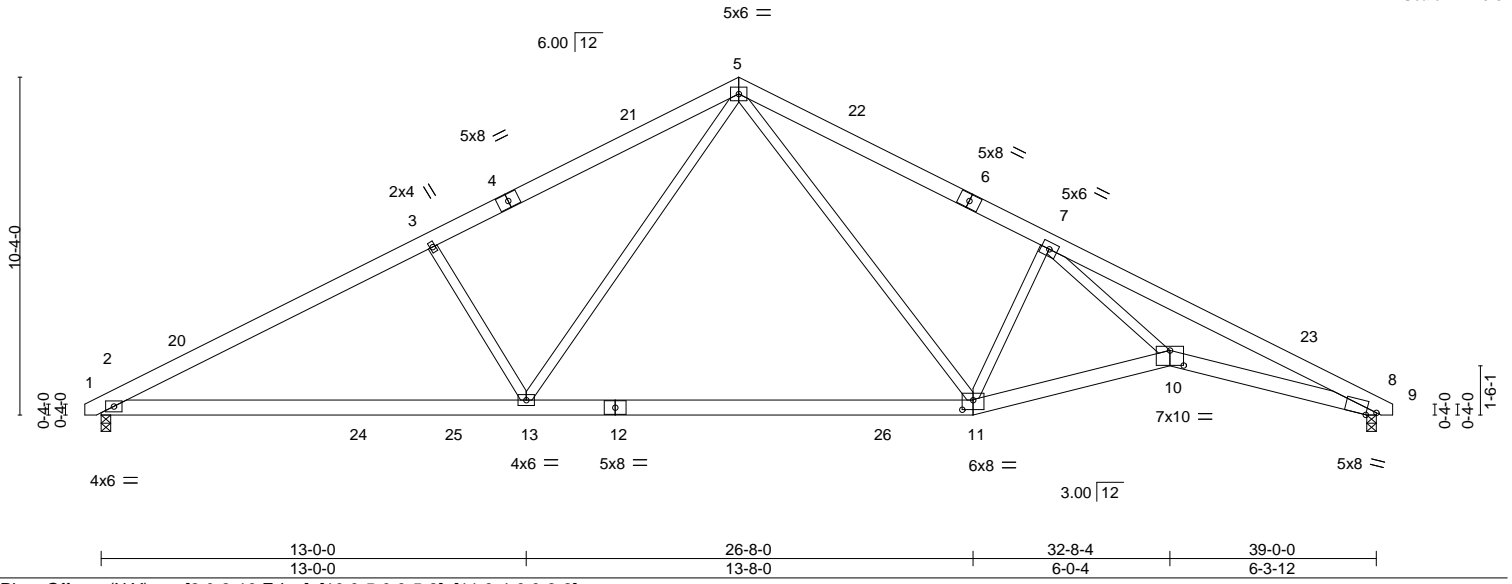

Plate Offsets (X,Y)--	[8:0-3-10,Edge], [10:0-5-0,0-5-8], [11:0-4-0,0-3-8]
-----------------------	---

LOADING (psf)	SPACING-	CSI.	DEFL.	PLATES	GRIP
TCLL 20.0	2-0-0	TC 0.56	in (loc) l/defl L/d	MT20	244/190
TCDL 10.0	Plate Grip DOL 1.15	BC 0.94	Vert(LL) -0.47 11-13 >999 360		
BCLL 0.0 *	Lumber DOL 1.15	WB 0.77	Vert(CT) -0.83 11-13 >562 240		
BCDL 10.0	Rep Stress Incr YES	Matrix-MS	Horz(CT) 0.19 8 n/a n/a		
	Code IRC2015/TPI2014		Wind(LL) 0.14 10-11 >999 240	Weight: 255 lb	FT = 20%

LUMBER-	BRACING-
TOP CHORD 2x6 SP No.2	TOP CHORD Structural wood sheathing directly applied or 2-8-14 oc purlins.
BOT CHORD 2x6 SP No.2 *Except* 2-12: 2x6 SP DSS	BOT CHORD Rigid ceiling directly applied or 10-0-0 oc bracing. Except: 2-2-0 oc bracing: 8-10.
WEBS 2x4 SP No.3 *Except* 7-10: 2x4 SP No.2	

**REACTIONS.** (size) 2=0-3-8, 8=0-3-8  
 Max Horz 2=144(LC 12)  
 Max Uplift 2=-103(LC 12), 8=-103(LC 13)  
 Max Grav 2=1579(LC 1), 8=1579(LC 1)

**FORCES.** (lb) - Max. Comp./Max. Ten. - All forces 250 (lb) or less except when shown.  
 TOP CHORD 2-3=-2823/188, 3-5=-2586/220, 5-7=-2509/264, 7-8=-5136/227  
 BOT CHORD 2-13=-200/2446, 11-13=-7/1578, 10-11=-86/2718, 8-10=-108/4638  
 WEBS 3-13=-588/283, 5-13=-91/1161, 5-11=-153/981, 7-11=-1308/288, 7-10=-27/2594

- NOTES-**
- Unbalanced roof live loads have been considered for this design.
  - Wind: ASCE 7-10; Vult=120mph Vasd=95mph; TCDL=6.0psf; BCDL=6.0psf; h=32ft; Cat. II; Exp B; Enclosed; MWFRS (envelope) gable end zone and C-C Exterior(2) -0-3-14 to 2-8-2, Interior(1) 2-8-2 to 19-6-0, Exterior(2) 19-6-0 to 22-6-0 to 39-3-14 zone; cantilever left and right exposed ; end vertical left and right exposed; C-C for members and forces & MWFRS for reactions shown; Lumber DOL=1.60 plate grip DOL=1.60
  - This truss has been designed for a 10.0 psf bottom chord live load nonconcurrent with any other live loads.
  - \* This truss has been designed for a live load of 20.0psf on the bottom chord in all areas where a rectangle 3-6-0 tall by 2-0-0 wide will fit between the bottom chord and any other members, with BCDL = 10.0psf.
  - Bearing at joint(s) 8 considers parallel to grain value using ANSI/TPI 1 angle to grain formula. Building designer should verify capacity of bearing surface.
  - Provide mechanical connection (by others) of truss to bearing plate capable of withstanding 103 lb uplift at joint 2 and 103 lb uplift at joint 8.



June 6, 2023

<p><b>WARNING - Verify design parameters and READ NOTES ON THIS AND INCLUDED MITEK REFERENCE PAGE MII-7473 rev. 5/19/2020 BEFORE USE.</b></p> <p>Design valid for use only with MiTek® connectors. This design is based only upon parameters shown, and is for an individual building component, not a truss system. Before use, the building designer must verify the applicability of design parameters and properly incorporate this design into the overall building design. Bracing indicated is to prevent buckling of individual truss web and/or chord members only. Additional temporary and permanent bracing is always required for stability and to prevent collapse with possible personal injury and property damage. For general guidance regarding the fabrication, storage, delivery, erection and bracing of trusses and truss systems, see <b>ANSI/TPI1 Quality Criteria, DSB-89 and BCSI Building Component Safety Information</b> available from Truss Plate Institute, 2670 Crain Highway, Suite 203 Waldorf, MD 20601</p>	<p>ENGINEERING BY</p> <p><b>TRENCO</b></p> <p>A MiTek Affiliate</p> <p>818 Soundside Road Edenton, NC 27932</p>
--	---

Job	Truss	Truss Type	Qty	Ply	DR Horton; Cali; 120; Master.RT	158747605
MASTER-120	A10	FAN	1	1	Job Reference (optional)	

Builders FirstSource, Apex, NC 27523

ID:GkdJTsrewC8FsrDZ9sGJOzyyZcn-sXsi90hTGqkMgphvd5RP2dOpjALfVhgZxcl3Hez9HGP  
8.430 s Jan 6 2022 MiTek Industries, Inc. Mon Jun 5 16:23:48 2023 Page 1

-0-6-0	10-1-10	19-6-0	28-10-6	39-0-0	39-6-0
0-6-0	10-1-10	9-4-6	9-4-6	10-1-10	0-6-0

Scale = 1:68.1

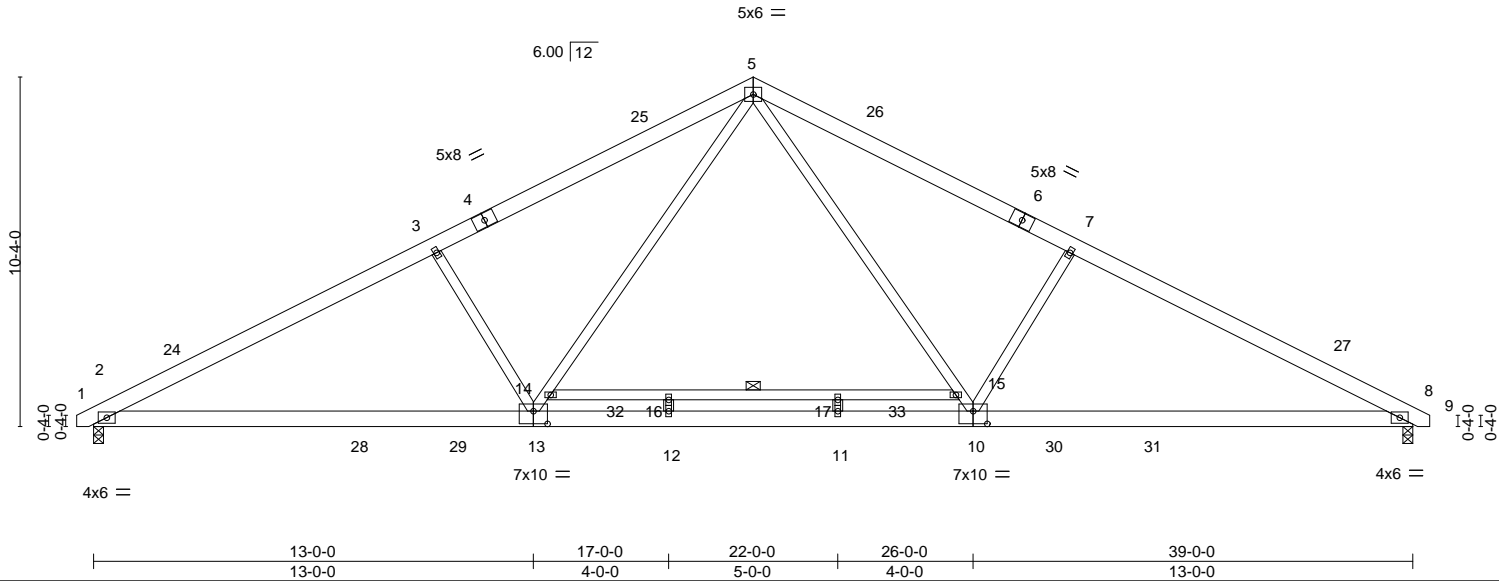

Plate Offsets (X,Y)--	[10:0-5-0,0-4-8], [13:0-5-0,0-4-8]				
<b>LOADING</b> (psf)	<b>SPACING-</b> 2-0-0	<b>CSI.</b>	<b>DEFL.</b> in (loc) l/defl L/d	<b>PLATES</b>	<b>GRIP</b>
TCLL 20.0	Plate Grip DOL 1.15	TC 0.64	Vert(LL) -0.39 11-12 >999 360	MT20	244/190
TCDL 10.0	Lumber DOL 1.15	BC 0.47	Vert(CT) -0.53 11-12 >889 240		
BCLL 0.0 *	Rep Stress Incr NO	WB 0.64	Horz(CT) 0.06 8 n/a n/a		
BCDL 10.0	Code IRC2015/TPI2014	Matrix-MS	Wind(LL) 0.10 13-20 >999 240		Weight: 266 lb FT = 20%

<b>LUMBER-</b>	<b>BRACING-</b>
TOP CHORD 2x6 SP No.2	TOP CHORD Structural wood sheathing directly applied or 3-10-14 oc purlins.
BOT CHORD 2x6 SP DSS	BOT CHORD Rigid ceiling directly applied or 10-0-0 oc bracing.
WEBS 2x4 SP No.3 *Except* 14-15: 2x4 SP No.2	WEBS 1 Row at midpt 14-15

**REACTIONS.** (size) 2=0-3-8, 8=0-3-8  
 Max Horz 2=144(LC 12)  
 Max Uplift 2=-103(LC 12), 8=-103(LC 13)  
 Max Grav 2=1593(LC 2), 8=1593(LC 2)

**FORCES.** (lb) - Max. Comp./Max. Ten. - All forces 250 (lb) or less except when shown.  
 TOP CHORD 2-24=-2828/152, 3-24=-2765/197, 3-4=-2611/184, 4-25=-2493/208, 5-25=-2466/230,  
 5-26=-2466/230, 6-26=-2493/208, 6-7=-2611/184, 7-27=-2765/197, 8-27=-2828/152  
 BOT CHORD 2-28=-208/2473, 28-29=-208/2473, 13-29=-208/2473, 12-13=-4/1787, 11-12=-4/1787,  
 10-11=-4/1787, 10-30=-64/2473, 30-31=-64/2473, 8-31=-64/2473  
 WEBS 5-15=-114/1105, 10-15=-115/1024, 7-10=-594/280, 13-14=-115/1024, 5-14=-114/1105,  
 3-13=-594/280

- NOTES-**
- Unbalanced roof live loads have been considered for this design.
  - Wind: ASCE 7-10; Vult=120mph Vasd=95mph; TCDL=6.0psf; BCDL=6.0psf; h=32ft; Cat. II; Exp B; Enclosed; MWFRS (envelope) gable end zone and C-C Exterior(2) -0-3-14 to 2-8-2, Interior(1) 2-8-2 to 19-6-0, Exterior(2) 19-6-0 to 22-6-0, Interior(1) 22-6-0 to 39-3-14 zone; cantilever left and right exposed ; end vertical left and right exposed; C-C for members and forces & MWFRS for reactions shown; Lumber DOL=1.60 plate grip DOL=1.60
  - All plates are 2x4 MT20 unless otherwise indicated.
  - This truss has been designed for a 10.0 psf bottom chord live load nonconcurrent with any other live loads.
  - \* This truss has been designed for a live load of 20.0psf on the bottom chord in all areas where a rectangle 3-6-0 tall by 2-0-0 wide will fit between the bottom chord and any other members, with BCDL = 10.0psf.
  - Provide mechanical connection (by others) of truss to bearing plate capable of withstanding 103 lb uplift at joint 2 and 103 lb uplift at joint 8.
  - This truss is designed in accordance with the 2015 International Residential Code sections R502.11.1 and R802.10.2 and referenced standard ANSI/TPI 1.
  - N/A
  - In the LOAD CASE(S) section, loads applied to the face of the truss are noted as front (F) or back (B).

**LOAD CASE(S)**

- Dead + Roof Live (balanced): Lumber Increase=1.15, Plate Increase=1.15  
 Uniform Loads (plf)  
 Vert: 1-5=-60, 5-9=-60, 18-21=-20



Continued on page 2

**WARNING - Verify design parameters and READ NOTES ON THIS AND INCLUDED MITEK REFERENCE PAGE MII-7473 rev. 5/19/2020 BEFORE USE.**  
 Design valid for use only with MiTek® connectors. This design is based only upon parameters shown, and is for an individual building component, not a truss system. Before use, the building designer must verify the applicability of design parameters and properly incorporate this design into the overall building design. Bracing indicated is to prevent buckling of individual truss web and/or chord members only. Additional temporary and permanent bracing is always required for stability and to prevent collapse with possible personal injury and property damage. For general guidance regarding the fabrication, storage, delivery, erection and bracing of trusses and truss systems, see **ANSI/TPI1 Quality Criteria, DSB-89 and BCSI Building Component Safety Information** available from Truss Plate Institute, 2670 Crain Highway, Suite 203 Waldorf, MD 20601

**ENGINEERING BY**  
**TRENCO**  
 A MiTek Affiliate  
 818 Soundside Road  
 Edenton, NC 27932

Job	Truss	Truss Type	Qty	Ply	DR Horton; Cali; 120; Master.RT	158747605
MASTER-120	A10	FAN	1	1	Job Reference (optional)	

Builders FirstSource, Apex, NC 27523

8.430 s Jan 6 2022 MiTek Industries, Inc. Mon Jun 5 16:23:48 2023 Page 2  
ID:GkdJTsrewC8FsdZ9sGJOzyyZcn-sXsi90hTGqkMgphvd5RP2dOpjALfVhgZxcl3Hez9HGP

**LOAD CASE(S)**

- 2) Dead + 0.75 Roof Live (balanced) + 0.75 Uninhab. Attic Storage: Lumber Increase=1.15, Plate Increase=1.15  
Uniform Loads (plf)  
Vert: 1-5=-50, 5-9=-50, 18-28=-20, 28-29=-50, 29-30=-20, 30-31=-50, 21-31=-20, 32-33=-30(F)
- 3) Dead + Uninhabitable Attic Without Storage: Lumber Increase=1.25, Plate Increase=1.25  
Uniform Loads (plf)  
Vert: 1-5=-20, 5-9=-20, 18-21=-40, 32-33=-40(F)
- 4) Dead + 0.6 C-C Wind (Pos. Internal) Case 1: Lumber Increase=1.60, Plate Increase=1.60  
Uniform Loads (plf)  
Vert: 1-2=47, 2-24=25, 5-24=14, 5-26=25, 8-26=14, 8-9=9, 18-21=-12  
Horz: 1-2=-59, 2-24=-37, 5-24=-26, 5-26=37, 8-26=26, 8-9=21
- 5) Dead + 0.6 C-C Wind (Pos. Internal) Case 2: Lumber Increase=1.60, Plate Increase=1.60  
Uniform Loads (plf)  
Vert: 1-2=9, 2-25=14, 5-25=25, 5-27=14, 8-27=25, 8-9=47, 18-21=-12  
Horz: 1-2=-21, 2-25=-26, 5-25=-37, 5-27=26, 8-27=37, 8-9=59
- 6) Dead + 0.6 C-C Wind (Neg. Internal) Case 1: Lumber Increase=1.60, Plate Increase=1.60  
Uniform Loads (plf)  
Vert: 1-2=-12, 2-5=-33, 5-8=-33, 8-9=-28, 18-21=-20  
Horz: 1-2=-8, 2-5=13, 5-8=-13, 8-9=-8
- 7) Dead + 0.6 C-C Wind (Neg. Internal) Case 2: Lumber Increase=1.60, Plate Increase=1.60  
Uniform Loads (plf)  
Vert: 1-2=-28, 2-5=-33, 5-8=-33, 8-9=-12, 18-21=-20  
Horz: 1-2=8, 2-5=13, 5-8=-13, 8-9=8
- 8) Dead + 0.6 MWFRS Wind (Pos. Internal) Left: Lumber Increase=1.60, Plate Increase=1.60  
Uniform Loads (plf)  
Vert: 1-2=9, 2-5=-2, 5-8=9, 8-9=4, 18-21=-12  
Horz: 1-2=-21, 2-5=-10, 5-8=21, 8-9=16
- 9) Dead + 0.6 MWFRS Wind (Pos. Internal) Right: Lumber Increase=1.60, Plate Increase=1.60  
Uniform Loads (plf)  
Vert: 1-2=4, 2-5=9, 5-8=-2, 8-9=9, 18-21=-12  
Horz: 1-2=-16, 2-5=-21, 5-8=10, 8-9=21
- 10) Dead + 0.6 MWFRS Wind (Neg. Internal) Left: Lumber Increase=1.60, Plate Increase=1.60  
Uniform Loads (plf)  
Vert: 1-2=-15, 2-5=-20, 5-8=-9, 8-9=-4, 18-21=-20  
Horz: 1-2=-5, 2-5=0, 5-8=11, 8-9=16
- 11) Dead + 0.6 MWFRS Wind (Neg. Internal) Right: Lumber Increase=1.60, Plate Increase=1.60  
Uniform Loads (plf)  
Vert: 1-2=-4, 2-5=9, 5-8=-20, 8-9=-15, 18-21=-20  
Horz: 1-2=-16, 2-5=11, 5-8=0, 8-9=5
- 12) Dead + 0.6 MWFRS Wind (Pos. Internal) 1st Parallel: Lumber Increase=1.60, Plate Increase=1.60  
Uniform Loads (plf)  
Vert: 1-2=17, 2-5=22, 5-8=7, 8-9=2, 18-21=-12  
Horz: 1-2=-29, 2-5=-34, 5-8=19, 8-9=14
- 13) Dead + 0.6 MWFRS Wind (Pos. Internal) 2nd Parallel: Lumber Increase=1.60, Plate Increase=1.60  
Uniform Loads (plf)  
Vert: 1-2=2, 2-5=7, 5-8=22, 8-9=17, 18-21=-12  
Horz: 1-2=-14, 2-5=19, 5-8=34, 8-9=29
- 14) Dead + 0.6 MWFRS Wind (Pos. Internal) 3rd Parallel: Lumber Increase=1.60, Plate Increase=1.60  
Uniform Loads (plf)  
Vert: 1-2=7, 2-5=11, 5-8=3, 8-9=-2, 18-21=-12  
Horz: 1-2=-19, 2-5=-23, 5-8=15, 8-9=10
- 15) Dead + 0.6 MWFRS Wind (Pos. Internal) 4th Parallel: Lumber Increase=1.60, Plate Increase=1.60  
Uniform Loads (plf)  
Vert: 1-2=-2, 2-5=3, 5-8=11, 8-9=7, 18-21=-12  
Horz: 1-2=-10, 2-5=15, 5-8=23, 8-9=19
- 16) Dead + 0.6 MWFRS Wind (Neg. Internal) 1st Parallel: Lumber Increase=1.60, Plate Increase=1.60  
Uniform Loads (plf)  
Vert: 1-2=9, 2-5=4, 5-8=-11, 8-9=-6, 18-21=-20  
Horz: 1-2=-29, 2-5=-24, 5-8=9, 8-9=14
- 17) Dead + 0.6 MWFRS Wind (Neg. Internal) 2nd Parallel: Lumber Increase=1.60, Plate Increase=1.60  
Uniform Loads (plf)  
Vert: 1-2=-6, 2-5=-11, 5-8=4, 8-9=9, 18-21=-20  
Horz: 1-2=-14, 2-5=9, 5-8=24, 8-9=29
- 18) Dead + Uninhabitable Attic Storage: Lumber Increase=1.25, Plate Increase=1.25  
Uniform Loads (plf)  
Vert: 1-5=-20, 5-9=-20, 18-28=-20, 28-29=-60, 29-30=-20, 30-31=-60, 21-31=-20, 32-33=-40(F)
- 19) Dead + 0.75 Roof Live (bal.) + 0.75 Uninhab. Attic Storage + 0.75(0.6 MWFRS Wind (Neg. Int) Left): Lumber Increase=1.60, Plate Increase=1.60  
Uniform Loads (plf)  
Vert: 1-2=-46, 2-5=-50, 5-8=-42, 8-9=-38, 18-28=-20, 28-29=-50, 29-30=-20, 30-31=-50, 21-31=-20, 32-33=-30(F)  
Horz: 1-2=-4, 2-5=0, 5-8=8, 8-9=12
- 20) Dead + 0.75 Roof Live (bal.) + 0.75 Uninhab. Attic Storage + 0.75(0.6 MWFRS Wind (Neg. Int) Right): Lumber Increase=1.60, Plate Increase=1.60  
Uniform Loads (plf)  
Vert: 1-2=-38, 2-5=-42, 5-8=-50, 8-9=-46, 18-28=-20, 28-29=-50, 29-30=-20, 30-31=-50, 21-31=-20, 32-33=-30(F)  
Horz: 1-2=-12, 2-5=8, 5-8=0, 8-9=4

Continued on page 3

**WARNING - Verify design parameters and READ NOTES ON THIS AND INCLUDED MITEK REFERENCE PAGE MII-7473 rev. 5/19/2020 BEFORE USE.**

Design valid for use only with MiTek® connectors. This design is based only upon parameters shown, and is for an individual building component, not a truss system. Before use, the building designer must verify the applicability of design parameters and properly incorporate this design into the overall building design. Bracing indicated is to prevent buckling of individual truss web and/or chord members only. Additional temporary and permanent bracing is always required for stability and to prevent collapse with possible personal injury and property damage. For general guidance regarding the fabrication, storage, delivery, erection and bracing of trusses and truss systems, see **ANSI/TPI1 Quality Criteria, DSB-89 and BCSI Building Component Safety Information** available from Truss Plate Institute, 2670 Crain Highway, Suite 203 Waldorf, MD 20601



818 Soundside Road  
Edenton, NC 27932

Job	Truss	Truss Type	Qty	Ply	DR Horton; Cali; 120; Master.RT	158747605
MASTER-120	A10	FAN	1	1	Job Reference (optional)	

Builders FirstSource, Apex, NC 27523

8.430 s Jan 6 2022 MiTek Industries, Inc. Mon Jun 5 16:23:48 2023 Page 3  
 ID:GkdJTsrewC8FsrDZ9sGJOzyyZcn-sXsi90hTGqkMgphvd5RP2dOpjALfVhgZxcl3Hez9HGP

**LOAD CASE(S)**

- 21) Dead + 0.75 Roof Live (bal.) + 0.75 Uninhab. Attic Storage + 0.75(0.6 MWFRS Wind (Neg. Int) 1st Parallel): Lumber Increase=1.60, Plate Increase=1.60  
 Uniform Loads (plf)  
 Vert: 1-2=-28, 2-5=-32, 5-8=-43, 8-9=-39, 18-28=-20, 28-29=-50, 29-30=-20, 30-31=-50, 21-31=-20, 32-33=-30(F)  
 Horz: 1-2=-22, 2-5=-18, 5-8=7, 8-9=11
- 22) Dead + 0.75 Roof Live (bal.) + 0.75 Uninhab. Attic Storage + 0.75(0.6 MWFRS Wind (Neg. Int) 2nd Parallel): Lumber Increase=1.60, Plate Increase=1.60  
 Uniform Loads (plf)  
 Vert: 1-2=-39, 2-5=-43, 5-8=-32, 8-9=-28, 18-28=-20, 28-29=-50, 29-30=-20, 30-31=-50, 21-31=-20, 32-33=-30(F)  
 Horz: 1-2=-11, 2-5=-7, 5-8=18, 8-9=22
- 23) 1st Dead + Roof Live (unbalanced): Lumber Increase=1.15, Plate Increase=1.15  
 Uniform Loads (plf)  
 Vert: 1-5=-60, 5-9=-20, 18-21=-20
- 24) 2nd Dead + Roof Live (unbalanced): Lumber Increase=1.15, Plate Increase=1.15  
 Uniform Loads (plf)  
 Vert: 1-5=-20, 5-9=-60, 18-21=-20
- 25) 3rd Dead + 0.75 Roof Live (unbalanced) + 0.75 Uninhab. Attic Storage: Lumber Increase=1.15, Plate Increase=1.15  
 Uniform Loads (plf)  
 Vert: 1-5=-50, 5-9=-20, 18-28=-20, 28-29=-50, 29-30=-20, 30-31=-50, 21-31=-20, 32-33=-30(F)
- 26) 4th Dead + 0.75 Roof Live (unbalanced) + 0.75 Uninhab. Attic Storage: Lumber Increase=1.15, Plate Increase=1.15  
 Uniform Loads (plf)  
 Vert: 1-5=-20, 5-9=-50, 18-28=-20, 28-29=-50, 29-30=-20, 30-31=-50, 21-31=-20, 32-33=-30(F)

**WARNING - Verify design parameters and READ NOTES ON THIS AND INCLUDED MITEK REFERENCE PAGE MII-7473 rev. 5/19/2020 BEFORE USE.**

Design valid for use only with MiTek® connectors. This design is based only upon parameters shown, and is for an individual building component, not a truss system. Before use, the building designer must verify the applicability of design parameters and properly incorporate this design into the overall building design. Bracing indicated is to prevent buckling of individual truss web and/or chord members only. Additional temporary and permanent bracing is always required for stability and to prevent collapse with possible personal injury and property damage. For general guidance regarding the fabrication, storage, delivery, erection and bracing of trusses and truss systems, see **ANSI/TPI1 Quality Criteria, DSB-89 and BCSI Building Component**

**Safety Information** available from Truss Plate Institute, 2670 Crain Highway, Suite 203 Waldorf, MD 20601



818 Soundside Road  
 Edenton, NC 27932

Job MASTER-120	Truss A15C	Truss Type CATHEDRAL	Qty 1	Ply 1	DR Horton; Cali; 120; Master.RT	158747610
-------------------	---------------	-------------------------	----------	----------	---------------------------------	-----------

Builders FirstSource (Apex, NC), Apex, NC - 27523, 8.430 s Jan 6 2022 MiTek Industries, Inc. Mon Jun 5 15:53:39 2023 Page 1

ID:GkdJTsrewC8FsrdrZ9sGJOzzyZcn-RfC?PsB70Hq3NSgPqnL8w3ulTXbGKWrCDoi7J4zJC?f

-0-6-0 0-6-0	10-1-10 10-1-10	19-6-0 9-4-6	28-10-6 9-4-6	39-0-0 10-1-10	39-6-0 0-6-0
-----------------	--------------------	-----------------	------------------	-------------------	-----------------

Scale = 1:70.5

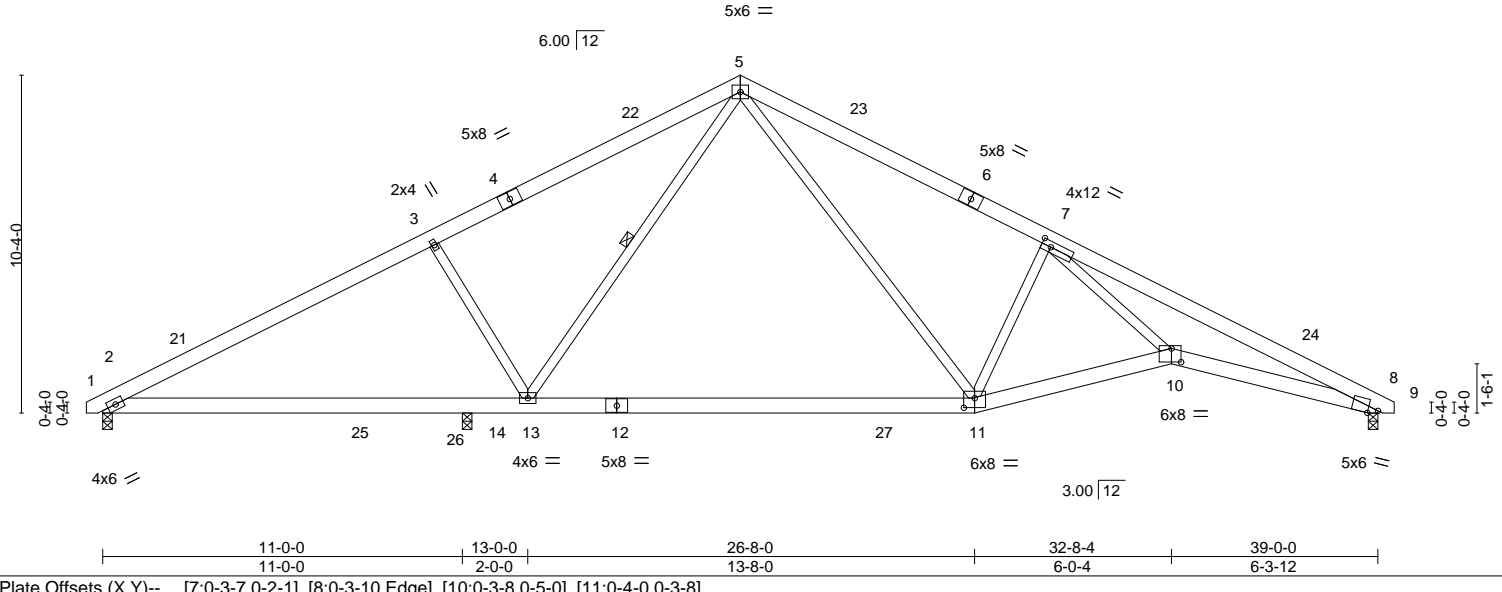

Plate Offsets (X,Y)--	[7:0-3-7,0-2-1], [8:0-3-10,Edge], [10:0-3-8,0-5-0], [11:0-4-0,0-3-8]
-----------------------	--

LOADING (psf)	SPACING-	CSI.	DEFL.	PLATES	GRIP
TCLL 20.0	2-0-0	TC 0.50	in (loc) l/defl L/d	MT20	244/190
TCDL 10.0	Plate Grip DOL 1.15	BC 0.77	Vert(LL) -0.46 11-13 >727 360		
BCLL 0.0 *	Lumber DOL 1.15	WB 0.87	Vert(CT) -0.85 11-13 >394 240		
BCDL 10.0	Rep Stress Incr YES	Matrix-MS	Horz(CT) 0.14 8 n/a n/a		
	Code IRC2015/TPI2014		Wind(LL) 0.15 11-13 >999 240	Weight: 255 lb	FT = 20%

LUMBER-	BRACING-
TOP CHORD 2x6 SP No.2	TOP CHORD Structural wood sheathing directly applied or 3-2-3 oc purlins.
BOT CHORD 2x6 SP No.2 *Except* 2-12,11-12: 2x6 SP DSS	BOT CHORD Rigid ceiling directly applied or 10-0-0 oc bracing.
WEBS 2x4 SP No.3	WEBS 1 Row at midpt 5-13

**REACTIONS.** (size) 2=0-3-8, 8=0-3-8, 14=0-3-8  
 Max Horz 2=144(LC 12)  
 Max Uplift 2=-69(LC 12), 8=-103(LC 13), 14=-48(LC 12)  
 Max Grav 2=1004(LC 2), 8=1332(LC 1), 14=866(LC 1)

**FORCES.** (lb) - Max. Comp./Max. Ten. - All forces 250 (lb) or less except when shown.  
 TOP CHORD 2-3=-1730/129, 3-5=-1494/168, 5-7=-2030/264, 7-8=-4157/227  
 BOT CHORD 2-14=-143/1480, 13-14=-143/1480, 11-13=0/1106, 10-11=-86/2212, 8-10=-108/3747  
 WEBS 3-13=-566/281, 5-13=-165/406, 5-11=-152/1038, 7-11=-1170/288, 7-10=-27/2111

- NOTES-**
- 1) Unbalanced roof live loads have been considered for this design.
  - 2) Wind: ASCE 7-10; Vult=120mph Vasd=95mph; TCDL=6.0psf; BCDL=6.0psf; h=32ft; Cat. II; Exp B; Enclosed; MWFRS (envelope) gable end zone and C-C Exterior(2) -0-3-14 to 2-8-2, Interior(1) 2-8-2 to 19-6-0, Exterior(2) 19-6-0 to 22-6-0, Interior(1) 22-6-0 to 39-3-14 zone; cantilever left and right exposed ; end vertical left and right exposed;C-C for members and forces & MWFRS for reactions shown; Lumber DOL=1.60 plate grip DOL=1.60
  - 3) This truss has been designed for a 10.0 psf bottom chord live load nonconcurrent with any other live loads.
  - 4) \* This truss has been designed for a live load of 20.0psf on the bottom chord in all areas where a rectangle 3-6-0 tall by 2-0-0 wide will fit between the bottom chord and any other members, with BCDL = 10.0psf.
  - 5) Bearing at joint(s) 8 considers parallel to grain value using ANSI/TPI 1 angle to grain formula. Building designer should verify capacity of bearing surface.
  - 6) Provide mechanical connection (by others) of truss to bearing plate capable of withstanding 100 lb uplift at joint(s) 2, 14 except (j=lb) 8=103.

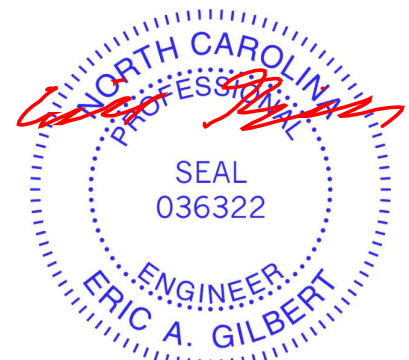

June 6, 2023

<p><b>WARNING - Verify design parameters and READ NOTES ON THIS AND INCLUDED MITEK REFERENCE PAGE MII-7473 rev. 5/19/2020 BEFORE USE.</b></p> <p>Design valid for use only with MiTek® connectors. This design is based only upon parameters shown, and is for an individual building component, not a truss system. Before use, the building designer must verify the applicability of design parameters and properly incorporate this design into the overall building design. Bracing indicated is to prevent buckling of individual truss web and/or chord members only. Additional temporary and permanent bracing is always required for stability and to prevent collapse with possible personal injury and property damage. For general guidance regarding the fabrication, storage, delivery, erection and bracing of trusses and truss systems, see <b>ANSI/TPI1 Quality Criteria, DSB-89 and BCSI Building Component Safety Information</b> available from Truss Plate Institute, 2670 Crain Highway, Suite 203 Waldorf, MD 20601</p>	<p>818 Soundside Road Edenton, NC 27932</p>
--	---

Job MASTER-120	Truss A16CG	Truss Type GABLE	Qty 1	Ply 1	DR Horton; Cali; 120; Master.RT Job Reference (optional)	158747611
-------------------	----------------	---------------------	----------	----------	---	-----------

Builders FirstSource (Apex, NC), Apex, NC - 27523, 8.430 s Jan 6 2022 MiTek Industries, Inc. Mon Jun 5 15:53:41 2023 Page 1  
ID:GkdJTsrewC8FsrDZ9sGJozzyZcn-RfC?PsB70Hq3NSgPqnL8w3uITXbGKWrCDoi7J4zJC?f

0-6-0 19-6-0 39-0-0 39-6-0  
0-6-0 19-6-0 19-6-0 0-6-0

5x6 =

Scale = 1:73.0

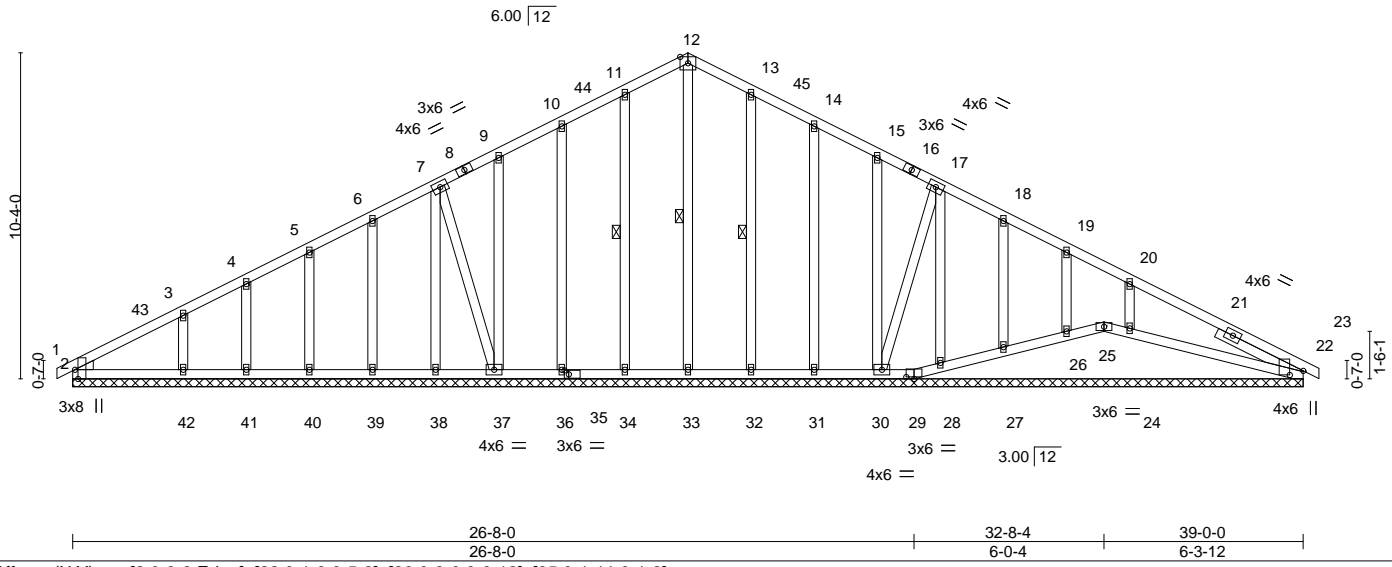

LOADING (psf)	SPACING-	2-0-0	CSI.	DEFL.	in (loc)	l/defl	L/d	PLATES	GRIP
TCLL 20.0	Plate Grip DOL	1.15	TC 0.36	Vert(LL)	0.01	23	n/r	MT20	244/190
TCDL 10.0	Lumber DOL	1.15	BC 0.24	Vert(CT)	0.01	23	n/r		
BCLL 0.0 *	Rep Stress Incr	YES	WB 0.15	Horz(CT)	0.01	22	n/a		
BCDL 10.0	Code IRC2015/TPI2014		Matrix-S						
								Weight: 282 lb	FT = 20%

LUMBER-	BRACING-
TOP CHORD 2x4 SP No.2	TOP CHORD Structural wood sheathing directly applied or 6-0-0 oc purlins.
BOT CHORD 2x4 SP No.2	BOT CHORD Rigid ceiling directly applied or 10-0-0 oc bracing. Except:
WEBS 2x4 SP No.3	6-0-0 oc bracing: 24-25.
OTHERS 2x4 SP No.3	WEBS 1 Row at midpt 12-33, 11-34, 13-32
WEDGE	
Left: 2x4 SP No.3	
SLIDER Right 2x4 SP No.3 3-0-1	

**REACTIONS.** All bearings 39-0-0.  
 (lb) - Max Horz 2=145(LC 16)  
 Max Uplift All uplift 100 lb or less at joint(s) 2, 29, 22, 34, 36, 37, 39, 40, 41, 42, 32, 31, 27, 24 except 25=121(LC 3), 30=136(LC 13)  
 Max Grav All reactions 250 lb or less at joint(s) 2, 29, 25, 22, 33, 34, 36, 37, 38, 39, 40, 41, 32, 31, 28, 27, 26 except 42=279(LC 23), 30=257(LC 24), 24=481(LC 24)

**FORCES.** (lb) - Max. Comp./Max. Ten. - All forces 250 (lb) or less except when shown.  
 WEBS 20-24=-307/160

- NOTES-**
- 1) Unbalanced roof live loads have been considered for this design.
  - 2) Wind: ASCE 7-10; Vult=120mph Vasd=95mph; TCDL=6.0psf; BCDL=6.0psf; h=32ft; Cat. II; Exp B; Enclosed; MWFRS (envelope) gable end zone and C-C Exterior(2) -0-6-0 to 2-6-0, Interior(1) 2-6-0 to 19-6-0, Exterior(2) 19-6-0 to 22-6-0, Interior(1) 22-6-0 to 39-6-0 zone; cantilever left and right exposed; end vertical left and right exposed; C-C for members and forces & MWFRS for reactions shown; Lumber DOL=1.60 plate grip DOL=1.60
  - 3) Truss designed for wind loads in the plane of the truss only. For studs exposed to wind (normal to the face), see Standard Industry Gable End Details as applicable, or consult qualified building designer as per ANSI/TPI 1.
  - 4) All plates are 2x4 MT20 unless otherwise indicated.
  - 5) Gable requires continuous bottom chord bearing.
  - 6) Gable studs spaced at 2-0-0 oc.
  - 7) This truss has been designed for a 10.0 psf bottom chord live load nonconcurrent with any other live loads.
  - 8) \* This truss has been designed for a live load of 20.0psf on the bottom chord in all areas where a rectangle 3-6-0 tall by 2-0-0 wide will fit between the bottom chord and any other members.
  - 9) Provide mechanical connection (by others) of truss to bearing plate capable of withstanding 100 lb uplift at joint(s) 2, 29, 22, 34, 36, 37, 39, 40, 41, 42, 32, 31, 27, 24 except (jt=lb) 25=121, 30=136.
  - 10) Beveled plate or shim required to provide full bearing surface with truss chord at joint(s) 25, 28, 27, 26, 24.

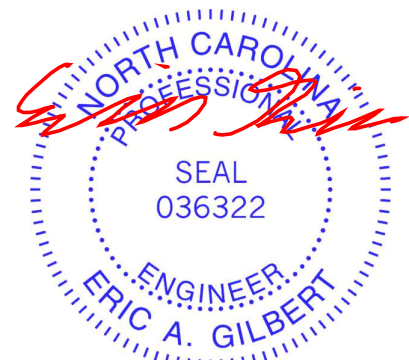

June 6, 2023

**WARNING - Verify design parameters and READ NOTES ON THIS AND INCLUDED MITEK REFERENCE PAGE MII-7473 rev. 5/19/2020 BEFORE USE.**  
 Design valid for use only with MiTek® connectors. This design is based only upon parameters shown, and is for an individual building component, not a truss system. Before use, the building designer must verify the applicability of design parameters and properly incorporate this design into the overall building design. Bracing indicated is to prevent buckling of individual truss web and/or chord members only. Additional temporary and permanent bracing is always required for stability and to prevent collapse with possible personal injury and property damage. For general guidance regarding the fabrication, storage, delivery, erection and bracing of trusses and truss systems, see **ANSI/TPI1 Quality Criteria, DSB-89 and BCSI Building Component Safety Information** available from Truss Plate Institute, 2670 Crain Highway, Suite 203 Waldorf, MD 20601

**ENGINEERING BY**  
**TRENCO**  
 A MiTek Affiliate  
 818 Soundside Road  
 Edenton, NC 27932



Job MASTER-120	Truss B01G	Truss Type GABLE	Qty 1	Ply 1	DR Horton; Cali; 120; Master.RT 158747613
Builders FirstSource (Apex, NC), Apex, NC - 27523,					Job Reference (optional)

8.430 s Jan 6 2022 MiTek Industries, Inc. Mon Jun 5 15:53:45 2023 Page 1  
 ID:GkdJTsrewC8FsrDZ9sGJOzYyZcn-RfC?PsB70Hq3NSgPqnL8w3uITXbGKWrCDoi7J4zJC?f



4x6 =

Scale = 1:38.0

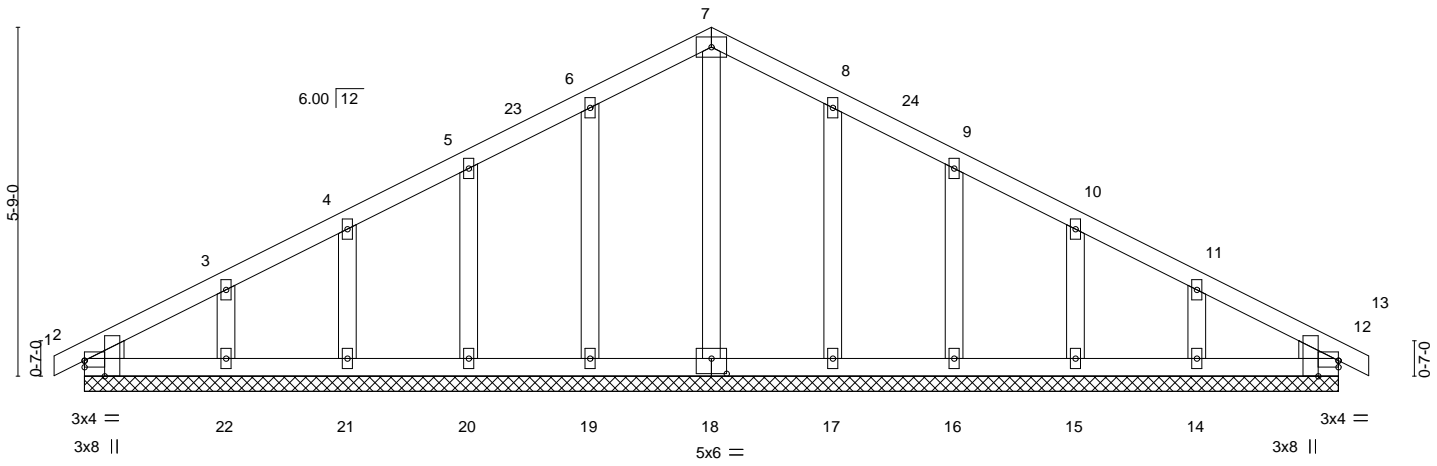

20-8-0  
20-8-0

Plate Offsets (X, Y)-- [2:0-0-0,0-1-5], [2:0-3-1,Edge], [12:0-3-1,Edge], [12:0-0-0,0-1-5], [18:0-3-0,0-3-0]

LOADING (psf)	SPACING-	2-0-0	CSI.	DEFL.	in (loc)	l/defl	L/d	PLATES	GRIP
TCLL 20.0	Plate Grip DOL	1.15	TC 0.07	Vert(LL)	0.00	12	n/r	MT20	244/190
TCDL 10.0	Lumber DOL	1.15	BC 0.05	Vert(CT)	0.00	13	n/r		
BCLL 0.0 *	Rep Stress Incr	NO	WB 0.06	Horz(CT)	0.00	12	n/a		
BCDL 10.0	Code IRC2015/TPI2014		Matrix-S						
								Weight: 109 lb	FT = 20%

**LUMBER-**  
 TOP CHORD 2x4 SP No.2  
 BOT CHORD 2x4 SP No.2  
 OTHERS 2x4 SP No.3  
 WEDGE  
 Left: 2x4 SP No.3 , Right: 2x4 SP No.3

**BRACING-**  
 TOP CHORD Structural wood sheathing directly applied or 6-0-0 oc purlins.  
 BOT CHORD Rigid ceiling directly applied or 10-0-0 oc bracing.

**REACTIONS.** All bearings 20-8-0.  
 (lb) - Max Horz 2=78(LC 12)  
 Max Uplift All uplift 100 lb or less at joint(s) 2, 19, 20, 21, 22, 17, 16, 15, 14  
 Max Grav All reactions 250 lb or less at joint(s) 2, 18, 19, 20, 21, 22, 17, 16, 15, 12, 14

**FORCES.** (lb) - Max. Comp./Max. Ten. - All forces 250 (lb) or less except when shown.

**NOTES-**

- 1) Unbalanced roof live loads have been considered for this design.
- 2) Wind: ASCE 7-10; Vult=120mph Vasd=95mph; TCDL=6.0psf; BCDL=6.0psf; h=32ft; Cat. II; Exp B; Enclosed; MWFRS (envelope) gable end zone and C-C Corner(3) -0-6-0 to 2-4-0, Exterior(2) 2-4-0 to 10-4-0, Corner(3) 10-4-0 to 13-4-0, Exterior(2) 13-4-0 to 21-2-0 zone; cantilever left and right exposed ; end vertical left and right exposed;C-C for members and forces & MWFRS for reactions shown; Lumber DOL=1.60 plate grip DOL=1.60
- 3) Truss designed for wind loads in the plane of the truss only. For studs exposed to wind (normal to the face), see Standard Industry Gable End Details as applicable, or consult qualified building designer as per ANSI/TPI 1.
- 4) All plates are 2x4 MT20 unless otherwise indicated.
- 5) Gable requires continuous bottom chord bearing.
- 6) Gable studs spaced at 2-0-0 oc.
- 7) This truss has been designed for a 10.0 psf bottom chord live load nonconcurrent with any other live loads.
- 8) \* This truss has been designed for a live load of 20.0psf on the bottom chord in all areas where a rectangle 3-6-0 tall by 2-0-0 wide will fit between the bottom chord and any other members.
- 9) Provide mechanical connection (by others) of truss to bearing plate capable of withstanding 100 lb uplift at joint(s) 2, 19, 20, 21, 22, 17, 16, 15, 14.



June 6, 2023

**WARNING - Verify design parameters and READ NOTES ON THIS AND INCLUDED MITEK REFERENCE PAGE MII-7473 rev. 5/19/2020 BEFORE USE.**  
 Design valid for use only with MiTek® connectors. This design is based only upon parameters shown, and is for an individual building component, not a truss system. Before use, the building designer must verify the applicability of design parameters and properly incorporate this design into the overall building design. Bracing indicated is to prevent buckling of individual truss web and/or chord members only. Additional temporary and permanent bracing is always required for stability and to prevent collapse with possible personal injury and property damage. For general guidance regarding the fabrication, storage, delivery, erection and bracing of trusses and truss systems, see **ANSI/TPI1 Quality Criteria, DSB-89 and BCSI Building Component Safety Information** available from Truss Plate Institute, 2670 Crain Highway, Suite 203 Waldorf, MD 20601



Job MASTER-120	Truss B02	Truss Type COMMON	Qty 1	Ply 1	DR Horton; Cali; 120; Master.RT	158747614
-------------------	--------------	----------------------	----------	----------	---------------------------------	-----------

Builders FirstSource (Apex, NC), Apex, NC - 27523, 8.430 s Jan 6 2022 MiTek Industries, Inc. Mon Jun 5 15:53:46 2023 Page 1

ID:GkdJTsrewC8FsrDZ9sGJOzzyZcn-RfC?PsB70Hq3NSgPqnL8w3uITXbGKWrCDoi7J4zJC?f

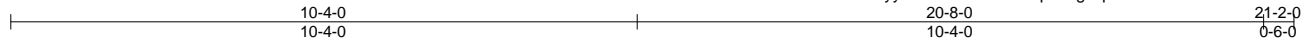

5x8 =

Scale = 1:38.0

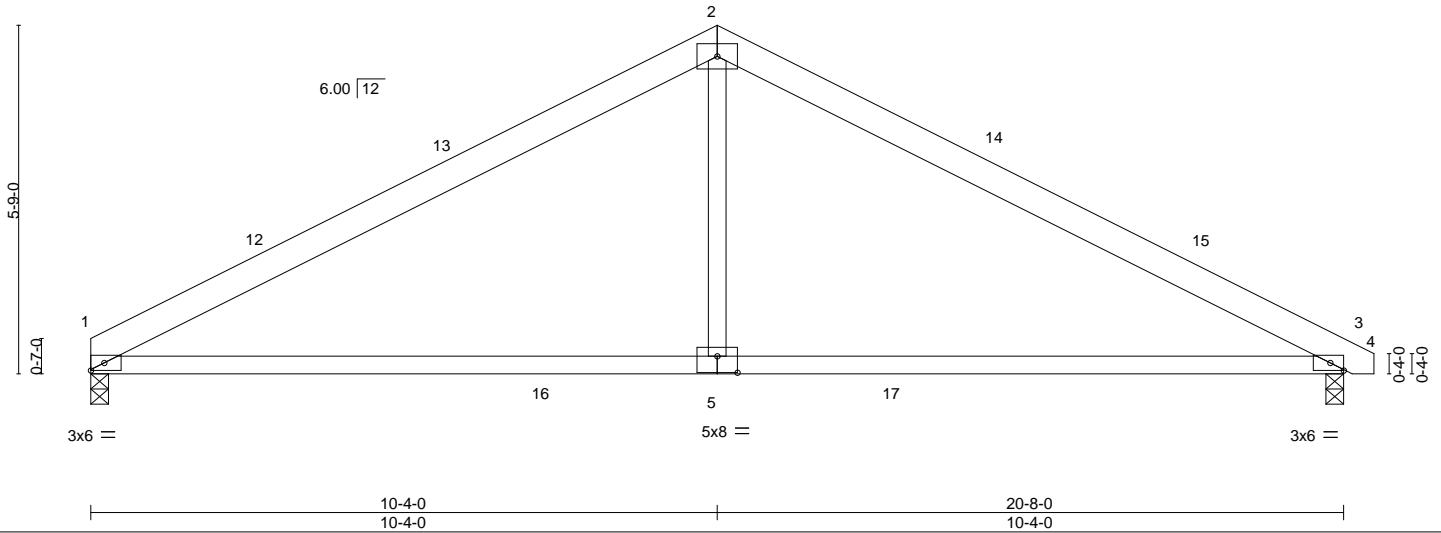

Plate Offsets (X,Y)--	[5:0-4-0,0-3-4]								
<b>LOADING</b> (psf)	<b>SPACING-</b>	2-0-0	<b>CSI.</b>	<b>DEFL.</b>	in (loc)	l/defl	L/d	<b>PLATES</b>	<b>GRIP</b>
TCLL 20.0	Plate Grip DOL	1.15	TC 0.79	Vert(LL)	-0.15	5-8	>999	MT20	244/190
TCDL 10.0	Lumber DOL	1.15	BC 0.96	Vert(CT)	-0.35	5-8	>706		
BCLL 0.0 *	Rep Stress Incr	YES	WB 0.17	Horz(CT)	0.02	1	n/a		
BCDL 10.0	Code IRC2015/TPI2014		Matrix-MS	Wind(LL)	0.12	5-8	>999	Weight: 94 lb	FT = 20%

<b>LUMBER-</b>	<b>BRACING-</b>
TOP CHORD 2x6 SP No.2	TOP CHORD Structural wood sheathing directly applied or 4-2-2 oc purlins.
BOT CHORD 2x4 SP No.2	BOT CHORD Rigid ceiling directly applied or 2-2-0 oc bracing.
WEBS 2x4 SP No.3	

**REACTIONS.** (size) 1=0-3-8, 3=0-3-8  
 Max Horz 1=-80(LC 17)  
 Max Uplift 1=-16(LC 12), 3=-21(LC 13)  
 Max Grav 1=827(LC 1), 3=846(LC 1)

**FORCES.** (lb) - Max. Comp./Max. Ten. - All forces 250 (lb) or less except when shown.  
 TOP CHORD 1-2=-1157/125, 2-3=-1157/123  
 BOT CHORD 1-5=0/969, 3-5=0/969  
 WEBS 2-5=0/438

- NOTES-**
- Unbalanced roof live loads have been considered for this design.
  - Wind: ASCE 7-10; Vult=120mph Vasd=95mph; TCDL=6.0psf; BCDL=6.0psf; h=32ft; Cat. II; Exp B; Enclosed; MWFRS (envelope) gable end zone and C-C Exterior(2) 0-0-0 to 3-0-0, Interior(1) 3-0-0 to 10-4-0, Exterior(2) 10-4-0 to 14-6-15, Interior(1) 14-6-15 to 20-11-14 zone; cantilever left and right exposed; end vertical left and right exposed; C-C for members and forces & MWFRS for reactions shown; Lumber DOL=1.60 plate grip DOL=1.60
  - This truss has been designed for a 10.0 psf bottom chord live load nonconcurrent with any other live loads.
  - \* This truss has been designed for a live load of 20.0psf on the bottom chord in all areas where a rectangle 3-6-0 tall by 2-0-0 wide will fit between the bottom chord and any other members, with BCDL = 10.0psf.
  - Provide mechanical connection (by others) of truss to bearing plate capable of withstanding 100 lb uplift at joint(s) 1, 3.

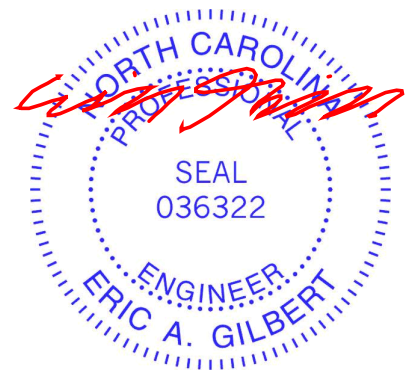

Job MASTER-120	Truss C01G	Truss Type GABLE	Qty 1	Ply 1	DR Horton; Cali; 120; Master.RT Job Reference (optional)	158747615
-------------------	---------------	---------------------	----------	----------	---	-----------

Builders FirstSource (Apex, NC), Apex, NC - 27523, 8.430 s Jan 6 2022 MiTek Industries, Inc. Mon Jun 5 15:53:47 2023 Page 1

ID:GkdJTsrewC8FsrdsGJozyyZcn-RfC?PsB70Hq3NSgPqnL8w3uITXbGKWrCDoi7J4zJC?f

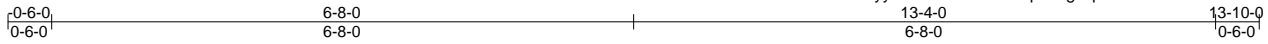

4x6 =

Scale = 1:26.4

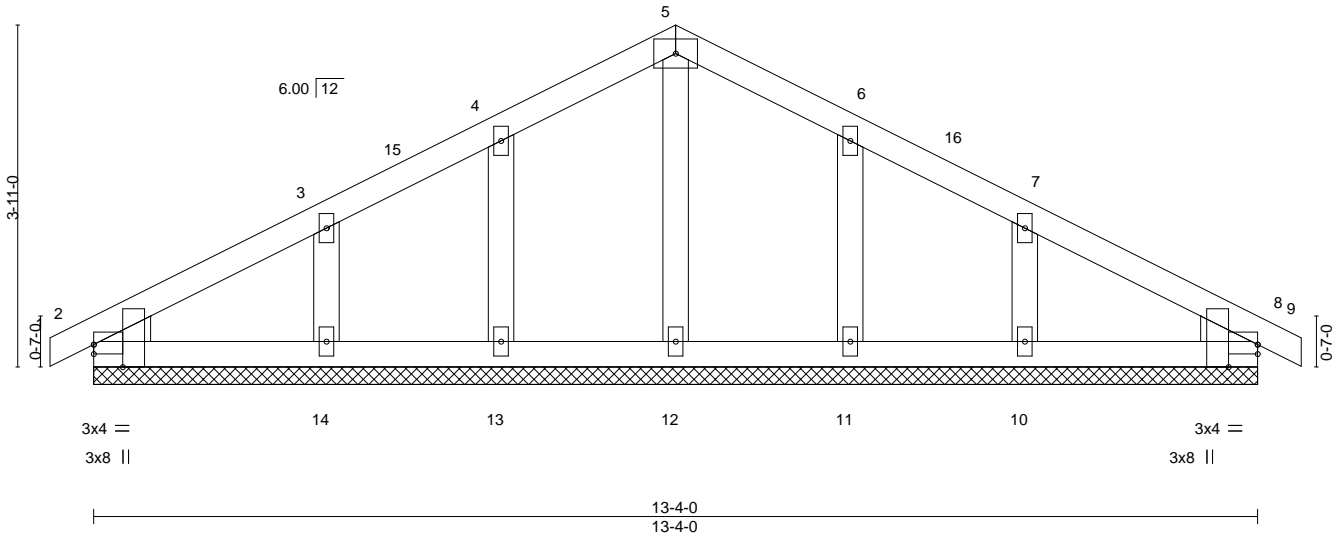

Plate Offsets (X, Y)--	[2:0-0-0,0-1-5], [2:0-3-1,Edge], [8:0-0-0,0-1-5], [8:0-3-1,Edge]
------------------------	--

LOADING (psf)	SPACING-	2-0-0	CSI.	DEFL.	in (loc)	l/defl	L/d	PLATES	GRIP
TCLL 20.0	Plate Grip DOL	1.15	TC 0.08	Vert(LL)	0.00	8	n/r	MT20	244/190
TCDL 10.0	Lumber DOL	1.15	BC 0.06	Vert(CT)	0.00	9	n/r		
BCLL 0.0 *	Rep Stress Incr	NO	WB 0.04	Horz(CT)	0.00	8	n/a		
BCDL 10.0	Code IRC2015/TPI2014		Matrix-S						
								Weight: 62 lb	FT = 20%

**LUMBER-**  
TOP CHORD 2x4 SP No.2  
BOT CHORD 2x4 SP No.2  
OTHERS 2x4 SP No.3  
WEDGE  
Left: 2x4 SP No.3 , Right: 2x4 SP No.3

**BRACING-**  
TOP CHORD Structural wood sheathing directly applied or 6-0-0 oc purlins.  
BOT CHORD Rigid ceiling directly applied or 10-0-0 oc bracing.

**REACTIONS.** All bearings 13-4-0.  
(lb) - Max Horz 2=52(LC 13)  
Max Uplift All uplift 100 lb or less at joint(s) 2, 8, 13, 14, 11, 10  
Max Grav All reactions 250 lb or less at joint(s) 2, 8, 12, 13, 14, 11, 10

**FORCES.** (lb) - Max. Comp./Max. Ten. - All forces 250 (lb) or less except when shown.

**NOTES-**

- Unbalanced roof live loads have been considered for this design.
- Wind: ASCE 7-10; Vult=120mph Vasd=95mph; TCDL=6.0psf; BCDL=6.0psf; h=32ft; Cat. II; Exp B; Enclosed; MWFRS (envelope) gable end zone and C-C Corner(3) 0-6-0 to 2-8-0, Exterior(2) 2-8-0 to 6-8-0, Corner(3) 6-8-0 to 9-8-0, Exterior(2) 9-8-0 to 13-10-0 zone; cantilever left and right exposed ; end vertical left and right exposed;C-C for members and forces & MWFRS for reactions shown; Lumber DOL=1.60 plate grip DOL=1.60
- Truss designed for wind loads in the plane of the truss only. For studs exposed to wind (normal to the face), see Standard Industry Gable End Details as applicable, or consult qualified building designer as per ANSI/TPI 1.
- All plates are 2x4 MT20 unless otherwise indicated.
- Gable requires continuous bottom chord bearing.
- Gable studs spaced at 2-0-0 oc.
- This truss has been designed for a 10.0 psf bottom chord live load nonconcurrent with any other live loads.
- \* This truss has been designed for a live load of 20.0psf on the bottom chord in all areas where a rectangle 3-6-0 tall by 2-0-0 wide will fit between the bottom chord and any other members.
- Provide mechanical connection (by others) of truss to bearing plate capable of withstanding 100 lb uplift at joint(s) 2, 8, 13, 14, 11, 10.



June 6, 2023

**WARNING - Verify design parameters and READ NOTES ON THIS AND INCLUDED MITEK REFERENCE PAGE MII-7473 rev. 5/19/2020 BEFORE USE.**

Design valid for use only with MiTek® connectors. This design is based only upon parameters shown, and is for an individual building component, not a truss system. Before use, the building designer must verify the applicability of design parameters and properly incorporate this design into the overall building design. Bracing indicated is to prevent buckling of individual truss web and/or chord members only. Additional temporary and permanent bracing is always required for stability and to prevent collapse with possible personal injury and property damage. For general guidance regarding the fabrication, storage, delivery, erection and bracing of trusses and truss systems, see

**ANSI/TPI1 Quality Criteria, DSB-89 and BCSI Building Component**

**Safety Information** available from Truss Plate Institute, 2670 Crain Highway, Suite 203 Waldorf, MD 20601



818 Soundside Road  
Edenton, NC 27932

Job MASTER-120	Truss C02	Truss Type COMMON	Qty 1	Ply 1	DR Horton; Cali; 120; Master.RT Job Reference (optional)	158747616
-------------------	--------------	----------------------	----------	----------	---	-----------

Builders FirstSource (Apex, NC), Apex, NC - 27523,

8.430 s Jan 6 2022 MiTek Industries, Inc. Mon Jun 5 15:53:49 2023 Page 1

ID:GkdJTsrewC8FsrDZ9sGJOzzyZcn-RfC?PsB70Hq3NSgPqnL8w3uITXbGKWrCDoi7J4zJC?f



4x6 =

Scale = 1:25.7

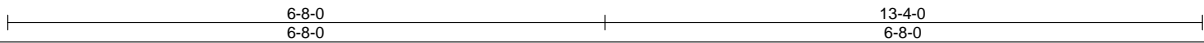
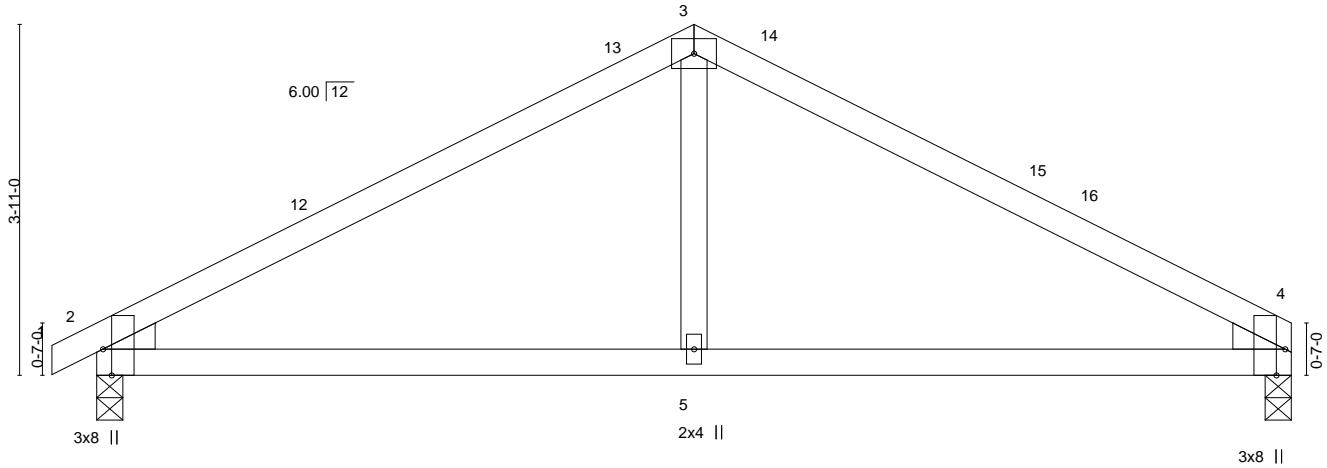

Plate Offsets (X, Y)--	[2:0-3-8,Edge], [4:0-3-8,Edge]				
<b>LOADING</b> (psf)	<b>SPACING-</b> 2-0-0	<b>CSI.</b>	<b>DEFL.</b> in (loc) l/defl L/d	<b>PLATES</b>	<b>GRIP</b>
TCLL 20.0	Plate Grip DOL 1.15	TC 0.53	Vert(LL) -0.06 5-11 >999 360	MT20	244/190
TCDL 10.0	Lumber DOL 1.15	BC 0.45	Vert(CT) -0.11 5-11 >999 240		
BCLL 0.0 *	Rep Stress Incr YES	WB 0.11	Horz(CT) 0.02 2 n/a n/a		
BCDL 10.0	Code IRC2015/TPI2014	Matrix-MS	Wind(LL) 0.06 5-11 >999 240	Weight: 50 lb	FT = 20%

<b>LUMBER-</b>	<b>BRACING-</b>
TOP CHORD 2x4 SP No.2	TOP CHORD Structural wood sheathing directly applied or 6-0-0 oc purlins.
BOT CHORD 2x4 SP No.2	BOT CHORD Rigid ceiling directly applied or 10-0-0 oc bracing.
WEBS 2x4 SP No.3	
WEDGE	
Left: 2x4 SP No.3 , Right: 2x4 SP No.3	

**REACTIONS.** (size) 2=0-3-8, 4=0-3-8  
 Max Horz 2=66(LC 16)  
 Max Uplift 2=-29(LC 12), 4=-21(LC 13)  
 Max Grav 2=564(LC 1), 4=533(LC 1)

**FORCES.** (lb) - Max. Comp./Max. Ten. - All forces 250 (lb) or less except when shown.  
 TOP CHORD 2-3=-714/119, 3-4=-714/122  
 BOT CHORD 2-5=-29/568, 4-5=-29/568  
 WEBS 3-5=0/294

- NOTES-**
- Unbalanced roof live loads have been considered for this design.
  - Wind: ASCE 7-10; Vult=120mph Vasd=95mph; TCDL=6.0psf; BCDL=6.0psf; h=32ft; Cat. II; Exp B; Enclosed; MWFRS (envelope) gable end zone and C-C Exterior(2) -0-6-0 to 2-6-0, Interior(1) 2-6-0 to 6-8-0, Exterior(2) 6-8-0 to 10-10-15, Interior(1) 10-10-15 to 13-4-0 zone; cantilever left and right exposed ; end vertical left and right exposed; C-C for members and forces & MWFRS for reactions shown; Lumber DOL=1.60 plate grip DOL=1.60
  - This truss has been designed for a 10.0 psf bottom chord live load nonconcurrent with any other live loads.
  - \* This truss has been designed for a live load of 20.0psf on the bottom chord in all areas where a rectangle 3-6-0 tall by 2-0-0 wide will fit between the bottom chord and any other members.
  - Provide mechanical connection (by others) of truss to bearing plate capable of withstanding 100 lb uplift at joint(s) 2, 4.

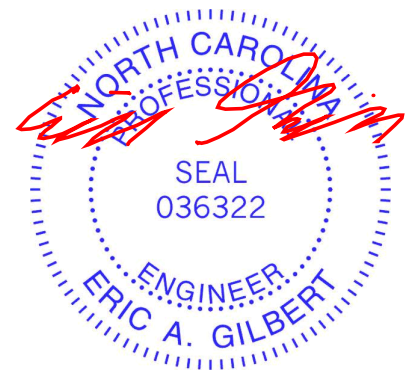

June 6, 2023

<p><b>WARNING - Verify design parameters and READ NOTES ON THIS AND INCLUDED MITEK REFERENCE PAGE MII-7473 rev. 5/19/2020 BEFORE USE.</b></p> <p>Design valid for use only with MiTek® connectors. This design is based only upon parameters shown, and is for an individual building component, not a truss system. Before use, the building designer must verify the applicability of design parameters and properly incorporate this design into the overall building design. Bracing indicated is to prevent buckling of individual truss web and/or chord members only. Additional temporary and permanent bracing is always required for stability and to prevent collapse with possible personal injury and property damage. For general guidance regarding the fabrication, storage, delivery, erection and bracing of trusses and truss systems, see <b>ANSI/TPI1 Quality Criteria, DSB-89 and BCSI Building Component Safety Information</b> available from Truss Plate Institute, 2670 Crain Highway, Suite 203 Waldorf, MD 20601</p>	<p>818 Soundside Road Edenton, NC 27932</p>
--	---

Job MASTER-120	Truss P01	Truss Type MONO TRUSS	Qty 1	Ply 1	DR Horton; Cali; 120; Master.RT 158747628
-------------------	--------------	--------------------------	----------	----------	--

Builders FirstSource (Apex, NC), Apex, NC - 27523, 8.430 s Jan 6 2022 MiTek Industries, Inc. Mon Jun 5 15:54:02 2023 Page 1

ID:GkdJTswreC8FsrDZ9sGJOzyyZcn-RfC?PsB70Hq3NSgPqnL8w3uITXbGKWrCDoi7J4zJC?f

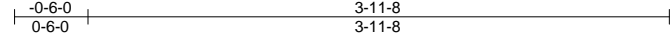

Scale = 1:15.7

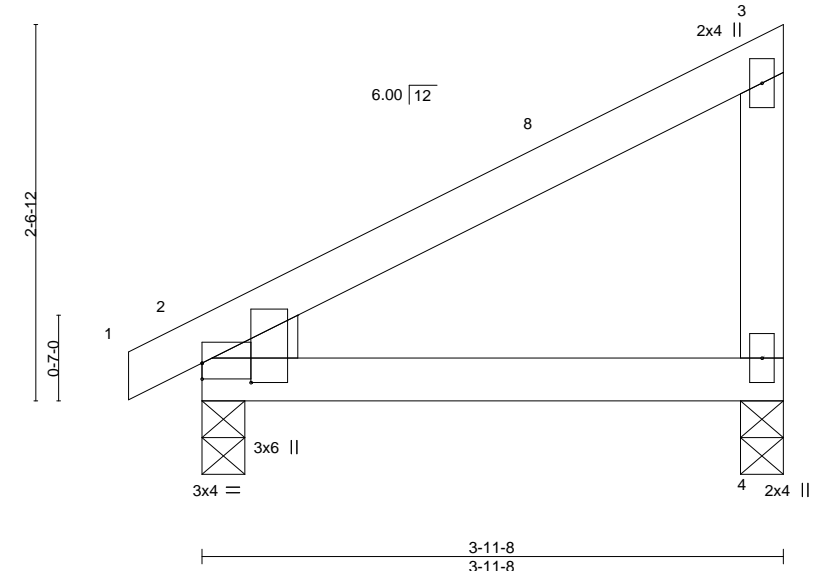

Plate Offsets (X,Y)--	[2:0-0-0,0-1-5], [2:0-1-9,0-4-0]
-----------------------	----------------------------------

LOADING (psf)	SPACING-	CSI.	DEFL.	in (loc)	l/defl	L/d	PLATES	GRIP
TCLL 20.0	Plate Grip DOL 1.15	TC 0.20	Vert(LL)	-0.01	4-7	>999	MT20	244/190
TCDL 10.0	Lumber DOL 1.15	BC 0.17	Vert(CT)	-0.02	4-7	>999		
BCLL 0.0 *	Rep Stress Incr YES	WB 0.00	Horz(CT)	0.01	2	n/a		
BCDL 10.0	Code IRC2015/TPI2014	Matrix-MP	Wind(LL)	0.01	4-7	>999		
							Weight: 17 lb	FT = 20%

LUMBER-	BRACING-
TOP CHORD 2x4 SP No.2	TOP CHORD Structural wood sheathing directly applied or 3-11-8 oc purlins, except end verticals.
BOT CHORD 2x4 SP No.2	BOT CHORD Rigid ceiling directly applied or 10-0-0 oc bracing.
WEBS 2x4 SP No.3	
WEDGE	
Left: 2x4 SP No.3	

**REACTIONS.** (size) 2=0-3-8, 4=0-3-8  
 Max Horz 2=76(LC 11)  
 Max Uplift 2=-16(LC 12), 4=-28(LC 12)  
 Max Grav 2=184(LC 1), 4=151(LC 1)

**FORCES.** (lb) - Max. Comp./Max. Ten. - All forces 250 (lb) or less except when shown.

- NOTES-**
- 1) Wind: ASCE 7-10; Vult=120mph Vasd=95mph; TCDL=6.0psf; BCDL=6.0psf; h=32ft; Cat. II; Exp B; Enclosed; MWFRS (envelope) gable end zone and C-C Exterior(2) -0-6-0 to 2-6-0, Interior(1) 2-6-0 to 3-9-12 zone; cantilever left and right exposed ; end vertical left and right exposed;C-C for members and forces & MWFRS for reactions shown; Lumber DOL=1.60 plate grip DOL=1.60
  - 2) This truss has been designed for a 10.0 psf bottom chord live load nonconcurrent with any other live loads.
  - 3) \* This truss has been designed for a live load of 20.0psf on the bottom chord in all areas where a rectangle 3-6-0 tall by 2-0-0 wide will fit between the bottom chord and any other members.
  - 4) Provide mechanical connection (by others) of truss to bearing plate capable of withstanding 100 lb uplift at joint(s) 2, 4.

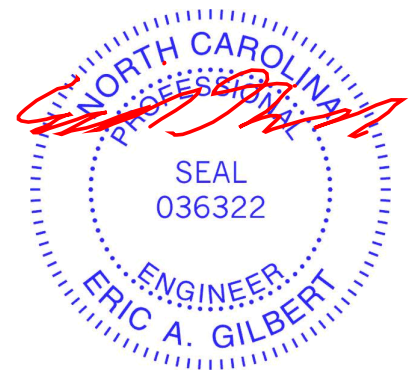

# Symbols

## PLATE LOCATION AND ORIENTATION



Center plate on joint unless x, y offsets are indicated. Dimensions are in ft-in-sixteenths. Apply plates to both sides of truss and fully embed teeth.



For 4 x 2 orientation, locate plates 0- 1/16" from outside edge of truss.



This symbol indicates the required direction of slots in connector plates.

\* Plate location details available in **MiTek 20/20 software** or upon request.

## PLATE SIZE

**4 X 4**

The first dimension is the plate width measured perpendicular to slots. Second dimension is the length parallel to slots.

## LATERAL BRACING LOCATION

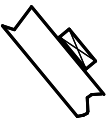

Indicated by symbol shown and/or by text in the bracing section of the output. Use T or I bracing if indicated.

## BEARING

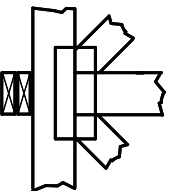

Indicates location where bearings (supports) occur. Icons vary but reaction section indicates joint number where bearings occur. Min size shown is for crushing only.

### Industry Standards:

ANSI/TP1: National Design Specification for Metal Plate Connected Wood Truss Construction.  
DSB-89: Design Standard for Bracing, Building Component Safety Information, Guide to Good Practice for Handling, Installing & Bracing of Metal Plate  
Connected Wood Trusses.

# Numbering System

6-4-8  
dimensions shown in ft-in-sixteenths  
(Drawings not to scale)

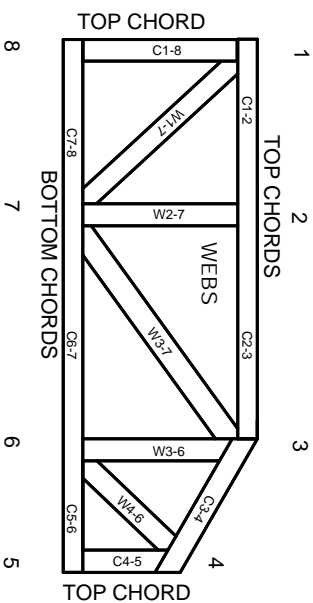

**JOINTS ARE GENERALLY NUMBERED/LETTERED CLOCKWISE AROUND THE TRUSS STARTING AT THE JOINT FARTHEST TO THE LEFT.**

**CHORDS AND WEBS ARE IDENTIFIED BY END JOINT NUMBERS/LETTERS.**

## PRODUCT CODE APPROVALS

ICC-ES Reports:

ESR-1311, ESR-1352, ESR1988  
ER-3907, ESR-2362, ESR-1397, ESR-3282

Trusses are designed for wind loads in the plane of the truss unless otherwise shown.

Lumber design values are in accordance with ANSI/TP1 section 6.3 These truss designs rely on lumber values established by others.

© 2012 MITTEK® All Rights Reserved



MiTek Engineering Reference Sheet: MI1-7473 rev. 5/19/2020



# General Safety Notes

## Failure to Follow Could Cause Property Damage or Personal Injury

1. Additional stability bracing for truss system, e.g. diagonal or X-bracing, is always required. See BCSI.
2. Truss bracing must be designed by an engineer. For wide truss spacing, individual lateral braces themselves may require bracing, or alternative Tor I bracing should be considered.
3. Never exceed the design loading shown and never stack materials on inadequately braced trusses.
4. Provide copies of this truss design to the building designer, erection supervisor, property owner and all other interested parties.
5. Cut members to bear tightly against each other.
6. Place plates on each face of truss at each joint and embed fully. Knots and wane at joint locations are regulated by ANSI/TP1 1.
7. Design assumes trusses will be suitably protected from the environment in accord with ANSI/TP1 1.
8. Unless otherwise noted, moisture content of lumber shall not exceed 19% at time of fabrication.
9. Unless expressly noted, this design is not applicable for use with fire retardant, preservative treated, or green lumber.
10. Camber is a non-structural consideration and is the responsibility of truss fabricator. General practice is to camber for dead load deflection.
11. Plate type, size, orientation and location dimensions indicated are minimum plating requirements.
12. Lumber used shall be of the species and size, and in all respects, equal to or better than that specified.
13. Top chords must be sheathed or purlins provided at spacing indicated on design.
14. Bottom chords require lateral bracing at 10 ft. spacing, or less, if no ceiling is installed, unless otherwise noted.
15. Connections not shown are the responsibility of others.
16. Do not cut or alter truss member or plate without prior approval of an engineer.
17. Install and load vertically unless indicated otherwise.
18. Use of green or treated lumber may pose unacceptable environmental, health or performance risks. Consult with project engineer before use.
19. Review all portions of this design (front, back, words and pictures) before use. Reviewing pictures alone is not sufficient.
20. Design assumes manufacture in accordance with ANSI/TP1 1 Quality Criteria.
21. The design does not take into account any dynamic or other loads other than those expressly stated.