

Trenco
818 Soundside Rd
Edenton, NC 27932

Re: FNC104-F
Chesapeake-6260A:Lot104 FarmNeillsCreek

The truss drawing(s) referenced below have been prepared by Truss Engineering Co. under my direct supervision based on the parameters provided by Builders FirstSource-Apex,NC.

Pages or sheets covered by this seal: I57280872 thru I57280888

My license renewal date for the state of North Carolina is December 31, 2023.

North Carolina COA: C-0844



March 21,2023

Gilbert, Eric

IMPORTANT NOTE: The seal on these truss component designs is a certification that the engineer named is licensed in the jurisdiction(s) identified and that the designs comply with ANSI/TPI 1. These designs are based upon parameters shown (e.g., loads, supports, dimensions, shapes and design codes), which were given to MiTek or TRENCO. Any project specific information included is for MiTek's or TRENCO's customers file reference purpose only, and was not taken into account in the preparation of these designs. MiTek or TRENCO has not independently verified the applicability of the design parameters or the designs for any particular building. Before use, the building designer should verify applicability of design parameters and properly incorporate these designs into the overall building design per ANSI/TPI 1, Chapter 2.

Job	Truss	Truss Type	Qty	Ply	Chesapeake-6260A:Lot104 FarmNeillsCreek
FNC104-F	F01G	GABLE	1	1	I57280872
					Job Reference (optional)

Builders FirstSource (Apex, NC), Apex, NC - 27523,

8.630 s Nov 19 2022 MiTek Industries, Inc. Mon Mar 20 15:58:01 2023 Page 1
ID:hazSNSvRlgjAW5liYCphTxyvdPZ-1oOg?OqrfVSXynZVy0pAR6Ycf6B7czA?8uyW83zZ_ya

0-1-8

0-1-8

Scale = 1:33.1

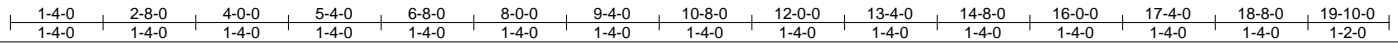
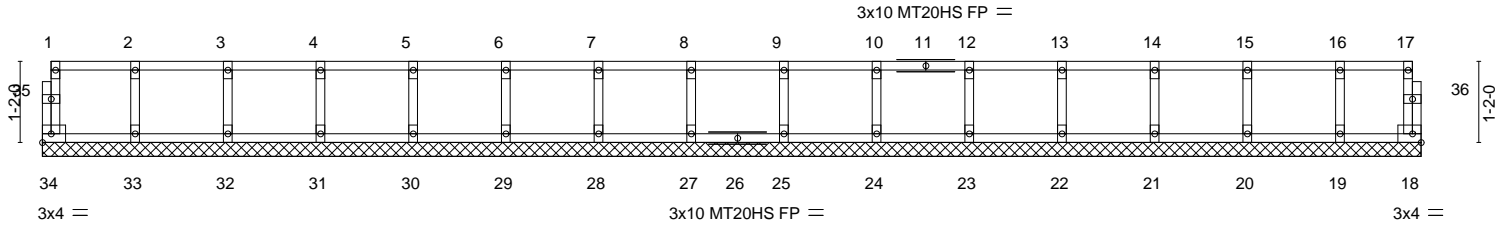

LOADING (psf)	SPACING-	2-0-0	CSI.	DEFL.	in (loc)	l/defl	L/d	PLATES	GRIP
TCLL 40.0	Plate Grip DOL	1.00	TC 0.09	Vert(LL)	n/a	-	n/a	MT20	244/190
TCDL 10.0	Lumber DOL	1.00	BC 0.01	Vert(CT)	n/a	-	n/a	MT20HS	187/143
BCLL 0.0	Rep Stress Incr	NO	WB 0.03	Horz(CT)	0.00	18	n/a		
BCDL 5.0	Code IRC2015/TPI2014		Matrix-R						
								Weight: 83 lb	FT = 20%F, 11%E

LUMBER-	BRACING-
TOP CHORD 2x4 SP No.2(flat)	TOP CHORD Structural wood sheathing directly applied or 6-0-0 oc purlins, except end verticals.
BOT CHORD 2x4 SP No.2(flat)	BOT CHORD Rigid ceiling directly applied or 10-0-0 oc bracing.
WEBS 2x4 SP No.3(flat)	
OTHERS 2x4 SP No.3(flat)	

REACTIONS. All bearings 19-10-0.
(lb) - Max Grav All reactions 250 lb or less at joint(s) 34, 18, 33, 32, 31, 30, 29, 28, 27, 25, 24, 23, 22, 21, 20, 19

FORCES. (lb) - Max. Comp./Max. Ten. - All forces 250 (lb) or less except when shown.

- NOTES-**
- All plates are MT20 plates unless otherwise indicated.
 - All plates are 1.5x3 MT20 unless otherwise indicated.
 - Gable requires continuous bottom chord bearing.
 - Truss to be fully sheathed from one face or securely braced against lateral movement (i.e. diagonal web).
 - Gable studs spaced at 1-4-0 oc.
 - Recommend 2x6 strongbacks, on edge, spaced at 10-0-0 oc and fastened to each truss with 3-10d (0.131" X 3") nails. Strongbacks to be attached to walls at their outer ends or restrained by other means.

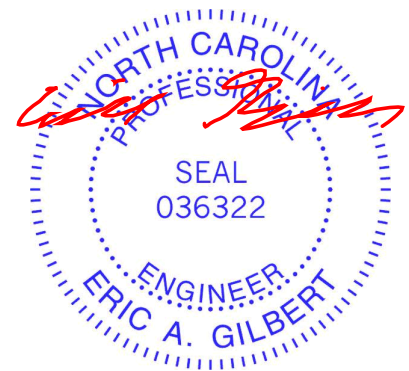

March 21, 2023

Job	Truss	Truss Type	Qty	Ply	Chesapeake-6260A:Lot104 FarmNeillsCreek
FNC104-F	F02	FLOOR	1	1	157280873

Builders FirstSource (Apex, NC), Apex, NC - 27523, 8.630 s Nov 19 2022 MiTek Industries, Inc. Mon Mar 20 15:58:02 2023 Page 1
 ID:hazSNSvRlgjAW5liYcPhTxyvdPZ-V_y2DkqTQpaNax8hVjKP_J5HsvLrLJU8NYh4gWzZ_yZ

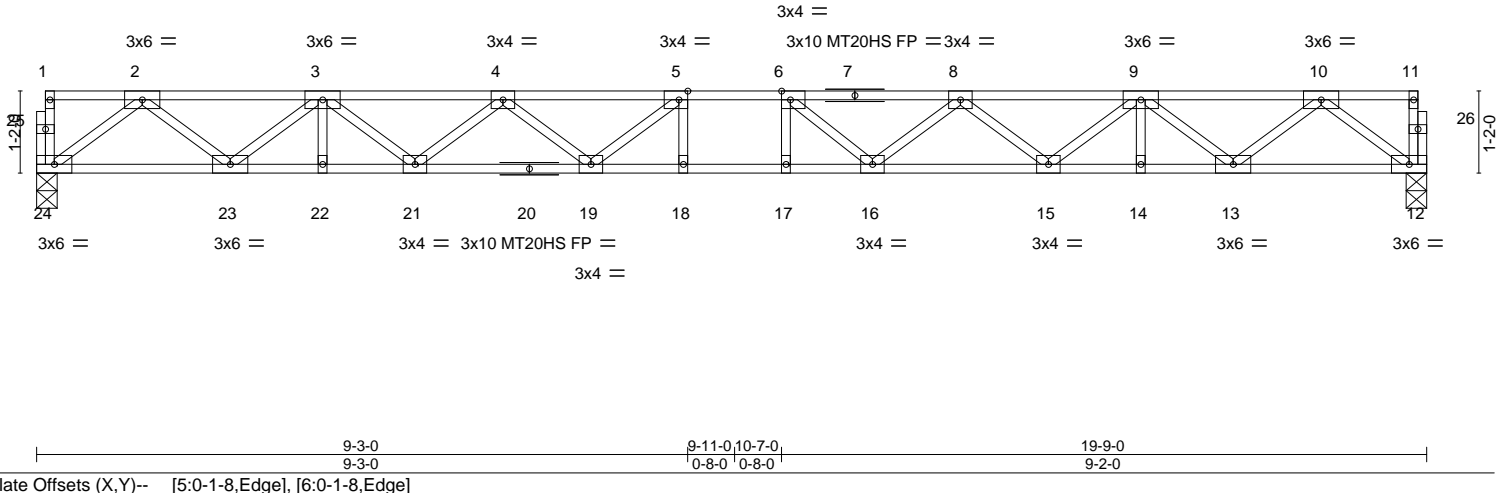
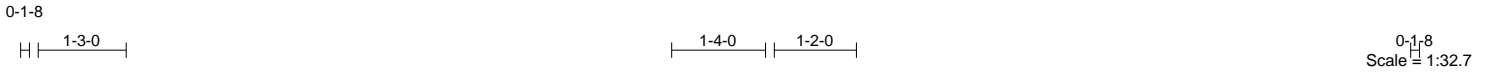

LOADING (psf)	SPACING-	1-7-3	CSI.	DEFL.	in (loc)	l/defl	L/d	PLATES	GRIP
TCLL 40.0	Plate Grip DOL	1.00	TC 0.47	Vert(LL)	-0.34 17-18	>697	480	MT20	244/190
TCDL 10.0	Lumber DOL	1.00	BC 0.81	Vert(CT)	-0.46 17-18	>507	360	MT20HS	187/143
BCLL 0.0	Rep Stress Incr	YES	WB 0.47	Horz(CT)	0.08 12	n/a	n/a		
BCDL 5.0	Code IRC2015/TP12014		Matrix-S						
								Weight: 101 lb	FT = 20%F, 11%E

LUMBER-	BRACING-
TOP CHORD 2x4 SP No.1(flat)	TOP CHORD Structural wood sheathing directly applied or 6-0-0 oc purlins, except end verticals.
BOT CHORD 2x4 SP No.1(flat)	BOT CHORD Rigid ceiling directly applied or 10-0-0 oc bracing.
WEBS 2x4 SP No.3(flat)	

REACTIONS. (size) 24=0-3-8, 12=0-3-8
 Max Grav 24=852(LC 1), 12=852(LC 1)

FORCES. (lb) - Max. Comp./Max. Ten. - All forces 250 (lb) or less except when shown.
 TOP CHORD 2-3=-1840/0, 3-4=-3127/0, 4-5=-3802/0, 5-6=-3998/0, 6-8=-3804/0, 8-9=-3126/0, 9-10=-1840/0
 BOT CHORD 23-24=0/1075, 22-23=0/2615, 21-22=0/2615, 19-21=0/3592, 18-19=0/3998, 17-18=0/3998, 16-17=0/3998, 15-16=0/3589, 14-15=0/2616, 13-14=0/2616, 12-13=0/1074
 WEBS 2-24=-1346/0, 2-23=0/996, 3-23=-990/0, 3-21=0/653, 4-21=-605/0, 4-19=0/388, 5-19=-475/85, 10-12=-1346/0, 10-13=0/997, 9-13=-991/0, 9-15=0/652, 8-15=-603/0, 8-16=0/396, 6-16=-477/84

- NOTES-**
- 1) Unbalanced floor live loads have been considered for this design.
 - 2) All plates are MT20 plates unless otherwise indicated.
 - 3) All plates are 1.5x3 MT20 unless otherwise indicated.
 - 4) Recommend 2x6 strongbacks, on edge, spaced at 10-0-0 oc and fastened to each truss with 3-10d (0.131" X 3") nails. Strongbacks to be attached to walls at their outer ends or restrained by other means.

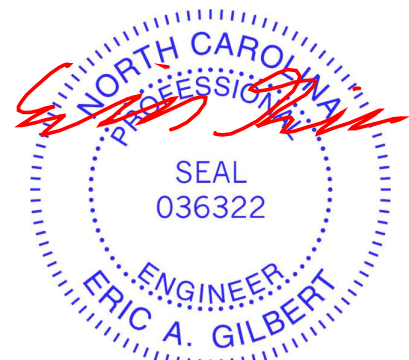

Job	Truss	Truss Type	Qty	Ply	Chesapeake-6260A:Lot104 FarmNeillsCreek	I57280874
FNC104-F	F03	FLOOR	1	1	Job Reference (optional)	

Builders FirstSource (Apex, NC),

Apex, NC - 27523,

8.630 s Nov 19 2022 MiTek Industries, Inc. Mon Mar 20 15:58:03 2023 Page 1
ID:hazSNSvRlgjAW5liYCphTxyvdPZ-zBWQQ4r5A6iEB5jt3RreWXdSAvg44mjlbcRdDyz_yY

0-1-8

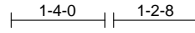
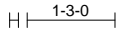

0-1-8
Scale = 1:32.8

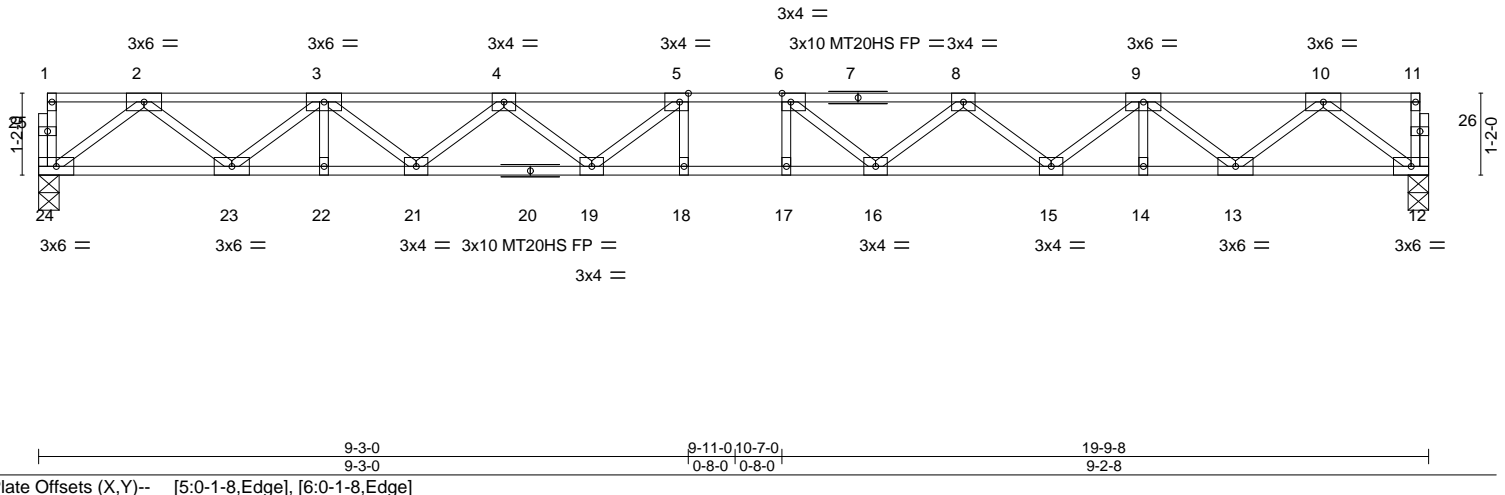

Plate Offsets (X,Y)--	[5:0-1-8,Edge], [6:0-1-8,Edge]						
LOADING (psf)	SPACING- 1-7-3	CSI.	DEFL. in (loc) l/defl L/d	PLATES	GRIP		
TCLL 40.0	Plate Grip DOL 1.00	TC 0.47	Vert(LL) -0.34 17-18 >693 480	MT20	244/190		
TCDL 10.0	Lumber DOL 1.00	BC 0.81	Vert(CT) -0.47 17-18 >504 360	MT20HS	187/143		
BCLL 0.0	Rep Stress Incr YES	WB 0.48	Horz(CT) 0.08 12 n/a n/a			Weight: 101 lb	FT = 20%F, 11%E
BCDL 5.0	Code IRC2015/TP12014	Matrix-S					

LUMBER-		BRACING-	
TOP CHORD 2x4 SP No.1(flat)		TOP CHORD	Structural wood sheathing directly applied or 6-0-0 oc purlins, except end verticals.
BOT CHORD 2x4 SP No.1(flat)		BOT CHORD	Rigid ceiling directly applied or 10-0-0 oc bracing.
WEBS 2x4 SP No.3(flat)			

REACTIONS. (size) 24=0-3-8, 12=0-3-8
Max Grav 24=854(LC 1), 12=854(LC 1)

FORCES. (lb) - Max. Comp./Max. Ten. - All forces 250 (lb) or less except when shown.

TOP CHORD 2-3=-1844/0, 3-4=-3136/0, 4-5=-3815/0, 5-6=-4015/0, 6-8=-3816/0, 8-9=-3136/0, 9-10=-1845/0

BOT CHORD 23-24=0/1077, 22-23=0/2622, 21-22=0/2622, 19-21=0/3603, 18-19=0/4015, 17-18=0/4015, 16-17=0/4015, 15-16=0/3602, 14-15=0/2623, 13-14=0/2623, 12-13=0/1077

WEBS 2-24=-1349/0, 2-23=0/999, 3-23=-993/0, 3-21=0/656, 4-21=-608/0, 4-19=0/391, 5-19=-480/84, 10-12=-1349/0, 10-13=0/999, 9-13=-993/0, 9-15=0/655, 8-15=-606/0, 8-16=0/395, 6-16=-481/83

- NOTES-**
- 1) Unbalanced floor live loads have been considered for this design.
 - 2) All plates are MT20 plates unless otherwise indicated.
 - 3) All plates are 1.5x3 MT20 unless otherwise indicated.
 - 4) Recommend 2x6 strongbacks, on edge, spaced at 10-0-0 oc and fastened to each truss with 3-10d (0.131" X 3") nails. Strongbacks to be attached to walls at their outer ends or restrained by other means.

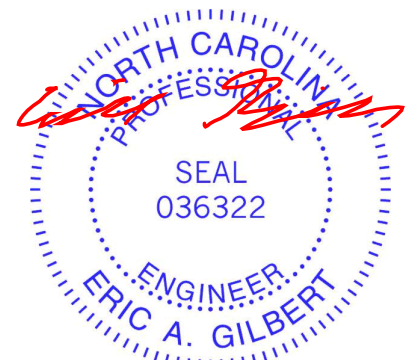

March 21, 2023

<p>WARNING - Verify design parameters and READ NOTES ON THIS AND INCLUDED MITEK REFERENCE PAGE MII-7473 rev. 5/19/2020 BEFORE USE.</p> <p>Design valid for use only with MiTek® connectors. This design is based only upon parameters shown, and is for an individual building component, not a truss system. Before use, the building designer must verify the applicability of design parameters and properly incorporate this design into the overall building design. Bracing indicated is to prevent buckling of individual truss web and/or chord members only. Additional temporary and permanent bracing is always required for stability and to prevent collapse with possible personal injury and property damage. For general guidance regarding the fabrication, storage, delivery, erection and bracing of trusses and truss systems, see ANSI/TPI1 Quality Criteria, DSB-89 and BCSI Building Component Safety Information available from Truss Plate Institute, 2670 Crain Highway, Suite 203 Waldorf, MD 20601</p>	<p>ENGINEERING BY</p> <p>TRENCO</p> <p>A MiTek Affiliate</p> <p>818 Soundside Road Edenton, NC 27932</p>
--	---

Job	Truss	Truss Type	Qty	Ply	Chesapeake-6260A:Lot104 FarmNeillsCreek
FNC104-F	F05G	GABLE	1	1	I57280875
					Job Reference (optional)

Builders FirstSource (Apex, NC), Apex, NC - 27523,

8.630 s Nov 19 2022 MiTek Industries, Inc. Mon Mar 20 15:58:04 2023 Page 1
ID:hazSNSvRlgjAW5liYcPhTxvyvdPZ-RN4odQsjxQq5pEH4d8Mt3kAjrJCjpKvRqsABIOzZ_yX

0,1,8

Scale = 1:20.1

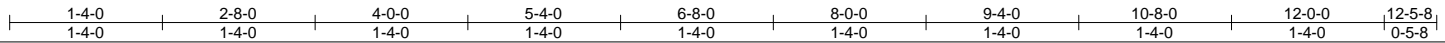
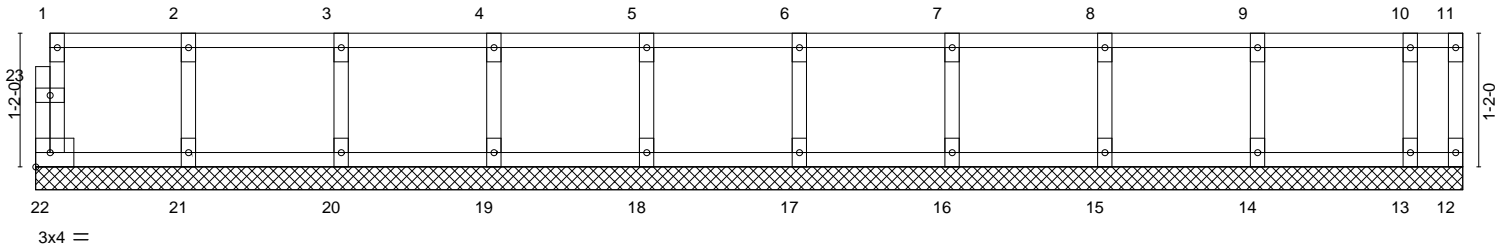

LOADING (psf)	SPACING-	2-0-0	CSI.	DEFL.	in (loc)	l/defl	L/d	PLATES	GRIP	
TCLL 40.0	Plate Grip DOL	1.00	TC 0.09	Vert(LL)	n/a	-	n/a	999	MT20	244/190
TCDL 10.0	Lumber DOL	1.00	BC 0.02	Vert(CT)	n/a	-	n/a	999		
BCLL 0.0	Rep Stress Incr	NO	WB 0.03	Horz(CT)	0.00	12	n/a	n/a		
BCDL 5.0	Code IRC2015/TPI2014		Matrix-R							
									Weight: 53 lb	FT = 20%F, 11%E

LUMBER-
TOP CHORD 2x4 SP No.2(flat)
BOT CHORD 2x4 SP No.2(flat)
WEBS 2x4 SP No.3(flat)
OTHERS 2x4 SP No.3(flat)

BRACING-
TOP CHORD Structural wood sheathing directly applied or 6-0-0 oc purlins, except end verticals.
BOT CHORD Rigid ceiling directly applied or 10-0-0 oc bracing.

REACTIONS. All bearings 12-5-8.
(lb) - Max Grav All reactions 250 lb or less at joint(s) 22, 12, 21, 20, 19, 18, 17, 16, 15, 14, 13

FORCES. (lb) - Max. Comp./Max. Ten. - All forces 250 (lb) or less except when shown.

- NOTES-**
- 1) All plates are 1.5x3 MT20 unless otherwise indicated.
 - 2) Gable requires continuous bottom chord bearing.
 - 3) Truss to be fully sheathed from one face or securely braced against lateral movement (i.e. diagonal web).
 - 4) Gable studs spaced at 1-4-0 oc.
 - 5) Recommend 2x6 strongbacks, on edge, spaced at 10-0-0 oc and fastened to each truss with 3-10d (0.131" X 3") nails. Strongbacks to be attached to walls at their outer ends or restrained by other means.
 - 6) CAUTION, Do not erect truss backwards.

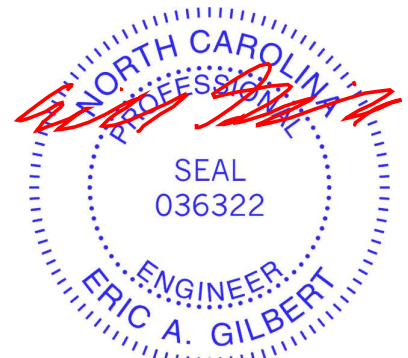

March 21, 2023

WARNING - Verify design parameters and READ NOTES ON THIS AND INCLUDED MITEK REFERENCE PAGE MII-7473 rev. 5/19/2020 BEFORE USE.
Design valid for use only with MiTek® connectors. This design is based only upon parameters shown, and is for an individual building component, not a truss system. Before use, the building designer must verify the applicability of design parameters and properly incorporate this design into the overall building design. Bracing indicated is to prevent buckling of individual truss web and/or chord members only. Additional temporary and permanent bracing is always required for stability and to prevent collapse with possible personal injury and property damage. For general guidance regarding the fabrication, storage, delivery, erection and bracing of trusses and truss systems, see **ANSI/TPI1 Quality Criteria, DSB-89 and BCSI Building Component Safety Information** available from Truss Plate Institute, 2670 Crain Highway, Suite 203 Waldorf, MD 20601



818 Soundside Road
Edenton, NC 27932

Job	Truss	Truss Type	Qty	Ply	Chesapeake-6260A:Lot104 FarmNeillsCreek	157280876
FNC104-F	F06	FLOOR	1	1	Job Reference (optional)	

Builders FirstSource (Apex, NC),

Apex, NC - 27523,

8.630 s Nov 19 2022 MiTek Industries, Inc. Mon Mar 20 15:58:05 2023 Page 1

ID:hazSNSvRlgiAW5liYCPHxyvdPZ-vZeArmtLikyyROsGBrt6byjppjP6Yj3b3WwkHrzZ_yW

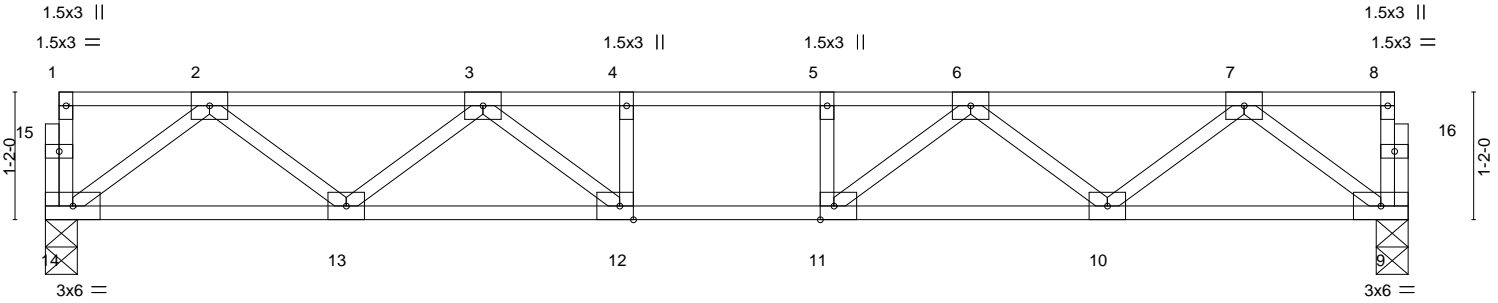
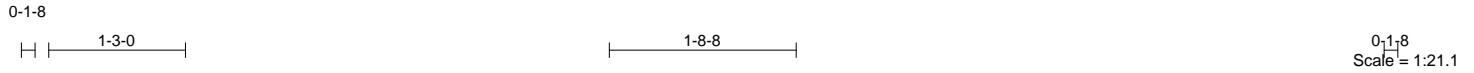

Plate Offsets (X, Y)--	[11:0-1-8,Edge], [12:0-1-8,Edge]						
LOADING (psf)	SPACING- 2-0-0	CSI.	DEFL. in (loc) l/defl L/d	PLATES	GRIP		
TCLL 40.0	Plate Grip DOL 1.00	TC 0.40	Vert(LL) -0.09 12-13 >999 480	MT20	244/190		
TCDL 10.0	Lumber DOL 1.00	BC 0.58	Vert(CT) -0.12 12-13 >999 360				
BCLL 0.0	Rep Stress Incr YES	WB 0.29	Horz(CT) 0.03 9 n/a n/a				
BCDL 5.0	Code IRC2015/TPI2014	Matrix-S					
						Weight: 63 lb	FT = 20%F, 11%E

LUMBER-		BRACING-	
TOP CHORD 2x4 SP No.2(flat)		TOP CHORD	Structural wood sheathing directly applied or 6-0-0 oc purlins, except end verticals.
BOT CHORD 2x4 SP No.2(flat)		BOT CHORD	Rigid ceiling directly applied or 10-0-0 oc bracing.
WEBS 2x4 SP No.3(flat)			

REACTIONS. (size) 14=0-3-8, 9=0-3-8
Max Grav 14=665(LC 1), 9=665(LC 1)

FORCES. (lb) - Max. Comp./Max. Ten. - All forces 250 (lb) or less except when shown.
TOP CHORD 2-3=-1294/0, 3-4=-1934/0, 4-5=-1934/0, 5-6=-1934/0, 6-7=-1294/0
BOT CHORD 13-14=0/820, 12-13=0/1732, 11-12=0/1934, 10-11=0/1732, 9-10=0/820
WEBS 7-9=-1026/0, 2-14=-1026/0, 7-10=0/616, 2-13=0/616, 6-10=-571/0, 3-13=-571/0, 6-11=0/453, 3-12=0/453

NOTES-
1) Unbalanced floor live loads have been considered for this design.
2) All plates are 3x4 MT20 unless otherwise indicated.
3) Recommend 2x6 strongbacks, on edge, spaced at 10-0-0 oc and fastened to each truss with 3-10d (0.131" X 3") nails. Strongbacks to be attached to walls at their outer ends or restrained by other means.

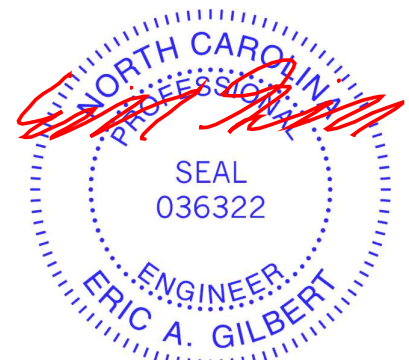

March 21, 2023

<p>WARNING - Verify design parameters and READ NOTES ON THIS AND INCLUDED MITEK REFERENCE PAGE MII-7473 rev. 5/19/2020 BEFORE USE. Design valid for use only with MiTek® connectors. This design is based only upon parameters shown, and is for an individual building component, not a truss system. Before use, the building designer must verify the applicability of design parameters and properly incorporate this design into the overall building design. Bracing indicated is to prevent buckling of individual truss web and/or chord members only. Additional temporary and permanent bracing is always required for stability and to prevent collapse with possible personal injury and property damage. For general guidance regarding the fabrication, storage, delivery, erection and bracing of trusses and truss systems, see ANSI/TPI1 Quality Criteria, DSB-89 and BCSI Building Component Safety Information available from Truss Plate Institute, 2670 Crain Highway, Suite 203 Waldorf, MD 20601</p>	<p>ENGINEERING BY TRENCO A MiTek Affiliate</p> <p>818 Soundside Road Edenton, NC 27932</p>
---	---

Job	Truss	Truss Type	Qty	Ply	Chesapeake-6260A:Lot104 FarmNeillsCreek
FNC104-F	F08G	GABLE	1	1	157280877
					Job Reference (optional)

Builders FirstSource (Apex, NC),

Apex, NC - 27523,

8.630 s Nov 19 2022 MiTek Industries, Inc. Mon Mar 20 15:58:06 2023 Page 1
 ID:hazSNSvRlgjAW5liYCPhtxyvdPZ-NICY25u_T14p2YRSkZPL89F3C7uJHENkHAFhHz_yV

Scale = 1:24.8

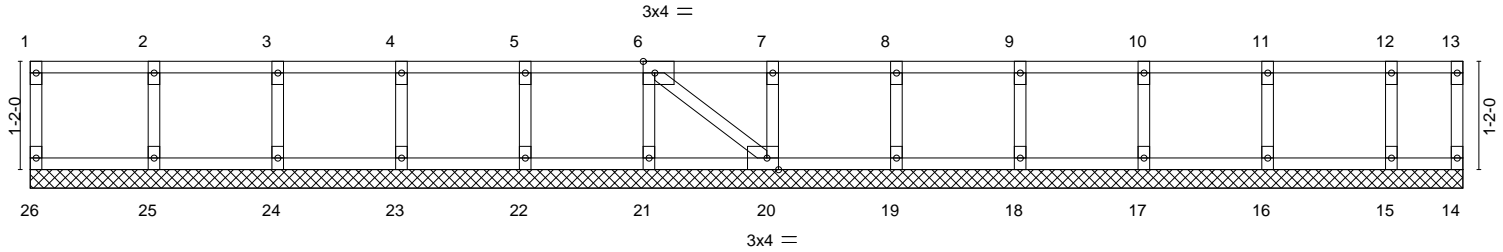

1-4-0	2-8-0	4-0-0	5-4-0	6-8-0	8-0-0	9-4-0	10-8-0	12-0-0	13-4-0	14-8-0	15-5-4
1-4-0	1-4-0	1-4-0	1-4-0	1-4-0	1-4-0	1-4-0	1-4-0	1-4-0	1-4-0	1-4-0	0-9-4
Plate Offsets (X, Y)-- [6:0-1-8,Edge], [20:0-1-8,Edge]											

LOADING (psf)	SPACING-	2-0-0	CSI.	DEFL.	in (loc)	l/defl	L/d	PLATES	GRIP
TCLL 40.0	Plate Grip DOL	1.00	TC 0.10	Vert(LL)	n/a	-	n/a	MT20	244/190
TCDL 10.0	Lumber DOL	1.00	BC 0.01	Vert(CT)	n/a	-	n/a		
BCLL 0.0	Rep Stress Incr	NO	WB 0.03	Horz(CT)	-0.00	20	n/a		
BCDL 5.0	Code IRC2015/TPI2014		Matrix-S						
								Weight: 66 lb	FT = 20%F, 11%E

LUMBER-
 TOP CHORD 2x4 SP No.2(flat)
 BOT CHORD 2x4 SP No.2(flat)
 WEBS 2x4 SP No.3(flat)
 OTHERS 2x4 SP No.3(flat)

BRACING-
 TOP CHORD Structural wood sheathing directly applied or 10-0-0 oc purlins, except end verticals.
 BOT CHORD Rigid ceiling directly applied or 10-0-0 oc bracing.

REACTIONS. All bearings 15-5-4.
 (lb) - Max Grav All reactions 250 lb or less at joint(s) 26, 14, 25, 24, 23, 22, 21, 20, 19, 18, 17, 16, 15

FORCES. (lb) - Max. Comp./Max. Ten. - All forces 250 (lb) or less except when shown.

- NOTES-**
- 1) All plates are 1.5x3 MT20 unless otherwise indicated.
 - 2) Gable requires continuous bottom chord bearing.
 - 3) Truss to be fully sheathed from one face or securely braced against lateral movement (i.e. diagonal web).
 - 4) Gable studs spaced at 1-4-0 oc.
 - 5) Recommend 2x6 strongbacks, on edge, spaced at 10-0-0 oc and fastened to each truss with 3-10d (0.131" X 3") nails. Strongbacks to be attached to walls at their outer ends or restrained by other means.

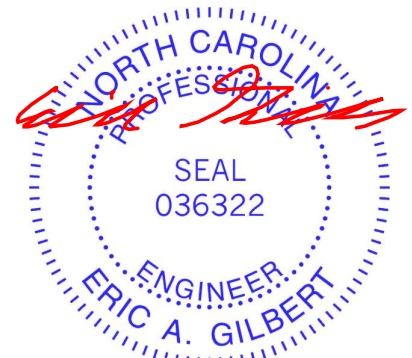

March 21, 2023

WARNING - Verify design parameters and READ NOTES ON THIS AND INCLUDED MITEK REFERENCE PAGE MII-7473 rev. 5/19/2020 BEFORE USE.
 Design valid for use only with MiTek® connectors. This design is based only upon parameters shown, and is for an individual building component, not a truss system. Before use, the building designer must verify the applicability of design parameters and properly incorporate this design into the overall building design. Bracing indicated is to prevent buckling of individual truss web and/or chord members only. Additional temporary and permanent bracing is always required for stability and to prevent collapse with possible personal injury and property damage. For general guidance regarding the fabrication, storage, delivery, erection and bracing of trusses and truss systems, see **ANSI/TPI1 Quality Criteria, DSB-89 and BCSI Building Component Safety Information** available from Truss Plate Institute, 2670 Crain Highway, Suite 203 Waldorf, MD 20601

ENGINEERING BY
TRENCO
 A MiTek Affiliate
 818 Soundside Road
 Edenton, NC 27932

Job	Truss	Truss Type	Qty	Ply	Chesapeake-6260A:Lot104 FarmNeillsCreek
FNC104-F	F09	FLOOR	1	1	157280878

Builders FirstSource (Apex, NC), Apex, NC - 27523,

8.630 s Nov 19 2022 MiTek Industries, Inc. Mon Mar 20 15:58:07 2023 Page 1
ID:hazSNSvRlgjAW5liYCphTxyvdPZ-symxGRucELDggi0elGwahNo73W3j0ahtWqPrMjzZ_yU

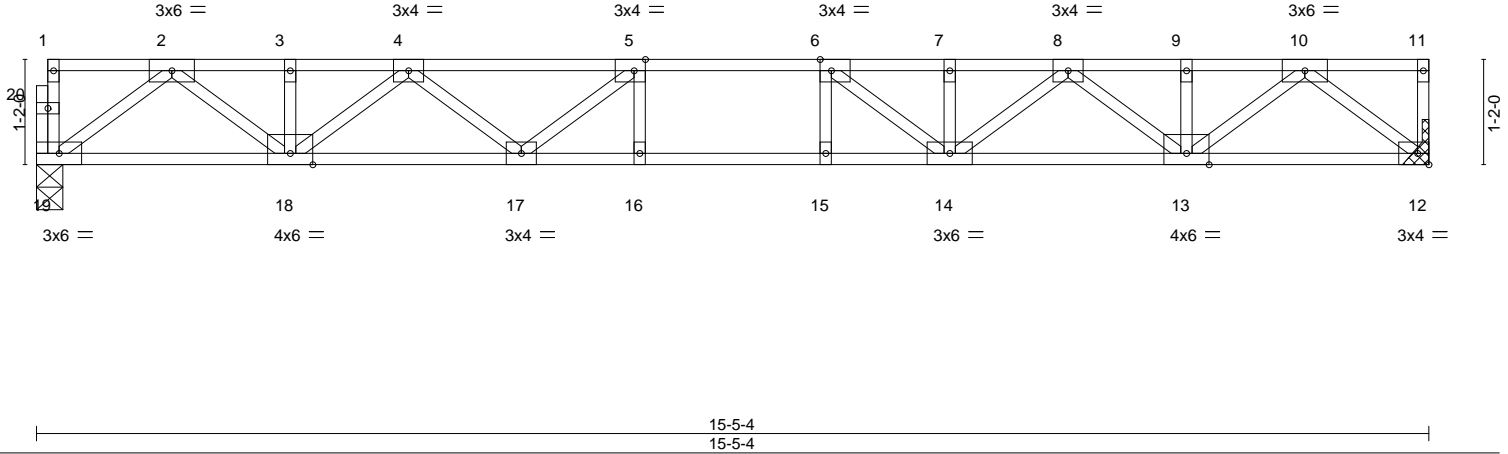
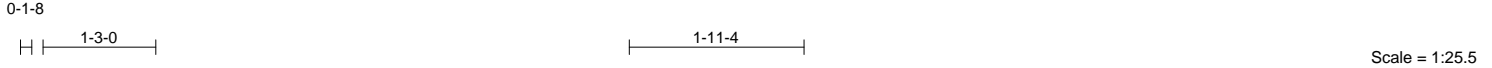

Plate Offsets (X,Y)--	[5:0-1-8,Edge], [6:0-1-8,Edge]	
LOADING (psf)	SPACING-	CSI.
TCLL 40.0	2-0-0	TC 0.54
TCDL 10.0	Plate Grip DOL 1.00	BC 0.77
BCLL 0.0	Lumber DOL 1.00	WB 0.48
BCDL 5.0	Rep Stress Incr YES	Matrix-S
	Code IRC2015/TPI2014	
		DEFL.
		in (loc) l/defl L/d
		Vert(LL) -0.17 15-16 >999 480
		Vert(CT) -0.24 15-16 >761 360
		Horz(CT) 0.05 12 n/a n/a
		PLATES
		MT20
		GRIP
		244/190
		Weight: 79 lb FT = 20%F, 11%E

LUMBER-	BRACING-
TOP CHORD 2x4 SP No.2(flat)	TOP CHORD Structural wood sheathing directly applied or 6-0-0 oc purlins, except end verticals.
BOT CHORD 2x4 SP No.1(flat)	BOT CHORD Rigid ceiling directly applied or 10-0-0 oc bracing.
WEBS 2x4 SP No.3(flat)	

REACTIONS. (size) 19=0-3-8, 12=Mechanical
Max Grav 19=833(LC 1), 12=839(LC 1)

FORCES. (lb) - Max. Comp./Max. Ten. - All forces 250 (lb) or less except when shown.
TOP CHORD 2-3=-1784/0, 3-4=-1784/0, 4-5=-2728/0, 5-6=-3037/0, 6-7=-2770/0, 7-8=-2770/0, 8-9=-1759/0, 9-10=-1759/0
BOT CHORD 18-19=0/1016, 17-18=0/2404, 16-17=0/3037, 15-16=0/3037, 14-15=0/3037, 13-14=0/2352, 12-13=0/974
WEBS 10-12=-1244/0, 2-19=-1270/0, 10-13=0/1002, 2-18=0/981, 8-13=-757/0, 4-18=-792/0, 8-14=0/533, 4-17=0/476, 6-14=-626/40, 5-17=-573/0

- NOTES-**
- 1) Unbalanced floor live loads have been considered for this design.
 - 2) All plates are 1.5x3 MT20 unless otherwise indicated.
 - 3) Refer to girder(s) for truss to truss connections.
 - 4) Recommend 2x6 strongbacks, on edge, spaced at 10-0-0 oc and fastened to each truss with 3-10d (0.131" X 3") nails. Strongbacks to be attached to walls at their outer ends or restrained by other means.
 - 5) CAUTION, Do not erect truss backwards.



March 21, 2023

<p>WARNING - Verify design parameters and READ NOTES ON THIS AND INCLUDED MITEK REFERENCE PAGE MII-7473 rev. 5/19/2020 BEFORE USE.</p> <p>Design valid for use only with MiTek® connectors. This design is based only upon parameters shown, and is for an individual building component, not a truss system. Before use, the building designer must verify the applicability of design parameters and properly incorporate this design into the overall building design. Bracing indicated is to prevent buckling of individual truss web and/or chord members only. Additional temporary and permanent bracing is always required for stability and to prevent collapse with possible personal injury and property damage. For general guidance regarding the fabrication, storage, delivery, erection and bracing of trusses and truss systems, see ANSI/TPI1 Quality Criteria, DSB-89 and BCSI Building Component Safety Information available from Truss Plate Institute, 2670 Crain Highway, Suite 203 Waldorf, MD 20601</p>	<p>ENGINEERING BY</p> <p>A MiTek Affiliate</p> <p>818 Soundside Road Edenton, NC 27932</p>
--	--

Job	Truss	Truss Type	Qty	Ply	Chesapeake-6260A:Lot104 FarmNeillsCreek
FNC104-F	F11	GABLE	1	1	157280879

Builders FirstSource (Apex, NC), Apex, NC - 27523,

8.630 s Nov 19 2022 MiTek Industries, Inc. Mon Mar 20 15:58:08 2023 Page 1
 ID:hazSNSvRlgjAW5liYCphTxyvdPZ-K8JJTnvE?lXlsbrs_RpDaLMHwZBI7t1IU8Ou9z_yT



Scale = 1:20.4

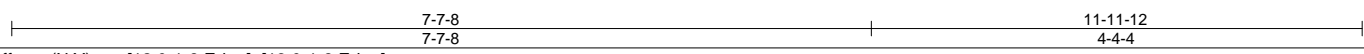
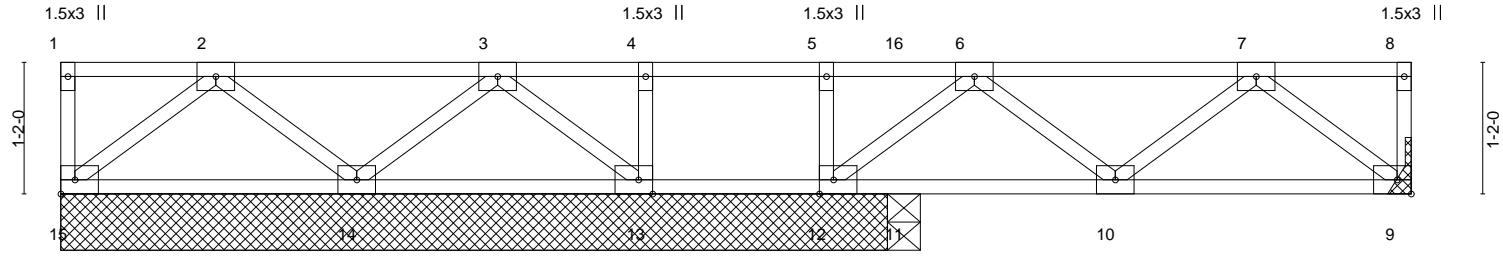

Plate Offsets (X, Y)--	[12:0-1-8,Edge], [13:0-1-8,Edge]						
LOADING (psf)	SPACING- 2-0-0	CSI.	DEFL. in (loc) l/defl L/d	PLATES	GRIP		
TCLL 40.0	Plate Grip DOL 1.00	TC 0.26	Vert(LL) -0.00 10 >999 480	MT20	244/190		
TCDL 10.0	Lumber DOL 1.00	BC 0.11	Vert(CT) -0.01 9-10 >999 360				
BCLL 0.0	Rep Stress Incr YES	WB 0.10	Horz(CT) 0.00 9 n/a n/a				
BCDL 5.0	Code IRC2015/TPI2014	Matrix-S				Weight: 60 lb	FT = 20%F, 11%E

LUMBER-		BRACING-	
TOP CHORD 2x4 SP No.2(flat)		TOP CHORD	Structural wood sheathing directly applied or 6-0-0 oc purlins, except end verticals.
BOT CHORD 2x4 SP No.2(flat)		BOT CHORD	Rigid ceiling directly applied or 6-0-0 oc bracing.
WEBS 2x4 SP No.3(flat)			

REACTIONS. All bearings 7-4-0 except (jt=length) 9=Mechanical, 11=0-3-8.
 (lb) - Max Grav All reactions 250 lb or less at joint(s) 15, 11 except 9=256(LC 4), 14=283(LC 3), 12=382(LC 1), 13=272(LC 5)

FORCES. (lb) - Max. Comp./Max. Ten. - All forces 250 (lb) or less except when shown.
 TOP CHORD 6-7=-253/0
 BOT CHORD 9-10=0/267
 WEBS 7-9=-341/0, 6-12=-407/0

- NOTES-**
- 1) Unbalanced floor live loads have been considered for this design.
 - 2) All plates are 3x4 MT20 unless otherwise indicated.
 - 3) Gable studs spaced at 1-4-0 oc.
 - 4) Refer to girder(s) for truss to truss connections.
 - 5) Recommend 2x6 strongbacks, on edge, spaced at 10-0-0 oc and fastened to each truss with 3-10d (0.131" X 3") nails. Strongbacks to be attached to walls at their outer ends or restrained by other means.

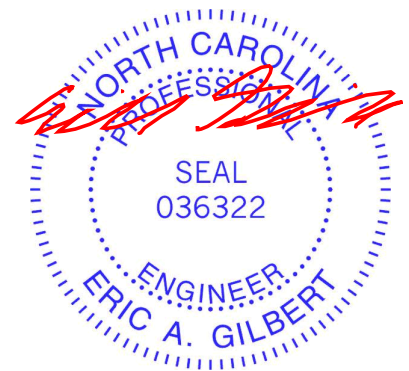

Job	Truss	Truss Type	Qty	Ply	Chesapeake-6260A:Lot104 FarmNeillsCreek	157280880
FNC104-F	F12G	GABLE	1	1	Job Reference (optional)	

Builders FirstSource (Apex, NC),

Apex, NC - 27523,

8.630 s Nov 19 2022 MiTek Industries, Inc. Mon Mar 20 15:58:08 2023 Page 1
ID:hazSNSvRlgjAW5liYCphTxyvdPZ-K8JJTnvE?fLXlsbrs_RpDaLPtwajl8u1IU8Ou9zZ_yT

0'-1-8"

0'-1-8"

Scale = 1:14.5

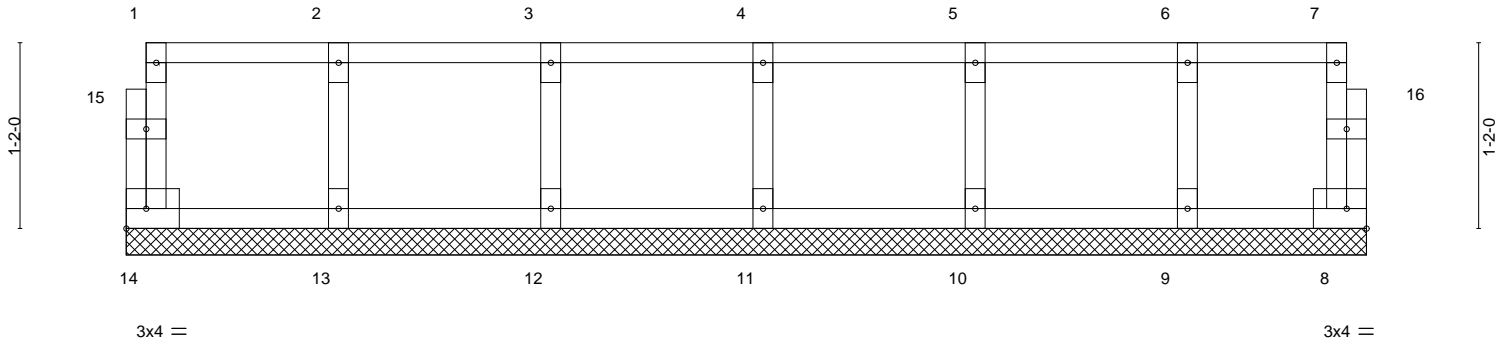

LOADING (psf)	SPACING-	CSI.	DEFL.	in (loc)	l/defl	L/d	PLATES	GRIP
TCLL 40.0	Plate Grip DOL 1.00	TC 0.09	Vert(LL)	n/a	-	n/a	MT20	244/190
TCDL 10.0	Lumber DOL 1.00	BC 0.01	Vert(CT)	n/a	-	n/a		
BCLL 0.0	Rep Stress Incr NO	WB 0.03	Horz(CT)	0.00	8	n/a		
BCDL 5.0	Code IRC2015/TPI2014	Matrix-R					Weight: 35 lb	FT = 20%F, 11%E

LUMBER-

TOP CHORD 2x4 SP No.2(flat)
BOT CHORD 2x4 SP No.2(flat)
WEBS 2x4 SP No.3(flat)
OTHERS 2x4 SP No.3(flat)

BRACING-

TOP CHORD Structural wood sheathing directly applied or 6-0-0 oc purlins, except end verticals.
BOT CHORD Rigid ceiling directly applied or 10-0-0 oc bracing.

REACTIONS. All bearings 7-9-8.

(lb) - Max Grav All reactions 250 lb or less at joint(s) 14, 8, 13, 12, 11, 10, 9

FORCES. (lb) - Max. Comp./Max. Ten. - All forces 250 (lb) or less except when shown.

NOTES-

- 1) All plates are 1.5x3 MT20 unless otherwise indicated.
- 2) Gable requires continuous bottom chord bearing.
- 3) Truss to be fully sheathed from one face or securely braced against lateral movement (i.e. diagonal web).
- 4) Gable studs spaced at 1-4-0 oc.
- 5) Recommend 2x6 strongbacks, on edge, spaced at 10-0-0 oc and fastened to each truss with 3-10d (0.131" X 3") nails. Strongbacks to be attached to walls at their outer ends or restrained by other means.

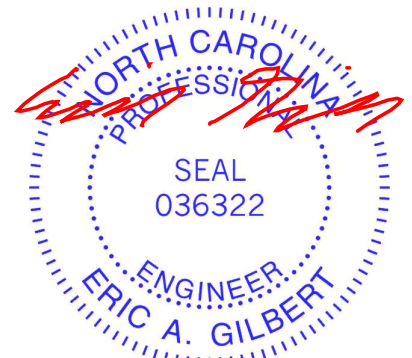

March 21, 2023

WARNING - Verify design parameters and READ NOTES ON THIS AND INCLUDED MITEK REFERENCE PAGE MII-7473 rev. 5/19/2020 BEFORE USE.

Design valid for use only with MiTek® connectors. This design is based only upon parameters shown, and is for an individual building component, not a truss system. Before use, the building designer must verify the applicability of design parameters and properly incorporate this design into the overall building design. Bracing indicated is to prevent buckling of individual truss web and/or chord members only. Additional temporary and permanent bracing is always required for stability and to prevent collapse with possible personal injury and property damage. For general guidance regarding the fabrication, storage, delivery, erection and bracing of trusses and truss systems, see **ANSI/TPI1 Quality Criteria, DSB-89 and BCSI Building Component**

Safety Information available from Truss Plate Institute, 2670 Crain Highway, Suite 203 Waldorf, MD 20601



818 Soundside Road
Edenton, NC 27932

Job	Truss	Truss Type	Qty	Ply	Chesapeake-6260A:Lot104 FarmNeillsCreek	157280881
FNC104-F	F13	FLOOR	1	1	Job Reference (optional)	

Builders FirstSource (Apex, NC), Apex, NC - 27523,

8.630 s Nov 19 2022 MiTek Industries, Inc. Mon Mar 20 15:58:09 2023 Page 1
ID:hazSNSvRlgjAW5liYCphTxyvdPZ-oKthh7wsmyTOv0A1Qhy2motWzKpeUZvA_8uxQczZ_yS

0-1-8



0-1-8
Scale = 1:14.5

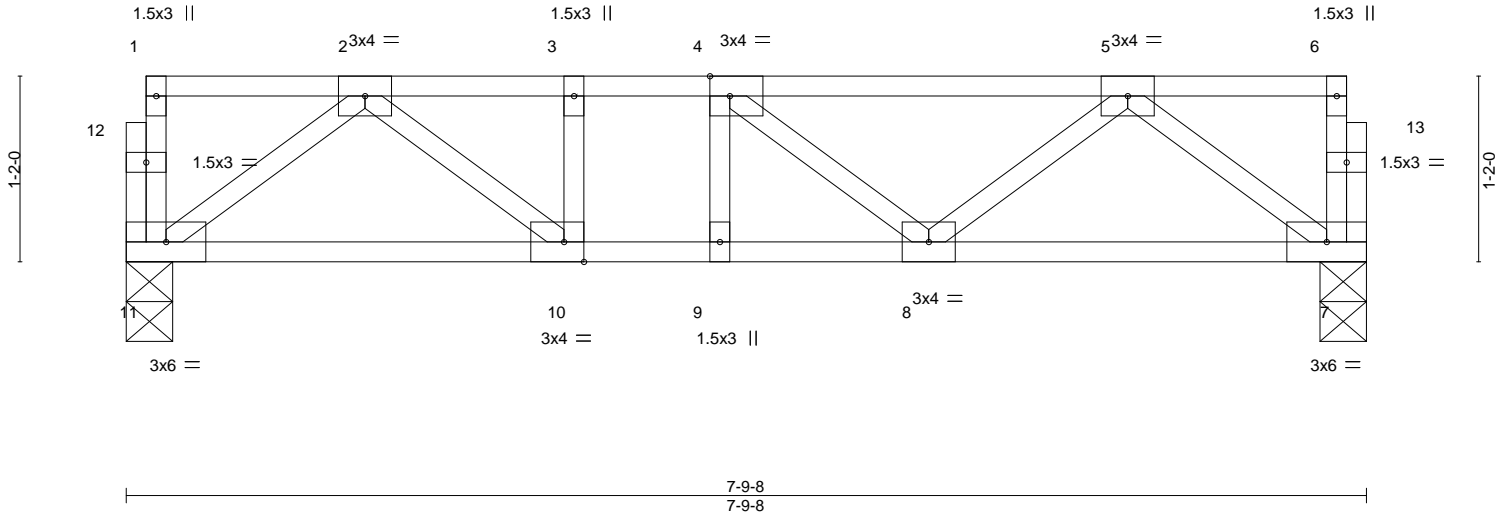

Plate Offsets (X,Y)--	[4:0-1-8,Edge], [10:0-1-8,Edge]				
LOADING (psf)	SPACING- 2-0-0	CSI.	DEFL. in (loc) l/defl L/d	PLATES	GRIP
TCLL 40.0	Plate Grip DOL 1.00	TC 0.32	Vert(LL) -0.03 8-9 >999 480	MT20	244/190
TCDL 10.0	Lumber DOL 1.00	BC 0.42	Vert(CT) -0.03 8-9 >999 360		
BCLL 0.0	Rep Stress Incr YES	WB 0.17	Horz(CT) 0.01 7 n/a n/a		
BCDL 5.0	Code IRC2015/TPI2014	Matrix-S		Weight: 42 lb	FT = 20%F, 11%E

LUMBER-	BRACING-
TOP CHORD 2x4 SP No.2(flat)	TOP CHORD Structural wood sheathing directly applied or 6-0-0 oc purlins, except end verticals.
BOT CHORD 2x4 SP No.2(flat)	BOT CHORD Rigid ceiling directly applied or 10-0-0 oc bracing.
WEBS 2x4 SP No.3(flat)	

REACTIONS. (size) 11=0-3-8, 7=0-3-8
Max Grav 11=409(LC 1), 7=409(LC 1)

FORCES. (lb) - Max. Comp./Max. Ten. - All forces 250 (lb) or less except when shown.
TOP CHORD 2-3=-738/0, 3-4=-738/0, 4-5=-647/0
BOT CHORD 10-11=0/461, 9-10=0/738, 8-9=0/738, 7-8=0/493
WEBS 5-7=-616/0, 2-11=-575/0, 2-10=0/366

NOTES-
1) Unbalanced floor live loads have been considered for this design.
2) Recommend 2x6 strongbacks, on edge, spaced at 10-0-0 oc and fastened to each truss with 3-10d (0.131" X 3") nails. Strongbacks to be attached to walls at their outer ends or restrained by other means.

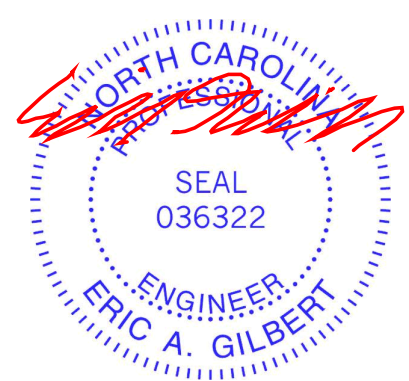

Job	Truss	Truss Type	Qty	Ply	Chesapeake-6260A:Lot104 FarmNeillsCreek	157280882
FNC104-F	F14	FLOOR	1	1	Job Reference (optional)	

Builders FirstSource (Apex, NC),

Apex, NC - 27523,

8.630 s Nov 19 2022 MiTek Industries, Inc. Mon Mar 20 15:58:10 2023 Page 1

ID:hazSNSvRlgjAW5liYcPhTxvvdPZ-GXR3uTxUXGbFX9IDzPTHI?QdPk3BDzOKCodVy2zZ_yR

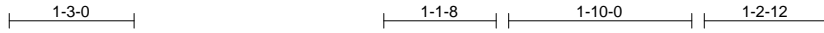

0,1,8

Scale = 1:23.1

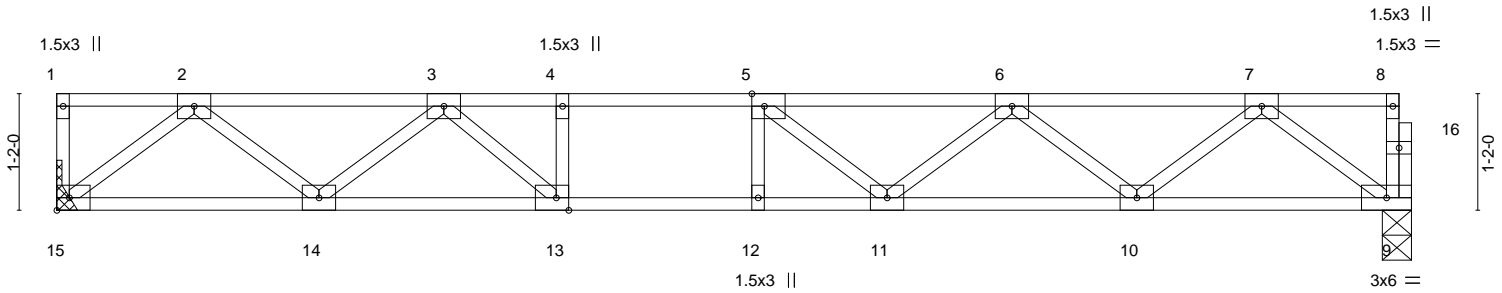

13-6-12
13-6-12

Plate Offsets (X,Y)-- [5:0-1-8,Edge], [13:0-1-8,Edge]

LOADING (psf)	SPACING-	2-0-0	CSI.	DEFL.	in (loc)	l/defl	L/d	PLATES	GRIP
TCLL 40.0	Plate Grip DOL	1.00	TC 0.60	Vert(LL)	-0.14 11-12	>999	480	MT20	244/190
TCDL 10.0	Lumber DOL	1.00	BC 0.78	Vert(CT)	-0.19 11-12	>824	360		
BCLL 0.0	Rep Stress Incr	YES	WB 0.35	Horz(CT)	0.03 9	n/a	n/a		
BCDL 5.0	Code IRC2015/TPI2014		Matrix-S						
								Weight: 67 lb	FT = 20%F, 11%E

LUMBER-
TOP CHORD 2x4 SP No.2(flat)
BOT CHORD 2x4 SP No.1(flat)
WEBS 2x4 SP No.3(flat)

BRACING-
TOP CHORD Structural wood sheathing directly applied or 6-0-0 oc purlins, except end verticals.
BOT CHORD Rigid ceiling directly applied or 10-0-0 oc bracing.

REACTIONS. (size) 9=0-3-8, 15=Mechanical
Max Grav 9=729(LC 1), 15=736(LC 1)

FORCES. (lb) - Max. Comp./Max. Ten. - All forces 250 (lb) or less except when shown.
TOP CHORD 2-3=-1415/0, 3-4=-2304/0, 4-5=-2304/0, 5-6=-2193/0, 6-7=-1461/0
BOT CHORD 14-15=0/867, 13-14=0/1961, 12-13=0/2304, 11-12=0/2304, 10-11=0/1999, 9-10=0/895
WEBS 4-13=-264/0, 2-15=-1107/0, 2-14=0/713, 3-14=-711/0, 3-13=0/627, 7-9=-1119/0,
7-10=0/737, 6-10=-701/0, 6-11=0/334, 5-11=-352/61

- NOTES-**
- 1) Unbalanced floor live loads have been considered for this design.
 - 2) All plates are 3x4 MT20 unless otherwise indicated.
 - 3) Refer to girder(s) for truss to truss connections.
 - 4) Recommend 2x6 strongbacks, on edge, spaced at 10-0-0 oc and fastened to each truss with 3-10d (0.131" X 3") nails. Strongbacks to be attached to walls at their outer ends or restrained by other means.
 - 5) CAUTION, Do not erect truss backwards.



March 21, 2023

WARNING - Verify design parameters and READ NOTES ON THIS AND INCLUDED MITEK REFERENCE PAGE MII-7473 rev. 5/19/2020 BEFORE USE.
Design valid for use only with MiTek® connectors. This design is based only upon parameters shown, and is for an individual building component, not a truss system. Before use, the building designer must verify the applicability of design parameters and properly incorporate this design into the overall building design. Bracing indicated is to prevent buckling of individual truss web and/or chord members only. Additional temporary and permanent bracing is always required for stability and to prevent collapse with possible personal injury and property damage. For general guidance regarding the fabrication, storage, delivery, erection and bracing of trusses and truss systems, see **ANSI/TPI1 Quality Criteria, DSB-89 and BCSI Building Component Safety Information** available from Truss Plate Institute, 2670 Crain Highway, Suite 203 Waldorf, MD 20601



818 Soundside Road
Edenton, NC 27932

Job	Truss	Truss Type	Qty	Ply	Chesapeake-6260A:Lot104 FarmNeillsCreek
FNC104-F	F15	FLOOR	1	1	I57280883

Builders FirstSource (Apex, NC),

Apex, NC - 27523,

8.630 s Nov 19 2022 MiTek Industries, Inc. Mon Mar 20 15:58:11 2023 Page 1
ID:hazSNSvRlgjAW5liYCphTxyvdPZ-kj?R5px6Iaj69JKQX6_WrDzrZ8S2xQTTTRSN2VUZ_zyQ

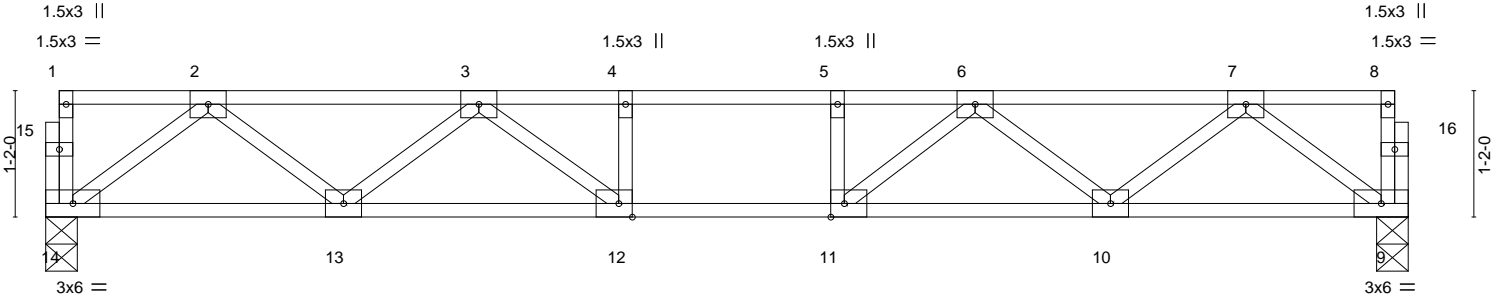
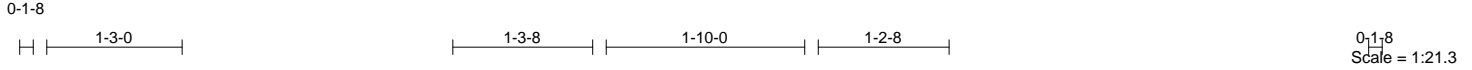

Plate Offsets (X,Y)--	[11:0-1-8,Edge], [12:0-1-8,Edge]	12-7-0 12-7-0			
LOADING (psf)	SPACING- 2-0-0	CSI.	DEFL. in (loc) l/defl L/d	PLATES	GRIP
TCLL 40.0	Plate Grip DOL 1.00	TC 0.45	Vert(LL) -0.10 12-13 >999 480	MT20	244/190
TCDL 10.0	Lumber DOL 1.00	BC 0.61	Vert(CT) -0.13 12-13 >999 360		
BCLL 0.0	Rep Stress Incr YES	WB 0.30	Horz(CT) 0.03 9 n/a n/a		
BCDL 5.0	Code IRC2015/TPI2014	Matrix-S		Weight: 63 lb	FT = 20%F, 11%E

LUMBER-	BRACING-
TOP CHORD 2x4 SP No.2(flat)	TOP CHORD Structural wood sheathing directly applied or 6-0-0 oc purlins, except end verticals.
BOT CHORD 2x4 SP No.2(flat)	BOT CHORD Rigid ceiling directly applied or 10-0-0 oc bracing.
WEBS 2x4 SP No.3(flat)	

REACTIONS. (size) 14=0-3-8, 9=0-3-8
Max Grav 14=672(LC 1), 9=672(LC 1)

FORCES. (lb) - Max. Comp./Max. Ten. - All forces 250 (lb) or less except when shown.
TOP CHORD 2-3=-1312/0, 3-4=-1972/0, 4-5=-1972/0, 5-6=-1972/0, 6-7=-1310/0
BOT CHORD 13-14=0/829, 12-13=0/1757, 11-12=0/1972, 10-11=0/1757, 9-10=0/829
WEBS 2-14=-1038/0, 2-13=0/628, 3-13=-580/0, 3-12=0/470, 7-9=-1038/0, 7-10=0/626, 6-10=-582/0, 6-11=0/475

- NOTES-**
- 1) Unbalanced floor live loads have been considered for this design.
 - 2) All plates are 3x4 MT20 unless otherwise indicated.
 - 3) Recommend 2x6 strongbacks, on edge, spaced at 10-0-0 oc and fastened to each truss with 3-10d (0.131" X 3") nails. Strongbacks to be attached to walls at their outer ends or restrained by other means.



March 21, 2023

Job	Truss	Truss Type	Qty	Ply	Chesapeake-6260A:Lot104 FarmNeillsCreek
FNC104-F	F16G	GABLE	1	1	157280884
					Job Reference (optional)

Builders FirstSource (Apex, NC), Apex, NC - 27523,

8.630 s Nov 19 2022 MiTek Industries, Inc. Mon Mar 20 15:58:11 2023 Page 1
ID:hazSNSvRlgjAW5liYCphTxvvdPZ-kj?R5px6laj69JKQX6_WrDzw48bFxEuTRS2VUZz_yQ

0₁1₈

0₁1₈

Scale = 1:20.8

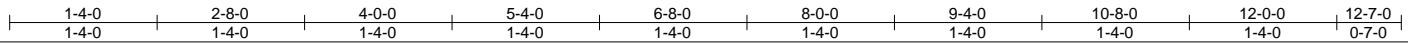
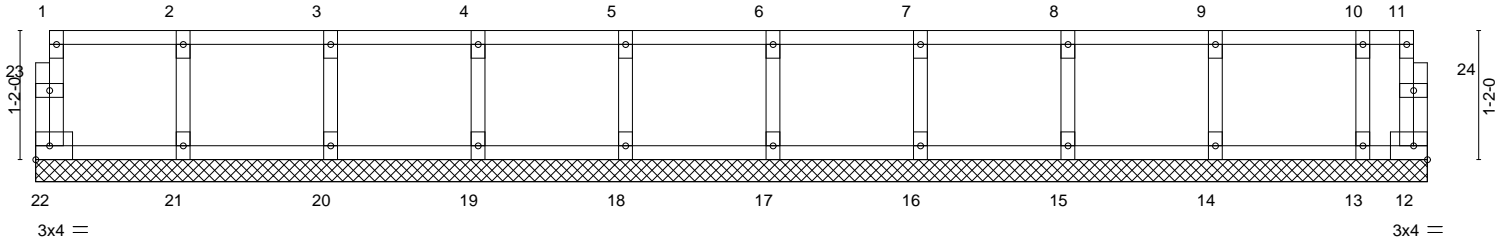

LOADING (psf)	SPACING-	2-0-0	CSI.	DEFL.	in (loc)	l/defl	L/d	PLATES	GRIP
TCLL 40.0	Plate Grip DOL	1.00	TC 0.09	Vert(LL)	n/a	-	n/a	MT20	244/190
TCDL 10.0	Lumber DOL	1.00	BC 0.02	Vert(CT)	n/a	-	n/a		
BCLL 0.0	Rep Stress Incr	NO	WB 0.03	Horz(CT)	0.00	12	n/a		
BCDL 5.0	Code IRC2015/TPI2014		Matrix-R						
								Weight: 54 lb	FT = 20%F, 11%E

LUMBER-	BRACING-
TOP CHORD 2x4 SP No.2(flat)	TOP CHORD Structural wood sheathing directly applied or 6-0-0 oc purlins, except end verticals.
BOT CHORD 2x4 SP No.2(flat)	BOT CHORD Rigid ceiling directly applied or 10-0-0 oc bracing.
WEBS 2x4 SP No.3(flat)	
OTHERS 2x4 SP No.3(flat)	

REACTIONS. All bearings 12-7-0.
(lb) - Max Grav All reactions 250 lb or less at joint(s) 22, 12, 21, 20, 19, 18, 17, 16, 15, 14, 13

FORCES. (lb) - Max. Comp./Max. Ten. - All forces 250 (lb) or less except when shown.

- NOTES-**
- 1) All plates are 1.5x3 MT20 unless otherwise indicated.
 - 2) Gable requires continuous bottom chord bearing.
 - 3) Truss to be fully sheathed from one face or securely braced against lateral movement (i.e. diagonal web).
 - 4) Gable studs spaced at 1-4-0 oc.
 - 5) Recommend 2x6 strongbacks, on edge, spaced at 10-0-0 oc and fastened to each truss with 3-10d (0.131" X 3") nails. Strongbacks to be attached to walls at their outer ends or restrained by other means.

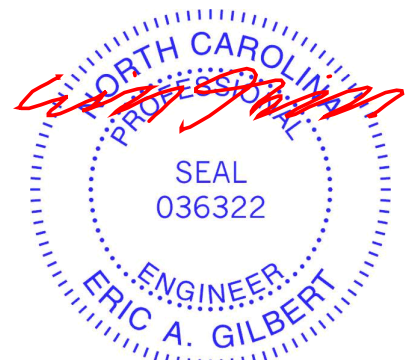

March 21, 2023

Job	Truss	Truss Type	Qty	Ply	Chesapeake-6260A:Lot104 FarmNeillsCreek
FNC104-F	F18G	GABLE	1	1	157280885
					Job Reference (optional)

Builders FirstSource (Apex, NC), Apex, NC - 27523,

8.630 s Nov 19 2022 MiTek Industries, Inc. Mon Mar 20 15:58:12 2023 Page 1
ID:hazSNSvRlgiAW5iiYCphTxyvdPZ-CvZqJ9yk3trzmTvc5qVIOQV4hXxigxscg66c1xz_yP

Scale = 1:24.3

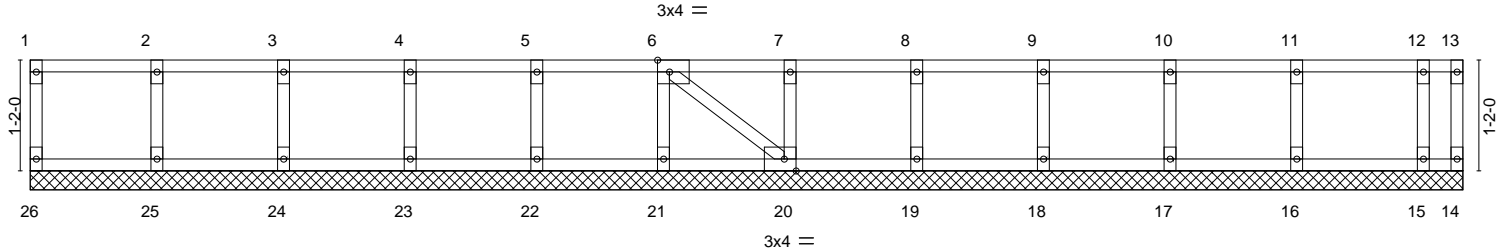

1-4-0	2-8-0	4-0-0	5-4-0	6-8-0	8-0-0	9-4-0	10-8-0	12-0-0	13-4-0	14-8-0	15-1-0
1-4-0	1-4-0	1-4-0	1-4-0	1-4-0	1-4-0	1-4-0	1-4-0	1-4-0	1-4-0	1-4-0	0-5-0
Plate Offsets (X, Y)-- [6:0-1-8,Edge], [20:0-1-8,Edge]											

LOADING (psf)	SPACING-	2-0-0	CSI.	DEFL.	in (loc)	l/defl	L/d	PLATES	GRIP
TCLL 40.0	Plate Grip DOL	1.00	TC 0.10	Vert(LL)	n/a	-	n/a	MT20	244/190
TCDL 10.0	Lumber DOL	1.00	BC 0.01	Vert(CT)	n/a	-	n/a		
BCLL 0.0	Rep Stress Incr	NO	WB 0.03	Horz(CT)	-0.00	14	n/a		
BCDL 5.0	Code IRC2015/TPI2014		Matrix-S						
								Weight: 65 lb	FT = 20%F, 11%E

LUMBER-	BRACING-
TOP CHORD 2x4 SP No.2(flat)	TOP CHORD Structural wood sheathing directly applied or 10-0-0 oc purlins, except end verticals.
BOT CHORD 2x4 SP No.2(flat)	BOT CHORD Rigid ceiling directly applied or 10-0-0 oc bracing.
WEBS 2x4 SP No.3(flat)	
OTHERS 2x4 SP No.3(flat)	

REACTIONS. All bearings 15-1-0.
(lb) - Max Uplift All uplift 100 lb or less at joint(s) 14
Max Grav All reactions 250 lb or less at joint(s) 26, 25, 24, 23, 22, 21, 20, 19, 18, 17, 16, 15

FORCES. (lb) - Max. Comp./Max. Ten. - All forces 250 (lb) or less except when shown.

- NOTES-**
- 1) All plates are 1.5x3 MT20 unless otherwise indicated.
 - 2) Gable requires continuous bottom chord bearing.
 - 3) Truss to be fully sheathed from one face or securely braced against lateral movement (i.e. diagonal web).
 - 4) Gable studs spaced at 1-4-0 oc.
 - 5) Provide mechanical connection (by others) of truss to bearing plate capable of withstanding 100 lb uplift at joint(s) 14.
 - 6) Recommend 2x6 strongbacks, on edge, spaced at 10-0-0 oc and fastened to each truss with 3-10d (0.131" X 3") nails. Strongbacks to be attached to walls at their outer ends or restrained by other means.



March 21, 2023

WARNING - Verify design parameters and READ NOTES ON THIS AND INCLUDED MITEK REFERENCE PAGE MII-7473 rev. 5/19/2020 BEFORE USE.
Design valid for use only with MiTek® connectors. This design is based only upon parameters shown, and is for an individual building component, not a truss system. Before use, the building designer must verify the applicability of design parameters and properly incorporate this design into the overall building design. Bracing indicated is to prevent buckling of individual truss web and/or chord members only. Additional temporary and permanent bracing is always required for stability and to prevent collapse with possible personal injury and property damage. For general guidance regarding the fabrication, storage, delivery, erection and bracing of trusses and truss systems, see **ANSI/TPI1 Quality Criteria, DSB-89 and BCSI Building Component Safety Information** available from Truss Plate Institute, 2670 Crain Highway, Suite 203 Waldorf, MD 20601



818 Soundside Road
Edenton, NC 27932

Job	Truss	Truss Type	Qty	Ply	Chesapeake-6260A:Lot104 FarmNeillsCreek
FNC104-F	F19	FLOOR	1	1	157280886

Builders FirstSource (Apex, NC),

Apex, NC - 27523,

8.630 s Nov 19 2022 MiTek Industries, Inc. Mon Mar 20 15:58:13 2023 Page 1

ID:hazSNSvRlgjAW5liYCphTxyvdPZ-g67CWVzNqBzqOdToeX1_we2ALx8qPKmuls9ZNzZ_yO



Scale = 1:21.0

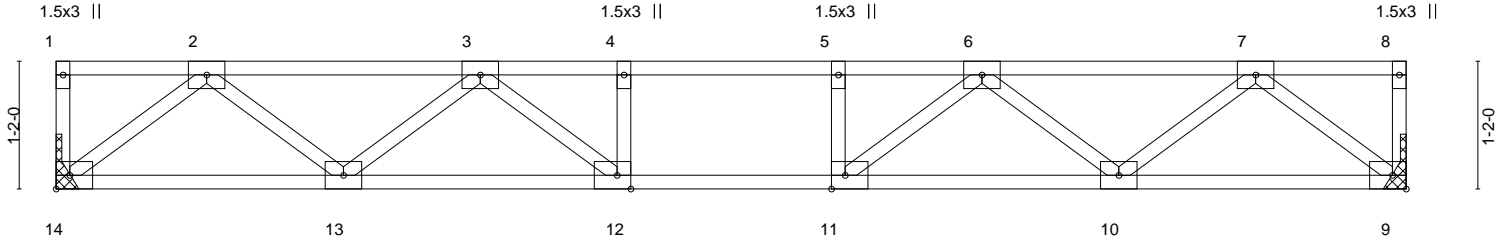

12-4-0
12-4-0

Plate Offsets (X,Y)--	[11:0-1-8,Edge], [12:0-1-8,Edge]						
LOADING (psf)	SPACING- 2-0-0	CSI.	DEFL. in (loc) l/defl L/d	PLATES	GRIP		
TCLL 40.0	Plate Grip DOL 1.00	TC 0.43	Vert(LL) -0.09 12-13 >999 480	MT20	244/190		
TCDL 10.0	Lumber DOL 1.00	BC 0.59	Vert(CT) -0.12 12-13 >999 360				
BCLL 0.0	Rep Stress Incr YES	WB 0.30	Horz(CT) 0.03 9 n/a n/a				
BCDL 5.0	Code IRC2015/TPI2014	Matrix-S					
						Weight: 61 lb	FT = 20%F, 11%E

LUMBER-

TOP CHORD 2x4 SP No.2(flat)
BOT CHORD 2x4 SP No.2(flat)
WEBS 2x4 SP No.3(flat)

BRACING-

TOP CHORD Structural wood sheathing directly applied or 6-0-0 oc purlins, except end verticals.
BOT CHORD Rigid ceiling directly applied or 10-0-0 oc bracing.

REACTIONS. (size) 9=Mechanical, 14=Mechanical
Max Grav 9=671(LC 1), 14=671(LC 1)

FORCES. (lb) - Max. Comp./Max. Ten. - All forces 250 (lb) or less except when shown.
TOP CHORD 2-3=-1271/0, 3-4=-1932/0, 4-5=-1932/0, 5-6=-1932/0, 6-7=-1271/0
BOT CHORD 13-14=0/790, 12-13=0/1717, 11-12=0/1932, 10-11=0/1717, 9-10=0/790
WEBS 7-9=-1008/0, 2-14=-1008/0, 7-10=0/626, 2-13=0/626, 6-10=-581/0, 3-13=-581/0, 6-11=0/469, 3-12=0/469

NOTES-

- 1) Unbalanced floor live loads have been considered for this design.
- 2) All plates are 3x4 MT20 unless otherwise indicated.
- 3) Refer to girder(s) for truss connections.
- 4) Recommend 2x6 strongbacks, on edge, spaced at 10-0-0 oc and fastened to each truss with 3-10d (0.131" X 3") nails. Strongbacks to be attached to walls at their outer ends or restrained by other means.



March 21, 2023

WARNING - Verify design parameters and READ NOTES ON THIS AND INCLUDED MITEK REFERENCE PAGE MII-7473 rev. 5/19/2020 BEFORE USE.

Design valid for use only with MiTek® connectors. This design is based only upon parameters shown, and is for an individual building component, not a truss system. Before use, the building designer must verify the applicability of design parameters and properly incorporate this design into the overall building design. Bracing indicated is to prevent buckling of individual truss web and/or chord members only. Additional temporary and permanent bracing is always required for stability and to prevent collapse with possible personal injury and property damage. For general guidance regarding the fabrication, storage, delivery, erection and bracing of trusses and truss systems, see

ANSI/TPI1 Quality Criteria, DSB-89 and BCSI Building Component

Safety Information available from Truss Plate Institute, 2670 Crain Highway, Suite 203 Waldorf, MD 20601



818 Soundside Road
Edenton, NC 27932

Job	Truss	Truss Type	Qty	Ply	Chesapeake-6260A:Lot104 FarmNeillsCreek	157280887
FNC104-F	F20	FLOOR	1	1		

Builders FirstSource (Apex, NC),

Apex, NC - 27523,

8.630 s Nov 19 2022 MiTek Industries, Inc. Mon Mar 20 15:58:14 2023 Page 1

ID:hazSNSvRlgjAW5liYCphTxvyvdPZ-8lhakr_?bV5h0n2?CEYDTrbKXLRg8kZv7Pbi5pzZ_yN

Job Reference (optional)

1-3-0

1-4-0 | 0-11-0

0-1-8

Scale = 1:32.8

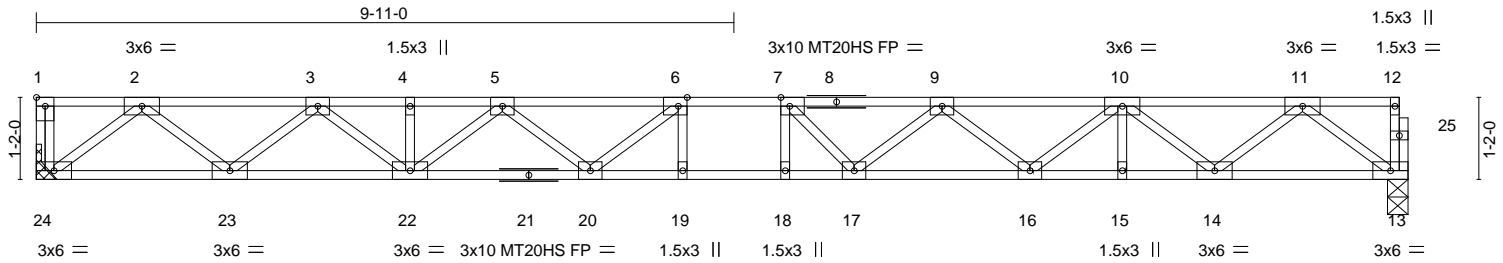

19-6-0
19-6-0

Plate Offsets (X,Y)-- [1:Edge,0-1-8], [6:0-1-8,Edge], [7:0-1-8,Edge]

LOADING (psf)	SPACING-	1-7-3	CSI.	DEFL.	in	(loc)	l/defl	L/d	PLATES	GRIP
TCLL 40.0	Plate Grip DOL	1.00	TC 0.46	Vert(LL)	-0.32	19	>719	480	MT20	244/190
TCDL 10.0	Lumber DOL	1.00	BC 0.81	Vert(CT)	-0.44	19	>523	360	MT20HS	187/143
BCLL 0.0	Rep Stress Incr	YES	WB 0.47	Horz(CT)	0.07	13	n/a	n/a		
BCDL 5.0	Code IRC2015/TP12014		Matrix-S							
									Weight: 100 lb	FT = 20%F, 11%E

LUMBER-

TOP CHORD 2x4 SP No.1(flat)
BOT CHORD 2x4 SP No.1(flat)
WEBS 2x4 SP No.3(flat)

BRACING-

TOP CHORD Structural wood sheathing directly applied or 6-0-0 oc purlins, except end verticals.
BOT CHORD Rigid ceiling directly applied or 10-0-0 oc bracing.

REACTIONS.

(size) 24=Mechanical, 13=0-3-8
Max Grav 24=846(LC 1), 13=841(LC 1)

FORCES. (lb) - Max. Comp./Max. Ten. - All forces 250 (lb) or less except when shown.

TOP CHORD 2-3=-1812/0, 3-4=-3066/0, 4-5=-3066/0, 5-6=-3718/0, 6-7=-3894/0, 7-9=-3729/0, 9-10=-3070/0, 10-11=-1813/0
BOT CHORD 23-24=0/1062, 22-23=0/2534, 20-22=0/3518, 19-20=0/3894, 18-19=0/3894, 17-18=0/3894, 16-17=0/3515, 15-16=0/2576, 14-15=0/2576, 13-14=0/1059
WEBS 2-24=-1332/0, 2-23=0/976, 3-23=-941/0, 3-22=0/678, 5-22=-577/0, 5-20=0/377, 6-20=-448/92, 11-13=-1327/0, 11-14=0/981, 10-14=-974/0, 10-16=0/630, 9-16=-580/0, 9-17=0/404, 7-17=-462/92

NOTES-

- 1) Unbalanced floor live loads have been considered for this design.
- 2) All plates are MT20 plates unless otherwise indicated.
- 3) All plates are 3x4 MT20 unless otherwise indicated.
- 4) Refer to girder(s) for truss to truss connections.
- 5) Recommend 2x6 strongbacks, on edge, spaced at 10-0-0 oc and fastened to each truss with 3-10d (0.131" X 3") nails. Strongbacks to be attached to walls at their outer ends or restrained by other means.
- 6) CAUTION, Do not erect truss backwards.

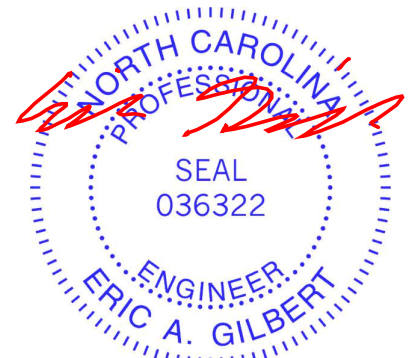

March 21, 2023

WARNING - Verify design parameters and READ NOTES ON THIS AND INCLUDED MITEK REFERENCE PAGE MII-7473 rev. 5/19/2020 BEFORE USE.

Design valid for use only with MiTek® connectors. This design is based only upon parameters shown, and is for an individual building component, not a truss system. Before use, the building designer must verify the applicability of design parameters and properly incorporate this design into the overall building design. Bracing indicated is to prevent buckling of individual truss web and/or chord members only. Additional temporary and permanent bracing is always required for stability and to prevent collapse with possible personal injury and property damage. For general guidance regarding the fabrication, storage, delivery, erection and bracing of trusses and truss systems, see

ANSI/TPI1 Quality Criteria, DSB-89 and BCSI Building Component

Safety Information available from Truss Plate Institute, 2670 Crain Highway, Suite 203 Waldorf, MD 20601



818 Soundside Road
Edenton, NC 27932

Job	Truss	Truss Type	Qty	Ply	Chesapeake-6260A:Lot104 FarmNeillsCreek	I57280888
FNC104-F	F21GR	FLOOR	1	1	Job Reference (optional)	

Builders FirstSource (Apex, NC),

Apex, NC - 27523,

8.630 s Nov 19 2022 MiTek Industries, Inc. Mon Mar 20 15:58:15 2023 Page 1

ID:hazSNSvRlgjAW5liYCphTxyvdPZ-dUEyxA?dMoDXdxdBmy3S?37VNImlqt3g3M3LGeFzZ_yM

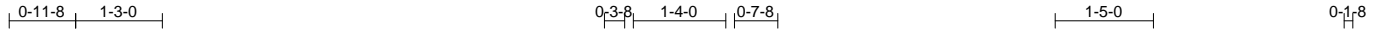

Scale = 1:33.2

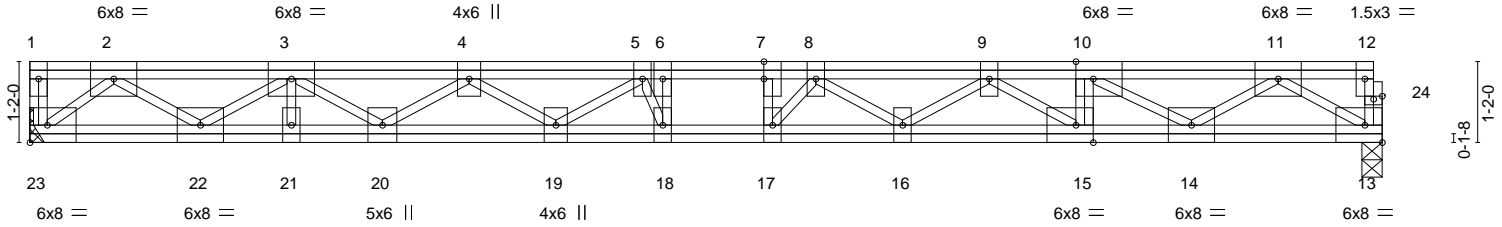

Plate Offsets (X,Y)--	[7:0-3-0,0-0-0], [10:0-3-0,Edge], [15:0-3-0,Edge], [24:0-1-8,0-0-8]
-----------------------	---

LOADING (psf)	SPACING-	CSI.	DEFL.	PLATES	GRIP
TCLL 40.0	1-7-3	TC 0.46	in (loc) l/defl L/d	MT20	244/190
TCDL 10.0	Plate Grip DOL 1.00	BC 0.82	Vert(LL) -0.35 17 >661 480		
BCLL 0.0	Lumber DOL 1.00	WB 0.99	Vert(CT) -0.48 17 >481 360		
BCDL 5.0	Rep Stress Incr NO	Matrix-S	Horz(CT) 0.05 13 n/a n/a		
	Code IRC2015/TPI2014			Weight: 154 lb	FT = 20%F, 11%E

LUMBER-	BRACING-
TOP CHORD 2x4 SP No.2(flat)	TOP CHORD Structural wood sheathing directly applied or 6-0-0 oc purlins, except end verticals.
BOT CHORD 2x4 SP No.1(flat)	BOT CHORD Rigid ceiling directly applied or 10-0-0 oc bracing.
WEBS 2x4 SP No.3(flat)	

REACTIONS. (size) 23=Mechanical, 13=0-3-8
Max Grav 23=1049(LC 1), 13=1598(LC 1)

FORCES. (lb) - Max. Comp./Max. Ten. - All forces 250 (lb) or less except when shown.
 TOP CHORD 2-3=-2349/0, 3-4=-4408/0, 4-5=-5744/0, 5-6=-6493/0, 6-7=-6493/0, 7-8=-6493/0, 8-9=-6705/0, 9-10=-6234/0, 10-11=-4061/0
 BOT CHORD 22-23=0/1199, 21-22=0/3524, 20-21=0/3524, 19-20=0/5213, 18-19=0/6320, 17-18=0/6493, 16-17=0/6709, 15-16=0/6594, 14-15=0/6234, 13-14=0/2391
 WEBS 6-18=-592/131, 7-17=-167/343, 2-23=-1571/0, 2-22=0/1426, 3-22=-1434/0, 3-20=0/1078, 4-20=-998/0, 4-19=0/719, 5-19=-834/0, 5-18=-193/875, 9-15=-436/0, 9-16=-79/347, 8-16=-336/264, 8-17=-669/289, 11-13=-2788/0, 11-14=0/2076, 10-14=-2528/0

- NOTES-**
- 1) Unbalanced floor live loads have been considered for this design.
 - 2) All plates are 3x6 MT20 unless otherwise indicated.
 - 3) Refer to girder(s) for truss to truss connections.
 - 4) Recommend 2x6 strongbacks, on edge, spaced at 10-0-0 oc and fastened to each truss with 3-10d (0.131" X 3") nails. Strongbacks to be attached to walls at their outer ends or restrained by other means.
 - 5) CAUTION, Do not erect truss backwards.
 - 6) Hanger(s) or other connection device(s) shall be provided sufficient to support concentrated load(s) 960 lb down at 15-2-8 on top chord. The design/selection of such connection device(s) is the responsibility of others.
 - 7) In the LOAD CASE(S) section, loads applied to the face of the truss are noted as front (F) or back (B).

LOAD CASE(S) Standard
 1) Dead + Floor Live (balanced): Lumber Increase=1.00, Plate Increase=1.00
 Uniform Loads (plf)
 Vert: 13-23=-8, 1-12=-80
 Concentrated Loads (lb)
 Vert: 10=-960(F)



March 21, 2023

<p>WARNING - Verify design parameters and READ NOTES ON THIS AND INCLUDED MITEK REFERENCE PAGE MII-7473 rev. 5/19/2020 BEFORE USE. Design valid for use only with MiTek® connectors. This design is based only upon parameters shown, and is for an individual building component, not a truss system. Before use, the building designer must verify the applicability of design parameters and properly incorporate this design into the overall building design. Bracing indicated is to prevent buckling of individual truss web and/or chord members only. Additional temporary and permanent bracing is always required for stability and to prevent collapse with possible personal injury and property damage. For general guidance regarding the fabrication, storage, delivery, erection and bracing of trusses and truss systems, see ANSI/TPI1 Quality Criteria, DSB-89 and BCSI Building Component Safety Information available from Truss Plate Institute, 2670 Crain Highway, Suite 203 Waldorf, MD 20601</p>	<p>ENGINEERING BY TRENCO A MiTek Affiliate</p> <p>818 Soundside Road Edenton, NC 27932</p>
--	--

Symbols

PLATE LOCATION AND ORIENTATION



Center plate on joint unless x, y offsets are indicated. Dimensions are in ft-in-sixteenths. Apply plates to both sides of truss and fully embed teeth.



For 4 x 2 orientation, locate plates 0- 1/16" from outside edge of truss.



This symbol indicates the required direction of slots in connector plates.

* Plate location details available in **MITek 20/20 software** or upon request.

PLATE SIZE

4 X 4

The first dimension is the plate width measured perpendicular to slots. Second dimension is the length parallel to slots.

LATERAL BRACING LOCATION



Indicated by symbol shown and/or by text in the bracing section of the output. Use T or I bracing if indicated.

BEARING



Indicates location where bearings (supports) occur. Icons vary but reaction section indicates joint number where bearings occur. Min size shown is for crushing only.

Industry Standards:

ANSI/TFP 1: National Design Specification for Metal Plate Connected Wood Truss Construction.
DSB-89: Design Standard for Bracing, Building Component Safety Information, Guide to Good Practice for Handling, Installing & Bracing of Metal Plate Connected Wood Trusses.

Numbering System

6-4-8
dimensions shown in ft-in-sixteenths
(Drawings not to scale)



JOINTS ARE GENERALLY NUMBERED/LETTERED CLOCKWISE AROUND THE TRUSS STARTING AT THE JOINT FARTHEST TO THE LEFT.

CHORDS AND WEBS ARE IDENTIFIED BY END JOINT NUMBERS/LETTERS.

PRODUCT CODE APPROVALS

ICC-ES Reports:

ESR-1311, ESR-1352, ESR1988
ER-3907, ESR-2362, ESR-1397, ESR-3282

Trusses are designed for wind loads in the plane of the truss unless otherwise shown.

Lumber design values are in accordance with ANSI/TFP 1 section 6.3 These truss designs rely on lumber values established by others.

© 2012 MITteK® All Rights Reserved



MITek Engineering Reference Sheet: Mill-7473 rev. 5/19/2020



General Safety Notes

Failure to Follow Could Cause Property Damage or Personal Injury

1. Additional stability bracing for truss system, e.g. diagonal or X-bracing, is always required. See BCSI.
2. Truss bracing must be designed by an engineer. For wide truss spacing, individual lateral braces themselves may require bracing, or alternative Tor I bracing should be considered.
3. Never exceed the design loading shown and never stack materials on inadequately braced trusses.
4. Provide copies of this truss design to the building designer, erection supervisor, property owner and all other interested parties.
5. Cut members to bear tightly against each other.
6. Place plates on each face of truss at each joint and embed fully. Knots and wane at joint locations are regulated by ANSI/TFP 1.
7. Design assumes trusses will be suitably protected from the environment in accord with ANSI/TFP 1.
8. Unless otherwise noted, moisture content of lumber shall not exceed 19% at time of fabrication.
9. Unless expressly noted, this design is not applicable for use with fire retardant, preservative treated, or green lumber.
10. Camber is a non-structural consideration and is the responsibility of truss fabricator. General practice is to camber for dead load deflection.
11. Plate type, size, orientation and location dimensions indicated are minimum plating requirements.
12. Lumber used shall be of the species and size, and in all respects, equal to or better than that specified.
13. Top chords must be sheathed or purlins provided at spacing indicated on design.
14. Bottom chords require lateral bracing at 10 ft. spacing, or less, if no ceiling is installed, unless otherwise noted.
15. Connections not shown are the responsibility of others.
16. Do not cut or alter truss member or plate without prior approval of an engineer.
17. Install and load vertically unless indicated otherwise.
18. Use of green or treated lumber may pose unacceptable environmental, health or performance risks. Consult with project engineer before use.
19. Review all portions of this design (front, back, words and pictures) before use. Reviewing pictures alone is not sufficient.
20. Design assumes manufacture in accordance with ANSI/TFP 1 Quality Criteria.
21. The design does not take into account any dynamic or other loads other than those expressly stated.