



NORTH CAROLINA 40' SERIES PLAN 238.2338

SHEET INDEX

PLAN #238.2338

TS	TITLE SHEET
GN1	GENERAL NOTES
GN2	GENERAL NOTES
GN3	GENERAL NOTES
1.1	FIRST FLOOR PLAN
1.2	SECOND FLOOR PLAN
1.3	FIRST FLOOR AT CRAWL SPACE OPTION
1.4	FIRST FLOOR PLAN OPTIONS
1.5	SECOND FLOOR PLAN OPTIONS
2.1	SLAB INTERFACE PLAN 'A'
2.2	PARTIAL SLAB INTERFACE PLAN 'B', 'C', & 'D'
2.3	CRAWL SPACE PLAN 'A'
2.4	PARTIAL CRAWL SPACE PLAN 'B', 'C' & 'D'
3.A1	ROOF PLAN, FRONT & REAR ELEVATIONS 'A'
3.A2	LEFT & RIGHT ELEVATIONS 'A'
3.A3	PARTIAL FIRST FLOOR PLAN, FRONT ELEVATION AND PARTIAL LEFT AND RIGHT ELEVATIONS 'A' AT CRAWL SPACE
3.A4	FRONT ELEVATION 'A' AT OPTIONAL 9'-0" PLATE AT SLAB & CRAWL SPACE
3.B1	PARTIAL FIRST & SECOND FLOOR PLANS 'B'
3.B2	ROOF PLAN, FRONT & REAR ELEVATIONS 'B'
3.B3	LEFT & RIGHT ELEVATIONS 'B'
3.B4	PARTIAL FLOOR PLAN, ROOF, FRONT ELEVATION, PARTIAL LEFT ELEVATION 'B' AT EXTENDED PORCH OPTION
3.B5	PARTIAL FIRST FLOOR PLAN, FRONT ELEVATION AND PARTIAL LEFT AND RIGHT ELEVATIONS 'B' AT CRAWL SPACE
3.B6	PARTIAL FLOOR PLAN, ROOF, FRONT ELEVATION, PARTIAL LEFT ELEVATION 'B' AT EXTENDED PORCH OPTION W/ CRAWLSPACE
3.B7	FRONT ELEVATION 'B' AT OPTIONAL 9'-0" PLATE AT SLAB & CRAWL SPACE
3.C1	PARTIAL FIRST & SECOND FLOOR PLANS 'C'
3.C2	ROOF PLAN, FRONT & REAR ELEVATIONS 'C'
3.C3	LEFT & RIGHT ELEVATIONS 'C'
3.C4	PARTIAL FIRST FLOOR PLAN, FRONT ELEVATION AND PARTIAL LEFT AND RIGHT ELEVATIONS 'C' AT CRAWL SPACE
3.C5	FRONT ELEVATION 'C' AT OPTIONAL 9'-0" PLATE AT SLAB & CRAWL SPACE
3.D1	PARTIAL FIRST & SECOND FLOOR PLANS 'D'
3.D2	ROOF PLAN, FRONT & REAR ELEVATIONS 'D'
3.D3	LEFT & RIGHT ELEVATIONS 'D'
3.D4	PARTIAL FIRST FLOOR PLAN, FRONT ELEVATION AND PARTIAL LEFT AND RIGHT ELEVATIONS 'D' AT CRAWL SPACE
3.D5	FRONT ELEVATION 'D' AT OPTIONAL 9'-0" PLATE AT SLAB & CRAWL SPACE
4.1	INTERIOR ELEVATIONS
4.2	SECTIONS
4.3	SECTIONS CRAWL SPACE
5.1	FIRST FLOOR UTILITY PLAN
5.2	SECOND FLOOR UTILITY PLAN
5.3	FIRST FLOOR UTILITY PLAN OPTIONS
5.4	SECOND FLOOR UTILITY PLAN OPTIONS
7.1	PARTIAL FLOOR PLAN, ELEVATIONS, CRAWL SPACE PLAN 'A/B/C/D' AT 12'x12' DECK
7.2	PARTIAL FLOOR PLAN, ELEVATIONS, CRAWL SPACE PLAN 'A/B/C/D' AT 24'x12' DECK
7.3	PARTIAL PLANS & ELEVATIONS 'A/B/C/D' W/ SCREENED DECK WITH OPT. AT CRAWL SPACE OPEN DECK OPT. AT CRAWL SPACE

8.1	PARTIAL FLOOR PLAN, ROOF & ELEVATIONS W/ OPT. COVERED PATIO
8.2	PARTIAL FLOOR PLAN, ROOF & ELEVATIONS W/ OPT. EXTENDED COVERED PATIO
8.3	PARTIAL FLOOR PLAN, ROOF & ELEVATIONS W/ OPT. COVERED SCREENED PATIO
8.4	PARTIAL FLOOR PLAN, ROOF & ELEVATIONS W/ OPT. EXTENDED COVERED SCREENED PATIO
8.5	PARTIAL FLOOR PLAN, ELEVATIONS & CRAWL SPACE PLAN 'A/B/C/D' AT SCREENED-IN COVERED DECK
8.6	PARTIAL FLOOR PLAN, ELEVATIONS & CRAWL SPACE PLAN 'A/B/C/D' AT SCREENED-IN EXTENDED COVERED DECK
9.1	PARTIAL FLOOR PLAN, ROOF & ELEVATIONS W/ OPT. SUNROOM
9.2	PARTIAL FLOOR PLAN, ROOF & ELEVATIONS & CRAWL SPACE PLAN 'A/B/C/D' W/ OPT. SUNROOM
AD1	ARCHITECTURAL DETAILS
AD2	ARCHITECTURAL DETAILS
AD3	ARCHITECTURAL DETAILS
AD4	ARCHITECTURAL DETAILS
AD5	ARCHITECTURAL DETAILS
AD6	ARCHITECTURAL DETAILS
AD7	ARCHITECTURAL DETAILS
AD8	ARCHITECTURAL DETAILS



NORTH CAROLINA 40' SERIES

KB HOME
NORTH CAROLINA DIVISION
4506 S. MIAMI BLVD.
SUITE 180
DURHAM, NC 27703
TEL: (919) 768-7980
FAX: (919) 544-2928

2018 NORTH CAROLINA STATE BUILDING CODES

ABBREVIATIONS

ABV.	ABOVE	G.F.I.	GROUND-FAULT CIRCUIT INTERRUPTER	R.O.	ROUGH OPENING
A/C	AIR CONDITIONING	S & P	S & P	S & P	SHELF AND POLE
ADJ.	ADJUSTABLE	S.C.	SOLID CORE	S.C.	SOLID CORE
ALT.	ALTERNATE	S.D.	SMOKE DETECTOR	S.D.	SMOKE DETECTOR
AMP.	AMPERAGE	SEC.	SECTION	SEC.	SECTION
BD.	BOARD	S.H.	SINGLE HUNG	S.H.	SINGLE HUNG
CL.	CENTER LINE	SHT.	SHEET	SHT.	SHEET
CAB.	CABINET	SHTS.	SHEATHING	SHTS.	SHEATHING
CLG.	CEILING	SHWR.	SHOWER	SHWR.	SHOWER
CLR.	CLEAR	SHWR.	SIMILAR	SHWR.	SIMILAR
CONC.	CONCRETE	SL.	SLIDING	SL.	SLIDING
CPT.	CARPET	SL. GL.	SLIDING GLASS	SL. GL.	SLIDING GLASS
C.T.	CERAMIC TILE	STD.	STANDARD	STD.	STANDARD
D.	DRYER	S.V.	SHEET VINYL	S.V.	SHEET VINYL
DBL.	DOUBLE	TEMP.	TEMPERED GLASS	TEMP.	TEMPERED GLASS
D.G.	DUAL GLAZED	THK.	THICK	THK.	THICK
DIA.	DIAMETER	T.O.C.	TOP OF CURB	T.O.C.	TOP OF CURB
DIM.	DIMENSION	T.O.P.	TOP OF PLATE	T.O.P.	TOP OF PLATE
DISP.	DISPOSAL	T.O.S.	TOP OF SLAB	T.O.S.	TOP OF SLAB
D.L.	DIVIDED LIGHT	TYP.	TYPICAL	TYP.	TYPICAL
DP.	DEEP	U.N.O.	UNLESS NOTED OTHERWISE	U.N.O.	UNLESS NOTED OTHERWISE
DR.	DOOR	V.P.	VAPOR PROOF	V.P.	VAPOR PROOF
D.S.	DOWNSPOUT	W.	WASHER	W.	WASHER
DTL.	DETAIL	W.	WITH	W.	WITH
D.W.	DISHWASHER	WD.	WOOD	WD.	WOOD
EA.	EACH	WDN.	WINDOW	WDN.	WINDOW
ELEV.	ELEVATION	WH.	WATER HEATER	WH.	WATER HEATER
EQ.	EQUAL	W.I.	WROUGHT IRON	W.I.	WROUGHT IRON
EXH.	EXHAUST	W.P.	WEATHER PROOF	W.P.	WEATHER PROOF
EXT.	EXTERIOR				
FAU.	FORCED AIR UNIT				
F.C.	FIBER CEMENT				
F.G./F.X.	FIXED GLASS				
F.G.	FUEL GAS				
FIN.	FINISH				
FLR.	FLOOR				
FLR. LINE	FLOOR LINE				
FLUOR.	FLUORESCENT				
FR. DR.	FRENCH DOOR				
F.M.C.	FLOOR MATERIAL CHANGE				
FTG.	FOOTING				
GA.	GAUGE				
GAR. DISP.	GARBAGE DISPOSAL				

ARCH. SYMBOLS

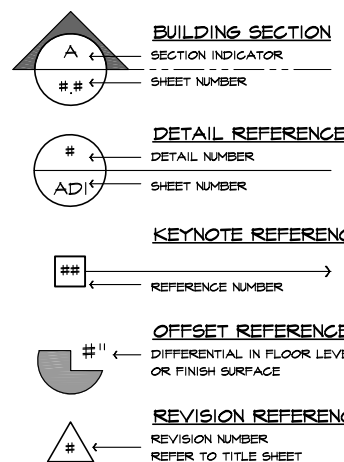

SCALE NOTE

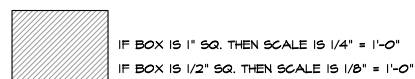

CONSULTANTS

OWNER :
KB HOME
NORTH CAROLINA DIVISION
4506 S. MIAMI BLVD., SUITE 180
DURHAM, NC 27703
TEL: (919) 768-7980
FAX: (919) 544-2928

ARCHITECT
KB HOME
5230 PACIFIC CONCOURSE DRIVE, SUITE 330
LOS ANGELES, CA 90045
TEL: (424) 244-3700
FAX: (310) 247-2671

SQUARE FOOTAGE

PLAN 238.2338		
FIRST FLOOR AREA	494	SQ. FT.
SECOND FLOOR AREA	1844	SQ. FT.
TOTAL AREA	2338	SQ. FT.
GARAGE AREA	421	SQ. FT.
PORCH AREA(S)		
ELEVATION 'A'	79	SQ. FT.
ELEVATION 'B'	62	SQ. FT.
ELEVATION 'C'	146	SQ. FT.
ELEVATION 'D'	174	SQ. FT.
PATIO AREA(S)		
COVERED	100	SQ. FT.
EXTENDED COVERED	200	SQ. FT.
DECK AREA(S)		
DECK	144	SQ. FT.
EXTENDED DECK	252	SQ. FT.

ALL EXPOSED PORTIONS OF CONCRETE SLAB FOUNDATIONS ARE TO BE 'FARGED (TEXTURED) AND PAINTED TO MATCH THE HOME'.

CODE INFORMATION

APPLICABLE CODES:

2018 NORTH CAROLINA STATE BUILDING CODE; RESIDENTIAL CODE, INCLUDING REFERENCED CODES AND STANDARDS

PROJECT DESCRIPTION:

2 STORY SINGLE FAMILY DETACHED RESIDENTIAL PLAN W/ 4 ELEVATIONS
OCCUPANCY:
R3

CONSTRUCTION TYPE:

V - B

CODE ABBREVIATIONS

N.C.-R.	NORTH CAROLINA RESIDENTIAL CODE
N.C.-B.	NORTH CAROLINA BUILDING CODE
N.C.-M.	NORTH CAROLINA MECHANICAL CODE
N.C.-P.	NORTH CAROLINA PLUMBING CODE
N.C.-F.	NORTH CAROLINA FUEL GAS CODE
N.C.-E.	NORTH CAROLINA ELECTRICAL CODE
N.C.-EG.	NORTH CAROLINA ENERGY CODE
N.E.C.	NATIONAL ELECTRICAL CODE
I.C.B.O.	INTERNATIONAL CONFERENCE OF BUILDING OFFICIALS
A.S.T.M.	AMERICAN SOCIETY FOR TESTING MATERIALS
N.F.P.A.	NATIONAL FIRE PROTECTION ASSOCIATION
A.N.S.I.	AMERICAN NATIONAL STANDARDS INSTITUTE
I.E.C.C.	INTERNATIONAL ENERGY CONSERVATION CODE
I.C.C.	INTERNATIONAL CODE COUNCIL
U.L.	UNDERWRITERS LABORATORIES, INC.

REVISION LIST

DELTA	DATE	SHEETS REVISED	LOG NUMBER
8	01/15/19	T.S, GN1, GN2, GN3, 5.1-5.4	NC19015NCP
9	04/01/19	1.1, 2.1, 3.A1, 3.B2, 3.C2, 3.D2, 5.1	NC19017NCP
10	04/26/19	1.1, 2.1, 4.2, 4.3	NC19032NCP
11	08/28/19	1.1-1.5, 2.1, 3.A2+3, 3.B1+3+4, 3.C1+3+4, 3.D1+3+4, 7.1, 7.2, 8.1-8.6, 9.1, 9.2	NC19054NCP
12	09/26/19	3.A1, 3.A3, 3.B2, 3.B5, 3.C2, 3.C4, 8.2, 8.4	NC19057NCP
13	12/19/19	3.D2, 3.D4, 3.D5	NC20008NCP
14	01/17/20	2.3, 2.4, 3.A2, 3.B2, 3.C2, 3.D2, 3.D4, 3.D5	NC20008NCP
15	02/10/20	1.1, 3.B2, 3.B3, 3.B4, 3.B5, 3.B6, 3.B7, 3.D1, 3.D2, 3.D3, 3.D4, 3.D5	NC20013NCP
16	03/04/20	TS, 1.4, 5.3, 8.3, 8.4	NC20017NCP
17	08/20/20	1.1, 1.3, 1.4, 4.1, 5.3	CORP20008CORP
19	01/06/21	TS, 1.2, 1.5	NC21005NCP
20	05/19/21	TS, 1.5, 5.4	NC21033NCP
21	12/17/21	TS, 7.3	NC21056NCP

ISSUE DATE: 01/08/15
PROJECT No.: 1350999:56
DIVISION MGR.: DCS
REVISIONS: 12/17/21

- 15 DIVISION REVISION NC20015NCP - 02/10/20 - MCP
- 16 DIVISION REVISION NC20017NCP - 03/04/20 - KBA
- 17 HOME OFFICE CORP20008CORP-08/20/20-CTD
- 18 ADD NOTE TO TS NC20037NCP - 10/06/20 - KBA
- 19 DIVISION REQ. REVISION NC21005NCP - 01/06/21 - KBA
- 20 DIVISION REQ. REVISION NC21033NCP - 05/19/21 - KBA
- 21 ADD DBCE OPTION NC21056NCP - 12/17/21 - CTD

REVISION BY:	DATE	DESCRIPTION
1		
2		
3		
4		
5		
6		

FOR INTERNAL USE ONLY
PLAN: 238.2338
SHEET: TS

SPEC. LEVEL 1
RALEIGH-DURHAM
40' SERIES

GENERAL REQUIREMENTS

1. THE WORD "CONTRACTOR" AS USED HEREIN SHALL MEAN THE GENERAL CONTRACTOR, SUBCONTRACTORS AND ALL PERSONS DIRECTLY OR INDIRECTLY EMPLOYED BY ANY OF THEM.
2. THE CONTRACTOR SHALL PERFORM THE WORK IN ACCORDANCE WITH THE FOLLOWING APPLICABLE CODE REQUIREMENTS:
 - A. ALL LAWS, STATUTES, THE MOST RECENT BUILDING CODES, ORDINANCES, RULES, REGULATIONS, AND LAWFUL ORDERS OF ALL PUBLIC AUTHORITIES HAVING JURISDICTION OVER OWNER, CONTRACTOR, ANY SUBCONTRACTOR, THE PROJECT, THE PROJECT SITE, THE WORK, OR THE PROSECUTION OF THE WORK.
 - B. THE FEDERAL OCCUPATIONAL SAFETY AND HEALTH ACT AND ALL OTHER APPLICABLE CODE REQUIREMENTS RELATING TO SAFETY.
 - C. THE FAIR HOUSING AMENDMENTS ACT, THE AMERICANS WITH DISABILITIES ACT, AND ALL OTHER APPLICABLE CODE REQUIREMENTS RELATING THERETO.
3. CONTRACTOR SHALL CAREFULLY STUDY AND REVIEW THE CONSTRUCTION DOCUMENTS AND INFORMATION FURNISHED BY OWNER, AND SHALL PROMPTLY REPORT IN WRITING TO OWNER'S REPRESENTATIVE ANY ERRORS, INCONSISTENCIES OR OMISSIONS IN THE CONSTRUCTION DOCUMENTS OR INCONSISTENCIES WITH APPLICABLE CODE REQUIREMENTS OBSERVED BY THE CONTRACTOR.
4. IF CONTRACTOR PERFORMS WORK WHICH HE KNOWS OR SHOULD KNOW IS CONTRARY TO APPLICABLE CODE REQUIREMENTS, WITHOUT THE AGREEMENT OF OWNER, CONTRACTOR SHALL BE RESPONSIBLE FOR SUCH WORK AND SHALL BEAR THE RESULTANT LOSSES, INCLUDING, WITHOUT LIMITATION, THE COSTS OF CORRECTING DEFECTIVE WORK.
5. CONTRACTOR SHALL PROVIDE CERTIFICATES OF INSURANCE ACCEPTABLE TO OWNER PRIOR TO COMMENCEMENT OF WORK.
6. CONTRACTOR SHALL TAKE FIELD MEASUREMENTS, VERIFY FIELD CONDITIONS, AND CAREFULLY COMPARE WITH THE CONSTRUCTION DOCUMENTS SUCH FIELD MEASUREMENTS, CONDITIONS, AND OTHER INFORMATION KNOWN TO CONTRACTOR BEFORE COMMENCING THE WORK. ERRORS, INCONSISTENCIES, OR OMISSIONS DISCOVERED AT ANY TIME SHALL BE PROMPTLY REPORTED IN WRITING TO THE OWNER.
7. CONTRACTOR SHALL PROMPTLY NOTIFY OWNER'S REPRESENTATIVE IF CONTRACTOR BECOMES AWARE DURING THE PERFORMANCE OF THE WORK THAT THE CONSTRUCTION DOCUMENTS ARE NOT IN COMPLIANCE WITH APPLICABLE CODE REQUIREMENTS.
8. BY SUBMITTAL OF BID, CONTRACTOR WARRANTS TO OWNER THAT ALL MATERIALS AND EQUIPMENT TO BE FURNISHED ARE NEW UNLESS NOTED OTHERWISE AND ALL WORK WILL BE OF GOOD QUALITY AND FREE FROM FAULTS AND DEFECTS.
9. SUB-CONTRACTORS SHALL INSURE THAT ALL WORK IS DONE IN A PROFESSIONAL WORKMANLIKE MANNER BY SKILLED MECHANICS AND SHALL REPLACE ANY MATERIALS OR ITEMS DAMAGED BY SUB-CONTRACTOR'S PERFORMANCE. SUB-CONTRACTORS AND SUPPLIERS ARE HEREBY NOTIFIED THAT THEY ARE TO CONFER AND COOPERATE FULLY WITH EACH OTHER DURING THE COURSE OF CONSTRUCTION TO DETERMINE THE EXACT EXTENT AND OVERLAP OF EACH OTHER'S WORK AND TO CONDUCT WORK CAREFULLY AND TO THE EXECUTION OF THE WORK. ALL SUB-CONTRACTOR WORKMANSHIP SHALL BE OF QUALITY TO PASS INSPECTIONS BY LOCAL AUTHORITIES, LENDING INSTITUTIONS, ARCHITECT OR BUILDER. ANY ONE OR ALL OF THE ABOVE MENTIONED INSPECTORS MAY INSPECT WORKMANSHIP AT ANY TIME, AND CORRECTIONS NEEDED TO ENHANCE THE QUALITY OF BUILDING WILL BE DONE IMMEDIATELY. EACH SUBCONTRACTOR SHALL BE RESPONSIBLE FOR THE TERMS OF HIS/HERS SUB-CONTRACT AGREEMENT, SHALL BE RESPONSIBLE FOR CLEANING UP AND REMOVING FROM THE JOB SITE ALL TRASH AND DEBRIS NOT LEFT BY OTHER SUB-CONTRACTORS. BUILDER WILL DETERMINE HOW SOON AFTER SUBCONTRACTOR COMPLETES EACH PHASE OF HIS WORK THAT TRASH AND DEBRIS WILL BE REMOVED FROM THE SITE.
10. APPROVAL BY THE BUILDING INSPECTOR DOES NOT MEAN APPROVAL OR ALLOWABLE FAILURE TO COMPLY WITH THE PLANS AND SPECIFICATIONS. ANY DESIGN WHICH FAILS TO BE CLEAR OR IS AMBIGUOUS MUST BE REFERRED TO THE ARCHITECT OR ENGINEER FOR INTERPRETATION OR CLARIFICATION.
11. ALL EQUIPMENT AND MATERIALS FURNISHED AND INSTALLED UNDER THESE PLANS SHALL BE GUARANTEED BY THE CONTRACTOR FOR A PERIOD OF ONE YEAR FROM THE DATE OF ACCEPTANCE OF THE WORK BY OWNER UNLESS STIPULATED OTHERWISE.
12. ALL TRADE NAMES AND BRAND NAMES CONTAINED HEREIN ESTABLISH QUALITY STANDARDS. SUBSTITUTIONS ARE PERMITTED, WITH PRIOR APPROVAL BY THE OWNER'S REPRESENTATIVE. THE CONTRACTOR SHALL SUBMIT FOR THE ARCHITECT'S AND BUILDER'S APPROVAL ALL MATERIALS OR EQUIPMENT WHICH IS CONSIDERED "OR EQUAL" TO THAT SPECIFIED.
13. CONSTRUCTION DOCUMENTS IDENTIFIED AS "BID SET" ON ANY OR ALL SHEETS MAY BE SUBJECT TO REVIEW. THIS REVIEW MAY RESULT IN CHANGES WHICH MAY BE MADE TO THE PLANS PRIOR TO THE ISSUANCE OF THE FINAL CONSTRUCTION SET WHICH WILL CONTAIN NO "BID SET" DESIGNATIONS. CONSTRUCTION DOCUMENTS IDENTIFIED AS "BID SET" ARE NOT TO BE CONSTRUCTED AS BEING THE COMPLETED OR FINAL DRAWINGS AND THEY SHOULD NOT IN ANY WAY BE USED AS SUCH.
14. ALL STANDARD NOTES CONTAINED HEREIN ARE TYPICAL UNLESS NOTED OTHERWISE.
15. TYPICAL DETAILS AND SPECIFICATIONS ARE MINIMUM REQUIREMENTS TO BE USED WHEN CONDITIONS ARE NOT SHOWN OTHERWISE.
16. SPECIFIC NOTES AND DETAILS ON DRAWINGS SHALL TAKE PRECEDENCE OVER GENERAL NOTES AND TYPICAL DETAILS. WHERE NO DETAILS ARE SHOWN CONSTRUCTION SHALL CONFORM TO SIMILAR WORK ON THE PROJECT.
17. SEE ARCHITECTURAL, STRUCTURAL, ELECTRICAL, AND MECHANICAL DRAWINGS FOR PITS, TRENCHES, ROOF OPENINGS, DEPRESSIONS, ETC. NOT SHOWN ON THE OTHER DRAWINGS.
18. THE CONSTRUCTION DOCUMENTS AND ALL COPIES THEREOF FURNISHED TO CONTRACTOR ARE THE PROPERTY OF THE ARCHITECT AND ARE NOT TO BE USED ON OTHER WORK.

SITE WORK

1. CONTRACTOR SHALL INVESTIGATE SITE DURING CLEARING AND EARTHWORK OPERATIONS FOR FILLED EXCAVATIONS OR BURIED STRUCTURES SUCH AS CESSPOOLS, CISTERNS, FOUNDATIONS, ETC., AND BURIED ARTIFACTS SUCH AS INDIAN OR DINOSAUR BONES. IF ANY SUCH ITEMS ARE FOUND THE ARCHITECT, CIVIL ENGINEER, AND SOILS ENGINEER SHALL BE NOTIFIED IMMEDIATELY.
2. CONTRACTOR SHALL TAKE ALL NECESSARY MEASURES TO FULLY PROTECT ADJACENT PROPERTIES.
3. REFER TO THE SOILS REPORT AS PREPARED BY THE GEOTECHNICAL ENGINEER.
4. REFER TO CIVIL ENGINEER'S CURRENT GRADING AND PLOT PLANS.

SITE WORK (continued)

5. REFER TO THE LANDSCAPE ARCHITECT'S CURRENT GRADING PLAN AND CONSTRUCTION DOCUMENTS.
6. ALL FOOTINGS SHALL REST ON FIRM NATURAL SOIL OR APPROVED COMPACTED FILL. REFER TO GEOTECHNICAL REPORT.
7. EXCAVATIONS FOR FOOTINGS SHALL BE MADE TO THE WIDTH, LENGTH, AND DEPTH REQUIRED AND FINISHED WITH LEVEL BOTTOMS.
8. EXCAVATIONS SHALL BE KEPT FREE OF STANDING WATER.
9. WHERE EXCAVATIONS ARE MADE TO A DEPTH GREATER THAN INDICATED, SUCH ADDITIONAL DEPTH SHALL BE FILLED WITH CONCRETE AS SPECIFIED FOR FOOTINGS.
10. FILL MATERIALS SHALL BE FREE FROM DEBRIS, VEGETABLE MATTER AND OTHER FOREIGN SUBSTANCES.
11. ALL FINISH GRADES TO DRAIN AWAY FROM THE BUILDING FOOTINGS.
12. THERE SHALL BE NO ON-SITE WATER RETENTION.
13. THERE SHALL BE NO DRAINAGE TO ADJACENT PROPERTY.
14. FOR ONSITE CONSTRUCTION, PLANS TO COMPLY WITH NECESSARY INSPECTIONS APPROVED BY THE BUILDING OFFICIAL.
15. THE REQUIREMENTS IN THESE NOTES ARE THE MINIMUM THAT SHALL BE MET. REQUIREMENTS OF THE STRUCTURAL DRAWINGS THAT EXCEED THE REQUIREMENTS SHOWN HERE SHALL BE MET.

CONCRETE

1. REFER TO STRUCTURAL ENGINEERING CALCULATIONS AND SOILS REPORT FOR THE PERFORMANCE REQUIREMENTS FOR CONCRETE FOUNDATIONS.
2. CONCRETE SHALL BE PROPORTIONED TO PROVIDE AN AVERAGE COMPRESSIVE STRENGTH AS PRESCRIBED IN THE N.C.-R, AS WELL AS SATISFY THE DURABILITY CRITERIA OF THE N.C.-R.
3. MIXING OF CONCRETE SHALL BE PERFORMED IN ACCORDANCE WITH ACI 318, SECTION 5.8.
4. THE DEPOSITING OF CONCRETE SHALL COMPLY WITH THE PROVISIONS ACI 318, SECTION 5.10.
5. THE CURING OF CONCRETE SHALL BE IN ACCORDANCE WITH ACI 318, SECTION 5.11.
6. ALL FORM WORK SHALL BE DESIGNED, CONSTRUCTED, UTILIZED, AND REMOVED.
7. CONDUIT, PIPES AND SLEEVES OF ANY MATERIAL NOT HARMFUL TO CONCRETE AND WITHIN THE LIMITATIONS OF ACI 318, SECTION 6.3, ARE PERMITTED TO BE EMBEDDED IN CONCRETE WITH APPROVAL OF THE REGISTERED DESIGN PROFESSIONAL.
8. CONSTRUCTION JOINTS INCLUDING THEIR LOCATION SHALL COMPLY WITH THE PROVISIONS OF ACI 318, SECTION 6.4.
9. ALL STEEL REINFORCING OF CONCRETE SHALL BE DONE IN ACCORDANCE WITH THE N.C.-R.
10. TOP OF CONCRETE SLABS TO BE A MINIMUM 4" W/ MASONRY VENEER 6" ELSEWHERE (Ø H.U.D.) ABOVE FINISH GRADE.
11. FOUNDATION WIDTHS, DEPTHS, AND REINFORCING, AS SHOWN ON PLANS, ARE SUPERSEDED BY ANY LOCAL CODES OR ORDINANCES WHICH REQUIRE INCREASES OF THE SAME.
12. ALL REINFORCEMENT, CONDUIT, OUTLET BOXES, ANCHORS, HANGERS, SLEEVES, BOLTS OR OTHER EMBEDDED MATERIALS AND ITEMS MUST BE SECURED AND APPROPRIATELY FASTENED IN THEIR PROPER LOCATIONS PRIOR TO THE PLACEMENT OF CONCRETE. SUB-CONTRACTOR SHALL VERIFY INSTALLATION OF HOLD-DOWNS, ANCHOR BOLTS, PA STRAPS, AND OTHER ANCHORAGE MATERIAL AND ITEMS PRIOR TO PLACEMENT OF CONCRETE.
13. POST-TENSION SLABS, IF APPLICABLE:
 - A. POINT AND LINE LOADS FROM STRUCTURE ABOVE TO BE PROVIDED TO POST-TENSION ENGINEER PRIOR TO POST-TENSION DESIGN.
 - B. ANCHOR BOLTS AND OTHER HARDWARE TO BE SHOWN ON POST-TENSION PLANS TO AVOID MIS-LOCATION OF HARDWARE AND POSSIBLE FIELD FIXES WHICH MAY CUT TENDONS.

MASONRY

1. ALL MASONRY DESIGN SHALL FOLLOW THE REQUIREMENTS OF THE CURRENT ADOPTED CODES.
2. ANCHORED MASONRY VENEER SHALL COMPLY WITH THE PROVISIONS OF N.C.-R, AND SECTIONS 6.1 AND 6.2 OF ACI 530/ASCE 5/TMS 402.
3. STONE VENEER UNITS NOT EXCEEDING 5 INCHES IN THICKNESS SHALL BE ANCHORED DIRECTLY TO MASONRY, CONCRETE OR TO STUD CONSTRUCTION BY ONE OF THE APPROVED METHODS LISTED IN THE N.C.-R.
4. MORTAR FOR USE IN MASONRY CONSTRUCTION SHALL COMPLY WITH ASTM C 270. THE TYPE OF MORTAR SHALL BE IN ACCORDANCE WITH THE N.C.-R AND SHALL MEET THE PROPORTION SPECIFICATIONS OR THE PROPERTY SPECIFICATIONS OF ASTM C 270.
5. GROUT SHALL CONSIST OF FIBER CEMENT MATERIAL AND AGGREGATE IN ACCORDANCE WITH ASTM C 476 AND THE PROPORTION SPECIFICATIONS PER THE N.C.-R.
6. AGGREGATES FOR MORTAR AND GROUT SHALL BE NATURAL SAND AND ROCK CONFORMING TO A.S.T.M. C-144-04 (MASONRY MORTAR) AND C-404-07 (GROUT).
7. CEMENT SHALL BE PORTLAND CEMENT CONFORMING TO A.S.T.M. C 150.
8. ALL BRICK SHALL CONFORM TO A.S.T.M. C 216, GRADE MM.
9. UNLESS SPECIFICALLY SHOWN OTHERWISE ALL BRICK SHALL BE LAID IN A RUNNING BOND PATTERN.
10. ANCHORS, TIES AND WIRE FABRIC SHALL CONFORM TO N.C.-R.
11. ANCHOR TIES AND WIRE FABRIC FOR USE IN MASONRY WALL CONSTRUCTION SHALL CONFORM TO THE N.C.-R.

METALS

1. REFER TO STRUCTURAL NOTES AND SPECIFICATIONS FOR STRUCTURAL STEEL, METAL AND REINFORCING STEEL SPECIFICATIONS.
2. ALL STRUCTURAL STEEL SHALL CONFORM TO AISC/A660.
3. ANCHOR RODS SHALL BE SET ACCURATELY TO THE PATTERN AND DIMENSIONS CALLED FOR ON THE PLANS. THE PROTRUSION OF THE THREADED ENDS THROUGH THE CONNECTED MATERIAL SHALL BE SUFFICIENT TO FULLY ENGAGE THE THREADS OF THE NUTS, BUT SHALL NOT BE GREATER THAN THE LENGTH OF THE THREADS ON THE BOLTS.
4. FASTENERS FOR PRESERVATIVE-TREATED AND FIRE-RETARDANT-TREATED WOOD SHALL BE OF HOT-DIPPED ZINC COATED GALVANIZED STEEL, STAINLESS STEEL, SILICON BRONZE OR COPPER. VERIFY ACCEPTABLE FASTENERS PER CHEMICALS USED IN PRESSURE PRESERVATIVELY TREATED WOOD W/ N.C.-R. FASTENINGS FOR WOOD FOUNDATIONS SHALL BE AS REQUIRED IN AF&PA TECHNICAL REPORT NO. 7.

WOOD & FRAMING

LUMBER

1. THE DESIGN AND CONSTRUCTION OF CONVENTIONAL LIGHT-FRAME WOOD CONSTRUCTION SHALL BE IN ACCORDANCE WITH THE PROVISIONS OF THE N.C.-R.
2. CONSTRUCTION, PROJECTIONS, OPENINGS AND PENETRATIONS OF EXTERIOR WALLS OF DWELLINGS AND ACCESSORY BUILDINGS SHALL COMPLY WITH TABLE R502.1.
3. ALL LUMBER SHALL MEET THE STANDARDS OF QUALITY AS STATED IN THE N.C.-R.
4. LUMBER AND PLYWOOD REQUIRED TO BE PRESSURE PRESERVATIVELY TREATED IN ACCORDANCE WITH THE N.C.-R AND SHALL BEAR THE QUALITY MARK OF AN APPROVED INSPECTION AGENCY THAT MAINTAINS CONTINUING SUPERVISION, TESTING AND INSPECTION OVER THE QUALITY OF THE PRODUCT AND THAT HAS BEEN APPROVED BY AN ACCREDITATION BODY THAT COMPLIES WITH THE REQUIREMENTS OF THE AMERICAN LUMBER STANDARD COMMITTEE TREATED WOOD PROGRAM.
5. ALL LUMBER SIZES NOTED AND SPECIFIED ON PLANS ARE NOMINAL SIZES UNLESS SPECIFICALLY INDICATED AS NET SIZE.

GLUE LAMINATED LUMBER

1. REFER TO THE STRUCTURAL ENGINEER'S CURRENT NOTES, CALCULATIONS, AND SPECIFICATIONS.
2. GLUED LAMINATED TIMBERS SHALL BE MANUFACTURED AND IDENTIFIED AS REQUIRED IN AITC A140.1 AND ASTM D 3757.

PROTECTION AGAINST DECAY & TERMITES

1. IN AREAS SUBJECT TO DECAY DAMAGE AS ESTABLISHED BY THE N.C.-R THE FOLLOWING LOCATIONS SHALL REQUIRE THE USE OF NATURALLY DURABLE WOOD OR WOOD THAT IS PRESERVATIVELY TREATED IN ACCORDANCE WITH AVPA II FOR THE SPECIES, PRODUCT, PRESERVATIVE AND END USE. PRESERVATIVES SHALL BE LISTED IN SECTION 4 OF AVPA II
 1. WOOD JOISTS OR THE BOTTOM OF WOOD FLOOR WHEN CLOSER THAN 18 INCHES OR WOOD GIRDBERS WHEN CLOSER THAN 12 INCHES TO THE EXPOSED GROUND IN CRAWL SPACES OR UNEXCAVATED AREAS LOCATED WITHIN THE PERIPHERY OF THE BUILDING FOUNDATION.
 2. ALL EXTERIOR SILLS & PLATES THAT REST ON CONCRETE OR MASONRY EXTERIOR FOUNDATION WALLS.
 3. SILLS AND SLEEPERS ON A CONCRETE OR MASONRY, UNLESS THE SLAB THAT IS IN DIRECT CONTACT WITH THE GROUND IS SEPARATED FROM THE GROUND BY AN APPROVED IMPERVIOUS MOISTURE BARRIER.
 4. THE ENDS OF WOOD GIRDBERS ENTERING EXTERIOR MASONRY OR CONCRETE WALLS HAVING CLEARANCES OF LESS THAN 0.5 INCH ON TOPS, SIDES AND ENDS.
 5. WOOD SIDING AND SHEATHING ON THE EXTERIOR OF A BUILDING HAVING A CLEARANCE OF LESS THAN 6 INCHES FROM THE GROUND.
 6. WOOD STRUCTURAL MEMBERS SUPPORTING MOISTURE-PERMEABLE FLOORS OR ROOFS THAT ARE EXPOSED TO THE WEATHER, SUCH AS CONCRETE OR MASONRY SLABS, UNLESS SEPARATED FROM SUCH FLOORS OR ROOFS BY AN IMPERVIOUS MOISTURE BARRIER.
 7. WOOD FURRING STRIPS OR OTHER WOOD FRAMING MEMBERS ATTACHED DIRECTLY TO THE INTERIOR OF EXTERIOR MASONRY WALLS OR CONCRETE WALLS BELOW GRADE EXCEPT WHERE AN APPROVED VAPOR RETARDER IS APPLIED BETWEEN THE WALL AND THE FURRING STRIPS OR FRAMING MEMBERS.
 8. ALL PORTIONS OF A PORCH, SCREEN PORCH OR DECK FROM THE BOTTOM OF THE HEADER DOWN, INCLUDING POSTS, GUARDRAILS, PICKETS, STEPS AND FLOOR STRUCTURE COVERINGS THAT WOULD PREVENT MOISTURE OR WATER ACCUMULATION ON THE SURFACE OR AT JOINTS BETWEEN MEMBERS ARE ALLOWED.
2. IN AREAS SUBJECT TO DAMAGE FROM TERMITES METHODS OF PROTECTION SHALL BE ONE OF THE METHODS LISTED IN THE N.C.-R.
3. WHERE JOISTS, TRUSSES OR RAFTERS ARE SPACED MORE THAN 16 INCHES ON CENTER AND THE BEARING STUDS BELOW ARE SPACED 24 INCHES ON CENTER, SUCH MEMBERS SHALL BEAR WITHIN 3 INCHES OF THE STUDS BENEATH. SEE EXCEPTIONS.
4. UNDER-FLOOR AREAS SHALL BE VENTILATED IN ACCORDANCE WITH THE REQUIREMENTS OF THE N.C.-R.

WOOD & FRAMING (continued)

SHEATHING

1. WOOD STRUCTURAL PANELS SHALL CONFORM TO THE REQUIREMENTS AS SET FORTH IN THE N.C.-R.
2. ROOF SHEATHINGS PANELS SHALL BE LAID WITH FACE GRAIN OR STRENGTH AXIS PERPENDICULAR TO SUPPORTS AND WITH PANEL CONTINUOUS OVER TWO OR MORE SPANS.
3. ROOF SHEATHING SHALL BE IN ACCORDANCE WITH THE N.C.-R.
4. FLOOR SHEATHINGS PANELS SHALL BE LAID WITH FACE GRAIN OR STRENGTH AXIS PERPENDICULAR TO SUPPORTS AND WITH PANEL CONTINUOUS OVER TWO OR MORE SPANS.
5. STRUCTURAL FLOOR SHEATHINGS SHALL COMPLY WITH THE PROVISIONS OF THE N.C.-R.
6. REFER TO THE STRUCTURAL ENGINEER'S CURRENT SPECIFICATIONS, CALCULATIONS, AND PLANS FOR REQUIRED STRENGTH, GRADE, AND THICKNESS FOR PLYWOOD FLOOR SHEATHING PANELS AND FOR DIAPHRAGM NAILING AND ADHESIVE REQUIREMENTS.
7. ALL VERTICAL JOINTS OF PANEL SHEATHINGS SHALL OCCUR OVER, AND BE FASTENED TO, COMMON STUDS. HORIZONTAL JOINTS IN BRACED WALL PANELS SHALL OCCUR OVER, AND BE FASTENED TO, COMMON BLOCKING OF A MINIMUM OF 1 1/2 INCH THICKNESS.
8. WHERE APPLICABLE, REFER TO THE SHEAR WALL SCHEDULE FOR REQUIRED STRENGTH, GRADE, AND THICKNESS OF PLYWOOD SHEAR PANELS AND FOR REQUIRED SHEAR WALL NAILING SCHEDULE.
9. IN ONE- AND TWO-FAMILY DWELLING CONSTRUCTION USING HARD BOARD OR ALUMINUM AS A SOFFIT MATERIAL, THE SOFFIT MATERIAL SHALL BE SECURELY ATTACHED TO FRAMING MEMBERS AND USE AN UNDERLAYMENT MATERIAL OF EITHER FIRE RETARDANT TREATED WOOD, 23/32 INCH WOOD SHEATHING OR 5/8 INCH GYPSUM BOARD. VENTING REQUIREMENTS APPLY TO BOTH SOFFIT AND UNDERLAYMENT AND SHALL BE PER SECTION R506 OF THE NORTH CAROLINA RESIDENTIAL CODE. WHERE THE PROPERTY LINE IS 10 FEET OR MORE FROM THE BUILDING FACE, THE PROVISIONS OF THIS CODE SECTION DO NOT APPLY.

FLOOR FRAMING

1. ALL FLOOR JOISTS SHALL BE DESIGNED I-JOIST WOOD FLOOR TRUSSES. REFER TO MANUFACTURER FOR ALL LAYOUTS AND CALCULATIONS.
2. REFER TO THE STRUCTURAL ENGINEER'S CURRENT PLANS & CALCULATIONS FOR SIZE, SPACING, AND ANCHORAGE OF ALL FLOOR JOISTS, SIZE, LOCATION, AND ANCHORAGE OF ALL FLOOR BEAMS AND HEADERS, AND ALL RELATED FRAMING ISSUES.

ROOF FRAMING

1. ROOF FRAMING SHALL BE BY PRE-MANUFACTURED ROOF TRUSSES SPACED AT 24 INCHES ON CENTER UNLESS NOTED OTHERWISE.
2. WOOD TRUSSES SHALL BE DESIGNED IN ACCORDANCE WITH THE REQUIREMENTS OF THE N.C.-R.
3. THE MANUFACTURER SHALL SUPPLY TO THE ARCHITECT AND BUILDER CALCULATIONS AND SHOP DRAWINGS FOR APPROVAL OF DESIGN LOADS, CONFIGURATION (2 OR 3 POINT BEARING), VOLUME CEILING OPTIONS, AND SHEAR TRANSFER, PRIOR TO FABRICATION.
4. THE BRACING OF WOOD TRUSSES SHALL COMPLY TO THEIR APPROPRIATE ENGINEERED DESIGN PER THE N.C.-R.
5. TRUSS MEMBERS SHALL NOT BE CUT, NOTCHED, DRILLED, SPLICED OR OTHERWISE ALTERED IN ANY WAY WITHOUT THE APPROVAL OF A REGISTERED DESIGN PROFESSIONAL. ALTERATIONS RESULTING IN THE ADDITION OF LOAD (E.G. HVAC EQUIPMENT, WATER HEATER) THAT EXCEEDS THE DESIGN LOAD FOR THE TRUSSES SHALL NOT BE PERMITTED WITHOUT WRITTEN VERIFICATION THAT THE TRUSS IS CAPABLE OF SUPPORTING SUCH ADDITIONAL LOADING.
6. ALL CALCULATIONS AND SHOP DRAWINGS SHALL BE SIGNED BY A PROFESSIONAL ENGINEER REGISTERED IN THE STATE WHEREIN THE PROJECT IS TO BE BUILT.
7. MANUFACTURER IS TO SECURE BUILDING DEPARTMENT APPROVAL OF CALCULATIONS AND SHOP DRAWINGS PRIOR TO FABRICATION.

WALL FRAMING

1. THE SIZE, HEIGHT, AND SPACING OF STUDS SHALL BE IN ACCORDANCE WITH THE N.C.-R.
2. STUDS SHALL BE PLACED WITH THEIR WIDE DIMENSION PERPENDICULAR TO THE WALL.
3. NOT LESS THAN THREE STUDS SHALL BE INSTALLED AT EACH CORNER OF AN EXTERIOR WALL.
4. WOOD STUD WALLS SHALL BE CAPPED WITH A DOUBLE TOP PLATE INSTALLED TO PROVIDE OVERLAPPING AT CORNERS AND INTERSECTIONS WITH BEARING PARTITIONS. END JOINTS IN TOP PLATES SHALL BE OFFSET AT LEAST 24 INCHES. JOINTS NEED NOT OCCUR OVER STUDS. PLATES SHALL BE NOT LESS THAN 2-INCHES NOMINAL THICKNESS AND HAVE A WIDTH AT LEAST EQUAL TO THE WIDTH OF THE STUDS. SEE EXCEPTIONS.
5. WHERE JOISTS, TRUSSES OR RAFTERS ARE SPACED MORE THAN 16 INCHES ON CENTER AND THE BEARING STUDS BELOW ARE SPACED 24 INCHES ON CENTER, SUCH MEMBERS SHALL BEAR WITHIN 3 INCHES OF THE STUDS BENEATH. SEE EXCEPTIONS.
6. STUDS SHALL HAVE FULL BEARINGS ON NOMINAL 2 BY OR LARGER PLATE OR SILL HAVING A WIDTH AT LEAST EQUAL TO THE WIDTH OF THE STUDS.
7. INTERIOR NONBEARING WALLS SHALL BE PERMITTED TO BE CONSTRUCTED WITH 2-INCH-BY-8-INCH STUDS SPACED 24 INCHES ON CENTER OR, WHEN NOT A PART OF A BRACED WALL, LINE 2-INCH-BY-4-INCH FLAT STUDS SPACED 16 INCHES ON CENTER. INTERIOR NONBEARING WALLS SHALL BE CAPPED WITH AT LEAST A SINGLE TOP PLATE. INTERIOR NONBEARING WALLS SHALL BE FIREBLOCKED IN ACCORDANCE WITH THE N.C.-R.

WOOD & FRAMING (continued)

8. DRILLING AND NOTCHING OF STUDS SHALL BE IN ACCORDANCE WITH THE FOLLOWING:
 1. NOTCHING, ANY STUD IN AN EXTERIOR WALL OR BEARING PARTITION MAY BE CUT OR NOTCHED TO A DEPTH NOT EXCEEDING 25 PERCENT OF ITS WIDTH. STUDS IN NONBEARING PARTITIONS MAY BE NOTCHED TO A DEPTH NOT TO EXCEED 40 PERCENT OF A SINGLE STUD WIDTH. NOTCHING OF BEARING STUDS SHALL BE ON ONE EDGE ONLY AND NOT TO EXCEED ONE-FOURTH THE HEIGHT OF THE STUD. NOTCHING SHALL NOT OCCUR IN THE BOTTOM OR TOP 6 INCHES OF BEARING STUDS.
 2. DRILLING, ANY STUD MAY BE BORED OR DRILLED, PROVIDED THAT THE DIAMETER OF THE RESULTING HOLE IS NO MORE THAN 60 PERCENT OF THE STUD WIDTH, THE EDGE OF THE HOLE IS NO MORE THAN 5/8" INCH TO THE EDGE OF THE STUD, AND THE HOLE SHALL NOT BE CLOSER THAN 6 INCHES FROM AN ADJACENT HOLE OR NOTCH. HOLES NOT EXCEEDING 3/4 INCH DIAMETER CAN BE AS CLOSE AS 1 1/2 INCHES ON CENTER SPACING. STUDS LOCATED IN EXTERIOR WALLS OR BEARING PARTITIONS DRILLED OVER 40 PERCENT AND UP TO 60 PERCENT SHALL ALSO BE DOUBLED WITH NO MORE THAN TWO SUCCESSIVE DOUBLED STUDS BORED.
 3. CUTTING AND NOTCHING OF STUDS SHALL BE PERMITTED TO BE INCREASED TO 65 PERCENT OF THE WIDTH OF THE STUD IN EXTERIOR AND INTERIOR WALLS AND BEARING PARTITIONS, PROVIDED THAT ONE OF THE FOLLOWING CONDITIONS ARE MET:
 - (a) THE WALL SECTION IS REINFORCED WITH 1/2-INCH EXTERIOR GRADE PLYWOOD OR EQUIVALENT REINFORCEMENT ON THE NOTCHED SIDE OF THE WALL. PLYWOOD, IF USED, SHALL REACH FROM THE FLOOR TO CEILING AND AT LEAST ONE STUD FURTHER ON EACH SIDE OF THE SECTION THAT HAS BEEN NOTCHED OR CUT.
 - (b) THE EXTERIOR WALLS OF A KITCHEN MAY BE REINFORCED BY PLACING 1/2-INCH PLYWOOD OR EQUIVALENT REINFORCEMENT ON THE NOTCHED SIDE OF THE WALL. PLYWOOD, IF USED, SHALL REACH FROM THE FLOOR TO COUNTER-TOP HEIGHT AND AT LEAST ONE STUD FURTHER ON EACH SIDE OF THE SECTION THAT HAS BEEN NOTCHED OR CUT.
 4. WHEN PIPING OR DUCTWORK IS PLACED IN OR PARTIALLY IN AN EXTERIOR OR INTERIOR LOAD-BEARING WALL, NECESSITATING CUTTING, DRILLING OR NOTCHING OF THE TOP PLATE 50 PERCENT OF ITS WIDTH, A GALVANIZED METAL TIE OF NOT LESS THAN 0.254 INCH THICK AND 1 1/2 INCHES WIDE SHALL BE FASTENED ACROSS AND TO THE PLATE AT EACH SIDE OF THE OPENING WITH NOT LESS THAN EIGHT 10# NAILS HAVING A MINIMUM LENGTH OF 1 1/2 INCHES (38 MM) AT EACH SIDE OR EQUIVALENT. THE METAL TIE MUST EXTEND A MINIMUM OF 6 INCHES PAST THE OPENING.
 5. HEADERS SHALL MEET THE REQUIREMENTS OF THE N.C.-R.
 6. PROVIDE LATERAL BRACING PER THE N.C.-R.
 7. FOUNDATION CRIPPLE WALLS SHALL MEET THE REQUIREMENTS OF THE N.C.-R CODE.
 8. WOOD STUD WALLS SHALL BE BRACED AS REQUIRED BY THE N.C.-R.
 9. UNLESS COVERED BY INTERIOR OR EXTERIOR WALL COVERINGS OR SHEATHING MEETING THE MINIMUM REQUIREMENTS OF THIS CODE, ALL STUD PARTITIONS OR WALLS WITH STUDS HAVING A HEIGHT-TO-LEAST THICKNESS RATIO EXCEEDING 50 SHALL HAVE BRISINGS NOT LESS THAN 2 INCHES IN THICKNESS AND OF THE SAME WIDTH AS THE STUDS FITTED SNUGLY AND NAILED THERETO TO PROVIDE ADEQUATE LATERAL SUPPORT.

FIRE BLOCKS AND DRAFT STOPS

1. FIRE BLOCKING SHALL BE PROVIDED TO CUT OFF ALL CONCEALED DRAFT OPENINGS (BOTH VERTICAL AND HORIZONTAL) AND TO FORM AN EFFECTIVE BARRIER BETWEEN STORIES, AND BETWEEN A TOP STORY AND A ROOF SPACE. FIREBLOCKING SHALL BE PROVIDED IN WOOD-FRAME CONSTRUCTION IN THE LOCATIONS SPECIFIED IN THE N.C.-R.
2. FIRE BLOCKING SHALL CONSIST OF 2 INCHES NOMINAL LUMBER OR TWO THICKNESSES OF 1-INCH NOMINAL LUMBER WITH BROKEN LAP JOINTS, OR ONE THICKNESS OF 23/32-INCH WOOD STRUCTURAL PANELS WITH JOINTS BACKED BY 23/32-INCH WOOD STRUCTURAL PANELS OR ONE THICKNESS OF 3/4-INCH PARTICLEBOARD WITH JOINTS BACKED BY 3/4-INCH PARTICLEBOARD, 1/2-INCH GYPSUM BOARD, OR 1/4-INCH CEMENT-BASED MILLBOARD.
3. BATTS OR BLANKETS OF MINERAL WOOL OR GLASS FIBER OR OTHER APPROVED MATERIALS INSTALLED IN SUCH A MANNER AS TO BE SECURELY RETAINED IN PLACE SHALL BE PERMITTED AS AN ACCEPTABLE FIRE BLOCK.
4. BATTS OR BLANKETS OF MINERAL OR GLASS FIBER OR OTHER APPROVED NON-RIGID MATERIALS SHALL BE PERMITTED FOR COMPLIANCE WITH THE 10 FOOT HORIZONTAL FIREBLOCKING IN WALLS CONSTRUCTED USING PARALLEL ROYS OF STUDS OR STAGGERED STUDS. LOOSE FILL INSULATION MATERIAL SHALL NOT BE USED AS A FIREBLOCK UNLESS SPECIFICALLY TESTED IN THE FORM AND MANNER INTENDED FOR USE TO DEMONSTRATE ITS ABILITY TO REMAIN IN PLACE AND TO RETARD THE SPREAD OF FIRE AND HOT GASSES.
5. WHEN THERE IS USABLE SPACE BOTH ABOVE AND BELOW THE CONCEALED SPACE OF A FLOOR/CEILING ASSEMBLY, DRAFTSTOPS SHALL BE INSTALLED SO THAT THE AREA OF THE CONCEALED SPACE DOES NOT EXCEED 1,000 SQUARE FEET. DRAFTSTOPPING SHALL DIVIDE THE CONCEALED SPACE INTO APPROXIMATELY EQUAL AREAS, WHERE THE ASSEMBLY IS ENCLOSED BY A FLOOR MEMBRANE ABOVE AND A CEILING MEMBRANE BELOW. DRAFTSTOPPING SHALL BE PROVIDED IN FLOOR/CEILING ASSEMBLIES UNDER THE FOLLOWING CIRCUMSTANCES:
 1. CEILING IS SUSPENDED UNDER THE FLOOR FRAMING.
 2. FLOOR FRAMING IS CONSTRUCTED OF TRUSS-TYPE OPEN-WEB OR PERFORATED MEMBERS.

HANDRAIL AND GUARDRAIL

1. GUARDRAIL OF 36" HIGH MIN. SHALL BE PROVIDED WHERE FINISHED GRADE OR FLOOR BELOW RAISED AREA EXCEEDS 30".
2. HANDRAIL AT STAIRS SHALL BE PROVIDED WHEN 4 OR MORE STAIR RISERS ARE REQUIRED.



NORTH CAROLINA 40' SERIES

KB HOME
NORTH CAROLINA DIVISION

4506 S. MIAMI BLVD.
SUITE 180
DURHAM, NC 27703
TEL: (919) 768-7980
FAX: (919) 544-2928

2018 NORTH CAROLINA STATE BUILDING CODES

ISSUE DATE: 01/08/15
PROJECT No.: 1350999:56
DIVISION MGR.: DCS
REVISIONS: 08/20/20

- 11 DIVISION REVISION NC13654NCP - 08/22/19 - FAB
- 12 DIVISION REVISION NC19677NCP - 09/26/19 - FAB
- 13 DIVISION REVISION NC20003NCP - 12/19/19 - CL
- 14 VENTILATION NC20008NCP - 01/17/20 - CL
- 15 DIVISION REVISION NC20013NCP - 02/10/20 - MCF
- 16 DIVISION REVISION NC20017NCP - 03/04/20 - KBA
- 17 HOME OFFICE CORP20095CORP-08/20/20-CTD

FOR INTERNAL USE ONLY	
REVISION BY:	
1.	
2.	
3.	
4.	
5.	
6.	

PLAN:
238.2338

SHEET:
GN1

SPEC. LEVEL 1
RALEIGH-DURHAM
40' SERIES

MECHANICAL & PLUMBING

HVAC

- ALL MATERIALS AND CONSTRUCTION METHODS SHALL BE IN CONFORMANCE WITH THE NORTH CAROLINA RESIDENTIAL AND MECHANICAL CODE. INSTALLATIONS OF MECHANICAL APPLIANCES, EQUIPMENT AND SYSTEMS NOT ADDRESSED BY THIS CODE SHALL COMPLY WITH THE APPLICABLE PROVISIONS OF THE NORTH CAROLINA RESIDENTIAL AND FUEL GAS CODE.
- CONTRACTOR SHALL DESIGN ENTIRE H.V.A.C. SYSTEM AND SUBMIT DRAWINGS FOR OWNER/BUILDER'S APPROVAL PRIOR TO ORDERING MATERIALS OR EQUIPMENT.
- WHERE AIR CONDITIONING IS AN OPTIONAL FEATURE, HEATING SYSTEMS MUST BE DESIGNED AND DUCT WORK SIZED TO ACCOMMODATE FUTURE AIR CONDITIONING NEEDS.
- WHERE THE PRIMARY HEATING SYSTEM IS A FORCED-AIR FURNACE, AT LEAST ONE THERMOSTAT PER DWELLING UNIT SHALL BE CAPABLE OF CONTROLLING THE HEATING AND COOLING SYSTEM ON A DAILY SCHEDULE TO MAINTAIN DIFFERENT TEMPERATURE SET POINTS AT DIFFERENT TIMES OF THE DAY. THIS THERMOSTAT SHALL INCLUDE THE CAPABILITY TO SET BACK OR TEMPORARILY OPERATE THE SYSTEM TO MAINTAIN ZONE TEMPERATURES DOWN TO 55 DEG. F (15 C) OR UP TO 85 DEG. F (24 C).
- ALL DUCTWORK SHALL CONFORM TO THE REQUIREMENTS OF THE N.C.-R
- COMBUSTION AIR SHALL BE PROVIDED FOR FORCED AIR UNITS IN ACCORDANCE WITH N.C.-R
- CONTRACTOR TO PROVIDE BOOT IN DUCTWORK WHEN OPTIONAL "HONEYWELL" OR "CARRIER" ELECTRONIC AIR CLEANER IS PROVIDED.
- DUCTS IN THE GARAGE AND DUCTS PENETRATING THE WALLS OR CEILINGS SEPARATING THE DWELLING FROM THE GARAGE SHALL BE CONSTRUCTED OF A MINIMUM NO. 26 GAGE SHEET STEEL OR OTHER APPROVED MATERIAL AND SHALL HAVE NO OPENINGS INTO THE GARAGE PER N.C.-R
- EXTERIOR-GRADE INSTALLATIONS, EQUIPMENT AND APPLIANCES INSTALLED ABOVE GRADE LEVEL SHALL BE SUPPORTED ON A SOLID BASE OR APPROVED MATERIAL A MINIMUM OF 2 INCHES THICK.
- UNDER-FLOOR INSTALLATION, SUSPENDED EQUIPMENT SHALL BE A MINIMUM OF 6 INCHES ABOVE THE ADJOINING GRADE.
- CRAWL SPACE SUPPORTS, IN A CRAWL SPACE A MINIMUM OF 2-INCH THICK SOLID BASE, 2-INCH (51 MM) THICK FORMED CONCRETE OR STACKED MASONRY UNITS HELD IN PLACE BY MORTAR OR OTHER APPROVED METHOD. THE WATER HEATER SHALL BE SUPPORTED NOT LESS THAN 2 INCHES ABOVE GRADE.
- DRAINAGE BELOW-GRADE INSTALLATIONS SHALL BE PROVIDED WITH A NATURAL DRAIN OR AN AUTOMATIC LIFT OR SUMP PUMP. FOR PIT REQUIREMENTS REFER TO N.C.-M

VENTING

- IN LIEU OF REQUIRED EXTERIOR OPENINGS FOR NATURAL VENTILATION IN BATHROOMS CONTAINING A BATHTUB, SHOWER OR COMBINATION THEREOF, A MECHANICAL VENTILATION SYSTEM MAY BE PROVIDED. THE MINIMUM VENTILATION RATES SHALL BE 50 CFM FOR INTERMITTENT VENTILATION OR 20 CFM FOR CONTINUOUS VENTILATION. VENTILATION AIR FROM THE SPACE SHALL BE EXHAUSTED DIRECTLY TO THE OUTSIDE PER N.C.-R
- EXHAUST DUCTS SHALL TERMINATE OUTSIDE THE BUILDING AND SHALL BE EQUIPPED WITH BACKDRAFT DAMPERS.
- RANGE HOODS SHALL DISCHARGE TO THE OUTDOORS THROUGH A DUCT. THE DUCT SERVING THE HOOD SHALL HAVE A SMOOTH INTERIOR SURFACE, SHALL BE AIR TIGHT, SHALL BE EQUIPPED WITH A BACKDRAFT DAMPER AND SHALL BE INDEPENDENT OF ALL OTHER EXHAUST SYSTEMS. DUCTS SERVING RANGE HOODS SHALL NOT TERMINATE IN AN ATTIC OR CRAWL SPACE OR AREAS INSIDE THE BUILDING. DUCTS SERVING RANGE HOODS SHALL BE CONSTRUCTED OF GALVANIZED STEEL, STAINLESS STEEL OR COPPER.
- WHERE INSTALLED IN ACCORDANCE WITH THE MANUFACTURER'S INSTALLATION INSTRUCTIONS, AND WHERE MECHANICAL OR NATURAL VENTILATION IS OTHERWISE PROVIDED, LISTED AND LABELED DUCTLESS RANGE HOODS SHALL NOT BE REQUIRED TO DISCHARGE TO THE OUTDOORS PER N.C.-M
- DUCTS FOR DOMESTIC KITCHEN COOKING APPLIANCES EQUIPPED WITH DOWN DRAFT EXHAUST SYSTEMS SHALL BE PERMITTED TO BE CONSTRUCTED OF SCHEDULE 40 PVC PIPE PROVIDED THAT THE INSTALLATION COMPLIES WITH ALL OF THE FOLLOWINGS PER N.C.-M:
 - THE DUCT SHALL BE INSTALLED UNDER A CONCRETE SLAB POURED ON GRADE.
 - THE UNDERFLOOR TRENCH IN WHICH THE DUCT IS INSTALLED SHALL BE COMPLETELY BACKFILLED WITH SAND OR GRAVEL.
 - THE PVC DUCT SHALL EXTEND NOT GREATER THAN 1 INCH ABOVE THE INDOOR EXTERIOR FLOOR SURFACE.
 - THE PVC DUCT SHALL EXTEND NOT GREATER THAN 1 INCH ABOVE GRADE OUTSIDE THE BUILDING.
 - THE PVC DUCTS SHALL BE SOLVENT CEMENTED.
- EXHAUST HOOD SYSTEMS CAPABLE OF EXHAUSTING IN EXCESS OF 400 CFM SHALL BE PROVIDED WITH MAKEUP AIR AT A RATE APPROXIMATELY EQUAL TO THE EXHAUST AIR RATE THAT IS IN EXCESS OF 400 CUBIC FEET PER MINUTE. SUCH MAKEUP AIR SYSTEMS SHALL BE EQUIPPED WITH A MEANS OF CLOSURE AND SHALL BE AUTOMATICALLY CONTROLLED TO START AND OPERATE SIMULTANEOUSLY WITH THE EXHAUST SYSTEM. DAMPERS SHALL BE ACCESSIBLE FOR INSPECTION, SERVICE, REPAIR AND REPLACEMENT WITHOUT REMOVING PERMANENT CONSTRUCTION
- DOMESTIC WATER HEATERS, UNLESS SPECIFIED OTHERWISE BY THE MANUFACTURER'S INSTALLATION INSTRUCTIONS, SHALL BE VENTED TO THE OUTSIDE AIR BY A TYPE 'B' VENT AND COMPLY WITH THE REQUIREMENTS OF THE N.C.-M

PLUMBING

- A POTABLE WATER SUPPLY SYSTEM SHALL BE DESIGNED, INSTALLED AND MAINTAINED IN SUCH A MANNER SO AS TO PREVENT CONTAMINATION FROM NONPOTABLE LIQUIDS, SOLIDS OR GASES BEING INTRODUCED INTO THE POTABLE WATER SUPPLY THROUGH CROSS-CONNECTIONS OR ANY OTHER PIPING CONNECTIONS TO THE SYSTEM. BACKFLOW PRE-VENTER APPLICATIONS SHALL CONFORM TO N.C.-P.
- THE SUPPLY LINES OR FITTINGS FOR EVERY PLUMBING FIXTURE SHALL BE INSTALLED SO AS TO PREVENT BACKFLOW. PLUMBING FIXTURE FITTINGS SHALL PROVIDE BACKFLOW PROTECTION IN ACCORDANCE WITH ASME A112.18.1.

MECHANICAL & PLUMBING (continued)

PLUMBING (continued)

- ALL DEVICES, APPURTENANCES, APPLIANCES AND APPARATUS INTENDED TO SERVE SOME SPECIAL FUNCTION, SUCH AS STERILIZATION, DISTILLATION, PROCESSING, COOLING, OR STORAGE OF ICE OR FOODS, AND THAT CONNECT TO THE WATER SUPPLY SYSTEM SHALL BE PROVIDED WITH PROTECTION AGAINST BACKFLOW AND CONTAMINATION OF THE WATER SUPPLY SYSTEM. WATER PUMPS, FILTERS, SOFTENERS, TANKS AND ALL OTHER APPLIANCES AND DEVICES THAT HANDLE OR TREAT POTABLE WATER SHALL BE PROTECTED AGAINST CONTAMINATION.
- WATER SERVICE PIPING SHALL BE PROTECTED IN ACCORDANCE WITH N.C.-P SECTIONS AND EXCEPTIONS)
- FIXTURE FITTINGS, FAUCETS AND DIVERTERS SHALL BE CONNECTED TO THE WATER DISTRIBUTION SYSTEM SO THAT HOT WATER CORRESPONDS TO THE LEFT SIDE OF THE FITTINGS.
- DIVERTERS FOR SINK FAUCETS WITH A SECONDARY OUTLET CONSISTING OF A FLEXIBLE HOSE AND SPRAY ASSEMBLY SHALL CONFORM TO ASTM A112.18.1 IN ADDITION TO THE REQUIREMENTS IN N.C.-P
- THE INSTALLATION OF A WATER SERVICE OR WATER DISTRIBUTION PIPE SHALL BE PROHIBITED IN SOIL AND GROUND WATER THAT IS CONTAMINATED. GROUND WATER CONDITIONS SHALL BE REQUIRED TO ASCERTAIN THE ACCEPTABILITY OF THE WATER SERVICE OR WATER DISTRIBUTION PIPING MATERIAL FOR THE SPECIFIC INSTALLATION. WHERE DETRIMENTAL CONDITIONS EXIST, APPROVED ALTERNATIVE MATERIALS OR ROUTING SHALL BE REQUIRED.
- WATER DISTRIBUTION PIPE SHALL CONFORM TO NSF 61 AND SHALL CONFORM TO ONE OF THE STANDARDS LISTED IN N.C.-PLUMBING. ALL WATER DISTRIBUTION PIPE AND TUBING SHALL HAVE A MINIMUM PRESSURE RATINGS OF 100 PSI AT 180 DEGREES F.
- PIPE PASSING THROUGH CONCRETE OR CINDER WALLS AND FLOORS OR OTHER CORROSIVE MATERIAL SHALL BE PROTECTED AGAINST EXTERNAL CORROSION BY A PROTECTIVE SHEATHING OR WRAPPING OR OTHER MEANS THAT WILL WITHSTAND ANY REACTION FROM THE LINE AND AGENT OF CONCRETE, CINDER OR OTHER CORROSIVE MATERIAL SHEATHING OR WRAPPING SHALL ALLOW FOR EXPANSION AND CONTRACTION OF PIPING TO PREVENT ANY RUBBING ACTION. MINIMUM WALL THICKNESS OF MATERIAL SHALL BE 0.025-INCH.
- PIPES PASSING UNDER OR THROUGH WALLS SHALL BE PROTECTED FROM PHYSICAL DAMAGE PER N.C.-R.
- PIPING SHALL BE INSTALLED SO AS TO PREVENT DETRIMENTAL STRAINS AND STRESSES IN THE PIPE. PROVISIONS SHALL BE MADE TO PROTECT PIPING FROM DAMAGE RESULTING FROM EXPANSION, CONTRACTION AND STRUCTURAL SETTLEMENT. PIPING SHALL BE INSTALLED TO AVOID STRUCTURAL STRESSES OR STRAINS WITHIN BUILDING COMPONENTS.
- WATER PIPES INSTALLED IN A WALL EXPOSED TO THE EXTERIOR SHALL BE LOCATED ON THE HEATED SIDE OF THE WALL INSULATION. IN OTHER CASES, WATER, SOIL AND WASTE PIPES SHALL NOT BE INSTALLED OUTSIDE OF A BUILDING, IN UNCONDITIONED ATTICS, UNCONDITIONED UTILITY ROOMS OR IN ANY OTHER PLACE SUBJECTED TO FREEZING TEMPERATURES UNLESS ADEQUATE PROVISION IS MADE TO PROTECT SUCH PIPES FROM FREEZING BY A MINIMUM OF R-6.5 INSULATION DETERMINED AT 75 DEG. F IN ACCORDANCE WITH ASTM G117 OR HEAT OR BOTH. EXTERIOR WATER SUPPLY SYSTEM PIPING SHALL BE INSTALLED NOT LESS THAN 6 INCHES BELOW THE FROST LINE AND NOT LESS THAN 12 INCHES BELOW GRADE.
- BUILDING SEWER PIPE SHALL CONFORM TO ONE OF THE STANDARDS LISTED IN N.C.-R.
- BUILDING SEWER PIPE FITTINGS SHALL BE APPROVED FOR INSTALLATION WITH THE PIPING MATERIAL, INSTALLED AND SHALL CONFORM TO THE RESPECTIVE PIPE STANDARDS OR ONE OF THE STANDARDS LISTED IN N.C.-P.
- WHERE WASTE LINE DROPS OCCUR IN A LOCATION WHERE THE SOUND OF A FLUSHING TOILET MAY BE UNDESIRABLE, SUCH AS IN WALLS OR PARTITIONS ADJACENT TO EATING ROOMS, USE CAST IRON PIPING OR SIMILAR APPROVED HARD OR DENSE PIPING TO MITIGATE SOUND.
- CLEANOUTS ON BUILDING SEWERS SHALL BE LOCATED AS SET FORTH IN N.C.-R.
- THE MAXIMUM WATER CONSUMPTION FLOW RATES AND QUANTITIES FOR ALL PLUMBING FIXTURES SHALL BE IN ACCORDANCE WITH N.C.-R.
- INDIVIDUAL SHOWER AND TUB/SHOWER COMBINATION VALVES SHALL BE EQUIPPED WITH CONTROL VALVES OF THE PRESSURE-BALANCE, THERMOSTATIC-MIXING OR COMBINATION PRESSURE-BALANCE/ THERMOSTATIC-MIXING VALVE TYPES WITH A HIGH LIMIT STOP IN ACCORDANCE WITH ASSE 1016/ ASME A112.1016/CSA B125.16. AND SHALL BE INSTALLED AND ADJUSTED PER MANUFACTURER'S INSTRUCTIONS.
- GAS AND ELECTRIC WATER HEATERS HAVING AN IGNITION SOURCE SHALL BE ELEVATED SUCH THAT THE SOURCE OF IGNITION IS NOT LESS THAN 18 INCHES ABOVE THE GARAGE FLOOR. REFER TO N.C.-R FOR EXCEPTION.
- WATER HEATERS, (USING SOLID, LIQUID OR GAS FUEL) WITH THE EXCEPTION OF THOSE HAVING DIRECT VENT SYSTEMS, SHALL NOT BE INSTALLED IN BATHROOMS AND BEDROOMS OR IN A CLOSET WITH ACCESS ONLY THROUGH A BEDROOM OR BATHROOM. HOWEVER, WATER HEATERS OF THE AUTOMATIC STORAGE TYPE MAY BE INSTALLED AS REPLACEMENT IN A BATHROOM, WHEN APPROVED BY THE PLUMBING OFFICIAL, PROVIDED THEY ARE VENTED AND SUPPLIED WITH ADEQUATE COMBUSTION AIR.
- IN SEISMIC DESIGN CATEGORIES DO, D1 AND D2 AND TOWNHOUSES IN SEISMIC DESIGN CATEGORY C, WATER HEATERS SHALL BE ANCHORED OR STRAPPED IN THE UPPER ONE-THIRD AND IN THE LOWER ONE-THIRD OF THE APPLIANCE TO RESIST A HORIZONTAL FORCE EQUAL TO ONE-THIRD OF THE OPERATING WEIGHT OF THE WATER HEATER, ACTING IN ANY HORIZONTAL DIRECTION, OR IN ACCORDANCE WITH THE APPLIANCE MANUFACTURER'S RECOMMENDATIONS.
- APPLIANCES LOCATED IN A GARAGE OR CARPORT SHALL BE PROTECTED FROM IMPACT BY A MOVING VEHICLE.
- WHERE WATER HEATERS OR HOT WATER STORAGE TANKS ARE INSTALLED IN REMOTE LOCATIONS SUCH AS SUSPENDED CEILINGS, ATTICS, ABOVE OCCUPIED SPACES, OR UNVENTILATED CRAWL SPACES, A LOCATION WHERE WATER LEAKAGE FROM THE TANK WILL CAUSE DAMAGE TO PRIMARY STRUCTURAL MEMBERS, THE TANK OR WATER HEATER SHALL BE INSTALLED IN A GALVANIZED STEEL PAN HAVING A MINIMUM THICKNESS OF 24 GAGE, OR OTHER PANS APPROVED FOR SUCH USE.
- WHERE CLOTHES WASHING MACHINES ARE LOCATED ON WOOD FRAMED FLOORS, THE CASKAGE SHOULD BE DAMAGED, A GALVANIZED STEEL PAN HAVING A MINIMUM THICKNESS OF 24 GAGE, OR OTHER PANS APPROVED FOR SUCH USE SHALL BE PROVIDED.

MECHANICAL & PLUMBING (continued)

PLUMBING (continued)

- APPLIANCES AND EQUIPMENT USED FOR HEATING WATER OR STORING HOT WATER SHALL BE PROTECTED BY A SEPARATE PRESSURE-RELIEF VALVE AND A SEPARATE TEMPERATURE-RELIEF VALVE OR A COMBINATION PRESSURE AND TEMPERATURE RELIEF VALVE. RELIEF VALVES SHALL HAVE A MINIMUM RATED CAPACITY FOR THE EQUIPMENT SERVED AND SHALL CONFORM TO ANSI Z21.22. THE RELIEF VALVE SHALL NOT BE USED AS A MEANS OF CONTROLLING THERMAL EXPANSION.
- THE WATER SUPPLY TO A DISHWASHER SHALL BE PROTECTED AGAINST BACKFLOW BY AN AIR GAP COMPLYING WITH ASME A112.15 OR A112.12 THAT IS INSTALLED INTERNALLY WITHIN THE MACHINE OR A BACKFLOW PREVENTER IN ACCORDANCE WITH THE N.C.-R.
- SINK AND DISHWASHER. THE COMBINED DISCHARGE FROM A DISHWASHER AND A ONE- OR TWO-COMPARTMENT SINK, WITH OR WITHOUT A FOOD-WASTE DISPOSER, SHALL BE SERVED BY A TRAP OF NOT LESS THAN 1 1/2 INCHES (38 MM) IN OUTSIDE DIAMETER. THE DISHWASHER DISCHARGE PIPE OR TUBING SHALL RISE TO THE UNDERSIDE OF THE COUNTER AND SHALL BE SECURELY FASTENED TO THE UNDERSIDE OF THE SINK RIM OR COUNTER BEFORE CONNECTING TO THE HEAD OF THE FOOD-WASTE DISPOSER OR TO A WYE FITTING IN THE SINK TAILPIECE.

FIREPLACES

- FACTORY-BUILT FIREPLACES SHALL BE LISTED AND LABELED AND SHALL BE INSTALLED IN ACCORDANCE WITH THE CONDITIONS OF THE LISTINGS. FACTORY-BUILT FIREPLACES SHALL BE TESTED IN ACCORDANCE WITH UL 127.
- FIREPLACES ARE TO BE PROVIDED WITH AN EXTERIOR AIR SUPPLY

ELECTRICAL

- ALL MATERIALS AND APPLIANCES, INSTALLATION AND CONSTRUCTION METHODS SHALL COMPLY WITH THE NATIONAL ELECTRICAL CODE OR CURRENT SAE REQUIREMENTS.
- ALL ELECTRICAL SYSTEMS, CIRCUITS, FIXTURES AND EQUIPMENT SHALL BE GROUNDED IN A MANNER COMPLYING WITH ARTICLE 250 OF THE NATIONAL ELECTRICAL CODE.
- ALL WIRING SHALL BE SO INSTALLED THAT, WHEN COMPLETED, THE SYSTEM WILL BE FREE FROM SHORT CIRCUITS AND FROM GROUNDS OTHER THAN AS REQUIRED OR PERMITTED IN N.E.C. ARTICLE 250.
- ELECTRIC EQUIPMENT SHALL BE INSTALLED IN A NEAT AND WORK-MANLIKE MANNER.
- ALL 125-VOLT, SINGLE-PHASE, 15- AND 20-AMPERE RECEPTACLES INSTALLED IN THE LOCATIONS SPECIFIED BELOW SHALL HAVE GROUND-FAULT CIRCUIT-INTERRUPTER PROTECTION FOR PERSONNEL. THE GROUND-FAULT CIRCUIT-INTERRUPTER SHALL BE INSTALLED IN A READILY ACCESSIBLE LOCATION.
 - BATHROOMS.
 - GARAGES AND ALSO ACCESSORY BUILDINGS THAT HAVE A FLOOR LOCATED AT OR BELOW GRADE LEVEL, NOT INTENDED AS HABITABLE ROOMS AND LIMITED TO STORAGE AREAS, WORK AREAS, AND AREAS OF SIMILAR USE.
 - OUTDOORS.
 - CRAWL SPACES, WHERE THE CRAWL SPACE IS AT OR BELOW GRADE LEVEL.
 - UNFINISHED PORTIONS OR AREAS OF THE BASEMENT NOT INTENDED AS HABITABLE ROOMS.
 - KITCHENS, WHERE THE RECEPTACLES ARE INSTALLED TO SERVE THE COUNTERTOP SURFACES.
 - SINKS, WHERE RECEPTACLES ARE INSTALLED WITHIN 6 FT FROM THE TOP INSIDE EDGE OF THE BOWL OF THE SINK.
 - BOAT HOUSES.
 - BATHTUBS OR SHOWER STALLS - WHERE RECEPTACLES ARE INSTALLED WITHIN 6' OF THE OUTSIDE EDGE OF THE BATHTUB OR SHOWER STALL.
 - LAUNDRY AREAS

- DISHWASHER - GFCI PROTECTION IS NOT REQUIRED FOR OUTLETS THAT SUPPLY DISHWASHERS INSTALLED IN DWELLING UNIT LOCATIONS.
- CRAWL SPACE LIGHTING OUTLETS, GFCI PROTECTION SHALL BE PROVIDED FOR LIGHTING OUTLETS NOT EXCEEDING 120 VOLTS INSTALLED IN CRAWL SPACES.

- APPLIANCE RECEPTACLE OUTLETS INSTALLED IN A DWELLING UNIT FOR SPECIFIC APPLIANCES, SUCH AS LAUNDRY EQUIPMENT, SHALL BE INSTALLED WITHIN 6 FEET OF THE INTENDED LOCATION OF THE APPLIANCE.

- IN EVERY KITCHEN, FAMILY ROOM, DINING ROOM, LIVING ROOM, PARLOR, LIBRARY, DEN, SUNROOM, BEDROOM, RECREATION ROOM, OR SIMILAR ROOM OR AREA OF DWELLING UNITS, RECEPTACLE OUTLETS SHALL BE INSTALLED SO THAT NO POINT ALONG THE FLOOR LINE IN ANY WALL SPACE IS MORE THAN 6 FEET, MEASURED HORIZONTALLY FROM AN OUTLET IN THAT SPACE, INCLUDING ANY WALL SPACE 2 FEET OR MORE IN WIDTH (INCLUDING SPACE MEASURED AROUND CORNERS) AND UNBROKEN ALONG THE FLOOR LINE BY DOORWAYS AND SIMILAR OPENINGS, FIREPLACES, AND FIXED CABINETS, AND THE WALL SPACE OCCUPIED BY FIXED PANELS IN EXTERIOR WALLS, BUT EXCLUDING SLIDING PANELS IN EXTERIOR WALLS, THE WALL SPACE AFFORDED BY FIXED ROOM DIVIDERS, SUCH AS FREESTANDING BAR-TYPE COUNTERS OR RAILINGS, SHALL BE INCLUDED IN THE 6 FOOT MEASUREMENT.

SMOKE DETECTORS

- SMOKE DETECTORS SHALL BE INSTALLED IN ACCORDANCE WITH THE APPROVED MANUFACTURER'S INSTRUCTIONS AND N.C.-R 314.
- ALL SMOKE ALARMS SHALL BE LISTED IN ACCORDANCE WITH UL 217 AND INSTALLED IN ACCORDANCE WITH THE PROVISIONS OF THIS CODE AND THE HOUSEHOLD FIRE MARKING EQUIPMENT PROVISIONS OF NFPA 72. HOUSEHOLD FIRE ALARM SYSTEMS INSTALLED IN ACCORDANCE WITH NFPA 72 THAT INCLUDE SMOKE ALARMS, OR A COMBINATION OF SMOKE DETECTOR AND AUDIBLE NOTIFICATION DEVICE INSTALLED AS REQUIRED BY THE N.C.-R 314.3 FOR SMOKE ALARMS, SHALL BE PERMITTED. THE HOUSEHOLD FIRE ALARM SYSTEM SHALL PROVIDE THE SAME LEVEL OF SMOKE DETECTION AND ALARM AS REQUIRED BY THE N.C.-R FOR SMOKE ALARMS IN THE EVENT THE FIRE ALARM PANEL IS REMOVED OR THE SYSTEM IS NOT CONNECTED TO A CENTRAL STATION.
- REQUIRED SMOKE DETECTORS SHALL BE LOCATED IN ACCORDANCE WITH THE N.C.-R 314.3

ELECTRICAL (continued)

- AT LEAST ONE RECEPTACLE OUTLET SHALL BE INSTALLED AT EACH ISLAND COUNTER SPACE WITH A LONG DIMENSION OF 24 INCHES OR GREATER AND A SHORT DIMENSION OF 12 INCHES OR GREATER.
- AT LEAST ONE RECEPTACLE OUTLET SHALL BE INSTALLED AT EACH PENINSULAR COUNTER SPACE WITH A LONG DIMENSION OF 24 INCHES OR GREATER AND A SHORT DIMENSION OF 12 INCHES OR GREATER. A PENINSULAR COUNTERTOP IS MEASURED FROM CONNECTING PERPENDICULAR WALL.
- COUNTERTOP SPACES SEPARATED BY RANGE TOPS, REFRIGERATORS, OR SINKS SHALL BE CONSIDERED AS SEPARATE COUNTERTOP SPACES IN APPLYING THE REQUIREMENTS OF (1), (2), AND (3) ABOVE. IF A RANGE, COUNTER-MOUNTED COOKING UNIT OR SINK IS INSTALLED IN AN ISLAND OR PENINSULAR COUNTERTOP AND THE DEPTH OF THE COUNTER BEHIND THE ITEM IS LESS THAN 12 INCHES, IT WILL BE CONSIDERED TO DIVIDE THE COUNTERTOP SPACE INTO TWO SEPARATE COUNTERTOP SPACES. EACH COUNTERTOP SPACE SHALL COMPLY WITH APPLICABLE REQUIREMENTS.
- RECEPTACLE OUTLETS SHALL BE LOCATED NOT MORE THAN 20 INCHES ABOVE THE COUNTERTOP. RECEPTACLE OUTLETS RENDERED NOT READILY ACCESSIBLE BY APPLIANCES FASTENED IN PLACE, APPLIANCE GARAGES, SINKS, OR RANGETOPS AS COVERED IN 4) ABOVE, OR APPLIANCES OCCUPYING DEDICATED SPACE SHALL NOT BE CONSIDERED AS THESE REQUIRED OUTLETS.
- AT LEAST ONE WALL RECEPTACLE OUTLET SHALL BE INSTALLED IN BATHROOMS WITHIN 3 FEET OF THE OUTSIDE EDGE OF EACH BASIN. THE RECEPTACLE OUTLET SHALL BE LOCATED IN WALL OR PARTITION THAT IS ADJACENT TO THE BASIN OR BASIN COUNTERTOP, OR INSTALLED ON THE SIDE OR FACE OF THE BASIN CABINET NOT MORE THAN 12" BELOW THE COUNTERTOP.
- IN DWELLING UNITS, AT LEAST ONE RECEPTACLE OUTLET SHALL BE INSTALLED IN AREAS DESIGNATED FOR THE INSTALLATION OF LAUNDRY EQUIPMENT.
- IN EACH ATTACHED GARAGE AND IN EACH DETACHED GARAGE WITH ELECTRIC POWER, THE BRANCH CIRCUIT SUPPLYING THIS RECEPTACLE(S) SHALL NOT SUPPLY OUTLETS OUTSIDE OF THE GARAGE. AT LEAST ONE RECEPTACLE OUTLET SHALL BE INSTALLED IN EACH VEHICLE BAY.
- CABLE- OR RACEWAY-TYPE WIRING METHODS INSTALLED IN A GROOVE, TO BE COVERED BY WALLBOARD, SIDING, PANELING, CARPETING, OR SIMILAR FINISH, SHALL BE PROTECTED BY 1/8 INCH THICK STEEL PLATE, SLEEVE, OR EQUIVALENT OR BY NOT LESS THAN 1-1/4 INCH FREE SPACE FOR THE FULL LENGTH OF THE GROOVE IN WHICH THE CABLE OR RACEWAY IS INSTALLED.
- RECEPTACLES IN DAMP OR WET LOCATIONS.
 - A RECEPTACLE INSTALLED OUTDOORS IN A LOCATION PROTECTED FROM WEATHER OR IN OTHER DAMP LOCATIONS SHALL HAVE AN ENCLOSURE FOR THE RECEPTACLE THAT IS WEATHERPROOF WHEN THE RECEPTACLE IS COVERED. (ATTACHMENT PLUG GAP NOT INSERTED AND RECEPTACLE COVERS CLOSED.)
 - ALL 15- AND 20- AMPERE, 125- AND 250-VOLT RECEPTACLES INSTALLED IN A WET LOCATION SHALL HAVE AN ENCLOSURE THAT IS WEATHER PROOF WHETHER OR NOT THE ATTACHMENT PLUG GAP IS INSERTED. AN OUTLET BOX HOOD INSTALLED FOR THIS PURPOSE SHALL BE LISTED AND SHALL BE IDENTIFIED AS "EXTRA DUTY". ALL 15- AND 20- AMPERE, 125- AND 250-VOLT NONLOCKING RECEPTACLES SHALL BE LISTED WEATHER RESISTANT TYPE.
- LIGHTING EQUIPMENT, NOT LESS THAN 75 PERCENT OF THE PERMANENTLY INSTALLED LIGHTING FIXTURES SHALL CONTAIN ONLY HIGH-EFFICACY LAMPS.
- LIGHT FIXTURES WITHIN CLOTHES CLOSETS SHALL BE INSTALLED IN ACCORDANCE WITH N.E.C.
- ALL 120-VOLT, SINGLE PHASE, 15- AND 20-AMPERE BRANCH CIRCUITS SUPPLYING OUTLETS OR DEVICES INSTALLED IN DWELLING UNIT FAMILY ROOMS, DINING ROOMS, LIVING ROOMS, PARLORS, LIBRARIES, DEN, BEDROOMS, SUNROOMS, RECREATION ROOMS, CLOSETS, HALLWAYS, OR SIMILAR ROOMS OR AREAS SHALL BE PROTECTED BY AN ARC-FAULT CIRCUIT INTERRUPTER(S), COMBINATION-TYPE, INSTALLED TO PROVIDE PROTECTION OF THE BRANCH CIRCUIT. THE ARC-FAULT CIRCUIT INTERRUPTER SHALL BE INSTALLED IN A READILY ACCESSIBLE LOCATION.
- BUILDINGS SHALL BE PROVIDED WITH APPROVED ADDRESS IDENTIFICATION. THE ADDRESS IDENTIFICATION SHALL BE LEGIBLE AND PLACED IN A POSITION THAT IS VISIBLE FROM THE STREET OR ROAD FRONTING THE PROPERTY.
- TAMPER-RESISTANT RECEPTACLES IN DWELLING UNITS IN ALL AREAS. ALL NON-LOCKING TYPE 125-VOLT 15- AND 20-AMPERE RECEPTACLES SHALL BE LISTED TAMPER-RESISTANT RECEPTACLES. EXCEPTIONS LISTED BELOW:
 - RECEPTACLES LOCATED MORE THAN 5 1/2' ABOVE THE FLOOR.
 - RECEPTACLES THAT ARE PART OF A LUMINAIRE OR APPLIANCE.
 - A SINGLE RECEPTACLE OR A DUPLEX RECEPTACLE FOR TWO APPLIANCES LOCATED WITHIN DEDICATED SPACE FOR EACH APPLIANCE THAT, IN NORMAL USE, IS NOT EASILY MOVED FROM ONE PLACE TO ANOTHER, AND THAT IS CORD-AND-PLUG CONNECTED.
 - NON-GROUNDING RECEPTACLES USED FOR REPLACEMENTS.
- DIMMER-CONTROLLED RECEPTACLES. A RECEPTACLE SUPPLYING LIGHTING LOADS SHALL NOT BE CONNECTED TO A DIMMER UNLESS THE PLUS-RECEPTACLE COMBINATION IS A NONSTANDARD CONFIGURATION TYPE THAT IS SPECIFICALLY LISTED AND IDENTIFIED FOR EACH SUCH UNIQUE COMBINATION.

ELECTRICAL (continued)

CARBON MONOXIDE ALARMS

- CARBON MONOXIDE ALARMS IN DWELLING UNITS SHALL BE INSTALLED OUTSIDE OF EACH SEPARATE SLEEPING AREA IN THE IMMEDIATE VICINITY OF THE BEDROOMS, WHERE A FUEL-BURNING APPLIANCE IS LOCATED WITHIN A BEDROOM OR ITS ATTACHED BATHROOM, A CARBON MONOXIDE ALARM SHALL BE INSTALLED WITHIN THE BEDROOM.
- SINGLE STATION CARBON MONOXIDE ALARMS SHALL BE LISTED AS COMPLYING WITH UL 2054 AND SHALL BE INSTALLED IN ACCORDANCE WITH THE N.C.-R 315 AND THE MANUFACTURER'S INSTALLATION INSTRUCTIONS.
- COMBINATION CARBON MONOXIDE AND SMOKE ALARMS SHALL BE PERMITTED TO BE USED IN LIEU OF INDIVIDUAL CARBON MONOXIDE OR SMOKE ALARMS.

DRYER VENT

- THE DRYER DUCT IS REQUIRED TO IDENTIFY THE LENGTH IN ACCORDANCE WITH SECTION M502.4.5

2018 NC-R-2017-162



NORTH CAROLINA 40' SERIES

KB HOME
NORTH CAROLINA DIVISION

4506 S. MIAMI BLVD.
SUITE 180
DURHAM, NC 27703
TEL: (919) 768-7980
FAX: (919) 544-2928

2018 NORTH CAROLINA STATE BUILDING CODES

ISSUE DATE: 01/08/15
PROJECT No.: 1350999:56
DIVISION MGR.: DCS
REVISIONS: 08/20/20

- 11 DIVISION REVISION NC13654NCP - 08/28/19 - FAB
- 12 DIVISION REVISION NC19657NCP - 09/26/19 - FAB
- 13 DIVISION REVISION NC20053NCP - 12/19/19 - CL
- 14 VENTILATION NC20008NCP - 01/17/20 - CL
- 15 DIVISION REVISION NC20053NCP - 02/10/20 - MCF
- 16 DIVISION REVISION NC20017NCP - 03/04/20 - KBA
- 17 HOME OFFICE CORP20095CORP-08/20/20-CITD

FOR INTERNAL USE ONLY	
REVISION BY:	
1.	_____
2.	_____
3.	_____
4.	_____
5.	_____
6.	_____

PLAN:
238.2338

SHEET:
GN3

SPEC. LEVEL 1
RALEIGH-DURHAM
40' SERIES

These designs and drawings are CONFIDENTIAL, and the exclusive property of KB Home Corporation, and are not to be disclosed without the express permission of KB Home Corporation. Copyright 2020 © KB Home Corporation. All rights reserved.



**NORTH CAROLINA
40' SERIES**

KB HOME
NORTH CAROLINA DIVISION
4506 S. MIAMI BLVD.
SUITE 180
DURHAM, NC 27703
TEL: (919) 768-7980
FAX: (919) 544-2928

**2018 NORTH
CAROLINA STATE
BUILDING
CODES**

- ISSUE DATE: 01/08/15
- PROJECT No.: 1350999:56
- DIVISION MGR.: DCS
- REVISIONS: 08/20/20
- 11 DIVISION REVISION NC19654NCP - 08/28/19 - FAE
- 12 DIVISION REVISION NC19657NCP - 09/26/19 - FAE
- 13 DIVISION REVISION NC20003NCP - 12/19/19 - CL
- 14 VENTILATION NC20004NCP - 01/17/20 - CL
- 15 DIVISION REVISION NC20015NCP - 02/10/20 - MCP
- 16 DIVISION REVISION NC20017NCP - 03/04/20 - KBA
- 17 HOME OFFICE CORP20095CORP-08/20/20-CTD

FOR INTERNAL USE ONLY

REVISION BY:	DATE:
1.	
2.	
3.	
4.	
5.	
6.	

PLAN:
238.2338
SHEET:
1.1

**SPEC. LEVEL 1
RALEIGH-DURHAM
40' SERIES**

- # FLOOR PLAN NOTES**
- NOTE: NOT ALL KEY NOTES APPLY.
- SINK - GARBAGE DISPOSAL OPTIONAL - VERIFY DIMENSIONS WITH MANUFACTURERS' SPECS
 - DISHWASHER - PROVIDE AIR GAP - VERIFY SPACING & DIMENSIONS PER MANUFACTURERS' SPECS
 - SLIDE-IN RANGE/OVEN COMBINATION W/ BUILT-IN NON-VENTED HOOD W/LIGHT & FAN - VERIFY WITH MANUFACTURERS' SPECS
 - 30" COOKTOP W/ BUILT-IN VENTED HOOD W/ LIGHT & FAN VERIFY WITH MANUFURS' SPECS
 - 34" CLEAR REFRIGERATOR SPACE W/ OPTIONAL CABINETS ABOVE - OPT. PLUMBING FOR ICEMAKER (RECESSED IN WALL)
 - COMBINATION DOUBLE OVEN OR OVEN MICROWAVE OVEN OR OVEN VERIFY DIMENSIONS WITH MANUFACTURERS' SPECS
 - BASE CABINETS - REFER TO INTERIOR ELEVATIONS
 - UPPER CABINETS - REFER TO INTERIOR ELEVATIONS
 - ISLAND CABINET - REFER TO INTERIOR ELEVATIONS
 - MIN. 12" BAR TOP/ BREAKFAST BAR
 - DESK AREA - REFER TO INTERIOR ELEVATIONS
 - BUILT-IN PANTRY (15" DEEP OR U.N.O.)
 - SINK CABINET(S) - REFER TO INTERIOR ELEVATIONS
 - SINK CABINET W/ EXTENDED VANITY & KNEE SPACE BELOW - REFER TO INTERIOR ELEVATIONS
 - OPT. SINK - REFER TO INTERIOR ELEVATIONS.
 - KNEE SPACE - REFER TO INTERIOR ELEVATIONS
 - PRE-FAB. TUB/SHOWER COMBO W/ FIBERGLASS MAINSCOT TO T2" - VERIFY DIMENSIONS W/ MANUF'S SPECS
 - OVAL TUB - VERIFY DIMENSIONS WITH MANUF'S SPECS.
 - PRE-FAB. SHOWER PAN W/ 30" MIN. CLR. INSIDE & MAINSCOT TO T2" - VERIFY DIMENSIONS W/ MANUF'S SPECS
 - SHATTERPROOF (TEMPERED) GLASS SHOWER ENCLOSURE.
 - TOWEL BAR - PROVIDE 2x SOLID BLK'G IN WALL
 - TOILET PAPER HOLDER - PROVIDE 2x SOLID BLK'G IN WALL
 - RECESSED, MIRRORED MEDICINE CABINET
 - WASHER & DRYER - PROVIDE WATER & WASTE FOR WASHER - RECESS WASHER CONTROL VALVES IN WALL - VENT DRYER TO OUTSIDE AIR - ACCOMMODATE APPLIANCES TO BE LOCATED WASHER AT LEFT AND DRYER AT RIGHT.
 - 12" SHELF PER SPECS
 - OPT. LAUNDRY SINK - REFER TO INTERIOR ELEVATIONS
 - WATER HEATER LOCATION - FOR GAS - LOCATE ON 18" HIGH PLATFORM - FOR INTERIOR LOCATION - PROVIDE PAN & DRAIN (REFER TO TS/AD-4)
 - RESERVED
 - MAIN LINE SHUT-OFF VALVE AND TEMP. & PRESSURE RELIEF VALVE
 - FAUJ LOCATION (REFER TO DETAIL B6/AD5)
 - RESERVED
 - LISTED FACTORY-BUILT GAS FIRED DEC. APPLIANCE (REF. B0/AD4) - INSTALL PER MFR. SPECS
 - HEARTH TO BE INSTALLED PER FACTORY-BUILT FIREPLACE LISTING
 - GAS APPLIANCE B' VENT FROM BELOW
 - LINEN PER SPECS (15" DEEP OR U.N.O.)
 - COAT CLOSET W/ SHELF & POLE (REFER TO DETAILS/AD4)
 - WARDROBE W/ SHELF & POLE (REFER TO DETAILS/AD4)
 - 22"x30" MIN. ATTIC ACCESS
 - 25"x54" FULL DOWN LADDER R.O. ATTIC ACCESS TO BE PROTECTED
 - LINE OF WALL BELOW
 - DUCT CHASE
 - LINE OF FLOOR ABOVE
 - LINE OF FLOOR BELOW
 - LINE OF OPTIONAL TRAY CEILING (REFER TO DETAIL 42/AD5)
 - LINE OF HIP AT OPTIONAL VOLUME CEILING
 - LINE OF RIDGE AT OPTIONAL VOLUME CEILING
 - CEILING BREAK
 - STAIR TREADS & RISERS - MIN. 10" TREAD & MAX. T 3/4" RISER - (REFER TO DETAIL B1-B2/AD5)
 - MIN. 42" HIGH GUARDRAIL (REFER TO DETAIL B6/AD5)
 - 34" TO 38" HIGH HANDRAIL (REFER TO DETAIL B3/AD5)
 - A/C PAD LOCATION
 - LOW WALL - REFER TO PLAN FOR HEIGHT
 - 2x6 STUD WALL
 - 2x6 BALLOON FRAMED WALL PER STRUCTURAL
 - DEL. 2x4 WALL PER PLAN
 - INTERIOR SHELF-SEE PLAN FOR HT.
 - MEDIA NICHE
 - FLAT SOFFIT - SEE ELEV. FOR HGT.
 - ARCHED SOFFIT - SEE ELEV. FOR HGT.
 - WINDOW SEAT
 - OPT. DOOR/ WINDOW
 - PRE-MANUFACTURED DECORATIVE COLUMN (SIZE, SEE ELEV.) PLYON OR EQ. SURROUNDING STRUCTURAL POST.
 - BRICK / STONE VENEER - REFER TO ELEVATIONS VENEER TO COMPLY WITH THE N.C.-R.
 - SECTIONAL GARAGE DOOR PER SPECS
 - MIN. 1/2" GYP. BD. ON CEILING & WALLS @ USEABLE SPACE UNDER STAIR.
 - GARAGE SHALL BE SEPARATED FROM THE RESIDENCE AND ITS ATTIC AREA BY NOT LESS THAN 1/2" GYP. BD. @ GARAGE SIDE WALLS & 5/8" UNDER LIVING AREA U.N.O.
 - RESERVED
 - 5/8" TYPE-X GYP. IN GARAGE BETWEEN CEILING & FLOOR ABV.
 - P.T. POST W/ WRAP
 - CONCRETE STOOP, 36"x36" STANDARD SLOPE 1/4" PER FT. MIN.
 - EGRESS WINDOW
 - PROVIDE ADDITIONAL RISER(S) AT OPTIONAL PLATE HT.
 - MDF TOP
 - PLUMBING DROP FROM ABOVE
 - ADJUST OPENING AT OPTION TO FIT THE DOOR SIZE SHOWN
 - WINDOW LEDGE, HEIGHT & WIDTH OF OPENING TO EXTEND 6" BEYOND WINDOW(S) ON ALL SIDES U.N.O.
 - SITE-BUILT COLUMN - SEE ELEVATION FOR TYPE
 - CONCRETE SLAB, SLOPE 1/4" PER FT. MIN. SEE PLAN FOR SIZE.
 - RESERVED
 - SLOPING LOW WALL 38" ABOVE ADJACENT TREADS
 - 20 MIN. FIRE-RATED DOOR

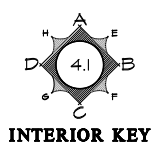
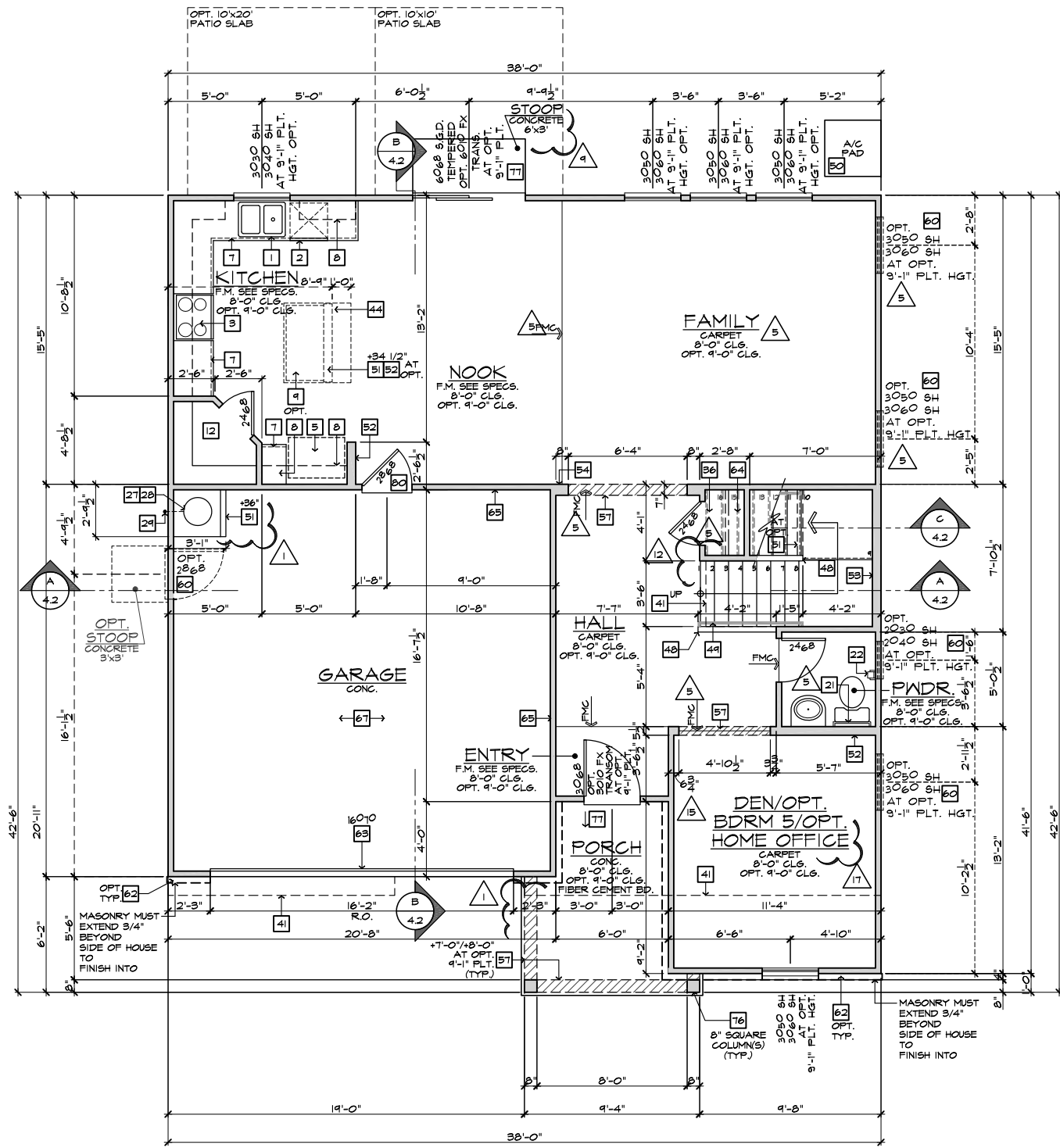

INTERIOR KEY

SQUARE FOOTAGE	
PLAN 238.2338	
FIRST FLOOR AREA	944 SQ. FT.
SECOND FLOOR AREA	1344 SQ. FT.
TOTAL AREA	2338 SQ. FT.
GARAGE AREA	
PORCH AREA(S)	421 SQ. FT.
PATIO AREA(S)	
ELEVATION 'A'	73 SQ. FT.
ELEVATION 'B'	62 SQ. FT.
ELEVATION 'C'	146 SQ. FT.
ELEVATION 'D'	174 SQ. FT.
DECK AREA(S)	
COVERED	100 SQ. FT.
EXTENDED COVERED	200 SQ. FT.
PLATE NOTES	
8'-1" PLATE NOTES	
WINDOW HEADER HEIGHT:	6'-8" U.N.O.
2ND FLOOR WINDOW HDR. HEIGHT:	7'-0" U.N.O.
4010 WINDOW OVER TUB HDR. HGT.:	8'-4" U.N.O.
ENTRY DOOR HEIGHT:	6'-8" (TEMP.)
SLIDING GLASS DOOR HEIGHT:	6'-8" (TEMP.)
INTERIOR SOFFIT HEIGHT:	7'-4" U.N.O.
TRAY CEILING:	7" RISE INTO TRUSS U.N.O.
INTERIOR DOOR HEIGHT:	6'-8" U.N.O.
9'-1" PLATE NOTES	
WINDOW HEADER HEIGHT 1st FL.:	8'-0" U.N.O.
WINDOW HEADER HEIGHT 2nd FL.:	7'-8" U.N.O.
4010 WINDOW OVER TUB HDR. HGT.:	8'-4" U.N.O.
ENTRY DOOR HEIGHT:	6'-8" U.N.O.
SLIDING GLASS DOOR HEIGHT:	6'-8" (TEMP.)
INTERIOR SOFFIT HEIGHT:	8'-0" U.N.O.
TRAY CEILING:	7" RISE INTO TRUSS U.N.O.
INTERIOR DOOR HEIGHT:	6'-8" U.N.O.
STAIR DATA NOTES	
FIRST FLOOR WITH 8" PLATE HEIGHT:	
14" DEEP T.J.I. FLOOR JOISTS WITH 3/4" T&G DECKING.	
14 TREADS AT 10" EACH	
15 RISERS AT 7-1/16" EACH	
FIRST FLOOR WITH 9" PLATE HEIGHT:	
14" DEEP T.J.I. FLOOR JOISTS WITH 3/4" T&G DECKING.	
15 TREADS AT 10" EACH	
16 RISERS AT 7-3/4" EACH	
GENERAL PLAN NOTES	
ALL CEILING HEIGHTS PER SECTION AND ELEVATION PLATE HEIGHTS, U.N.O.	
ALL INTERIOR DOORS TO BE HOLLOW CORE 1 3/8" THICK, U.N.O. (REFER TO PLAN FOR SIZE).	
ALL GARAGE SERVICE DOORS TO BE HOLLOW CORE EXTERIOR GRADE (REFER TO PLAN FOR SIZE).	
ALL HOUSE TO GARAGE DOORS TO BE 20-MINUTE FIRE-RATED (REFER TO PLAN FOR SIZE).	
ALL ENTRY DOORS AND EXTERIOR FRENCH DOORS TO BE SOLID CORE 1 3/4" THICK (REFER TO PLAN FOR SIZE).	
ALL FLOOR MATERIAL CHANGES TO OCCUR AT CENTER OF DOOR JAMBS, U.N.O.	

FIRST FLOOR PLAN 'A'
SCALE 1/4"=1'-0" (22"x34") - 1/8"=1'-0" (11"x17")

These designs and drawings are CONFIDENTIAL, and the exclusive property of KB Home Corporation, and are not to be disclosed without the express permission of KB Home Corporation. Copyright 2020 © KB Home Corporation, all rights reserved.



**NORTH CAROLINA
40' SERIES**

KB HOME
NORTH CAROLINA DIVISION
4518 S. MIAMI BLVD.
SUITE 180
DURHAM, NC 27703
TEL: (919) 768-7988
FAX: (919) 472-0582

**2018 NORTH
CAROLINA STATE
BUILDING
CODES**

- ISSUE DATE: 01/08/15
PROJECT No.: 1350999:56
DIVISION MGR.: DCS
REVISIONS: 08/20/20
- 11 DIVISION REVISION NC13654NCF - 08/28/19 - FAE
 - 12 DIVISION REVISION NC13657NCF - 09/26/19 - FAE
 - 13 DIVISION REVISION NC20003NCF - 12/19/19 - CL
 - 14 VENTILATION NC20004NCF - 01/17/20 - CL
 - 15 DIVISION REVISION NC20003NCF - 02/10/20 - MCP
 - 16 DIVISION REVISION NC20017NCF - 03/04/20 - KBA
 - 17 HOME OFFICE CORP20005CORP-08/20/20-CTD
 - 18 ADD NOTE TO TF NC20007NCF - 10/06/20 - KBA
 - 19 DIVISION REQ REVISION NC21005NCF - 01/06/21 - KBA
 - 20 DIVISION REQ REVISION NC21032NCF - 05/19/21 - KBA

PLAN:
238.2338
SHEET:
1.2

**SPEC. LEVEL 1
RALEIGH-DURHAM
40' SERIES**

- # FLOOR PLAN NOTES**
- NOTE: NOT ALL KEY NOTES APPLY.
1. SINK - GARBAGE DISPOSAL OPTIONAL - VERIFY DIMENSIONS WITH MANUFACTURERS' SPECS
 2. DISHWASHER - PROVIDE AIR GAP - VERIFY SPACING & DIMENSIONS PER MANUFACTURERS' SPECS
 3. SLIDE-IN RANGE/OVEN COMBINATION W/ BUILT-IN VENTED HOOD W/LIGHT & FAN, OR MICRO/HOOD COMBO - SEE SPECS
 4. 30" COOKTOP W/ BUILT-IN VENTED HOOD W/ LIGHT & FAN - VERIFY WITH MANUFACTURERS' SPECS
 5. 34" CLEAR REFRIGERATOR SPACE W/ OPTIONAL CABINETS ABOVE - OPT. PLUMBING FOR ICEMAKER (RECESSED IN WALL)
 6. COMBINATION DOUBLE OVEN OR OVEN/MICROWAVE OVEN OR OVEN - VERIFY DIMENSIONS WITH MANUFACTURERS' SPECS
 7. BASE CABINETS - REFER TO INTERIOR ELEVATIONS
 8. UPPER CABINETS - REFER TO INTERIOR ELEVATIONS
 9. ISLAND CABINET - REFER TO INTERIOR ELEVATIONS
 10. MIN. 12" BAR TOP/ BREAKFAST BAR
 11. DESK AREA - REFER TO INTERIOR ELEVATIONS
 12. BUILT-IN PANTRY (15" DEEP OR U.N.O.)
 13. SINK CABINET(S) - REFER TO INTERIOR ELEVATIONS
 14. SINK CABINET W/ EXTENDED VANITY & KNEE SPACE BELOW - REFER TO INTERIOR ELEVATIONS
 15. OPT. SINK - REFER TO INTERIOR ELEVATIONS.
 16. KNEE SPACE - REFER TO INTERIOR ELEVATIONS
 17. PRE-FAB. TUB/SHOWER COMBO W/ FIBERGLASS MAINSCOT TO T2 - VERIFY DIMENSIONS W/ MANUF'S SPECS
 18. OVAL TUB - VERIFY DIMENSIONS WITH MANUF'S SPECS.
 19. PRE-FAB. SHOWER PAN W/ 30" MIN. CLR. INSIDE & MAINSCOT TO T2 - VERIFY DIMENSIONS W/ MANUF'S SPECS
 20. SHATTERPROOF (TEMPERED) GLASS SHOWER ENCLOSURE.
 21. TOWEL BAR - PROVIDE 2x SOLID BLK'S IN WALL
 22. TOILET PAPER HOLDER - PROVIDE 2x SOLID BLK'S IN WALL
 23. RESERVED
 24. WASHER & DRYER: - PROVIDE WATER & WASTE FOR WASHER - RECESS WASHER CONTROL VALVES IN WALL - VENT DRYER TO OUTSIDE AIR - ACCOMMODATE APPLIANCES TO BE LOCATED WASHER AT LEFT AND DRYER AT RIGHT.
 25. 12" SHELF PER SPECS
 26. OPT. LAUNDRY SINK - REFER TO INTERIOR ELEVATIONS
 27. WATER HEATER LOCATION - FOR GAS - LOCATE ON 18" HIGH PLATFORM - FOR INTERIOR LOCATION - PROVIDE PAN & DRAIN. (REFER TO TS/AD-4)
 28. RESERVED
 29. MAIN LINE SHUT-OFF VALVE AND TEMP. & PRESSURE RELIEF VALVE
 30. FAUJ. LOCATION (REFER TO DETAIL B8/AD5)
 31. RESERVED
 32. LISTED FACTORY-BUILT GAS FIRED DEC. APPLIANCE (REF. B0/AD4) - INSTALL PER MFR. SPECS
 33. HEARTH TO BE INSTALLED PER FACTORY-BUILT FIREPLACE LISTING
 34. GAS APPLIANCE B' VENT FROM BELOW
 35. LINEN PER SPECS (15" DEEP OR U.N.O.)
 36. COAT CLOSET W/ SHELF & POLE (REFER TO DETAILS/AD4)
 37. WARDROBE W/ SHELF & ROPE (REFER TO DETAILS/AD4)
 38. 22"X30" MIN. ATTIC ACCESS 25"X54" FULL DOWN LADDER R.O. ATTIC ACCESS TO BE PROTECTED
 39. LINE OF WALL BELOW
 40. DUCT CHASE
 41. LINE OF FLOOR ABOVE
 42. LINE OF FLOOR BELOW
 43. LINE OF OPTIONAL TRAY CEILING (REFER TO DETAIL 42/AD5)
 44. LINE OF HIP AT OPTIONAL VOLUME CEILING
 45. LINE OF RIDGE AT OPTIONAL VOLUME CEILING
 46. CEILING BREAK
 47. STAIR TREADS & RISERS - MIN. 10" TREAD & MAX. T 3/4" RISER - (REFER TO DETAIL B1-B2/AD5)
 48. MIN. 36" HIGH GUARDWALL (REFER TO DET. B3/AD5 & B5/AD5)
 49. 34" TO 36" HIGH HANDRAIL (REFER TO DETAIL B3/AD5)
 50. A/C PAD LOCATION
 51. LOW WALL - REFER TO PLAN FOR HEIGHT
 52. 2x6 STUD WALL
 53. 2x6 BALLOON FRAMED WALL PER STRUCTURAL
 54. DEL. 2x4 WALL PER PLAN
 55. INTERIOR SHELF-SEE PLAN FOR HT.
 56. MEDIA NICHE
 57. FLAT SOFFIT - SEE ELEV. FOR HGT.
 58. ARCHED SOFFIT - SEE ELEV. FOR HGT.
 59. WINDOW SEAT
 60. OPT. DOOR/ WINDOW
 61. PRE-MANUFACTURED DECORATIVE COLUMN (SIZE, SEE ELEV.) PYLON OR EQ. SURROUNDING STRUCTURAL POST.
 62. BRICK / STONE VENEER - REFER TO ELEVATIONS VENEER TO COMPLY WITH THE N.C.-R.
 63. SECTIONAL GARAGE DOOR PER SPECS
 64. MIN. 1/2" GYP. BD. ON CEILING & WALLS @ USEABLE SPACE UNDER STAIR.
 65. GARAGE SHALL BE SEPARATED FROM THE RESIDENCE AND ITS ATTIC AREA BY NOT LESS THAN 1/2" GYP. BD. @ GARAGE SIDE WALLS & 5/8" UNDER LIVING AREA U.N.O.
 66. OPT. MIN. 36" HIGH GUARDRAIL (REFER TO DETAIL B6/AD5)
 67. 5/8" TYPE-X GYP. IN GARAGE BETWEEN CEILING & FLOOR ABOVE
 68. P.T. POST W/ WRAP
 69. CONCRETE STOOP, SIZE PER PLAN SLOPE 1/4" PER FT. MIN.
 70. EGRESS WINDOW
 71. PROVIDE ADDITIONAL RISER(S) AT OPTIONAL PLATE HT.
 72. MDF TOP
 73. PLUMBING DROP FROM ABOVE
 74. ADJUST OPENING AT OPTION TO FIT THE DOOR SIZE SHOWN
 75. WINDOW LEDGE, HEIGHT & WIDTH OF OPENING TO EXTEND 6" BEYOND WINDOWS) ON ALL SIDES U.N.O.
 76. SITE-BUILT COLUMN - SEE ELEVATION FOR TYPE
 77. CONCRETE SLAB. SLOPE 1/4" PER FT. MIN. SEE PLAN FOR SIZE.
 78. RESERVED
 79. SLOPING LOW WALL 38" ABOVE ADJACENT TREADS
 80. 20 MIN. FIRE-RATED DOOR

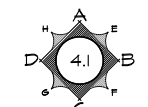
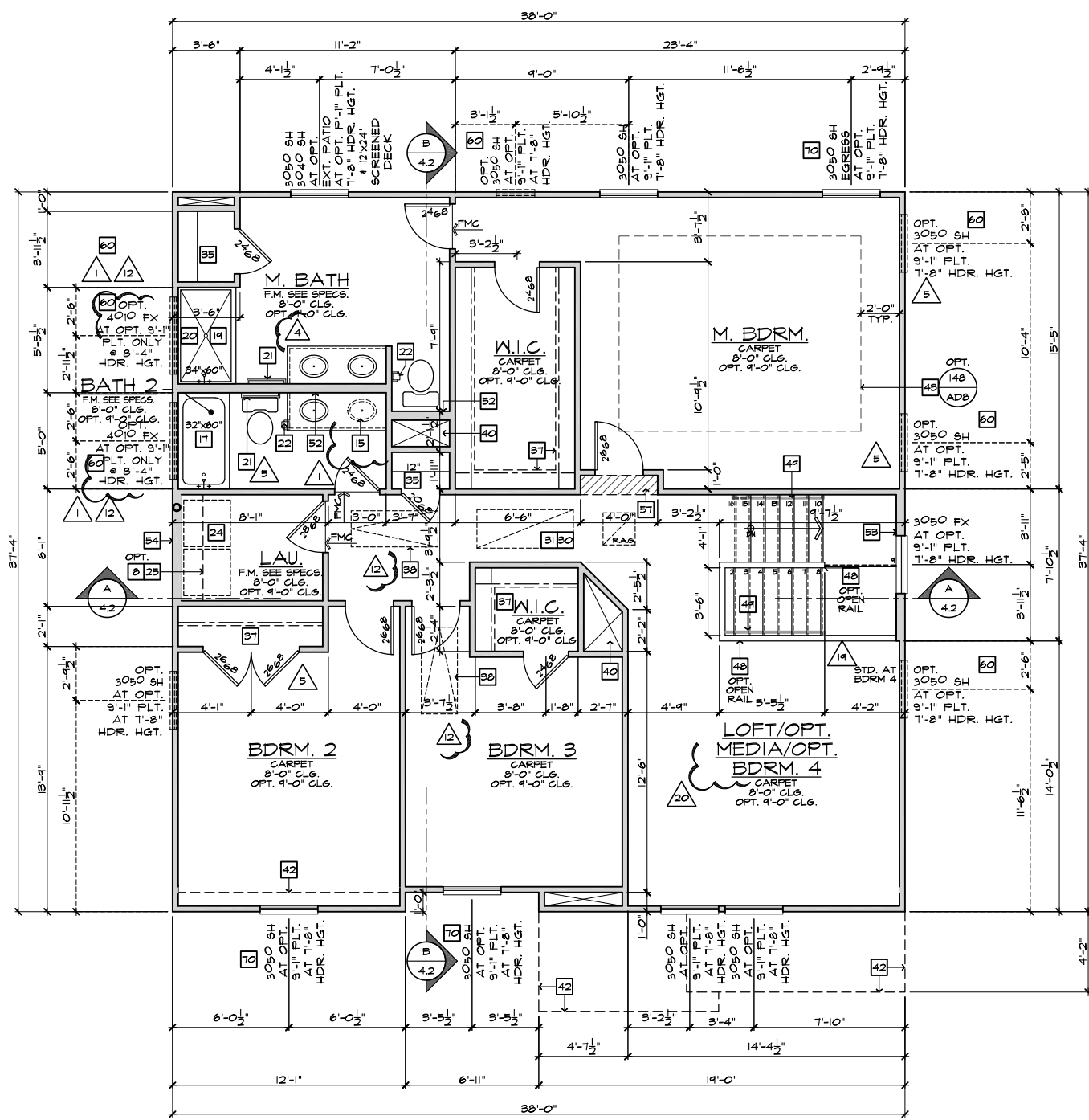

INTERIOR KEY

PLATE NOTES	
8'-1" PLATE NOTES	
• WINDOW HEADER HEIGHT:	6'-8" U.N.O.
• 2nd FLOOR WINDOW HDR. HEIGHT:	7'-0" U.N.O.
• ENTRY DOOR HEIGHT:	6'-8" U.N.O.
• SLIDING GLASS DOOR HEIGHT:	6'-8" (TEMP.)
• INTERIOR SOFFIT HEIGHT:	7'-4" U.N.O.
• TRAY CEILING:	7" RISE INTO TRUSS U.N.O.
• INTERIOR DOOR HEIGHT:	6'-8" U.N.O.
9'-1" PLATE NOTES	
• WINDOW HEADER HEIGHT 1st FL.:	8'-0" U.N.O.
• WINDOW HEADER HEIGHT 2nd FL.:	7'-8" U.N.O.
• 4010 WINDOW OVER TUB HDR. HGT.:	8'-4" U.N.O.
• ENTRY DOOR HEIGHT:	6'-8" U.N.O.
• SLIDING GLASS DOOR HEIGHT:	6'-8" (TEMP.)
• INTERIOR SOFFIT HEIGHT:	8'-0" U.N.O.
• TRAY CEILING:	7" RISE INTO TRUSS U.N.O.
• INTERIOR DOOR HEIGHT:	6'-8" U.N.O.
STAIR DATA NOTES	
FIRST FLOOR WITH 8'-4" PLATE HEIGHT:	
14" DEEP T.J.I. FLOOR JOISTS WITH 3/4" T&G DECKING.	
14 TREADS AT 10" EACH	
15 RISERS AT 7-1/16" EACH	
FIRST FLOOR WITH 9'-4" PLATE HEIGHT:	
14" DEEP T.J.I. FLOOR JOISTS WITH 3/4" T&G DECKING.	
15 TREADS AT 10" EACH	
16 RISERS AT 7-3/4" EACH	
GENERAL PLAN NOTES	
ALL CEILING HEIGHTS PER SECTION AND ELEVATION PLATE HEIGHTS, U.N.O.	
ALL INTERIOR DOORS TO BE HOLLOW CORE 1 3/8" THICK, U.N.O. (REFER TO PLAN FOR SIZE).	
ALL GARAGE SERVICE DOORS TO BE HOLLOW CORE EXTERIOR GRADE (REFER TO PLAN FOR SIZE).	
ALL HOUSE TO GARAGE DOORS TO BE 20-MINUTE FIRE-RATED (REFER TO PLAN FOR SIZE).	
ALL ENTRY DOORS AND EXTERIOR FRENCH DOORS TO BE SOLID CORE 1 3/4" THICK (REFER TO PLAN FOR SIZE).	
ALL FLOOR MATERIAL CHANGES TO OCCUR AT CENTER OF DOOR JAMBS, U.N.O.	

SECOND FLOOR PLAN 'A'

SCALE 1/4"=1'-0" (22"X34") - 1/8"=1'-0" (11"X17")

BASIC PLAN

These designs and drawings are CONFIDENTIAL, and the exclusive property of KB Home Corporation, and are not to be disclosed without the express permission of KB Home Corporation. Copyright 2014 © KB Home Corporation, all rights reserved.



**NORTH CAROLINA
40' SERIES**

KB HOME
NORTH CAROLINA DIVISION
4506 S. MIAMI BLVD.
SUITE 180
DURHAM, NC 27703
TEL: (919) 768-7980
FAX: (919) 544-2928

**2018 NORTH
CAROLINA STATE
BUILDING
CODES**

- ISSUE DATE: 01/08/15
PROJECT No.: 1350999:56
DIVISION MGR.: DCS
REVISIONS: 08/20/20
- 11 DIVISION REVISION NC13654NCF - 08/28/19 - FAE
 - 12 DIVISION REVISION NC13657NCF - 09/26/19 - FAE
 - 13 DIVISION REVISION NC20003NCF - 12/19/19 - CL
 - 14 VENTILATION NC20004NCF - 01/17/20 - CL
 - 15 DIVISION REVISION NC20005NCF - 02/10/20 - MCP
 - 16 DIVISION REVISION NC20007NCF - 03/04/20 - KBA
 - 17 HOME OFFICE CORP20009CORP-08/20/20-CTD

FOR INTERNAL USE ONLY

REVISION BY:	DATE:
1.	
2.	
3.	
4.	
5.	
6.	

PLAN:
238.2338
SHEET:
1.3

**SPEC. LEVEL 1
RALEIGH-DURHAM
40' SERIES**

- # FLOOR PLAN NOTES**
- NOTE: NOT ALL KEY NOTES APPLY.
- SINK - GARBAGE DISPOSAL OPTIONAL - VERIFY DIMENSIONS WITH MANUFACTURERS' SPECS
 - DISHWASHER - PROVIDE AIR GAP - VERIFY SPACING & DIMENSIONS PER MANUFACTURERS' SPECS
 - SLIDE-IN RANGE/OVEN COMBINATION W/ BUILT-IN NON-VENTED HOOD W/LIGHT & FAN - VERIFY WITH MANUFACTURERS' SPECS
 - 30" COOKTOP W/ BUILT-IN VENTED HOOD W/ LIGHT & FAN VERIFY WITH MANUFERS' SPECS
 - 34" CLEAR REFRIGERATOR SPACE W/ OPTIONAL CABINETS ABOVE - OPT. PLUMBING FOR ICEMAKER (RECESSED IN WALL)
 - COMBINATION DOUBLE OVEN OR OVEN MICROWAVE OVEN OR OVEN VERIFY DIMENSIONS WITH MANUFACTURERS' SPECS
 - BASE CABINETS - REFER TO INTERIOR ELEVATIONS
 - UPPER CABINETS - REFER TO INTERIOR ELEVATIONS
 - ISLAND CABINET - REFER TO INTERIOR ELEVATIONS
 - MIN. 12" BAR TOP/ BREAKFAST BAR
 - DESK AREA - REFER TO INTERIOR ELEVATIONS
 - BUILT-IN PANTRY (15" DEEP OR U.N.O.)
 - SINK CABINET(S) - REFER TO INTERIOR ELEVATIONS
 - SINK CABINET W/ EXTENDED VANITY & KNEE SPACE BELOW - REFER TO INTERIOR ELEVATIONS
 - OPT. SINK - REFER TO INTERIOR ELEVATIONS.
 - KNEE SPACE - REFER TO INTERIOR ELEVATIONS
 - PRE-FAB. TUB/SHOWER COMBO W/ FIBERGLASS MAINSCOT TO T2" - VERIFY DIMENSIONS W/ MANUF'S SPECS
 - OVAL TUB - VERIFY DIMENSIONS WITH MANUF'S SPECS.
 - PRE-FAB. SHOWER PAN W/ 30" MIN. CLR. INSIDE & MAINSCOT TO T2" - VERIFY DIMENSIONS W/ MANUF'S SPECS
 - SHATTERPROOF (TEMPERED) GLASS SHOWER ENCLOSURE.
 - TOWEL BAR - PROVIDE 2x SOLID BLK'G IN WALL
 - TOILET PAPER HOLDER - PROVIDE 2x SOLID BLK'G IN WALL
 - RECESSED, MIRROR MIRROR MIRROR MIRROR
 - WASHER & DRYER - PROVIDE WATER & WASTE FOR WASHER - RECESS WASHER CONTROL VALVES IN WALL - VENT DRYER TO OUTSIDE AIR - ACCOMMODATE APPLIANCES TO BE LOCATED WASHER AT LEFT AND DRYER AT RIGHT.
 - 12" SHELF PER SPECS
 - OPT. LAUNDRY SINK - REFER TO INTERIOR ELEVATIONS
 - WATER HEATER LOCATION - FOR GAS - LOCATE ON 18" HIGH PLATFORM - FOR INTERIOR LOCATION - PROVIDE PAN & DRAIN (REFER TO TS/AD-4)
 - RESERVED
 - MAIN LINE SHUT-OFF VALVE AND TEMP. & PRESSURE RELIEF VALVE
 - RESERVED
 - FAUJ LOCATION (REFER TO DETAIL B6/AD5)
 - RESERVED
 - LISTED FACTORY-BUILT GAS FIRED DEC. APPLIANCE (REF. B0/AD4) - INSTALL PER MFR. SPECS
 - HEARTH TO BE INSTALLED PER FACTORY-BUILT FIREPLACE LISTING
 - GAS APPLIANCE B' VENT FROM BELOW
 - WATER PER SPECS (15" DEEP OR U.N.O.)
 - COAT CLOSET W/ SHELF & POLE (REFER TO DETAILS/AD4)
 - WARDROBE W/ SHELF & POLE (REFER TO DETAILS/AD4)
 - 22"x30" MIN. ATTIC ACCESS
 - 25"x54" FULL DOWN LADDER R.O. ATTIC ACCESS TO BE PROTECTED
 - LINE OF WALL BELOW
 - DUCT CHASE
 - LINE OF FLOOR ABOVE
 - LINE OF FLOOR BELOW
 - LINE OF OPTIONAL TRAY CEILING (REFER TO DETAIL 92/AD5)
 - LINE OF HIP AT OPTIONAL VOLUME CEILING
 - LINE OF RIDGE AT OPTIONAL VOLUME CEILING
 - CEILING BREAK
 - STAIR TREADS & RISERS - MIN. 10" TREAD & MAX. 7 3/4" RISER - (REFER TO DETAIL B1-B2/AD5)
 - MIN. 42" HIGH GUARDRAIL (REFER TO DETAIL B6/AD5)
 - 34" TO 38" HIGH HANDRAIL (REFER TO DETAIL B3/AD5)
 - A/C PAD LOCATION
 - LOW WALL - REFER TO PLAN FOR HEIGHT
 - 2x6 STUD WALL
 - 2x6 BALLOON FRAMED WALL PER STRUCTURAL
 - DEL. 2x4 WALL PER PLAN
 - INTERIOR SHELF-SEE PLAN FOR HT.
 - MEDIA NICHE
 - FLAT SOFFIT - SEE ELEV. FOR HGT.
 - ARCHED SOFFIT - SEE ELEV. FOR HGT.
 - WINDOW SEAT
 - OPT. DOOR/ WINDOW
 - PRE-MANUFACTURED DECORATIVE COLUMN (SIZE, SEE ELEV.) PYLON OR EQ. SURROUNDING STRUCTURAL POST.
 - BRICK / STONE VENEER - REFER TO ELEVATIONS VENEER TO COMPLY WITH THE N.C.-R.
 - SECTIONAL GARAGE DOOR PER SPECS
 - MIN. 1/2" GYP. BD. ON CEILING & WALLS @ USEABLE SPACE UNDER STAIR.
 - GARAGE SHALL BE SEPARATED FROM THE RESIDENCE AND ITS ATTIC AREA BY NOT LESS THAN 1/2" GYP. BD. @ GARAGE SIDE WALLS & 5/8" UNDER LIVING AREA U.N.O.
 - RESERVED
 - 3/8" TYPE-X GYP. IN GARAGE BETWEEN CEILING & FLOOR ABV.
 - P.T. POST W/ WRAP
 - CONCRETE STOOP, 36"x36" STANDARD
 - CONCRETE SLAB. SLOPE 1/4" PER FT. MIN. SEE PLAN FOR SIZE.
 - EGRESS WINDOW
 - PROVIDE ADDITIONAL RISER(S) AT OPTIONAL PLATE HT.
 - MDF TOP
 - PLUMBING DROP FROM ABOVE
 - ADJUST OPENING AT OPTION TO FIT THE DOOR SIZE SHOWN
 - WINDOW LEDGE. HEIGHT & WIDTH OF OPENING TO EXTEND 6" BEYOND WINDOWS) ON ALL SIDES U.N.O.
 - SITE-BUILT COLUMN - SEE ELEVATION FOR TYPE
 - CONCRETE SLAB. SLOPE 1/4" PER FT. MIN. SEE PLAN FOR SIZE.
 - RESERVED
 - SLOPING LOW WALL 38" ABOVE ADJACENT TREADS
 - 20 MIN. FIRE-RATED DOOR

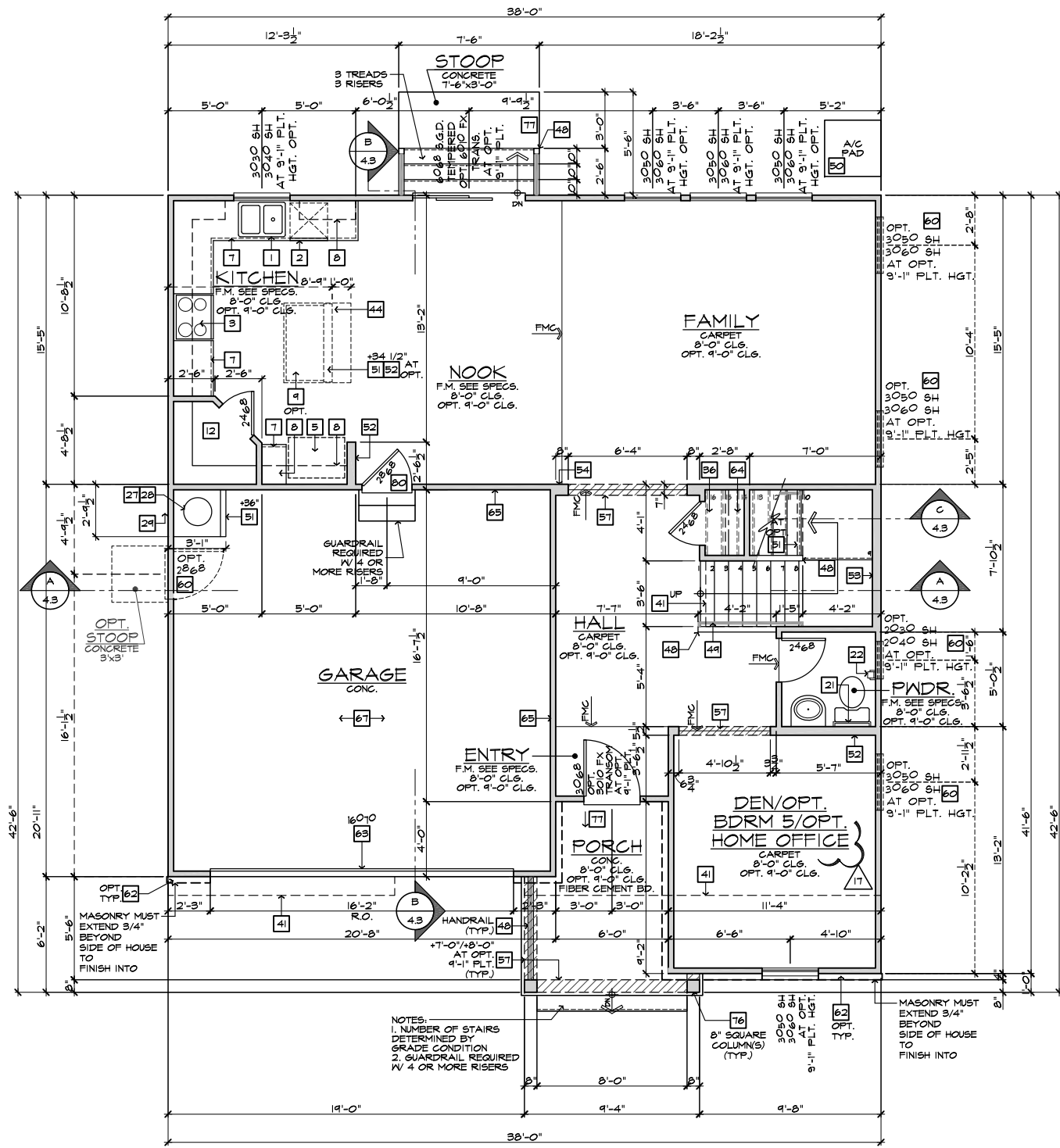

FIRST FLOOR PLAN 'A' W/ CRAWL SPACE
SCALE 1/4"=1'-0" (22"X34") - 1/8"=1'-0" (11"X17")

INTERIOR KEY

PLAN 238.2338

FIRST FLOOR AREA	444	SQ. FT.
SECOND FLOOR AREA	1344	SQ. FT.
TOTAL AREA	2338	SQ. FT.
GARAGE AREA		
PORCH AREA(S)	421	SQ. FT.
PATIO AREA(S)		
ELEVATION 'A'	73	SQ. FT.
ELEVATION 'B'	62	SQ. FT.
ELEVATION 'C'	146	SQ. FT.
ELEVATION 'D'	174	SQ. FT.
DECK AREA(S)		
COVERED	100	SQ. FT.
EXTENDED COVERED	200	SQ. FT.
DECK	144	SQ. FT.
EXTENDED DECK	252	SQ. FT.

PLATE NOTES

8'-1" PLATE NOTES

- WINDOW HEADER HEIGHT: 6'-8" U.N.O.
- 2nd FLOOR WINDOW HDR. HEIGHT: 7'-0" U.N.O.
- ENTRY DOOR HEIGHT: 6'-8" U.N.O.
- SLIDING GLASS DOOR HEIGHT: 6'-8" (TEMP.)
- INTERIOR SOFFIT HEIGHT: 7'-4" U.N.O.
- TRAY CEILING: 8'-0" U.N.O.
- INTERIOR DOOR HEIGHT: 6'-8" RISE INTO TRUSS U.N.O.

9'-1" PLATE NOTES

- WINDOW HEADER HEIGHT 1st FL.: 8'-0" U.N.O.
- WINDOW HEADER HEIGHT 2nd FL.: 7'-8" U.N.O.
- 4010 WINDOW OVER TUB HDR. HGT.: 8'-4" U.N.O.
- ENTRY DOOR HEIGHT: 6'-8" U.N.O.
- SLIDING GLASS DOOR HEIGHT: 6'-8" (TEMP.)
- INTERIOR SOFFIT HEIGHT: 8'-0" U.N.O.
- TRAY CEILING: 7'-1" RISE INTO TRUSS U.N.O.
- INTERIOR DOOR HEIGHT: 6'-8" U.N.O.

STAIR DATA NOTES

FIRST FLOOR WITH 8" PLATE HEIGHT:

- 14" DEEP T.J.I. FLOOR JOISTS WITH 3/4" T&G DECKING.
- 14 TREADS AT 10" EACH
- 15 RISERS AT 7-7/16" EACH

FIRST FLOOR WITH 9" PLATE HEIGHT:

- 14" DEEP T.J.I. FLOOR JOISTS WITH 3/4" T&G DECKING.
- 15 TREADS AT 10" EACH
- 16 RISERS AT 7-3/4" EACH

GENERAL PLAN NOTES

- ALL CEILING HEIGHTS PER SECTION AND ELEVATION PLATE HEIGHTS, U.N.O.
- ALL INTERIOR DOORS TO BE HOLLOW CORE 1 3/8" THICK, U.N.O. (REFER TO PLAN FOR SIZE).
- ALL GARAGE SERVICE DOORS TO BE HOLLOW CORE EXTERIOR GRADE (REFER TO PLAN FOR SIZE).
- ALL HOUSE TO GARAGE DOORS TO BE 20-MINUTE FIRE-RATED (REFER TO PLAN FOR SIZE).
- ALL ENTRY DOORS AND EXTERIOR FRENCH DOORS TO BE SOLID CORE 1 3/4" THICK (REFER TO PLAN FOR SIZE).
- ALL FLOOR MATERIAL CHANGES TO OCCUR AT CENTER OF DOOR JAMBES, U.N.O.

These designs and drawings are CONFIDENTIAL, and the exclusive property of KB Home Corporation, and are not to be disclosed without the express permission of KB Home Corporation. Copyright 2020 © KB Home Corporation, all rights reserved.

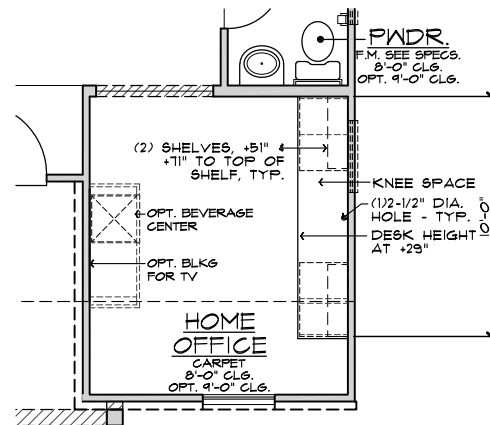

OPT. HOME OFFICE
AT DEN

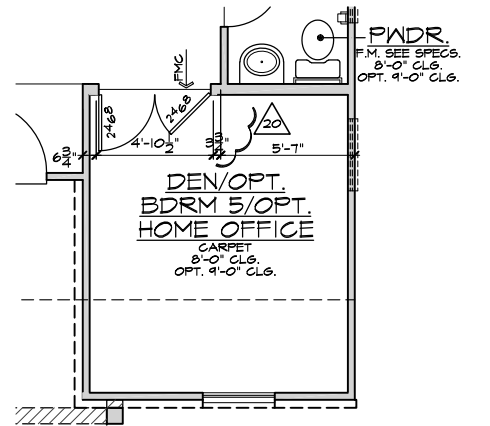

OPT. DOUBLE DOORS
AT DEN

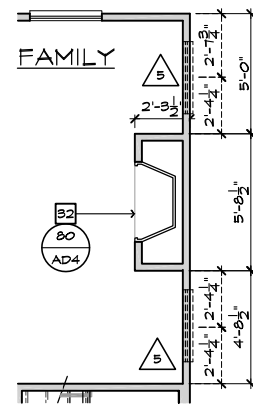

FIREPLACE
AT FAMILY

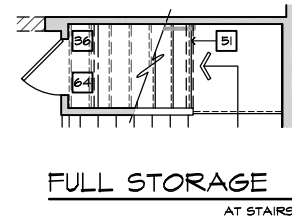

FULL STORAGE
AT STAIRS

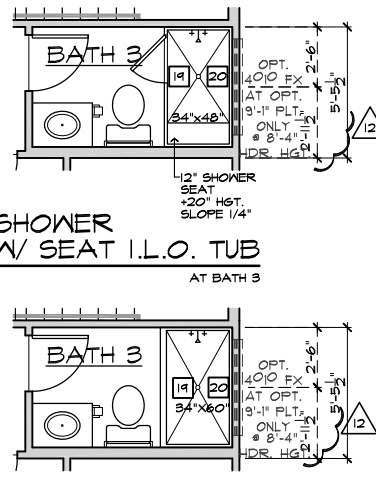

SHOWER I.L.O. TUB
AT BATH 3

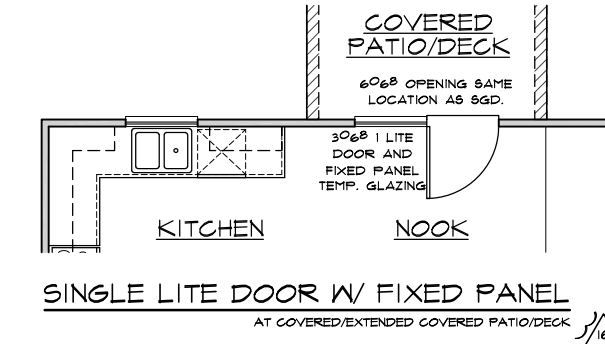

SINGLE LITE DOOR W/ FIXED PANEL
AT COVERED/EXTENDED COVERED PATIO/DECK

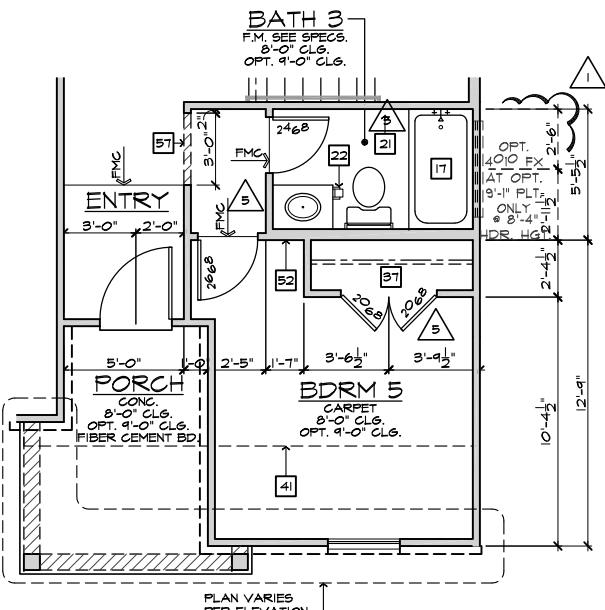

BEDROOM 5 W/ BATH 3
AT DEN/POUNDER

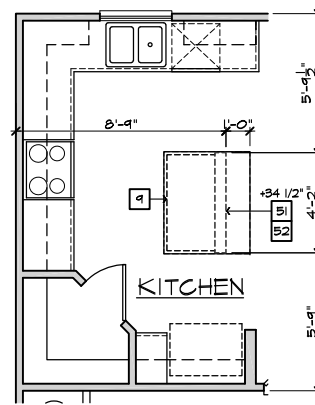

KITCHEN ISLAND
AT KITCHEN

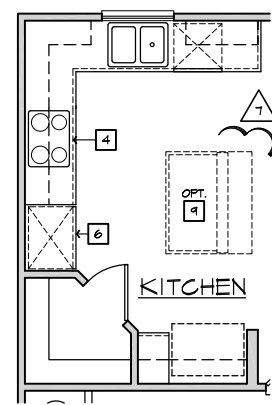

GOURMET KITCHEN
AT KITCHEN

- ### # FLOOR PLAN NOTES
- NOTE: NOT ALL KEY NOTES APPLY.
- SINK - GARBAGE DISPOSAL OPTIONAL - VERIFY DIMENSIONS WITH MANUFACTURERS' SPECS
 - DISHWASHER - PROVIDE AIR GAP - VERIFY SPACING & DIMENSIONS PER MANUFACTURERS' SPECS
 - SLIDE-IN RANGE/OVEN COMBINATION W/ BUILT-IN VENTED HOOD W/LIGHT & FAN, OR MICRO/HOOD COMBO - SEE SPECS
 - 30" COOKTOP W/ BUILT-IN VENTED HOOD W/ LIGHT & FAN VERIFY WITH MANUFERS' SPECS
 - 34" CLEAR REFRIGERATOR SPACE W/ OPTIONAL CABINETS ABOVE - OPT. PLUMBING FOR ICEMAKER (RECESSED IN WALL)
 - COMBINATION DOUBLE OVEN OR OVEN/MICROWAVE OVEN OR OVEN VERIFY DIMENSIONS WITH MANUFACTURERS' SPECS
 - BASE CABINETS - REFER TO INTERIOR ELEVATIONS
 - UPPER CABINETS - REFER TO INTERIOR ELEVATIONS
 - ISLAND CABINET - REFER TO INTERIOR ELEVATIONS
 - MIN. 12" BAR TOP/ BREAKFAST BAR
 - DESK AREA - REFER TO INTERIOR ELEVATIONS
 - BUILT-IN PANTRY (15" DEEP OR U.N.O.)
 - SINK CABINET(S) - REFER TO INTERIOR ELEVATIONS
 - SINK CABINET W/ EXTENDED VANITY & KNEE SPACE BELOW - REFER TO INTERIOR ELEVATIONS
 - OPT. SINK - REFER TO INTERIOR ELEVATIONS.
 - KNEE SPACE - REFER TO INTERIOR ELEVATIONS
 - PRE-FAB. TUB/SHOWER COMBO W/ FIBERGLASS MAINSCOT TO 72" - VERIFY DIMENSIONS W/ MANUF'S SPECS
 - OVAL TUB - VERIFY DIMENSIONS WITH MANUF'S SPECS.
 - PRE-FAB. SHOWER PAN W/ 30" MIN. CLR. INSIDE & MAINSCOT TO 72" - VERIFY DIMENSIONS W/ MANUF'S SPECS
 - SHATTERPROOF (TEMPERED) GLASS SHOWER ENCLOSURE.
 - TOWEL BAR - PROVIDE 2x SOLID BLK'S IN WALL
 - TOILET PAPER HOLDER - PROVIDE 2x SOLID BLK'S IN WALL
 - RESERVED
 - WASHER & DRYER: - PROVIDE WATER & WASTE FOR WASHER - RECESS WASHER CONTROL VALVES IN WALL - VENT DRYER TO OUTSIDE AIR - ACCOMMODATE APPLIANCES TO BE LOCATED WASHER AT LEFT AND DRYER AT RIGHT.
 - 12" SHELF PER SPECS
 - OPT. LAUNDRY SINK - REFER TO INTERIOR ELEV'S
 - WATER HEATER LOCATION: - FOR GAS - LOCATE ON 18" HIGH PLATFORM - FOR INTERIOR LOCATION - PROVIDE PAN & DRAIN. (REFER TO TS/AD4)
 - R.A.S. LOCATION (SEE HVAC PLAN)
 - MAIN LINE SHUT-OFF VALVE AND TEMP. & PRESSURE RELIEF VALVE
 - FAUJ LOCATION (REFER TO DETAIL 88/AD5)
 - RESERVED
 - LISTED FACTORY-BUILT GAS FIRED DEC. APPLIANCE (REF. 80/AD4) - INSTALL PER MFR. SPECS
 - HEARTH TO BE INSTALLED PER FACTORY-BUILT FIREPLACE LISTING
 - GAS APPLIANCE B' VENT FROM BELOW
 - LINEN PER SPECS (15" DEEP OR U.N.O.)
 - COAT CLOSET W/ SHELF & POLE (REFER TO DETAILS/AD4)
 - WARDROBE W/ SHELF & ROPE (REFER TO DETAILS/AD4)
 - 22"x30" MIN. ATTIC ACCESS
 - 25"x54" FULL DOWN LADDER R.O. ATTIC ACCESS TO BE PROTECTED
 - LINE OF WALL BELOW
 - DUCT CHASE/VOID SPACE - 1/2" GYP. BD. AT CLG. FIRE BLK.G.
 - LINE OF FLOOR ABOVE
 - LINE OF FLOOR BELOW
 - LINE OF OPTIONAL TRAY CEILING (REFER TO DETAIL 92/AD5)
 - LINE OF HIP AT OPTIONAL VOLUME CEILING
 - LINE OF RIDGE AT OPTIONAL VOLUME CEILING
 - CEILING BREAK
 - STAIR TREADS & RISERS: - MIN. 10" TREAD & MAX. 7 3/4" RISER - (REFER TO DETAIL 81-82/AD5)
 - MIN. 36" HIGH GUARDWALL (REFER TO DET. 83/AD5 & 85/AD5)
 - 34" TO 36" HIGH HANDRAIL (REFER TO DETAIL 83/AD5)
 - A/C PAD LOCATION
 - SOA/A/C LINESET LOCATION
 - LOW WALL - REFER TO PLAN FOR HEIGHT
 - 2x6 STUD WALL
 - 2x6 BALLOON FRAMED WALL PER STRUCTURAL
 - DEL. 2x4 WALL PER PLAN
 - INTERIOR SHELF-SEE PLAN FOR HT.
 - MEDIA NICHE
 - FLAT SOFFIT - SEE ELEV. FOR HST.
 - ARCHED SOFFIT - SEE ELEV. FOR HST.
 - WINDOW SEAT
 - OPT. DOOR/ WINDOW
 - PRE-MANUFACTURED DECORATIVE COLUMN (SIZE, SEE ELEV.) PYRON OR EQ. SURROUNDING STRUCTURAL POST.
 - BRICK / STONE VENEER - REFER TO ELEVATIONS VENEER TO COMPLY WITH THE N.C.-R.
 - SECTIONAL GARAGE DOOR PER SPECS
 - MIN. 1/2" GYP. BD. ON CEILING & WALLS @ USEABLE SPACE UNDER STAIR.
 - GARAGE SHALL BE SEPARATED FROM THE RESIDENCE AND ITS ATTIC AREA BY NOT LESS THAN 1/2" GYP. BD. @ GARAGE SIDE WALLS & 5/8" UNDER LIVING AREA U.N.O.
 - OPT. MIN. 36" HIGH GUARDRAIL (REFER TO DETAIL 86/AD5)
 - 5/8" TYPE-X GYP. IN GARAGE BETWEEN CEILING & FLOOR ABV.
 - P.T. POST W/ WRAP
 - CONCRETE STOOP, SIZE PER PLAN
 - SLOPE 1/4" PER FT. MIN.
 - EGRESS WINDOW
 - PROVIDE ADDITIONAL RISER(S) AT OPTIONAL PLATE HT.
 - MDF TOP
 - PLUMBING DROP FROM ABOVE
 - ADJUST OPENING AT OPTION TO FIT THE DOOR SIZE SHOWN
 - WINDOW LEDGE, HEIGHT & WIDTH OF OPENING TO EXTEND 6" BEYOND WINDOW(S) ON ALL SIDES U.N.O.
 - SITE-BUILT COLUMN - SEE ELEVATION FOR TYPE
 - CONCRETE SLAB, SLOPE 1/4" PER FT. MIN. SEE PLAN FOR SIZE.
 - 1/2" PRELIM. GYP. BD. BEHIND TUB/SHOWER (TO MEET STC)
 - SLOPING LOW WALL 38" ABOVE ADJACENT TREADS
 - 20 MIN. FIRE-RATED DOOR

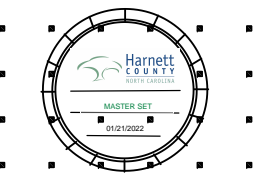

NORTH CAROLINA 40' SERIES

KB HOME
NORTH CAROLINA DIVISION
4518 S. MIAMI BLVD.
SUITE 180
DURHAM, NC 27703
TEL: (919) 768-7988
FAX: (919) 472-0582

2018 NORTH CAROLINA STATE BUILDING CODES

- ISSUE DATE: 01/08/15
PROJECT No.: 1350999:56
DIVISION MGR.: DCS
REVISIONS: SEE REV. LOG
- 11 DIVISION REVISION NC13654NCF - 08/28/19 - FAE
 - 12 DIVISION REVISION NC19657NCF - 09/26/19 - FAE
 - 13 DIVISION REVISION NC20003NCF - 12/19/19 - CL
 - 14 VENTILATION NC20008NCF - 01/17/20 - CL
 - 15 DIVISION REVISION NC20013NCF - 02/10/20 - MCP
 - 16 DIVISION REVISION NC20017NCF - 03/04/20 - KBA
 - 17 HOME OFFICE CORP20009CORP-08/20/20-CTD
 - 18 ADD NOTE TO TS NC20007NCF - 10/06/20 - KBA
 - 19 DIVISION REQ. REVISION NC21005NCF - 01/06/21 - KBA
 - 20 DIVISION REQ. REVISION NC21032NCF - 05/19/21 - KBA

PLAN:
238.2338
SHEET:
1.4

SPEC. LEVEL 1 RALEIGH-DURHAM 40' SERIES

FIRST FLOOR PLAN OPTIONS

SCALE 1/4"=1'-0" (22"X34") - 1/8"=1'-0" (11"X17")

BASIC PLAN

These designs and drawings are CONFIDENTIAL, and the exclusive property of KB Home Corporation, and are not to be disclosed without the express permission of KB Home Corporation. Copyright 2021 © KB Home Corporation, all rights reserved.

- # SLAB PLAN NOTES**
- NOTE: NOT ALL KEY NOTES APPLY.
1. CONCRETE PATIO/PORCH SLAB PER STRUCTURAL- SLOPE 1/4" PER FT. MIN.
 2. CONCRETE GARAGE SLAB PER STRUCTURAL- SLOPE 1/8" PER 1'-0" MIN. TOWARD DOOR OPENING.
 3. CONCRETE FOUNDATION PER STRUCTURAL.
 4. CONCRETE STOOP: 36"x36" STANDARD SLOPE 1/4" PER FT. MIN.
 5. CONCRETE DRIVEWAY SLOPE 1/4" PER FT. MIN. AWAY FROM GARAGE DOOR OPENING.
 6. PROVIDE ELECTRICAL CONDUIT UNDER SLAB AT ISLAND. VERIFY LOCATION.
 7. 5" BRICK LEDGE FOR MASONRY VENEER.
 8. 3" DIAMETER CONCRETE FILLED PIPE BOLLARD 36" HIGH WITH MIN. 12" EMBEDMENT INTO CONCRETE.
 9. REFER TO CIVIL DRAWINGS FOR ALL FINISH SURFACE ELEVATIONS.
 10. VERIFY ALL PLUMBING STUB DIMENSIONS SHOWN HERE PRIOR TO POUR OF SLAB.
 11. 4" MIN. @ 1/4" MAX. TO HARD SURFACE.
 12. A/C PAD. VERIFY LOCATION.
 13. 36" WIDE WALKWAY- SLOPE 1/4" PER FT. MIN.



**NORTH CAROLINA
40' SERIES**

KB HOME
NORTH CAROLINA DIVISION
4506 S. MIAMI BLVD.
SUITE 180
DURHAM, NC 27703
TEL: (919) 768-7980
FAX: (919) 544-2928

**2018 NORTH
CAROLINA STATE
BUILDING
CODES**

- ISSUE DATE: 01/08/15
PROJECT No.: 1350999:56
DIVISION MGR.: DCS
REVISIONS: 08/20/20
- 11 DIVISION REVISION NC19654NCP - 08/28/19 - FAE
 - 12 DIVISION REVISION NC19657NCP - 09/26/19 - FAE
 - 13 DIVISION REVISION NC20043NCP - 12/19/19 - CL
 - 14 VENTILATION NC20008NCP - 01/17/20 - CL
 - 15 DIVISION REVISION NC20013NCP - 02/10/20 - MCP
 - 16 DIVISION REVISION NC20017NCP - 03/04/20 - KBA
 - 17 HOME OFFICE CORP20009CORP-08/20/20-CTD

FOR INTERNAL USE ONLY

REVIEWED BY:

1.	
2.	
3.	
4.	
5.	
6.	

PLAN:
238.2338
SHEET:
2.1

**SPEC. LEVEL 1
RALEIGH-DURHAM
40' SERIES**

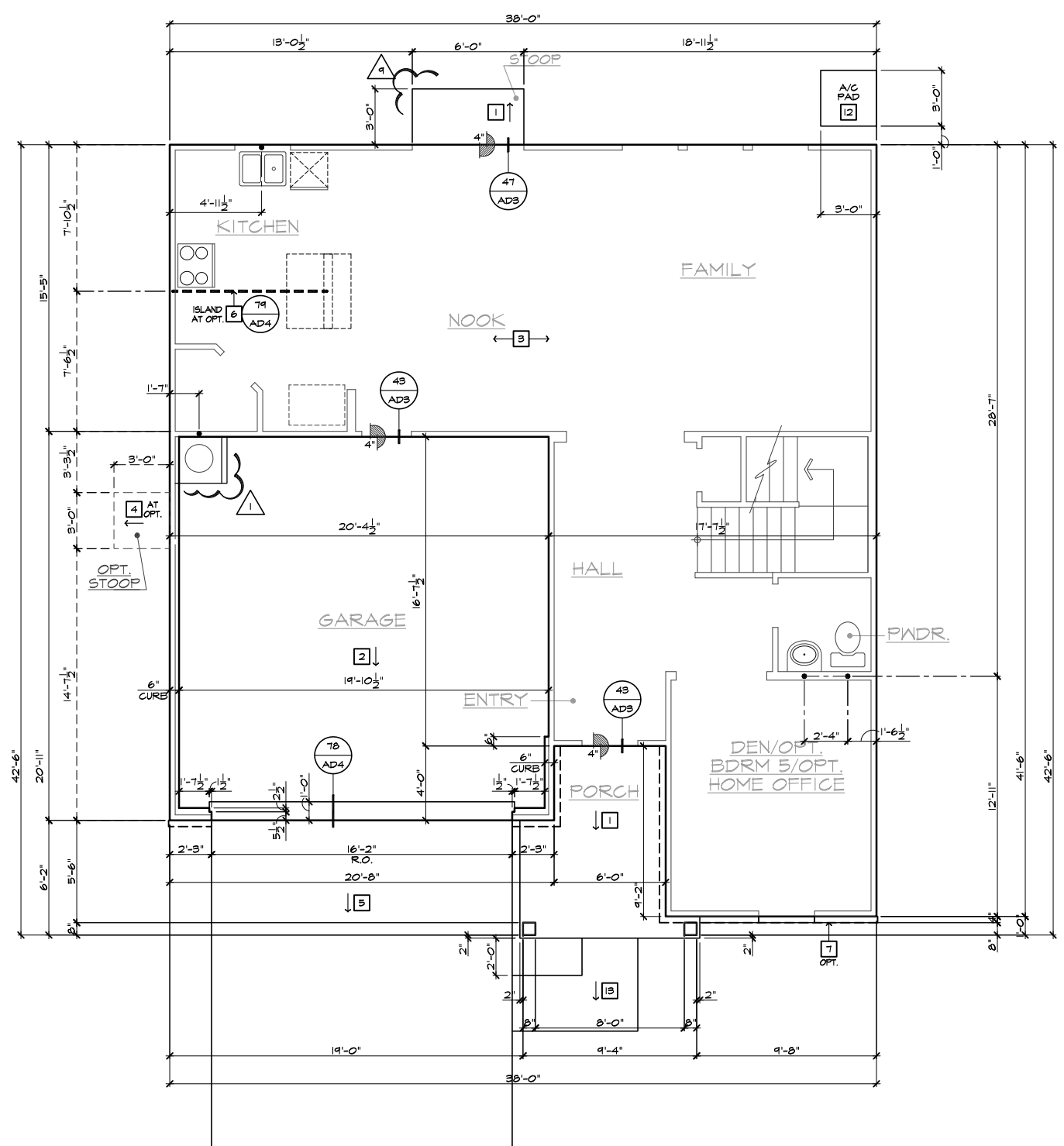

SLAB INTERFACE PLAN 'A'
SCALE 1/4"=1'-0" (22"x34") - 1/8"=1'-0" (11"x17") BASIC PLAN AT SLAB-ON-GRADE

These designs and drawings are CONFIDENTIAL, and the exclusive property of KB Home Corporation, and may not be used or duplicated without the express permission of KB Home Corporation. Copyright 2020 © KB Home Corporation, all rights reserved.

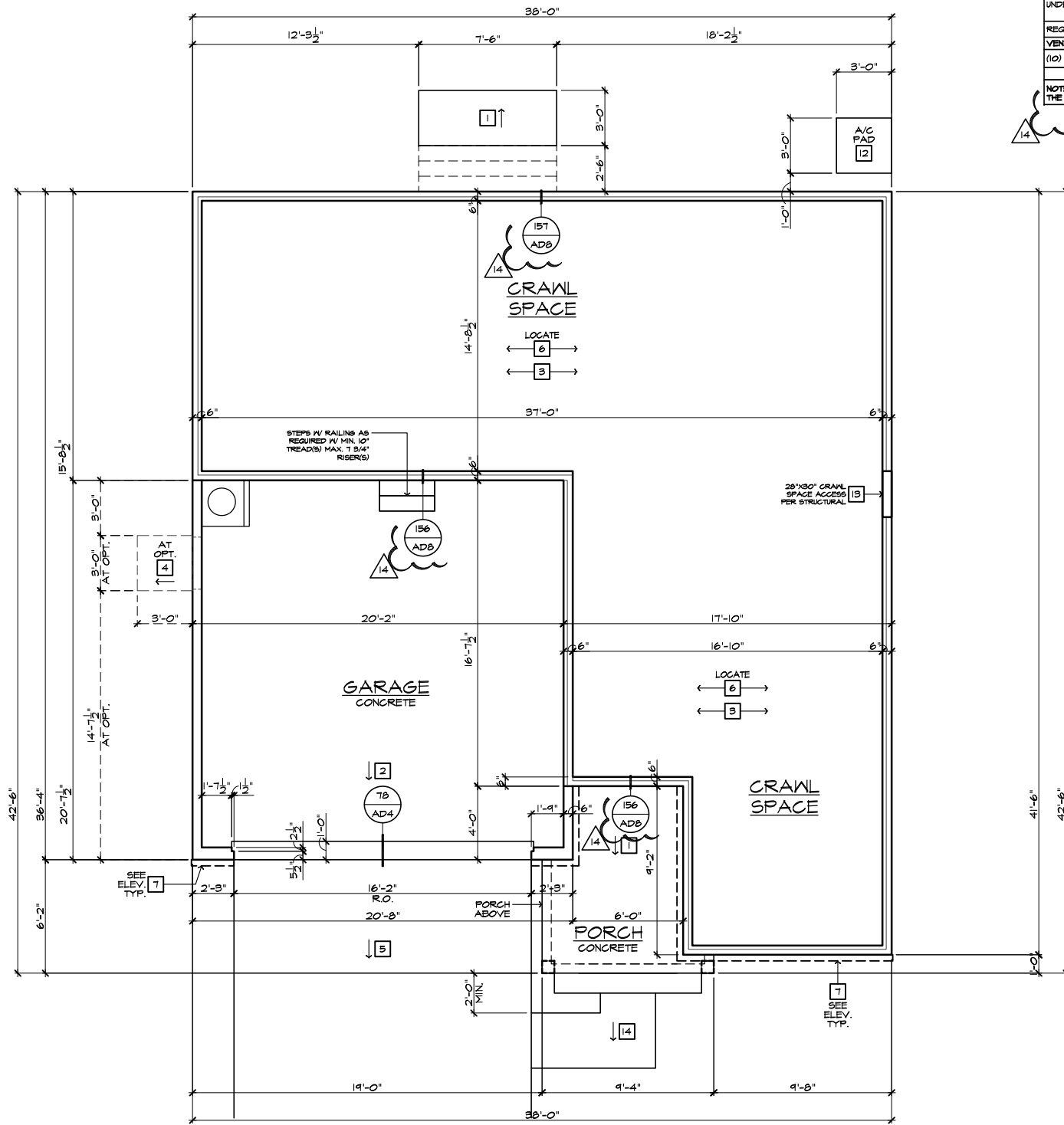

CRAWL SPACE PLAN 'A'
 SCALE 1/4"=1'-0" (22"X34") - 1/8"=1'-0" (11"X17")

#		FOUNDATION PLAN NOTES
NOTE: NOT ALL KEY NOTES APPLY.		
1.	CONCRETE PATIO/PORCH SLAB PER STRUCTURAL- SLOPE 1/4" PER FT. MIN.	
2.	CONCRETE GARAGE SLAB PER STRUCTURAL- SLOPE 1/8" PER 1'-0" MIN. TOWARD DOOR OPENING.	
3.	FOUNDATION PER STRUCTURAL.	
4.	STAIR LANDING: 36"X36" MIN.	
5.	CONCRETE DRIVEWAY SLOPE 1/4" PER FT. MIN. AWAY FROM GARAGE DOOR OPENING.	
6.	PROVIDE UNDER FLOOR VENTILATION	
7.	4" TOE KICK FOR MASONRY VENEER.	
8.	3" DIAMETER CONCRETE FILLED PIPE BOLLARD 36" HIGH WITH MIN. 12" EMBEDMENT INTO CONCRETE.	
9.	REFER TO CIVIL DRAWINGS FOR ALL FINISH SURFACE ELEVATIONS.	
10.	VERIFY LOCATION OF PIER FOOTINGS PER STRUCTURAL.	
11.	4" MIN. 7 3/4" MAX. TO HARD SURFACE.	
12.	A/C PAD. VERIFY LOCATION.	
13.	CRAWL SPACE ACCESS	
14.	36" WIDE WALKWAY- SLOPE 1/4" PER FT. MIN.	
UNDER FLOOR VENTING AREA		
UNDER FLOOR AREA SHALL COMPLY WITH NCRC 2018		
UNDER FLOOR AREA CALCULATION =	934 SQ. FT. / 150	6.63 SQ. FT.
REQUIRED AREA	X 144 =	954 SQ. IN.
VENTILATION PROVIDED:		
(10) FOUNDATION VENTS	105 SQ. IN. =	1050 SQ. IN.
NOTE: CRAWLSPACE VENT TO BE LOCATED WITHIN 3'-0" OF THE CORNER OF THE STEM WALL.		



**NORTH CAROLINA
40' SERIES**

KB HOME
 NORTH CAROLINA DIVISION
 4506 S. MIAMI BLVD.
 SUITE 180
 DURHAM, NC 27703
 TEL: (919) 768-7980
 FAX: (919) 544-2928

**2018 NORTH
CAROLINA STATE
BUILDING
CODES**

- ISSUE DATE: 01/08/15
- PROJECT No.: 1350999:56
- DIVISION MGR.: DCS
- REVISIONS: 08/20/20
- 11 DIVISION REVISION NC19654NCP - 08/28/19 - FAE
- 12 DIVISION REVISION NC19657NCP - 09/26/19 - FAE
- 13 DIVISION REVISION NC20003NCP - 12/19/19 - CL
- 14 VENTILATION NC20008NCP - 01/17/20 - CL
- 15 DIVISION REVISION NC20013NCP - 02/10/20 - MCP
- 16 DIVISION REVISION NC20017NCP - 03/04/20 - KBA
- 17 HOME OFFICE CORP20009CORP-08/20/20-CTD

FOR INTERNAL USE ONLY	
REVIEWED BY:	
1.	
2.	
3.	
4.	
5.	
6.	

PLAN:
238.2338
 SHEET:
2.3

SPEC. LEVEL 1
**RALEIGH-DURHAM
40' SERIES**

These designs and drawings are CONFIDENTIAL, and the exclusive property of KB Home Corporation, and are not to be disclosed without the express permission of KB Home Corporation. Copyright 2020 © KB Home Corporation, all rights reserved.

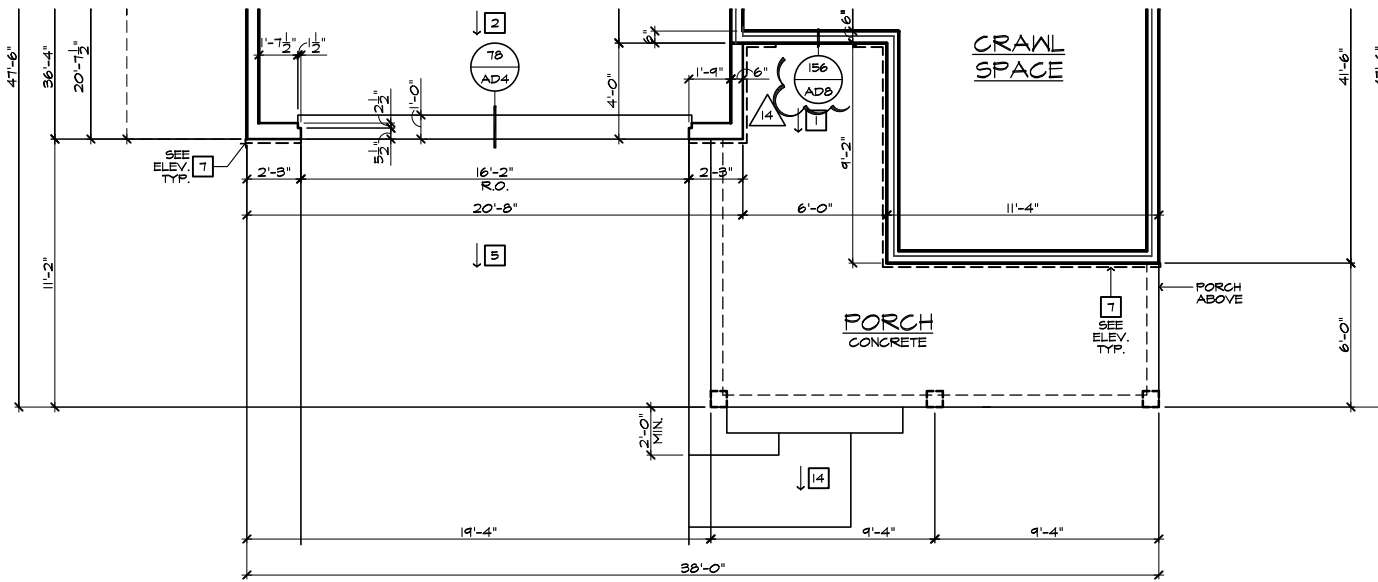

PARTIAL CRAWL SPACE PLAN 'D'

SCALE 1/4"=1'-0" (22"X34") - 1/8"=1'-0" (11"X17")

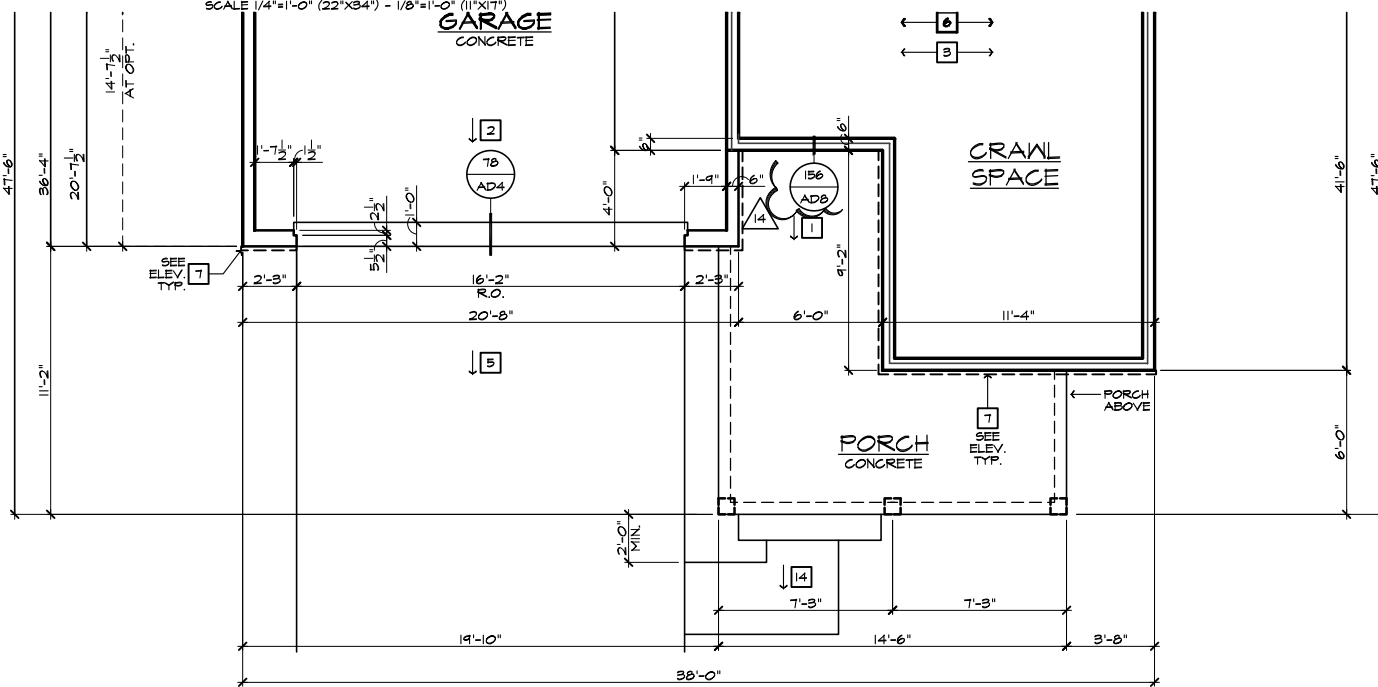

PARTIAL CRAWL SPACE PLAN 'C'

SCALE 1/4"=1'-0" (22"X34") - 1/8"=1'-0" (11"X17")

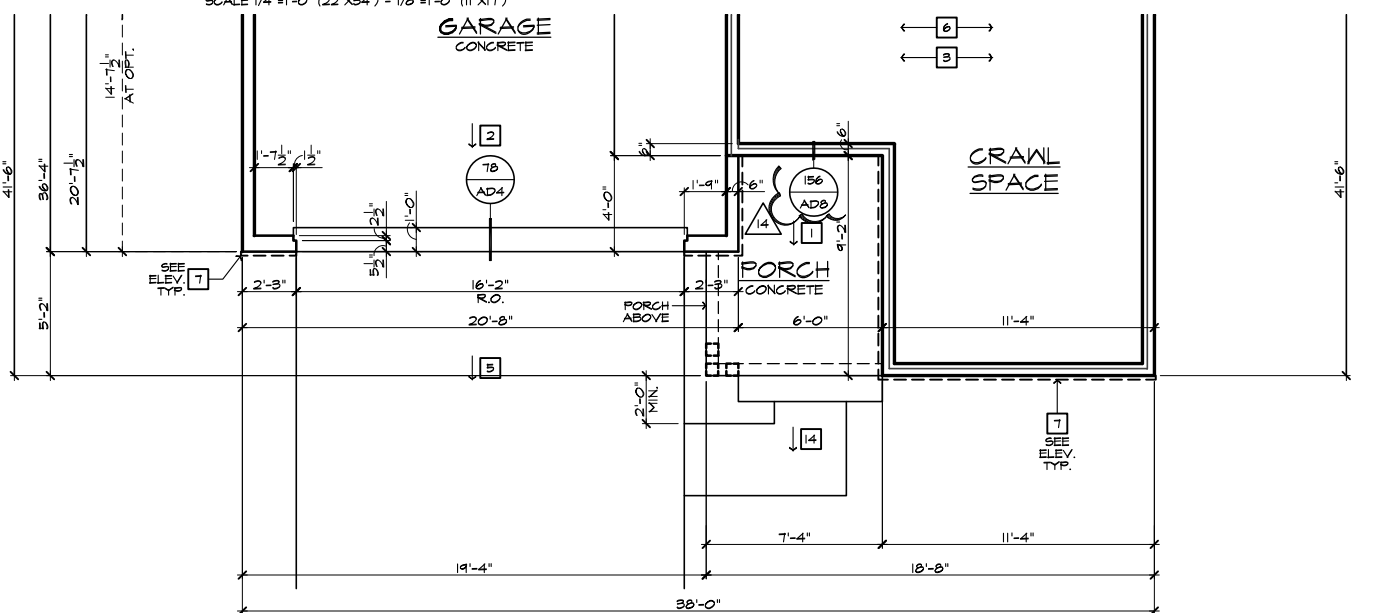

PARTIAL CRAWL SPACE PLAN 'B'

SCALE 1/4"=1'-0" (22"X34") - 1/8"=1'-0" (11"X17")

- # FOUNDATION PLAN NOTES**
- NOTE: NOT ALL KEY NOTES APPLY.
1. CONCRETE PATIO/PORCH SLAB PER STRUCTURAL- SLOPE 1/4" PER FT. MIN.
 2. CONCRETE GARAGE SLAB PER STRUCTURAL- SLOPE 1/8" PER 1'-0" MIN. TOWARD DOOR OPENING.
 3. FOUNDATION PER STRUCTURAL.
 4. STAIR LANDING: 36"x36" MIN.
 5. CONCRETE DRIVEWAY SLOPE 1/4" PER FT. MIN. AWAY FROM GARAGE DOOR OPENING.
 6. PROVIDE UNDER FLOOR VENTILATION
 7. 4" TOE KICK FOR MASONRY VENEER.
 8. 3" DIAMETER CONCRETE FILLED PIPE BOLLARD 36" HIGH WITH MIN. 12" EMBEDMENT INTO CONCRETE.
 9. REFER TO CIVIL DRAWINGS FOR ALL FINISH SURFACE ELEVATIONS.
 10. VERIFY LOCATION OF PIER FOOTINGS PER STRUCTURAL.
 11. 4" MIN. 7 3/4" MAX. TO HARD SURFACE.
 12. A/C PAD. VERIFY LOCATION.
 13. CRAWL SPACE ACCESS
 14. 36" WIDE WALKWAY- SLOPE 1/4" PER FT. MIN.



NORTH CAROLINA 40' SERIES

KB HOME
 NORTH CAROLINA DIVISION
 4506 S. MIAMI BLVD.
 SUITE 180
 DURHAM, NC 27703
 TEL: (919) 768-7980
 FAX: (919) 544-2928

2018 NORTH CAROLINA STATE BUILDING CODES

ISSUE DATE: 01/08/15
 PROJECT No.: 1350999:56
 DIVISION MGR.: DCS
 REVISIONS: 08/20/20

- 11 DIVISION REVISION NC19654NCP - 08/28/19 - FAE
- 12 DIVISION REVISION NC19657NCP - 09/26/19 - FAE
- 13 DIVISION REVISION NC20003NCP - 12/19/19 - CL
- 14 VENTILATION NC20008NCP - 01/17/20 - CL
- 15 DIVISION REVISION NC20013NCP - 02/10/20 - MCP
- 16 DIVISION REVISION NC20017NCP - 03/04/20 - KBA
- 17 HOME OFFICE CORP20009CORP-08/20/20-CTD

FOR INTERNAL USE ONLY

REVISION NO.	DATE	BY	DESCRIPTION
1.			
2.			
3.			
4.			
5.			
6.			

PLAN: 238.2338
 SHEET: 2.4

SPEC. LEVEL 1
 RALEIGH-DURHAM 40' SERIES

These designs and drawings are CONFIDENTIAL, and the exclusive property of KB Home Corporation, and are not to be disclosed without the express permission of KB Home Corporation. Copyright 2020 © KB Home Corporation, all rights reserved.

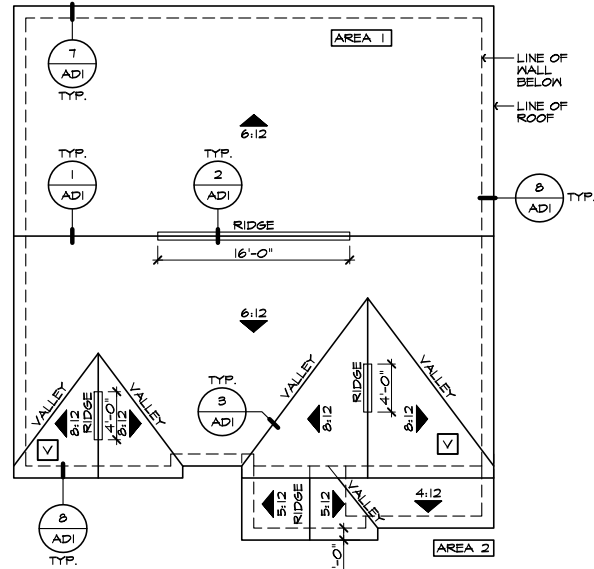

ROOF PLAN 'A'

SCALE 1/8"=1'-0" (22'x34") - 1/16"=1'-0" (11'x17")

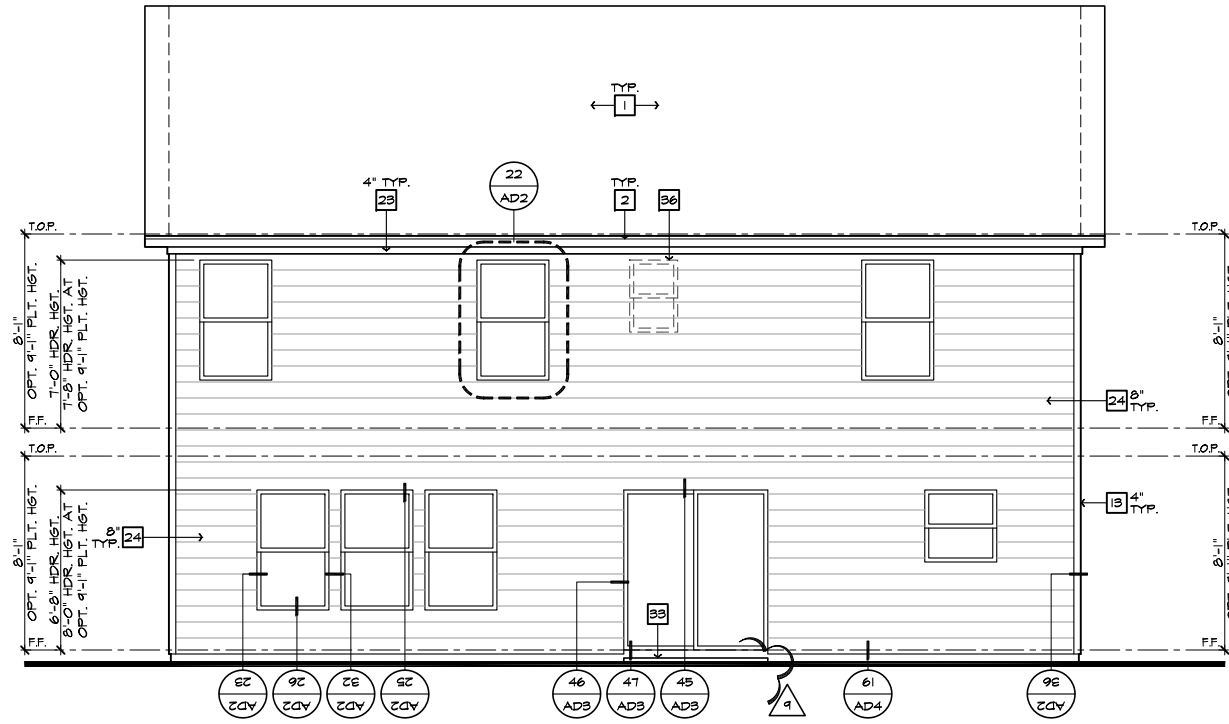

REAR ELEVATION 'A'

SCALE 1/4"=1'-0" (22'x34") - 1/8"=1'-0" (11'x17")



FRONT ELEVATION 'A'

SCALE 1/4"=1'-0" (22'x34") - 1/8"=1'-0" (11'x17")



PARTIAL FRONT ELEVATION 'A' W/ BRICK OPTION

SCALE 1/4"=1'-0" (22'x34") - 1/8"=1'-0" (11'x17")

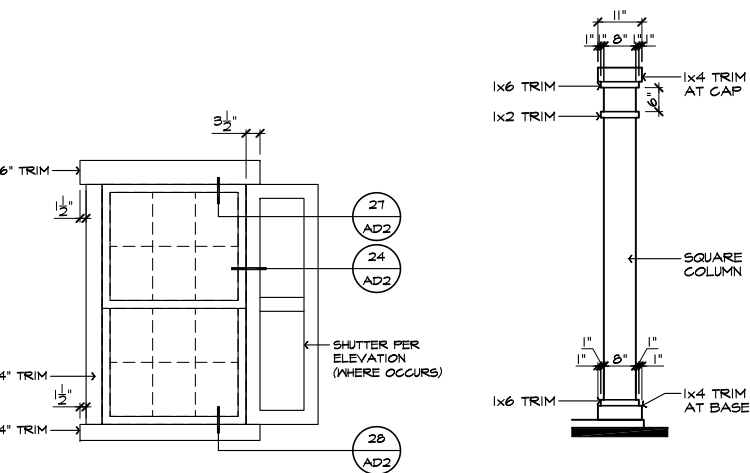

DETAIL 'B'

SCALE: N.T.S.

DETAIL 'A'

SCALE: N.T.S.

- ELEVATION NOTES**
- NOTE: NOT ALL KEY NOTES APPLY.
1. ROOF MATERIAL - REFER TO ROOF NOTES
 2. 2X FASCIA/BARGE BOARD WITH FASCIA CAP
 3. 6:1 FLASHING
 4. 6:1 FLASHING & SADDLE/CRICKET
 5. 6:1 DRIP SCREED
 6. 24"x24" CHIMNEY
 7. DECORATIVE VENT
 8. DECORATIVE CORBEL
 9. DECORATIVE SHUTTERS
 10. PEDIMENT. SEE ELEVATION FOR TYPE
 11. RECESSED ELEMENT
 12. DECORATIVE TRIM FYPON OR EQ. SEE ELEVATION FOR TYPE
 13. TRIM PER SPEC - SEE ELEVATION FOR SIZE
 14. SYNTHETIC MATERIAL
 15. PRE-MANUFACTURED DECORATIVE COLUMN (SIZE, SEE ELEV.) FYPON OR EQ. SURROUNDING STRUCTURAL POST.
 16. SITE-BUILT COLUMN - SEE ELEVATION FOR TYPE
 17. SHAKE SIDING
 18. STONE VENEER PER SPECS
 19. BRICK/MASONRY VENEER PER SPECS
 20. BUILT UP BRICK COLUMN
 21. SOLDIER COURSE
 22. ROWLOCK COURSE
 23. FRIEZE BOARD
 24. SIDING W/ 4" CORNER TRIM PER SPECS
 25. P.T. POST W/ WRAP - SEE STRUCTURAL FOR SIZE
 26. PRE-FAB DECORATIVE TRIM
 27. LIGHT WEIGHT PRECAST STONE TRIM
 28. P.T. LUMBER RAILINGS (36" U.N.O.)
 29. WRAP
 30. DECORATIVE WINDOW/DOOR TRIM - FYPON OR EQ. SEE ELEVATION FOR SIZE.
 31. BRACKET OR KICKER - FYPON OR EQ.
 32. ENTRY DOOR
 33. CONCRETE STOOP/ PORCH - SEE SLAB INTERFACE PLAN.
 34. SECTIONAL GARAGE DOOR PER SPECS
 35. ALUMINUM WRAP
 36. OPTIONAL DOOR/WINDOW - REFER TO PLAN OPTIONS
 37. OPTIONAL STANDING SEAM METAL ROOF
 38. KEYSTONE
 39. SOLDIER CROWN
 40. JACK SOLDIER COURSE
 41. WATER TABLE
 42. ATRIUM DOOR
 43. PILASTER - SEE ELEVATION FOR TYPE

ROOF PLAN NOTES 'A'

6:12 INDICATES ROOF SLOPE AND DIRECTION, U.N.O.

ROOF MATERIAL: COMPOSITION SHINGLE
 12" (INCHES) TYPICAL ROOF OVERHANGS AT RAKE, U.N.O.
 12" (INCHES) TYPICAL ROOF OVERHANGS AT EAVE, U.N.O.
 LOCATE EAVE/ RAFTER VENTS EQUALLY BALANCED AROUND HOUSE EXCEPT ABOVE SHEARMALL PANELS.

ATTIC VENT CALCULATIONS

PROVIDE 1 SQ. IN. OF VENTILATION PER 300 SQ. IN. OF ATTIC SPACE. PROVIDE THAT AT LEAST 50% & NO MORE THAN 80% OF THE REQ. VENTILATING AREA IS PROVIDED BY VENTILATORS LOCATED IN THE UPPER PORTION OF THE ATTIC (HIGH VENTING) AT 3'-0" ABOVE EAVE VENT WITH THE BALANCE BEING PROVIDED BY EAVE VENTS (LOW VENTING) (2018 N.C.-R 806.2)
 * CALCULATION BY 1/150, HIGH/LOW VENTING NOT REQUIRED. APPROXIMATE RIDGE VENT LOCATIONS SHOWN. ACTUAL LOCATIONS TO BE DETERMINED IN THE FIELD.

AREA 1 / MAIN:

VENTILATION REQUIRED:	SQ. FT. / 300	4.71 SQ. FT.
ATTIC AREA = 1412	X 144 =	678 SQ. IN.
	TOTAL HIGH & LOW =	678 SQ. IN.
	X 50% =	339 SQ. IN.

VENTILATION PROVIDED:

HIGH	LF RIDGE VENT(S) AT	10 SQ. IN. / LF. =	482 SQ. IN.
	ROOF VENT(S) AT	50 SQ. IN. EA. =	0 SQ. IN.
SUB-TOTAL HIGH VENTILATION:			482 SQ. IN.
LOW	LF VENTILATED SOFFIT AT	6.9 SQ. IN. / LF. =	304 SQ. IN.
	ROOF VENT(S) AT	50 SQ. IN. EA. =	100 SQ. IN.
SUB-TOTAL LOW VENTILATION:			404 SQ. IN.
TOTAL VENTILATION PROVIDED:			886 SQ. IN.

AREA 2 / PORCH:

VENTILATION REQUIRED:	SQ. FT. / 150	0.94 SQ. FT.
ATTIC AREA = 88	X 144 =	84 SQ. IN.
	TOTAL HIGH & LOW =	84 SQ. IN.

VENTILATION PROVIDED:

(B)	LF VENTILATED SOFFIT AT	6.9 SQ. IN. / LF. =	40 SQ. IN.
(O)	LF RIDGE VENT(S) AT	10 SQ. IN. EA. =	0 SQ. IN.
TOTAL VENTILATION PROVIDED:			40 SQ. IN.

NOTES:

ALL VENT OPENINGS SHALL BE COVERED WITH 1/4" CORROSION RESISTANT METAL MESH.
 FRAMER SHALL BE RESPONSIBLE FOR COORDINATING WITH TRUSS MANUFACTURER TO ACCOMMODATE ALL ATTIC VENTS.
 ALL VENTS SHALL BE INSTALLED SO AS TO MAKE THEM WATER-PROOF & WALL MOUNTED LOUVERS SHALL BE SEALED & FLASHED W/ TAPE/STAPLE IN THE SAME MANNER PRESCRIBED FOR WINDOW INSTALLATION.
 PROVIDE APPROVED INSULATION DAMS (BAFFLES) WHERE VENT BLOCKS ARE USED BETWEEN ROOF FRAMING MEMBERS TO PREVENT VENT HOLES FROM BEING BLOCKED BY INSULATION. LOCATE HIGH VENTING MINIMUM 3'-0" VERTICAL DISTANCE ABOVE EAVES.
 WHEN GABLE END TRUSS MEMBERS BLOCK GABLE END VENTS, PROVIDE ADEQUATE ADDITIONAL VENTILATION BY MEANS OF ROOF TILE VENTS.

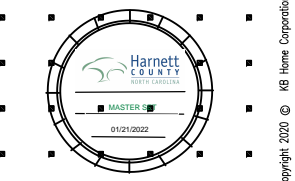

NORTH CAROLINA 40' SERIES

KB HOME
 NORTH CAROLINA DIVISION
 4506 S. MIAMI BLVD.
 SUITE 180
 DURHAM, NC 27703
 TEL: (919) 768-7980
 FAX: (919) 544-2928

2018 NORTH CAROLINA STATE BUILDING CODES

ISSUE DATE: 01/08/15
 PROJECT No.: 1350999:56
 DIVISION MGR.: DCS
 REVISIONS: 08/20/20

11 DIVISION REVISION NC19654NCP - 08/28/19 - FAB
 12 DIVISION REVISION NC19657NCP - 09/26/19 - FAB
 13 DIVISION REVISION NC20003NCP - 12/19/19 - CL
 14 VENTILATION NC20008NCP - 01/17/20 - CL
 15 DIVISION REVISION NC20013NCP - 02/10/20 - MCP
 16 DIVISION REVISION NC20017NCP - 03/04/20 - KBA
 17 HOME OFFICE CORP20009CORP-08/20/20-CTD

FOR INTERNAL USE ONLY
 REVIEWED BY:
 1. _____
 2. _____
 3. _____
 4. _____
 5. _____
 6. _____

PLAN: 238.2338
 SHEET: 3.A1

SPEC. LEVEL 1 RALEIGH-DURHAM 40' SERIES

These designs and drawings are CONFIDENTIAL, and the exclusive property of KB Home Corporation and are not to be disclosed without the express permission of KB Home Corporation. Copyright 2020 © KB Home Corporation, all rights reserved.

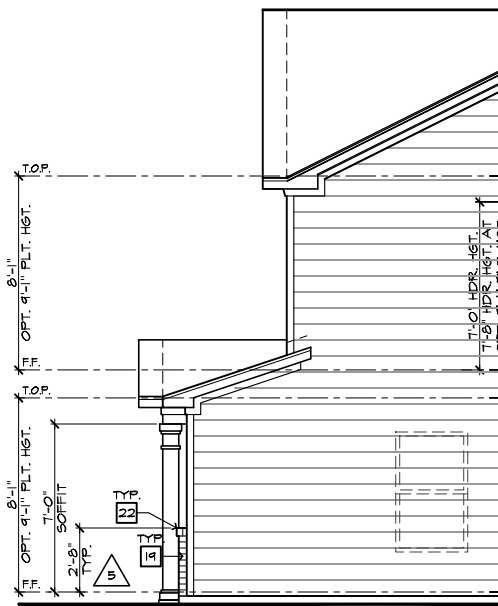

**PARTIAL RIGHT ELEVATION 'A'
W/ MASONRY OPTION**

SCALE 1/4"=1'-0" (22'x34") - 1/8"=1'-0" (11'x17")

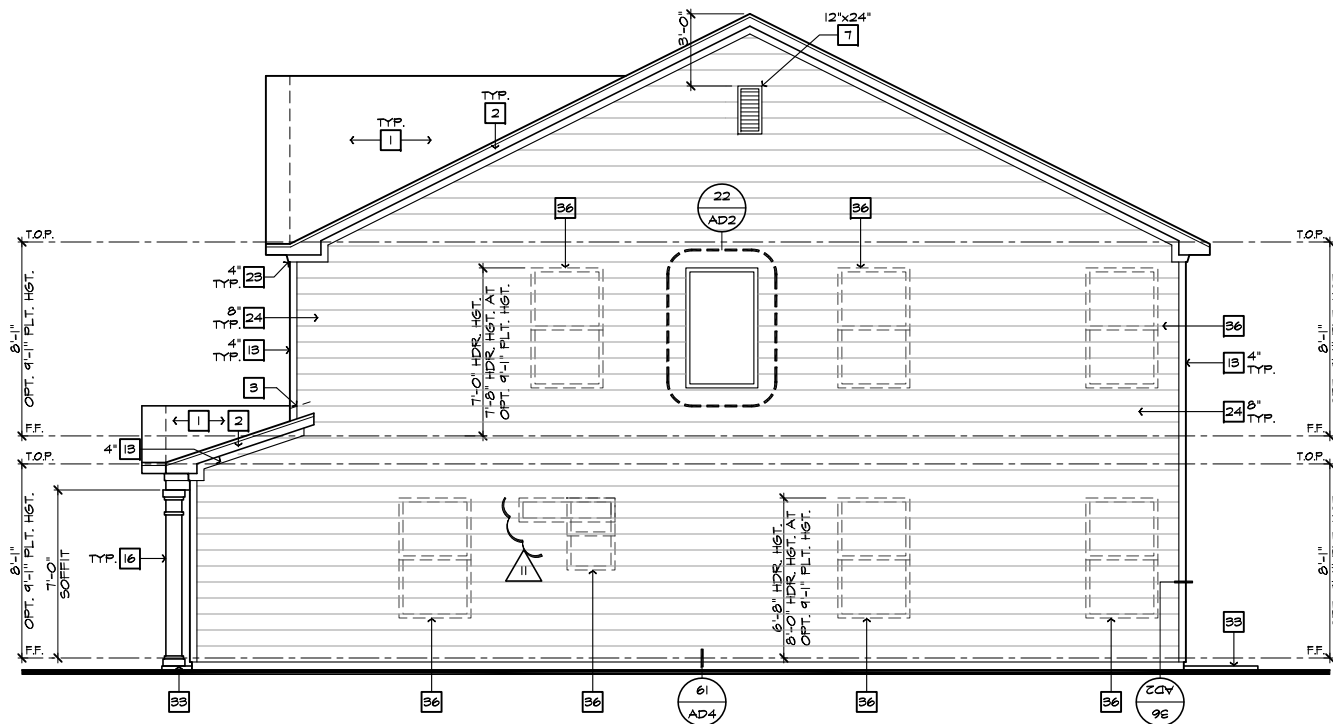

RIGHT ELEVATION 'A'

SCALE 1/4"=1'-0" (22'x34") - 1/8"=1'-0" (11'x17")

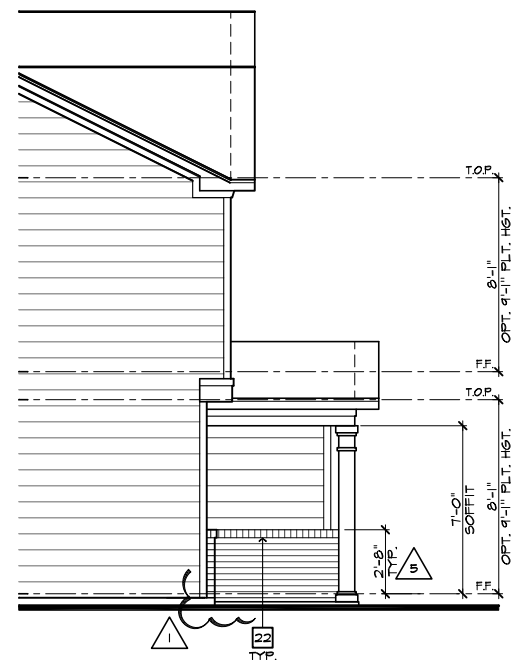

**PARTIAL LEFT ELEVATION 'A'
W/ MASONRY OPTION**

SCALE 1/4"=1'-0" (22'x34") - 1/8"=1'-0" (11'x17")

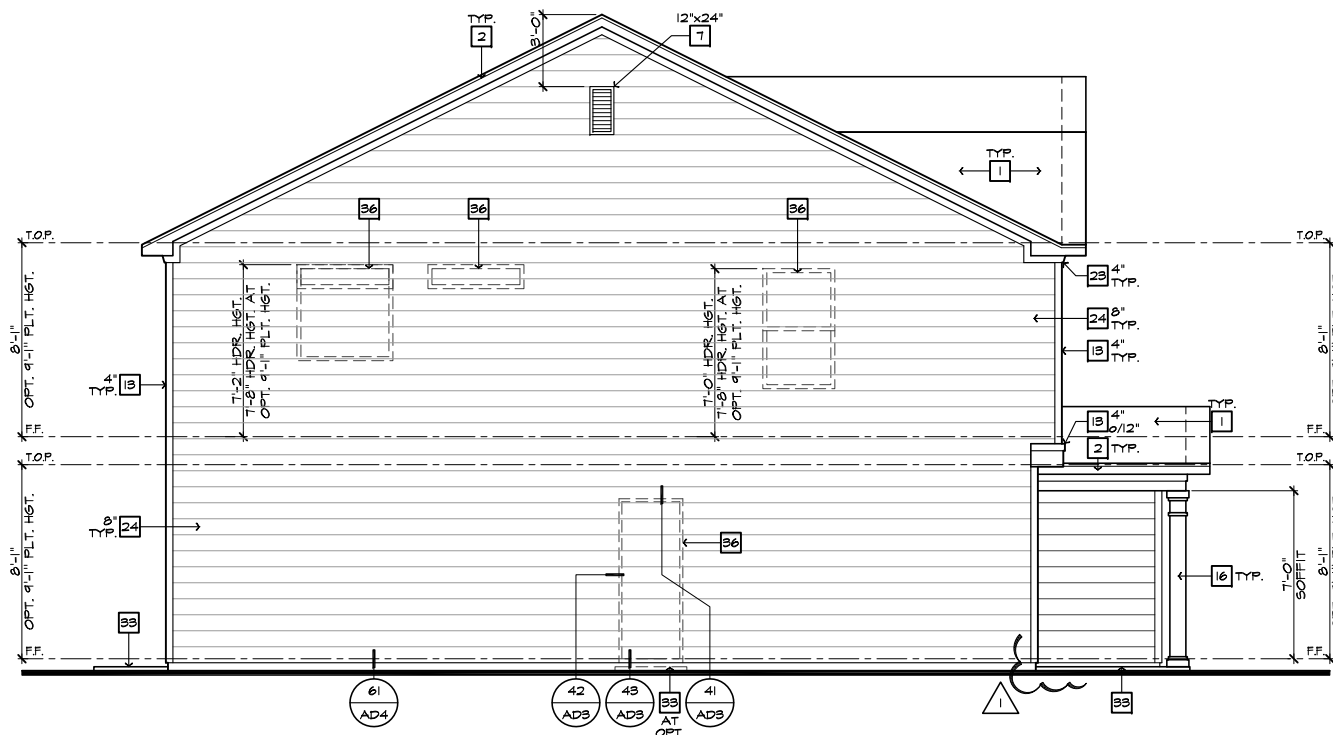

LEFT ELEVATION 'A'

SCALE 1/4"=1'-0" (22'x34") - 1/8"=1'-0" (11'x17")

- # ELEVATION NOTES**
- NOTE: NOT ALL KEY NOTES APPLY.
1. ROOF MATERIAL - REFER TO ROOF NOTES
 2. 2X FASCIA/BARGE BOARD WITH FASCIA CAP
 3. 6.1. FLASHING
 4. 6.1. FLASHING & SADDLE/CRICKET
 5. 6.1. DRIP SCREED
 6. 24"x24" CHIMNEY
 7. DECORATIVE VENT
 8. DECORATIVE CORBEL
 9. DECORATIVE SHUTTERS
 10. PEDIMENT. SEE ELEVATION FOR TYPE
 11. RECESSED ELEMENT
 12. DECORATIVE TRIM FYPON OR EQ. SEE ELEVATION FOR TYPE
 13. TRIM PER SPEC- SEE ELEVATION FOR SIZE
 14. SYNTHETIC MATERIAL
 15. PRE-MANUFACTURED DECORATIVE COLUMN (SIZE, SEE ELEV.) FYPON OR EQ. SURROUNDING STRUCTURAL POST.
 16. SITE-BUILT COLUMN - SEE ELEVATION FOR TYPE
 17. SHAKE SIDING
 18. STONE VENEER PER SPECS
 19. BRICK/MASONRY VENEER PER SPECS
 20. BUILT UP BRICK COLUMN
 21. SOLDIER COURSE
 22. RAILLOCK COURSE
 23. FRIEZE BOARD
 24. SIDING W/ 4" CORNER TRIM PER SPECS
 25. P.T. POST W/ WRAP - SEE STRUCTURAL FOR SIZE
 26. PRE-FAB DECORATIVE TRIM
 27. LIGHT WEIGHT PRECAST STONE TRIM
 28. P.T. LUMBER RAILINGS (36" U.N.O.)
 29. WRAP
 30. DECORATIVE WINDOW/DOOR TRIM - FYPON OR EQ. SEE ELEVATION FOR SIZE.
 31. BRACKET OR KICKER - FYPON OR EQ.
 32. ENTRY DOOR
 33. CONCRETE STOOP/ PORCH - SEE SLAB INTERFACE PLAN.
 34. SECTIONAL GARAGE DOOR PER SPECS
 35. ALUMINUM WRAP
 36. OPTIONAL DOOR/WINDOW - REFER TO PLAN OPTIONS
 37. OPTIONAL STANDING SEAM METAL ROOF
 38. KEYSTONE
 39. SOLDIER CROWN
 40. JACK SOLDIER COURSE
 41. WATER TABLE
 42. ATRIUM DOOR
 43. PILASTER - SEE ELEVATION FOR TYPE



**NORTH CAROLINA
40' SERIES**

KB HOME
NORTH CAROLINA DIVISION

4506 S. MIAMI BLVD.
SUITE 180
DURHAM, NC 27703
TEL: (919) 768-7980
FAX: (919) 544-2928

**2018 NORTH
CAROLINA STATE
BUILDING
CODES**

- ISSUE DATE: 01/08/15
PROJECT No.: 1350999:56
DIVISION MGR.: DCS
REVISIONS: 08/20/20
- 11 DIVISION REVISION NC19654NCP - 08/28/19 - FAE
 - 12 DIVISION REVISION NC19657NCP - 09/26/19 - FAE
 - 13 DIVISION REVISION NC20003NCP - 12/19/19 - CL
 - 14 VENTILATION NC20008NCP - 01/17/20 - CL
 - 15 DIVISION REVISION NC20013NCP - 02/10/20 - MCP
 - 16 DIVISION REVISION NC20017NCP - 03/04/20 - KBA
 - 17 HOME OFFICE CORP20009CORP-08/20/20-CTD

FOR INTERNAL USE ONLY

REVIEWED BY:

1.	
2.	
3.	
4.	
5.	
6.	

PLAN:
238.2338

SHEET:
3.A2

**SPEC. LEVEL 1
RALEIGH-DURHAM
40' SERIES**

These designs and drawings are CONFIDENTIAL, and the exclusive property of KB Home Corporation. They may not be used or duplicated without the express permission of KB Home Corporation. Copyright 2020 © KB Home Corporation, all rights reserved.

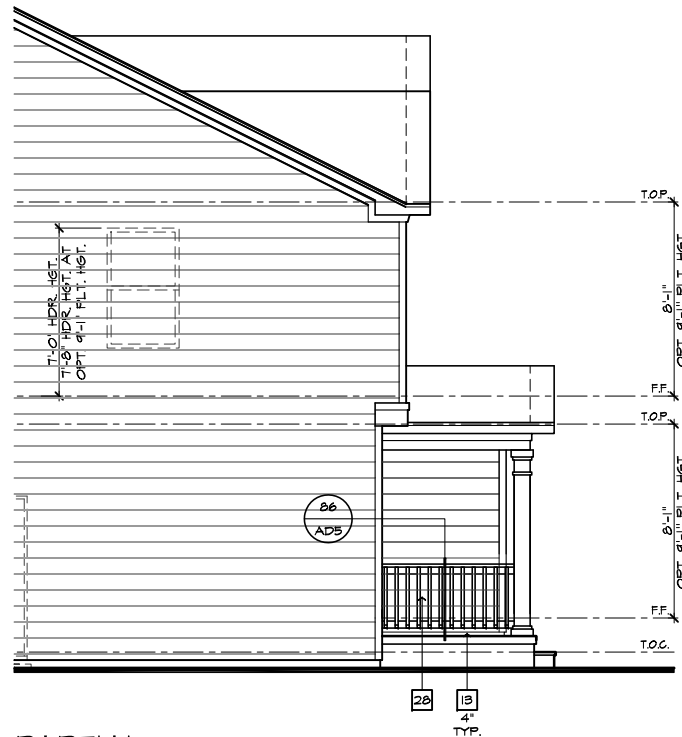

PARTIAL LEFT ELEVATION 'A' AT CRAWL SPACE
 SCALE 1/4"=1'-0" (22"X34") - 1/8"=1'-0" (11"X17")

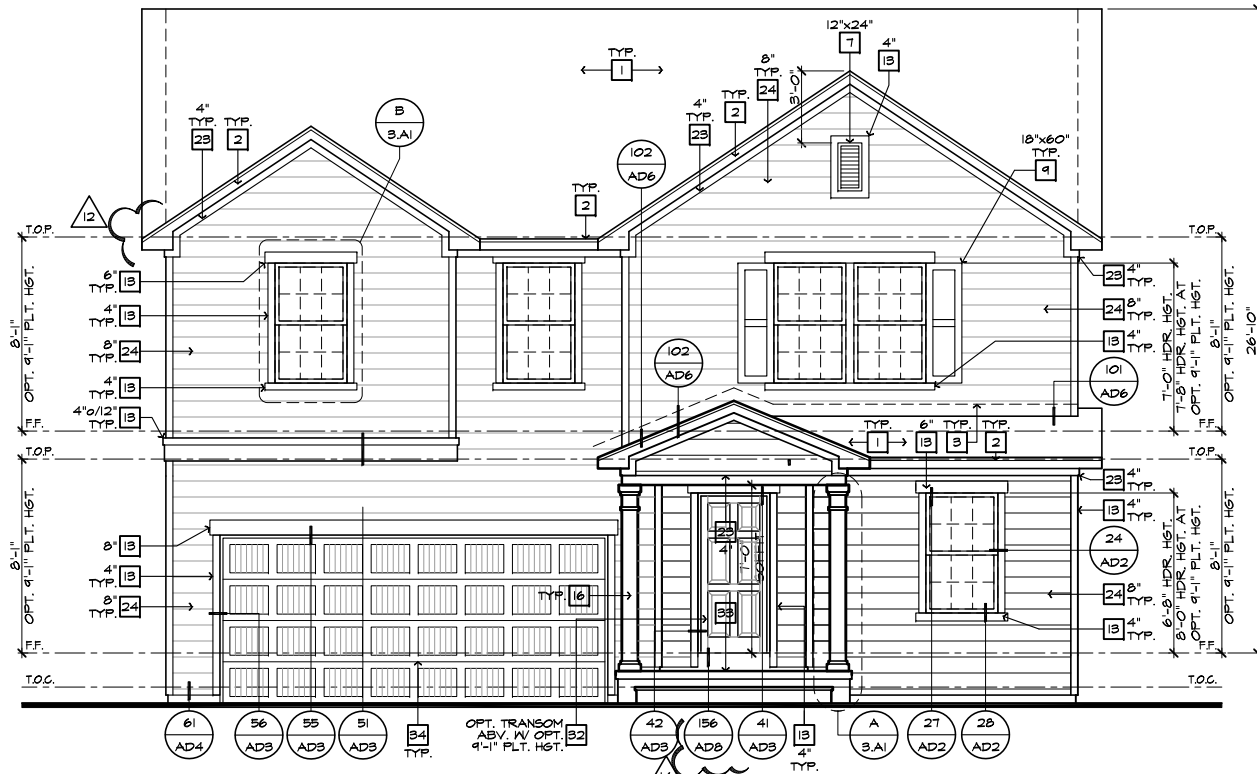

FRONT ELEVATION 'A' W/ CRAWL SPACE
 SCALE 1/4"=1'-0" (22"X34") - 1/8"=1'-0" (11"X17")

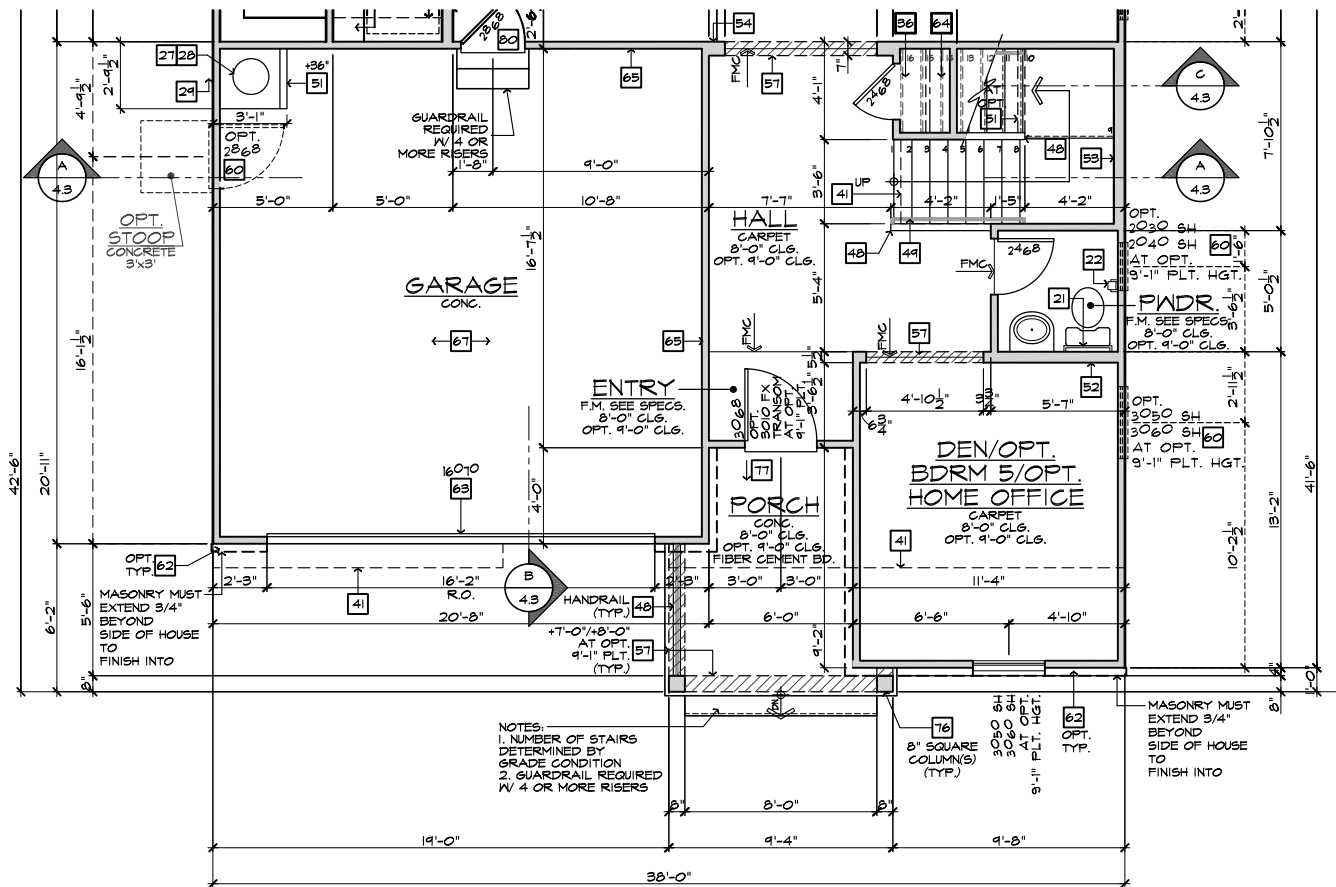

PARTIAL FIRST FLOOR PLAN 'A' AT CRAWL SPACE
 SCALE 1/4"=1'-0" (22"X34") - 1/8"=1'-0" (11"X17")

#	ELEVATION NOTES
NOTE: NOT ALL KEY NOTES APPLY.	
1.	ROOF MATERIAL - REFER TO ROOF NOTES
2.	2X FASCIA/BARGE BOARD WITH FASCIA CAP
3.	G.I. FLASHING
4.	G.I. FLASHING & SADDLE/CRICKET
5.	G.I. DRIP SCREED
6.	24"X24" CHIMNEY
7.	DECORATIVE VENT
8.	DECORATIVE CORBEL
9.	DECORATIVE SHUTTERS
10.	PEDIMENT. SEE ELEVATION FOR TYPE
11.	RECESSED ELEMENT
12.	DECORATIVE TRIM FYPON OR EQ. SEE ELEVATION FOR TYPE
13.	TRIM PER SPEC - SEE ELEVATION FOR SIZE
14.	SYNTHETIC MATERIAL
15.	PRE-MANUFACTURED DECORATIVE COLUMN (SIZE, SEE ELEV.) FYPON OR EQ. SURROUNDING STRUCTURAL POST.
16.	SITE-BUILT COLUMN - SEE ELEVATION FOR TYPE
17.	SHAKE SIDING
18.	STONE VENEER PER SPECS
19.	BRICK/MASONRY VENEER PER SPECS
20.	BUILT UP BRICK CURB
21.	SOLDIER COURSE
22.	ROWLOCK COURSE
23.	FRIEZE BOARD
24.	SIDING W/ 4" CORNER TRIM PER SPECS
25.	P.T. POST W/ WRAP - SEE STRUCTURAL FOR SIZE
26.	PRE-FAB DECORATIVE TRIM
27.	LIGHT WEIGHT PRECAST STONE TRIM
28.	P.T. LUMBER RAILINGS (36" U.N.O.)
29.	WRAP
30.	DECORATIVE WINDOW/DOOR TRIM - FYPON OR EQ. SEE ELEVATION FOR SIZE
31.	BRACKET OR KICKER - FYPON OR EQ.
32.	ENTRY DOOR
33.	CONCRETE STOOP/ PORCH - SEE SLAB INTERFACE PLAN.
34.	SECTIONAL GARAGE DOOR PER SPECS
35.	ALUMINUM WRAP
36.	OPTIONAL DOOR/WINDOW - REFER TO PLAN OPTIONS
37.	OPTIONAL STANDING SEAM METAL ROOF
38.	KEYSTONE
39.	SOLDIER CROWN
40.	JACK SOLDIER COURSE
41.	WATER TABLE
42.	ATRIUM DOOR
43.	PILASTER - SEE ELEVATION FOR TYPE

#	PARTIAL PLAN NOTES
NOTE: NOT ALL KEY NOTES APPLY.	
27.	WATER HEATER LOCATION - FOR GAS - LOCATE ON 18" HIGH PLATFORM - FOR INTERIOR LOCATION - PROVIDE PAN & DRAIN (REFER TO DETAILS)
28.	WATER HEATER B VENT TO OUTSIDE AIR
29.	MAIN LINE SHUT-OFF VALVE AND TEMP. & PRESSURE RELIEF VALVE
34.	LINE OF WALL BELOW
41.	LINE OF FLOOR ABOVE
42.	LINE OF FLOOR BELOW
43.	LINE 36" HIGH GUARDRAIL (REFER TO DETAIL SHEETS)
50.	A/C PAD LOCATION
51.	LOW WALL - REFER TO PLAN FOR HEIGHT
52.	2x6 STUD WALL
54.	DEL. 2x4 WALL PER PLAN
55.	INTERIOR SHELF - REFER TO PLAN FOR HEIGHT
57.	FLAT SOFFIT
58.	ARCHED SOFFIT
60.	OPT. DOOR/WINDOW
61.	PRE-MANUFACTURED DECORATIVE COLUMN (SIZE, SEE ELEV.) FYPON OR EQ. SURROUNDING STRUCTURAL POST.
62.	BRICK / STONE VENEER - REFER TO ELEVATIONS
63.	SECTIONAL GARAGE DOOR PER SPECS
66.	3" DIAM. CONCRETE FILLED PIPE BOLLARD 36" HIGH WITH MIN. 12" EMBEDMENT INTO CONCRETE. (NOT REQUIRED AT ELECTRIC WATER HEATERS OR FOR APPLIANCES LOCATED OUT OF THE VEHICLE'S NORMAL TRAVEL PATH.)
68.	P.T. POST W/ WRAP.
70.	EGRESS WINDOW
75.	WINDOW LEDGE. HEIGHT & WIDTH OF OPENING TO EXTEND 6" BEYOND WINDOW(S) ON ALL SIDES U.N.O.
76.	SITE-BUILT COLUMN - SEE ELEVATION FOR TYPE
77.	CONCRETE SLAB. SLOPE 1/4" PER FT. MIN. SEE PLAN FOR SIZE

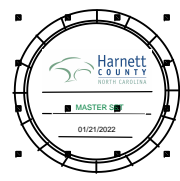

NORTH CAROLINA 40' SERIES

KB HOME
 NORTH CAROLINA DIVISION
 4506 S. MIAMI BLVD.
 SUITE 180
 DURHAM, NC 27703
 TEL: (919) 768-7980
 FAX: (919) 544-2928

2018 NORTH CAROLINA STATE BUILDING CODES

- ISSUE DATE: 01/08/15
- PROJECT No.: 1350999:56
- DIVISION MGR.: DCS
- REVISIONS: 08/20/20
- 11 DIVISION REVISION NC13654NCP - 08/28/19 - FAB
- 12 DIVISION REVISION NC13657NCP - 09/26/19 - FAB
- 13 DIVISION REVISION NC20003NCP - 12/19/19 - CL
- 14 VENTILATION NC20008NCP - 01/17/20 - CL
- 15 DIVISION REVISION NC20013NCP - 02/10/20 - MCP
- 16 DIVISION REVISION NC20017NCP - 03/04/20 - KBA
- 17 HOME OFFICE CORP20009CORP-08/20/20-CTD

FOR INTERNAL USE ONLY	
REVIEWED BY:	
1.	
2.	
3.	
4.	
5.	
6.	

PLAN: 238.2338
 SHEET: 3.A3

SPEC. LEVEL 1 RALEIGH-DURHAM 40' SERIES

NOTE: REFER TO BASIC ELEVATIONS FOR INFORMATION NOT SHOWN HERE

NOTE: REFER TO BASIC FLOOR PLAN FOR INFORMATION NOT SHOWN HERE

These designs and drawings are CONFIDENTIAL, and the exclusive property of KB Home Corporation, and are not to be disclosed without the express permission of KB Home Corporation. Copyright 2020 © KB Home Corporation, all rights reserved.

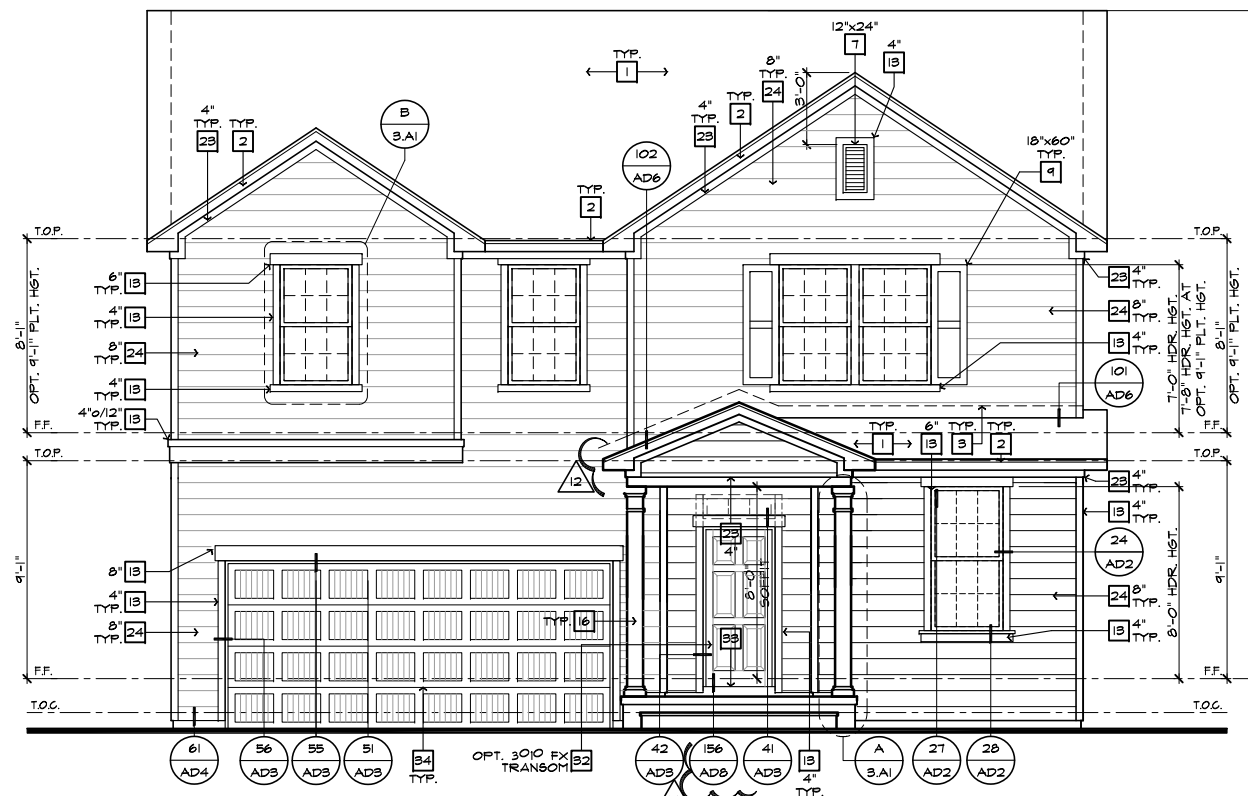

FRONT ELEVATION 'A' W/ CRAWL SPACE
AT OPTIONAL 9'-1" PLT. HGT.

SCALE 1/4"=1'-0" (22'x34") - 1/8"=1'-0" (11'x17')

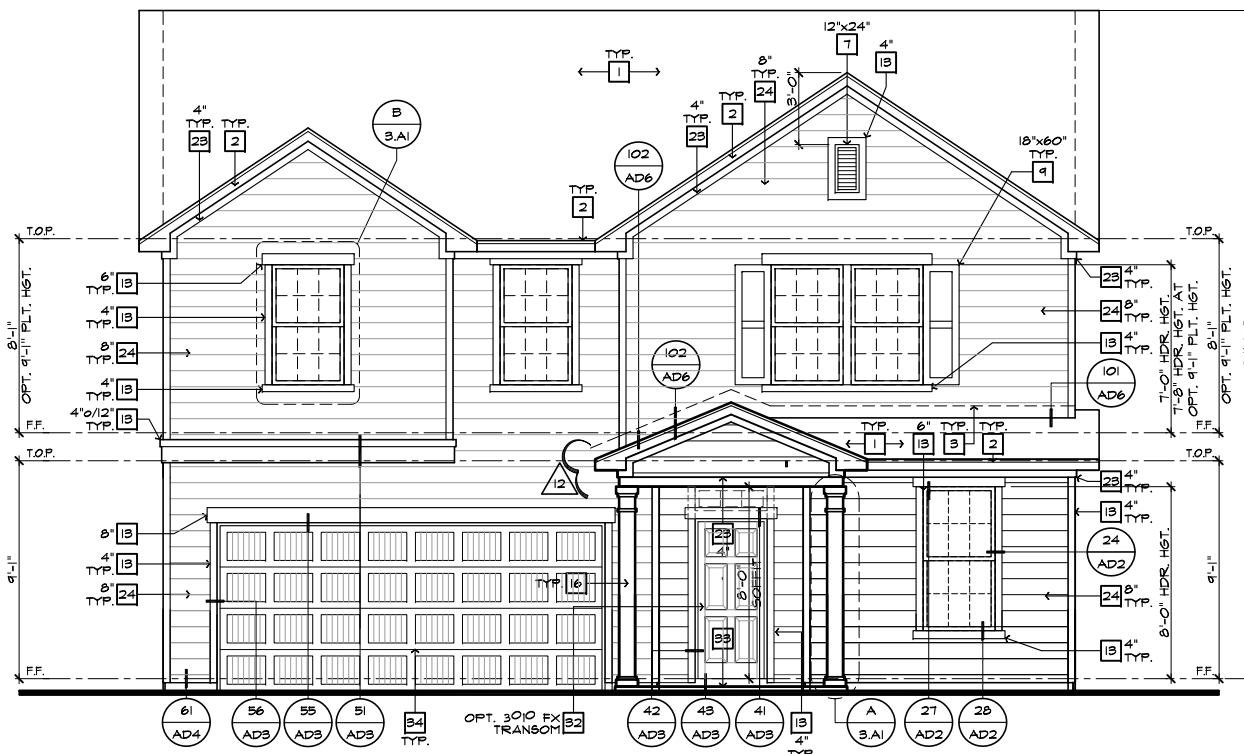

FRONT ELEVATION 'A'
AT OPTIONAL 9'-1" PLT. HGT.

SCALE 1/4"=1'-0" (22'x34") - 1/8"=1'-0" (11'x17')

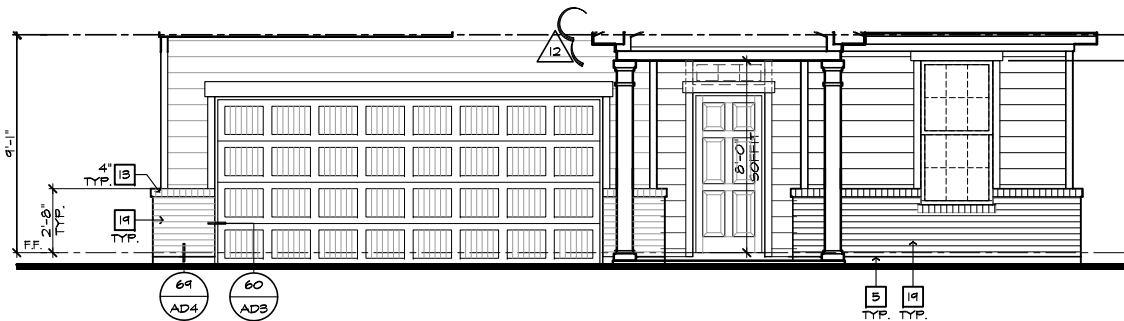

PARTIAL FRONT ELEVATION 'A'
AT OPTIONAL 9'-1" PLT. HGT. W/ BRICK OPT.

SCALE 1/4"=1'-0" (22'x34") - 1/8"=1'-0" (11'x17')

#	ELEVATION NOTES
NOTE: NOT ALL KEY NOTES APPLY.	
1.	ROOF MATERIAL - REFER TO ROOF NOTES
2.	2X FASCIA/BARGE BOARD WITH FASCIA CAP
3.	6.1. FLASHING
4.	6.1. FLASHING & SADDLE/CRICKET
5.	6.1. DRIP SCREED
6.	24"x24" CHIMNEY
7.	DECORATIVE VENT
8.	DECORATIVE CORBEL
9.	DECORATIVE SHUTTERS
10.	PEDIMENT. SEE ELEVATION FOR TYPE
11.	RECESSED ELEMENT
12.	DECORATIVE TRIM FYPON OR EQ. SEE ELEVATION FOR TYPE
13.	TRIM PER SPEC - SEE ELEVATION FOR SIZE
14.	SYNTHETIC MATERIAL
15.	PRE-MANUFACTURED DECORATIVE COLUMN (SIZE, SEE ELEV.) FYPON OR EQ. SURROUNDING STRUCTURAL POST.
16.	SITE-BUILT COLUMN - SEE ELEVATION FOR TYPE
17.	SHAKE SIDING
18.	STONE VENEER PER SPECS
19.	BRICK/MASONRY VENEER PER SPECS
20.	BUILT UP BRICK COLUMN
21.	SOLDIER COURSE
22.	ROWLOCK COURSE
23.	FRIEZE BOARD
24.	SIDING W/ 4" CORNER TRIM PER SPECS
25.	P.T. POST W/ WRAP - SEE STRUCTURAL FOR SIZE
26.	PRE-FAB DECORATIVE TRIM
27.	LIGHT WEIGHT PRECAST STONE TRIM
28.	P.T. LUMBER RAILINGS (+36" U.N.O.)
29.	WRAP
30.	DECORATIVE WINDOW/DOOR TRIM - FYPON OR EQ. SEE ELEVATION FOR SIZE.
31.	BRACKET OR KICKER - FYPON OR EQ.
32.	ENTRY DOOR
33.	CONCRETE STOOP/ PORCH - SEE SLAB INTERFACE PLAN.
34.	SECTIONAL GARAGE DOOR PER SPECS
35.	ALUMINUM WRAP
36.	OPTIONAL DOOR/WINDOW - REFER TO PLAN OPTIONS
37.	OPTIONAL STANDING SEAM METAL ROOF
38.	KEYSTONE
39.	SOLDIER CROWN
40.	JACK SOLDIER COURSE
41.	WATER TABLE
42.	ATRIUM DOOR
43.	PILASTER - SEE ELEVATION FOR TYPE
9'-1" PLATE OPTION	
NOTE: WINDOW SIZES WILL INCREASE BY 1" AT 9'-1" PLATE OPTIONS. HEADER HEIGHTS FOR ALL WINDOWS WILL BE 7'-6" AT 9'-1" PLATE OPTIONS.	

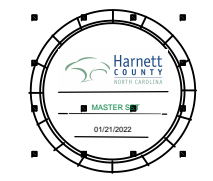

**NORTH CAROLINA
40' SERIES**

KB HOME
NORTH CAROLINA DIVISION
4506 S. MIAMI BLVD.
SUITE 180
DURHAM, NC 27703
TEL: (919) 768-7980
FAX: (919) 544-2928

**2018 NORTH
CAROLINA STATE
BUILDING
CODES**

- ISSUE DATE: 01/08/15
- PROJECT No.: 1350999:56
- DIVISION MGR.: DCS
- REVISIONS: 08/20/20
- 11 DIVISION REVISION NC19654NCP - 08/28/19 - FAE
- 12 DIVISION REVISION NC19657NCP - 09/26/19 - FAE
- 13 DIVISION REVISION NC20033NCP - 12/15/19 - CL
- 14 VENTILATION NC20008NCP - 01/17/20 - CL
- 15 DIVISION REVISION NC20013NCP - 02/10/20 - MCP
- 16 DIVISION REVISION NC20017NCP - 03/04/20 - KBA
- 17 HOME OFFICE CORP20039CORP-08/20/20-CTD

FOR INTERNAL USE ONLY	
REVIEWED BY:	
1.	
2.	
3.	
4.	
5.	
6.	

PLAN:
238.2338
SHEET:
3.A4

**SPEC. LEVEL 1
RALEIGH-DURHAM
40' SERIES**

These designs and drawings are CONFIDENTIAL, and the exclusive property of KB Home Corporation, and are not to be disclosed without the express permission of KB Home Corporation. Copyright 2020 © KB Home Corporation, all rights reserved.

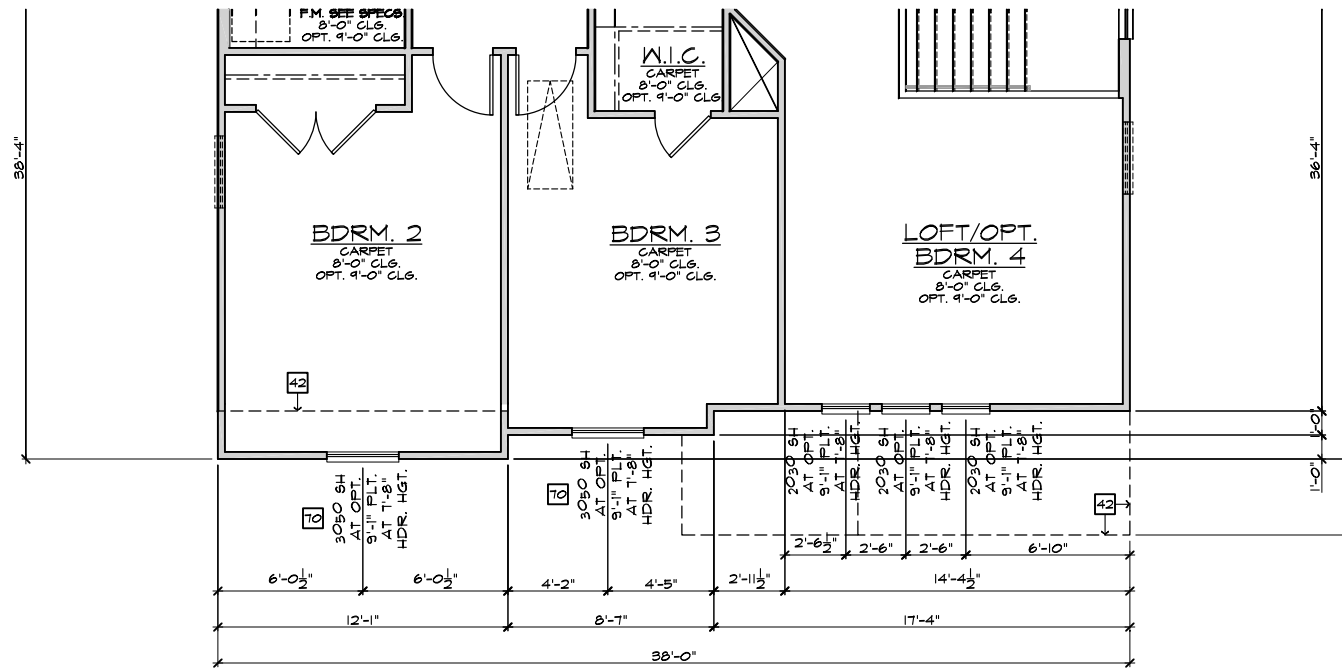

PARTIAL SECOND FLOOR PLAN 'B'

SCALE 1/4"=1'-0" (22'x34') - 1/8"=1'-0" (11'x17')

BASIC PLAN

#	PARTIAL PLAN NOTES
NOTE: NOT ALL KEY NOTES APPLY.	
27.	WATER HEATER LOCATION - FOR GAS - LOCATE ON 18" HIGH PLATFORM - FOR INTERIOR LOCATION - PROVIDE PAN & DRAIN (REFER TO DETAILS)
28.	WATER HEATER VENT TO OUTSIDE AIR
29.	MAIN LINE SHUT-OFF VALVE AND TEMP. & PRESSURE RELIEF VALVE
34.	LINE OF WALL BELOW
41.	LINE OF FLOOR ABOVE
42.	LINE OF FLOOR BELOW
49.	MIN. 36" HIGH GUARDRAIL (REFER TO DETAIL SHEETS)
50.	A/C PAD LOCATION
51.	LOW WALL - REFER TO PLAN FOR HEIGHT
52.	2x6 STUD WALL
54.	DBL. 2x4 WALL PER PLAN
55.	INTERIOR SHELF - REFER TO PLAN FOR HEIGHT
57.	FLAT SOFFIT
58.	ARCHED SOFFIT
60.	OPT. DOOR/WINDOW
61.	PRE-MANUFACTURED DECORATIVE COLUMN (SIZE, SEE ELEV.)
62.	BRICK / STONE VENEER - REFER TO ELEVATIONS
63.	SECTIONAL GARAGE DOOR PER SPECS
66.	3" DIAM. CONCRETE FILLED PIPE BOLLARD 36" HIGH WITH MIN. 12" EMBEDMENT INTO CONCRETE (NOT REQUIRED AT ELECTRIC WATER HEATERS OR FOR APPLIANCES LOCATED OUT OF THE VEHICLE'S NORMAL TRAVEL PATH)
68.	P.T. POST IV WRAP
70.	EGRESS WINDOW
75.	WINDOW LEDGE - HEIGHT & WIDTH OF OPENING TO EXTEND 6" BEYOND WINDOW(S) ON ALL SIDES UNO.
76.	SITE-BUILT COLUMN - SEE ELEVATION FOR TYPE
77.	CONCRETE SLAB - SLOPE 1/4" PER FT. MIN. SEE PLAN FOR SLOPE



NORTH CAROLINA 40' SERIES

KB HOME
NORTH CAROLINA DIVISION
4506 S. MIAMI BLVD.
SUITE 180
DURHAM, NC 27703
TEL: (919) 768-7980
FAX: (919) 544-2928

2018 NORTH CAROLINA STATE BUILDING CODES

- ISSUE DATE: 01/08/15
- PROJECT No.: 1350999:56
- DIVISION MGR.: DCS
- REVISIONS: 08/20/20
- 11 DIVISION REVISION NC19654NCP - 08/28/19 - FAE
- 12 DIVISION REVISION NC19657NCP - 09/26/19 - FAE
- 13 DIVISION REVISION NC20003NCP - 12/19/19 - CL
- 14 VENTILATION NC20008NCP - 01/17/20 - CL
- 15 DIVISION REVISION NC20013NCP - 02/10/20 - MCP
- 16 DIVISION REVISION NC20017NCP - 03/04/20 - KBA
- 17 HOME OFFICE CORP20009CORP-08/20/20-CTD

FOR INTERNAL USE ONLY	
REVIEWED BY:	
1.	
2.	
3.	
4.	
5.	
6.	

PLAN:
238.2338
SHEET:
3.B1

SPEC. LEVEL 1 RALEIGH-DURHAM 40' SERIES

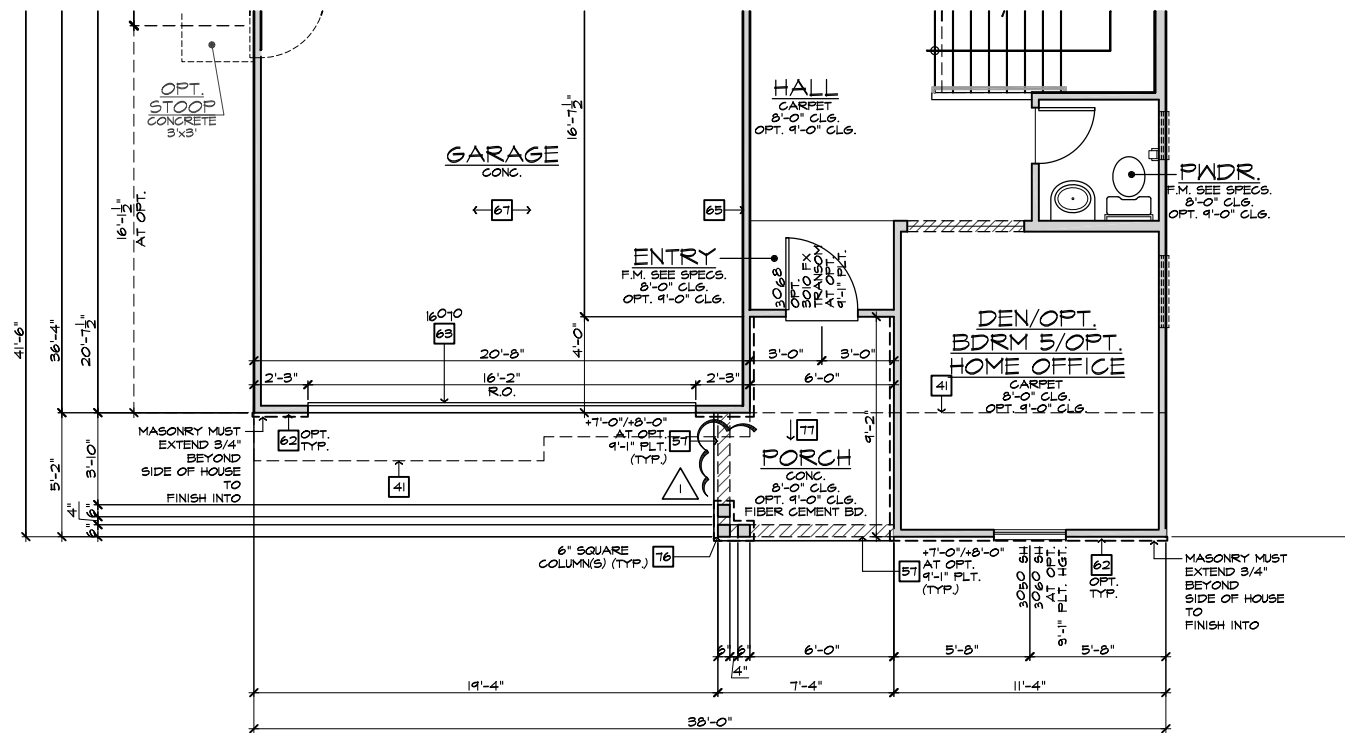

PARTIAL FIRST FLOOR PLAN 'B'

SCALE 1/4"=1'-0" (22'x34') - 1/8"=1'-0" (11'x17')

BASIC PLAN

NOTE: REFER TO BASIC FLOOR PLAN FOR INFORMATION NOT SHOWN HERE

These designs and drawings are CONFIDENTIAL, and the exclusive property of KB Home Corporation and are not to be disclosed without the express permission of KB Home Corporation. Copyright 2020 © KB Home Corporation, all rights reserved.

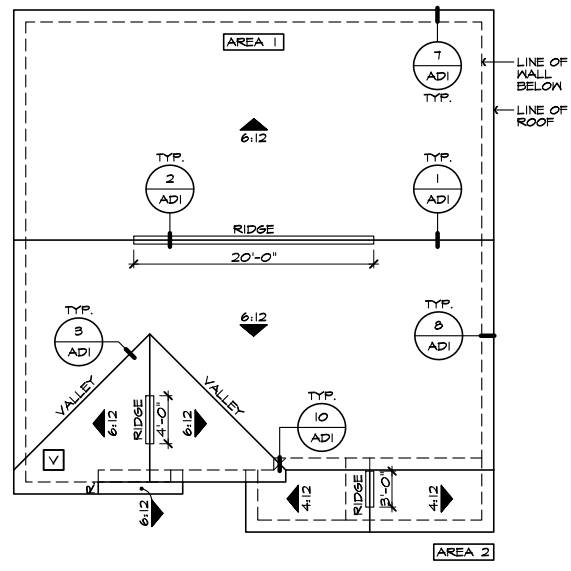

ROOF PLAN 'B'
SCALE 1/8"=1'-0" (22'x34') - 1/16"=1'-0" (11'x17')

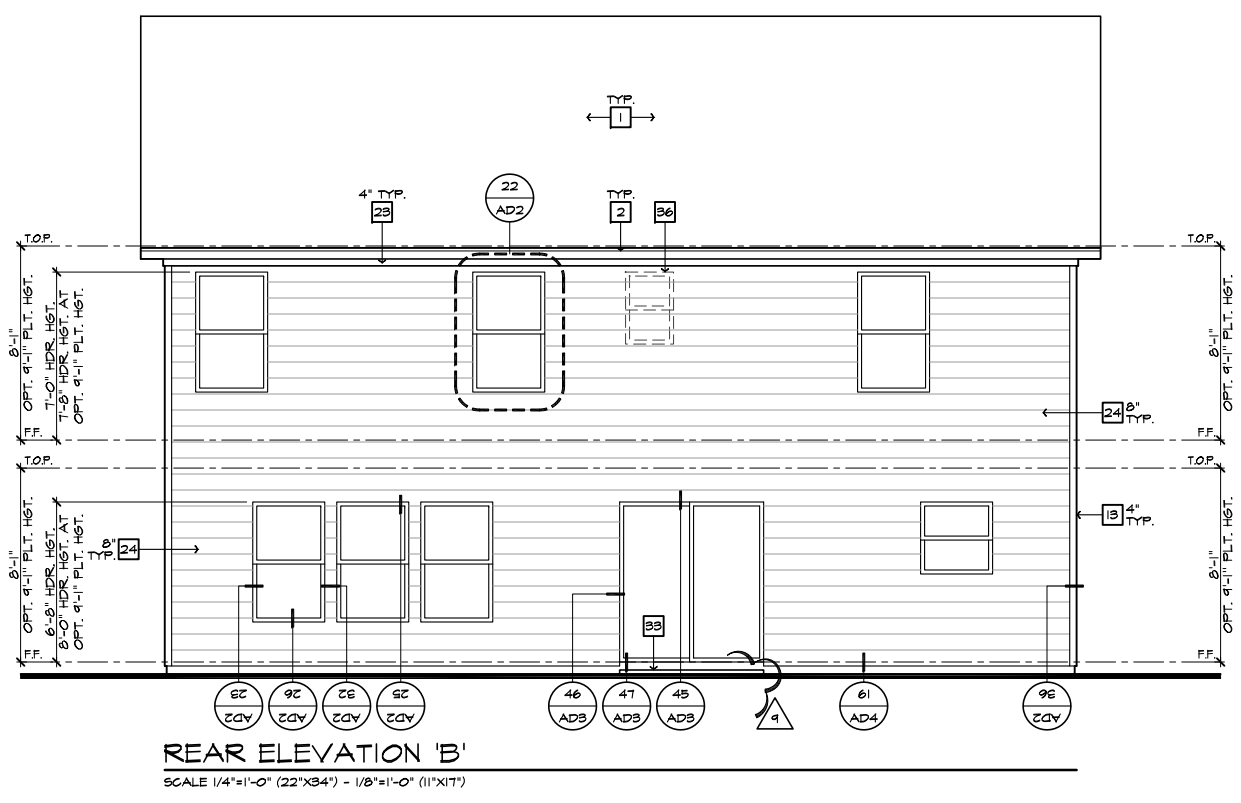

REAR ELEVATION 'B'
SCALE 1/4"=1'-0" (22'x34') - 1/8"=1'-0" (11'x17')

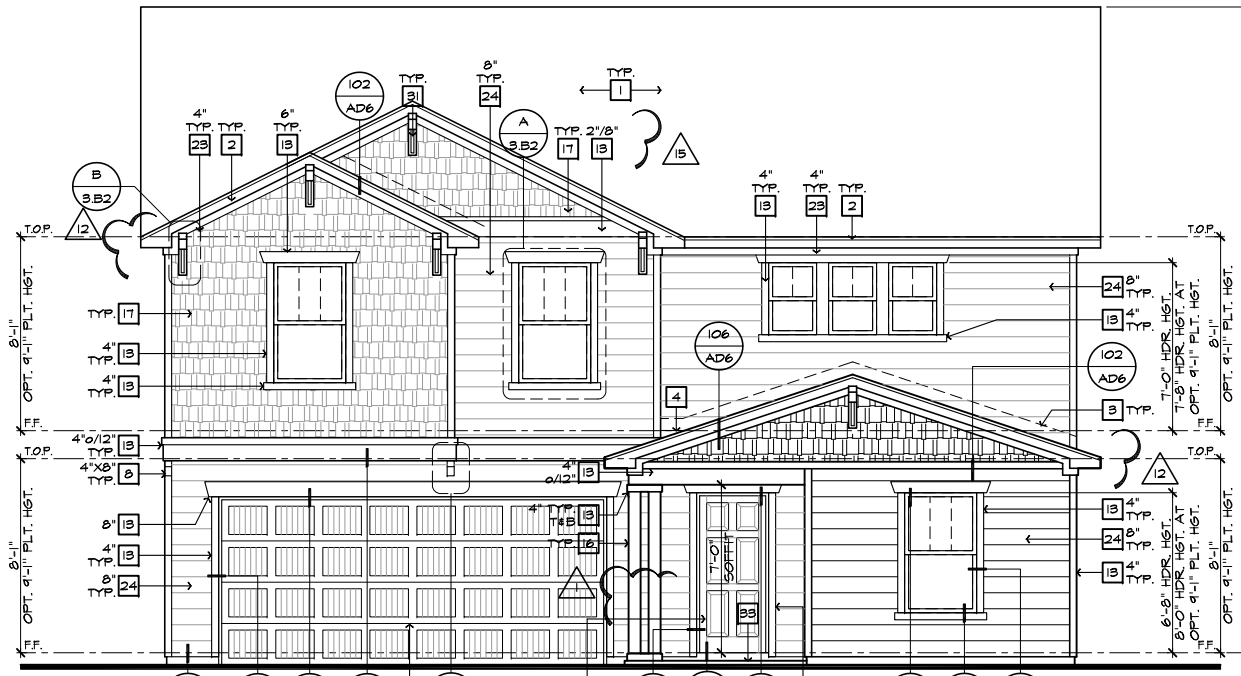

FRONT ELEVATION 'B'
SCALE 1/4"=1'-0" (22'x34') - 1/8"=1'-0" (11'x17')

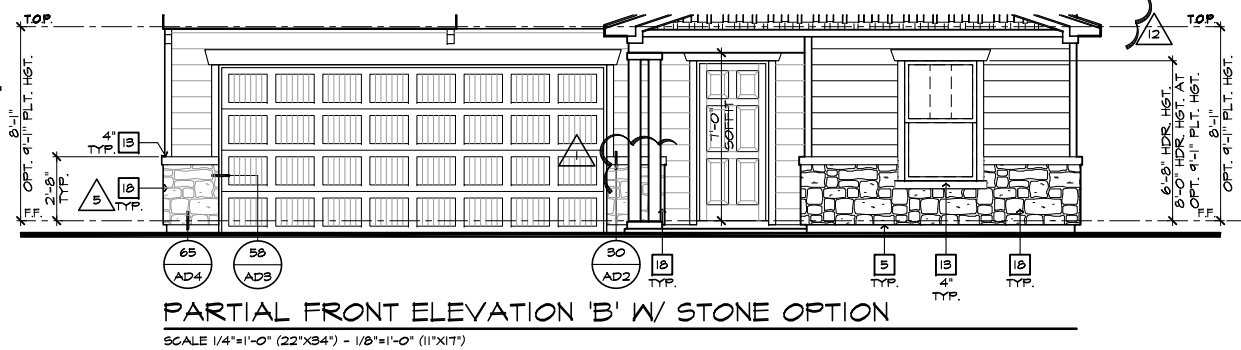

PARTIAL FRONT ELEVATION 'B' W/ STONE OPTION
SCALE 1/4"=1'-0" (22'x34') - 1/8"=1'-0" (11'x17')

- ELEVATION NOTES**
- NOTE: NOT ALL KEY NOTES APPLY.
1. ROOF MATERIAL - REFER TO ROOF NOTES
 2. 2X FASCIA/BARGE BOARD WITH FASCIA CAP
 3. 6:1 FLASHING
 4. 6:1 FLASHING & SADDLE/CRICKET
 5. 6:1 DRIP SCREED
 6. 24"x24" CHIMNEY
 7. DECORATIVE VENT
 8. DECORATIVE CORBEL
 9. DECORATIVE SHUTTERS
 10. PEDIMENT. SEE ELEVATION FOR TYPE
 11. RECESSED ELEMENT
 12. DECORATIVE TRIM FYPON OR EQ. SEE ELEVATION FOR TYPE
 13. TRIM PER SPEC- SEE ELEVATION FOR SIZE
 14. SYNTHETIC MATERIAL
 15. PRE-MANUFACTURED DECORATIVE COLUMN (SIZE, SEE ELEV.) FYPON OR EQ. SURROUNDING STRUCTURAL POST.
 16. SITE-BUILT COLUMN - SEE ELEVATION FOR TYPE
 17. SHAKE SIDING
 18. STONE VENEER PER SPECS
 19. BRICK/MASONRY VENEER PER SPECS
 20. BUILT UP BRICK COLUMN
 21. SOLDIER COURSE
 22. ROWLOCK COURSE
 23. FRIEZE BOARD
 24. SIDING W/ 4" CORNER TRIM PER SPECS
 25. P.T. POST W/ WRAP - SEE STRUCTURAL FOR SIZE
 26. PRE-FAB DECORATIVE TRIM
 27. LIGHT WEIGHT PRECAST STONE TRIM
 28. P.T. LUMBER RAILINGS (36" U.N.O.)
 29. WRAP
 30. DECORATIVE WINDOW/DOOR TRIM - FYPON OR EQ. SEE ELEVATION FOR SIZE.
 31. BRACKET OR KICKER - FYPON OR EQ.
 32. ENTRY DOOR
 33. CONCRETE STOOP/ PORCH - SEE SLAB INTERFACE PLAN.
 34. SECTIONAL GARAGE DOOR PER SPECS
 35. ALUMINUM WRAP
 36. OPTIONAL DOOR/WINDOW - REFER TO PLAN OPTIONS
 37. OPTIONAL STANDING SEAM METAL ROOF
 38. KEYSTONE
 39. SOLDIER CROWN
 40. JACK SOLDIER COURSE
 41. WATER TABLE
 42. ATRIUM DOOR
 43. PILASTER - SEE ELEVATION FOR TYPE

ROOF PLAN NOTES 'B'

6:12 INDICATES ROOF SLOPE AND DIRECTION, U.N.O.

ROOF MATERIAL: COMPOSITION SHINGLE
12" (INCHES) TYPICAL ROOF OVERHANGS AT RAKE, U.N.O.
12" (INCHES) TYPICAL ROOF OVERHANGS AT EAVE, U.N.O.
LOCATE EAVE/ RAFTER VENTS EQUALLY BALANCED AROUND HOUSE EXCEPT ABOVE SHEARWALL PANELS.

ATTIC VENT CALCULATIONS

PROVIDE 1 SQ. IN. OF VENTILATION PER 300 SQ. IN. OF ATTIC SPACE. PROVIDE THAT AT LEAST 50% & NO MORE THAN 80% OF THE REQ. VENTILATING AREA IS PROVIDED BY VENTILATORS LOCATED IN THE UPPER PORTION OF THE ATTIC (HIGH VENTING) AT 3'-0" ABOVE EAVE VENT WITH THE BALANCE BEING PROVIDED BY EAVE VENTS (LOW VENTING) (2018 N.C.-R 806.2)
* CALCULATION BY 1/150, HIGH/LOW VENTING NOT REQUIRED.
APPROXIMATE RIDGE VENT LOCATIONS SHOWN.
ACTUAL LOCATIONS TO BE DETERMINED IN THE FIELD.

AREA 1 / MAIN:	
VENTILATION REQUIRED:	SQ. FT. / 300 4.64 SQ. FT.
ATTIC AREA = 1407	X 144 = 675 SQ. IN.
	TOTAL HIGH & LOW = 675 SQ. IN.
	X 50% = 338 SQ. IN.
VENTILATION PROVIDED:	
HIGH	
24	LF RIDGE VENT(S) AT 10 SQ. IN. / LF. = 482 SQ. IN.
0	ROOF VENT(S) AT 50 SQ. IN. EA. = 0 SQ. IN.
SUB-TOTAL HIGH VENTILATION: 482 SQ. IN.	
LOW	
50	LF VENTILATED SOFFIT AT 6.9 SQ. IN. / LF. = 345 SQ. IN.
1	ROOF VENT(S) AT 50 SQ. IN. EA. = 50 SQ. IN.
SUB-TOTAL LOW VENTILATION: 395 SQ. IN.	
TOTAL VENTILATION PROVIDED: 827 SQ. IN.	
AREA 2 / PORCH:	
VENTILATION REQUIRED:	SQ. FT. / 150 0.63 SQ. FT.
ATTIC AREA = 45	X 144 = 41 SQ. IN.
	TOTAL HIGH & LOW = 41 SQ. IN.
VENTILATION PROVIDED:	
4	LF VENTILATED SOFFIT AT 6.9 SQ. IN. / LF. = 62 SQ. IN.
4	LF RIDGE VENT(S) AT 10 SQ. IN. EA. = 72 SQ. IN.
TOTAL VENTILATION PROVIDED: 134 SQ. IN.	

NOTES:

ALL VENT OPENINGS SHALL BE COVERED WITH 1/4" CORROSION RESISTANT METAL MESH.

FRAMER SHALL BE RESPONSIBLE FOR COORDINATING WITH TRUSS MANUFACTURER TO ACCOMMODATE ALL ATTIC VENTS.

ALL VENTS SHALL BE INSTALLED SO AS TO MAKE THEM WATER-PROOF & WALL MOUNTED LOUVERS SHALL BE SEALED & FLASHED W/ AUTOSTOP IN THE SAME MANNER PRESCRIBED FOR WINDOW INSTALLATION.

PROVIDE APPROVED INSULATION DAMS (BAFFLES) WHERE VENT BLOCKS ARE USED BETWEEN ROOF FRAMING MEMBERS TO PREVENT VENT HOLES FROM BEING BLOCKED BY INSULATION.

LOCATE HIGH VENTING MINIMUM 3'-0" VERTICAL DISTANCE ABOVE EAVES.

WHEN GABLE END TRUSS MEMBERS BLOCK GABLE END VENTS, PROVIDE ADEQUATE ADDITIONAL VENTILATION BY MEANS OF ROOF TILE VENTS.

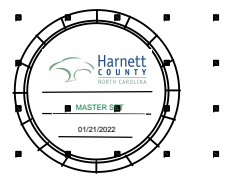

NORTH CAROLINA 40' SERIES

KB HOME
NORTH CAROLINA DIVISION

4506 S. MIAMI BLVD.
SUITE 180
DURHAM, NC 27703
TEL: (919) 768-7980
FAX: (919) 544-2928

2018 NORTH CAROLINA STATE BUILDING CODES

- ISSUE DATE: 01/08/15
PROJECT No.: 1350999:56
DIVISION MGR.: DCS
REVISIONS: 08/20/20
- 11 DIVISION REVISION NC19654NCP - 08/28/19 - FAE
 - 12 DIVISION REVISION NC19657NCP - 09/26/19 - FAE
 - 13 DIVISION REVISION NC20003NCP - 12/19/19 - CL
 - 14 VENTILATION NC20008NCP - 01/17/20 - CL
 - 15 DIVISION REVISION NC20013NCP - 02/10/20 - MCP
 - 16 DIVISION REVISION NC20017NCP - 03/04/20 - KBA
 - 17 HOME OFFICE CORP20009CORP-08/20/20-CTD

FOR INTERNAL USE ONLY

REVIEWED BY:

1. _____
2. _____
3. _____
4. _____
5. _____
6. _____

PLAN: 238.2338
SHEET: 3.B2

SPEC. LEVEL 1
RALEIGH-DURHAM 40' SERIES

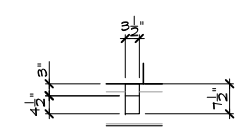

DETAIL 'C'
SCALE: N.T.S.

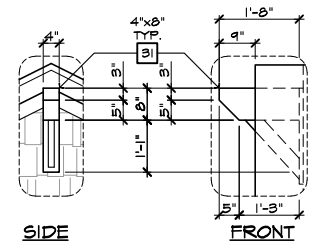

DETAIL 'B'
SCALE: N.T.S.

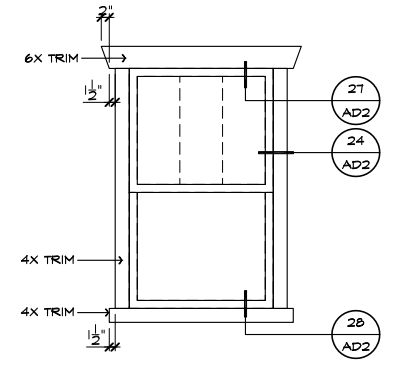

DETAIL 'A'
SCALE: N.T.S.

These designs and drawings are CONFIDENTIAL, and the exclusive property of KB Home Corporation and are not to be disclosed without the express permission of KB Home Corporation. They may not be used or duplicated without the express permission of KB Home Corporation. Copyright 2020 © KB Home Corporation, all rights reserved.

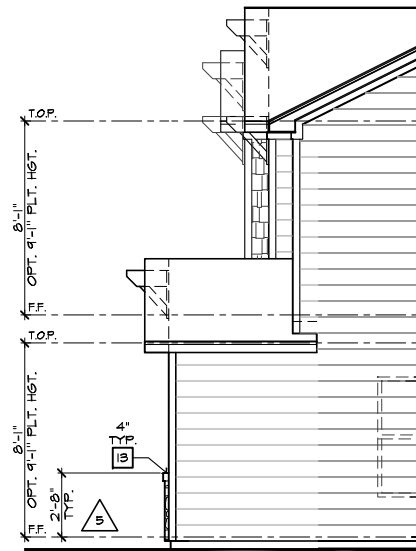

**PARTIAL RIGHT ELEVATION 'B'
W/ STONE OPTION**

SCALE 1/4"=1'-0" (22"X34") - 1/8"=1'-0" (11"X17")

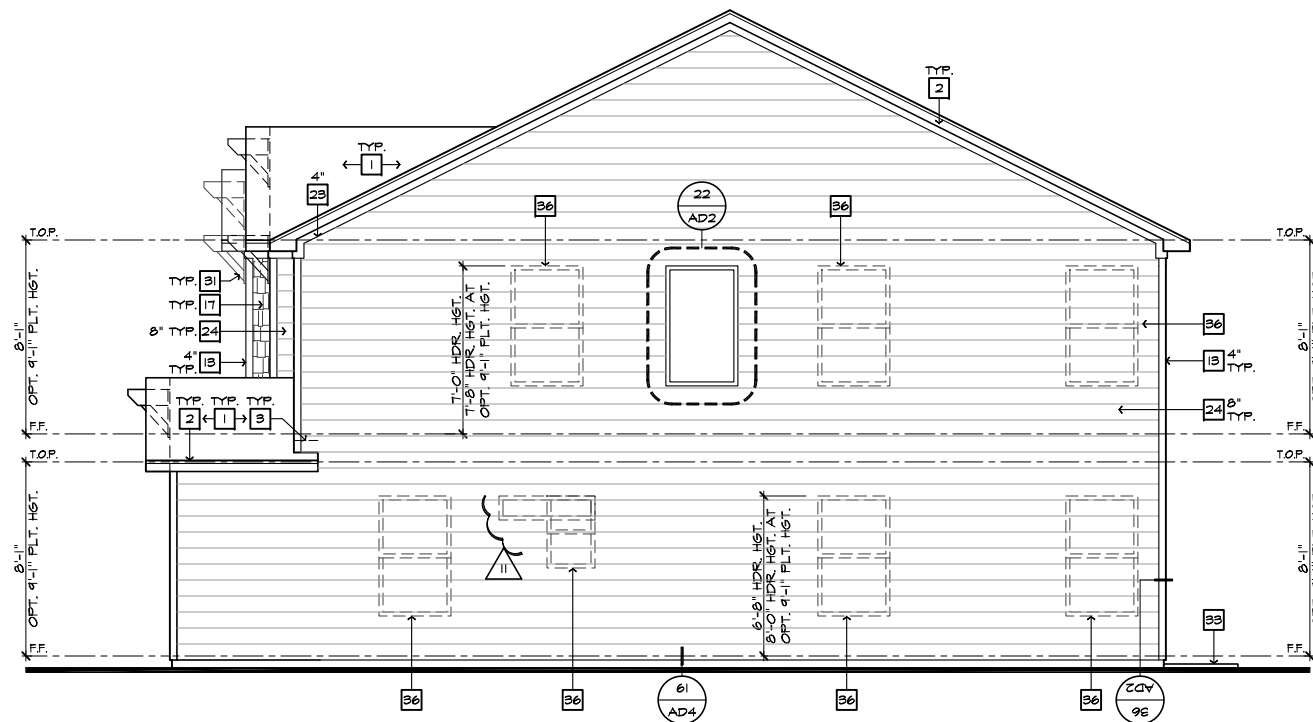

RIGHT ELEVATION 'B'

SCALE 1/4"=1'-0" (22"X34") - 1/8"=1'-0" (11"X17")

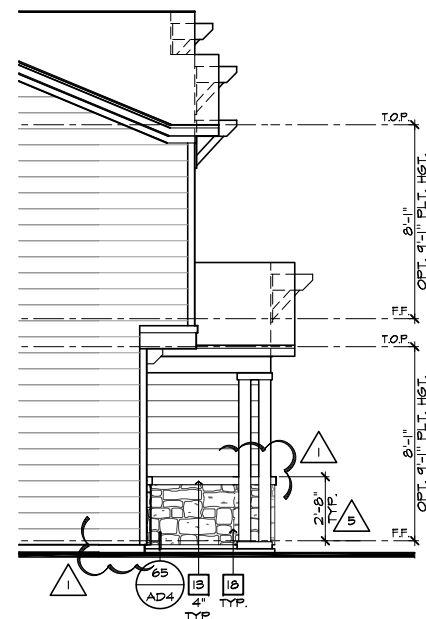

**PARTIAL LEFT ELEVATION 'B'
W/ STONE OPTION**

SCALE 1/4"=1'-0" (22"X34") - 1/8"=1'-0" (11"X17")

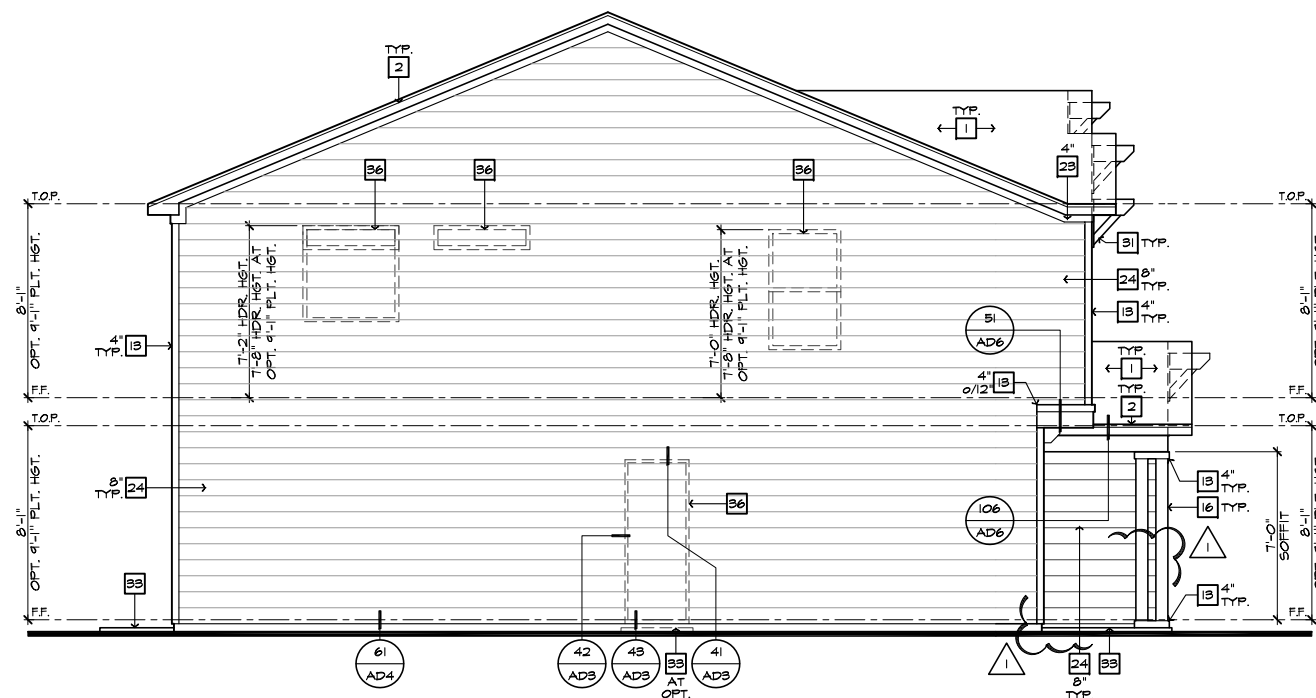

LEFT ELEVATION 'B'

SCALE 1/4"=1'-0" (22"X34") - 1/8"=1'-0" (11"X17")

#	ELEVATION NOTES
NOTE: NOT ALL KEY NOTES APPLY.	
1.	ROOF MATERIAL - REFER TO ROOF NOTES
2.	2X FASCIA/BARGE BOARD WITH FASCIA CAP
3.	6.1. FLASHING
4.	6.1. FLASHING & SADDLE/CRICKET
5.	6.1. DRIP SCREED
6.	24"X24" CHIMNEY
7.	DECORATIVE VENT
8.	DECORATIVE CORBEL
9.	DECORATIVE SHUTTERS
10.	PEDIMENT. SEE ELEVATION FOR TYPE
11.	RECESSED ELEMENT
12.	DECORATIVE TRIM FYPON OR EQ. SEE ELEVATION FOR TYPE
13.	TRIM PER SPEC- SEE ELEVATION FOR SIZE
14.	SYNTHETIC MATERIAL
15.	PRE-MANUFACTURED DECORATIVE COLUMN (SIZE, SEE ELEV.) FYPON OR EQ. SURROUNDING STRUCTURAL POST.
16.	SITE-BUILT COLUMN - SEE ELEVATION FOR TYPE
17.	SHAKE SIDING
18.	STONE VENEER PER SPECS
19.	BRICK/MASONRY VENEER PER SPECS
20.	BUILT UP BRICK COLUMN
21.	SOLDIER COURSE
22.	RONLOCK COURSE
23.	FRIEZE BOARD
24.	SIDING W/ 4" CORNER TRIM PER SPECS
25.	P.T. POST W/ WRAP - SEE STRUCTURAL FOR SIZE
26.	PRE-FAB DECORATIVE TRIM
27.	LIGHT WEIGHT PRECAST STONE TRIM
28.	P.T. LUMBER RAILINGS (+36" U.N.O.)
29.	WRAP
30.	DECORATIVE WINDOW/DOOR TRIM - FYPON OR EQ. SEE ELEVATION FOR SIZE.
31.	BRACKET OR KICKER - FYPON OR EQ.
32.	ENTRY DOOR
33.	CONCRETE STOOP/ PORCH - SEE SLAB INTERFACE PLAN.
34.	SECTIONAL GARAGE DOOR PER SPECS
35.	ALUMINUM WRAP
36.	OPTIONAL DOOR/WINDOW - REFER TO PLAN OPTIONS
37.	OPTIONAL STANDING SEAM METAL ROOF
38.	KEYSTONE
39.	SOLDIER CROWN
40.	JACK SOLDIER COURSE
41.	WATER TABLE
42.	ATRIUM DOOR
43.	PILASTER - SEE ELEVATION FOR TYPE

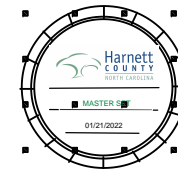

**NORTH CAROLINA
40' SERIES**

KB HOME
NORTH CAROLINA DIVISION

4506 S. MIAMI BLVD.
SUITE 180
DURHAM, NC 27703
TEL: (919) 768-7980
FAX: (919) 544-2928

**2018 NORTH
CAROLINA STATE
BUILDING
CODES**

ISSUE DATE: 01/08/15
PROJECT No.: 1350999:56
DIVISION MGR.: DCS
REVISIONS: 08/20/20

- 11 DIVISION REVISION NC19654NCP - 08/28/19 - FAE
- 12 DIVISION REVISION NC19657NCP - 09/26/19 - FAE
- 13 DIVISION REVISION NC20003NCP - 12/19/19 - CL
- 14 VENTILATION NC20008NCP - 01/17/20 - CL
- 15 DIVISION REVISION NC20013NCP - 02/10/20 - MCP
- 16 DIVISION REVISION NC20017NCP - 03/04/20 - KBA
- 17 HOME OFFICE CORP20009CORP-08/20/20-CTD

FOR INTERNAL USE ONLY	
REVIEWED BY:	
1.	
2.	
3.	
4.	
5.	
6.	

PLAN:
238.2338

SHEET:
3.B3

**SPEC. LEVEL 1
RALEIGH-DURHAM
40' SERIES**

These designs and drawings are CONFIDENTIAL, and the exclusive property of KB Home Corporation and are not to be disclosed without the express permission of KB Home Corporation. Copyright 2020 © KB Home Corporation, all rights reserved.

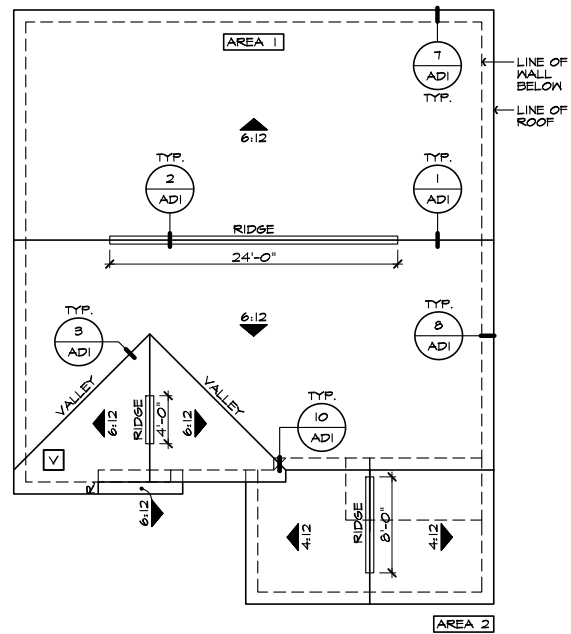

(PARTIAL ROOF PLAN 'B')
SCALE 1/8"=1'-0" (22'x34") - 1/16"=1'-0" (11'x17") AT OPTION PORCH

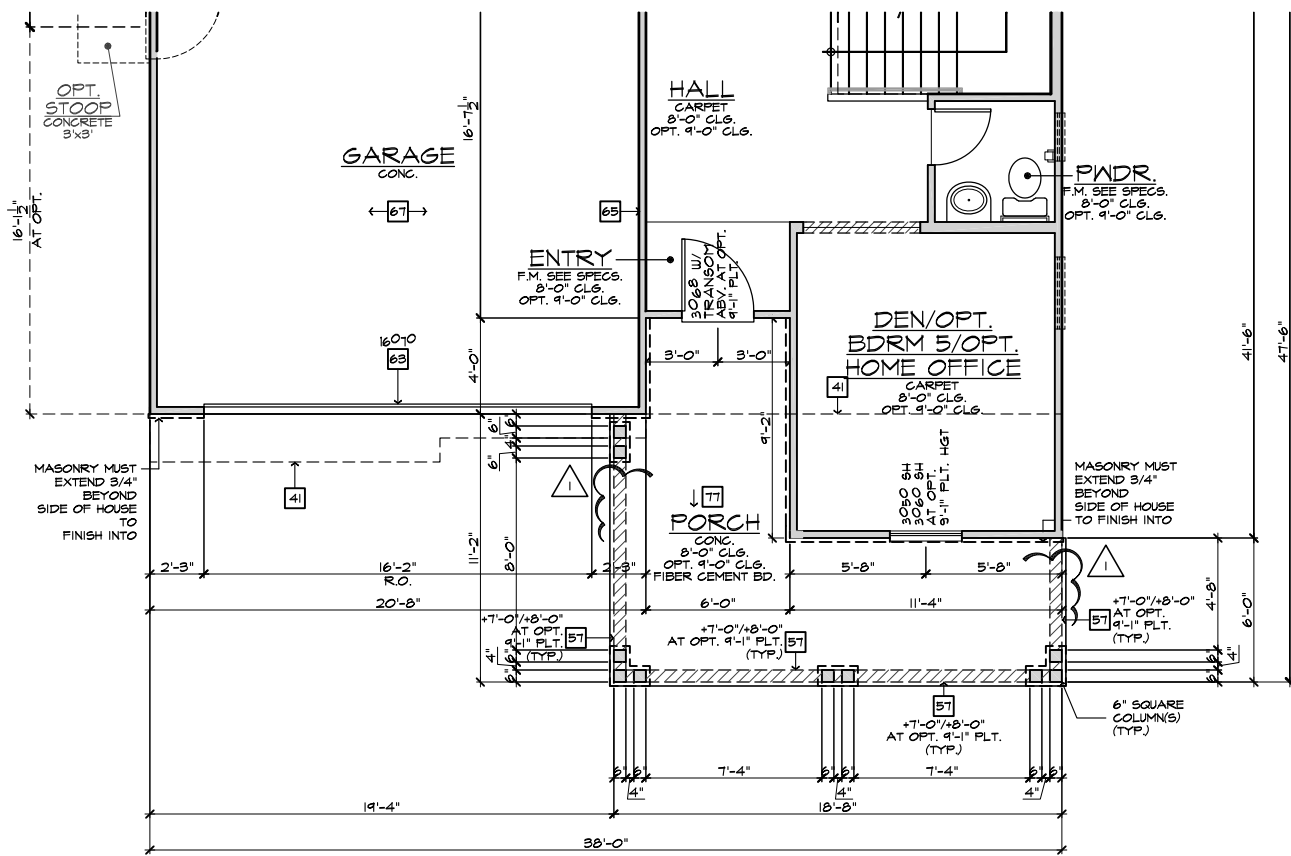

PARTIAL FIRST FLOOR PLAN 'B'
SCALE 1/4"=1'-0" (22'x34") - 1/8"=1'-0" (11'x17") AT OPT. PORCH

#	ELEVATION NOTES
NOTE: NOT ALL KEY NOTES APPLY.	
1.	ROOF MATERIAL - REFER TO ROOF NOTES
2.	2X FASCIA/BARGE BOARD WITH FASCIA CAP
3.	6:1. FLASHING
4.	6:1. FLASHING & SADDLE/CRICKET
5.	6:1. DRIP SCREED
6.	24"x24" CHIMNEY
7.	DECORATIVE VENT
8.	DECORATIVE CORBEL
9.	DECORATIVE SHUTTERS
10.	PEDIMENT. SEE ELEVATION FOR TYPE
11.	RECESSED ELEMENT
12.	DECORATIVE TRIM FYPON OR EQ. SEE ELEVATION FOR TYPE
13.	TRIM PER SPEC - SEE ELEVATION FOR SIZE
14.	SYNTHETIC MATERIAL
15.	PRE-MANUFACTURED DECORATIVE COLUMN (SIZE, SEE ELEV.) FYPON OR EQ. SURROUNDING STRUCTURAL POST.
16.	SITE-BUILT COLUMN - SEE ELEVATION FOR TYPE
17.	SHAKE SIDING
18.	STONE VENEER PER SPECS
19.	BRICK/MASONRY VENEER PER SPECS
20.	BUILT UP BRICK COLUMN
21.	SOLDIER COURSE
22.	ROWLOCK COURSE
23.	FRIEZE BOARD
24.	SIDING W/ 4" CORNER TRIM PER SPECS
25.	P.T. POST W/ WRAP - SEE STRUCTURAL FOR SIZE
26.	PRE-FAB DECORATIVE TRIM
27.	LIGHT WEIGHT PRECAST STONE TRIM
28.	P.T. LUMBER RAILINGS (36" U.N.O.)
29.	WRAP
30.	DECORATIVE WINDOW/DOOR TRIM - FYPON OR EQ. SEE ELEVATION FOR SIZE.
31.	BRACKET OR KICKER - FYPON OR EQ.
32.	ENTRY DOOR
33.	CONCRETE STOOP/ PORCH - SEE SLAB INTERFACE PLAN.
34.	SECTIONAL GARAGE DOOR PER SPECS
35.	ALUMINUM WRAP
36.	OPTIONAL DOOR/WINDOW - REFER TO PLAN OPTIONS
37.	OPTIONAL STANDING SEAM METAL ROOF
38.	KEYSTONE
39.	SOLDIER CROWN
40.	JACK SOLDIER COURSE
41.	WATER TABLE
42.	ATRIUM DOOR
43.	PILASTER - SEE ELEVATION FOR TYPE

#	PARTIAL PLAN NOTES
NOTE: NOT ALL KEY NOTES APPLY.	
27.	WATER HEATER LOCATION - FOR GAS - LOCATE ON 18" HIGH PLATFORM - FOR INTERIOR LOCATION - PROVIDE PAN & DRAIN (REFER TO DETAILS)
28.	WATER HEATER B VENT TO OUTSIDE AIR
29.	MAIN LINE SHUT-OFF VALVE AND TEMP. & PRESSURE RELIEF VALVE
34.	LINE OF WALL BELOW
41.	LINE OF FLOOR ABOVE
42.	LINE OF FLOOR BELOW
43.	36" HIGH GUARDRAIL (REFER TO DETAIL SHEETS)
50.	A/C PAD LOCATION
51.	LOW WALL - REFER TO PLAN FOR HEIGHT
52.	2x6 STUD WALL
54.	DBL. 2x4 WALL PER PLAN
55.	INTERIOR SHELF - REFER TO PLAN FOR HEIGHT
57.	FLAT SOFFIT
58.	ARCHED SOFFIT
60.	OPT. DOOR/WINDOW
61.	PRE-MANUFACTURED DECORATIVE COLUMN (SIZE, SEE ELEV.) FYPON OR EQ. SURROUNDING STRUCTURAL POST.
62.	BRICK / STONE VENEER - REFER TO ELEVATIONS
63.	SECTIONAL GARAGE DOOR PER SPECS
66.	3" DIAM. CONCRETE FILLED PIPE BOLLARD 36" HIGH WITH MIN. 12" EMBEDMENT INTO CONCRETE. (NOT REQUIRED AT ELECTRIC WATER HEATERS OR FOR APPLIANCES LOCATED OUT OF THE VEHICLE'S NORMAL TRAVEL PATH).
68.	P.T. POST W/ WRAP.
70.	EGRESS WINDOW
75.	WINDOW LEDGE. HEIGHT & WIDTH OF OPENING TO EXTEND 6" BEYOND WINDOW(S) ON ALL SIDES U.N.O.
76.	SITE-BUILT COLUMN - SEE ELEVATION FOR TYPE
77.	CONCRETE SLAB. SLOPE 1/4" PER FT. MIN. SEE PLAN FOR SIZE.

ROOF PLAN NOTES 'B'	
	INDICATES ROOF SLOPE AND DIRECTION, U.N.O.
4:12	
ROOF MATERIAL: COMPOSITION SHINGLE	
12" (INCHES) TYPICAL ROOF OVERHANGS AT RAKE, U.N.O.	
12" (INCHES) TYPICAL ROOF OVERHANGS AT EAVE, U.N.O.	
LOCATE EAVE/ RAFTER VENTS EQUALLY BALANCED AROUND HOUSE EXCEPT ABOVE SHEARWALL PANELS.	
ATTIC VENT CALCULATIONS	
PROVIDE 1 SQ. IN. OF VENTILATION PER 300 SQ. IN. OF ATTIC SPACE. PROVIDE THAT AT LEAST 50% & NO MORE THAN 80% OF THE REQ. VENTILATING AREA IS PROVIDED BY VENTILATORS LOCATED IN THE UPPER PORTION OF THE ATTIC. (HIGH VENTING) AT 3'-0" ABOVE EAVE VENT WITH THE BALANCE BEING PROVIDED BY EAVE VENTS. (LOW VENTING) (2018 N.C.R. 806.2)	
* CALCULATION BY 1/50. HIGH/LOW VENTING NOT REQUIRED.	
APPROXIMATE RIDGE VENT LOCATIONS SHOWN.	
ACTUAL LOCATIONS TO BE DETERMINED IN THE FIELD.	
AREA 1 / MAIN:	
VENTILATION REQUIRED:	SQ. FT. / 300 4.64 SQ. FT.
ATTIC AREA = 1407	X 144 = 675 SQ. IN.
	TOTAL HIGH & LOW = 675 SQ. IN.
	X 50% = 338 SQ. IN.
VENTILATION PROVIDED:	
HIGH	
24	LF RIDGE VENT(S) AT 18 SQ. IN. / LF. = 482 SQ. IN.
0	ROOF VENT(S) AT 50 SQ. IN. EA. = 0 SQ. IN.
	SUB-TOTAL HIGH VENTILATION: 482 SQ. IN.
LOW	
50	LF VENTILATED SOFFIT AT 6.9 SQ. IN. / LF. = 345 SQ. IN.
1	ROOF VENT(S) AT 50 SQ. IN. EA. = 50 SQ. IN.
	SUB-TOTAL LOW VENTILATION: 345 SQ. IN.
	TOTAL VENTILATION PROVIDED: 827 SQ. IN.
AREA 2 / OPTION PORCH:	
VENTILATION REQUIRED:	SQ. FT. / 300 0.64 SQ. FT.
ATTIC AREA = 207	X 144 = 91 SQ. IN.
	TOTAL HIGH & LOW = 91 SQ. IN.
VENTILATION PROVIDED:	
20	LF VENTILATED SOFFIT AT 6.9 SQ. IN. / LF. = 138 SQ. IN.
0	LF RIDGE VENT(S) AT 18 SQ. IN. EA. = 144 SQ. IN.

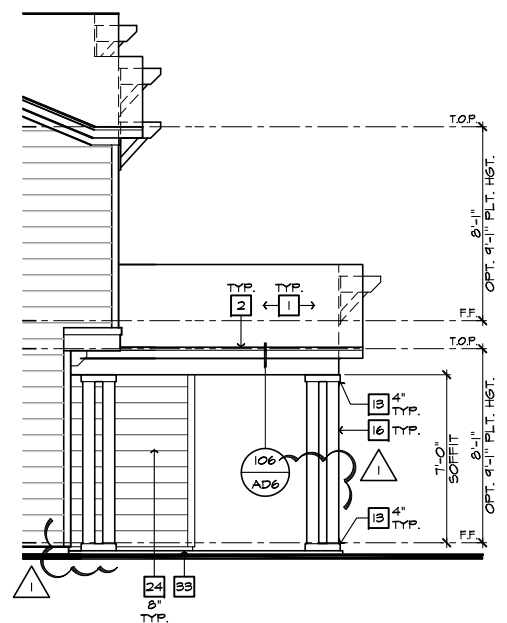

PARTIAL LEFT ELEVATION 'B' AT OPTIONAL PORCH
SCALE 1/4"=1'-0" (22'x34") - 1/8"=1'-0" (11'x17")



FRONT ELEVATION 'B' AT OPTIONAL PORCH
SCALE 1/4"=1'-0" (22'x34") - 1/8"=1'-0" (11'x17")



NORTH CAROLINA 40' SERIES

KB HOME
NORTH CAROLINA DIVISION
4506 S. MIAMI BLVD.
SUITE 180
DURHAM, NC 27703
TEL: (919) 768-7980
FAX: (919) 544-2928

2018 NORTH CAROLINA STATE BUILDING CODES

- ISSUE DATE: 01/08/15
- PROJECT No.: 1350999:56
- DIVISION MGR.: DCS
- REVISIONS: 08/20/20
- 11 DIVISION REVISION NC13654NCP - 08/28/19 - FAE
- 12 DIVISION REVISION NC13657NCP - 09/26/19 - FAE
- 13 DIVISION REVISION NC20003NCP - 12/19/19 - CL
- 14 VENTILATION NC20008NCP - 01/17/20 - CL
- 15 DIVISION REVISION NC20013NCP - 02/10/20 - MCP
- 16 DIVISION REVISION NC20017NCP - 03/04/20 - KBA
- 17 HOME OFFICE CORP21009CORP-08/20/20-CTD

FOR INTERNAL USE ONLY	
REVIEWED BY:	
1.	
2.	
3.	
4.	
5.	
6.	

PLAN: 238.2338
SHEET: 3.B4

SPEC. LEVEL 1 RALEIGH-DURHAM 40' SERIES

NOTE: REFER TO BASIC FLOOR PLAN FOR INFORMATION NOT SHOWN HERE

These designs and drawings are CONFIDENTIAL, and the exclusive property of KB Home Corporation and are not to be disclosed without the express permission of KB Home Corporation. Copyright 2020 © KB Home Corporation, all rights reserved.

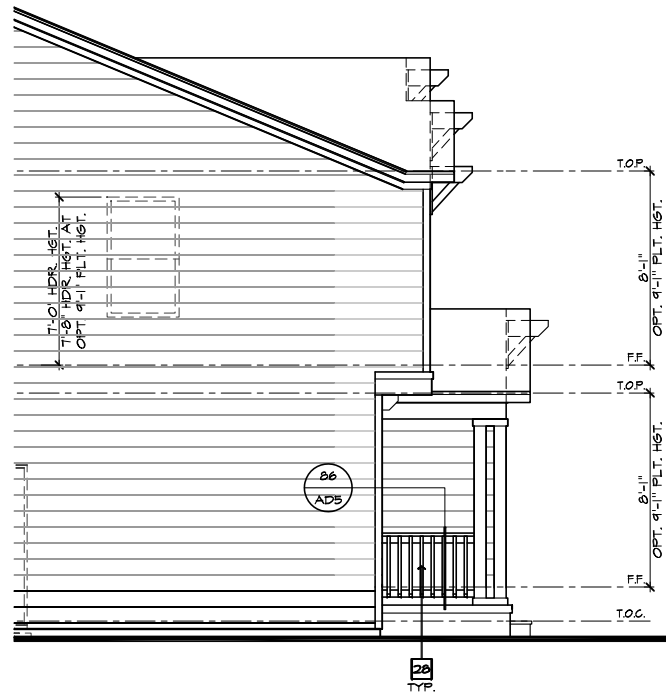

PARTIAL LEFT ELEVATION 'B' AT CRAWL SPACE
 SCALE 1/4"=1'-0" (22'X34') - 1/8"=1'-0" (11'X17')

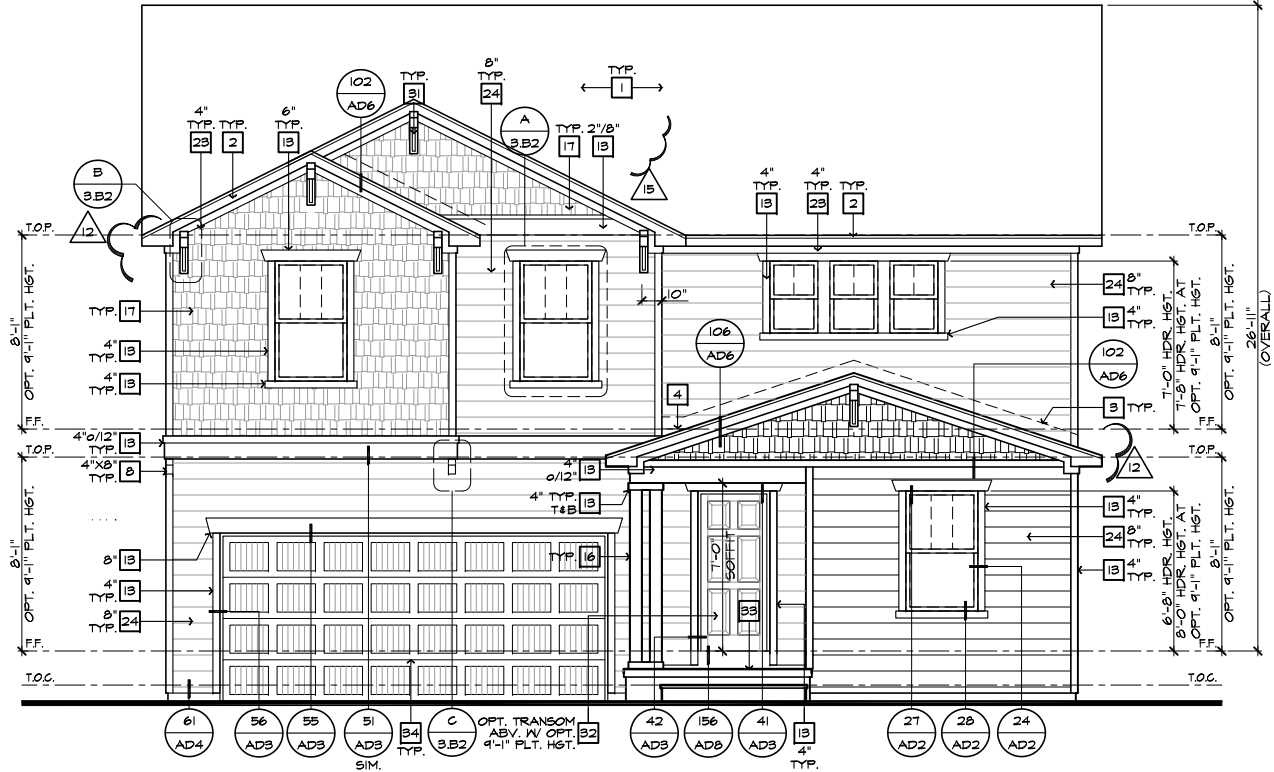

FRONT ELEVATION 'B' W/ CRAWL SPACE
 SCALE 1/4"=1'-0" (22'X34') - 1/8"=1'-0" (11'X17')

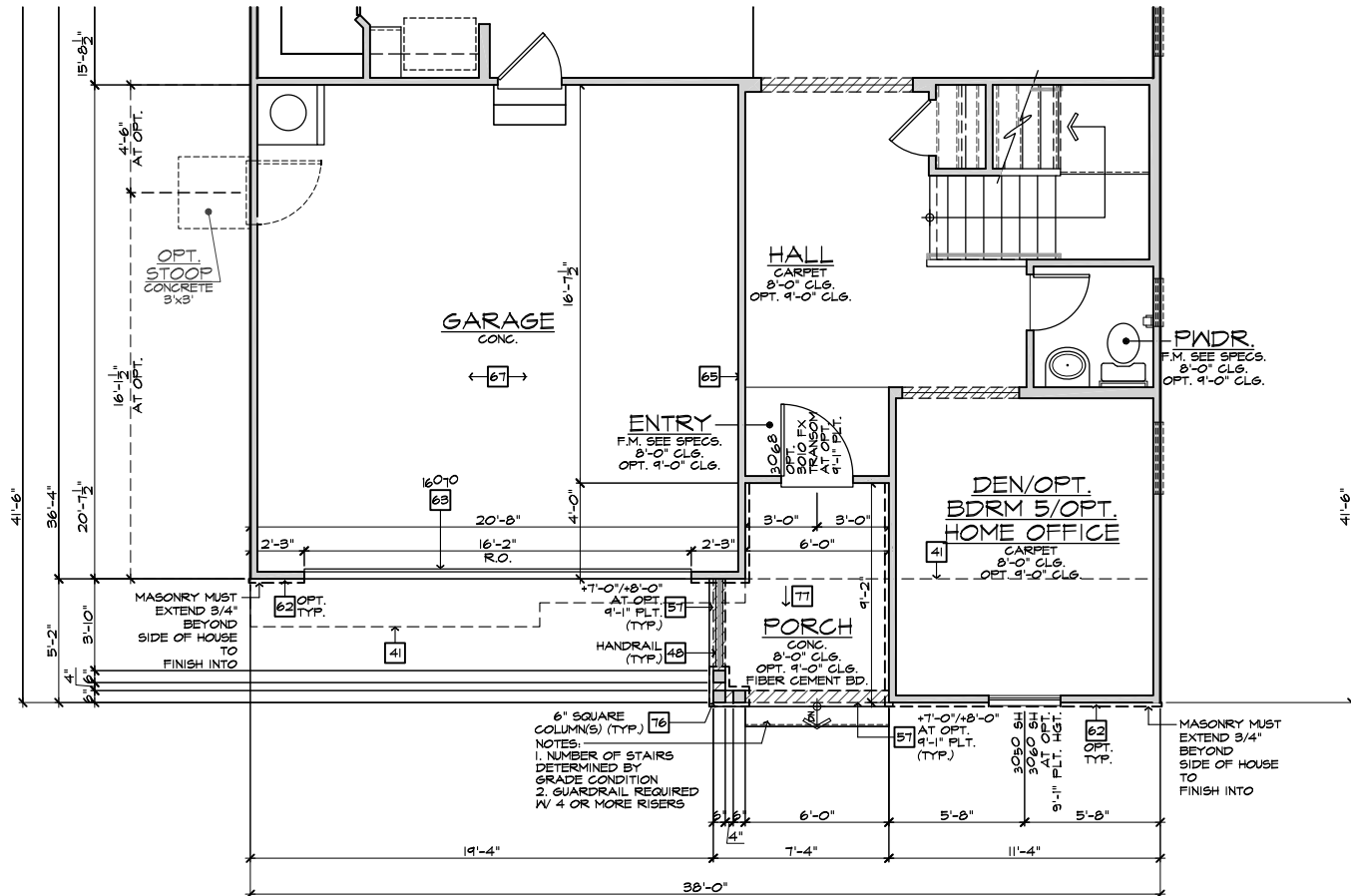

PARTIAL FIRST FLOOR PLAN 'B' AT CRAWL SPACE
 SCALE 1/4"=1'-0" (22'X34') - 1/8"=1'-0" (11'X17')

#	ELEVATION NOTES
NOTE: NOT ALL KEY NOTES APPLY.	
1.	ROOF MATERIAL - REFER TO ROOF NOTES
2.	2X FASCIA/BARGE BOARD WITH FASCIA CAP
3.	6.1. FLASHING
4.	6.1. FLASHING & SADDLE/CRICKET
5.	6.1. DRIP SCREED
6.	24"X24" CHIMNEY
7.	DECORATIVE VENT
8.	DECORATIVE CORBEL
9.	DECORATIVE SHUTTERS
10.	PEDIMENT. SEE ELEVATION FOR TYPE
11.	RECESSED ELEMENT
12.	DECORATIVE TRIM FYPON OR EQ. SEE ELEVATION FOR TYPE
13.	TRIM PER SPEC- SEE ELEVATION FOR SIZE
14.	SYNTHETIC MATERIAL
15.	PRE-MANUFACTURED DECORATIVE COLUMN (SIZE, SEE ELEV.) FYPON OR EQ. SURROUNDING STRUCTURAL POST.
16.	SITE-BUILT COLUMN - SEE ELEVATION FOR TYPE
17.	SHAKE SIDING
18.	STONE VENEER PER SPECS
19.	BRICK/MASONRY VENEER PER SPECS
20.	BUILT UP BRICK COLUMN
21.	SOLDIER COURSE
22.	RONLOCK COURSE
23.	FRIEZE BOARD
24.	SIDING 1/4" 4" CORNER TRIM PER SPECS
25.	P.T. POST 1/4" WRAP - SEE STRUCTURAL FOR SIZE
26.	PRE-FAB DECORATIVE TRIM
27.	LIGHT WEIGHT PRECAST STONE TRIM
28.	P.T. LUMBER RAILINGS (36" U.N.O.)
29.	WRAP
30.	DECORATIVE WINDOW/DOOR TRIM - FYPON OR EQ. SEE ELEVATION FOR SIZE.
31.	BRACKET OR KICKER - FYPON OR EQ.
32.	ENTRY DOOR
33.	CONCRETE STOOP/ PORCH - SEE SLAB INTERFACE PLAN.
34.	SECTIONAL GARAGE DOOR PER SPECS
35.	ALUMINUM WRAP
36.	OPTIONAL DOOR/WINDOW - REFER TO PLAN OPTIONS
37.	OPTIONAL STANDING SEAM METAL ROOF
38.	KEYSTONE
39.	SOLDIER CROWN
40.	JACK SOLDIER COURSE
41.	WATER TABLE
42.	ATRIUM DOOR
43.	PILASTER - SEE ELEVATION FOR TYPE

#	PARTIAL PLAN NOTES
NOTE: NOT ALL KEY NOTES APPLY.	
27.	WATER HEATER LOCATION - FOR GAS - LOCATE ON 18" HIGH PLATFORM - FOR INTERIOR LOCATION - PROVIDE PAN & DRAIN (REFER TO DETAILS)
28.	WATER HEATER B VENT TO OUTSIDE AIR
29.	MAIN LINE SHUT-OFF VALVE AND TEMP. & PRESSURE RELIEF VALVE
34.	LINE OF WALL BELOW
41.	LINE OF FLOOR ABOVE
42.	LINE OF FLOOR BELOW
43.	LINE 36" HIGH GUARDRAIL (REFER TO DETAIL SHEETS)
50.	A/C PAD LOCATION
51.	LOW WALL - REFER TO PLAN FOR HEIGHT
52.	2x6 STUD WALL
54.	DEL. 2x4 WALL PER PLAN
55.	INTERIOR SHELF - REFER TO PLAN FOR HEIGHT
57.	FLAT SOFFIT
58.	ARCHED SOFFIT
60.	OPT. DOOR / WINDOW
61.	PRE-MANUFACTURED DECORATIVE COLUMN (SIZE, SEE ELEV.) FYPON OR EQ. SURROUNDING STRUCTURAL POST.
62.	BRICK / STONE VENEER - REFER TO ELEVATIONS
63.	SECTIONAL GARAGE DOOR PER SPECS
66.	3" DIAM. CONCRETE FILLED PIPE BOLLARD 36" HIGH WITH MIN. 12" EMBEDMENT INTO CONCRETE. (NOT REQUIRED AT ELECTRIC WATER HEATERS OR FOR APPLIANCES LOCATED OUT OF THE VEHICLE'S NORMAL TRAVEL PATH.)
68.	P.T. POST 1/4" WRAP TO EGRESS WINDOW
75.	WINDOW LEDGE. HEIGHT & WIDTH OF OPENING TO EXTEND 6" BEYOND WINDOW(S) ON ALL SIDES U.N.O.
76.	SITE-BUILT COLUMN - SEE ELEVATION FOR TYPE
77.	CONCRETE SLAB. SLOPE 1/4" PER FT. MIN. SEE PLAN FOR SIZE



NORTH CAROLINA 40' SERIES

KB HOME
 NORTH CAROLINA DIVISION
 4506 S. MIAMI BLVD.
 SUITE 180
 DURHAM, NC 27703
 TEL: (919) 768-7980
 FAX: (919) 544-2928

2018 NORTH CAROLINA STATE BUILDING CODES

- ISSUE DATE: 01/08/15
- PROJECT No.: 1350999:56
- DIVISION MGR.: DCS
- REVISIONS: 08/20/20
- 11 DIVISION REVISION NC19654NCP - 08/28/19 - FAB
- 12 DIVISION REVISION NC19657NCP - 09/26/19 - FAB
- 13 DIVISION REVISION NC20003NCP - 12/19/19 - CL
- 14 VENTILATION NC20008NCP - 01/17/20 - CL
- 15 DIVISION REVISION NC20013NCP - 02/10/20 - MCP
- 16 DIVISION REVISION NC20017NCP - 03/04/20 - KBA
- 17 HOME OFFICE CORP20009CORP-08/20/20-CTD

FOR INTERNAL USE ONLY	
REVIEWED BY:	
1.	
2.	
3.	
4.	
5.	
6.	

PLAN: 238.2338
 SHEET: 3.B5

SPEC. LEVEL 1 RALEIGH-DURHAM 40' SERIES

NOTE: REFER TO BASIC ELEVATIONS FOR INFORMATION NOT SHOWN HERE

NOTE: REFER TO BASIC FLOOR PLAN FOR INFORMATION NOT SHOWN HERE

These designs and drawings are CONFIDENTIAL, and the exclusive property of KB Home Corporation, and are not to be disclosed without the express permission of KB Home Corporation. Copyright 2020 © KB Home Corporation, all rights reserved.

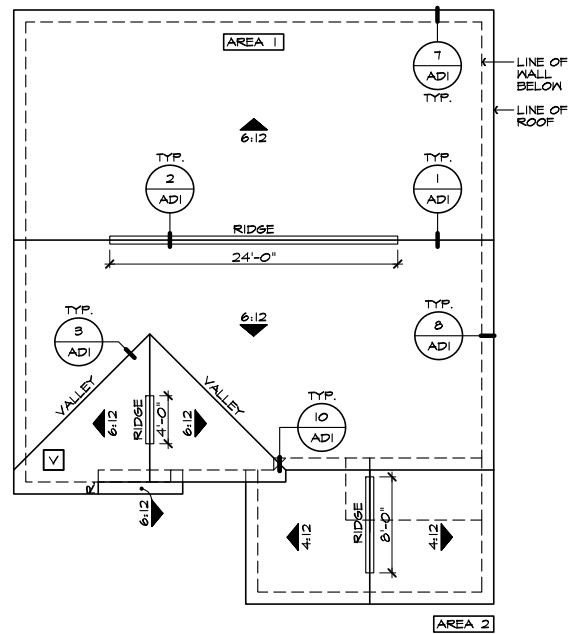

PARTIAL ROOF PLAN 'B'
SCALE 1/8"=1'-0" (22"x34") - 1/16"=1'-0" (11"x17") AT OPTION PORCH W/ CRAWL SPACE

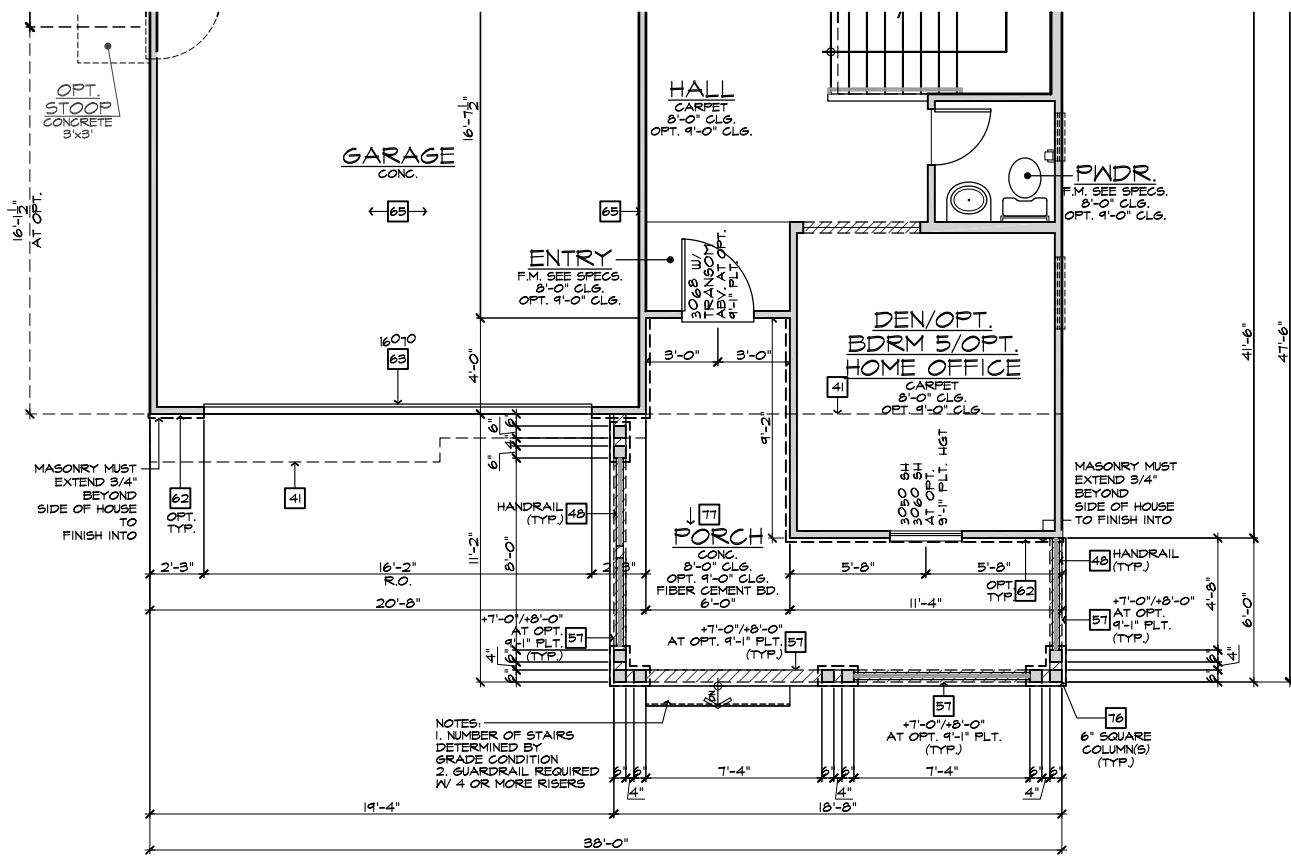

PARTIAL FIRST FLOOR PLAN 'B'
SCALE 1/4"=1'-0" (22"x34") - 1/8"=1'-0" (11"x17") AT OPT. PORCH W/ CRAWL SPACE

#	ELEVATION NOTES
NOTE: NOT ALL KEY NOTES APPLY.	
1.	ROOF MATERIAL - REFER TO ROOF NOTES
2.	2X FASCIA/BARGE BOARD WITH FASCIA CAP
3.	6.1. FLASHING
4.	6.1. FLASHING & SADDLE/CRICKET
5.	6.1. DRIP SCREED
6.	24"x24" CHIMNEY
7.	DECORATIVE VENT
8.	DECORATIVE CORBEL
9.	DECORATIVE SHUTTERS
10.	PEDIMENT. SEE ELEVATION FOR TYPE
11.	RECESSED ELEMENT
12.	DECORATIVE TRIM FYPON OR EQ. SEE ELEVATION FOR TYPE
13.	TRIM PER SPEC- SEE ELEVATION FOR SIZE
14.	SYNTHETIC MATERIAL
15.	PRE-MANUFACTURED DECORATIVE COLUMN (SIZE, SEE ELEV.) FYPON OR EQ. SURROUNDING STRUCTURAL POST.
16.	SITE-BUILT COLUMN - SEE ELEVATION FOR TYPE
17.	SHAKE SIDING
18.	STONE VENEER PER SPECS
19.	BRICK/MASONRY VENEER PER SPECS
20.	BUILT UP BRICK COLUMN
21.	SOLDIER COURSE
22.	ROWLOCK COURSE
23.	FRIEZE BOARD
24.	SIDING W/ 4" CORNER TRIM PER SPECS
25.	P.T. POST W/ WRAP - SEE STRUCTURAL FOR SIZE
26.	PRE-FAB DECORATIVE TRIM
27.	LIGHT WEIGHT PRECAST STONE TRIM
28.	P.T. LUMBER RAILINGS (36" U.N.O.)
29.	WRAP
30.	DECORATIVE WINDOW/DOOR TRIM - FYPON OR EQ. SEE ELEVATION FOR SIZE
31.	BRACKET OR KICKER - FYPON OR EQ.
32.	ENTRY DOOR
33.	CONCRETE STOOP/ PORCH - SEE SLAB INTERFACE PLAN.
34.	SECTIONAL GARAGE DOOR PER SPECS
35.	ALUMINUM WRAP
36.	OPTIONAL DOOR/WINDOW - REFER TO PLAN OPTIONS
37.	OPTIONAL STANDING SEAM METAL ROOF
38.	KEYSTONE
39.	SOLDIER CROWN
40.	JACK SOLDIER COURSE
41.	WATER TABLE
42.	ATRIUM DOOR
43.	PILASTER - SEE ELEVATION FOR TYPE

#	PARTIAL PLAN NOTES
NOTE: NOT ALL KEY NOTES APPLY.	
21.	WATER HEATER LOCATION - FOR GAS - LOCATE ON 18" HIGH PLATFORM - FOR INTERIOR LOCATION - PROVIDE PAN & DRAIN (REFER TO DETAILS)
28.	WATER HEATER 3" VENT TO OUTSIDE AIR
29.	MAIN LINE SHUT-OFF VALVE AND TEMP. & PRESSURE RELIEF VALVE
34.	LINE OF WALL BELOW
41.	LINE OF FLOOR ABOVE
42.	LINE OF FLOOR BELOW
48.	LINE 36" HIGH GUARDRAIL (REFER TO DETAIL SHEETS)
50.	A/C PAD LOCATION
51.	LOW WALL - REFER TO PLAN FOR HEIGHT
52.	2x6 STUD WALL
54.	DBL. 2x4 WALL PER PLAN
55.	INTERIOR SHELF - REFER TO PLAN FOR HEIGHT
57.	FLAT SOFFIT
58.	ARCHED SOFFIT
60.	OPT. DOOR/WINDOW
61.	PRE-MANUFACTURED DECORATIVE COLUMN (SIZE, SEE ELEV.) FYPON OR EQ. SURROUNDING STRUCTURAL POST.
62.	BRICK / STONE VENEER - REFER TO ELEVATIONS
63.	SECTIONAL GARAGE DOOR PER SPECS
66.	3" DIAM. CONCRETE FILLED PIPE BOLLARD 36" HIGH WITH MIN. 12" EMBEDMENT INTO CONCRETE. (NOT REQUIRED AT ELECTRIC WATER HEATERS OR FOR APPLIANCES LOCATED OUT OF THE VEHICLE'S NORMAL TRAVEL PATH)
68.	P.T. POST W/ WRAP.
75.	EGRESS WINDOW
76.	WINDOW LEDGE. HEIGHT & WIDTH OF OPENING TO EXTEND 6" BEYOND WINDOW(S) ON ALL SIDES U.N.O.
77.	SITE-BUILT COLUMN - SEE ELEVATION FOR TYPE
77.	CONCRETE SLAB. SLOPE 1/4" PER FT. MIN. SEE PLAN FOR SIZE

ROOF PLAN NOTES 'B'	
	INDICATES ROOF SLOPE AND DIRECTION, U.N.O.
4:12	
ROOF MATERIAL: COMPOSITION SHINGLE	
12" (INCHES) TYPICAL ROOF OVERHANGS AT RAKE, U.N.O.	
12" (INCHES) TYPICAL ROOF OVERHANGS AT EAVE, U.N.O.	
LOCATE EAVE/ RAFTER VENTS EQUALLY BALANCED AROUND HOUSE EXCEPT ABOVE SHEARWALL PANELS.	
ATTIC VENT CALCULATIONS	
PROVIDE 1 SQ. IN. OF VENTILATION PER 300 SQ. IN. OF ATTIC SPACE. PROVIDE THAT AT LEAST 50% & NO MORE THAN 80% OF THE REQ. VENTILATING AREA IS PROVIDED BY VENTILATORS LOCATED IN THE UPPER PORTION OF THE ATTIC (HIGH VENTING) LOCATED IN THE UPPER PORTION OF THE ATTIC (HIGH VENTING) AT 3'-0" ABOVE EAVE VENT WITH THE BALANCE BEING PROVIDED BY EAVE VENTS (LOW VENTING) (2018 N.C.R. 806.2)	
* CALCULATION BY 1/150, HIGH/LOW VENTING NOT REQUIRED.	
APPROXIMATE RIDGE VENT LOCATIONS SHOWN.	
ACTUAL LOCATIONS TO BE DETERMINED IN THE FIELD.	
AREA 1 / MAIN:	
VENTILATION REQUIRED:	SQ. FT. / 300 4.64 SQ. FT.
ATTIC AREA = 1407	X 144 = 675 SQ. IN.
TOTAL HIGH & LOW:	675 SQ. IN.
X 50% =	338 SQ. IN.
VENTILATION PROVIDED:	
HIGH	
24	LF RIDGE VENT(S) AT 10 SQ. IN. / LF. = 482 SQ. IN.
0	ROOF VENT(S) AT 50 SQ. IN. EA. = 0 SQ. IN.
SUB-TOTAL HIGH VENTILATION:	482 SQ. IN.
LOW	
50	LF VENTILATED SOFFIT AT 6.9 SQ. IN. / LF. = 345 SQ. IN.
1	ROOF VENT(S) AT 50 SQ. IN. EA. = 50 SQ. IN.
SUB-TOTAL LOW VENTILATION:	345 SQ. IN.
TOTAL VENTILATION PROVIDED:	827 SQ. IN.
AREA 2 / OPTION PORCH:	
VENTILATION REQUIRED:	SQ. FT. / 300 0.64 SQ. FT.
ATTIC AREA = 207	X 144 = 99 SQ. IN.
TOTAL HIGH & LOW:	99 SQ. IN.
VENTILATION PROVIDED:	
20	LF VENTILATED SOFFIT AT 6.9 SQ. IN. / LF. = 138 SQ. IN.
0	LF RIDGE VENT(S) AT 10 SQ. IN. EA. = 144 SQ. IN.
TOTAL VENTILATION PROVIDED:	282 SQ. IN.
NOTES:	
ALL VENT OPENINGS SHALL BE COVERED WITH 1/4" CORROSION RESISTANT METAL MESH.	
FRAMER SHALL BE RESPONSIBLE FOR COORDINATING WITH TRUSS MANUFACTURER TO ACCOMMODATE ALL ATTIC VENTS.	
ALL VENTS SHALL BE INSTALLED SO AS TO MAKE THEM WATER-PROOF & WALL MOUNTED LOWERS SHALL BE SEALED & FLASHED W/ "MOISTOP" IN THE SAME MANNER PRESCRIBED FOR WINDOW INSTALLATION.	
PROVIDE APPROVED INSULATION DAMS (BAFFLES) WHERE VENT BLOCKS ARE USED BETWEEN ROOF FRAMING MEMBERS TO PREVENT VENT HOLES FROM BEING BLOCKED BY INSULATION.	
LOCATE HIGH VENTING MINIMUM 3'-0" VERTICAL DISTANCE ABOVE EAVES.	
WHEN GABLE END TRUSS MEMBERS BLOCK GABLE END VENTS, PROVIDE ADEQUATE ADDITIONAL VENTILATION BY MEANS OF ROOF TILE VENTS.	

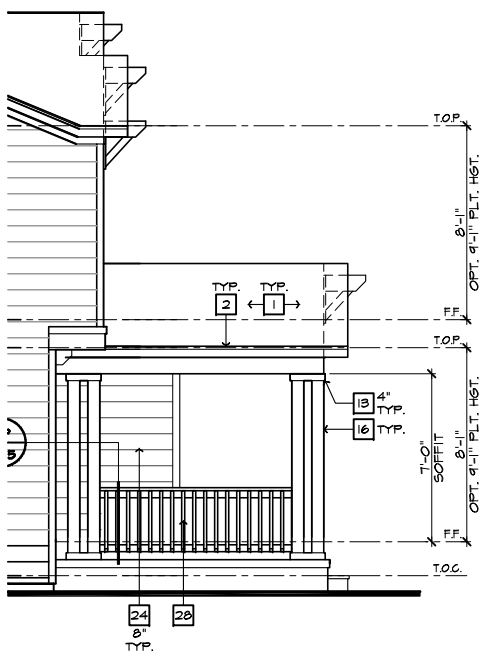

PARTIAL LEFT ELEVATION 'B'
AT OPTIONAL PORCH W/ CRAWL SPACE
SCALE 1/4"=1'-0" (22"x34") - 1/8"=1'-0" (11"x17")

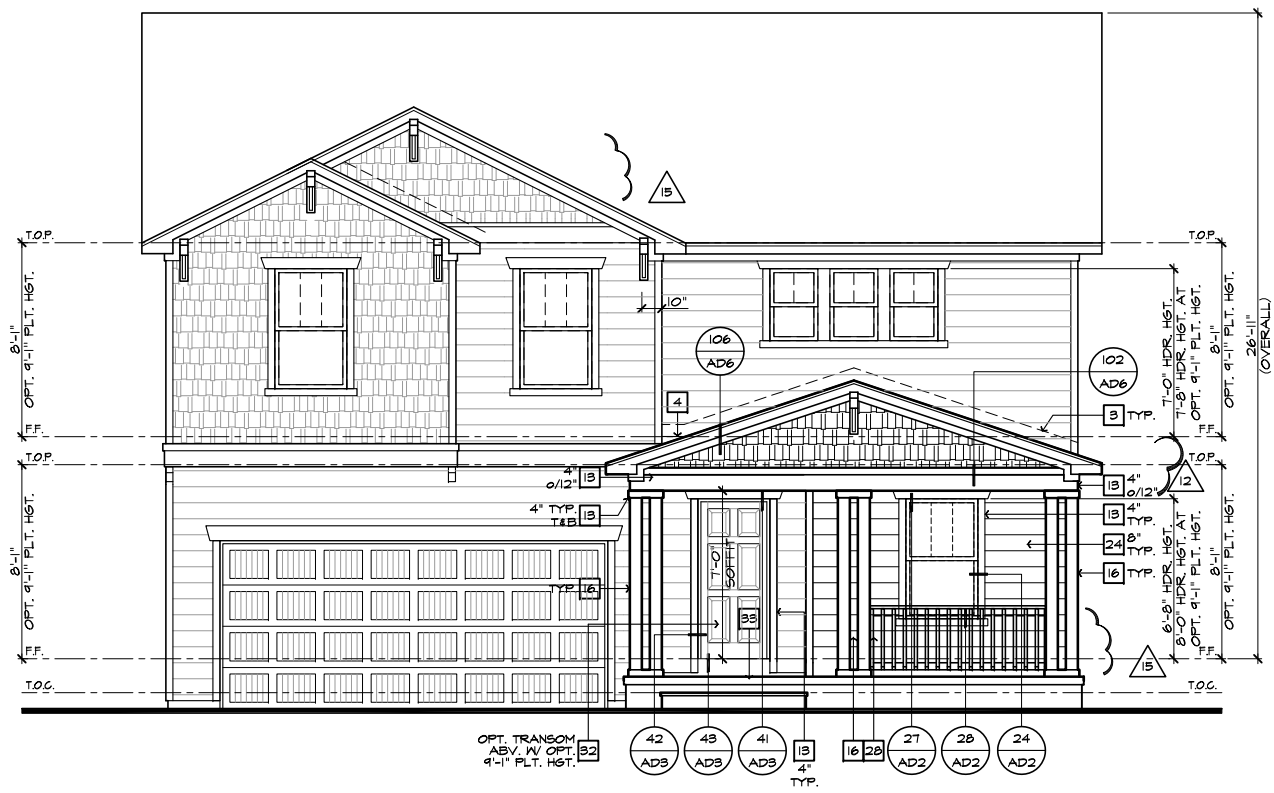

FRONT ELEVATION 'B'
AT OPTIONAL PORCH W/ CRAWL SPACE
SCALE 1/4"=1'-0" (22"x34") - 1/8"=1'-0" (11"x17")



NORTH CAROLINA 40' SERIES

KB HOME
NORTH CAROLINA DIVISION
4506 S. MIAMI BLVD.
SUITE 180
DURHAM, NC 27703
TEL: (919) 768-7980
FAX: (919) 544-2928

2018 NORTH CAROLINA STATE BUILDING CODES

- ISSUE DATE: 01/08/15
- PROJECT No.: 1350999:56
- DIVISION MGR.: DCS
- REVISIONS: 08/20/20
- 11 DIVISION REVISION NC13654NCP - 08/28/19 - FAE
- 12 DIVISION REVISION NC13657NCP - 09/26/19 - FAE
- 13 DIVISION REVISION NC20003NCP - 12/19/19 - CL
- 14 VENTILATION NC20004NCP - 01/17/20 - CL
- 15 DIVISION REVISION NC20013NCP - 02/10/20 - MCP
- 16 DIVISION REVISION NC20017NCP - 03/04/20 - KBA
- 17 HOME OFFICE CORP20095CORP-08/20/20-CTD

FOR INTERNAL USE ONLY	
REVIEWED BY:	
1.	
2.	
3.	
4.	
5.	
6.	

PLAN: 238.2338
SHEET: 3.B6

SPEC. LEVEL 1 RALEIGH-DURHAM 40' SERIES

NOTE: REFER TO BASIC FLOOR PLAN FOR INFORMATION NOT SHOWN HERE

These designs and drawings are CONFIDENTIAL, and the exclusive property of KB Home Corporation and are not to be disclosed without the express permission of KB Home Corporation. Copyright 2020 © KB Home Corporation, all rights reserved.

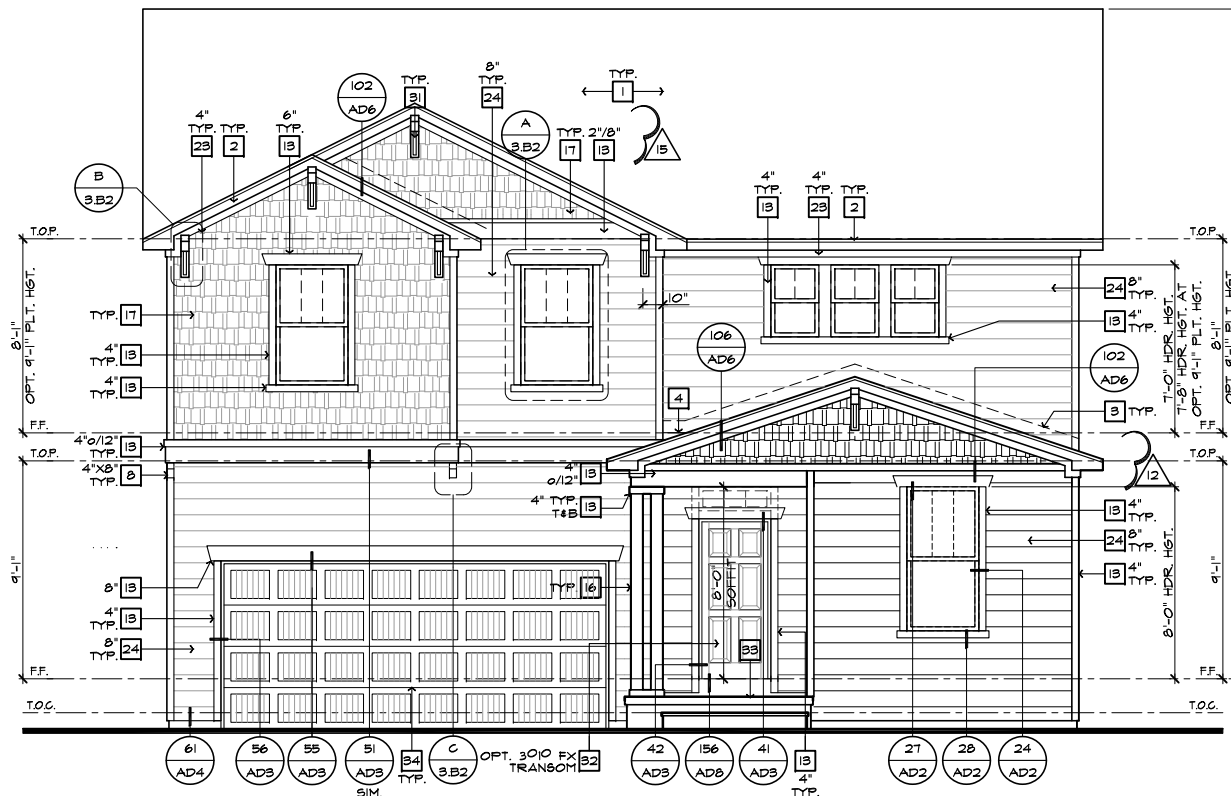

FRONT ELEVATION 'B' W/ CRAWL SPACE AT OPTIONAL 9'-1" PLT. HGT.

SCALE 1/4"=1'-0" (22'X34') - 1/8"=1'-0" (11'X17')

#	ELEVATION NOTES
NOTE: NOT ALL KEY NOTES APPLY.	
1.	ROOF MATERIAL - REFER TO ROOF NOTES
2.	2X FASCIA/BARGE BOARD WITH FASCIA CAP
3.	6.1. FLASHING
4.	6.1. FLASHING & SADDLE/CRICKET
5.	6.1. DRIP SCREED
6.	24"X24" CHIMNEY
7.	DECORATIVE VENT
8.	DECORATIVE CORBEL
9.	DECORATIVE SHUTTERS
10.	PEDIMENT. SEE ELEVATION FOR TYPE
11.	RECESSED ELEMENT
12.	DECORATIVE TRIM FYPON OR EQ. SEE ELEVATION FOR TYPE
13.	TRIM PER SPEC- SEE ELEVATION FOR SIZE
14.	SYNTHETIC MATERIAL
15.	PRE-MANUFACTURED DECORATIVE COLUMN (SIZE, SEE ELEV.) FYPON OR EQ. SURROUNDING STRUCTURAL POST.
16.	SITE-BUILT COLUMN - SEE ELEVATION FOR TYPE
17.	SHAKE SIDING
18.	STONE VENEER PER SPECS
19.	BRICK/MASONRY VENEER PER SPECS
20.	BUILT UP BRICK COLUMN
21.	SOLDIER COURSE
22.	ROWLOCK COURSE
23.	FRIEZE BOARD
24.	SIDING W/ 4" CORNER TRIM PER SPECS
25.	P.T. POST W/ WRAP - SEE STRUCTURAL FOR SIZE
26.	PRE-FAB DECORATIVE TRIM
27.	LIGHT WEIGHT PRECAST STONE TRIM
28.	P.T. LUMBER RAILINGS (+36" U.N.O.)
29.	WRAP
30.	DECORATIVE WINDOW/DOOR TRIM - FYPON OR EQ. SEE ELEVATION FOR SIZE.
31.	BRACKET OR KICKER - FYPON OR EQ.
32.	ENTRY DOOR
33.	CONCRETE STOOP/ PORCH - SEE SLAB INTERFACE PLAN.
34.	SECTIONAL GARAGE DOOR PER SPECS
35.	ALUMINUM WRAP
36.	OPTIONAL DOOR/WINDOW - REFER TO PLAN OPTIONS
37.	OPTIONAL STANDING SEAM METAL ROOF
38.	KEYSTONE
39.	SOLDIER CROWN
40.	JACK SOLDIER COURSE
41.	WATER TABLE
42.	ATRIUM DOOR
43.	PILASTER - SEE ELEVATION FOR TYPE
9'-1" PLATE OPTION	
NOTE: WINDOW SIZES WILL INCREASE BY 1" AT 9'-1" PLATE OPTIONS. HEADER HEIGHTS FOR ALL WINDOWS WILL BE 7'-8" AT 9'-1" PLATE OPTIONS.	

NORTH CAROLINA 40' SERIES

KB HOME
NORTH CAROLINA DIVISION
4506 S. MIAMI BLVD.
SUITE 180
DURHAM, NC 27703
TEL: (919) 768-7980
FAX: (919) 544-2928

2018 NORTH CAROLINA STATE BUILDING CODES

- ISSUE DATE: 01/08/15
- PROJECT No.: 1350999:56
- DIVISION MGR.: DCS
- REVISIONS: 08/20/20
- 11 DIVISION REVISION NC19654NCP - 08/28/19 - FAE
- 12 DIVISION REVISION NC19657NCP - 09/26/19 - FAE
- 13 DIVISION REVISION NC20003NCP - 12/19/19 - CL
- 14 VENTILATION NC20004NCP - 01/17/20 - CL
- 15 DIVISION REVISION NC20013NCP - 02/10/20 - MCP
- 16 DIVISION REVISION NC20017NCP - 03/04/20 - KBA
- 17 HOME OFFICE CORP20009CORP-08/20/20-CTD

FOR INTERNAL USE ONLY	
REVIEWED BY:	
1.	
2.	
3.	
4.	
5.	
6.	

PLAN: **238.2338**
SHEET: **3.B7**

SPEC. LEVEL 1 RALEIGH-DURHAM 40' SERIES

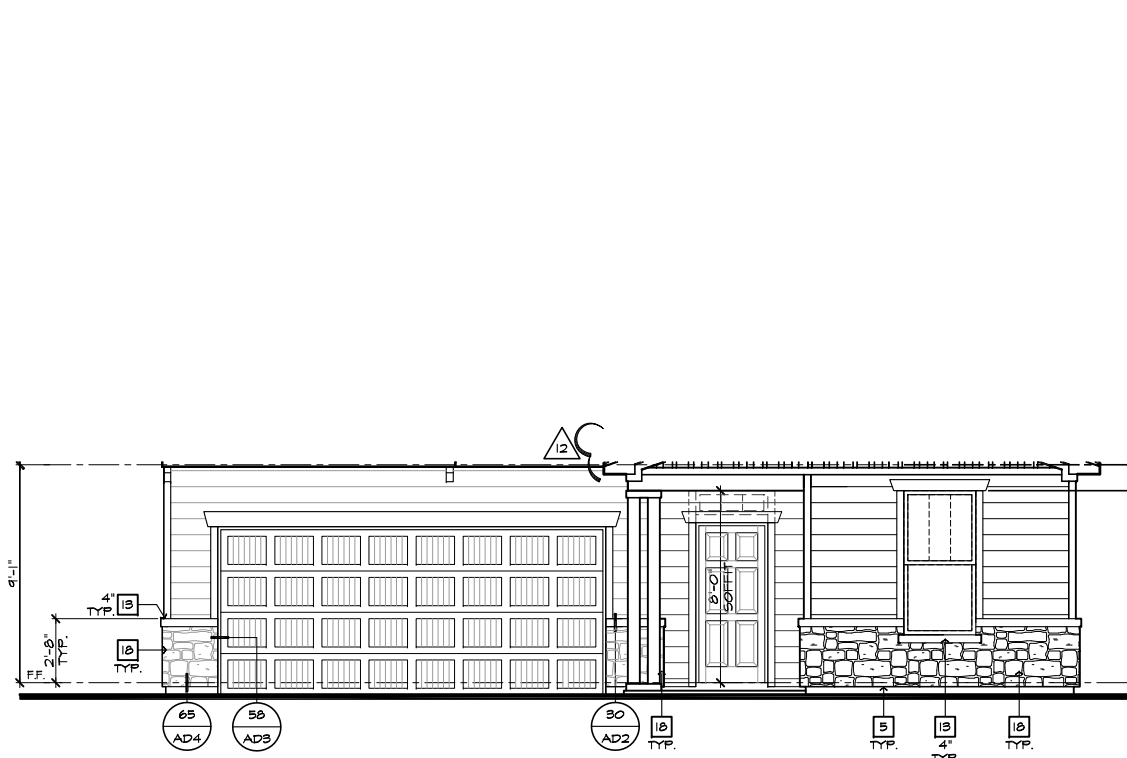

PARTIAL FRONT ELEVATION 'B' AT OPTIONAL 9'-1" PLT. HGT. W/ STONE OPT.

SCALE 1/4"=1'-0" (22'X34') - 1/8"=1'-0" (11'X17')

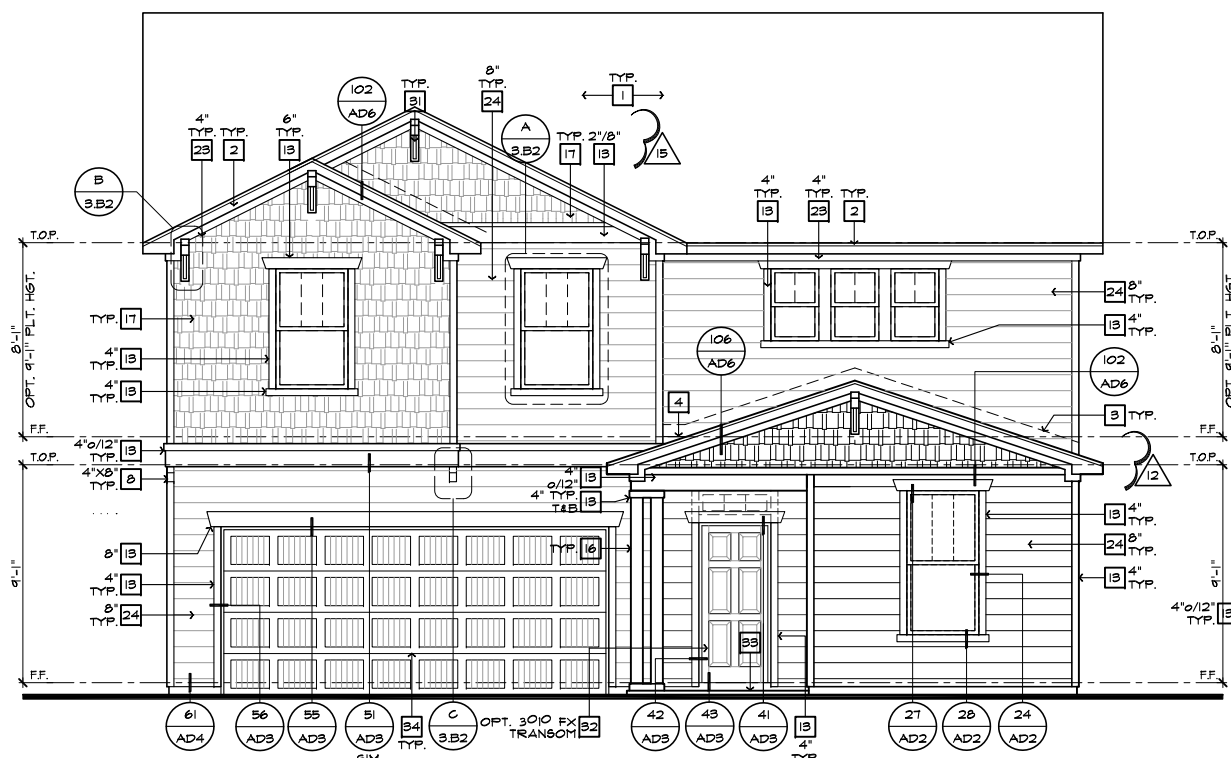

FRONT ELEVATION 'B' AT OPTIONAL 9'-1" PLT. HGT.

SCALE 1/4"=1'-0" (22'X34') - 1/8"=1'-0" (11'X17')

These designs and drawings are CONFIDENTIAL, and the exclusive property of KB Home Corporation, and are not to be disclosed without the express permission of KB Home Corporation. Copyright 2020 © KB Home Corporation, all rights reserved.

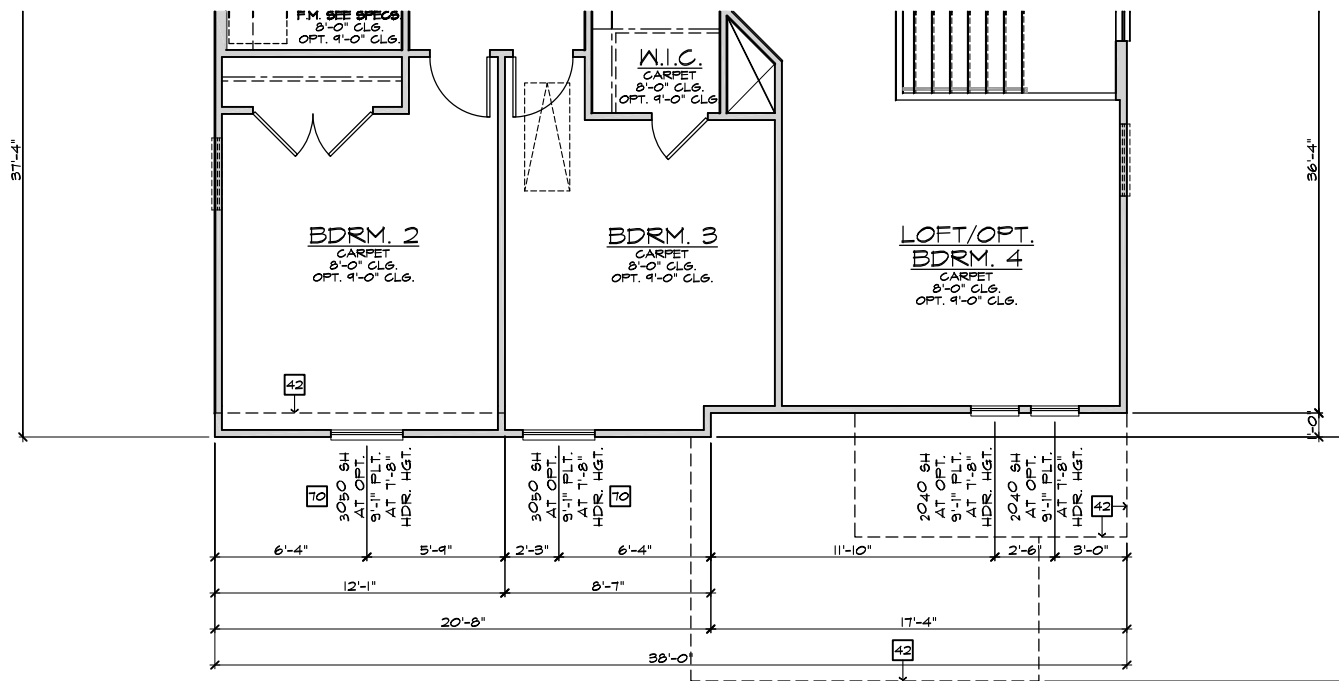

PARTIAL SECOND FLOOR PLAN 'C'

SCALE 1/4"=1'-0" (22'x34") - 1/8"=1'-0" (11'x17")

BASIC PLAN

#	PARTIAL PLAN NOTES
NOTE: NOT ALL KEY NOTES APPLY.	
27.	WATER HEATER LOCATION - FOR GAS - LOCATE ON 18" HIGH PLATFORM - FOR INTERIOR LOCATION - PROVIDE PAN & DRAIN (REFER TO DETAILS)
28.	WATER HEATER B VENT TO OUTSIDE AIR
29.	MAIN LINE SHUT-OFF VALVE AND TEMP. & PRESSURE RELIEF VALVE
34.	LINE OF WALL BELOW
41.	LINE OF FLOOR ABOVE
42.	LINE OF FLOOR BELOW
43.	MIN. 36" HIGH GUARDRAIL (REFER TO DETAIL SHEETS)
50.	A/C PAD LOCATION
51.	LOW WALL - REFER TO PLAN FOR HEIGHT
52.	2x6 STUD WALL
54.	DBL. 2x4 WALL PER PLAN
55.	INTERIOR SHELF - REFER TO PLAN FOR HEIGHT
57.	FLAT SOFFIT
58.	ARCHED SOFFIT
60.	OPT. DOOR/WINDOW
61.	PRE-MANUFACTURED DECORATIVE COLUMN (SIZE, SEE ELEV.)
62.	BRICK / STONE VENEER - REFER TO ELEVATIONS
63.	SECTIONAL GARAGE DOOR PER SPECS
66.	3" DIAM. CONCRETE FILLED PIPE BOLLARD 36" HIGH WITH MIN. 12" EMBEDMENT INTO CONCRETE (NOT REQUIRED AT ELECTRIC WATER HEATERS OR FOR APPLIANCES LOCATED OUT OF THE VEHICLE'S NORMAL TRAVEL PATH)
68.	P.T. POST IV WRAP
70.	EGRESS WINDOW
75.	WINDOW LEDGE - HEIGHT & WIDTH OF OPENING TO EXTEND 6" BEYOND WINDOW(S) ON ALL SIDES UNO.
76.	SITE-BUILT COLUMN - SEE ELEVATION FOR TYPE
77.	CONCRETE SLAB - SLOPE 1/4" PER FT. MIN. SEE PLAN FOR SLOPE

NORTH CAROLINA
40' SERIES

KB HOME
NORTH CAROLINA DIVISION

4506 S. MIAMI BLVD.
SUITE 180
DURHAM, NC 27703
TEL: (919) 768-7980
FAX: (919) 544-2928

2018 NORTH
CAROLINA STATE
BUILDING
CODES

ISSUE DATE: 01/08/15
PROJECT No.: 1350999:56
DIVISION MGR.: DCS
REVISIONS: 08/20/20

- 11 DIVISION REVISION NC19654NCP - 08/28/19 - FAE
- 12 DIVISION REVISION NC19657NCP - 09/26/19 - FAE
- 13 DIVISION REVISION NC20003NCP - 12/19/19 - CL
- 14 VENTILATION NC20008NCP - 01/17/20 - CL
- 15 DIVISION REVISION NC20013NCP - 02/10/20 - MCP
- 16 DIVISION REVISION NC20017NCP - 03/04/20 - KBA
- 17 HOME OFFICE CORP20009CORP-08/20/20-CTD

FOR INTERNAL USE ONLY	
REVIEWED BY:	
1.	
2.	
3.	
4.	
5.	
6.	

PLAN:
238.2338
SHEET:
3.C1

SPEC. LEVEL 1
RALEIGH-DURHAM
40' SERIES

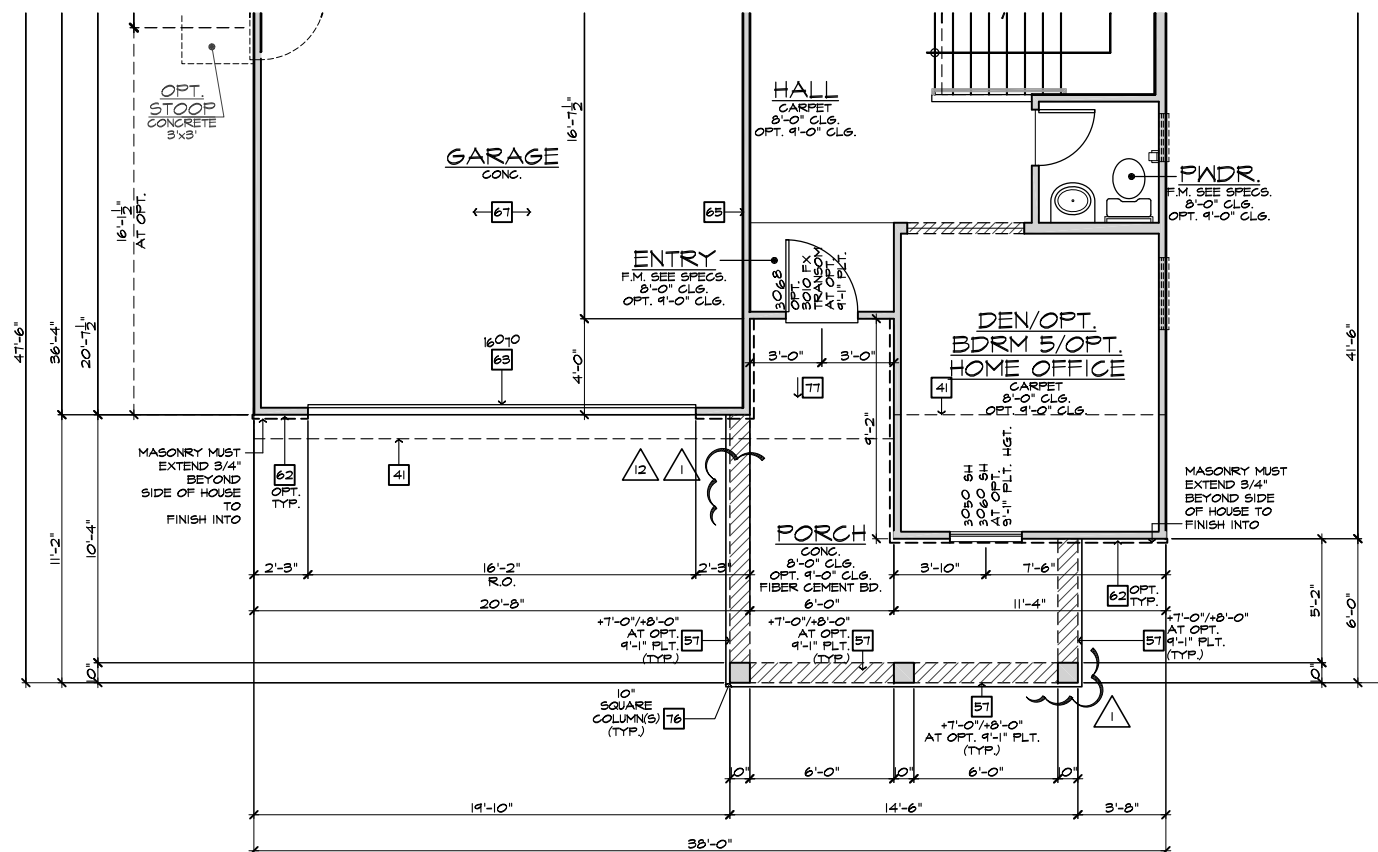

PARTIAL FIRST FLOOR PLAN 'C'

SCALE 1/4"=1'-0" (22'x34") - 1/8"=1'-0" (11'x17")

BASIC PLAN

NOTE: REFER TO BASIC FLOOR PLAN FOR INFORMATION NOT SHOWN HERE

These designs and drawings are CONFIDENTIAL, and the exclusive property of KB Home Corporation, and are not to be disclosed without the express permission of KB Home Corporation. They may not be used or duplicated without the express permission of KB Home Corporation. Copyright 2020 © KB Home Corporation, all rights reserved.

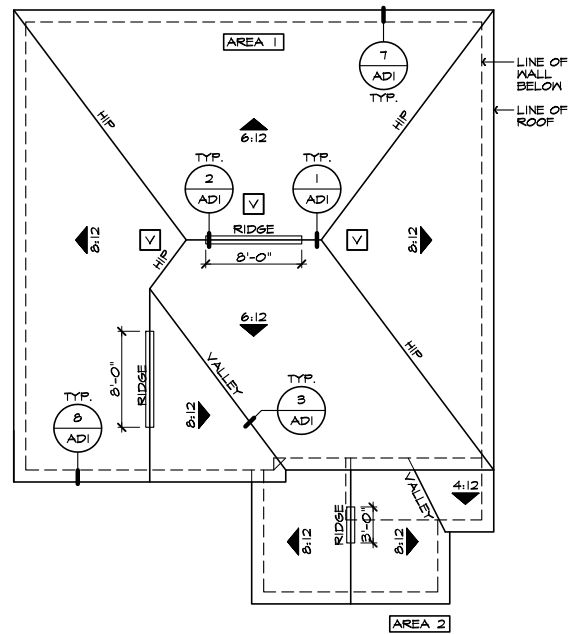

ROOF PLAN 'C'
SCALE 1/8"=1'-0" (22"x34") - 1/16"=1'-0" (11"x17")

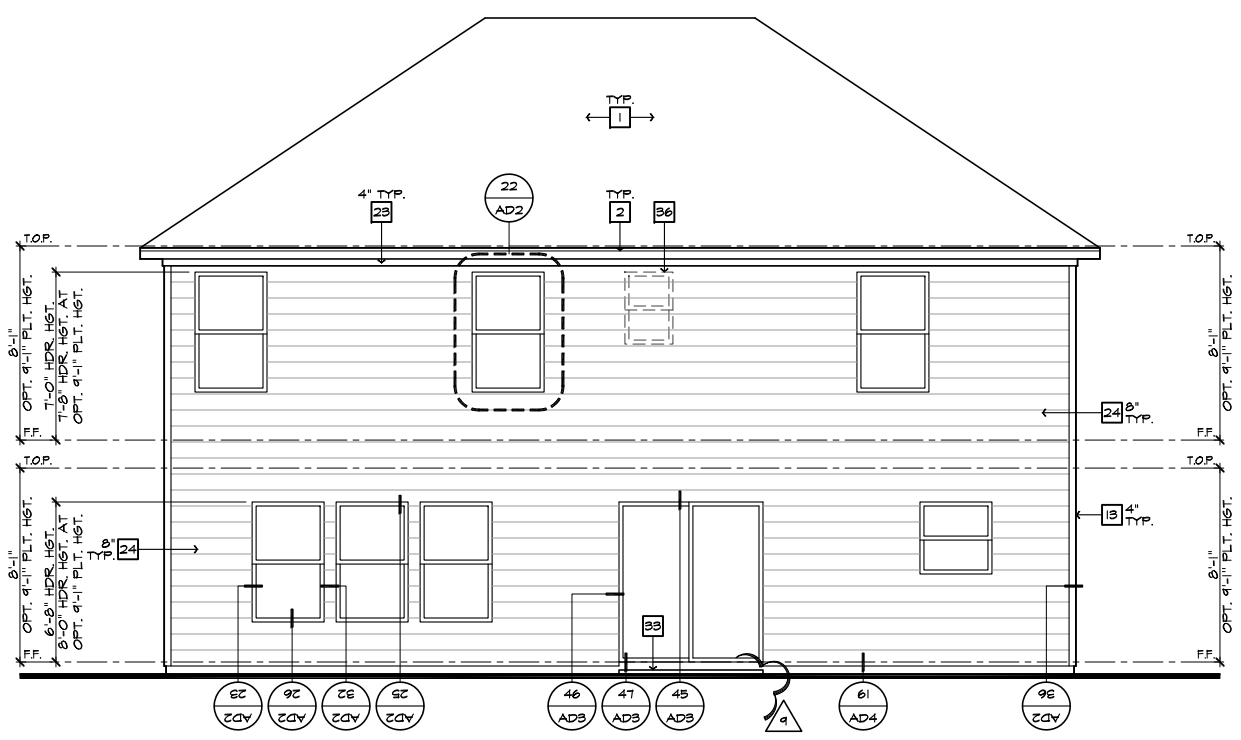

REAR ELEVATION 'C'
SCALE 1/4"=1'-0" (22"x34") - 1/8"=1'-0" (11"x17")

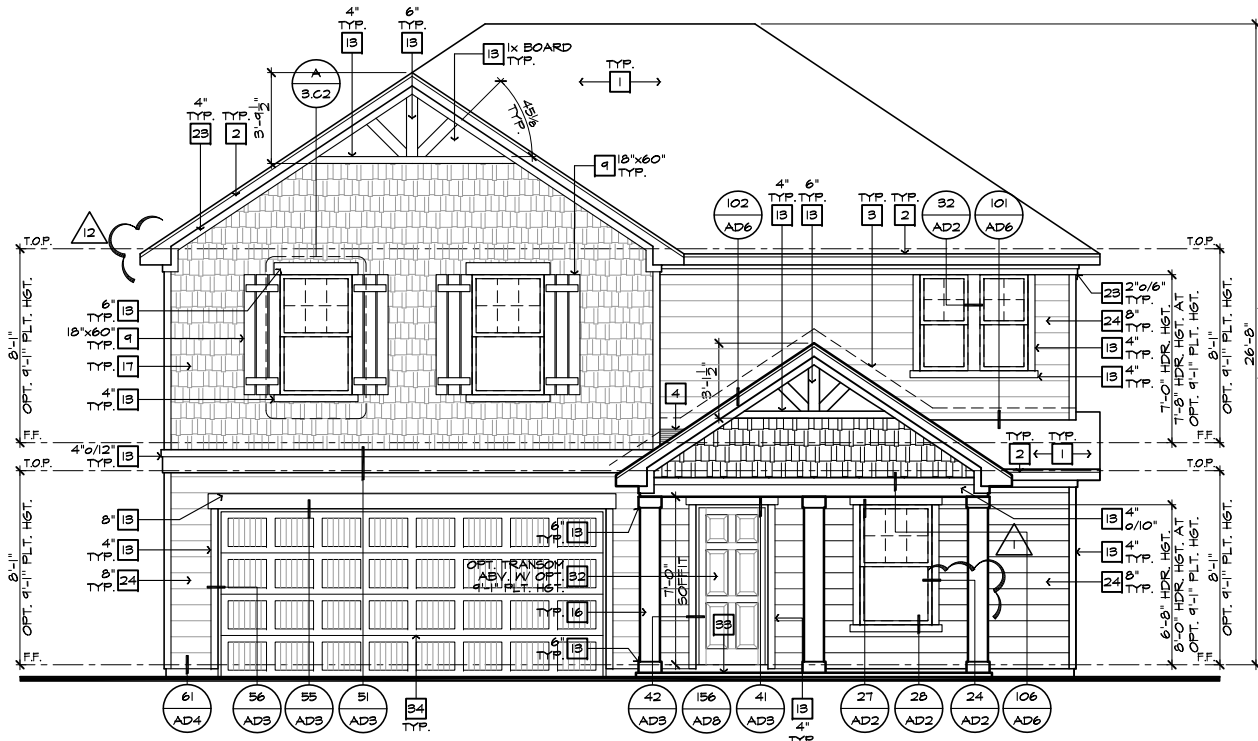

FRONT ELEVATION 'C'
SCALE 1/4"=1'-0" (22"x34") - 1/8"=1'-0" (11"x17")

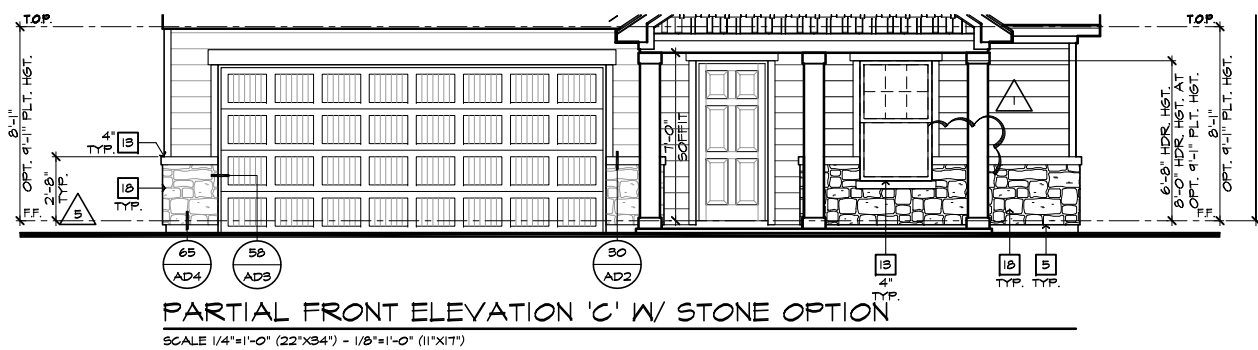

PARTIAL FRONT ELEVATION 'C' W/ STONE OPTION
SCALE 1/4"=1'-0" (22"x34") - 1/8"=1'-0" (11"x17")

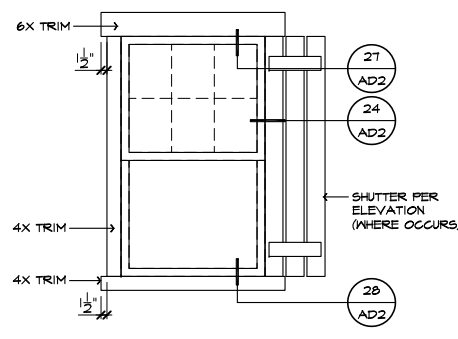

DETAIL 'A'
SCALE: N.T.S.

- ELEVATION NOTES**
- NOTE: NOT ALL KEY NOTES APPLY.
- ROOF MATERIAL - REFER TO ROOF NOTES
 - 2X FASCIA/BARGE BOARD WITH FASCIA CAP
 - 6:1 FLASHING
 - 6:1 FLASHING & SADDLE/CRICKET
 - 6:1 DRIP SCREED
 - 24"x24" CHIMNEY
 - DECORATIVE VENT
 - DECORATIVE CORBEL
 - DECORATIVE SHUTTERS
 - PEDIMENT. SEE ELEVATION FOR TYPE
 - RECESSED ELEMENT
 - DECORATIVE TRIM FYPON OR EQ. SEE ELEVATION FOR TYPE
 - TRIM PER SPEC- SEE ELEVATION FOR SIZE
 - SYNTHETIC MATERIAL
 - PRE-MANUFACTURED DECORATIVE COLUMN (SIZE, SEE ELEV.) FYPON OR EQ. SURROUNDING STRUCTURAL POST.
 - SITE-BUILT COLUMN - SEE ELEVATION FOR TYPE
 - SHAKE SIDING
 - STONE VENEER PER SPECS
 - BRICK/MASONRY VENEER PER SPECS
 - BUILT UP BRICK COLUMN
 - SOLDIER COURSE
 - ROCKLOCK COURSE
 - FRIEZE BOARD
 - SIDING W/ 4" CORNER TRIM PER SPECS
 - P.T. POST W/ WRAP - SEE STRUCTURAL FOR SIZE
 - PRE-FAB DECORATIVE TRIM
 - LIGHT WEIGHT PRECAST STONE TRIM
 - P.T. LUMBER RAILINGS (36" U.N.O.)
 - WRAP
 - DECORATIVE WINDOW/DOOR TRIM - FYPON OR EQ. SEE ELEVATION FOR SIZE.
 - BRACKET OR KICKER - FYPON OR EQ.
 - ENTRY DOOR
 - CONCRETE STOOP/ PORCH - SEE SLAB INTERFACE PLAN.
 - SECTIONAL GARAGE DOOR PER SPECS
 - ALUMINUM WRAP
 - OPTIONAL DOOR/WINDOW - REFER TO PLAN OPTIONS
 - OPTIONAL STANDING SEAM METAL ROOF
 - KEYSTONE
 - SOLDIER CROWN
 - JACK SOLDIER COURSE
 - WATER TABLE
 - ATRIUM DOOR
 - PILASTER - SEE ELEVATION FOR TYPE

ROOF PLAN NOTES 'C'

6:12 INDICATES ROOF SLOPE AND DIRECTION, U.N.O.

ROOF MATERIAL: COMPOSITION SHINGLE
12" (INCHES) TYPICAL ROOF OVERHANGS AT RAKE, U.N.O.
12" (INCHES) TYPICAL ROOF OVERHANGS AT EAVE, U.N.O.
LOCATE EAVE/ RAFTER VENTS EQUALLY BALANCED AROUND HOUSE EXCEPT ABOVE SHEARWALL PANELS.

ATTIC VENT CALCULATIONS

PROVIDE 1 SQ. IN. OF VENTILATION PER 300 SQ. IN. OF ATTIC SPACE. PROVIDE THAT AT LEAST 50% & NO MORE THAN 80% OF THE REQ. VENTILATING AREA IS PROVIDED BY VENTILATORS LOCATED IN THE UPPER PORTION OF THE ATTIC (HIGH VENTING) AT 3'-0" ABOVE EAVE WITH THE BALANCE BEING PROVIDED BY EAVE VENTS (LOW VENTING) (2018 N.C.-R 806.2)
* CALCULATION BY 1/150, HIGH/LOW VENTING NOT REQUIRED.
APPROXIMATE RIDGE VENT LOCATIONS SHOWN.
ACTUAL LOCATIONS TO BE DETERMINED IN THE FIELD.

AREA 1 / MAIN:

VENTILATION REQUIRED:	SO. FT. / 300	4.67 SQ. FT.
ATTIC AREA = 1401	X 144 =	672 SQ. IN.
	TOTAL HIGH & LOW =	672 SQ. IN.
	X 50% =	336 SQ. IN.

VENTILATION PROVIDED:

HIGH	LF RIDGE VENT(S) AT	10	SO. IN. / LF. =	288 SQ. IN.
	ROOF VENT(S) AT	50	SO. IN. EA. =	150 SQ. IN.
	SUB-TOTAL HIGH VENTILATION:			438 SQ. IN.
LOW	LF VENTILATED SOFFIT AT	6.9	SO. IN. / LF. =	400 SQ. IN.
	ROOF VENT(S) AT	50	SO. IN. EA. =	0 SQ. IN.
	SUB-TOTAL LOW VENTILATION:			400 SQ. IN.
	TOTAL VENTILATION PROVIDED:			838 SQ. IN.

AREA 2 / PORCH:

VENTILATION REQUIRED:	SO. FT. / 150	1.20 SQ. FT.
ATTIC AREA = 180	X 144 =	178 SQ. IN.
	TOTAL HIGH & LOW =	178 SQ. IN.

VENTILATION PROVIDED:

	LF VENTILATED SOFFIT AT	6.9	SO. IN. / LF. =	110 SQ. IN.
	LF RIDGE VENT(S) AT	10	SO. IN. EA. =	100 SQ. IN.
	TOTAL VENTILATION PROVIDED:			218 SQ. IN.

NOTES:

ALL VENT OPENINGS SHALL BE COVERED WITH 1/4" CORROSION RESISTANT METAL MESH.
FRAMER SHALL BE RESPONSIBLE FOR COORDINATING WITH TRUSS MANUFACTURER TO ACCOMMODATE ALL ATTIC VENTS.
ALL VENTS SHALL BE INSTALLED SO AS TO MAKE THEM WATER-PROOF & WALL MOUNTED LOWERS SHALL BE SEALED & FLASHED W/ TAPE/STAPLE IN THE SAME MANNER PRESCRIBED FOR WINDOW INSTALLATION.
PROVIDE APPROVED INSULATION DAMS (BAFFLES) WHERE VENT BLOCKS ARE USED BETWEEN ROOF FRAMING MEMBERS TO PREVENT VENT HOLES FROM BEING BLOCKED BY INSULATION.
LOCATE HIGH VENTING MINIMUM 3'-0" VERTICAL DISTANCE ABOVE EAVES.
WHEN GABLE END TRUSS MEMBERS BLOCK GABLE END VENTS, PROVIDE ADEQUATE ADDITIONAL VENTILATION BY MEANS OF ROOF TILE VENTS.

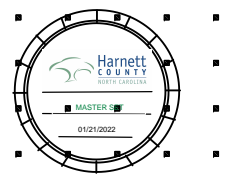

NORTH CAROLINA 40' SERIES

KB HOME
NORTH CAROLINA DIVISION
4506 S. MIAMI BLVD.
SUITE 180
DURHAM, NC 27703
TEL: (919) 768-7980
FAX: (919) 544-2928

2018 NORTH CAROLINA STATE BUILDING CODES

ISSUE DATE: 01/08/15
PROJECT No.: 1350999:56
DIVISION MGR.: DCS
REVISIONS: 08/20/20

- 11 DIVISION REVISION NC19654NCP - 08/28/19 - FAB
- 12 DIVISION REVISION NC19657NCP - 09/26/19 - FAB
- 13 DIVISION REVISION NC20003NCP - 12/19/19 - CL
- 14 VENTILATION NC20008NCP - 01/17/20 - CL
- 15 DIVISION REVISION NC20013NCP - 02/10/20 - MCP
- 16 DIVISION REVISION NC20017NCP - 03/04/20 - KBA
- 17 HOME OFFICE CORP20009CORP-08/20/20-CTD

FOR INTERNAL USE ONLY
REVIEWED BY:
1. _____
2. _____
3. _____
4. _____
5. _____
6. _____

PLAN: 238.2338
SHEET: 3.C2

SPEC. LEVEL 1
RALEIGH-DURHAM 40' SERIES

These designs and drawings are CONFIDENTIAL, and the exclusive property of KB Home Corporation and are not to be disclosed without the express permission of KB Home Corporation. Copyright 2020 © KB Home Corporation, all rights reserved.

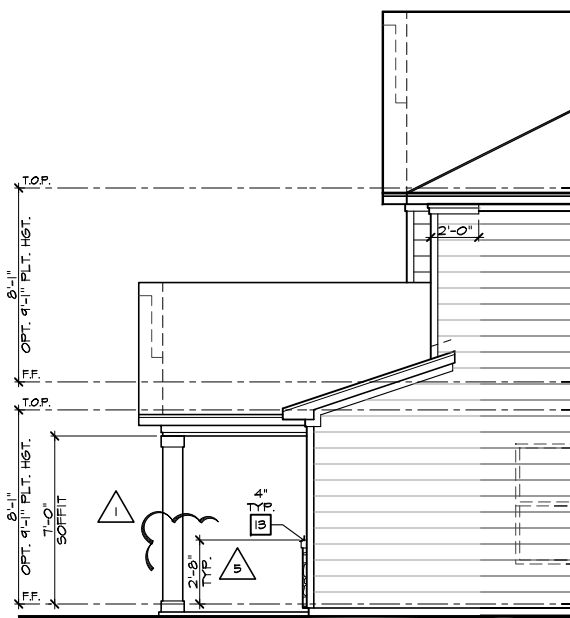

PARTIAL RIGHT ELEVATION 'C'
W/ STONE OPTION

SCALE 1/4"=1'-0" (22"X34") - 1/8"=1'-0" (11"X17")

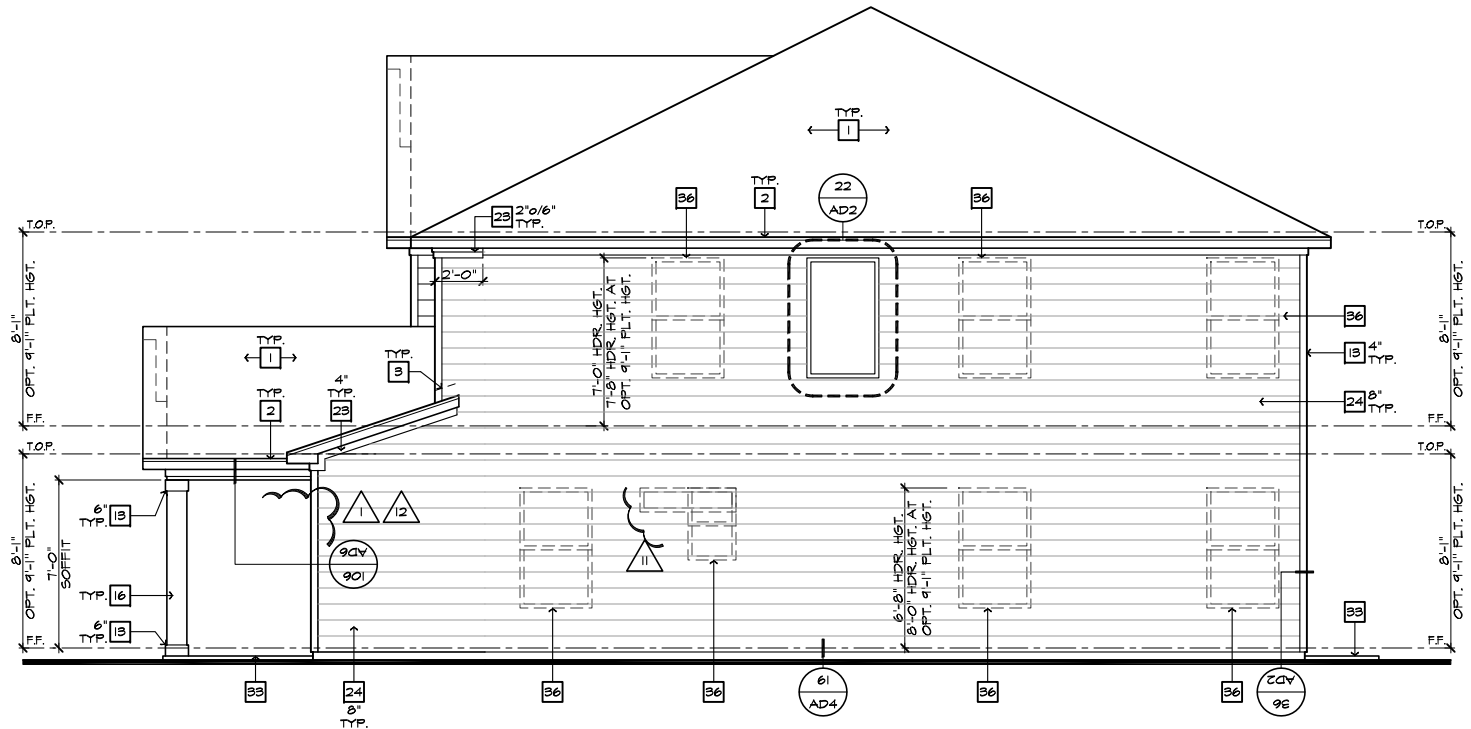

RIGHT ELEVATION 'C'

SCALE 1/4"=1'-0" (22"X34") - 1/8"=1'-0" (11"X17")

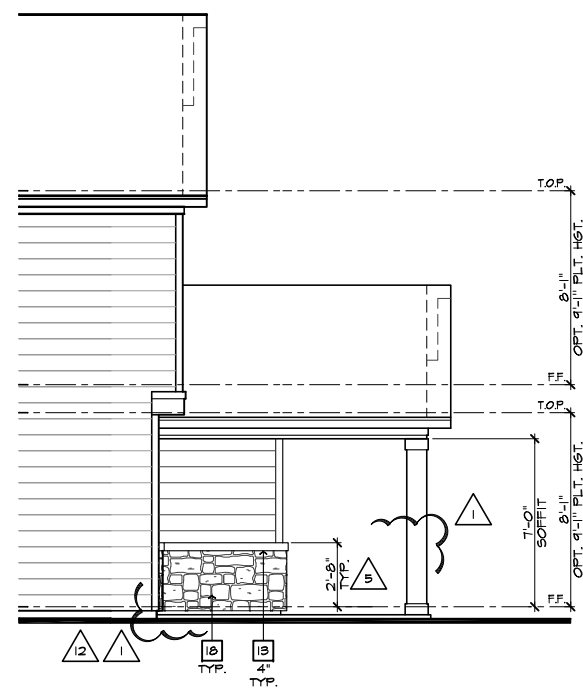

PARTIAL LEFT ELEVATION 'C'
W/ STONE OPTION

SCALE 1/4"=1'-0" (22"X34") - 1/8"=1'-0" (11"X17")

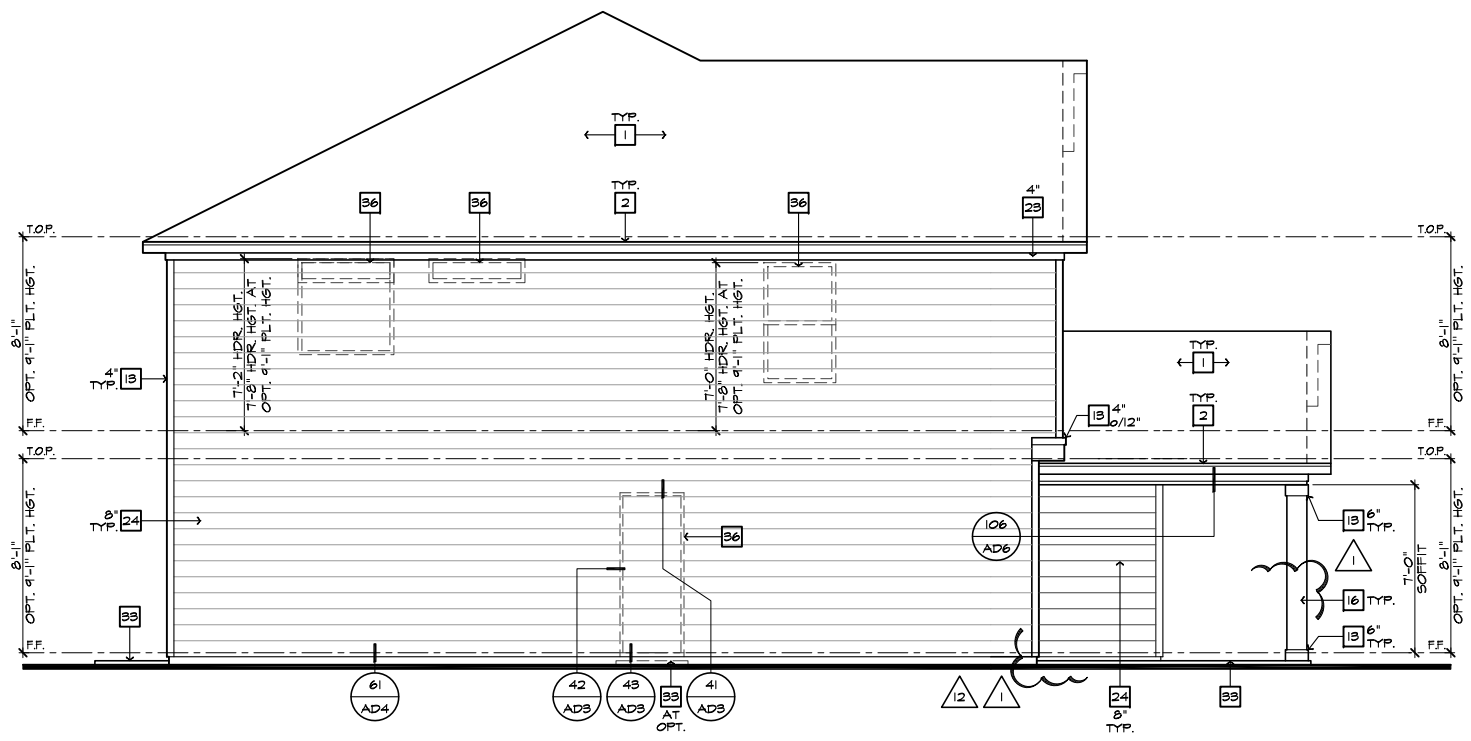

LEFT ELEVATION 'C'

SCALE 1/4"=1'-0" (22"X34") - 1/8"=1'-0" (11"X17")

- ELEVATION NOTES**
- NOTE: NOT ALL KEY NOTES APPLY.
1. ROOF MATERIAL - REFER TO ROOF NOTES
 2. 2X FASCIA/BARGE BOARD WITH FASCIA CAP
 3. 6:1. FLASHING
 4. 6:1. FLASHING & SADDLE/CRICKET
 5. 6:1. DRIP SCREED
 6. 24"X24" CHIMNEY
 7. DECORATIVE VENT
 8. DECORATIVE CORBEL
 9. DECORATIVE SHUTTERS
 10. PEDIMENT. SEE ELEVATION FOR TYPE
 11. RECESSED ELEMENT
 12. DECORATIVE TRIM FYPON OR EQ. SEE ELEVATION FOR TYPE
 13. TRIM PER SPEC- SEE ELEVATION FOR SIZE
 14. SYNTHETIC MATERIAL
 15. PRE-MANUFACTURED DECORATIVE COLUMN (SIZE, SEE ELEV.) FYPON OR EQ. SURROUNDING STRUCTURAL POST.
 16. SITE-BUILT COLUMN - SEE ELEVATION FOR TYPE
 17. SHAKE SIDING
 18. STONE VENEER PER SPECS
 19. BRICK/MASONRY VENEER PER SPECS
 20. BUILT UP BRICK COLUMN
 21. SOLDIER COURSE
 22. ROLLOCK COURSE
 23. FRIEZE BOARD
 24. SIDING W/ 4" CORNER TRIM PER SPECS
 25. P.T. POST W/ WRAP - SEE STRUCTURAL FOR SIZE
 26. PRE-FAB DECORATIVE TRIM
 27. LIGHT WEIGHT PRECAST STONE TRIM
 28. P.T. LUMBER RAILINGS (36" U.N.O.)
 29. WRAP
 30. DECORATIVE WINDOW/DOOR TRIM - FYPON OR EQ. SEE ELEVATION FOR SIZE.
 31. BRACKET OR KICKER - FYPON OR EQ.
 32. ENTRY DOOR
 33. CONCRETE STOOP/ PORCH - SEE SLAB INTERFACE PLAN.
 34. SECTIONAL GARAGE DOOR PER SPECS
 35. ALUMINUM WRAP
 36. OPTIONAL DOOR/WINDOW - REFER TO PLAN OPTIONS
 37. OPTIONAL STANDING SEAM METAL ROOF
 38. KEYSTONE
 39. SOLDIER CROWN
 40. JACK SOLDIER COURSE
 41. WATER TABLE
 42. ATRIUM DOOR
 43. PILASTER - SEE ELEVATION FOR TYPE



**NORTH CAROLINA
40' SERIES**

KB HOME
NORTH CAROLINA DIVISION

4506 S. MIAMI BLVD.
SUITE 180
DURHAM, NC 27703
TEL: (919) 768-7980
FAX: (919) 544-2928

**2018 NORTH
CAROLINA STATE
BUILDING
CODES**

- ISSUE DATE: 01/08/15
PROJECT No.: 1350999:56
DIVISION MGR.: DCS
REVISIONS: 08/20/20
- 11 DIVISION REVISION NC19654NCP - 08/28/19 - FAE
 - 12 DIVISION REVISION NC19657NCP - 09/26/19 - FAE
 - 13 DIVISION REVISION NC20003NCP - 12/19/19 - CL
 - 14 VENTILATION NC20008NCP - 01/17/20 - CL
 - 15 DIVISION REVISION NC20013NCP - 02/10/20 - MCP
 - 16 DIVISION REVISION NC20017NCP - 03/04/20 - KBA
 - 17 HOME OFFICE CORP20009CORP-08/20/20-CTD

FOR INTERNAL USE ONLY

REVIEWED BY:	DATE:
1.	
2.	
3.	
4.	
5.	
6.	

PLAN:
238.2338
SHEET:
3.C3

**SPEC. LEVEL 1
RALEIGH-DURHAM
40' SERIES**

These designs and drawings are CONFIDENTIAL, and the exclusive property of KB Home Corporation, and are not to be disclosed without the express permission of KB Home Corporation. Copyright 2020 © KB Home Corporation, all rights reserved.

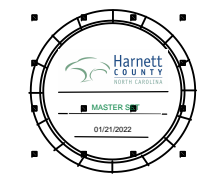

NORTH CAROLINA 40' SERIES

KB HOME
NORTH CAROLINA DIVISION
4506 S. MIAMI BLVD.
SUITE 180
DURHAM, NC 27703
TEL: (919) 768-7980
FAX: (919) 544-2928

2018 NORTH CAROLINA STATE BUILDING CODES

ISSUE DATE: 01/08/15
PROJECT No.: 1350999:56
DIVISION MGR.: DCS
REVISIONS: 08/20/20

- 11 DIVISION REVISION NC19654NCP - 08/28/19 - FAB
- 12 DIVISION REVISION NC19657NCP - 09/26/19 - FAB
- 13 DIVISION REVISION NC20003NCP - 12/19/19 - CL
- 14 VENTILATION NC20004NCP - 01/17/20 - CL
- 15 DIVISION REVISION NC20015NCP - 02/10/20 - MCP
- 16 DIVISION REVISION NC20017NCP - 03/04/20 - KBA
- 17 HOME OFFICE CORP20009CORP-08/20/20-CTD

FOR INTERNAL USE ONLY	
REVIEWED BY:	
1.	
2.	
3.	
4.	
5.	
6.	

PLAN: 238.2338
SHEET: 3.C4

SPEC. LEVEL 1 RALEIGH-DURHAM 40' SERIES

ELEVATION NOTES

- NOTE: NOT ALL KEY NOTES APPLY.
- ROOF MATERIAL - REFER TO ROOF NOTES
 - 2X FASCIA/BARGE BOARD WITH FASCIA CAP
 - 6.1. FLASHING
 - 6.1. FLASHING & SADDLE/CRICKET
 - 6.1. DRIP SCREED
 - 24"x24" CHIMNEY
 - DECORATIVE VENT
 - DECORATIVE CORBEL
 - DECORATIVE SHUTTERS
 - PEDIMENT. SEE ELEVATION FOR TYPE
 - RECESSED ELEMENT
 - DECORATIVE TRIM FYPON OR EQ. SEE ELEVATION FOR TYPE
 - TRIM PER SPEC- SEE ELEVATION FOR SIZE
 - SYNTHETIC MATERIAL
 - PRE-MANUFACTURED DECORATIVE COLUMN (SIZE, SEE ELEV.) FYPON OR EQ. SURROUNDING STRUCTURAL POST.
 - SITE-BUILT COLUMN - SEE ELEVATION FOR TYPE
 - SHAKE SIDING
 - STONE VENEER PER SPECS
 - BRICK/MASONRY VENEER PER SPECS
 - BUILT UP BRICK COLUMN
 - SOLDIER COURSE
 - ROWLOCK COURSE
 - FRIEZE BOARD
 - SIDING W/ 4" CORNER TRIM PER SPECS
 - P.T. POST W/ WRAP - SEE STRUCTURAL FOR SIZE
 - PRE-FAB DECORATIVE TRIM
 - LIGHT WEIGHT PRECAST STONE TRIM
 - P.T. LUMBER RAILINGS (36" U.N.O.)
 - WRAP
 - DECORATIVE WINDOW/DOOR TRIM - FYPON OR EQ. SEE ELEVATION FOR SIZE.
 - SOLDIER COURSE
 - ENTRY DOOR
 - CONCRETE STOOP/PORCH - SEE SLAB INTERFACE PLAN.
 - SECTIONAL GARAGE DOOR PER SPECS
 - ALUMINUM WRAP
 - OPTIONAL DOOR/WINDOW - REFER TO PLAN OPTIONS
 - OPTIONAL STANDING SEAM METAL ROOF
 - KEYSTONE
 - SOLDIER CROWN
 - JACK SOLDIER COURSE
 - WATER TABLE
 - ATRIUM DOOR
 - PILASTER - SEE ELEVATION FOR TYPE

PARTIAL PLAN NOTES

- NOTE: NOT ALL KEY NOTES APPLY.
- WATER HEATER LOCATION - FOR GAS - LOCATE ON 18" HIGH PLATFORM - FOR INTERIOR LOCATION - PROVIDE PAN & DRAIN (REFER TO DETAILS)
 - WATER HEATER 3" VENT TO OUTSIDE AIR
 - MAIN LINE SHUT-OFF VALVE AND TEMP. & PRESSURE RELIEF VALVE
 - LINE OF WALL BELOW
 - LINE OF FLOOR ABOVE
 - LINE 36" HIGH GUARDRAIL (REFER TO DETAIL SHEETS)
 - A/C PAD LOCATION
 - LOW WALL - REFER TO PLAN FOR HEIGHT
 - 2x6 STUD WALL
 - DEL. 2x4 WALL PER PLAN
 - INTERIOR SHELF - REFER TO PLAN FOR HEIGHT
 - FLAT SOFFIT
 - ARCHED SOFFIT
 - OPT. DOOR/WINDOW
 - PRE-MANUFACTURED DECORATIVE COLUMN (SIZE, SEE ELEV.) FYPON OR EQ. SURROUNDING STRUCTURAL POST.
 - BRICK / STONE VENEER - REFER TO ELEVATIONS
 - SECTIONAL GARAGE DOOR PER SPECS
 - 3" DIAM. CONCRETE FILLED PIPE BOLLARD 36" HIGH WITH MIN. 12" EMBEDMENT INTO CONCRETE. (NOT REQUIRED AT ELECTRIC WATER HEATERS OR FOR APPLIANCES LOCATED OUT OF THE VEHICLE'S NORMAL TRAVEL PATH).
 - P.T. POST W/ WRAP.
 - EGRESS WINDOW
 - WINDOW LEDGE - HEIGHT & WIDTH OF OPENING TO EXTEND 6" BEYOND WINDOW(S) ON ALL SIDES U.N.O.
 - SITE-BUILT COLUMN - SEE ELEVATION FOR TYPE
 - CONCRETE SLAB. SLOPE 1/4" PER FT. MIN. SEE PLAN FOR SIZE.

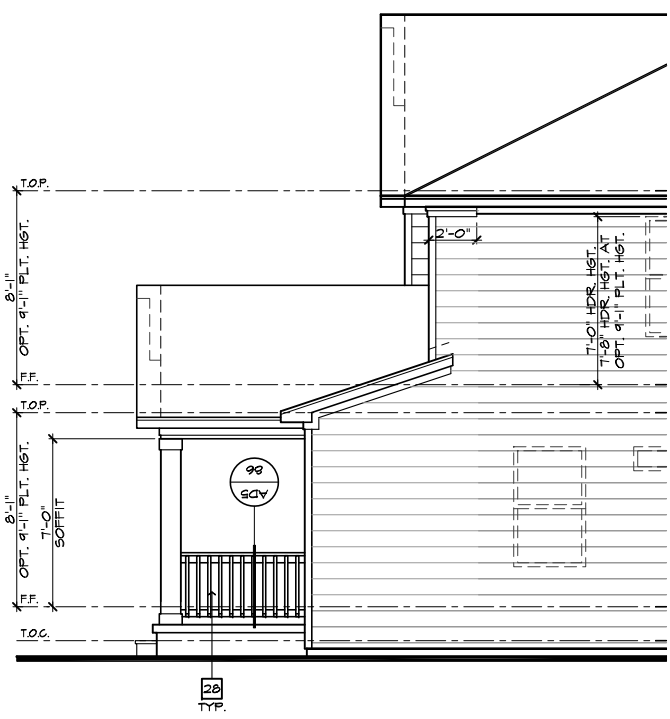

PARTIAL RIGHT ELEVATION 'C' AT CRAWL SPACE
SCALE 1/4"=1'-0" (22"x34") - 1/8"=1'-0" (11"x17")



FRONT ELEVATION 'C' W/ CRAWL SPACE
SCALE 1/4"=1'-0" (22"x34") - 1/8"=1'-0" (11"x17")

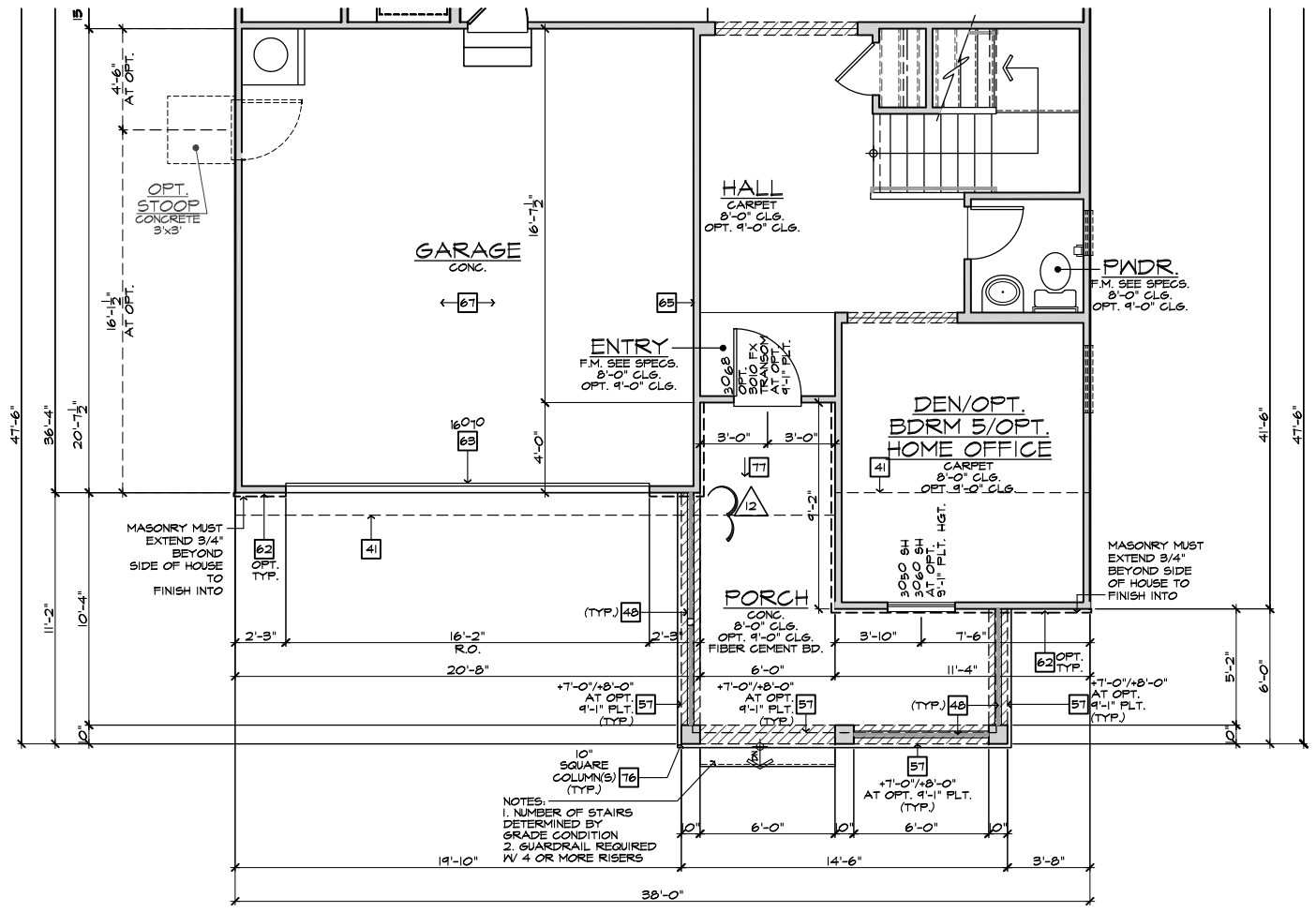

PARTIAL FIRST FLOOR PLAN 'C' AT CRAWL SPACE
SCALE 1/4"=1'-0" (22"x34") - 1/8"=1'-0" (11"x17")

NOTE: REFER TO BASIC ELEVATIONS FOR INFORMATION NOT SHOWN HERE

NOTE: REFER TO BASIC FLOOR PLAN FOR INFORMATION NOT SHOWN HERE

These designs and drawings are CONFIDENTIAL, and the exclusive property of KB Home Corporation, and are not to be disclosed without the express permission of KB Home Corporation. Copyright 2020 © KB Home Corporation, all rights reserved.

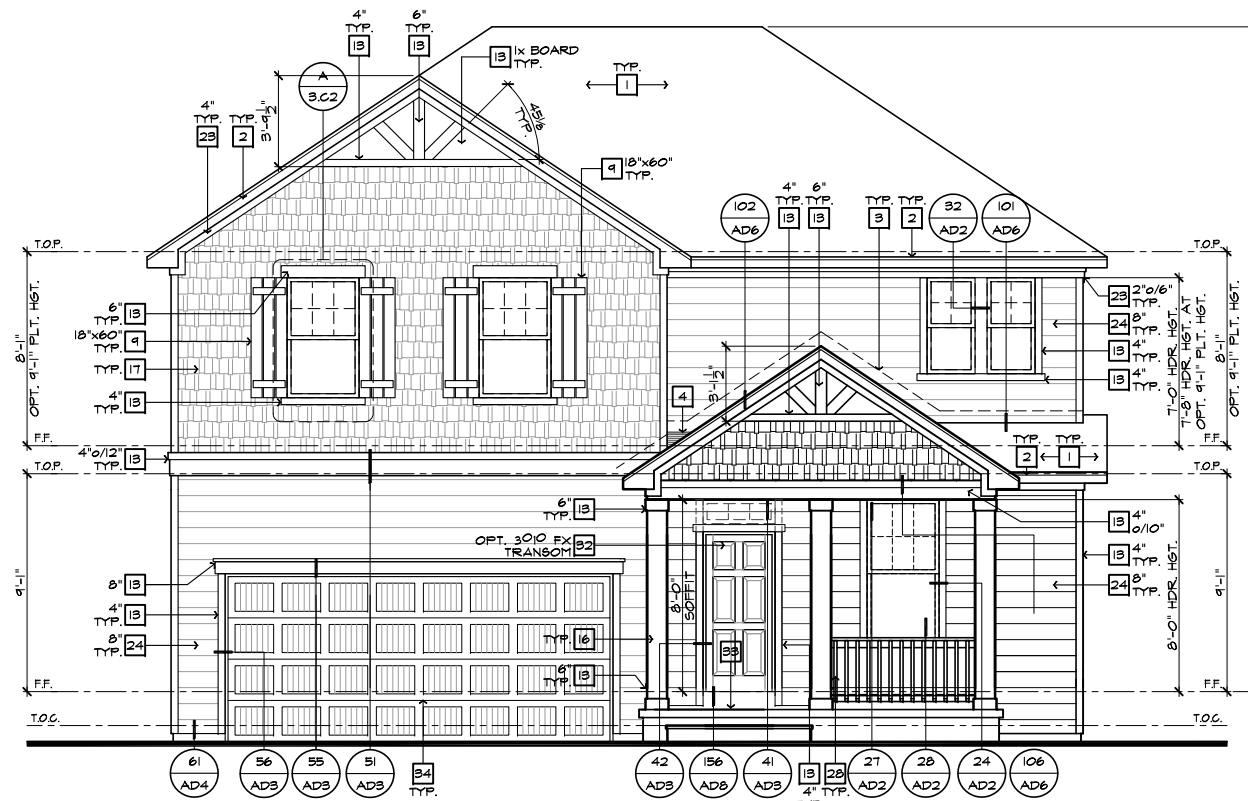

FRONT ELEVATION 'C' W/ CRAWL SPACE
AT OPTIONAL 9'-1" PLT. HGT.

SCALE 1/4"=1'-0" (22"X34") - 1/8"=1'-0" (11"X17")

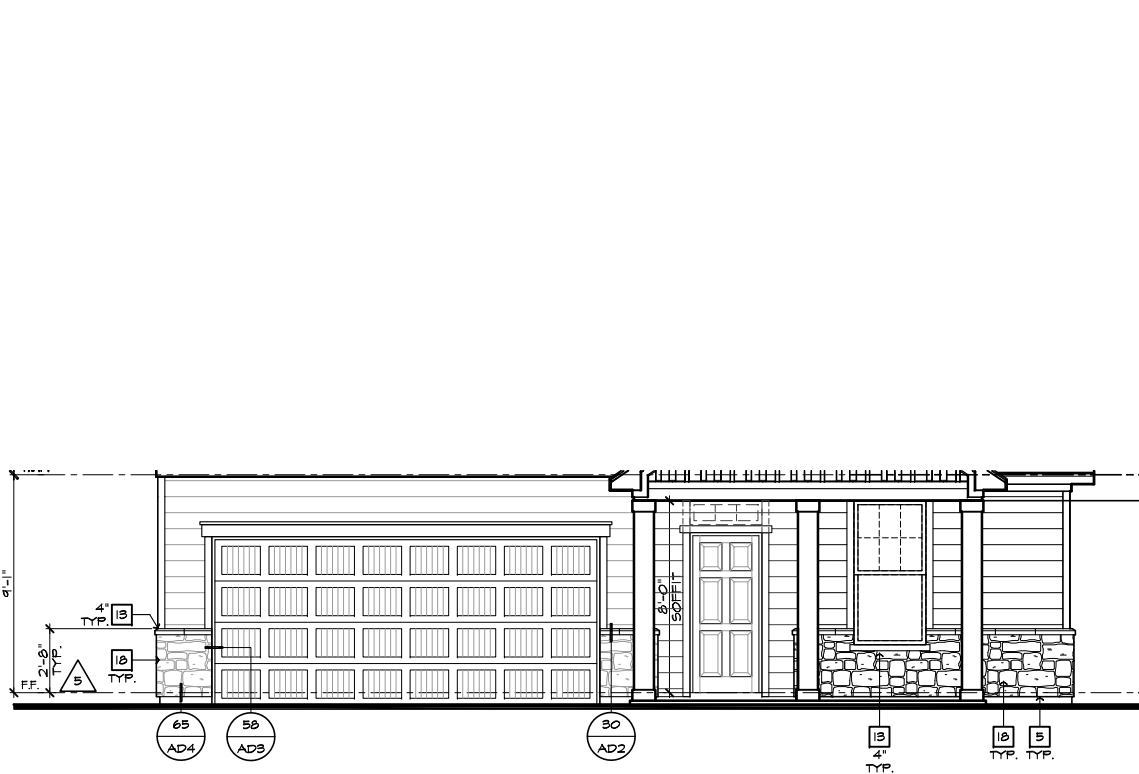

PARTIAL FRONT ELEVATION 'C'
AT OPTIONAL 9'-1" PLT. HGT. W/ STONE OPT.

SCALE 1/4"=1'-0" (22"X34") - 1/8"=1'-0" (11"X17")

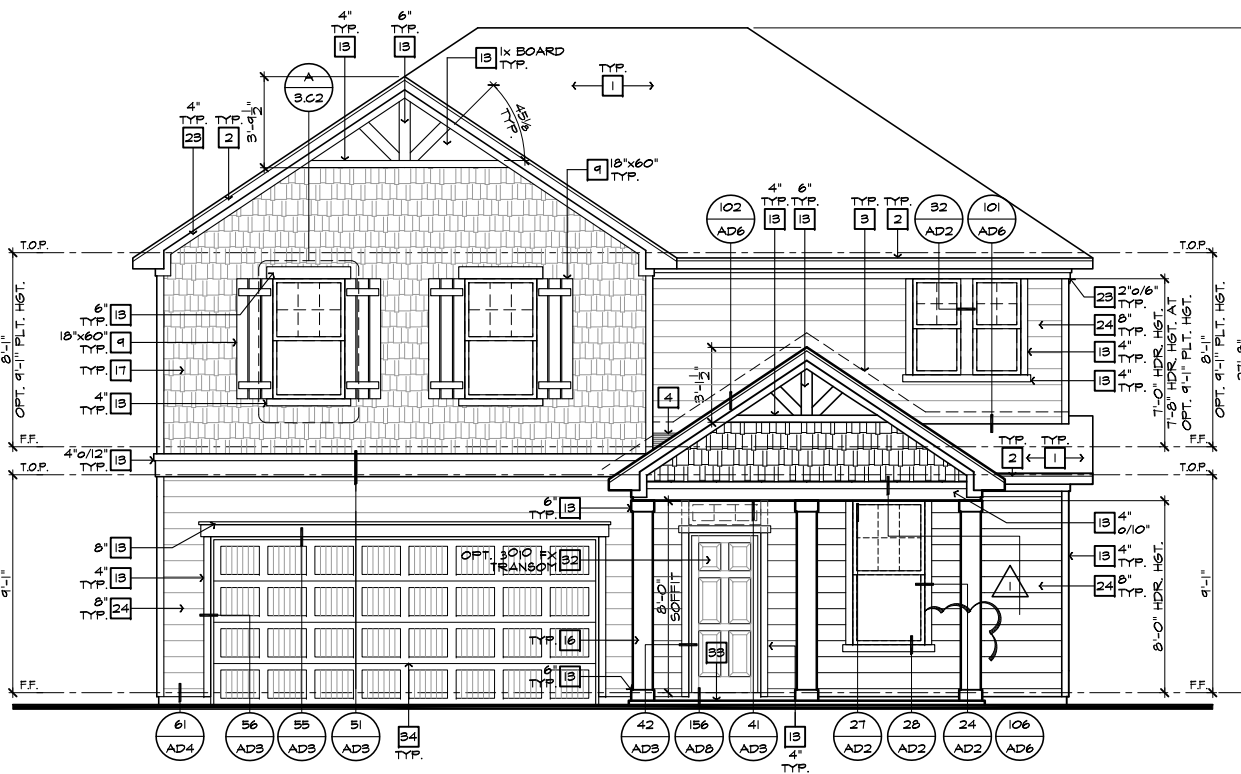

FRONT ELEVATION 'C'
AT OPTIONAL 9'-1" PLT. HGT.

SCALE 1/4"=1'-0" (22"X34") - 1/8"=1'-0" (11"X17")

#	ELEVATION NOTES
NOTE: NOT ALL KEY NOTES APPLY.	
1.	ROOF MATERIAL - REFER TO ROOF NOTES
2.	2X FASCIA/BARGE BOARD WITH FASCIA CAP
3.	6.1. FLASHING
4.	6.1. FLASHING & SADDLE/CRICKET
5.	6.1. DRIP SCREED
6.	24"X24" CHIMNEY
7.	DECORATIVE VENT
8.	DECORATIVE CORBEL
9.	DECORATIVE SHUTTERS
10.	PEDIMENT. SEE ELEVATION FOR TYPE
11.	RECESSED ELEMENT
12.	DECORATIVE TRIM FYPON OR EQ. SEE ELEVATION FOR TYPE
13.	TRIM PER SPEC- SEE ELEVATION FOR SIZE
14.	SYNTHETIC MATERIAL
15.	PRE-MANUFACTURED DECORATIVE COLUMN (SIZE, SEE ELEV.) FYPON OR EQ. SURROUNDING STRUCTURAL POST.
16.	SITE-BUILT COLUMN - SEE ELEVATION FOR TYPE
17.	SHAKE SIDING
18.	STONE VENEER PER SPECS
19.	BRICK/MASONRY VENEER PER SPECS
20.	BUILT UP BRICK COLUMN
21.	SOLDIER COURSE
22.	ROWLOCK COURSE
23.	FRIEZE BOARD
24.	SIDING W/ 4" CORNER TRIM PER SPECS
25.	P.T. POST W/ WRAP - SEE STRUCTURAL FOR SIZE
26.	PRE-FAB DECORATIVE TRIM
27.	LIGHT WEIGHT PRECAST STONE TRIM
28.	P.T. LUMBER RAILINGS (+36" U.N.O.)
29.	WRAP
30.	DECORATIVE WINDOW/DOOR TRIM - FYPON OR EQ. SEE ELEVATION FOR SIZE.
31.	BRACKET OR KICKER - FYPON OR EQ.
32.	ENTRY DOOR
33.	CONCRETE STOOP/ PORCH - SEE SLAB INTERFACE PLAN.
34.	SECTIONAL GARAGE DOOR PER SPECS
35.	ALUMINUM WRAP
36.	OPTIONAL DOOR/WINDING - REFER TO PLAN OPTIONS
37.	OPTIONAL STANDING SEAM METAL ROOF
38.	KEYSTONE
39.	SOLDIER CROWN
40.	JACK SOLDIER COURSE
41.	WATER TABLE
42.	ATRIUM DOOR
43.	PILASTER - SEE ELEVATION FOR TYPE
9'-1" PLATE OPTION	
NOTE: WINDOW SIZES WILL INCREASE BY 1" AT 9'-1" PLATE OPTIONS. HEADER HEIGHTS FOR ALL WINDOWS WILL BE 7'-8" AT 9'-1" PLATE OPTIONS.	

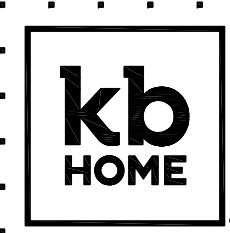

**NORTH CAROLINA
40' SERIES**

KB HOME
NORTH CAROLINA DIVISION
4506 S. MIAMI BLVD.
SUITE 180
DURHAM, NC 27703
TEL: (919) 768-7980
FAX: (919) 544-2928

**2018 NORTH
CAROLINA STATE
BUILDING
CODES**

- ISSUE DATE: 01/08/15
- PROJECT No.: 1350999:56
- DIVISION MGR.: DCS
- REVISIONS: 08/20/20
- 11 DIVISION REVISION NC19654NCP - 08/28/19 - FAE
- 12 DIVISION REVISION NC19657NCP - 09/26/19 - FAE
- 13 DIVISION REVISION NC20003NCP - 12/19/19 - CL
- 14 VENTILATION NC20008NCP - 01/17/20 - CL
- 15 DIVISION REVISION NC20013NCP - 02/10/20 - MCP
- 16 DIVISION REVISION NC20017NCP - 03/04/20 - KBA
- 17 HOME OFFICE CORP20009CORP-08/20/20-CTD

FOR INTERNAL USE ONLY	
REVIEWED BY:	
1.	
2.	
3.	
4.	
5.	
6.	

PLAN:
238.2338
SHEET:
3.C5

SPEC. LEVEL 1
**RALEIGH-DURHAM
40' SERIES**

These designs and drawings are CONFIDENTIAL, and the exclusive property of KB Home Corporation, and are not to be disclosed without the express permission of KB Home Corporation. Copyright 2020 © KB Home Corporation, all rights reserved.

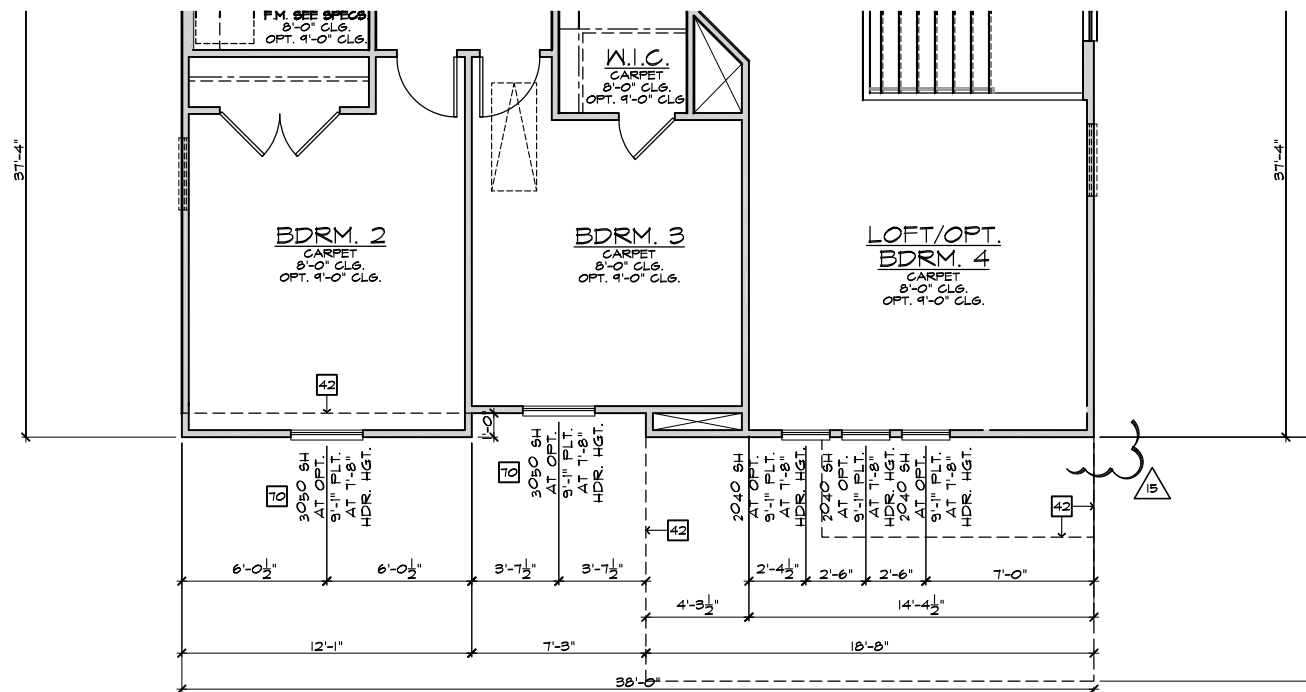

PARTIAL SECOND FLOOR PLAN 'D'

SCALE 1/4"=1'-0" (22"X34") - 1/8"=1'-0" (11"X17")

BASIC PLAN

#	PARTIAL PLAN NOTES
NOTE: NOT ALL KEY NOTES APPLY.	
27.	WATER HEATER LOCATION - FOR GAS - LOCATE ON 18" HIGH PLATFORM - FOR INTERIOR LOCATION - PROVIDE PAN & DRAIN (REFER TO DETAILS)
28.	WATER HEATER B VENT TO OUTSIDE AIR
29.	MAIN LINE SHUT-OFF VALVE AND TEMP. & PRESSURE RELIEF VALVE
34.	LINE OF WALL BELOW
41.	LINE OF FLOOR ABOVE
42.	LINE OF FLOOR BELOW
49.	MIN. 36" HIGH GUARDRAIL (REFER TO DETAIL SHEETS)
50.	A/C PAD LOCATION
51.	LOW WALL - REFER TO PLAN FOR HEIGHT
52.	2x6 STUD WALL
54.	DEL. 2x4 WALL PER PLAN
55.	INTERIOR SHELF - REFER TO PLAN FOR HEIGHT
57.	FLAT SOFFIT
58.	ARCHED SOFFIT
60.	OPT. DOOR/WINDOW
61.	PRE-MANUFACTURED DECORATIVE COLUMN (SIZE, SEE ELEV.)
62.	BRICK / STONE VENEER - REFER TO ELEVATIONS
63.	SECTIONAL GARAGE DOOR PER SPECS
66.	3" DIAM. CONCRETE FILLED FIRE BOLLARD 36" HIGH WITH MIN. 12" EMBEDMENT INTO CONCRETE (NOT REQUIRED AT ELECTRIC WATER HEATERS OR FOR APPLIANCES LOCATED OUT OF THE VEHICLE'S NORMAL TRAVEL PATH)
68.	P.T. POST IV WRAP
70.	EGRESS WINDOW
75.	WINDOW LEDGE - HEIGHT & WIDTH OF OPENING TO EXTEND 6" BEYOND WINDOW(S) ON ALL SIDES UNO.
76.	SITE-BUILT COLUMN - SEE ELEVATION FOR TYPE
77.	CONCRETE SLAB - SLOPE 1/4" PER FT. MIN. SEE PLAN FOR SLOPE

NORTH CAROLINA 40' SERIES

KB HOME NORTH CAROLINA DIVISION

4518 S. MIAMI BLVD. SUITE 180 DURHAM, NC 27703 TEL: (919) 768-7988 FAX: (919) 472-0582

2018 NORTH CAROLINA STATE BUILDING CODES

ISSUE DATE: 01/08/15
PROJECT No.: 1350999:56
DIVISION MGR.: DCS
REVISIONS: 08/20/20

- 11 DIVISION REVISION NC19654NCP - 08/28/19 - FAE
- 12 DIVISION REVISION NC19657NCP - 09/26/19 - FAE
- 13 DIVISION REVISION NC20003NCP - 12/19/19 - CL
- 14 VENTILATION NC20008NCP - 01/17/20 - CL
- 15 DIVISION REVISION NC20013NCP - 02/10/20 - MCP
- 16 DIVISION REVISION NC20017NCP - 03/04/20 - KBA
- 17 HOME OFFICE CORP210095CORP-08/20/20-CTD
- 18 ADD NOTE TO TF NC20037NCP - 10/06/20 - KBA
- 19 DIVISION REQ. REVISION NC21005NCP - 01/06/21 - KBA

PLAN: 238.2338

SHEET: 3.D1

SPEC. LEVEL 1 RALEIGH-DURHAM 40' SERIES

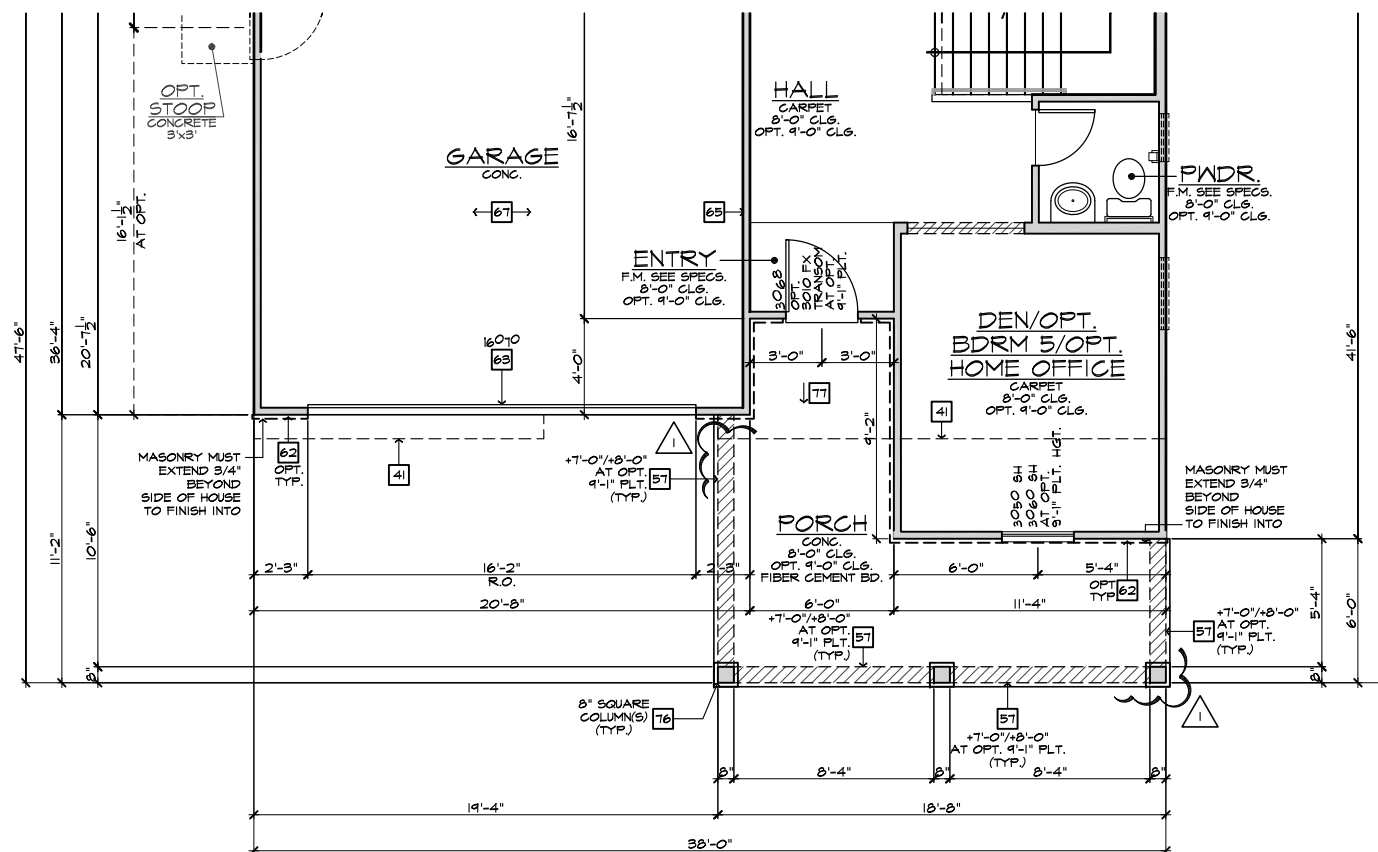

PARTIAL FIRST FLOOR PLAN 'D'

SCALE 1/4"=1'-0" (22"X34") - 1/8"=1'-0" (11"X17")

BASIC PLAN

NOTE: REFER TO BASIC FLOOR PLAN FOR INFORMATION NOT SHOWN HERE

These designs and drawings are CONFIDENTIAL, and the exclusive property of KB Home Corporation, and are not to be disclosed without the express permission of KB Home Corporation. They may not be used or duplicated without the express permission of KB Home Corporation. Copyright 2014 © KB Home Corporation, all rights reserved.

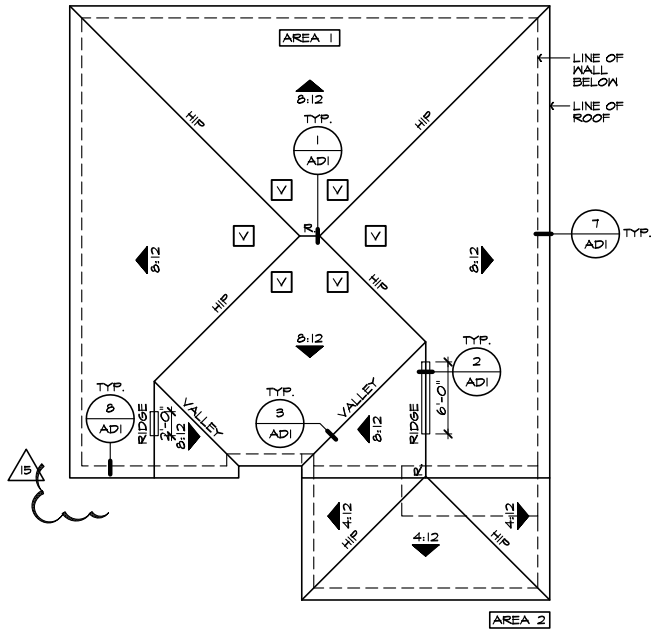

ROOF PLAN 'D'
SCALE 1/8"=1'-0" (22'x34') - 1/16"=1'-0" (11'x17')

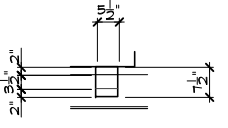

DETAIL 'C'
SCALE: N.T.S.

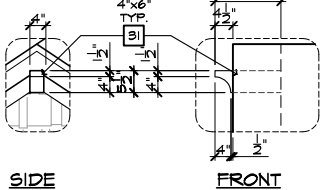

DETAIL 'B'
SCALE: N.T.S.

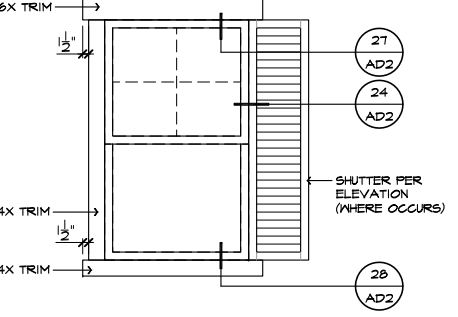

DETAIL 'A'
SCALE: N.T.S.

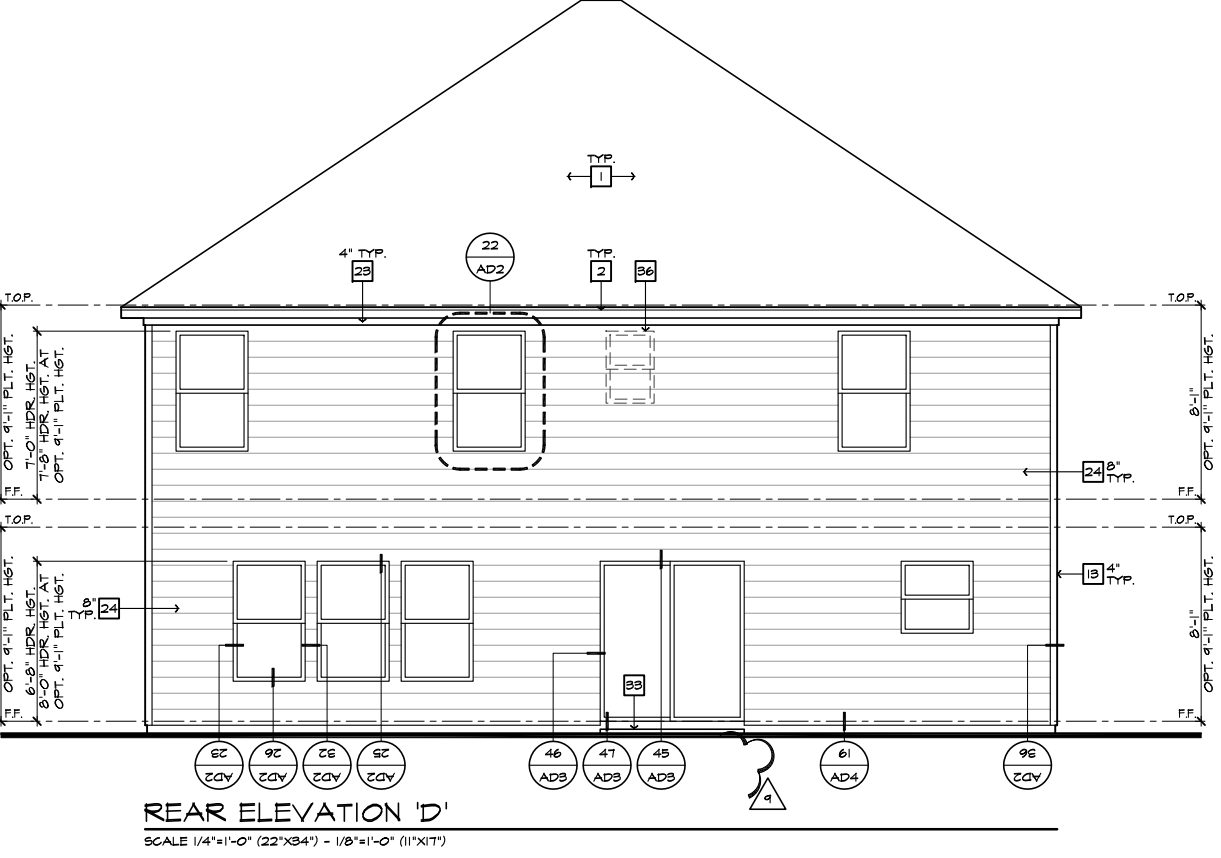

REAR ELEVATION 'D'
SCALE 1/4"=1'-0" (22'x34') - 1/8"=1'-0" (11'x17')

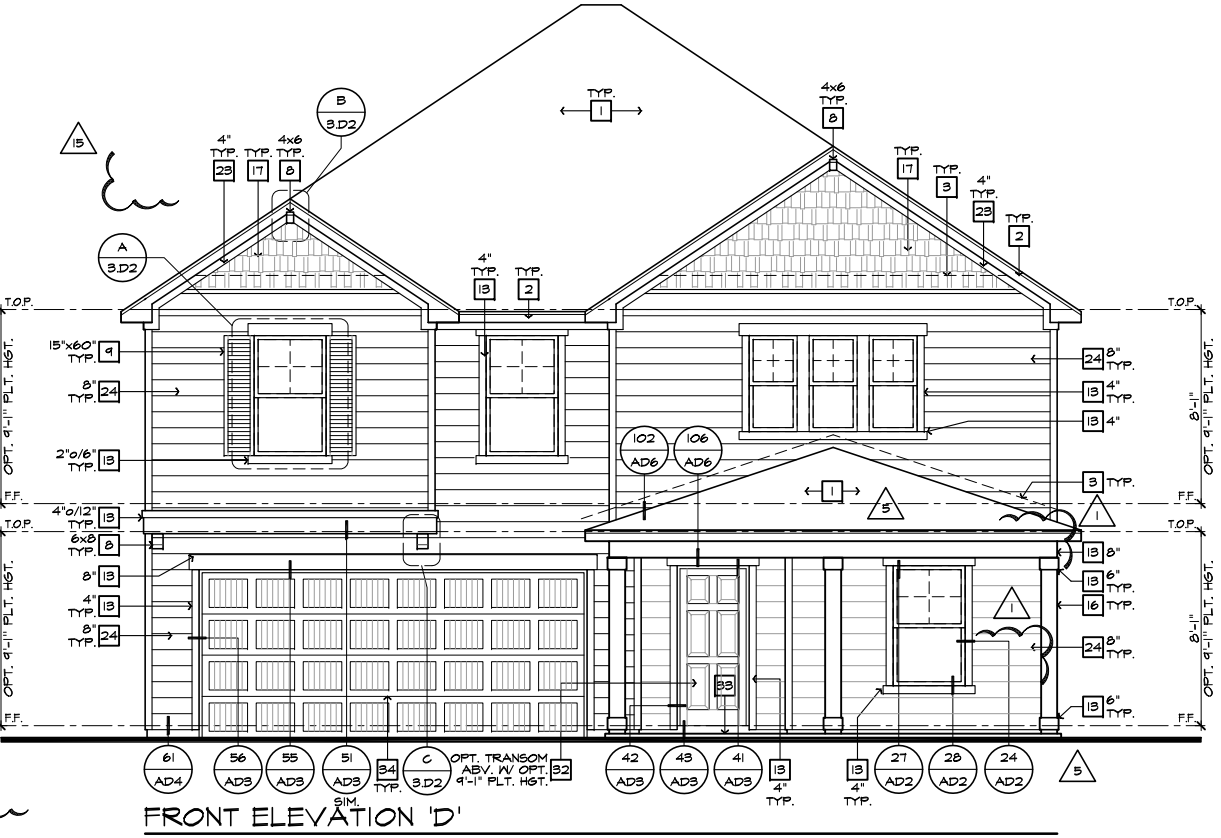

FRONT ELEVATION 'D'
SCALE 1/4"=1'-0" (22'x34') - 1/8"=1'-0" (11'x17')

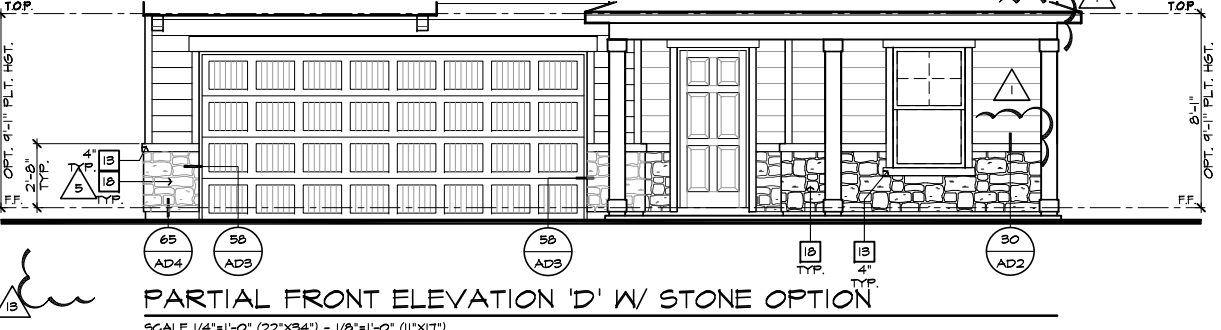

PARTIAL FRONT ELEVATION 'D' W/ STONE OPTION
SCALE 1/4"=1'-0" (22'x34') - 1/8"=1'-0" (11'x17')

- ELEVATION NOTES**
- NOTE: NOT ALL KEY NOTES APPLY.
- ROOF MATERIAL - REFER TO ROOF NOTES
 - 2X FASCIA/BARGE BOARD WITH FASCIA CAP
 - 6:1 FLASHING
 - 6:1 FLASHING & SADDLE/CRICKET
 - 6:1 DRIP SCREED
 - 24"x24" CHIMNEY
 - DECORATIVE VENT
 - DECORATIVE CORBEL
 - DECORATIVE SHUTTERS
 - PEDIMENT. SEE ELEVATION FOR TYPE
 - RECESSED ELEMENT
 - DECORATIVE TRIM FYPON OR EQ. SEE ELEVATION FOR TYPE
 - TRIM PER SPEC- SEE ELEVATION FOR SIZE
 - EXTERIOR FIBER CEMENT PANEL (BEADED OR SMOOTH)
 - PRE-MANUFACTURED DECORATIVE COLUMN (SIZE, SEE ELEV.) FYPON OR EQ. SURROUNDING STRUCTURAL POST.
 - SITE-BUILT COLUMN - SEE ELEVATION FOR TYPE
 - FIBER-CEMENT STRAIGHT SHAKE SIDING SEE SPECS
 - STONE VENEER PER SPECS
 - BRICK/MASONRY VENEER PER SPECS
 - BUILT UP BRICK COLUMN
 - SOLDIER COURSE
 - ROCKLOCK COURSE
 - FRIEZE BOARD
 - FIBER-CEMENT SIDING PER SPECS
 - P.T. POST W/ WRAP - SEE STRUCTURAL FOR SIZE
 - PRE-FAB DECORATIVE TRIM
 - LIGHT WEIGHT PRECAST STONE TRIM
 - P.T. LUMBER RAILINGS (36" U.N.O.)
 - FIBER-CEMENT SMOOTH BOARD SEE SPECS
 - DECORATIVE WINDOW/DOOR TRIM - FYPON OR EQ. SEE ELEVATION FOR SIZE.
 - BRACKET OR KICKER - FYPON OR EQ.
 - ENTRY DOOR
 - CONCRETE STOOP/ PORCH - SEE SLAB INTERFACE PLAN.
 - SECTIONAL GARAGE DOOR PER SPECS
 - ALUMINUM WRAP
 - OPTIONAL DOOR/WINDOW - REFER TO PLAN OPTIONS
 - OPTIONAL STANDING SEAM METAL ROOF
 - KEYSTONE
 - SOLDIER CROWN
 - JACK SOLDIER COURSE
 - WATER TABLE
 - ATRIUM DOOR
 - PILASTER - SEE ELEVATION FOR TYPE

ROOF PLAN NOTES 'D'

INDICATES ROOF SLOPE AND DIRECTION, U.N.O.

8:12

ROOF MATERIAL: COMPOSITION SHINGLE

12" (INCHES) TYPICAL ROOF OVERHANGS AT RAKE, U.N.O.

12" (INCHES) TYPICAL ROOF OVERHANGS AT EAVE, U.N.O.

LOCATE EAVE/ RAFTER VENTS EQUALLY BALANCED AROUND HOUSE EXCEPT ABOVE SHEARWALL PANELS.

ATTIC VENT CALCULATIONS

PROVIDE 1 SQ. IN. OF VENTILATION PER 300 SQ. IN. OF ATTIC SPACE. PROVIDE THAT AT LEAST 50% & NO MORE THAN 80% OF THE REQ. VENTILATING AREA IS PROVIDED BY VENTILATORS LOCATED IN THE UPPER PORTION OF THE ATTIC, (HIGH VENTING) AT 3'-0" ABOVE EAVE VENT WITH THE BALANCE BEING PROVIDED BY EAVE VENTS. (LOW VENTING) (2018 N.C.-R 806.2)

* CALCULATION BY 1/50 HIGH/LOW VENTING NOT REQUIRED.

APPROXIMATE RIDGE VENT LOCATIONS SHOWN.

ACTUAL LOCATIONS TO BE DETERMINED IN THE FIELD.

AREA 1 / MAIN:	
VENTILATION REQUIRED:	SO. FT. / 300 4.70 SQ. FT.
ATTIC AREA = 1411	X 144 = 671 SQ. IN.
	TOTAL HIGH & LOW = 671 SQ. IN.
	X 50% = 339 SQ. IN.
VENTILATION PROVIDED:	
High	
6	LF RIDGE VENT(S) AT 18 SQ. IN. / LF. = 144 SQ. IN.
	ROOF VENT(S) AT 50 SQ. IN. EA. = 300 SQ. IN.
	SUB-TOTAL HIGH VENTILATION: 444 SQ. IN.
Low	
58	LF VENTILATED SOFFIT AT 6.9 SQ. IN. / LF. = 400 SQ. IN.
	ROOF VENT(S) AT 50 SQ. IN. EA. = 0 SQ. IN.
	SUB-TOTAL LOW VENTILATION: 400 SQ. IN.
	TOTAL VENTILATION PROVIDED: 844 SQ. IN.
AREA 2 / PORCH:	
VENTILATION REQUIRED:	SO. FT. / 150 1.27 SQ. FT.
ATTIC AREA = 190	X 144 = 182 SQ. IN.
	TOTAL HIGH & LOW = 182 SQ. IN.
VENTILATION PROVIDED:	
(27)	LF VENTILATED SOFFIT AT 6.9 SQ. IN. / LF. = 186 SQ. IN.
(0)	LF RIDGE VENT(S) AT 18 SQ. IN. EA. = 0 SQ. IN.
	TOTAL VENTILATION PROVIDED: 186 SQ. IN.

NOTES:

ALL VENT OPENINGS SHALL BE COVERED WITH 1/4" CORROSION RESISTANT METAL MESH.

FRAMER SHALL BE RESPONSIBLE FOR COORDINATING WITH TRUSS MANUFACTURER TO ACCOMMODATE ALL ATTIC VENTS.

ALL VENTS SHALL BE INSTALLED SO AS TO MAKE THEM WATER-PROOF & WALL MOUNTED LOUVERS SHALL BE SEALED & FLASHED W/ MOISTOP IN THE SAME MANNER PRESCRIBED FOR WINDOW INSTALLATION.

PROVIDE APPROVED INSULATION DAMS (BAFFLES) WHERE VENT BLOCKS ARE USED BETWEEN ROOF FRAMING MEMBERS TO PREVENT VENT HOLES FROM BEING BLOCKED BY INSULATION.

LOCATE HIGH VENTING MINIMUM 3'-0" VERTICAL DISTANCE ABOVE EAVES.

WHEN GABLE END TRUSS MEMBERS BLOCK GABLE END VENTS, PROVIDE ADEQUATE ADDITIONAL VENTILATION BY MEANS OF ROOF TILE VENTS.



NORTH CAROLINA 40' SERIES

KB HOME
NORTH CAROLINA DIVISION

4518 S. MIAMI BLVD.
SUITE 180
DURHAM, NC 27703
TEL: (919) 768-7988
FAX: (919) 472-0582

2018 NORTH CAROLINA STATE BUILDING CODES

- ISSUE DATE: 01/08/15
- PROJECT No.: 1350999:56
- DIVISION MGR.: DCS
- REVISIONS: 08/20/20
- 11 DIVISION REVISION NC20054NCP - 08/28/20 - FAB
 - 12 DIVISION REVISION NC20057NCP - 09/16/20 - FAB
 - 13 DIVISION REVISION NC20093NCP - 12/19/20 - CL
 - 14 VENTILATION NC20068NCP - 01/17/20 - CL
 - 15 DIVISION REVISION NC20013NCP - 02/10/20 - MCP
 - 16 DIVISION REVISION NC20017NCP - 03/04/20 - KBA
 - 17 HOME OFFICE CORP20053CORP-04/20/20-CTD
 - 18 ADD NOTE TO TP NC20057NCP - 10/06/20 - KBA
 - 19 DIVISION REQ. REVISION NC21005NCP - 01/06/21 - KBA

PLAN: 238.2338

SHEET: 3.D2

SPEC. LEVEL 1 RALEIGH-DURHAM 40' SERIES

These designs and drawings are CONFIDENTIAL, and the exclusive property of KB Home Corporation and are not to be disclosed without the express permission of KB Home Corporation. Copyright 2014 © KB Home Corporation. All rights reserved.

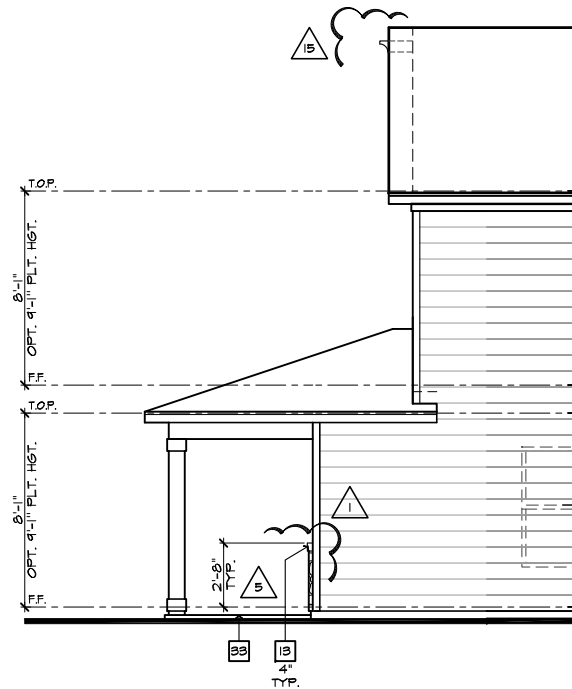

PARTIAL RIGHT ELEVATION 'D'
W/ STONE OPTION

SCALE 1/4"=1'-0" (22'x34") - 1/8"=1'-0" (11'x17")

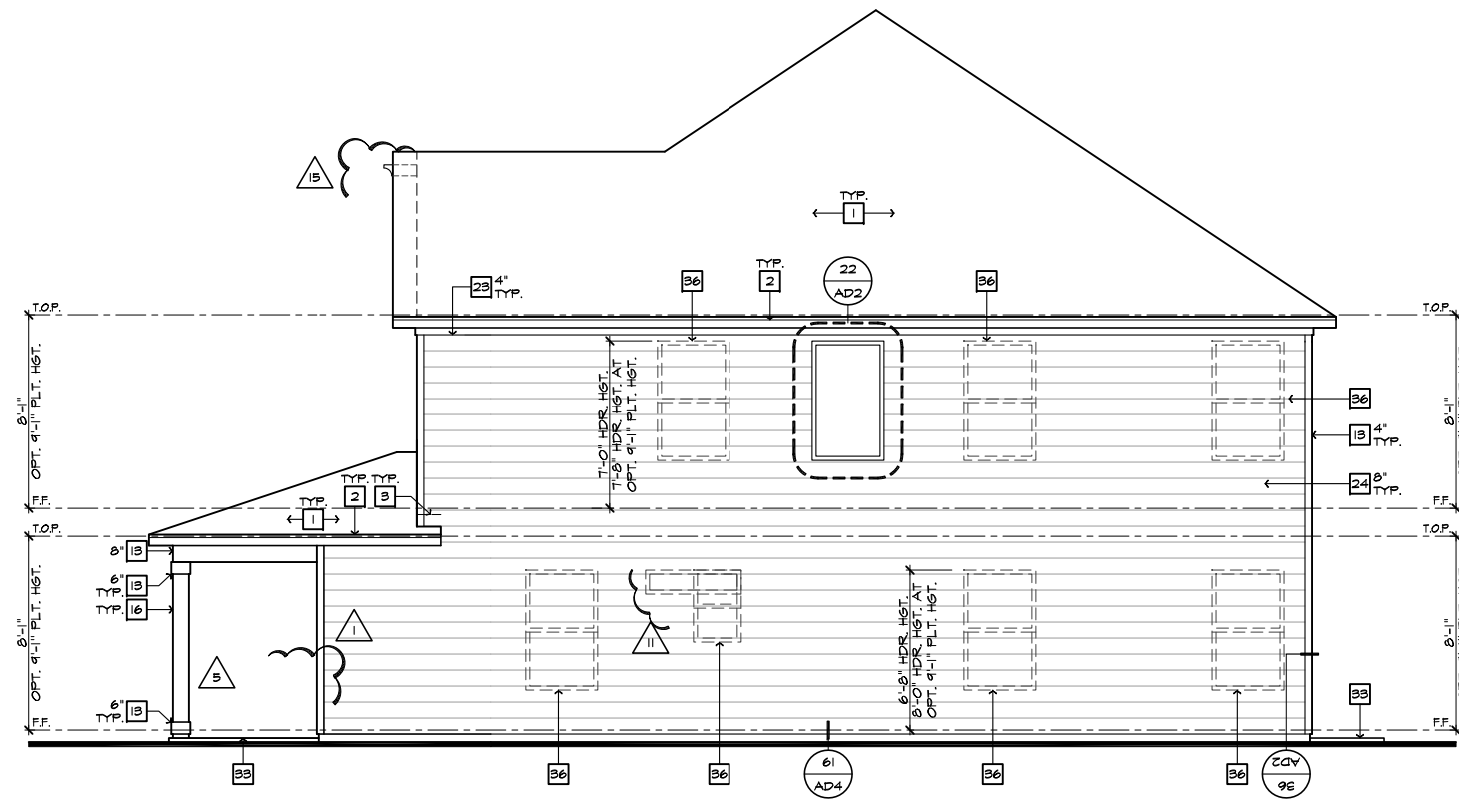

RIGHT ELEVATION 'D'

SCALE 1/4"=1'-0" (22'x34") - 1/8"=1'-0" (11'x17")

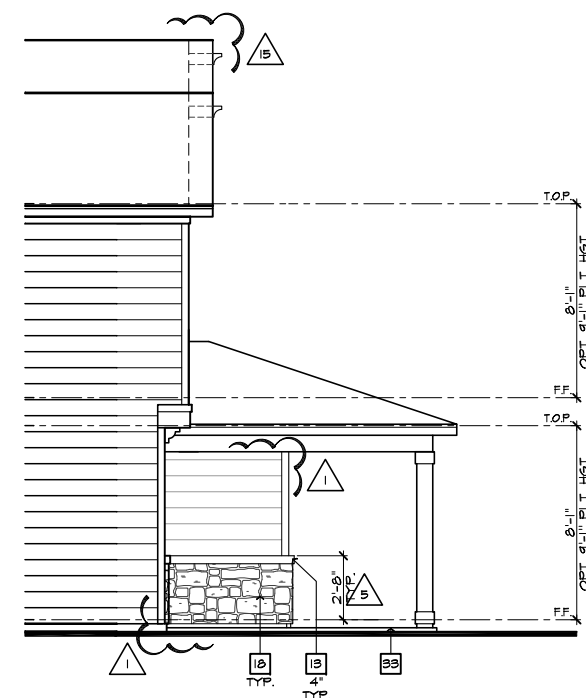

PARTIAL LEFT ELEVATION 'D'
W/ STONE OPTION

SCALE 1/4"=1'-0" (22'x34") - 1/8"=1'-0" (11'x17")

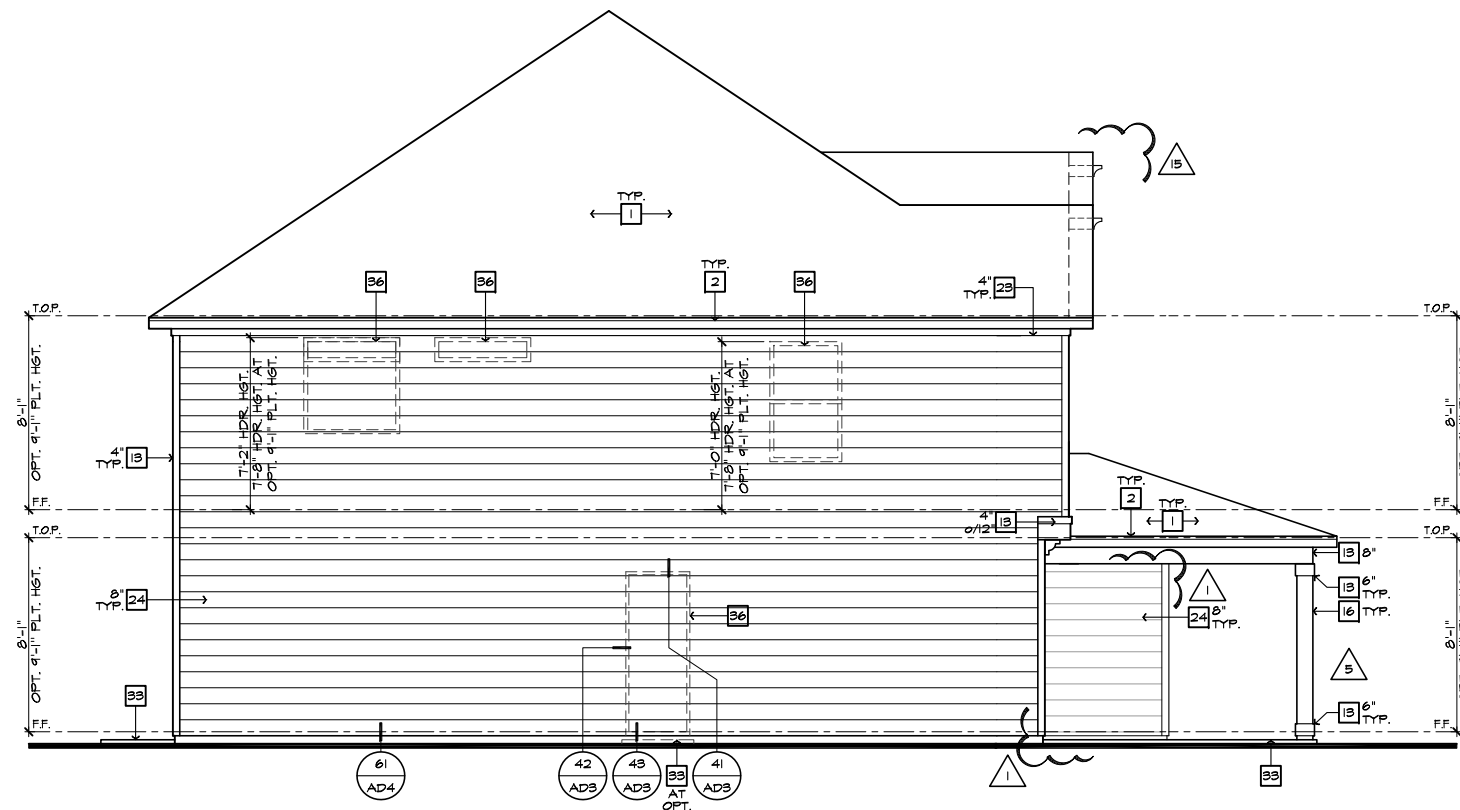

LEFT ELEVATION 'D'

SCALE 1/4"=1'-0" (22'x34") - 1/8"=1'-0" (11'x17")

#	ELEVATION NOTES
NOTE: NOT ALL KEY NOTES APPLY.	
1.	ROOF MATERIAL - REFER TO ROOF NOTES
2.	2X FASCIA/BARGE BOARD WITH FASCIA CAP
3.	6.1. FLASHING
4.	6.1. FLASHING & SADDLE/CRICKET
5.	6.1. DRIP SCREED
6.	24"x24" CHIMNEY
7.	DECORATIVE VENT
8.	DECORATIVE CORBEL
9.	DECORATIVE SHUTTERS
10.	PEDIMENT. SEE ELEVATION FOR TYPE
11.	RECESSED ELEMENT
12.	DECORATIVE TRIM FYPON OR EQ. SEE ELEVATION FOR TYPE
13.	TRIM PER SPEC-- SEE ELEVATION FOR SIZE
14.	EXTERIOR FIBER CEMENT PANEL (BEADED OR SMOOTH)
15.	PRE-MANUFACTURED DECORATIVE COLUMN (SIZE, SEE ELEV.) FYPON OR EQ. SURROUNDING STRUCTURAL POST.
16.	SITE-BUILT COLUMN - SEE ELEVATION FOR TYPE
17.	FIBER-CEMENT STRAIGHT SHAKE SIDING SEE SPECS
18.	STONE VENEER PER SPECS
19.	BRICK/MASONRY VENEER PER SPECS
20.	BUILT UP BRICK COLUMN
21.	SOLDIER COURSE
22.	ROWLOCK COURSE
23.	FRIEZE BOARD
24.	FIBER-CEMENT SIDING PER SPECS
25.	P.T. POST W/ WRAP - SEE STRUCTURAL FOR SIZE
26.	PRE-FAB DECORATIVE TRIM
27.	LIGHT WEIGHT PRECAST STONE TRIM
28.	P.T. LUMBER RAILINGS (36" U.N.O.)
29.	FIBER-CEMENT SMOOTH BOARD SEE SPECS
30.	DECORATIVE WINDOW/DOOR TRIM - FYPON OR EQ. SEE ELEVATION FOR SIZE.
31.	BRACKET OR KICKER - FYPON OR EQ.
32.	ENTRY DOOR
33.	CONCRETE STOOP/ PORCH - SEE SLAB INTERFACE PLAN.
34.	SECTIONAL GARAGE DOOR PER SPECS
35.	ALUMINUM WRAP
36.	OPTIONAL DOOR/WINDOW - REFER TO PLAN OPTIONS
37.	OPTIONAL STANDING SEAM METAL ROOF
38.	KEYSTONE
39.	SOLDIER CROWN
40.	JACK SOLDIER COURSE
41.	WATER TABLE
42.	ATRIUM DOOR
43.	PILASTER - SEE ELEVATION FOR TYPE

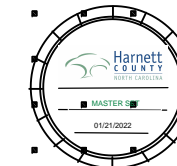
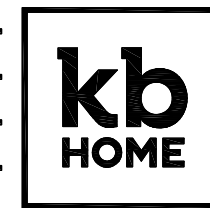

**NORTH CAROLINA
40' SERIES**

KB HOME
NORTH CAROLINA DIVISION

4518 S. MIAMI BLVD.
SUITE 180
DURHAM, NC 27703
TEL: (919) 768-7988
FAX: (919) 472-0582

**2018 NORTH
CAROLINA STATE
BUILDING
CODES**

ISSUE DATE: 01/08/15
PROJECT No.: 1350999:56
DIVISION MGR.: DCS
REVISIONS: 08/20/20

- 11 DIVISION REVISION NC19654NCP - 08/28/19 - FAE
- 12 DIVISION REVISION NC19657NCP - 09/26/19 - FAE
- 13 DIVISION REVISION NC20003NCP - 12/19/19 - CL
- 14 VENTILATION NC20008NCP - 01/17/20 - CL
- 15 DIVISION REVISION NC20013NCP - 02/10/20 - MCP
- 16 DIVISION REVISION NC20017NCP - 03/04/20 - KBA
- 17 HOME OFFICE CORP20009CORP-08/20/20-CTD
- 18 ADD NOTE TO TF NC20037NCP - 10/06/20 - KBA
- 19 DIVISION REQ REVISION NC21005NCP - 01/06/21 - KBA

PLAN:
238.2338

SHEET:
3.D3

**SPEC. LEVEL 1
RALEIGH-DURHAM
40' SERIES**



**NORTH CAROLINA
40' SERIES**

KB HOME
NORTH CAROLINA DIVISION
4518 S. MIAMI BLVD.
SUITE 180
DURHAM, NC 27703
TEL: (919) 768-7988
FAX: (919) 472-0582

**2018 NORTH
CAROLINA STATE
BUILDING
CODES**

- ISSUE DATE: 01/08/15
PROJECT No.: 1350999:56
DIVISION MGR.: DCS
REVISIONS: 08/20/20
- 11 DIVISION REVISION NC19654NCP - 08/28/19 - FAE
 - 12 DIVISION REVISION NC19657NCP - 09/26/19 - FAE
 - 13 DIVISION REVISION NC20003NCP - 12/19/19 - CL
 - 14 VENTILATION NC20008NCP - 01/17/20 - CL
 - 15 DIVISION REVISION NC20013NCP - 02/10/20 - MCP
 - 16 DIVISION REVISION NC20017NCP - 03/04/20 - KBA
 - 17 HOME OFFICE CORP210093CORP-08/20/20-CTD
 - 18 ADD NOTE TO TF NC20007NCP - 10/06/20 - KBA
 - 19 DIVISION REQ. REVISION NC21005NCP - 01/06/21 - KBA

PLAN:
238.2338
SHEET:
3.D4
SPEC. LEVEL 1
**RALEIGH-DURHAM
40' SERIES**

#	ELEVATION NOTES
NOTE: NOT ALL KEY NOTES APPLY.	
1.	ROOF MATERIAL - REFER TO ROOF NOTES
2.	2X FASCIA/BARGE BOARD WITH FASCIA CAP
3.	6.1. FLASHING
4.	6.1. FLASHING & SADDLE/CRICKET
5.	6.1. DRIP SCREED
6.	24"x24" CHIMNEY
7.	DECORATIVE VENT
8.	DECORATIVE CORBEL
9.	DECORATIVE SHUTTERS
10.	PEDIMENT. SEE ELEVATION FOR TYPE
11.	RECESSED ELEMENT
12.	DECORATIVE TRIM FYPON OR EQ. SEE ELEVATION FOR TYPE
13.	TRIM PER SPEC - SEE ELEVATION FOR SIZE
14.	EXTERIOR FIBER CEMENT PANEL (BEADED OR SMOOTH)
15.	PRE-MANUFACTURED DECORATIVE COLUMN (SIZE, SEE ELEV.) FYPON OR EQ. SURROUNDING STRUCTURAL POST.
16.	SITE-BUILT COLUMN - SEE ELEVATION FOR TYPE
17.	FIBER-CEMENT STRAIGHT SHAKE SIDING SEE SPECS
18.	STONE VENEER PER SPECS
19.	BRICK/MASONRY VENEER PER SPECS
20.	BUILT UP BRICK COLUMN
21.	SOLDIER COURSE
22.	ROCKLOCK COURSE
23.	FRIEZE BOARD
24.	FIBER-CEMENT SIDING PER SPECS
25.	P.T. POST W/ WRAP - SEE STRUCTURAL FOR SIZE
26.	PRE-FAB DECORATIVE TRIM
27.	LIGHT WEIGHT PRECAST STONE TRIM
28.	P.T. LUMBER RAILINGS (36" U.N.O.)
29.	FIBER-CEMENT SMOOTH BOARD SEE SPECS
30.	DECORATIVE WINDOW/DOOR TRIM - FYPON OR EQ. SEE ELEVATION FOR SIZE.
31.	BRACKET OR KICKER - FYPON OR EQ.
32.	ENTRY DOOR
33.	CONCRETE STOOFF/ PORCH - SEE SLAB INTERFACE PLAN.
34.	SECTIONAL GARAGE DOOR PER SPECS
35.	ALUMINUM WRAP
36.	OPTIONAL DOOR/WINDOW - REFER TO PLAN OPTIONS
37.	OPTIONAL STANDING SEAM METAL ROOF
38.	KEYSTONE
39.	SOLDIER CROWN
40.	JACK SOLDIER COURSE
41.	WATER TABLE
42.	ATRIUM DOOR
43.	PILASTER - SEE ELEVATION FOR TYPE

#	PARTIAL PLAN NOTES
NOTE: NOT ALL KEY NOTES APPLY.	
27.	WATER HEATER LOCATION - FOR GAS - LOCATE ON 15" HIGH PLATFORM - FOR INTERIOR LOCATION - PROVIDE PAN & DRAIN (REFER TO DETAILS)
28.	WATER HEATER B VENT TO OUTSIDE AIR
29.	MAIN LINE SHUT-OFF VALVE AND TEMP. & PRESSURE RELIEF VALVE
34.	LINE OF WALL BELOW
41.	LINE OF FLOOR ABOVE
42.	LINE OF FLOOR BELOW
43.	LINE 36" HIGH GUARDRAIL (REFER TO DETAIL SHEETS)
50.	A/C PAD LOCATION
51.	LOW WALL - REFER TO PLAN FOR HEIGHT
52.	2x6 STUD WALL
54.	DEL. 2x4 WALL PER PLAN
55.	INTERIOR SHELF - REFER TO PLAN FOR HEIGHT
57.	FLAT SOFFIT
58.	ARCHED SOFFIT
60.	OPT. DOOR/WINDOW
61.	PRE-MANUFACTURED DECORATIVE COLUMN (SIZE, SEE ELEV.) FYPON OR EQ. SURROUNDING STRUCTURAL POST.
62.	BRICK / STONE VENEER - REFER TO ELEVATIONS
63.	SECTIONAL GARAGE DOOR PER SPECS
66.	3" DIAM. CONCRETE FILLED PIPE BOLLARD 36" HIGH WITH MIN. 12" EMBEDMENT INTO CONCRETE. (NOT REQUIRED AT ELECTRIC WATER HEATERS OR FOR APPLIANCES LOCATED OUT OF THE VEHICLE'S NORMAL TRAVEL PATH).
68.	P.T. POST W/ WRAP.
70.	EGRESS WINDOW
75.	WINDOW LEDGE. HEIGHT & WIDTH OF OPENING TO EXTEND 6" BEYOND WINDOW(S) ON ALL SIDES U.N.O.
76.	SITE-BUILT COLUMN - SEE ELEVATION FOR TYPE
77.	CONCRETE SLAB. SLOPE 1/4" PER FT. MIN. SEE PLAN FOR SIZE.

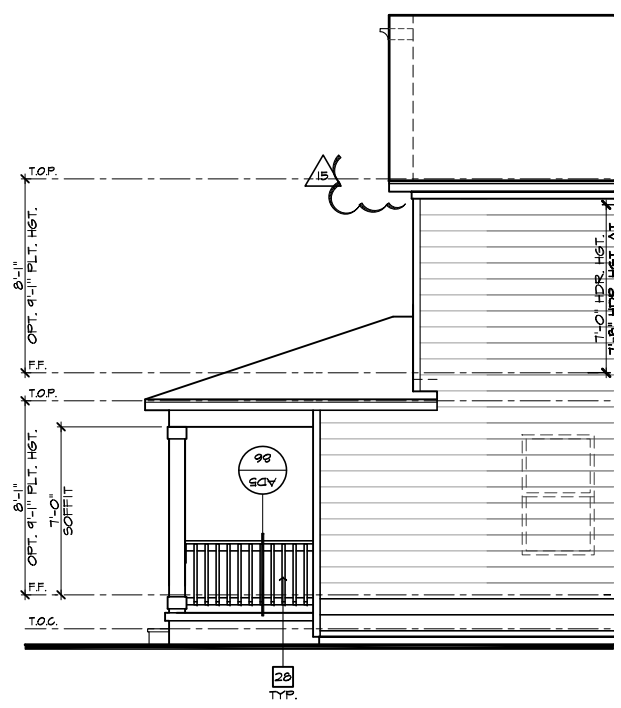

**PARTIAL
RIGHT ELEVATION 'D' AT CRAWL SPACE**
SCALE 1/4"=1'-0" (22"x34") - 1/8"=1'-0" (11"x17")



FRONT ELEVATION 'D' W/ CRAWL SPACE
SCALE 1/4"=1'-0" (22"x34") - 1/8"=1'-0" (11"x17")

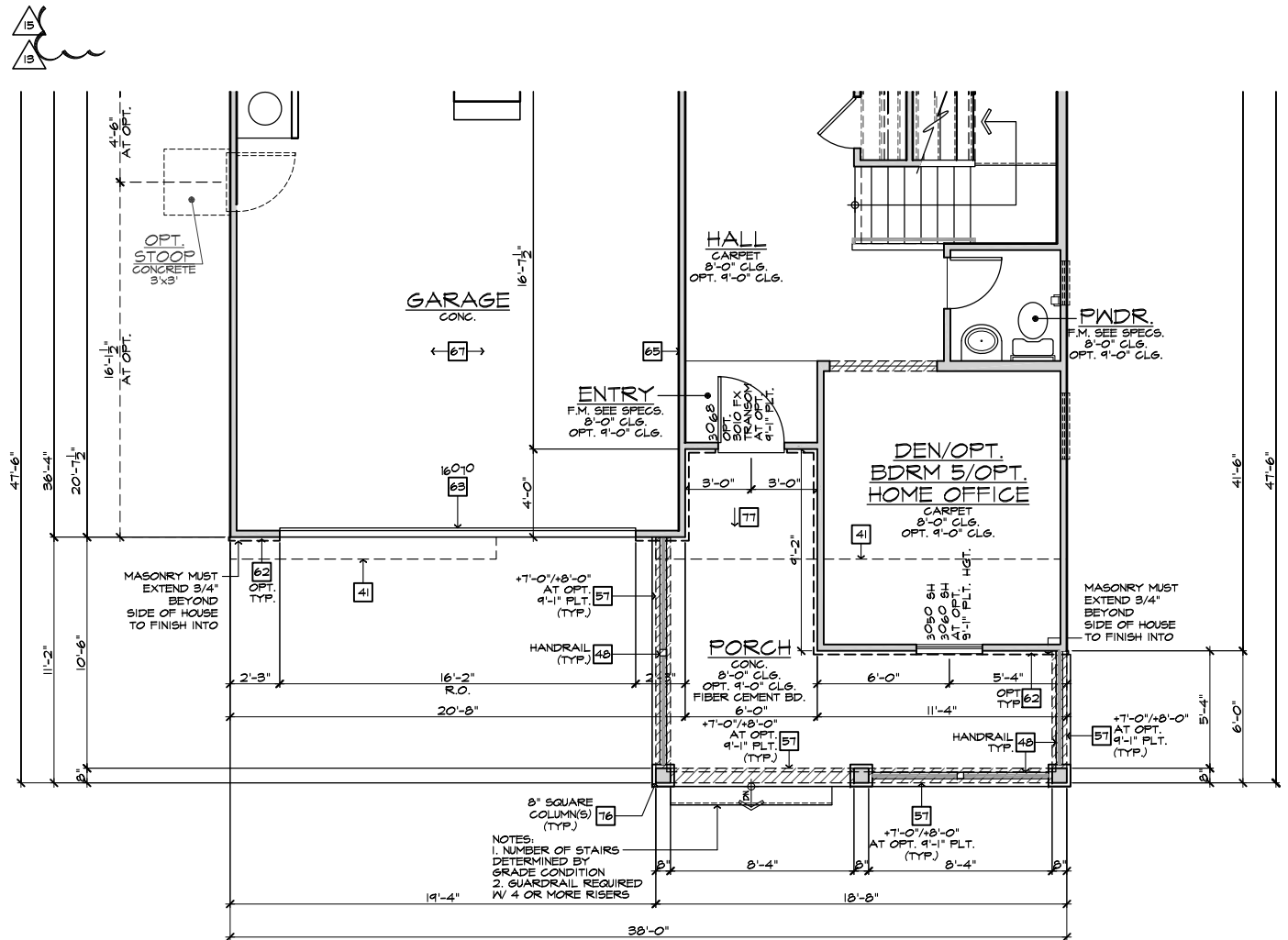

PARTIAL FIRST FLOOR PLAN 'D' AT CRAWL SPACE
SCALE 1/4"=1'-0" (22"x34") - 1/8"=1'-0" (11"x17")

NOTE:
REFER TO BASIC ELEVATIONS FOR INFORMATION NOT SHOWN HERE

NOTE:
REFER TO BASIC FLOOR PLAN FOR INFORMATION NOT SHOWN HERE

These designs and drawings are CONFIDENTIAL, and the exclusive property of KB Home Corporation, and are not to be disclosed without the express permission of KB Home Corporation. Copyright 2014 © KB Home Corporation, all rights reserved.

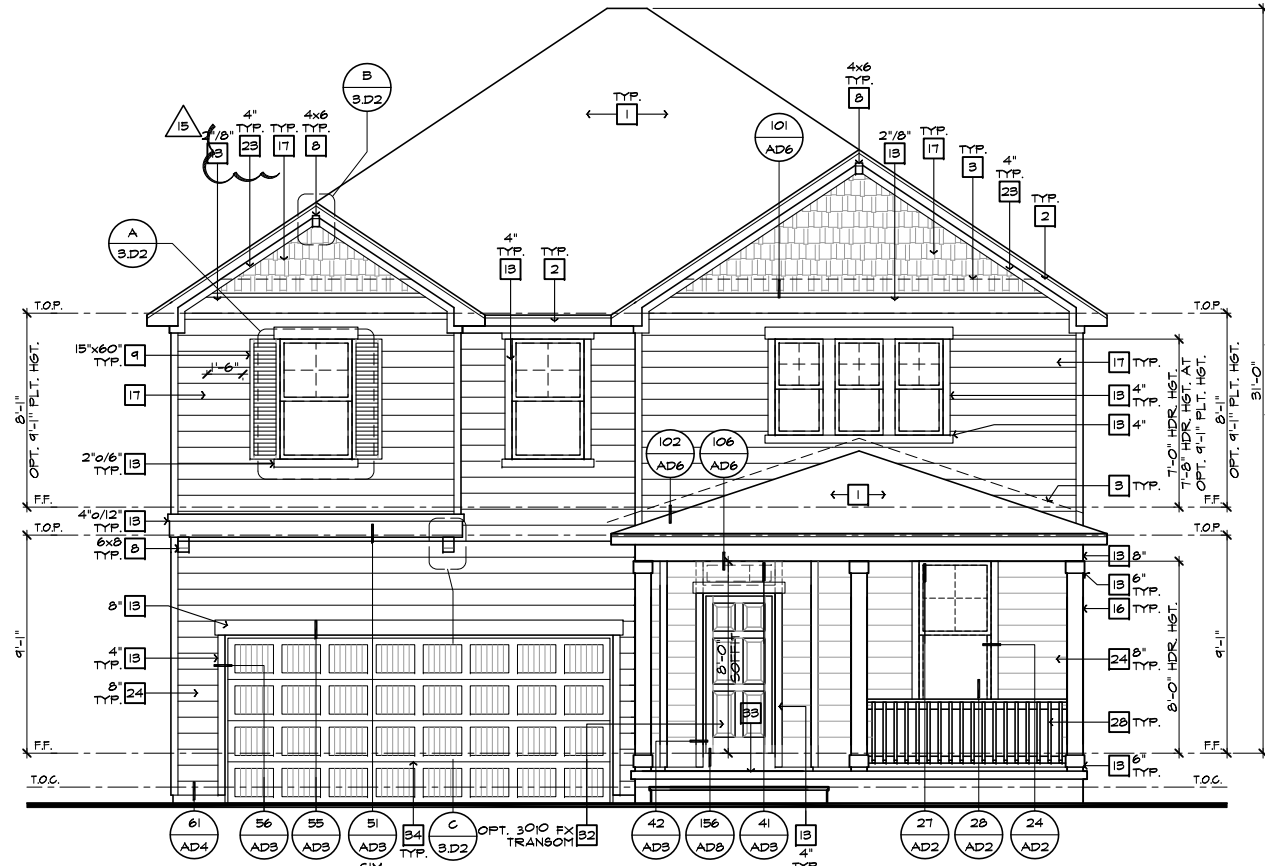

FRONT ELEVATION 'D' W/ CRAWL SPACE
AT OPTIONAL 9'-1" PLT. HGT.

SCALE 1/4"=1'-0" (22'x34") - 1/8"=1'-0" (11'x17")



FRONT ELEVATION 'D'
AT OPTIONAL 9'-1" PLT. HGT.

SCALE 1/4"=1'-0" (22'x34") - 1/8"=1'-0" (11'x17")

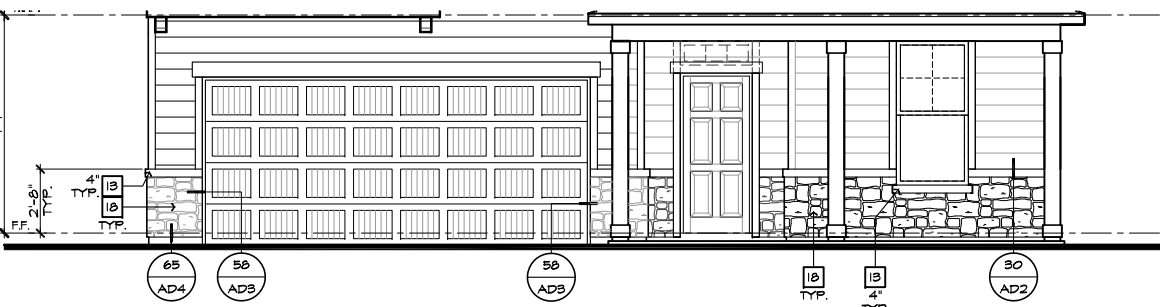

PARTIAL FRONT ELEVATION 'D'
AT OPTIONAL 9'-1" PLT. HGT. W/ STONE OPT.

SCALE 1/4"=1'-0" (22'x34") - 1/8"=1'-0" (11'x17")

#	ELEVATION NOTES
NOTE: NOT ALL KEY NOTES APPLY.	
1.	ROOF MATERIAL - REFER TO ROOF NOTES
2.	2X FASCIA/BARGE BOARD WITH FASCIA CAP
3.	6.1. FLASHING
4.	6.1. FLASHING & SADDLE/CRICKET
5.	6.1. DRIP SCREED
6.	24"x24" CHIMNEY
7.	DECORATIVE VENT
8.	DECORATIVE CORBEL
9.	DECORATIVE SHUTTERS
10.	PEDIMENT - SEE ELEVATION FOR TYPE
11.	RECESSED ELEMENT
12.	DECORATIVE TRIM FYPON OR EQ. SEE ELEVATION FOR TYPE
13.	TRIM PER SPEC - SEE ELEVATION FOR SIZE
14.	EXTERIOR FIBER CEMENT PANEL (BEADED OR SMOOTH)
15.	PRE-MANUFACTURED DECORATIVE COLUMN (SIZE, SEE ELEV.) FYPON OR EQ. SURROUNDING STRUCTURAL POST.
16.	SITE-BUILT COLUMN - SEE ELEVATION FOR TYPE
17.	FIBER-CEMENT STRAIGHT SHAKE SIDING SEE SPECS
18.	STONE VENEER PER SPECS
19.	BRICK/MASONRY VENEER PER SPECS
20.	BUILT UP BRICK COLUMN
21.	SOLDIER COURSE
22.	RONLOCK COURSE
23.	FRIEZE BOARD
24.	FIBER-CEMENT SIDING PER SPECS
25.	P.T. POST W/ WRAP - SEE STRUCTURAL FOR SIZE
26.	PRE-FAB DECORATIVE TRIM
27.	LIGHT WEIGHT PRECAST STONE TRIM
28.	P.T. LUMBER RAILINGS (48" U.N.O.)
29.	FIBER-CEMENT SMOOTH BOARD SEE SPECS
30.	DECORATIVE WINDOW/DOOR TRIM - FYPON OR EQ. SEE ELEVATION FOR SIZE.
31.	BRACKET OR KICKER - FYPON OR EQ.
32.	ENTRY DOOR
33.	CONCRETE STOOP/ PORCH - SEE SLAB INTERFACE PLAN.
34.	SECTIONAL GARAGE DOOR PER SPECS
35.	ALUMINUM WRAP
36.	OPTIONAL DOOR/WINDOW - REFER TO PLAN OPTIONS
37.	OPTIONAL STANDING SEAM METAL ROOF
38.	KEYSTONE
39.	SOLDIER CROWN
40.	JACK SOLDIER COURSE
41.	WATER TABLE
42.	ATRIUM DOOR
43.	PILASTER - SEE ELEVATION FOR TYPE
9'-1" PLATE OPTION	
NOTE: WINDOW SIZES WILL INCREASE BY 1' AT 9'-1" PLATE OPTIONS. HEADER HEIGHTS FOR ALL WINDOWS WILL BE 7'-8" AT 9'-1" PLATE OPTIONS.	

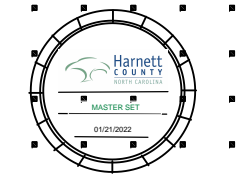

**NORTH CAROLINA
40' SERIES**

KB HOME
NORTH CAROLINA DIVISION
4518 S. MIAMI BLVD.
SUITE 180
DURHAM, NC 27703
TEL: (919) 768-7988
FAX: (919) 472-0582

**2018 NORTH
CAROLINA STATE
BUILDING
CODES**

- ISSUE DATE: 01/08/15
- PROJECT No.: 1350999-56
- DIVISION MGR.: DCS
- REVISIONS: 08/20/20
- 11 DIVISION REVISION NC19654NCP - 08/28/19 - FAE
- 12 DIVISION REVISION NC19657NCP - 09/26/19 - FAE
- 13 DIVISION REVISION NC20003NCP - 12/19/19 - CL
- 14 VENTILATION NC20008NCP - 01/17/20 - CL
- 15 DIVISION REVISION NC20013NCP - 02/10/20 - MCF
- 16 DIVISION REVISION NC20017NCP - 03/04/20 - KBA
- 17 HOME OFFICE CORP22003CORP-08/20/20-CTD
- 18 ADD NOTE TO TF NC20037NCP - 10/06/20 - KBA
- 19 DIVISION RBQ REVISION NC21065NCP - 01/06/21 - KBA

PLAN:
238.2338
SHEET:
3.D5
SPEC. LEVEL 1
**RALEIGH-DURHAM
40' SERIES**

These designs and drawings are CONFIDENTIAL, and the exclusive property of KB Home Corporation and are not to be disclosed without the express permission of KB Home Corporation. Copyright 2014. © KB Home Corporation, all rights reserved.



NORTH CAROLINA 40' SERIES

KB HOME
NORTH CAROLINA DIVISION
4506 S. MIAMI BLVD.
SUITE 180
DURHAM, NC 27703
TEL: (919) 768-7980
FAX: (919) 544-2928

2018 NORTH CAROLINA STATE BUILDING CODES

- ISSUE DATE: 01/08/15
- PROJECT No.: 1350999:56
- DIVISION MGR.: DCS
- REVISIONS: 08/20/20
- 11 DIVISION REVISION NC13654NCP - 08/28/19 - FAE
- 12 DIVISION REVISION NC13657NCP - 09/26/19 - FAE
- 13 DIVISION REVISION NC20003NCP - 12/19/19 - CL
- 14 VENTILATION NC20008NCP - 01/17/20 - CL
- 15 DIVISION REVISION NC20013NCP - 02/10/20 - MCP
- 16 DIVISION REVISION NC20017NCP - 03/04/20 - KBA
- 17 HOME OFFICE CORP20009CORP-08/20/20-CTD

FOR INTERNAL USE ONLY	
REVIEWED BY:	
1.	
2.	
3.	
4.	
5.	
6.	

PLAN: 238.2338
SHEET: 4.1

SPEC. LEVEL 1 RALEIGH-DURHAM 40' SERIES

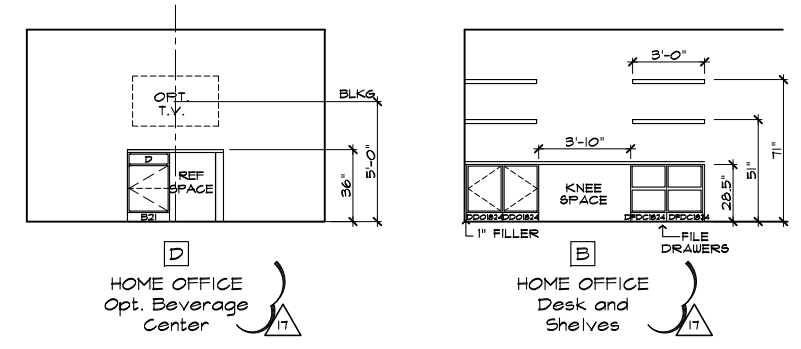

MISC. ELEVATIONS

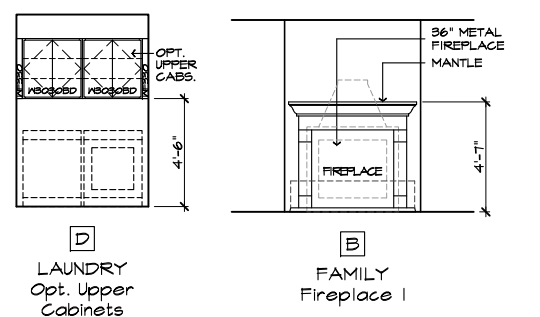

INTERIOR ELEVATIONS

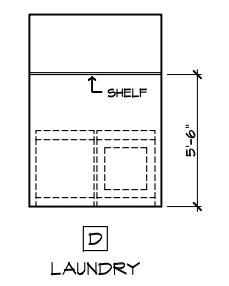

INTERIOR ELEVATIONS

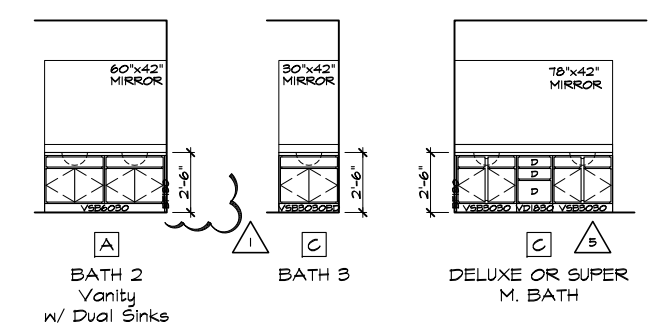

BATH ELEVATIONS

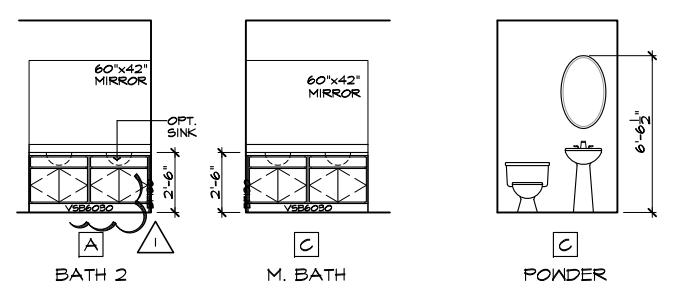

BATH ELEVATIONS

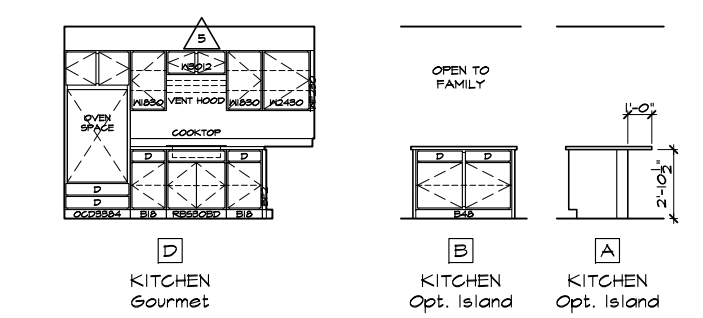

KITCHEN ELEVATIONS

OPTIONAL INTERIOR ELEVATIONS

SCALE: 1/4"=1'-0" (22"x34") - 1/8"=1'-0" (11"x17")

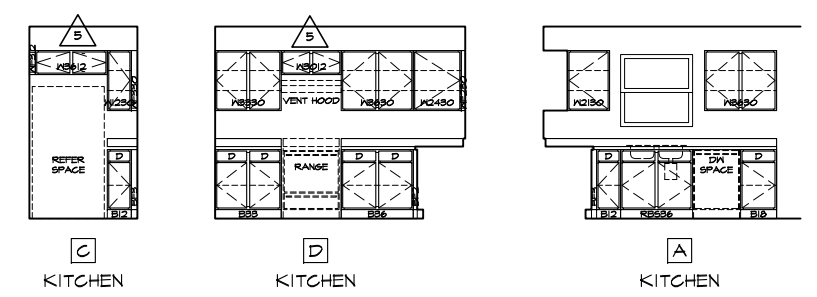

KITCHEN ELEVATIONS

INTERIOR ELEVATIONS

SCALE: 1/4"=1'-0" (22"x34") - 1/8"=1'-0" (11"x17")

These designs and drawings are CONFIDENTIAL, and the exclusive property of KB Home Corporation and are not to be disclosed without the express permission of KB Home Corporation. Copyright 2020 © KB Home Corporation, all rights reserved.

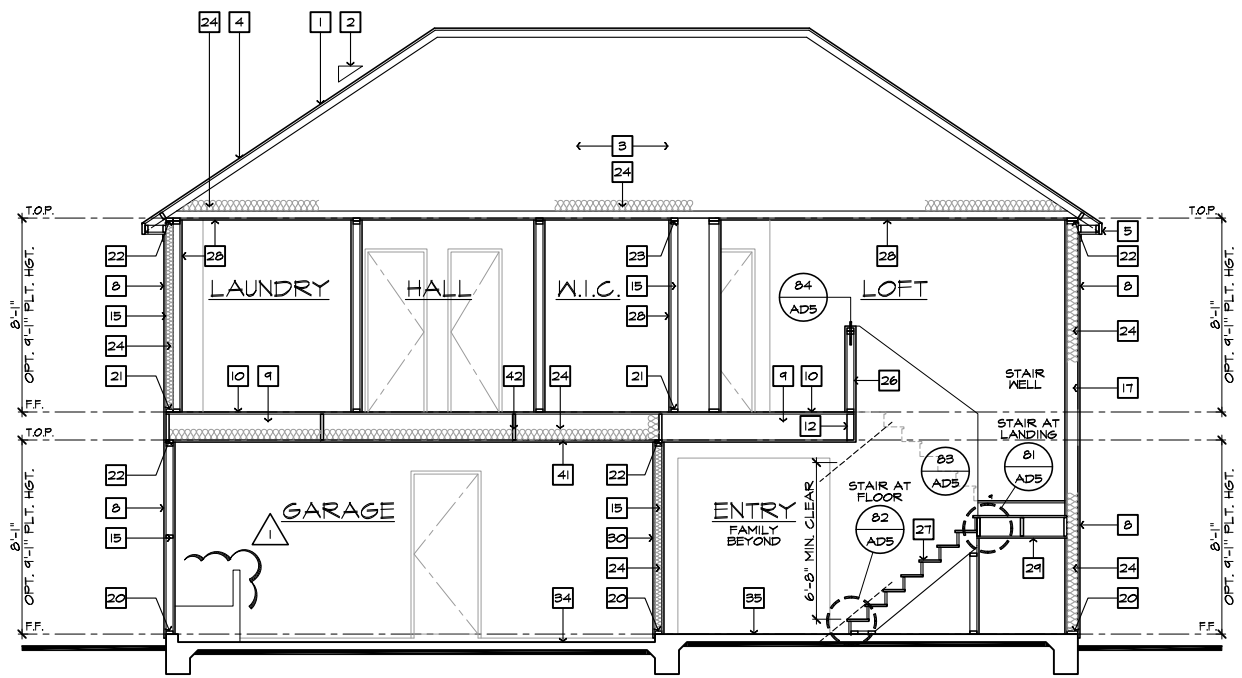

SECTION "A"
SCALE 1/4"=1'-0" (22"X34") - 1/8"=1'-0" (11"X17")

AT SLAB-ON-GRADE

- # SECTION NOTES**
- NOTE: NOT ALL KEY NOTES APPLY.
1. ROOF MATERIAL - REFER TO ROOF NOTES
 2. ROOF PITCH - REFER TO ROOF NOTES
 3. PRE-MANUFACTURED WOOD ROOF TRUSS SYSTEM - SEE STRUCTURAL & TRUSS CALCS
 4. ROOF SHEATHING PER STRUCTURAL
 5. 2x FASCIA/BARGE BOARD
 6. CONT. SOFFITED EAVE W/ VENTING
 7. 6.1. FLASHING - ROOF TO WALL
 8. EXTERIOR FINISH PER ELEVATIONS
 9. FLOOR FRAMING PER STRUCTURAL
 10. FLOOR SHEATHING PER STRUCTURAL
 11. HEADER PER STRUCTURAL
 12. FLUSH BEAM PER STRUCTURAL
 13. DROPPED BEAM PER STRUCTURAL
 14. FLAT/ ARCHED SOFFIT PER PLAN
 15. 2x4 STUD WALL
 16. 2x6 STUD WALL
 17. 2x6 BALLOON FRAMED WALL PER STRUCTURAL
 18. DBL. 2x4 WALL PER PLAN
 19. 2x CRIPPLES @ 16" O.C.
 20. 2x PRESSURE TREATED SILL PLATE
 21. 2x SOLE PLATE
 22. DBL. 2x TOP PLATE @ EXTERIOR & BEARING WALLS
 23. 1x OVER 2x TOP PLATE @ INTERIOR & NON-BEARING WALLS
 24. INSULATION MATERIAL PER ENERGY CALCULATIONS
 25. MIN. 36" HIGH GUARD - SEE PLAN FOR HEIGHT
 26. LOW WALL - SEE PLAN FOR HEIGHT
 27. STAIR TREADS AND RISERS PER PLAN. - MIN. 10" TREAD & MAX. 7 3/4" RISER
 28. INTERIOR FINISH - MIN. 1/2" GYP. BD. @ WALLS & SAG RESISTANT OR 5/8" DRYWALL @ CEILING
 29. MIN. 1/2" GYP. BD. ON CEILING & WALLS @ USEABLE SPACE UNDER STAIRS
 30. GARAGE SHALL BE SEPARATED FROM THE RESIDENCE AND ITS ATTIC AREA BY NOT LESS THAN 1/2" GYP. BD. @ GARAGE SIDE WALLS & 5/8" UNDER LIVING AREA U.N.O.
 31. MATERIAL TO UNDERSIDE OF ROOF SHEATHING
 32. INTERIOR SHELF - MIN. 1/2" GYP. BD. OVER 3/8" PLY MD.
 33. CONCRETE PATIO/ PORCH SLAB PER STRUCTURAL - SLOPE 1/4" PER FT. MIN.
 34. CONCRETE GARAGE SLAB PER STRUCTURAL - SLOPE 2" MIN.
 35. CONCRETE FOUNDATION PER STRUCTURAL
 36. LINE OF OPTIONAL TRAY CEILING/ STEP CEILING
 37. LINE OF OPTIONAL VOLUME CEILING
 38. PROFILE OF OPTIONAL COVERED PATIO
 39. EXTERIOR SOFFIT MATERIAL - REFER TO ELEVATIONS.
 40. 8" BLOCK WALL
 41. 5/8" TYPE-X DRYWALL @ GARAGE CEILING
 42. WHEN THERE IS USABLE SPACE ABOVE AND BELOW THE CONCEALED SPACE OF A FLOOR-CEILING ASSEMBLY IN A SINGLE-FAMILY DWELLING, DRAFT STOPS SHALL BE INSTALLED SO THAT THE AREA OF THE CONCEALED SPACE DOES NOT EXCEED 1000 SQUARE FEET. DRAFTSTOPPING SHALL DIVIDE THE CONCEALED SPACE INTO APPROXIMATELY EQUAL AREAS.

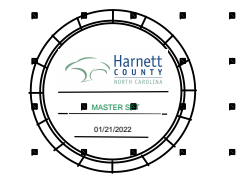

NORTH CAROLINA 40' SERIES

KB HOME
NORTH CAROLINA DIVISION

4506 S. MIAMI BLVD.
SUITE 180
DURHAM, NC 27703
TEL: (919) 768-7980
FAX: (919) 544-2928

2018 NORTH CAROLINA STATE BUILDING CODES

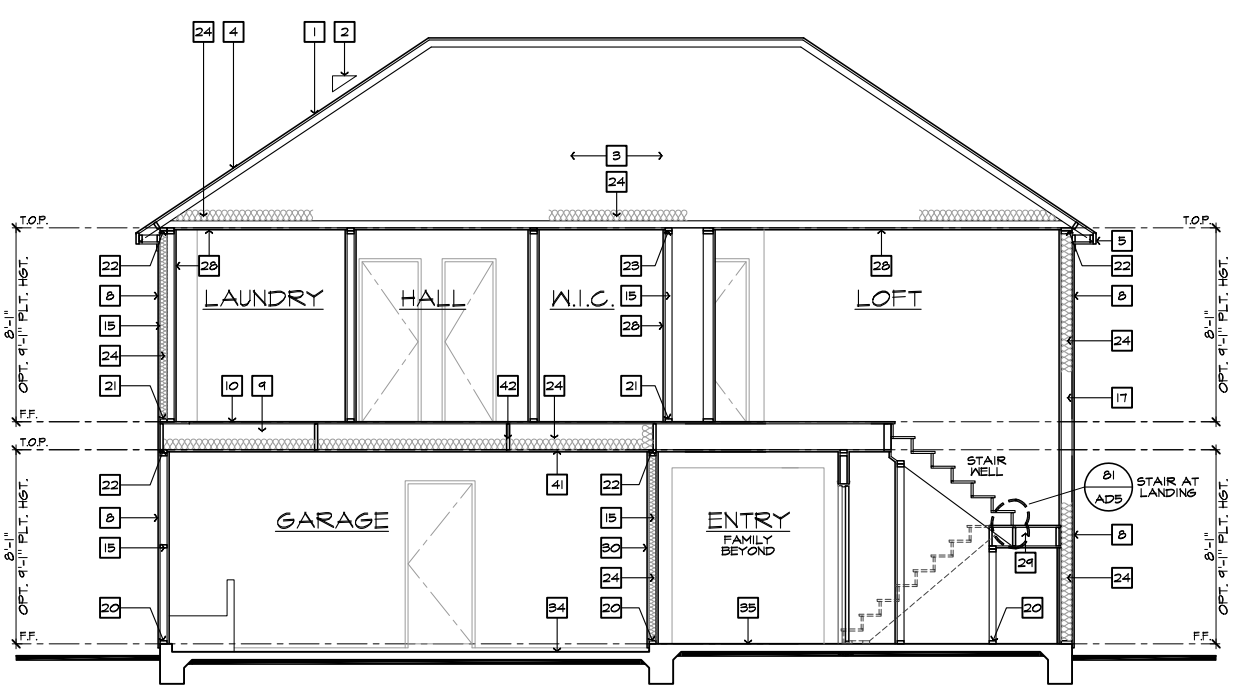

SECTION "C"

SCALE 1/4"=1'-0" (22"X34") - 1/8"=1'-0" (11"X17")

AT SLAB-ON-GRADE

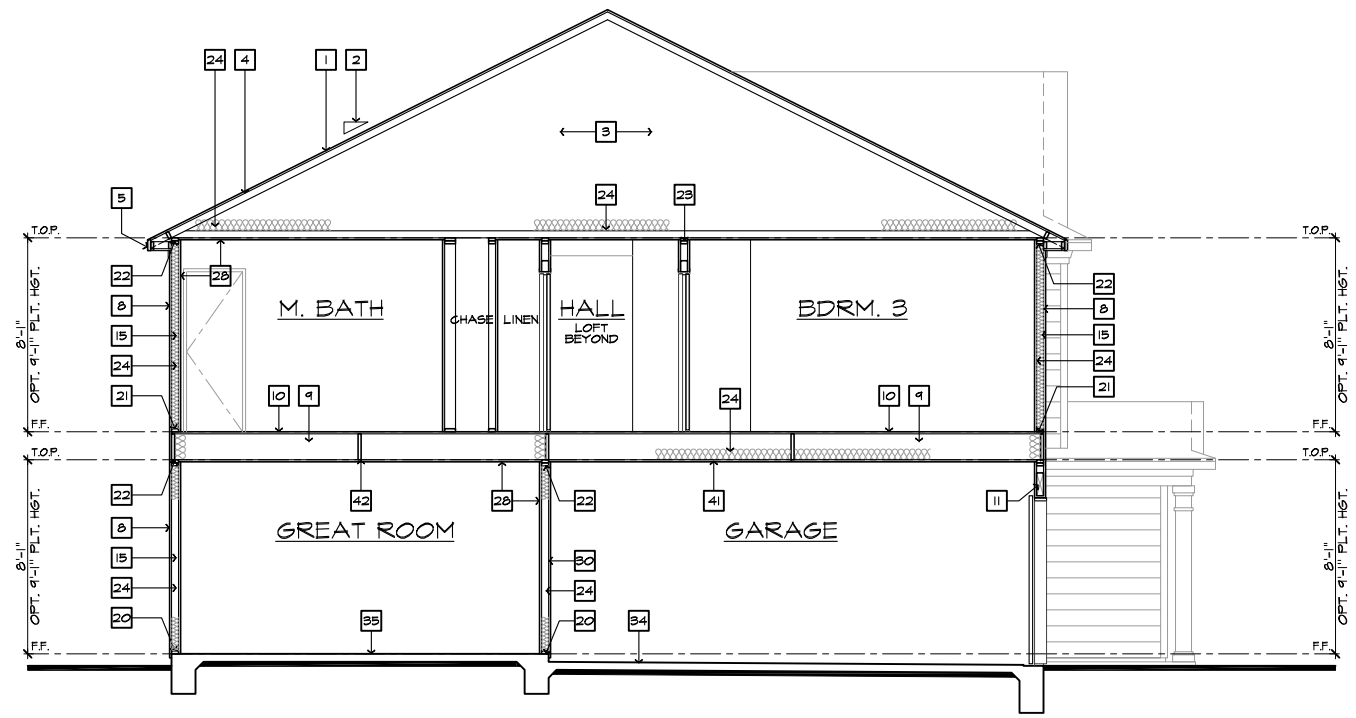

SECTION "B"

SCALE 1/4"=1'-0" (22"X34") - 1/8"=1'-0" (11"X17")

AT SLAB-ON-GRADE

- ISSUE DATE: 01/08/15
PROJECT No.: 1350999:56
DIVISION MGR.: DCS
REVISIONS: 08/20/20
- 11 DIVISION REVISION NC19654NCP - 08/28/19 - FAB
 - 12 DIVISION REVISION NC19657NCP - 09/26/19 - FAB
 - 13 DIVISION REVISION NC20003NCP - 12/19/19 - CL
 - 14 VENTILATION NC20008NCP - 01/17/20 - CL
 - 15 DIVISION REVISION NC20013NCP - 02/10/20 - MCP
 - 16 DIVISION REVISION NC20017NCP - 03/04/20 - KBA
 - 17 HOME OFFICE CORP20019CORP-08/20/20-CITD

FOR INTERNAL USE ONLY

REVIEWED BY:

1.	
2.	
3.	
4.	
5.	
6.	

PLAN:
238.2338
SHEET:
4.2

**SPEC. LEVEL 1
RALEIGH-DURHAM 40' SERIES**

These designs and drawings are CONFIDENTIAL, and the exclusive property of KB Home Corporation, and are not to be disclosed without the express permission of KB Home Corporation. Copyright 2020 © KB Home Corporation. All rights reserved.

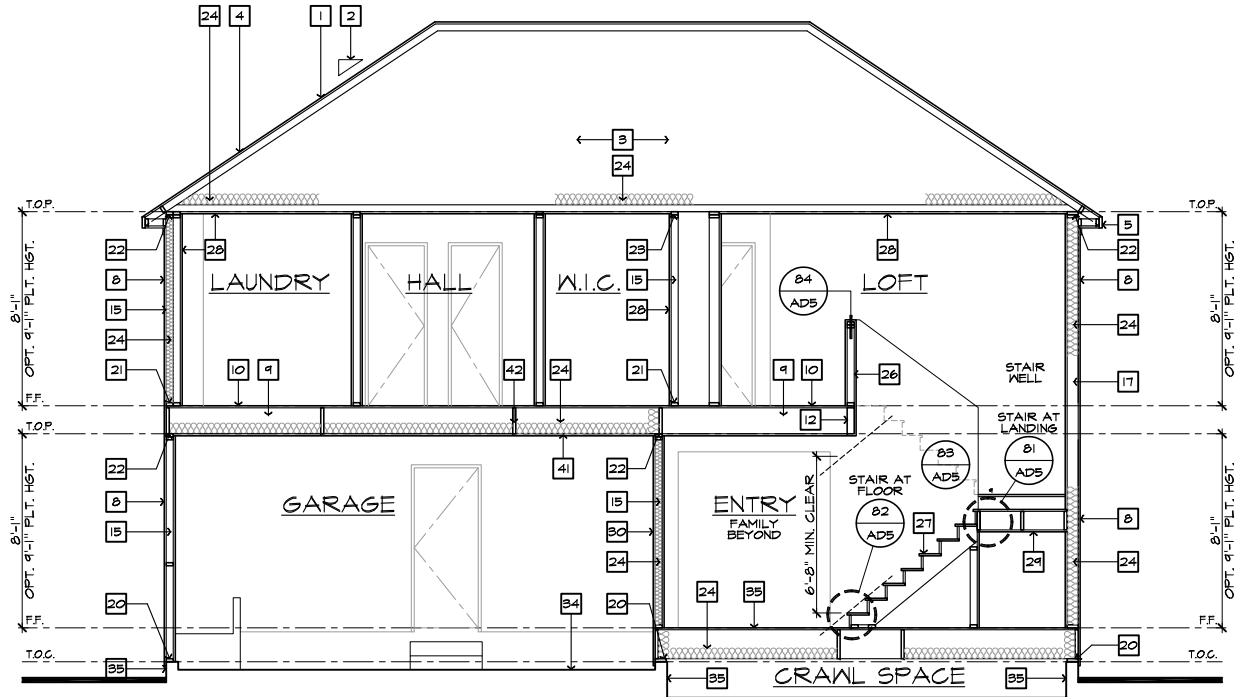

SECTION "A"

SCALE 1/4"=1'-0" (22'X34") - 1/8"=1'-0" (11'X17")

AT CRAWL SPACE

- SECTION NOTES**
- NOTE: NOT ALL KEY NOTES APPLY.
1. ROOF MATERIAL - REFER TO ROOF NOTES
 2. ROOF PITCH - REFER TO ROOF NOTES
 3. PRE-MANUFACTURED WOOD ROOF TRUSS SYSTEM - SEE STRUCTURAL & TRUSS CALCS
 4. ROOF SHEATHING PER STRUCTURAL
 5. 2x FASCIA/BARGE BOARD
 6. CONT. SOFFITED EAVE W/ VENTING
 7. G.I. FLASHING - ROOF TO WALL
 8. EXTERIOR FINISH PER ELEVATIONS
 9. FLOOR FRAMING PER STRUCTURAL
 10. FLOOR SHEATHING PER STRUCTURAL
 11. HEADER PER STRUCTURAL
 12. FLUSH BEAM PER STRUCTURAL
 13. DROPPED BEAM PER STRUCTURAL
 14. FLAT/ ARCHED SOFFIT PER PLAN
 15. 2x4 STUD WALL
 16. 2x6 STUD WALL
 17. 2x6 BALLOON FRAMED WALL PER STRUCTURAL
 18. DBL. 2x4 WALL PER PLAN
 19. 2x CRIPPLES @ 16" O.C.
 20. 2x PRESSURE TREATED SILL PLATE
 21. 2x SOLE PLATE
 22. DBL. 2x TOP PLATE @ EXTERIOR & BEARING WALLS
 23. 1x OVER 2x TOP PLATE @ INTERIOR & NON-BEARING WALLS
 24. INSULATION MATERIAL PER ENERGY CALCULATIONS
 25. MIN. 36" HIGH GUARD - SEE PLAN FOR HEIGHT
 26. LOW WALL - SEE PLAN FOR HEIGHT
 27. STAIR TREADS AND RISERS PER PLAN - MIN. 10" TREAD & MAX. 7 3/4" RISER
 28. INTERIOR FINISH - MIN. 1/2" GYP. BD. @ WALLS & SAG RESISTANT OR 5/8" DRYWALL @ CEILING
 29. MIN. 1/2" GYP. BD. ON CEILING & WALLS @ USEABLE SPACE UNDER STAIRS
 30. GARAGE SHALL BE SEPARATED FROM THE RESIDENCE AND ITS ATTIC AREA BY NOT LESS THAN 1/2" GYP. BD. @ GARAGE SIDE WALLS & 5/8" UNDER LIVING AREA U.N.O.
 31. MATERIAL TO UNDERSIDE OF ROOF SHEATHING
 32. INTERIOR SHELF - MIN. 1/2" GYP. BD. OVER 3/8" PLY MD.
 33. CONCRETE PATIO/ PORCH SLAB PER STRUCTURAL - SLOPE 1/4" PER FT. MIN.
 34. CONCRETE GARAGE SLAB PER STRUCTURAL - SLOPE 2" MIN.
 35. CONCRETE FOUNDATION PER STRUCTURAL
 36. LINE OF OPTIONAL TRAY CEILING/ STEP CEILING
 37. LINE OF OPTIONAL VOLUME CEILING
 38. PROFILE OF OPTIONAL COVERED PATIO
 39. EXTERIOR SOFFIT MATERIAL - REFER TO ELEVATIONS.
 40. 8" BLOCK WALL
 41. 5/8" TYPE-X DRYWALL @ GARAGE CEILING
 42. WHEN THERE IS USABLE SPACE ABOVE AND BELOW THE CONCEALED SPACE OF A FLOOR-CEILING ASSEMBLY IN A SINGLE-FAMILY DWELLING, DRAFT STOPS SHALL BE INSTALLED SO THAT THE AREA OF THE CONCEALED SPACE DOES NOT EXCEED 1000 SQUARE FEET. DRAFTSTOPPING SHALL DIVIDE THE CONCEALED SPACE INTO APPROXIMATELY EQUAL AREAS.

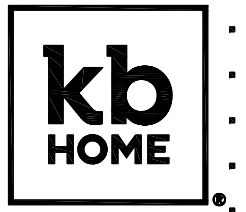

NORTH CAROLINA 40' SERIES

KB HOME
NORTH CAROLINA DIVISION

4506 S. MIAMI BLVD.
SUITE 180
DURHAM, NC 27703
TEL: (919) 768-7980
FAX: (919) 544-2928

2018 NORTH CAROLINA STATE BUILDING CODES

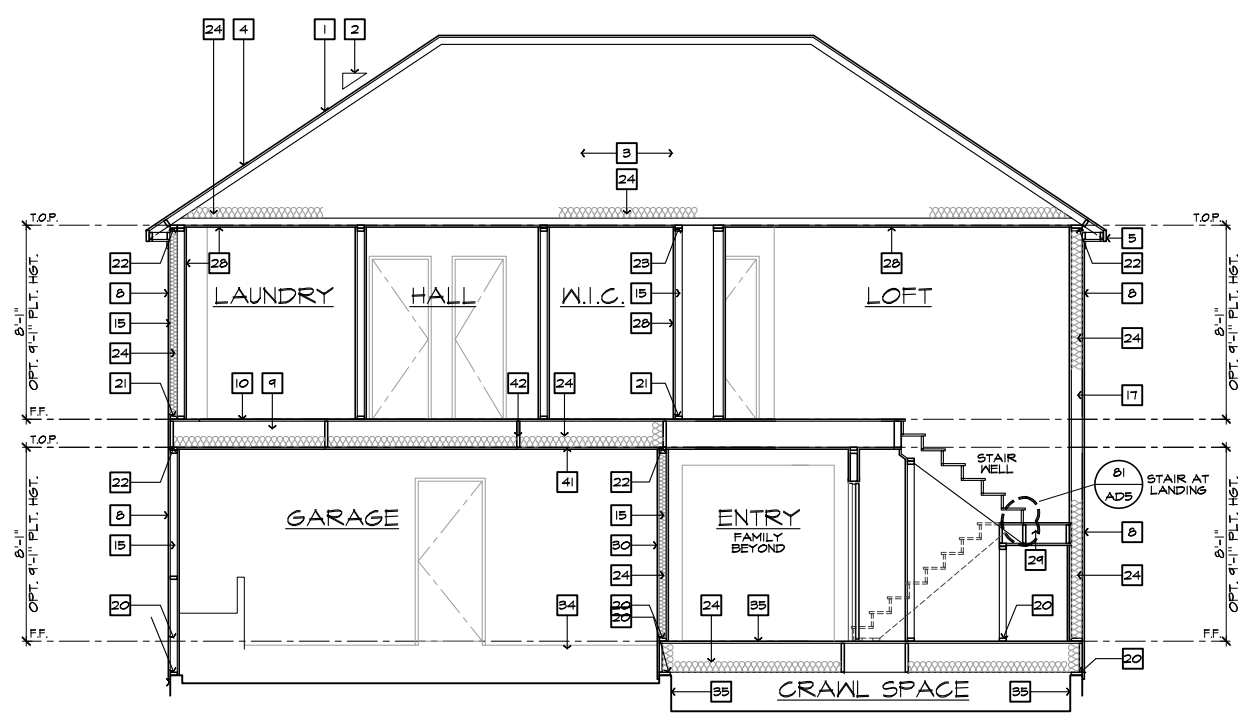

SECTION "C"

SCALE 1/4"=1'-0" (22'X34") - 1/8"=1'-0" (11'X17")

AT CRAWL SPACE

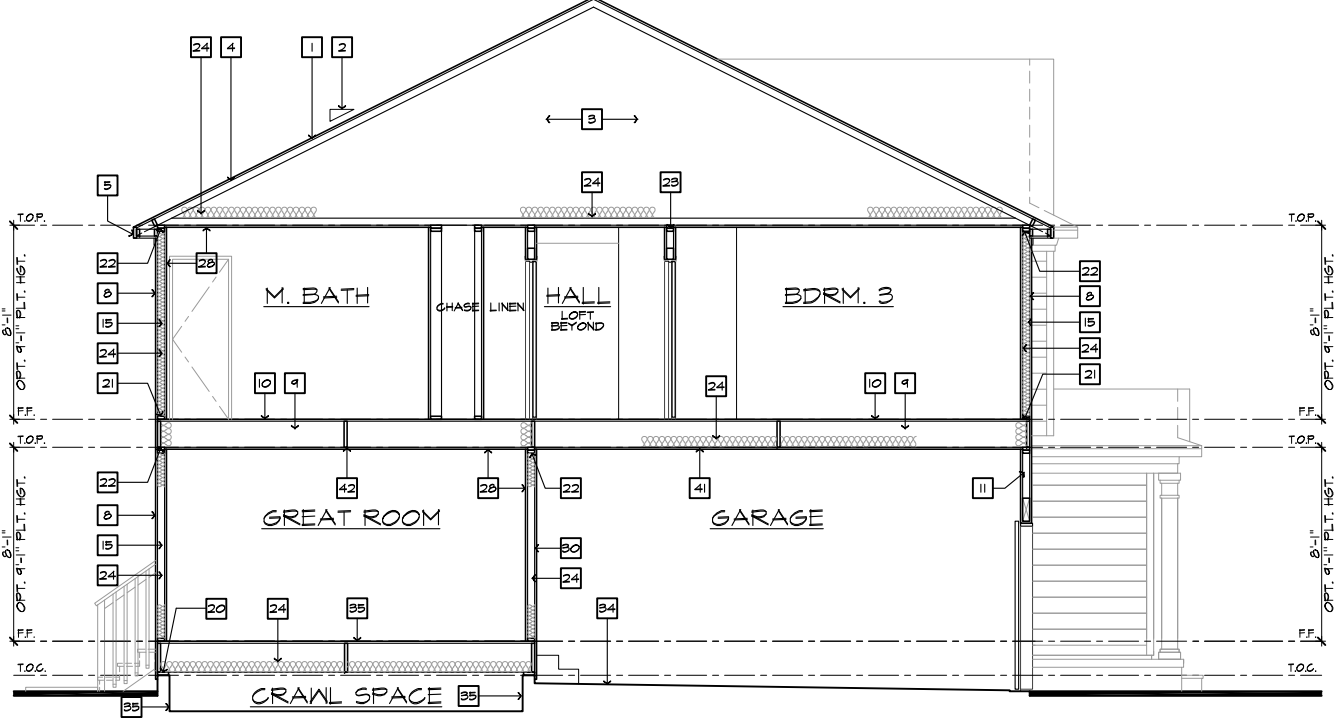

SECTION "B"

SCALE 1/4"=1'-0" (22'X34") - 1/8"=1'-0" (11'X17")

AT CRAWL SPACE

- ISSUE DATE: 01/08/15
PROJECT No.: 1350999:56
DIVISION MGR.: DCS
REVISIONS: 08/20/20
- 11 DIVISION REVISION NC19654NCP - 08/28/19 - FAE
 - 12 DIVISION REVISION NC19657NCP - 09/26/19 - FAE
 - 13 DIVISION REVISION NC20003NCP - 12/19/19 - CL
 - 14 VENTILATION NC20008NCP - 01/17/20 - CL
 - 15 DIVISION REVISION NC20013NCP - 02/10/20 - MCP
 - 16 DIVISION REVISION NC20017NCP - 03/04/20 - KBA
 - 17 HOME OFFICE CORP20009CORP-08/20/20-CTD

FOR INTERNAL USE ONLY

REVIEWED BY:	DATE:
1.	
2.	
3.	
4.	
5.	
6.	

PLAN: 238.2338
SHEET: 4.3

SPEC. LEVEL 1 RALEIGH-DURHAM 40' SERIES

These designs and drawings are CONFIDENTIAL, and the exclusive property of KB Home Corporation, and are not to be disclosed without the express permission of KB Home Corporation. They may not be used or duplicated without the express permission of KB Home Corporation. Copyright 2020 © KB Home Corporation, all rights reserved.

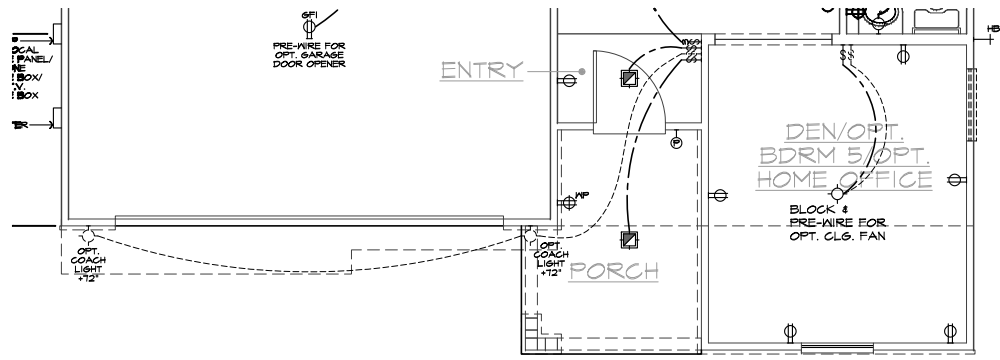

PARTIAL FIRST FLOOR UTILITY PLAN "B"

SCALE 1/4"=1'-0" (22"X34") - 1/8"=1'-0" (11"X17")

BASIC PLAN

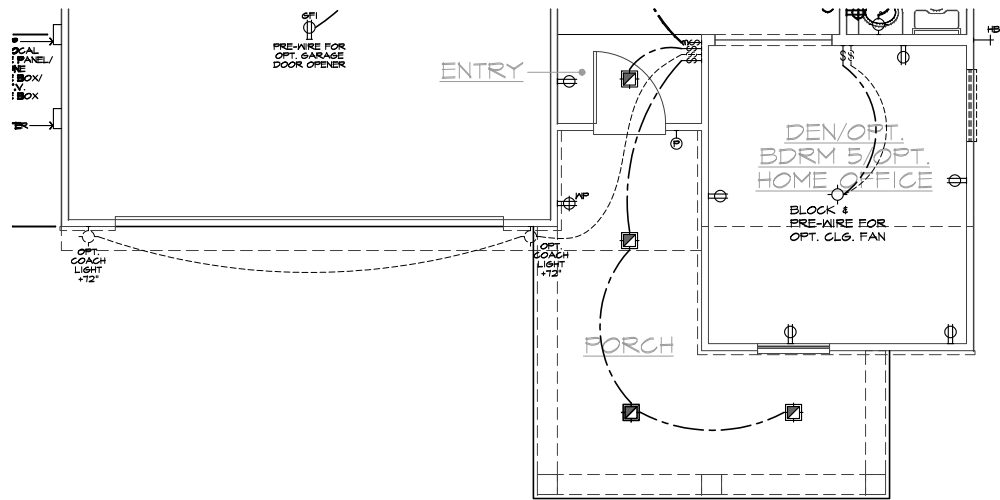

PARTIAL FIRST FLOOR UTILITY PLAN "C"

SCALE 1/4"=1'-0" (22"X34") - 1/8"=1'-0" (11"X17")

BASIC PLAN

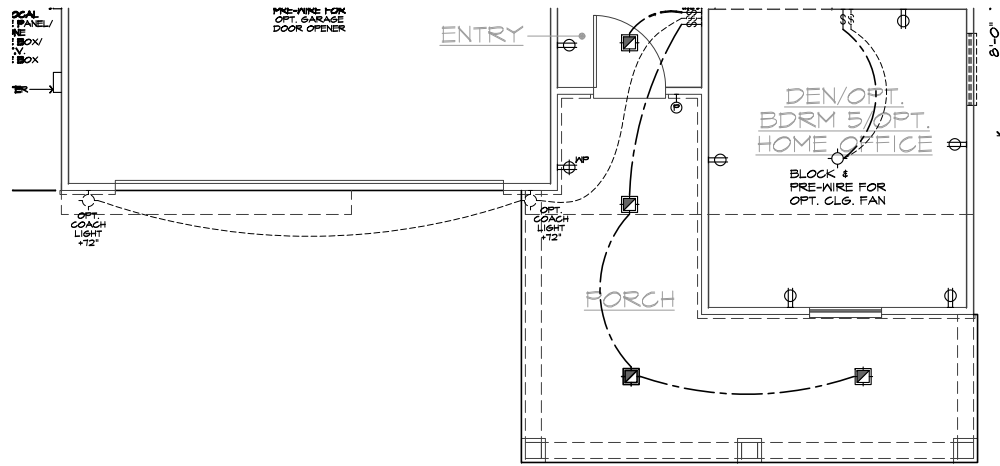

PARTIAL FIRST FLOOR UTILITY PLAN "D"

SCALE 1/4"=1'-0" (22"X34") - 1/8"=1'-0" (11"X17")

BASIC PLAN

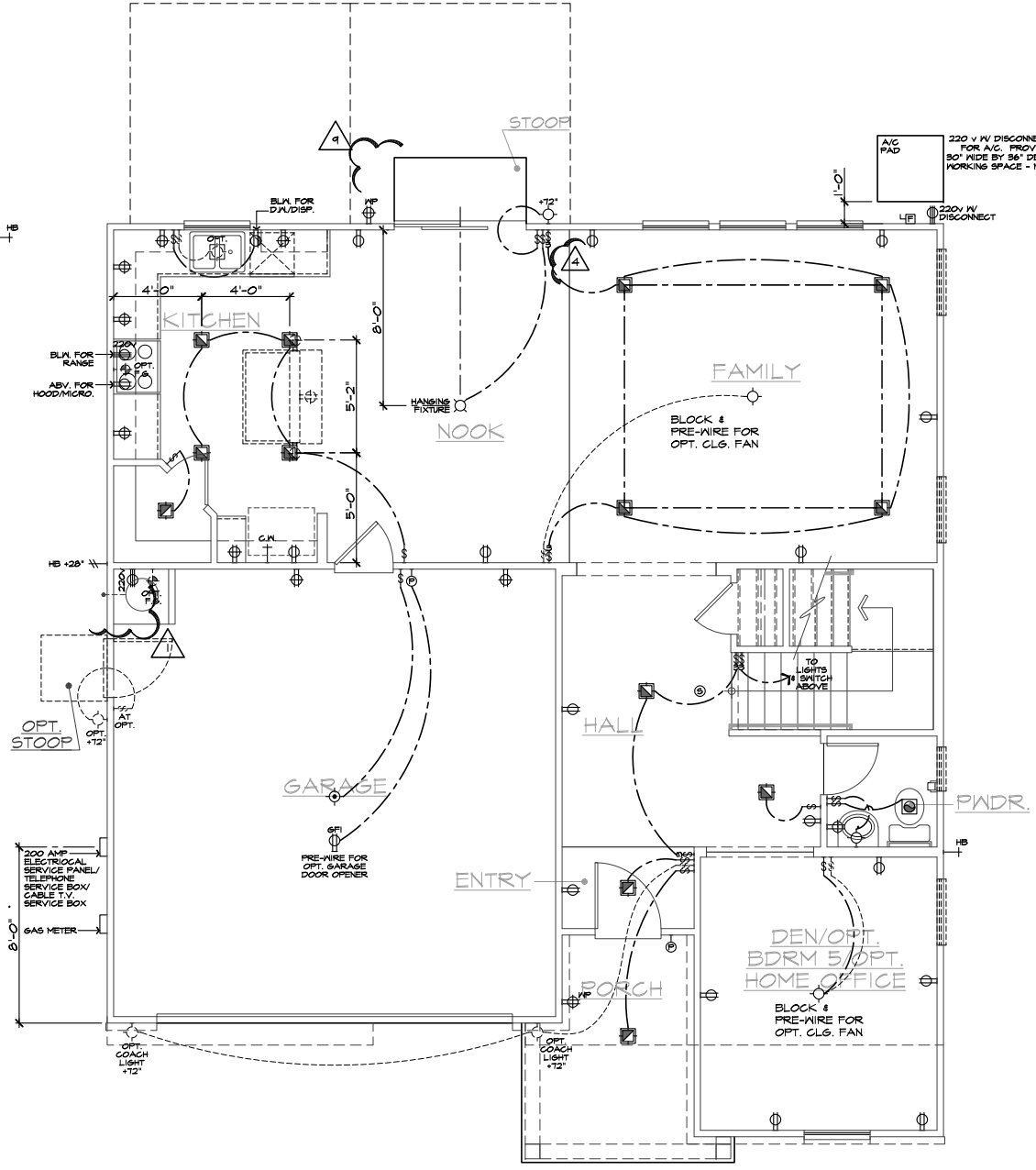

FIRST FLOOR UTILITY PLAN

SCALE 1/4"=1'-0" (22"X34") - 1/8"=1'-0" (11"X17")

BASIC PLAN

UTILITY LEGEND	
	120V DUPLEX CONVENIENCE RECEPTACLE ARC FAULT (AFCI) AND TAMPER RESISTANT (TR) 12" ABV. FIN. FLR. TYPICAL U.N.O.
	120V (TR) RECEPTACLE W/ GFI CIRCUIT W/ WATER RESISTANT HOUSING
	120V (TR) RECEPTACLE W/ GFI CIRCUIT
	FUSED DISCONNECT
	120V (AFCI & TR) RECESSED FLOOR RECEPTACLE W/ COVER
	120V (AFCI & TR) DUPLEX CONVENIENCE RECEPTACLE SWITCH CONTROLLED, 1/2 HOT
	220V SINGLE CONVENIENCE RECEPTACLE HEIGHT NOTED AS PER PLAN
	TWO-POLE LIGHT SWITCH AT 42" ABV. FIN. FLR. 8" ABOVE COUNTER U.N.O.
	THREE-POLE LIGHT SWITCH
	FOUR-POLE LIGHT SWITCH
	WALL MOUNTED LIGHT FIXTURE W/ WATER RESISTANT HOUSING
	WALL MOUNTED INCANDESCENT LIGHT FIXTURE
	WALL MOUNTED FLUORESCENT LIGHT FIXTURE
	CEILING MOUNTED INCANDESCENT LIGHT FIXTURE
	CEILING MOUNTED FLUORESCENT LIGHT FIXTURE
	HANGING INCANDESCENT LIGHT FIXTURE
	RECESSED INCANDESCENT DIRECTIONAL LIGHT FIXTURE (EYE BALL)
	RECESSED INCANDESCENT LIGHT FIXTURE
	RECESSED INCANDESCENT LIGHT FIXTURE W/ WATER RESISTANT HOUSING
	RECESSED FLUORESCENT LIGHT FIXTURE
	RECESSED EXHAUST FAN
	RECESSED EXHAUST FAN/ INCANDESCENT LIGHT COMBINATION
	RECESSED EXHAUST FAN/ FLUORESCENT LIGHT COMBINATION
	INCANDESCENT WALL SCONCE
	ILLUMINATED ADDRESS SIGN - VISIBLE FROM STREET
	24"X48" FLUORESCENT LIGHT BOX (CEILING MOUNTED)
	12"X48" FLUORESCENT LIGHT BOX (CEILING MOUNTED)
	OPTIONAL PRE-WIRED CEILING FAN AND SWITCH - LOCATED IN CENTER OF ROOM U.N.O.
	CEILING MOUNTED JUNCTION BOX
	WALL MOUNTED JUNCTION BOX
	DOOR CHIME
	CATV RECEPTACLE
	PUSH BUTTON
	PHONE OUTLET
	SERVICE BOX
	HOSE BIB
	HOSE BIB W/ S.O.V.
	WATER STUB FOR ICE MAKER
	APPROVED CEILING MOUNTED SMOKE DETECTOR TO BE HARD WIRED WITH BATTERY BACK-UP AND INTERCONNECTED
	APPROVED CARBON MONOXIDE ALARM/ SMOKE DET.
	THERMOSTAT (VERIFY LOCATION W/ HVAC PLAN)
	GAS TAP
	GAS KEY - FIREPLACE GAS VALVES SHALL BE LOCATED OUTSIDE OF REQUIRED HEARTH AREA, BUT NO MORE THAN 48" FROM GAS OUTLET
	SWITCHING FOR ROOMS W/ CLG. FAN OPTIONS
	24" MIN. SEPARATION OF ELECTRICAL BOXES AS SHOWN BELOW
	DWELLING

NOTES

- MECHANICAL, ELECTRICAL AND PLUMBING SYSTEMS ARE SHOWN FOR INTENT ONLY. THESE SYSTEMS SHALL BE ENGINEERED BY OTHERS. THE CONTRACTOR SHALL BE RESPONSIBLE FOR PROPER INSTALLATION AND PLACEMENT. ALL HEIGHTS SHOWN ARE TO CENTERLINE OF FIXTURE.
- PROVIDE SWITCH, LIGHT, 120V (AFCI & TR) DUPLEX RECEPTACLE & FUEL GAS STUB OR 220V RECEPTACLE IN ATTIC FOR F.A.U. - PER COMMUNITY SPECIFICATIONS.
- SMOKE DETECTORS IN ROOMS WITH VOLUME CEILING TO BE LOCATED AT HIGHEST POINT OF CEILING.
- 20 FOOT #4 REBAR FOR UPPER GROUND AND ADDITIONAL COLD WATER GROUND. REFER TO SLAB INTERFACE PLAN FOR LOCATION.
- 200 AMP ELECTRICAL PANEL (DEFAULT). ELECTRICAL PLAN CHECK PERMIT REQUIRED IF LOAD EXCEED 400 AMPS.



NORTH CAROLINA 40' SERIES

KB HOME
NORTH CAROLINA DIVISION
4518 S. MIAMI BLVD.
SUITE 180
DURHAM, NC 27703
TEL: (919) 768-7988
FAX: (919) 472-0582

2018 NORTH CAROLINA STATE BUILDING CODES

- ISSUE DATE: 01/08/15
PROJECT No.: 1350999:56
DIVISION MGR.: DCS
REVISIONS: 08/20/20
- 11 DIVISION REVISION NC19054NCP - 08/22/19 - FAE
 - 12 DIVISION REVISION NC19057NCP - 09/26/19 - FAE
 - 13 DIVISION REVISION NC20003NCP - 12/19/20 - CL
 - 14 VENTILATION NC20008NCP - 01/17/20 - CL
 - 15 DIVISION REVISION NC20013NCP - 02/10/20 - MCP
 - 16 DIVISION REVISION NC20017NCP - 03/04/20 - KBA
 - 17 HOME OFFICE CORP20003CORP-08/20/20-CTD
 - 18 ADD NOTE TO TS NC20037NCP - 10/06/20 - KBA
 - 19 DIVISION REQ REVISION NC21005NCP - 01/06/21 - KBA

PLAN: 238.2338
SHEET: 5.1

SPEC. LEVEL 1
RALEIGH-DURHAM 40' SERIES

These designs and drawings are CONFIDENTIAL, and the exclusive property of KB Home Corporation, and are not to be disclosed without the express permission of KB Home Corporation. Copyright 2014 © KB Home Corporation, all rights reserved.

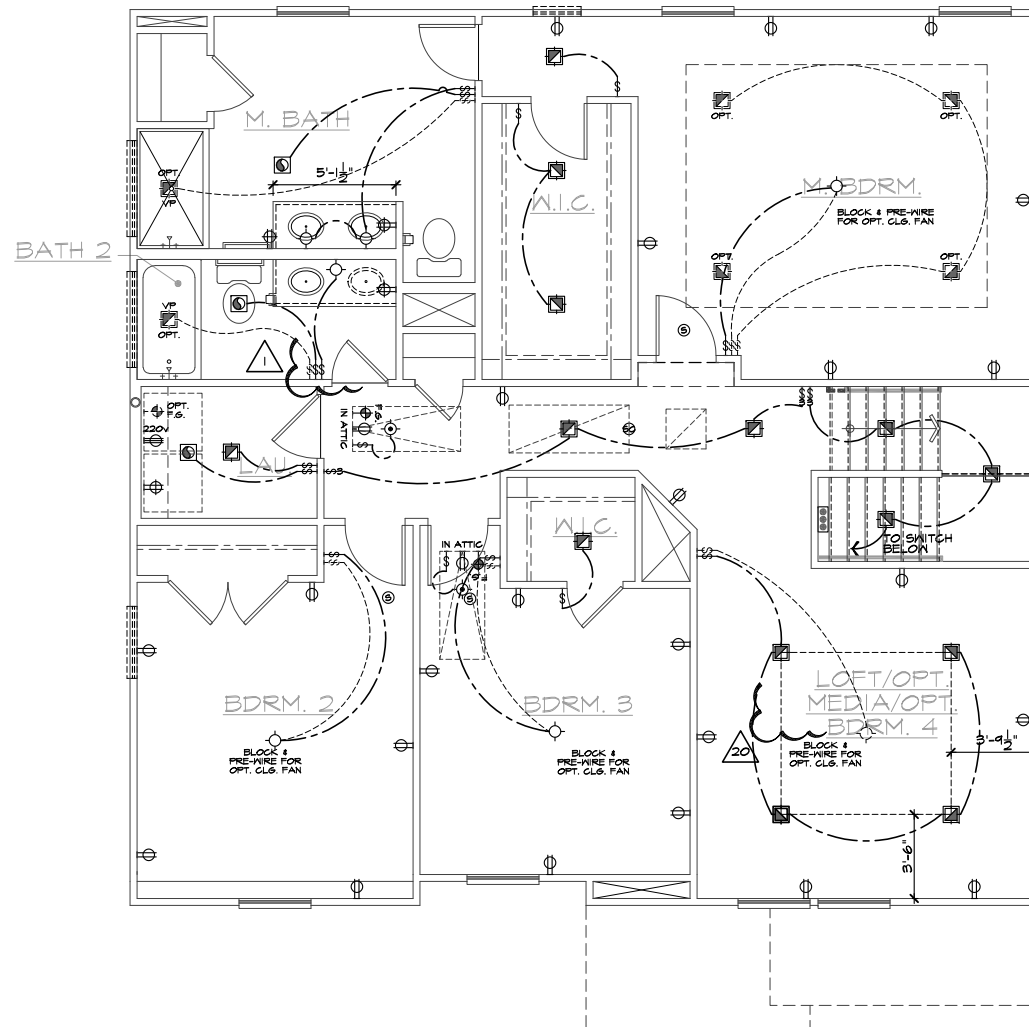

UTILITY LEGEND

120V DUPLEX CONVENIENCE RECEPTACLE
ARC FAULT(AFCI) AND TAMPER RESISTANT(TR)
12" ABV. FIN. FLR. TYPICAL U.N.O.

120V (TR) RECEPTACLE W/ GFI CIRCUIT
W/ WATER RESISTANT HOUSING

120V (TR) RECEPTACLE W/ GFI CIRCUIT

FUSED DISCONNECT

120V (AFCI & TR) RECESSED FLOOR RECEPTACLE W/ COVER

120V (AFCI & TR) DUPLEX CONVENIENCE RECEPTACLE SWITCH CONTROLLED, 1/2 HOT

220V SINGLE CONVENIENCE RECEPTACLE HEIGHT NOTED AS PER PLAN

TWO-POLE LIGHT SWITCH AT 42" ABV. FIN. FLR. 8" ABOVE COUNTER U.N.O.

THREE-POLE LIGHT SWITCH

FOUR-POLE LIGHT SWITCH

W.P. WALL MOUNTED LIGHT FIXTURE W/ WATER RESISTANT HOUSING

WALL MOUNTED INCANDESCENT LIGHT FIXTURE

WALL MOUNTED FLUORESCENT LIGHT FIXTURE

CEILING MOUNTED INCANDESCENT LIGHT FIXTURE

CEILING MOUNTED FLUORESCENT LIGHT FIXTURE

HANGING INCANDESCENT LIGHT FIXTURE

RECESSED INCANDESCENT DIRECTIONAL LIGHT FIXTURE (EYE BALL)

RECESSED INCANDESCENT LIGHT FIXTURE LIGHTING - TRAVERSE II LED FIXTURE - PER SPECS

W.P. RECESSED INCANDESCENT LIGHT FIXTURE W/ WATER RESISTANT HOUSING

RECESSED FLUORESCENT LIGHT FIXTURE

RECESSED EXHAUST FAN

RECESSED EXHAUST FAN/ INCANDESCENT LIGHT COMBINATION

RECESSED EXHAUST FAN/ FLUORESCENT LIGHT COMBINATION

INCANDESCENT WALL SCONCE

ILLUMINATED ADDRESS SIGN - VISIBLE FROM STREET

24"x48" FLUORESCENT LIGHT BOX (CEILING MOUNTED)

12"x48" FLUORESCENT LIGHT BOX (CEILING MOUNTED)

OPTIONAL PRE-WIRED CEILING FAN AND SWITCH - LOCATED IN CENTER OF ROOM U.N.O.

CEILING MOUNTED JUNCTION BOX

WALL MOUNTED JUNCTION BOX

DOOR CHIME

CATV RECEPTACLE

PUSH BUTTON

PHONE OUTLET

SERVICE BOX

HOSE BIB

HOSE BIB W/ S.O.V.

WATER STUB FOR ICE MAKER

APPROVED CEILING MOUNTED SMOKE DETECTOR TO BE HARD WIRED WITH BATTERY BACK-UP AND INTERCONNECTED

APPROVED CARBON MONOXIDE ALARM/ SMOKE DET.

THERMOSTAT (VERIFY LOCATION W/ HVAC PLAN)

GAS TAP

GAS KEY - FIREPLACE GAS VALVES SHALL BE LOCATED OUTSIDE OF REQUIRED HEARTH AREA, BUT NO MORE THAN 48" FROM GAS OUTLET

SWITCHING FOR ROOMS W/ CLG. FAN OPTIONS

24" MIN. SEPARATION OF ELECTRICAL BOXES AS SHOWN BELOW

DIWELLING

MIN.

SECONDARY MASTER GARAGE

NOTES

- MECHANICAL, ELECTRICAL AND PLUMBING SYSTEMS ARE SHOWN FOR INTENT ONLY. THESE SYSTEMS SHALL BE ENGINEERED BY OTHERS. THE CONTRACTOR SHALL BE RESPONSIBLE FOR PROPER INSTALLATION AND PLACEMENT. ALL HEIGHTS SHOWN ARE TO CENTERLINE OF FIXTURE.
- PROVIDE SWITCH, LIGHT, 120V (AFCI & TR) DUPLEX RECEPTACLE & FUEL GAS STUB OR 220V RECEPTACLE IN ATTIC FOR F.A.U. - PER COMMUNITY SPECIFICATIONS.
- SMOKE DETECTORS IN ROOMS WITH VOLUME CEILING TO BE LOCATED AT HIGHEST POINT OF CEILING
- 20 FOOT #4 REBAR FOR UPPER GROUND AND ADDITIONAL COLD WATER GROUND. REFER TO SLAB INTERFACE PLAN FOR LOCATION.
- 200 AMP ELECTRICAL PANEL (DEFAULT). ELECTRICAL PLAN CHECK PERMIT REQUIRED IF LOAD EXCEED 400 AMPS.

SECOND FLOOR UTILITY PLAN

SCALE 1/4"=1'-0" (22"X34") - 1/8"=1'-0" (11"X17")

BASIC PLAN

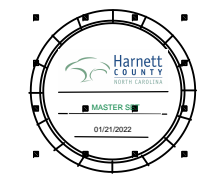

NORTH CAROLINA 40' SERIES

KB HOME
NORTH CAROLINA DIVISION

4518 S. MIAMI BLVD.
SUITE 180
DURHAM, NC 27703
TEL: (919) 768-7988
FAX: (919) 472-0582

2018 NORTH CAROLINA STATE BUILDING CODES

ISSUE DATE: 01/08/15
PROJECT No.: 1350999:56
DIVISION MGR.: DCS

REVISIONS: 08/20/20

- 11 DIVISION REVISION NC19054NCP - 08/22/19 - FAE
- 12 DIVISION REVISION NC19057NCP - 09/26/19 - FAE
- 13 DIVISION REVISION NC20003NCP - 12/19/19 - CL
- 14 VENTILATION NC20008NCP - 01/17/20 - CL
- 15 DIVISION REVISION NC20013NCP - 02/10/20 - MCP
- 16 DIVISION REVISION NC20017NCP - 03/04/20 - KBA
- 17 HOME OFFICE CORP20003CORP-08/20/20-CTD
- 18 ADD NOTE TO TS NC20037NCP - 10/06/20 - KBA
- 19 DIVISION REQ REVISION NC21005NCP - 01/06/21 - KBA
- 20 DIVISION REQ REVISION NC21032NCP - 05/19/21 - KBA

PLAN: **238.2338**
SHEET: **5.2**

SPEC. LEVEL 1 RALEIGH-DURHAM 40' SERIES

These designs and drawings are CONFIDENTIAL, and the exclusive property of KB Home Corporation, and are not to be disclosed without the express permission of KB Home Corporation. Copyright 2014 © KB Home Corporation, all rights reserved.

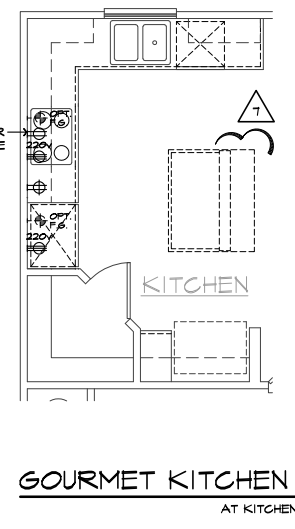
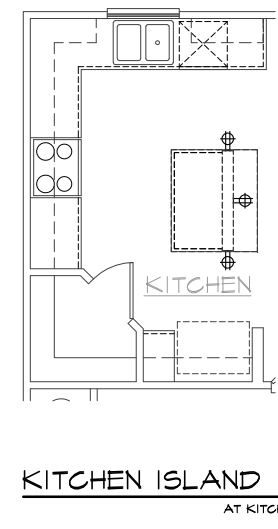
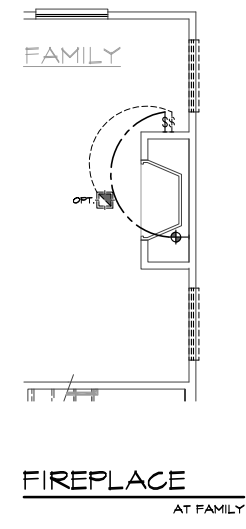
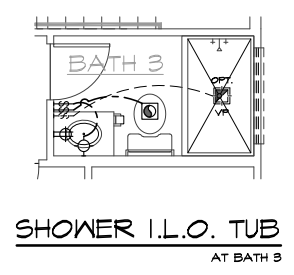
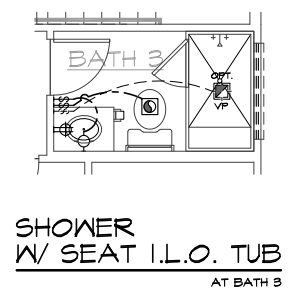
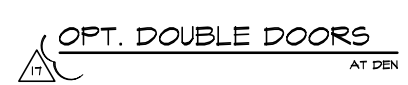
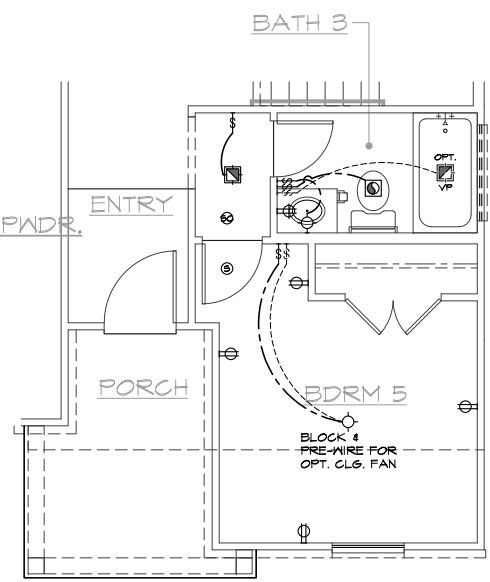
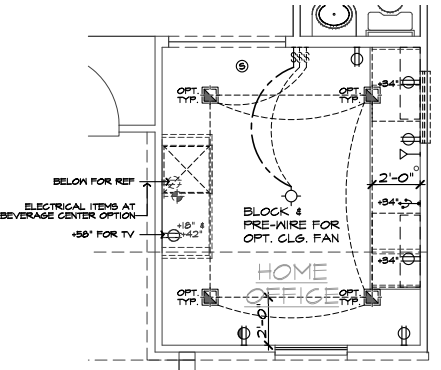
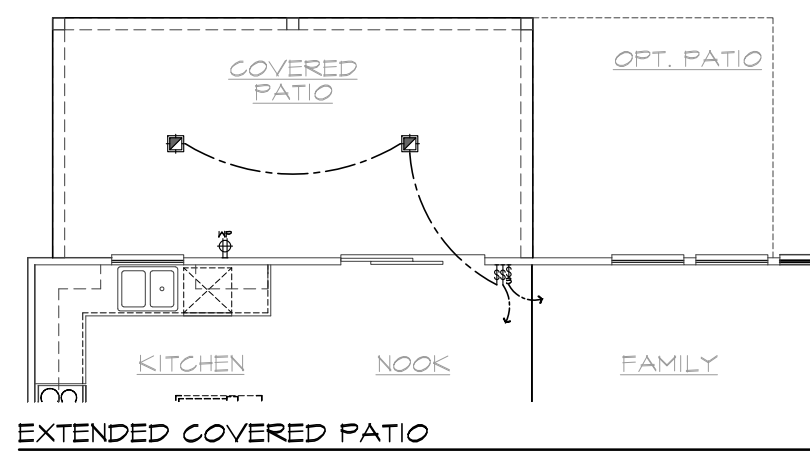
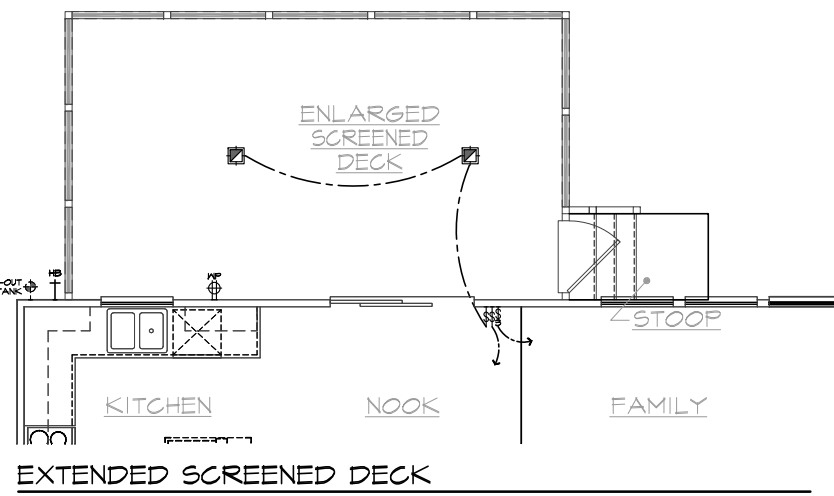
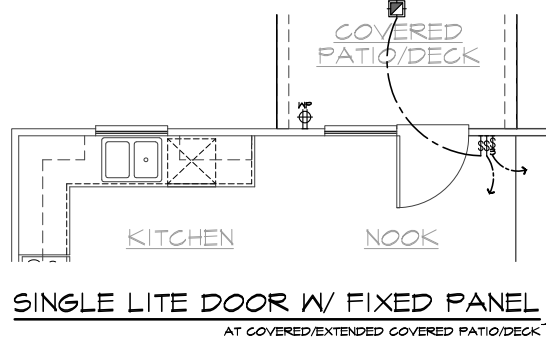
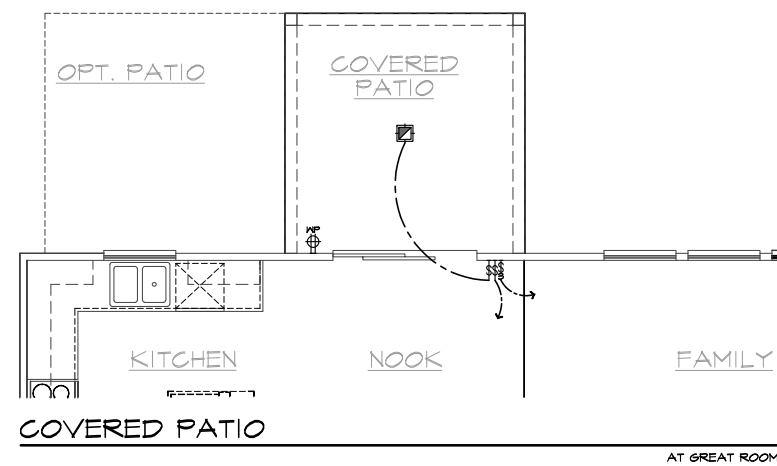
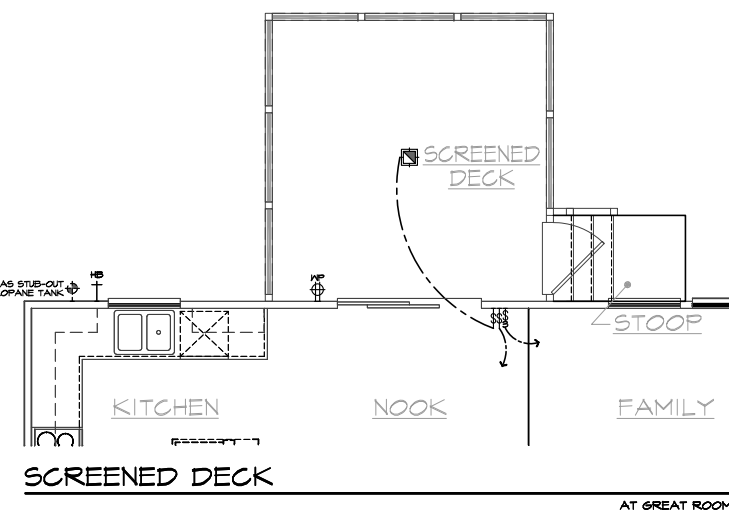
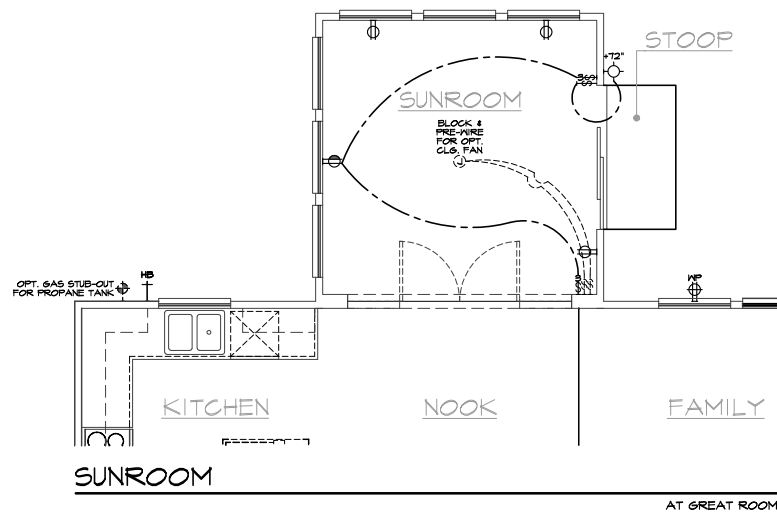

UTILITY LEGEND

- 120V DUPLEX CONVENIENCE RECEPTACLE (ARC FAULT/TAFPI) AND TAMPER RESISTANT (TR) 12" ABV. FIN. FLR. TYPICAL UNO.
- 120V (TR) RECEPTACLE W/ GFI CIRCUIT W/ WATER RESISTANT HOUSING
- 120V (TR) RECEPTACLE W/ GFI CIRCUIT
- FUSED DISCONNECT
- 120V (AFCI & TR) RECESSED FLOOR RECEPTACLE W/ COVER
- 120V (AFCI & TR) DUPLEX CONVENIENCE RECEPTACLE SWITCH CONTROLLED, 1/2 HOT
- 220V SINGLE CONVENIENCE RECEPTACLE HEIGHT NOTED AS PER PLAN
- TWO-POLE LIGHT SWITCH AT 42" ABV. FIN. FLR. 8" ABOVE COUNTER UNO.
- THREE-POLE LIGHT SWITCH
- FOUR-POLE LIGHT SWITCH
- W.P. WALL MOUNTED LIGHT FIXTURE W/ WATER RESISTANT HOUSING
- WALL MOUNTED INCANDESCENT LIGHT FIXTURE
- WALL MOUNTED FLUORESCENT LIGHT FIXTURE
- CEILING MOUNTED INCANDESCENT LIGHT FIXTURE
- CEILING MOUNTED FLUORESCENT LIGHT FIXTURE
- HANGING INCANDESCENT LIGHT FIXTURE
- RECESSED INCANDESCENT DIRECTIONAL LIGHT FIXTURE (EYE BALL)
- RECESSED INCANDESCENT LIGHT FIXTURE LIGHTING - TRAVERSE II LED FIXTURE - PER SPECS
- RECESSED INCANDESCENT LIGHT FIXTURE W/ WATER RESISTANT HOUSING
- RECESSED FLUORESCENT LIGHT FIXTURE
- RECESSED EXHAUST FAN
- RECESSED EXHAUST FAN/ INCANDESCENT LIGHT COMBINATION
- RECESSED EXHAUST FAN/ FLUORESCENT LIGHT COMBINATION
- INCANDESCENT WALL SCONCE
- ILLUMINATED ADDRESS SIGN - VISIBLE FROM STREET
- 24"x48" FLUORESCENT LIGHT BOX (CEILING MOUNTED)
- 12"x48" FLUORESCENT LIGHT BOX (CEILING MOUNTED)
- OPTIONAL PRE-WIRED CEILING FAN AND SWITCH - LOCATED IN CENTER OF ROOM UNO.
- CEILING MOUNTED JUNCTION BOX
- WALL MOUNTED JUNCTION BOX
- DOOR CHIME
- CATV RECEPTACLE
- PUSH BUTTON
- PHONE OUTLET
- SERVICE BOX
- HOSE BIB
- HOSE BIB W/ S.O.V.
- WATER STUB FOR ICE MAKER
- APPROVED CEILING MOUNTED SMOKE DETECTOR TO BE HARD WIRED WITH BATTERY BACK-UP AND INTERCONNECTED
- APPROVED CARBON MONOXIDE ALARM/ SMOKE DET.
- THERMOSTAT (VERIFY LOCATION W/ HVAC PLAN)
- GAS TAP
- GAS KEY - FIREPLACE GAS VALVES SHALL BE LOCATED OUTSIDE OF REQUIRED HEARTH AREA, BUT NO MORE THAN 48" FROM GAS OUTLET
- SWITCHING FOR ROOMS W/ CLG. FAN OPTIONS
- 24" MIN. SEPARATION OF ELECTRICAL BOXES AS SHOWN BELOW

NOTES

- MECHANICAL, ELECTRICAL AND PLUMBING SYSTEMS ARE SHOWN FOR INTENT ONLY. THESE SYSTEMS SHALL BE ENGINEERED BY OTHERS. THE CONTRACTOR SHALL BE RESPONSIBLE FOR PROPER INSTALLATION AND PLACEMENT. ALL HEIGHTS SHOWN ARE TO CENTERLINE OF FIXTURE.
- PROVIDE SWITCH, LIGHT, 120V (AFCI & TR) DUPLEX RECEPTACLE & FUEL GAS STUB OR 220V RECEPTACLE IN ATTIC FOR F.A.U. - PER COMMUNITY SPECIFICATIONS.
- SMOKE DETECTORS IN ROOMS WITH VOLUME CEILING TO BE LOCATED AT HIGHEST POINT OF CEILING
- 20 FOOT #4 REBAR FOR UFER GROUND AND ADDITIONAL COLD WATER GROUND. REFER TO SLAB INTERFACE PLAN FOR LOCATION.
- 300 AMP ELECTRICAL PANEL (DEFAULT). ELECTRICAL PLAN CHECK PERMIT REQUIRED IF LOAD EXCEED 400 AMPS.

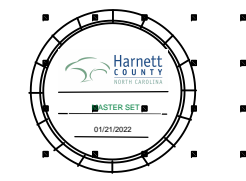

NORTH CAROLINA 40' SERIES

KB HOME
NORTH CAROLINA DIVISION
4518 S. MIAMI BLVD.
SUITE 180
DURHAM, NC 27703
TEL: (919) 768-7988
FAX: (919) 472-0582

2018 NORTH CAROLINA STATE BUILDING CODES

- ISSUE DATE: 01/08/15
PROJECT No.: 1350999-56
DIVISION MGR.: DCS
REVISIONS: 08/20/20
- 11 DIVISION REVISION NC19654NCP - 08/28/15 - FAB
 - 12 DIVISION REVISION NC19657NCP - 09/26/15 - FAB
 - 13 DIVISION REVISION NC20053NCP - 02/18/20 - CL
 - 14 VENTILATION NC20058NCP - 01/17/20 - CL
 - 15 DIVISION REVISION NC20053NCP - 02/18/20 - MCP
 - 16 DIVISION REVISION NC20017NCP - 03/04/20 - KBA
 - 17 HOME OFFICE CORP20053CORP-08/20/20-CTD
 - 18 ADD NOTE TO TP NC20057NCP - 10/06/20 - KBA
 - 19 DIVISION REQ REVISION NC21005NCP - 01/06/21 - KBA

PLAN: 238.2338
SHEET: 5.3

SPEC. LEVEL 1 RALEIGH-DURHAM 40' SERIES

FIRST FLOOR UTILITY PLAN OPTIONS

SCALE 1/4"=1'-0" (22'x34") - 1/8"=1'-0" (11'x17")

BASIC PLAN

These designs and drawings are CONFIDENTIAL and the exclusive property of KB Home Corporation and are not to be disclosed without the express permission of KB Home Corporation. They may not be used or duplicated without the express permission of KB Home Corporation. Copyright 2014 © KB Home Corporation, all rights reserved.

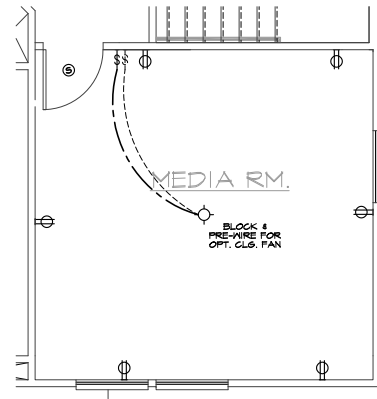

MEDIA
AT LOFT

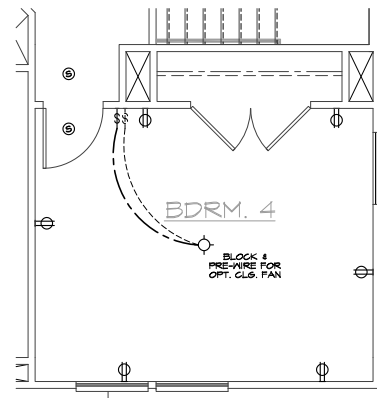

BEDROOM 4
AT LOFT

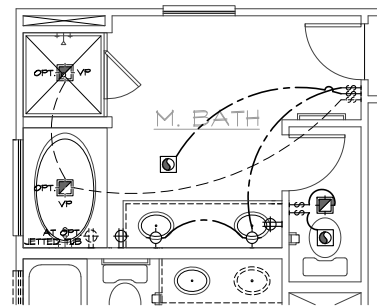

SUPER M. BATH
AT M. BATH

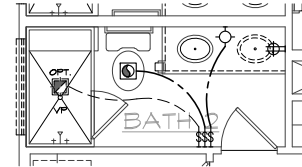

SHOWER W/ SEAT I.L.O. TUB
AT BATH 2

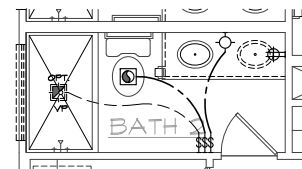

SHOWER I.L.O. TUB
AT BATH 2

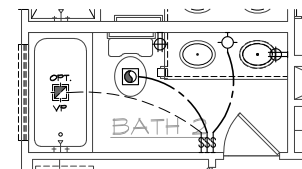

VANITY W/ DUAL SINKS
AT BATH 2

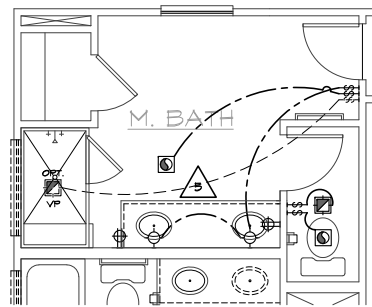

DELUXE M. BATH
AT M. BATH

SECOND FLOOR UTILITY PLAN OPTIONS

SCALE 1/4"=1'-0" (22"x34") - 1/8"=1'-0" (11"x17")

BASIC PLAN

UTILITY LEGEND

- ⊕ 120V DUPLEX CONVENIENCE RECEPTACLE ARC FAULT (AFCI) AND TAMPER RESISTANT (TR) 12" ABV. FIN. FLR. TYPICAL U.N.O.
- ⊕ W/ 6FI 120V (TR) RECEPTACLE W/ 6FI CIRCUIT W/ WATER RESISTANT HOUSING
- ⊕ 6FI 120V (TR) RECEPTACLE W/ 6FI CIRCUIT
- ⊕ FUSED DISCONNECT
- 120V (AFCI & TR) RECESSED FLOOR RECEPTACLE W/ COVER
- ⊕ 120V (AFCI & TR) DUPLEX CONVENIENCE RECEPTACLE SWITCH CONTROLLED, 1/2 HOT
- ⊕ 220 v 220V SINGLE CONVENIENCE RECEPTACLE HEIGHT NOTED AS PER PLAN
- ↔ TWO-POLE LIGHT SWITCH AT 42" ABV. FIN. FLR. 8" ABOVE COUNTER U.N.O.
- ↔ 3 THREE-POLE LIGHT SWITCH
- ↔ 4 FOUR-POLE LIGHT SWITCH
- ⊕ W.P. WALL MOUNTED LIGHT FIXTURE W/ WATER RESISTANT HOUSING
- ⊕ WALL MOUNTED INCANDESCENT LIGHT FIXTURE
- ⊕ WALL MOUNTED FLUORESCENT LIGHT FIXTURE
- ⊕ CEILING MOUNTED INCANDESCENT LIGHT FIXTURE
- ⊕ CEILING MOUNTED FLUORESCENT LIGHT FIXTURE
- ⊕ HANGING INCANDESCENT LIGHT FIXTURE
- ⊕ RECESSED INCANDESCENT DIRECTIONAL LIGHT FIXTURE (EYE BALL)
- ⊕ RECESSED INCANDESCENT LIGHT FIXTURE
- ⊕ LIGHTING - TRAVERSE II LED FIXTURE - PER SPECS
- ⊕ W.P. RECESSED INCANDESCENT LIGHT FIXTURE W/ WATER RESISTANT HOUSING
- ⊕ RECESSED FLUORESCENT LIGHT FIXTURE
- ⊕ RECESSED EXHAUST FAN
- ⊕ RECESSED EXHAUST FAN/ INCANDESCENT LIGHT COMBINATION
- ⊕ RECESSED EXHAUST FAN/ FLUORESCENT LIGHT COMBINATION
- ⊕ INCANDESCENT WALL SCONCE
- ⊕ ILLUMINATED ADDRESS SIGN - VISIBLE FROM STREET

24"x48" FLUORESCENT LIGHT BOX (CEILING MOUNTED)

12"x48" FLUORESCENT LIGHT BOX (CEILING MOUNTED)

- ⊕ OPTIONAL PRE-WIRED CEILING FAN AND SWITCH - LOCATED IN CENTER OF ROOM U.N.O.
- ⊕ CEILING MOUNTED JUNCTION BOX
- ⊕ WALL MOUNTED JUNCTION BOX
- ⊕ DOOR CHIME
- ⊕ CATV RECEPTACLE
- ⊕ PUSH BUTTON
- ⊕ PHONE OUTLET
- ⊕ SERVICE BOX
- ⊕ HOSE BIB
- ⊕ HOSE BIB W/ S.O.V.
- ⊕ WATER STUB FOR ICE MAKER
- ⊕ APPROVED CEILING MOUNTED SMOKE DETECTOR TO BE HARD WIRED WITH BATTERY BACK-UP AND INTERCONNECTED
- ⊕ APPROVED CARBON MONOXIDE ALARM/ SMOKE DET.
- ⊕ THERMOSTAT (VERIFY LOCATION W/ HVAC PLAN)
- ⊕ GAS TAP
- ⊕ GAS KEY - FIREPLACE GAS VALVES SHALL BE LOCATED OUTSIDE OF REQUIRED HEARTH AREA, BUT NO MORE THAN 48" FROM GAS OUTLET

SWITCHING FOR ROOMS W/ CLG. FAN OPTIONS

SECONDARY MASTER

24" MIN. SEPARATION OF ELECTRICAL BOXES AS SHOWN BELOW

MIN. DWELLING

NOTES

1. MECHANICAL, ELECTRICAL AND PLUMBING SYSTEMS ARE SHOWN FOR INTENT ONLY. THESE SYSTEMS SHALL BE ENGINEERED BY OTHERS. THE CONTRACTOR SHALL BE RESPONSIBLE FOR PROPER INSTALLATION AND PLACEMENT. ALL HEIGHTS SHOWN ARE TO CENTERLINE OF FIXTURE.
2. PROVIDE SWITCH, LIGHT, 120V (AFCI & TR) DUPLEX RECEPTACLE & FUEL GAS STUB OR 220V RECEPTACLE IN ATTIC FOR F.A.U. - PER COMMUNITY SPECIFICATIONS.
3. SMOKE DETECTORS IN ROOMS WITH VOLUME CEILING TO BE LOCATED AT HIGHEST POINT OF CEILING.
4. 20 FOOT #4 REBAR FOR UPPER GROUND AND ADDITIONAL COLD WATER GROUND. REFER TO SLAB INTERFACE PLAN FOR LOCATION.
5. 200 AMP ELECTRICAL PANEL (DEFAULT). ELECTRICAL PLAN CHECK PERMIT REQUIRED IF LOAD EXCEED 400 AMPS.

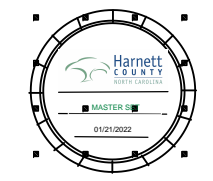

NORTH CAROLINA 40' SERIES

KB HOME
NORTH CAROLINA DIVISION
4518 S. MIAMI BLVD.
SUITE 180
DURHAM, NC 27703
TEL: (919) 768-7988
FAX: (919) 472-0582

2018 NORTH CAROLINA STATE BUILDING CODES

- ISSUE DATE: 01/08/15
PROJECT No.: 1350999:56
DIVISION MGR.: DCS
REVISIONS: 08/20/20
- 11 DIVISION REVISION NC19054NCP - 08/22/19 - FAE
 - 12 DIVISION REVISION NC19057NCP - 09/26/19 - FAE
 - 13 DIVISION REVISION NC20003NCP - 12/19/19 - CL
 - 14 VENTILATION NC20008NCP - 01/17/20 - CL
 - 15 DIVISION REVISION NC20013NCP - 02/10/20 - MCP
 - 16 DIVISION REVISION NC21017NCP - 03/04/20 - KBA
 - 17 HOME OFFICE CORP20003CORP-08/20/20-CTD
 - 18 ADD NOTE TO TS NC20037NCP - 10/06/20 - KBA
 - 19 DIVISION REQ REVISION NC21005NCP - 01/06/21 - KBA
 - 20 DIVISION REQ REVISION NC21032NCP - 05/19/21 - KBA

PLAN: **238.2338**
SHEET: **5.4**

SPEC. LEVEL 1 RALEIGH-DURHAM 40' SERIES

These designs and drawings are CONFIDENTIAL, and the exclusive property of KB Home Corporation, and are not to be disclosed without the express permission of KB Home Corporation. Copyright 2014 © KB Home Corporation, all rights reserved.

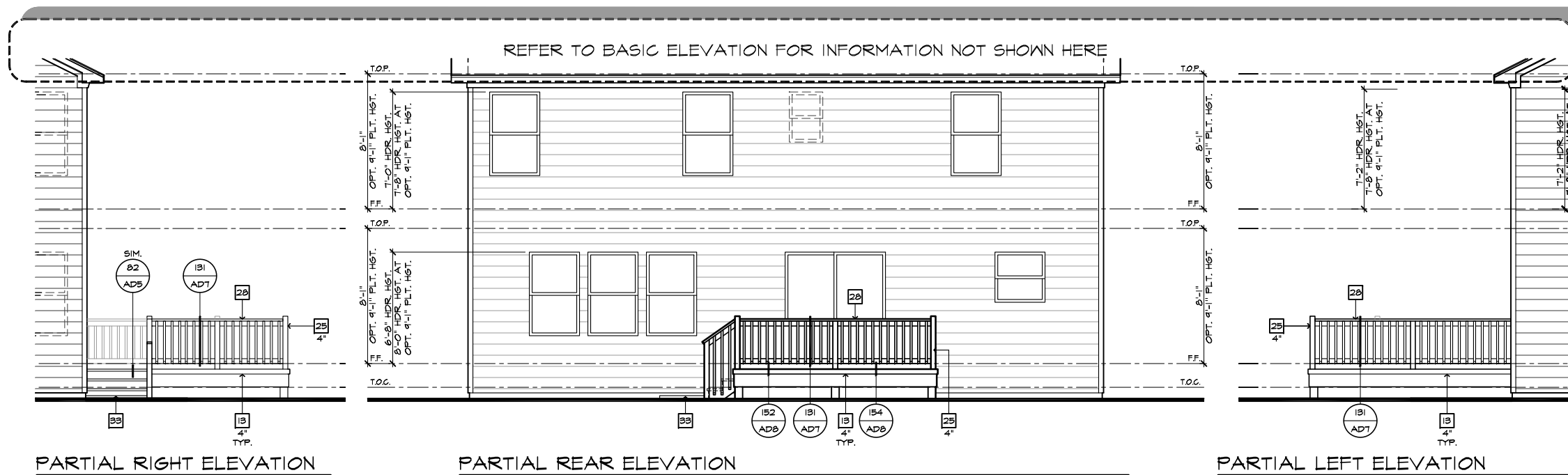

PARTIAL RIGHT ELEVATION

PARTIAL REAR ELEVATION

PARTIAL LEFT ELEVATION

#	ELEVATION NOTES
NOTE: NOT ALL KEY NOTES APPLY.	
1.	ROOF MATERIAL - REFER TO ROOF NOTES
2.	2X FASCIA/BARGE BOARD WITH FASCIA CAP
3.	6.1. FLASHING
4.	6.1. FLASHING & SADDLE/CRICKET
5.	6.1. DRIP SCREED
6.	24"x24" CHIMNEY
7.	DECORATIVE VENT
8.	DECORATIVE CORBEL
9.	DECORATIVE SHUTTERS
10.	PEDIMENT. SEE ELEVATION FOR TYPE
11.	RECESSED ELEMENT
12.	DECORATIVE TRIM FYPON OR EQ. SEE ELEVATION FOR TYPE
13.	TRIM PER SPEC- SEE ELEVATION FOR SIZE
14.	EXTERIOR FIBER CEMENT PANEL (BEADED OR SMOOTH)
15.	PRE-MANUFACTURED DECORATIVE COLUMN (SIZE, SEE ELEV.) FYPON OR EQ. SURROUNDING STRUCTURAL POST.
16.	SITE-BUILT COLUMN - SEE ELEVATION FOR TYPE
17.	FIBER-CEMENT STRAIGHT SHAKE SIDING SEE SPECS
18.	STONE VENEER PER SPECS
19.	BRICK/MASONRY VENEER PER SPECS
20.	BUILT UP BRICK COLUMN
21.	SOLDIER COURSE
22.	RONLOCK COURSE
23.	FRIEZE BOARD
24.	FIBER-CEMENT SIDING PER SPECS
25.	P.T. POST W/ WRAP - SEE STRUCTURAL FOR SIZE
26.	PRE-FAB DECORATIVE TRIM
27.	LIGHT WEIGHT PRECAST STONE TRIM
28.	P.T. LUMBER RAILINGS (36" U.N.O.)
29.	FIBER-CEMENT SMOOTH BOARD SEE SPECS
30.	DECORATIVE WINDOW/DOOR TRIM - FYPON OR EQ. SEE ELEVATION FOR SIZE.
31.	BRACKET OR KICKER - FYPON OR EQ.
32.	ENTRY DOOR
33.	CONCRETE STOOP/PORCH - SEE SLAB INTERFACE PLAN.
34.	SECTIONAL GARAGE DOOR PER SPECS
35.	ALUMINUM WRAP
36.	OPTIONAL DOOR/WINDOW - REFER TO PLAN OPTIONS
37.	OPTIONAL STANDING SEAM METAL ROOF
38.	KEYSTONE
39.	SOLDIER CROWN
40.	JACK SOLDIER COURSE
41.	WATER TABLE
42.	ATRIUM DOOR
43.	PILASTER - SEE ELEVATION FOR TYPE

#	PARTIAL PLAN NOTES
NOTE: NOT ALL KEY NOTES APPLY.	
27.	WATER HEATER LOCATION - FOR GAS - LOCATE ON 18" HIGH PLATFORM - FOR INTERIOR LOCATION - PROVIDE PAN & DRAIN (REFER TO DETAILS)
28.	WATER HEATER VENT TO OUTSIDE AIR
29.	MAIN LINE SHUT-OFF VALVE AND TEMP. & PRESSURE RELIEF VALVE
34.	LINE V. WALL BELOW
41.	LINE OF FLOOR ABOVE
42.	LINE OF FLOOR BELOW
43.	MIN. 36" HIGH GUARDRAIL (REFER TO DETAIL SHEETS)
50.	A/C PAD LOCATION
51.	LOW WALL - REFER TO PLAN FOR HEIGHT
52.	2x6 STUD WALL
54.	DBL. 2x4 WALL PER PLAN
55.	INTERIOR SHELF - REFER TO PLAN FOR HEIGHT
57.	FLAT SOFFIT
58.	ARCHED SOFFIT
60.	OPT. DOOR/WINDOW
61.	PRE-MANUFACTURED DECORATIVE COLUMN (SIZE, SEE ELEV.) FYPON OR EQ. SURROUNDING STRUCTURAL POST.
62.	BRICK / STONE VENEER - REFER TO ELEVATIONS
63.	SECTIONAL GARAGE DOOR PER SPECS
66.	3" DIAM. CONCRETE FILLED PIPE BOLLARD 36" HIGH WITH MIN. 12" EMBEDMENT INTO CONCRETE. (NOT REQUIRED AT ELECTRIC WATER HEATERS OR FOR APPLIANCES LOCATED OUT OF THE VEHICLE'S NORMAL TRAVEL PATH)
68.	P.T. POST W/ WRAP.
70.	EGRESS WINDOW
75.	WINDOW LEDGE - HEIGHT & WIDTH OF OPENING TO EXTEND 6" BEYOND WINDOW(S) ON ALL SIDES U.N.O.
76.	SITE-BUILT COLUMN - SEE ELEVATION FOR TYPE
77.	CONCRETE SLAB. SLOPE 1/4" PER FT. MIN. SEE PLAN FOR SIZE.

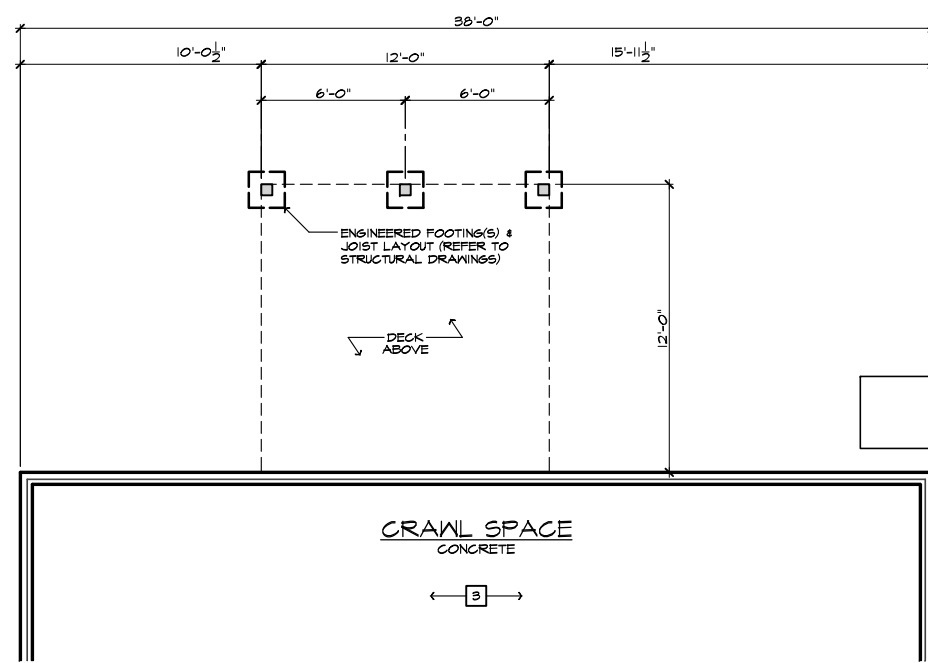

PARTIAL CRAWL SPACE PLAN

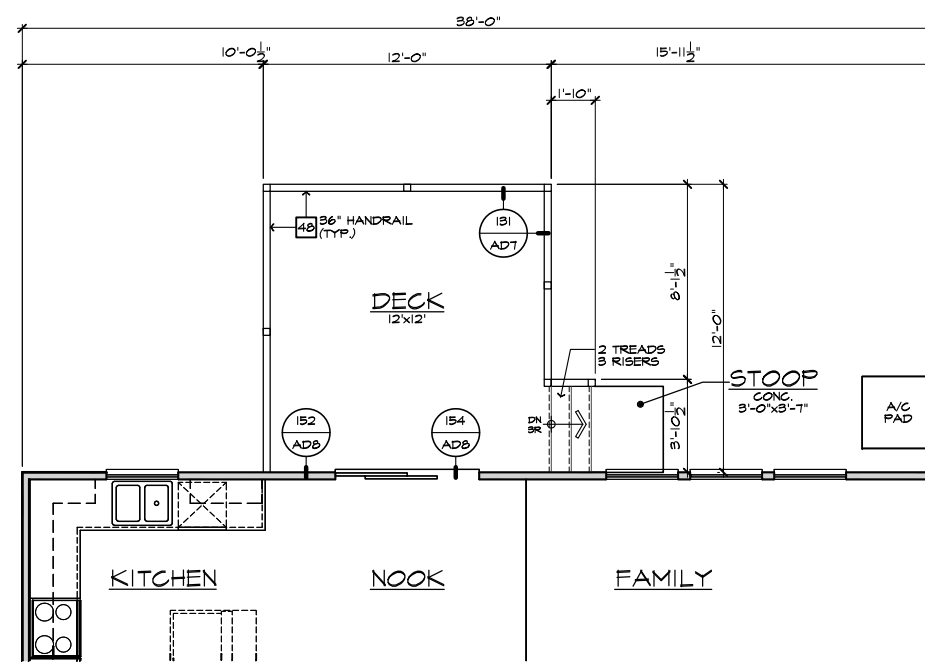

PARTIAL FIRST FLOOR PLAN

#	FOUNDATION PLAN NOTES
NOTE: NOT ALL KEY NOTES APPLY.	
1.	CONCRETE PATIO/PORCH SLAB PER STRUCTURAL- SLOPE 1/4" PER FT. MIN.
2.	CONCRETE GARAGE SLAB PER STRUCTURAL- SLOPE 1/8" PER 1'-0" MIN. TOWARD DOOR OPENINGS.
3.	FOUNDATION PER STRUCTURAL.
4.	STAIR LANDING, 36"x36" MIN.
5.	CONCRETE DRIVEWAY SLOPE 1/4" PER FT. MIN. AWAY FROM GARAGE DOOR OPENINGS.
6.	PROVIDE UNDER FLOOR VENTILATION
7.	4" TOE KICK FOR MASONRY VENEER.
8.	3" DIAMETER CONCRETE FILLED PIPE BOLLARD 36" HIGH WITH MIN. 12" EMBEDMENT INTO CONCRETE.
9.	REFER TO CIVIL DRAWINGS FOR ALL FINISH SURFACE ELEVATIONS.
10.	VERIFY LOCATION OF PIER FOOTINGS PER STRUCTURAL
11.	4" MIN. T 3/4" MAX. TO HARD SURFACE.
12.	A/C PAD. VERIFY LOCATION.
13.	CRAWL SPACE ACCESS
14.	36" WIDE WALKWAY- SLOPE 1/4" PER FT. MIN.

NOTE:
THE CRAWL SPACE IS TO BE CONDITIONED PER NC-R SECTION R409.
THE CRAWL SPACE VAPOR RETARDER (BARRIER) IS TO BE PER NC-R SECTION R409.2.

NOTE:
REFER TO BASIC ELEVATIONS FOR INFORMATION NOT SHOWN HERE
NOTE:
REFER TO BASIC FLOOR PLAN FOR INFORMATION NOT SHOWN HERE



NORTH CAROLINA 40' SERIES

KB HOME
NORTH CAROLINA DIVISION
4506 S. MIAMI BLVD.
SUITE 180
DURHAM, NC 27703
TEL: (919) 768-7980
FAX: (919) 544-2928

2018 NORTH CAROLINA STATE BUILDING CODES

ISSUE DATE: 01/08/15
PROJECT No.: 1350999:56
DIVISION MGR.: DCS
REVISIONS: 12/17/21

- 15 DIVISION REVISION NC20013NCP - 02/10/20 - MCP
- 16 DIVISION REVISION NC20017NCP - 03/04/20 - KBA
- 17 HOME OFFICE CORP20003CORP-08/20/20-CTD
- 18 ADD NOTE TO TF NC20037NCP - 10/06/20 - KBA
- 19 DIVISION REQ. REVISION NC21005NCP - 01/06/21 - KBA
- 20 DIVISION REQ. REVISION NC21032NCP - 05/19/21 - KBA
- 21 ADD DBCK OPTION NC21056NCP - 12/17/21 - CTD

FOR INTERNAL USE ONLY
REVIEWED BY:
1. _____
2. _____
3. _____
4. _____
5. _____
6. _____

PLAN: 238.2338
SHEET: 71

SPEC. LEVEL 1 RALEIGH-DURHAM 40' SERIES

DECK 'A/B/C/D' AT CRAWL SPACE
SCALE 1/4"=1'-0" (22"x34") - 1/8"=1'-0" (11"x17")

These designs and drawings are CONFIDENTIAL, and the exclusive property of KB Home Corporation, and are not to be disclosed without the express permission of KB Home Corporation. Copyright 2021 © KB Home Corporation. All rights reserved.

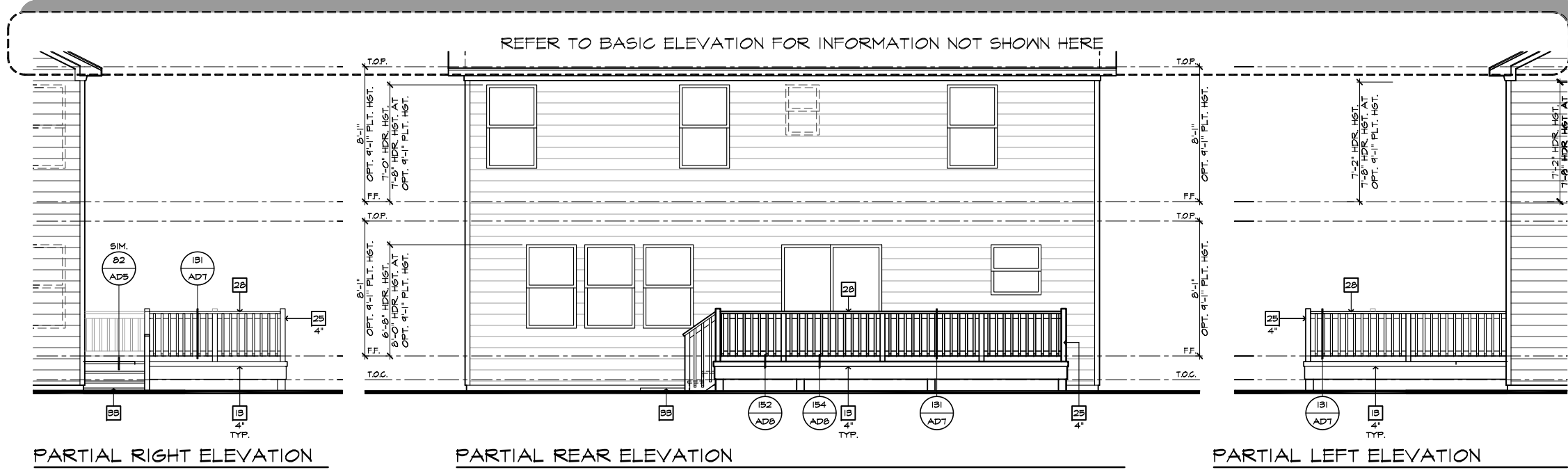

PARTIAL RIGHT ELEVATION

PARTIAL REAR ELEVATION

PARTIAL LEFT ELEVATION

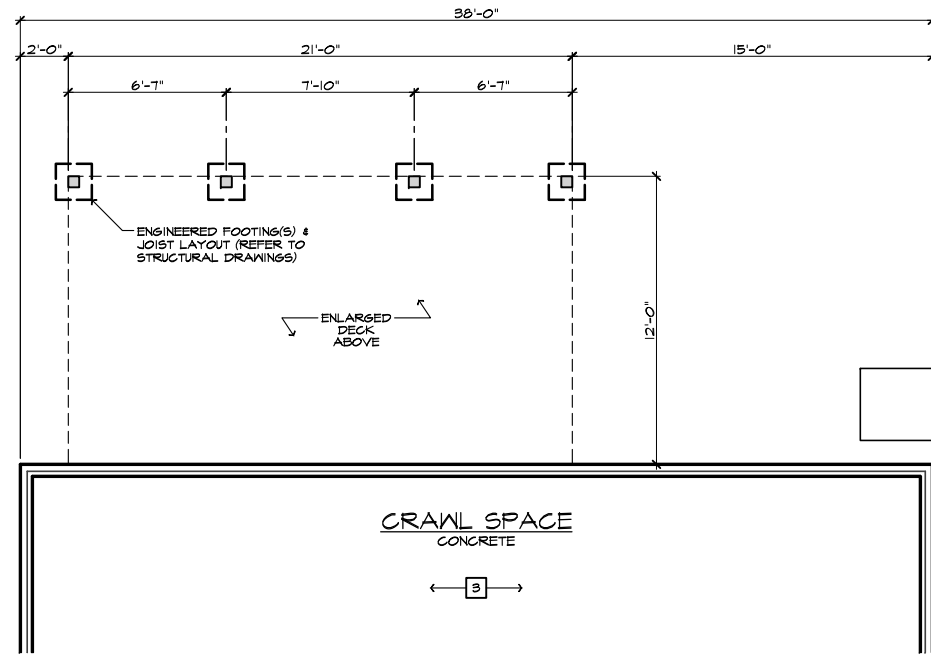

PARTIAL CRAWL SPACE PLAN

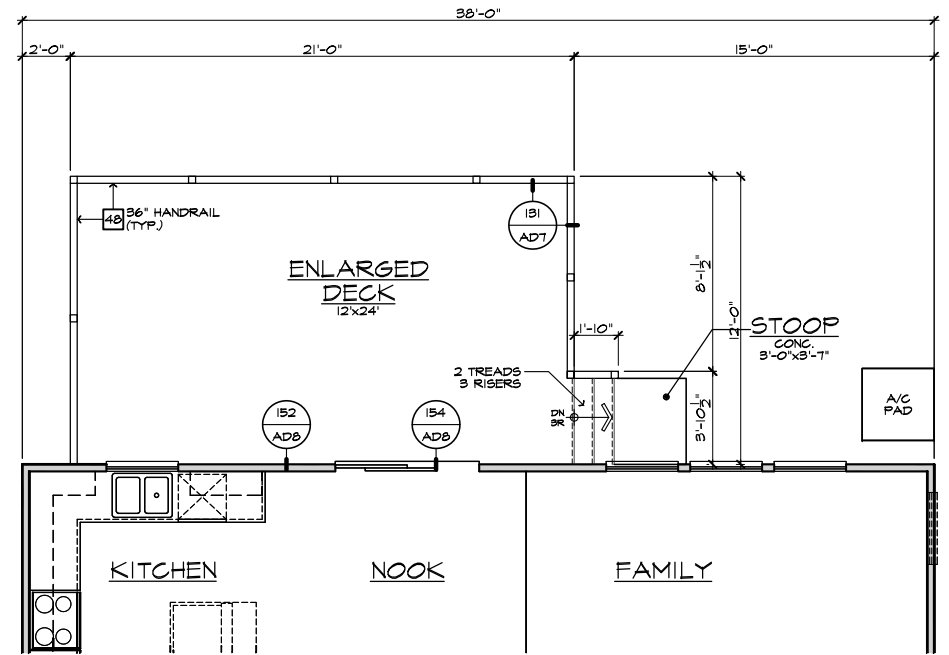

PARTIAL FIRST FLOOR PLAN

EXTENDED ENLARGED DECK 'A/B/C/D' AT CRAWL SPACE

SCALE 1/4"=1'-0" (22'x34") - 1/8"=1'-0" (11'x17")

#	ELEVATION NOTES
NOTE: NOT ALL KEY NOTES APPLY.	
1.	ROOF MATERIAL - REFER TO ROOF NOTES
2.	2X FASCIA/BARGE BOARD WITH FASCIA CAP
3.	6.1. FLASHING
4.	6.1. FLASHING & SADDLE/CRICKET
5.	6.1. DRIP SCREED
6.	24"x24" CHIMNEY
7.	DECORATIVE VENT
8.	DECORATIVE CORBEL
9.	DECORATIVE SHUTTERS
10.	PEDIMENT. SEE ELEVATION FOR TYPE
11.	RECESSED ELEMENT
12.	DECORATIVE TRIM FYPON OR EQ. SEE ELEVATION FOR TYPE
13.	TRIM PER SPEC - SEE ELEVATION FOR SIZE
14.	EXTERIOR FIBER CEMENT PANEL (BEADED OR SMOOTH)
15.	PRE-MANUFACTURED DECORATIVE COLUMN (SIZE, SEE ELEV.) FYPON OR EQ. SURROUNDING STRUCTURAL POST.
16.	SITE-BUILT COLUMN - SEE ELEVATION FOR TYPE
17.	FIBER-CEMENT STRAIGHT SHAKE SIDING SEE SPECS
18.	STONE VENEER PER SPECS
19.	BRICK/MASONRY VENEER PER SPECS
20.	BUILT UP BRICK COLUMN
21.	SOLDIER COURSE
22.	ROWLOCK COURSE
23.	FRIEZE BOARD
24.	FIBER-CEMENT SIDING PER SPECS
25.	P.T. POST W/ WRAP - SEE STRUCTURAL FOR SIZE
26.	PRE-FAB DECORATIVE TRIM
27.	LIGHT WEIGHT PRECAST STONE TRIM
28.	P.T. LUMBER RAILINGS (36" U.N.O.)
29.	FIBER-CEMENT SMOOTH BOARD SEE SPECS
30.	DECORATIVE WINDOW/DOOR TRIM - FYPON OR EQ. SEE ELEVATION FOR SIZE.
31.	BRACKET OR KICKER - FYPON OR EQ.
32.	ENTRY DOOR
33.	CONCRETE STOOP/ PORCH - SEE SLAB INTERFACE PLAN.
34.	SECTIONAL GARAGE DOOR PER SPECS
35.	ALUMINUM WRAP
36.	OPTIONAL DOOR/WINDOW - REFER TO PLAN OPTIONS
37.	OPTIONAL STANDING SEAM METAL ROOF
38.	KEYSTONE
39.	SOLDIER CROWN
40.	JACK SOLDIER COURSE
41.	WATER TABLE
42.	ATRIUM DOOR
43.	PILASTER - SEE ELEVATION FOR TYPE

#	PARTIAL PLAN NOTES
NOTE: NOT ALL KEY NOTES APPLY.	
27.	WATER HEATER LOCATION - FOR GAS - LOCATE ON 18" HIGH PLATFORM - FOR INTERIOR LOCATION - PROVIDE PAN & DRAIN (REFER TO DETAILS)
28.	WATER HEATER VENT TO OUTSIDE AIR
29.	MAIN LINE SHUT-OFF VALVE AND TEMP. & PRESSURE RELIEF VALVE
34.	LINE OF WALL BELOW
41.	LINE OF FLOOR ABOVE
42.	LINE OF FLOOR BELOW
43.	MIN. 36" HIGH GUARDRAIL (REFER TO DETAIL SHEETS)
50.	A/C PAD LOCATION
51.	LOW WALL - REFER TO PLAN FOR HEIGHT
52.	2x6 STUD WALL
54.	DBL. 2x4 WALL PER PLAN
55.	INTERIOR SHELF - REFER TO PLAN FOR HEIGHT
57.	FLAT SOFFIT
58.	ARCHED SOFFIT
60.	OPT. DOOR / WINDOW
61.	PRE-MANUFACTURED DECORATIVE COLUMN (SIZE, SEE ELEV.) FYPON OR EQ. SURROUNDING STRUCTURAL POST.
62.	BRICK / STONE VENEER - REFER TO ELEVATIONS
63.	SECTIONAL GARAGE DOOR PER SPECS
66.	3" DIAM. CONCRETE FILLED PIPE BOLLARD 36" HIGH WITH MIN. 12" EMBEDMENT INTO CONCRETE. (NOT REQUIRED AT ELECTRIC WATER HEATERS OR FOR APPLIANCES LOCATED OUT OF THE VEHICLE'S NORMAL TRAVEL PATH)
68.	P.T. POST W/ WRAP TO EGRESS WINDOW
75.	WINDOW LEDGE - HEIGHT & WIDTH OF OPENING TO EXTEND 6" BEYOND WINDOW(S) ON ALL SIDES U.N.O.
76.	SITE-BUILT COLUMN - SEE ELEVATION FOR TYPE
77.	CONCRETE SLAB. SLOPE 1/4" PER FT. MIN. SEE PLAN FOR SIZE

#	FOUNDATION PLAN NOTES
NOTE: NOT ALL KEY NOTES APPLY.	
1.	CONCRETE PATIO/PORCH SLAB PER STRUCTURAL- SLOPE 1/4" PER FT. MIN.
2.	CONCRETE GARAGE SLAB PER STRUCTURAL- SLOPE 1/8" PER 1'-0" MIN. TOWARD DOOR OPENINGS.
3.	FOUNDATION PER STRUCTURAL.
4.	STAIR LANDING, 36"x36" MIN.
5.	CONCRETE DRIVEWAY SLOPE 1/4" PER FT. MIN. AWAY FROM GARAGE DOOR OPENINGS.
6.	PROVIDE UNDER FLOOR VENTILATION
7.	4" TOE KICK FOR MASONRY VENEER.
8.	3" DIAMETER CONCRETE FILLED PIPE BOLLARD 36" HIGH WITH MIN. 12" EMBEDMENT INTO CONCRETE.
9.	REFER TO CIVIL DRAWINGS FOR ALL FINISH SURFACE ELEVATIONS.
10.	VERIFY LOCATION OF PIER FOOTINGS PER STRUCTURAL
11.	4" MIN. T 3/4" MAX. TO HARD SURFACE.
12.	A/C PAD. VERIFY LOCATION.
13.	CRAWL SPACE ACCESS
14.	36" WIDE WALKWAY- SLOPE 1/4" PER FT. MIN.

#	FOUNDATION PLAN NOTES
NOTE: NOT ALL KEY NOTES APPLY.	
THE CRAWL SPACE IS TO BE CONDITIONED PER NC-R SECTION R409.	
THE CRAWL SPACE VAPOR RETARDER (BARRIER) IS TO BE PER NC-R SECTION R409.2.	

#	FOUNDATION PLAN NOTES
NOTE: REFER TO BASIC ELEVATIONS FOR INFORMATION NOT SHOWN HERE	
NOTE: REFER TO BASIC FLOOR PLAN FOR INFORMATION NOT SHOWN HERE	



NORTH CAROLINA 40' SERIES
 KB HOME
 NORTH CAROLINA DIVISION
 4506 S. MIAMI BLVD.
 SUITE 180
 DURHAM, NC 27703
 TEL: (919) 768-7980
 FAX: (919) 544-2928

2018 NORTH CAROLINA STATE BUILDING CODES

ISSUE DATE: 01/08/15
 PROJECT No.: 1350999:56
 DIVISION MGR.: DCS
 REVISIONS: 12/17/21

- 15 DIVISION REVISION NC20013NCP - 02/10/20 - MCP
- 16 DIVISION REVISION NC20017NCP - 03/04/20 - KBA
- 17 HOME OFFICE CORP20003CORP-08/20/20-CTD
- 18 ADD NOTE TO TF NC20037NCP - 10/06/20 - KBA
- 19 DIVISION REQ. REVISION NC21005NCP - 01/06/21 - KBA
- 20 DIVISION REQ. REVISION NC21032NCP - 05/19/21 - KBA
- 21 ADD DECK OPTION NC21056NCP - 12/17/21 - CTD

FOR INTERNAL USE ONLY	
REVIEWED BY:	
1.	
2.	
3.	
4.	
5.	
6.	

PLAN: 238.2338
 SHEET: 7.2

SPEC. LEVEL 1
RALEIGH-DURHAM 40' SERIES

These designs and drawings are CONFIDENTIAL, and the exclusive property of KB Home Corporation and are not to be disclosed without the express permission of KB Home Corporation. Copyright 2021 © KB Home Corporation. All rights reserved.

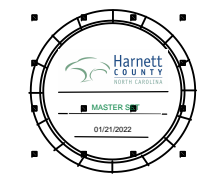

NORTH CAROLINA 40' SERIES

KB HOME
NORTH CAROLINA DIVISION
4506 S. MIAMI BLVD.
SUITE 180
DURHAM, NC 27703
TEL: (919) 768-7980
FAX: (919) 544-2928

2018 NORTH CAROLINA STATE BUILDING CODES

ISSUE DATE: 01/08/15
PROJECT No.: 1350999:56
DIVISION MGR.: DCS
REVISIONS: 12/17/21

- 15 DIVISION REVISION NC2003NCP - 02/10/20 - MCP
- 16 DIVISION REVISION NC2007NCP - 03/04/20 - KBA
- 17 HOME OFFICE CORP2003CORP-08/20/20-CTD
- 18 ADD NOTE TO TF NC2003NCP - 10/04/20 - KBA
- 19 DIVISION RBO REVISION NC21005NCP - 01/06/21 - KBA
- 20 DIVISION RBO REVISION NC21005NCP - 05/19/21 - KBA
- 21 ADD DBCK OPTION NC21056NCP - 12/17/21 - CTD

FOR INTERNAL USE ONLY	
REVISION BY:	
1.	
2.	
3.	
4.	
5.	
6.	

PLAN: 238.2338
SHEET: 7.3

SPEC. LEVEL 1 21 RALEIGH-DURHAM 40' SERIES

- ### ELEVATION NOTES
- NOTE: NOT ALL KEY NOTES APPLY.
- ROOF MATERIAL - REFER TO ROOF NOTES
 - 2X FASCIA/BARGE BOARD WITH FASCIA CAP
 - 6.1. FLASHING
 - 6.1. FLASHING & SADDLE/CRICKET
 - 6.1. DRIP SCREED
 - 24"x24" CHIMNEY
 - DECORATIVE VENT
 - DECORATIVE CORBEL
 - DECORATIVE SHUTTERS
 - PEDIMENT. SEE ELEVATION FOR TYPE
 - RECESSED ELEMENT
 - DECORATIVE TRIM FYPON OR EQ. SEE ELEVATION FOR TYPE
 - TRIM PER SPEC- SEE ELEVATION FOR SIZE
 - EXTERIOR FIBER CEMENT PANEL (BEADED OR SMOOTH)
 - PRE-MANUFACTURED DECORATIVE COLUMN (SIZE, SEE ELEV.) FYPON OR EQ. SURROUNDING STRUCTURAL POST.
 - SITE-BUILT COLUMN - SEE ELEVATION FOR TYPE
 - FIBER-CEMENT STRAIGHT SHAKE SIDING SEE SPECS
 - STONE VENEER PER SPECS
 - BRICK/MASONRY VENEER PER SPECS
 - BUILT UP BRICK COLUMN
 - SOLDIER COURSE
 - ROCKLOCK COURSE
 - FRIEZE BOARD
 - FIBER-CEMENT SIDING PER SPECS
 - P.T. POST W/ WRAP - SEE STRUCTURAL FOR SIZE
 - PRE-FAB DECORATIVE TRIM
 - LIGHT WEIGHT PRECAST STONE TRIM
 - P.T. LUMBER RAILINGS (36" U.N.O.)
 - FIBER-CEMENT SMOOTH BOARD SEE SPECS
 - DECORATIVE WINDOW/DOOR TRIM - FYPON OR EQ. SEE ELEVATION FOR SIZE
 - BRACKET OR KICKER - FYPON OR EQ.
 - ENTRY DOOR
 - CONCRETE STOOP/ PORCH - SEE SLAB INTERFACE PLAN.
 - SECTIONAL GARAGE DOOR PER SPECS
 - ALUMINUM WRAP
 - OPTIONAL DOOR/WINDOM - REFER TO PLAN OPTIONS
 - OPTIONAL STANDING SEAM METAL ROOF
 - KEYSTONE
 - SOLDIER CROWN
 - JACK SOLDIER COURSE
 - WATER TABLE
 - ATRIUM DOOR
 - PILASTER - SEE ELEVATION FOR TYPE

- ### PARTIAL PLAN NOTES
- NOTE: NOT ALL KEY NOTES APPLY.
- WATER HEATER LOCATION - FOR GAS - LOCATE ON 18" HIGH PLATFORM - FOR INTERIOR LOCATION - PROVIDE PAN & DRAIN (REFER TO DETAILS)
 - WATER HEATER 3" VENT TO OUTSIDE AIR
 - MAIN LINE SHUT-OFF VALVE AND TEMP. & PRESSURE RELIEF VALVE
 - LIVE WALL BELOW
 - LINE OF FLOOR ABOVE
 - LINE OF FLOOR BELOW
 - 36" HIGH SHARDRAIL (REFER TO DETAIL SHEETS)
 - A/C PAD LOCATION
 - LOW WALL - REFER TO PLAN FOR HEIGHT
 - 2x6 STUD WALL
 - DBL. 2x4 WALL PER PLAN
 - INTERIOR SHELF - REFER TO PLAN FOR HEIGHT
 - FLAT SOFFIT
 - ARCHED SOFFIT
 - OPT. DOOR/WINDOW
 - PRE-MANUFACTURED DECORATIVE COLUMN (SIZE, SEE ELEV.) FYPON OR EQ. SURROUNDING STRUCTURAL POST.
 - BRICK / STONE VENEER - REFER TO ELEVATIONS
 - SECTIONAL GARAGE DOOR PER SPECS
 - 3" DIAM. CONCRETE FILLED PIPE BOLLARD 36" HIGH WITH MIN. 12" EMBEDMENT INTO CONCRETE. (NOT REQUIRED AT ELECTRIC WATER HEATERS OR FOR APPLIANCES LOCATED OUT OF THE VEHICLE'S NORMAL TRAVEL PATH)
 - P.T. POST W/ WRAP.
 - EGRESS WINDOW
 - WINDOW LEDGE - HEIGHT & WIDTH OF OPENING TO EXTEND 6" BEYOND WINDOW(S) ON ALL SIDES U.N.O.
 - SITE-BUILT COLUMN - SEE ELEVATION FOR TYPE
 - CONCRETE SLAB. SLOPE 1/4" PER FT. MIN. SEE PLAN FOR SITE

- ### FOUNDATION PLAN NOTES
- NOTE: NOT ALL KEY NOTES APPLY.
- CONCRETE PATIO/PORCH SLAB PER STRUCTURAL- SLOPE 1/4" PER FT. MIN.
 - CONCRETE GARAGE SLAB PER STRUCTURAL- SLOPE 1/8" PER 1'-0" MIN. TOWARD DOOR OPENING.
 - FOUNDATION PER STRUCTURAL.
 - STAIR LANDINGS: 36"x36" MIN.
 - CONCRETE DRIVEWAY SLOPE 1/4" PER FT. MIN. AWAY FROM GARAGE DOOR OPENING.
 - PROVIDE UNDER FLOOR VENTILATION
 - 4" TOE KICK FOR MASONRY VENEER.
 - 3" DIAMETER CONCRETE FILLED PIPE BOLLARD 36" HIGH WITH MIN. 12" EMBEDMENT INTO CONCRETE.
 - REFER TO CIVIL DRAWINGS FOR ALL FINISH SURFACE ELEVATIONS.
 - VERIFY LOCATION OF PIER FOOTINGS PER STRUCTURAL
 - 4" MIN. 7 3/4" MAX. TO HARD SURFACE.
 - A/C PAD. VERIFY LOCATION.
 - CRAWL SPACE ACCESS
 - 36" WIDE WALKWAY- SLOPE 1/4" PER FT. MIN.

NOTE: THE CRAWL SPACE IS TO BE CONDITIONED PER NC-R SECTION R409. THE CRAWL SPACE VAPOR RETARDER (BARRIER) IS TO BE PER NC-R SECTION R409.2.

NOTE: REFER TO BASIC ELEVATIONS FOR INFORMATION NOT SHOWN HERE
NOTE: REFER TO BASIC FLOOR PLAN FOR INFORMATION NOT SHOWN HERE

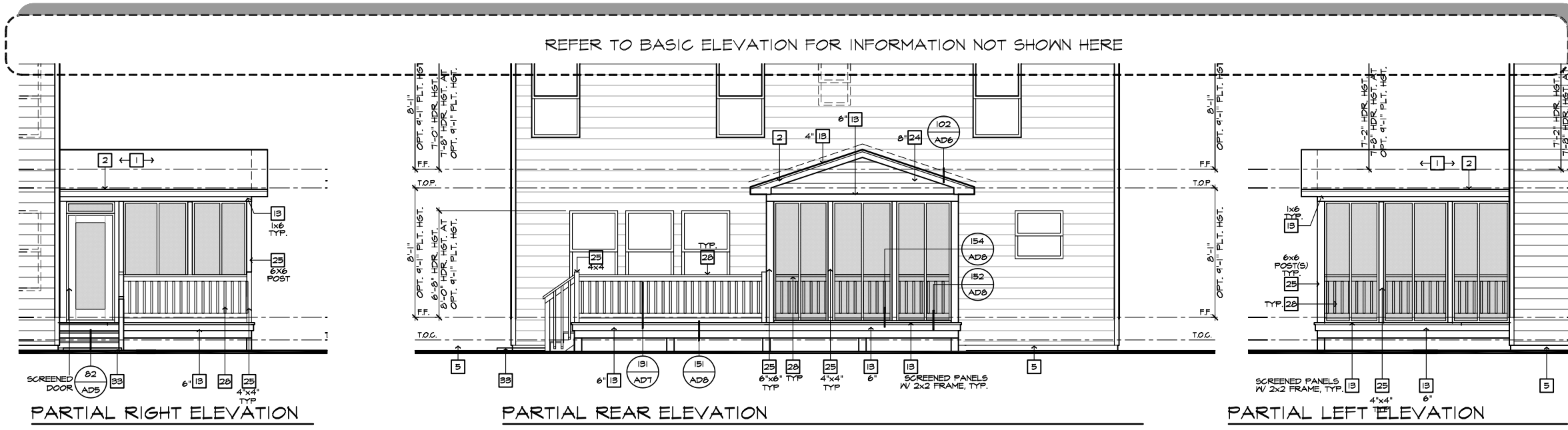

ROOF PLAN NOTES

INDICATES ROOF SLOPE AND DIRECTION, U.N.O.
4:12

ROOF MATERIAL: COMPOSITION SHINGLE
12" (INCHES) TYPICAL ROOF OVERHANG AT RAKE, U.N.O.
12" (INCHES) TYPICAL ROOF OVERHANG AT EAVE, U.N.O.
LOCATE EAVE/ RAFTER VENTS EQUALLY BALANCED AROUND HOUSE EXCEPT ABOVE SHEARWALL PANELS.

ATTIC VENT CALCULATIONS

PROVIDE 1 SQ. IN. OF VENTILATION PER 300 SQ. IN. OF ATTIC SPACE. PROVIDE THAT AT LEAST 50% & NO MORE THAN 80% OF THE REQ. VENTILATING AREA IS PROVIDED BY VENTILATORS LOCATED IN THE UPPER PORTION OF THE ATTIC, (HIGH VENTING) AT 3'-0" ABOVE EAVE VENT WITH THE BALANCE BEING PROVIDED BY EAVE VENTS, (LOW VENTING)
* CALCULATION BY 1/150, HIGH/LOW VENTING NOT REQUIRED.

AREA B / MAIN W/ W/ SCREENED-IN DECK:	SQ. FT. / 150	0.96 SQ. FT.
ATTIC AREA = 144	X 144 =	138 SQ. IN.
VENTILATION REQUIRED:	TOTAL HIGH & LOW =	138 SQ. IN.
VENTILATION PROVIDED:		
10 LF VENTILATED SOFFIT AT 6.9	SQ. IN. / LF. =	64 SQ. IN.
6 LF RIDGE VENT(S) AT 18	SQ. IN. EA. =	108 SQ. IN.
TOTAL VENTILATION PROVIDED:		172 SQ. IN.

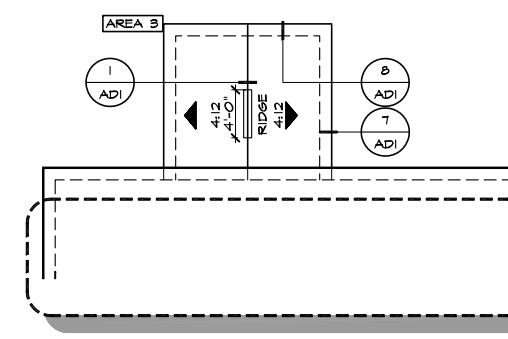

PARTIAL ROOF PLAN

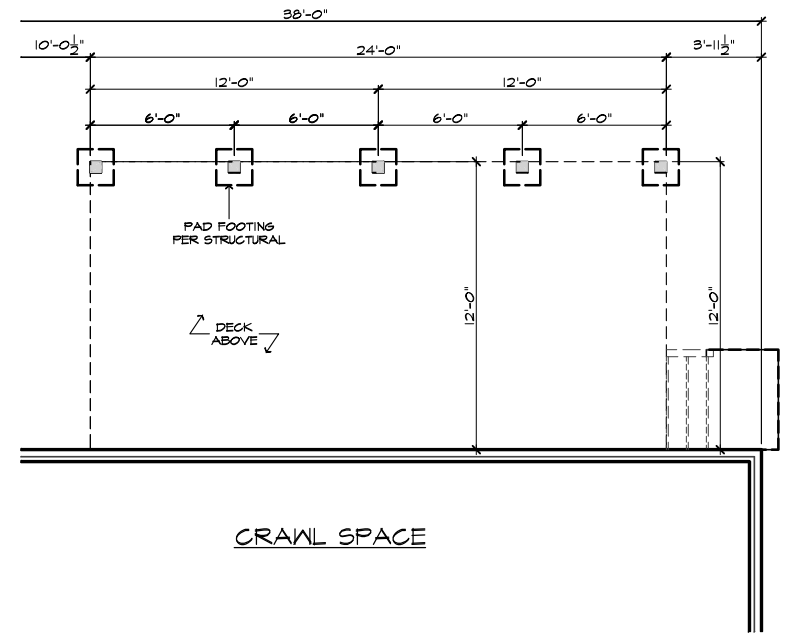

PARTIAL CRAWL SPACE PLAN

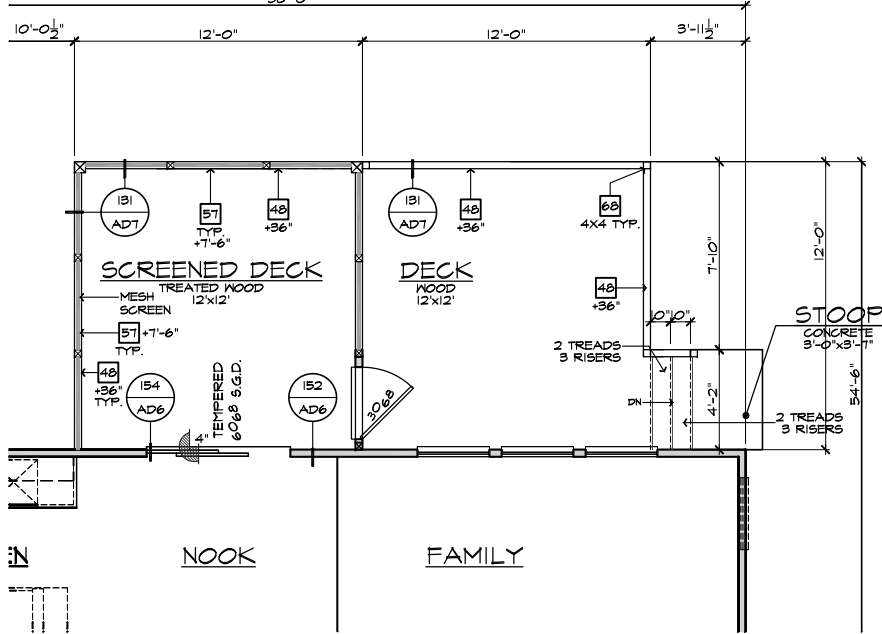

PARTIAL FIRST FLOOR PLAN

SCREEN DECK WITH OPEN DECK 'A/B/C/D' AT CRAWL SPACE
SCALE 1/4"=1'-0" (22"x34") - 1/8"=1'-0" (11"x17")

These designs and drawings are CONFIDENTIAL, and the exclusive property of KB Home Corporation, and are not to be disclosed without the express permission of KB Home Corporation. Copyright 2021 © KB Home Corporation, all rights reserved.

REFER TO BASIC ELEVATION FOR INFORMATION NOT SHOWN HERE

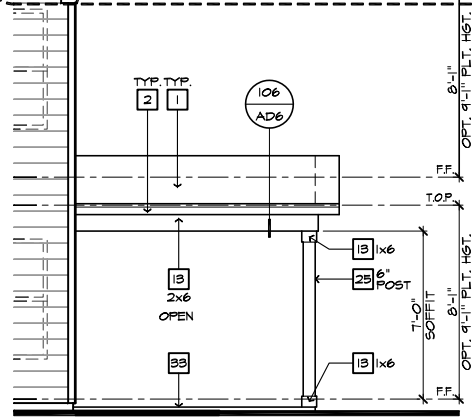

PARTIAL RIGHT ELEVATION



PARTIAL REAR ELEVATION

ROOF PLAN NOTES	
	INDICATES ROOF SLOPE AND DIRECTION, U.N.O.
ROOF MATERIAL: COMPOSITION SHINGLE	
12" (INCHES) TYPICAL ROOF OVERHANGS AT RAKE, U.N.O.	
12" (INCHES) TYPICAL ROOF OVERHANGS AT EAVE, U.N.O.	
LOCATE EAVE/ RAFTER VENTS EQUALLY BALANCED AROUND HOUSE EXCEPT ABOVE SHEARWALL PANELS.	
ATTIC VENT CALCULATIONS	
PROVIDE 1 SQ. IN. OF VENTILATION PER 500 SQ. IN. OF ATTIC SPACE. PROVIDE THAT AT LEAST 50% & NO MORE THAN 80% OF THE REQ. VENTILATING AREA IS PROVIDED BY VENTILATORS LOCATED IN THE UPPER PORTION OF THE ATTIC, (HIGH VENTING) AT 9'-0" ABOVE EAVE VENT WITH THE BALANCE BEING PROVIDED BY EAVE VENTS, (LOW VENTING) (2018 NC-R 200.2)	
* CALCULATION BY 1/50, HIGH/LOW VENTING NOT REQUIRED.	
APPROXIMATE RIDGE VENT LOCATIONS SHOWN. ACTUAL LOCATIONS TO BE DETERMINED IN THE FIELD.	
AREA 3 / MAIN IV COVERED PATIO	
VENTILATION REQUIRED:	
ATTIC AREA = 100	SQ. FT. / 150 = 0.67 SQ. FT.
	X 144 = 96 SQ. IN.
	TOTAL HIGH & LOW = 96 SQ. IN.
VENTILATION PROVIDED:	
6	LF VENTILATED SOFFIT AT 6.9 SQ. IN. / LF. = 55 SQ. IN.
4	LF RIDGE VENT(S) AT 18 SQ. IN. EA. = 72 SQ. IN.
TOTAL VENTILATION PROVIDED: 127 SQ. IN.	

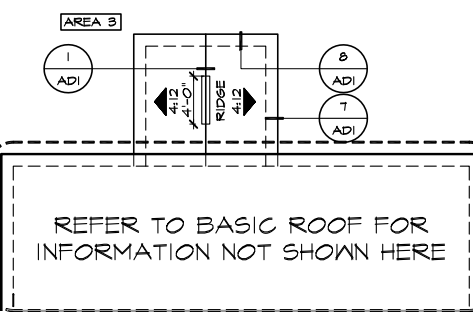

PARTIAL ROOF PLAN

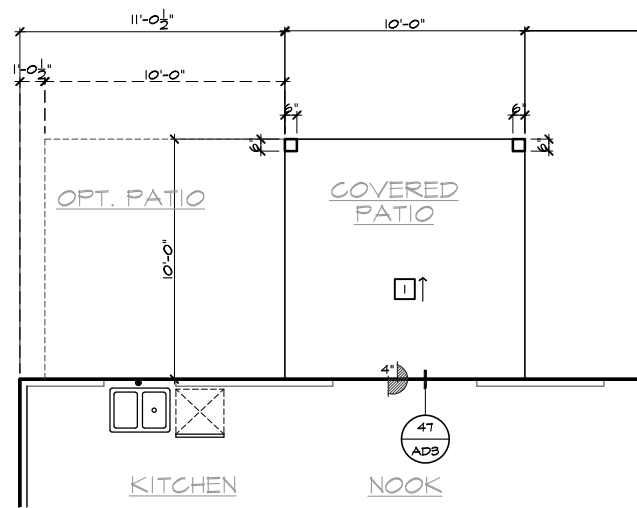

PARTIAL SLAB INTERFACE PLAN

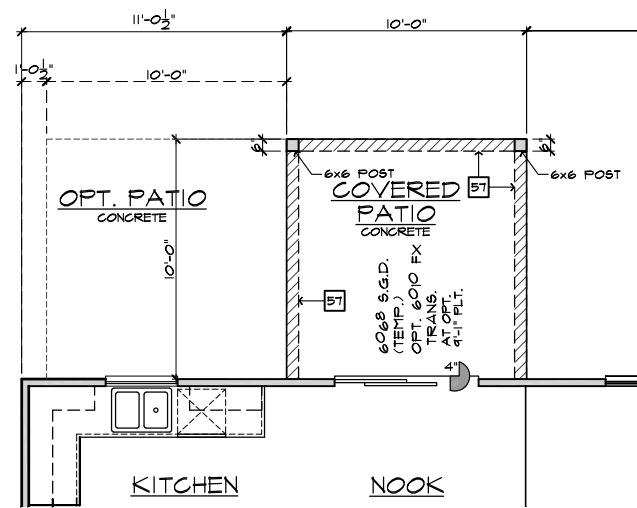

PARTIAL FIRST FLOOR PLAN

COVERED PATIO AT SLAB ON GRADE

SCALE 1/4"=1'-0" (22'x34') - 1/8"=1'-0" (11'x17')

ELEVATION NOTES

- NOTE: NOT ALL KEY NOTES APPLY.
1. ROOF MATERIAL - REFER TO ROOF NOTES
 2. 2X FASCIA/BARGE BOARD WITH FASCIA CAP
 3. 6:1 FLASHING
 4. 6:1 FLASHING & SADDLE/CRICKET
 5. 6:1 DRIP SCREED
 6. 24"x24" CHIMNEY
 7. DECORATIVE VENT
 8. DECORATIVE CORBEL
 9. DECORATIVE SHUTTERS
 10. PEDIMENT. SEE ELEVATION FOR TYPE
 11. RECESSED ELEMENT
 12. DECORATIVE TRIM FYPON OR EQ. SEE ELEVATION FOR TYPE
 13. TRIM PER SPEC- SEE ELEVATION FOR SIZE
 14. SYNTHETIC MATERIAL
 15. PRE-MANUFACTURED DECORATIVE COLUMN (SIZE, SEE ELEV.) FYPON OR EQ. SURROUNDING STRUCTURAL POST.
 16. SITE-BUILT COLUMN - SEE ELEVATION FOR TYPE
 17. SHAKE SIDING
 18. STONE VENEER PER SPECS
 19. BRICK/MASONRY VENEER PER SPECS
 20. BUILT UP BRICK COLUMN
 21. SOLDIER COURSE
 22. RAILLOCK COURSE
 23. FRIEZE BOARD
 24. SIDING IV 4" CORNER TRIM PER SPECS
 25. P.T. POST IV WRAP - SEE STRUCTURAL FOR SIZE
 26. PRE-FAB DECORATIVE TRIM
 27. LIGHT WEIGHT PRECAST STONE TRIM
 28. P.T. LUMBER RAILINGS (+36" U.N.O.)
 29. WRAP
 30. DECORATIVE WINDOW/DOOR TRIM - FYPON OR EQ. SEE ELEVATION FOR SIZE.
 31. BRACKET OR KICKER - FYPON OR EQ.
 32. ENTRY DOOR
 33. CONCRETE STOOP/ PORCH - SEE SLAB INTERFACE PLAN.
 34. SECTIONAL GARAGE DOOR PER SPECS
 35. ALUMINUM WRAP
 36. OPTIONAL DOOR/WINDOW - REFER TO PLAN OPTIONS
 37. OPTIONAL STANDING SEAM METAL ROOF
 38. KEYSTONE
 39. SOLDIER CROWN
 40. JACK SOLDIER COURSE
 41. WATER TABLE
 42. ATRIUM DOOR
 43. PILASTER - SEE ELEVATION FOR TYPE

PARTIAL PLAN NOTES

- NOTE: NOT ALL KEY NOTES APPLY.
21. WATER HEATER LOCATION - FOR GAS - LOCATE ON 18" HIGH PLATFORM - FOR INTERIOR LOCATION - PROVIDE PAN & DRAIN (REFER TO DETAILS)
 28. WATER HEATER 3" VENT TO OUTSIDE AIR
 29. MAIN LINE SHUT-OFF VALVE AND TEMP. & PRESSURE RELIEF VALVE
 34. LINE WALL BELOW
 41. LINE OF FLOOR ABOVE
 42. LINE OF FLOOR BELOW
 43. MIN. 36" HIGH GUARDRAIL (REFER TO DETAIL SHEETS)
 50. A/C PAD LOCATION
 51. LOW WALL - REFER TO PLAN FOR HEIGHT
 52. 2x6 STUD WALL
 54. DEL. 2x4 MALL PER PLAN
 55. INTERIOR SHELF - REFER TO PLAN FOR HEIGHT
 57. FLAT SOFFIT
 58. ARCHED SOFFIT
 60. OPT. DOOR / WINDOW
 61. PRE-MANUFACTURED DECORATIVE COLUMN (SIZE, SEE ELEV.) FYPON OR EQ. SURROUNDING STRUCTURAL POST.
 62. BRICK / STONE VENEER - REFER TO ELEVATIONS
 63. SECTIONAL GARAGE DOOR PER SPECS
 66. 3" DIAM. CONCRETE FILLED PIPE BOLLARD 36" HIGH WITH MIN. 12" EMBEDMENT INTO CONCRETE. (NOT REQUIRED AT ELECTRIC WATER HEATERS OR FOR APPLIANCES LOCATED OUT OF THE VEHICLE'S NORMAL TRAVEL PATH)
 68. P.T. POST IV WRAP.
 70. EGRESS WINDOW
 75. WINDOW LEDGE. HEIGHT & WIDTH OF OPENING TO EXTEND 6" BEYOND WINDOW(S) ON ALL SIDES U.N.O.
 76. SITE-BUILT COLUMN - SEE ELEVATION FOR TYPE
 77. CONCRETE SLAB. SLOPE 1/4" PER FT. MIN. SEE PLAN FOR SITE.

SLAB PLAN NOTES

- NOTE: NOT ALL KEY NOTES APPLY.
1. CONCRETE PATIO/PORCH SLAB PER STRUCTURAL- SLOPE 1/4" PER FT. MIN.
 2. CONCRETE GARAGE SLAB PER STRUCTURAL- SLOPE 1/8" PER 1'-0" MIN. TOWARD DOOR OPENINGS.
 3. CONCRETE FOUNDATION PER STRUCTURAL.
 4. CONCRETE STOOP: 36"x36" STANDARD SLOPE 1/4" PER FT. MIN.
 5. CONCRETE DRIVEMAY SLOPE 1/4" PER FT. MIN. AWAY FROM GARAGE DOOR OPENINGS.
 6. PROVIDE ELECTRICAL CONDUIT UNDER SLAB AT ISLAND. VERIFY LOCATION.
 7. 5" BRICK LEDGE FOR MASONRY VENEER.
 8. 3" DIAMETER CONCRETE FILLED PIPE BOLLARD 36" HIGH WITH MIN. 12" EMBEDMENT INTO CONCRETE.
 9. REFER TO CIVIL DRAWINGS FOR ALL FINISH SURFACE ELEVATIONS.
 10. VERIFY ALL PLUMBING SUB DIMENSIONS SHOWN HERE PRIOR TO POUR OF SLAB
 11. 4" MIN. @ 1/4" MAX. TO HARD SURFACE.
 12. A/C PAD. VERIFY LOCATION.
 13. 36" WIDE WALKWAY- SLOPE 1/4" PER FT. MIN.

NOTE: REFER TO BASIC ROOF PLAN FOR INFORMATION NOT SHOWN HERE

NOTE: REFER TO BASIC ELEVATIONS FOR INFORMATION NOT SHOWN HERE

NOTE: REFER TO BASIC FLOOR PLAN FOR INFORMATION NOT SHOWN HERE

NOTE: REFER TO BASIC SLAB PLAN FOR INFORMATION NOT SHOWN HERE

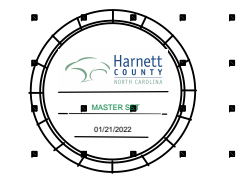
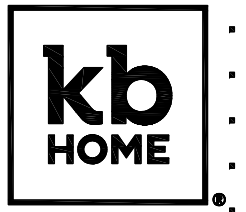

NORTH CAROLINA 40' SERIES

KB HOME
NORTH CAROLINA DIVISION
4506 S. MIAMI BLVD.
SUITE 180
DURHAM, NC 27703
TEL: (919) 768-7980
FAX: (919) 544-2928

2018 NORTH CAROLINA STATE BUILDING CODES

ISSUE DATE: 01/08/15
PROJECT No.: 1350999:56
DIVISION MGR.: DCS
REVISIONS: 08/20/20

- 11 DIVISION REVISION NC13654NCP - 08/28/19 - FAB
- 12 DIVISION REVISION NC1967NCP - 09/26/19 - FAB
- 13 DIVISION REVISION NC2003NCP - 12/19/19 - CL
- 14 VENTILATION NC2000NCP - 01/17/20 - CL
- 15 DIVISION REVISION NC2003NCP - 02/10/20 - MCP
- 16 DIVISION REVISION NC2007NCP - 03/04/20 - KBA
- 17 HOME OFFICE CORP2009CORP-08/20/20-CTD

FOR INTERNAL USE ONLY

REVIEWED BY:

1.	
2.	
3.	
4.	
5.	
6.	

PLAN: 238.2338
SHEET: 8.1

SPEC. LEVEL 1
RALEIGH-DURHAM 40' SERIES

These designs and drawings are CONFIDENTIAL, and the exclusive property of KB Home Corporation, and are not to be disclosed without the express permission of KB Home Corporation. Copyright 2020 © KB Home Corporation, all rights reserved.

REFER TO BASIC ELEVATION FOR INFORMATION NOT SHOWN HERE

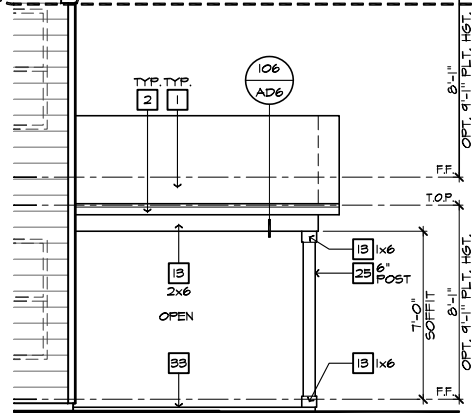

PARTIAL RIGHT ELEVATION



PARTIAL REAR ELEVATION

- # ELEVATION NOTES**
- NOTE: NOT ALL KEY NOTES APPLY.
1. ROOF MATERIAL - REFER TO ROOF NOTES
 2. 2X FASCIA/BARGE BOARD WITH FASCIA CAP
 3. 6.1. FLASHING
 4. 6.1. FLASHING & SADDLE/CRICKET
 5. 6.1. DRIP SCREED
 6. 24"x24" CHIMNEY
 7. DECORATIVE VENT
 8. DECORATIVE CORBEL
 9. DECORATIVE SHUTTERS
 10. PEDIMENT. SEE ELEVATION FOR TYPE
 11. RECESSED ELEMENT
 12. DECORATIVE TRIM FYPON OR EQ. SEE ELEVATION FOR TYPE
 13. TRIM PER SPEC - SEE ELEVATION FOR SIZE
 14. SYNTHETIC MATERIAL
 15. PRE-MANUFACTURED DECORATIVE COLUMN (SIZE, SEE ELEV.) FYPON OR EQ. SURROUNDING STRUCTURAL POST.
 16. SITE-BUILT COLUMN - SEE ELEVATION FOR TYPE
 17. SHAKE SIDING
 18. STONE VENEER PER SPECS
 19. BRICK/MASONRY VENEER PER SPECS
 20. BUILT UP BRICK COLUMN
 21. SOLDIER COURSE
 22. ROWLOCK COURSE
 23. FRIEZE BOARD
 24. SIDING W/ 4" CORNER TRIM PER SPECS
 25. P.T. POST W/ WRAP - SEE STRUCTURAL FOR SIZE
 26. PRE-FAB DECORATIVE TRIM
 27. LIGHT WEIGHT PRECAST STONE TRIM
 28. P.T. LUMBER RAILINGS (36" U.N.O.)
 29. WRAP
 30. DECORATIVE WINDOW/DOOR TRIM - FYPON OR EQ. SEE ELEVATION FOR SIZE.
 31. BRACKET OR KICKER - FYPON OR EQ.
 32. ENTRY DOOR
 33. CONCRETE STOOP/PORCH - SEE SLAB INTERFACE PLAN.
 34. SECTIONAL GARAGE DOOR PER SPECS
 35. ALUMINUM WRAP
 36. OPTIONAL DOOR/WINDOW - REFER TO PLAN OPTIONS
 37. OPTIONAL STANDING SEAM METAL ROOF
 38. KEYSTONE
 39. SOLDIER CROWN
 40. JACK SOLDIER COURSE
 41. WATER TABLE
 42. ATRIUM DOOR
 43. PILASTER - SEE ELEVATION FOR TYPE

- # PARTIAL PLAN NOTES**
- NOTE: NOT ALL KEY NOTES APPLY.
27. WATER HEATER LOCATION - FOR GAS - LOCATE ON 18" HIGH PLATFORM - FOR INTERIOR LOCATION - PROVIDE PAN & DRAIN (REFER TO DETAILS)
 28. WATER HEATER 2" VENT TO OUTSIDE AIR
 29. MAIN LINE SHUT-OFF VALVE AND TEMP. & PRESSURE RELIEF VALVE
 34. LINE V. WALL BELOW
 41. LINE OF FLOOR ABOVE
 42. LINE OF FLOOR BELOW
 43. MIN. 36" HIGH GUARDRAIL (REFER TO DETAIL SHEETS)
 50. A/C PAD LOCATION
 51. LOW WALL - REFER TO PLAN FOR HEIGHT
 52. 2x6 STUD WALL
 54. DEL. 2x4 WALL PER PLAN
 55. INTERIOR SHELF - REFER TO PLAN FOR HEIGHT
 57. FLAT SOFFIT
 58. ARCHED SOFFIT
 60. OPT. DOOR/WINDOW
 61. PRE-MANUFACTURED DECORATIVE COLUMN (SIZE, SEE ELEV.) FYPON OR EQ. SURROUNDING STRUCTURAL POST.
 62. BRICK / STONE VENEER - REFER TO ELEVATIONS
 63. SECTIONAL GARAGE DOOR PER SPECS
 66. 3" DIAM. CONCRETE FILLED PIPE BOLLARD 36" HIGH WITH MIN. 12" EMBEDMENT INTO CONCRETE. (NOT REQUIRED AT ELECTRIC WATER HEATERS OR FOR APPLIANCES LOCATED OUT OF THE VEHICLE'S NORMAL TRAVEL PATH)
 68. P.T. POST W/ WRAP.
 75. EGRESS WINDOW
 76. WINDOW LEDGE. HEIGHT & WIDTH OF OPENING TO EXTEND 6" BEYOND WINDOW(S) ON ALL SIDES U.N.O.
 77. SITE-BUILT COLUMN - SEE ELEVATION FOR TYPE
 78. CONCRETE SLAB. SLOPE 1/4" PER FT. MIN. SEE PLAN FOR SIZE.

ROOF PLAN NOTES

INDICATES ROOF SLOPE AND DIRECTION, U.N.O.
4:12

ROOF MATERIAL: COMPOSITION SHINGLE

12" (INCHES) TYPICAL ROOF OVERHANGS AT RAKE, U.N.O.
12" (INCHES) TYPICAL ROOF OVERHANGS AT EAVE, U.N.O.
LOCATE EAVE/ RAFTER VENTS EQUALLY BALANCED AROUND HOUSE EXCEPT ABOVE SHEARWALL PANELS.

ATTIC VENT CALCULATIONS

PROVIDE 1 SQ. IN. OF VENTILATION PER 500 SQ. IN. OF ATTIC SPACE. PROVIDE THAT AT LEAST 50% & NO MORE THAN 80% OF THE REQ. VENTILATING AREA IS PROVIDED BY VENTILATORS LOCATED IN THE UPPER PORTION OF THE ATTIC, (HIGH VENTING) AT 3'-0" ABOVE EAVE VENT WITH THE BALANCE BEING PROVIDED BY EAVE VENTS, (LOW VENTING) (2018 NC-R 906.2)
* CALCULATION BY 1/50, HIGH/LOW VENTING NOT REQUIRED.
APPROXIMATE RIDGE VENT LOCATIONS SHOWN. ACTUAL LOCATIONS TO BE DETERMINED IN THE FIELD.

AREA B / MAIN W/ EXTENDED COVERED PATIO.			
VENTILATION REQUIRED:			
ATTIC AREA = 200	SQ. FT. / 150	133 SQ. FT.	
	X 144 =	142 SQ. IN.	
	TOTAL HIGH & LOW =	142 SQ. IN.	
VENTILATION PROVIDED:			
16	LF VENTILATED SOFFIT AT 6" SQ. IN. / LF. =	110 SQ. IN.	
6	LF RIDGE VENT(S) AT 18" SQ. IN. EA. =	144 SQ. IN.	
TOTAL VENTILATION PROVIDED:		254 SQ. IN.	

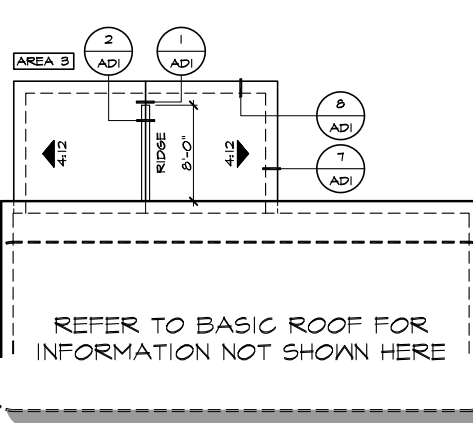

PARTIAL ROOF PLAN

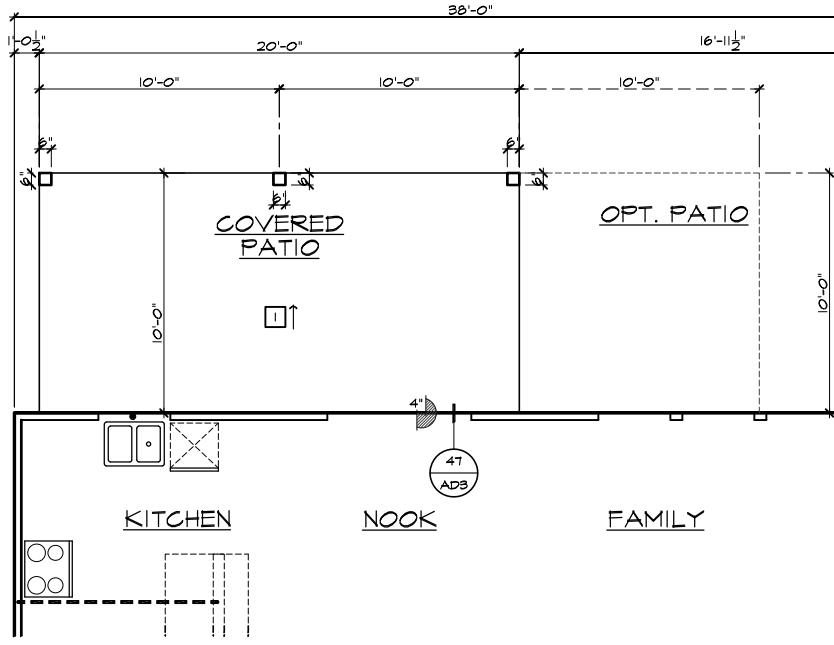

PARTIAL SLAB INTERFACE PLAN

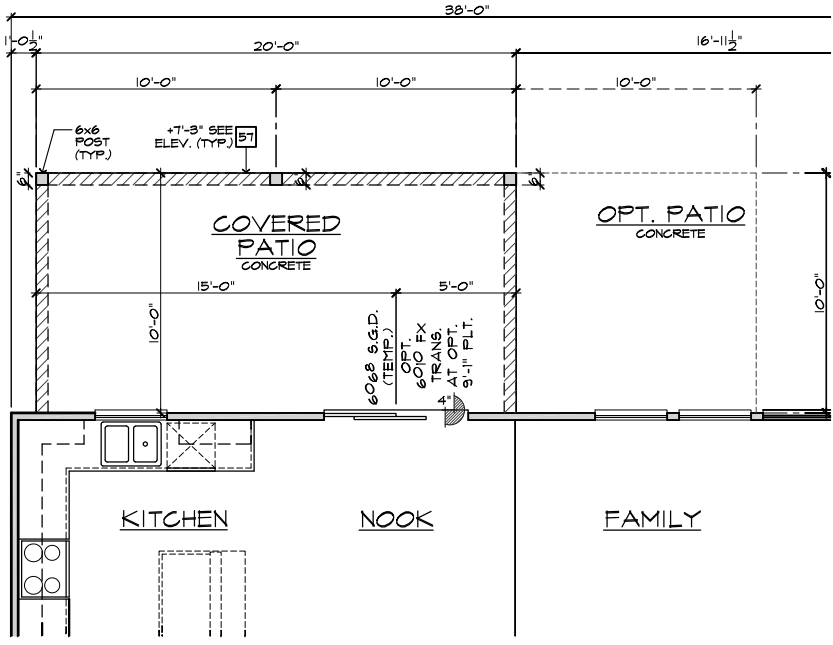

PARTIAL FIRST FLOOR PLAN

- # SLAB PLAN NOTES**
- NOTE: NOT ALL KEY NOTES APPLY.
1. CONCRETE PATIO/PORCH SLAB PER STRUCTURAL- SLOPE 1/4" PER FT. MIN.
 2. CONCRETE GARAGE SLAB PER STRUCTURAL- SLOPE 1/8" PER FT. MIN. TOWARD DOOR OPENINGS.
 3. CONCRETE FOUNDATION PER STRUCTURAL.
 4. CONCRETE STOOP: 36"x36" STANDARD SLOPE 1/4" PER FT. MIN.
 5. CONCRETE DRIVEWAY SLOPE 1/4" PER FT. MIN. AWAY FROM GARAGE DOOR OPENINGS.
 6. PROVIDE ELECTRICAL CONDUIT UNDER SLAB AT ISLAND. VERIFY LOCATION.
 7. 5" BRICK LEDGE FOR MASONRY VENEER.
 8. 3" DIAMETER CONCRETE FILLED PIPE BOLLARD 36" HIGH WITH MIN. 12" EMBEDMENT INTO CONCRETE.
 9. REFER TO CIVIL DRAWINGS FOR ALL FINISH SURFACE ELEVATIONS.
 10. VERIFY ALL PLUMBING STUD DIMENSIONS SHOWN HERE PRIOR TO POUR OF SLAB.
 11. 4" MIN. @ 1/4" MAX. TO HARD SURFACE.
 12. A/C PAD. VERIFY LOCATION.
 13. 36" WIDE WALKWAY- SLOPE 1/4" PER FT. MIN.

NOTE: REFER TO BASIC ROOF PLAN FOR INFORMATION NOT SHOWN HERE

NOTE: REFER TO BASIC ELEVATIONS FOR INFORMATION NOT SHOWN HERE

NOTE: REFER TO BASIC FLOOR PLAN FOR INFORMATION NOT SHOWN HERE

NOTE: REFER TO BASIC SLAB PLAN FOR INFORMATION NOT SHOWN HERE

EXTENDED COVERED PATIO AT SLAB ON GRADE
SCALE 1/4"=1'-0" (22"x34") - 1/8"=1'-0" (11"x17")

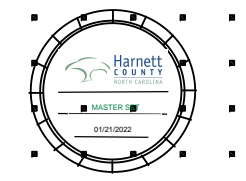
**NORTH CAROLINA
40' SERIES**

KB HOME
NORTH CAROLINA DIVISION

4506 S. MIAMI BLVD.
SUITE 180
DURHAM, NC 27703
TEL: (919) 768-7980
FAX: (919) 544-2928

**2018 NORTH
CAROLINA STATE
BUILDING
CODES**

ISSUE DATE: 01/08/15
PROJECT No.: 1350999:56
DIVISION MGR.: DCS
REVISIONS: 08/20/20

11	DIVISION REVISION	NC13654NCP	08/28/19	FAB
12	DIVISION REVISION	NC19657NCP	09/26/19	FAB
13	DIVISION REVISION	NC20053NCP	12/19/19	CL
14	VENTILATION	NC20004NCP	01/17/20	CL
15	DIVISION REVISION	NC20053NCP	02/10/20	MCP
16	DIVISION REVISION	NC20017NCP	03/04/20	KBA
17	HOME OFFICE	CORP20059CORP	08/20/20	CTD

FOR INTERNAL USE ONLY
REVIEWED BY:

1.	_____
2.	_____
3.	_____
4.	_____
5.	_____
6.	_____

PLAN:
238.2338

SHEET:
8.2

SPEC. LEVEL 1
**RALEIGH-DURHAM
40' SERIES**

These designs and drawings are CONFIDENTIAL, and the exclusive property of KB Home Corporation, and are not to be disclosed without the express permission of KB Home Corporation. Copyright 2020 © KB Home Corporation, all rights reserved.

REFER TO BASIC ELEVATION FOR INFORMATION NOT SHOWN HERE

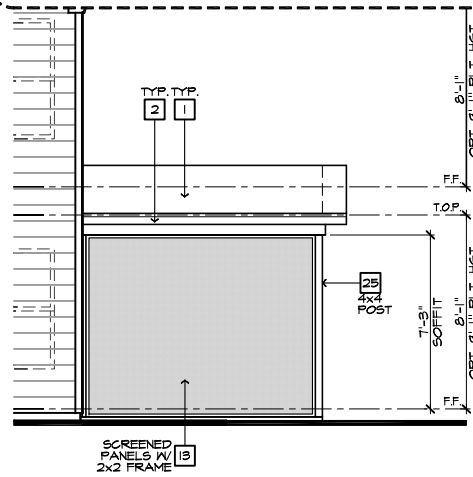

PARTIAL RIGHT ELEVATION

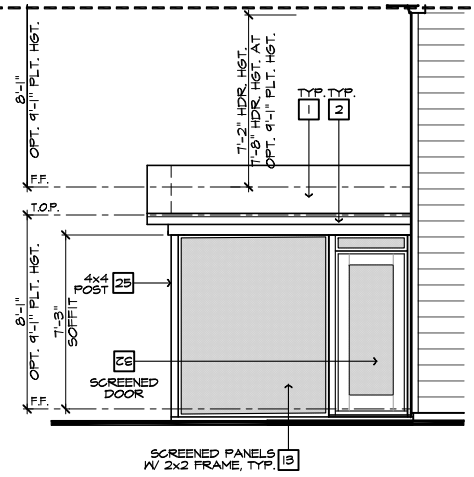

PARTIAL LEFT ELEVATION

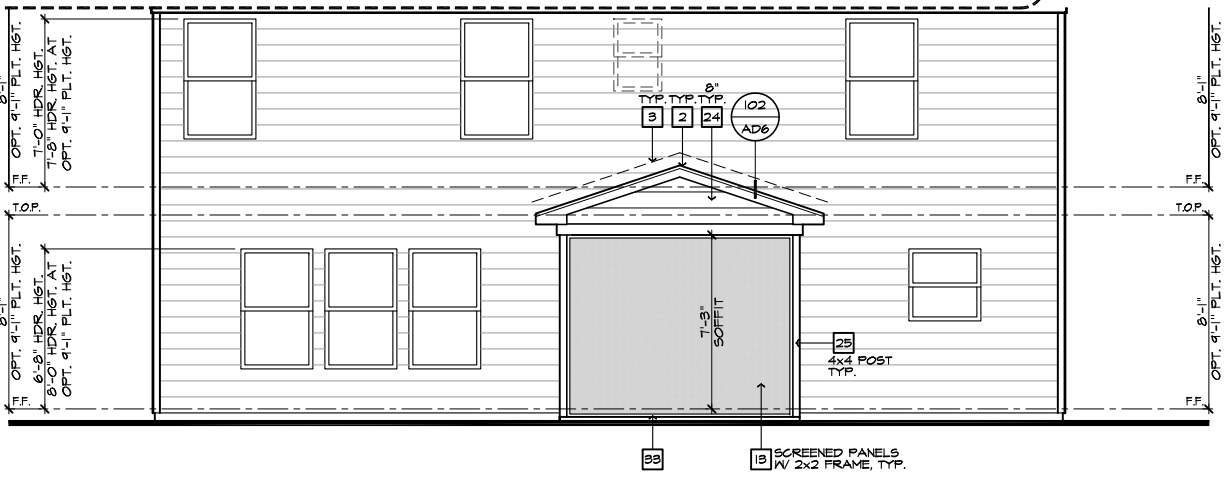

PARTIAL REAR ELEVATION

- ELEVATION NOTES**
- NOTE: NOT ALL KEY NOTES APPLY.
1. ROOF MATERIAL - REFER TO ROOF NOTES
 2. 2X FASCIA/BARGE BOARD WITH FASCIA CAP
 3. 6:1 FLASHING
 4. 6:1 FLASHING & SADDLE/CRICKET
 5. 6:1 DRIP SCREED
 6. 24"x24" CHIMNEY
 7. DECORATIVE VENT
 8. DECORATIVE CORBEL
 9. DECORATIVE SHUTTERS
 10. PEDIMENT. SEE ELEVATION FOR TYPE
 11. RECESSED ELEMENT
 12. DECORATIVE TRIM FYPON OR EQ. SEE ELEVATION FOR TYPE
 13. TRIM PER SPEC- SEE ELEVATION FOR SIZE
 14. SYNTHETIC MATERIAL
 15. PRE-MANUFACTURED DECORATIVE COLUMN (SIZE, SEE ELEV.) FYPON OR EQ. SURROUNDING STRUCTURAL POST.
 16. SITE-BUILT COLUMN - SEE ELEVATION FOR TYPE
 17. SHAKE SIDING
 18. STONE VENEER PER SPECS
 19. BRICK/MASONRY VENEER PER SPECS
 20. BUILT UP BRICK COLUMN
 21. SOLDIER COURSE
 22. RAILLOCK COURSE
 23. FRIEZE BOARD
 24. SIDING W/ 4" CORNER TRIM PER SPECS
 25. P.T. POST W/ WRAP - SEE STRUCTURAL FOR SIZE
 26. PRE-FAB DECORATIVE TRIM
 27. LIGHT WEIGHT PRECAST STONE TRIM
 28. P.T. LUMBER RAILINGS (36" U.N.O.)
 29. WRAP
 30. DECORATIVE WINDOW/DOOR TRIM - FYPON OR EQ. SEE ELEVATION FOR SIZE.
 31. BRACKET OR KICKER - FYPON OR EQ.
 32. ENTRY DOOR
 33. CONCRETE STOOP/ PORCH - SEE SLAB INTERFACE PLAN.
 34. SECTIONAL GARAGE DOOR PER SPECS
 35. ALUMINUM WRAP
 36. OPTIONAL DOOR/WINDOW - REFER TO PLAN OPTIONS
 37. OPTIONAL STANDING SEAM METAL ROOF
 38. KEYSTONE
 39. SOLDIER CROWN
 40. JACK SOLDIER COURSE
 41. WATER TABLE
 42. ATRIUM DOOR
 43. PILASTER - SEE ELEVATION FOR TYPE

- PARTIAL PLAN NOTES**
- NOTE: NOT ALL KEY NOTES APPLY.
27. WATER HEATER LOCATION - FOR GAS - LOCATE ON 18" HIGH PLATFORM - FOR INTERIOR LOCATION - PROVIDE PAN & DRAIN (REFER TO DETAILS)
 28. WATER HEATER 3" VENT TO OUTSIDE AIR
 29. MAIN LINE SHUT-OFF VALVE AND TEMP. & PRESSURE RELIEF VALVE
 34. LINE V. WALL BELOW
 41. LINE OF FLOOR ABOVE
 42. LINE OF FLOOR BELOW
 43. MIN. 36" HIGH GUARDRAIL (REFER TO DETAIL SHEETS)
 50. A/C PAD LOCATION
 51. LOW WALL - REFER TO PLAN FOR HEIGHT
 52. 2x6 STUD WALL
 54. DEL. 2x4 WALL PER PLAN
 55. INTERIOR SHELF - REFER TO PLAN FOR HEIGHT
 57. FLAT SOFFIT
 58. ARCHED SOFFIT
 60. OPT. DOOR/WINDOW
 61. PRE-MANUFACTURED DECORATIVE COLUMN (SIZE, SEE ELEV.) FYPON OR EQ. SURROUNDING STRUCTURAL POST.
 62. BRICK / STONE VENEER - REFER TO ELEVATIONS
 63. SECTIONAL GARAGE DOOR PER SPECS
 66. 3" DIAM. CONCRETE FILLED PIPE BOLLARD 36" HIGH WITH MIN. 12" EMBEDMENT INTO CONCRETE. (NOT REQUIRED AT ELECTRIC WATER HEATERS OR FOR APPLIANCES LOCATED OUT OF THE VEHICLE'S NORMAL TRAVEL PATH)
 68. P.T. POST W/ WRAP.
 70. EGRESS WINDOW
 75. WINDOW LEDGE. HEIGHT & WIDTH OF OPENING TO EXTEND 6" BEYOND WINDOW(S) ON ALL SIDES U.N.O.
 76. SITE-BUILT COLUMN - SEE ELEVATION FOR TYPE
 77. CONCRETE SLAB. SLOPE 1/4" PER FT. MIN. SEE PLAN FOR SIZE.

ROOF PLAN NOTES

INDICATES ROOF SLOPE AND DIRECTION, U.N.O.

4:12

ROOF MATERIAL: COMPOSITION SHINGLE

12" (INCHES) TYPICAL ROOF OVERHANGS AT RAKE, U.N.O.

12" (INCHES) TYPICAL ROOF OVERHANGS AT EAVE, U.N.O.

LOCATE EAVE/ RAFTER VENTS EQUALLY BALANCED AROUND HOUSE EXCEPT ABOVE SHEARWALL PANELS.

ATTIC VENT CALCULATIONS

PROVIDE 1 SQ. IN. OF VENTILATION PER 500 SQ. IN. OF ATTIC SPACE. PROVIDE THAT AT LEAST 50% & NO MORE THAN 80% OF THE REQ. VENTILATING AREA IS PROVIDED BY VENTILATORS LOCATED IN THE UPPER PORTION OF THE ATTIC (HIGH VENTING) AT 3'-0" ABOVE EAVE VENT WITH THE BALANCE BEING PROVIDED BY EAVE VENTS (LOW VENTING) (2018 NC-R 200.2)

* CALCULATION BY 1/50, HIGH/LOW VENTING NOT REQUIRED.

APPROXIMATE RIDGE VENT LOCATIONS SHOWN. ACTUAL LOCATIONS TO BE DETERMINED IN THE FIELD.

AREA 3 / MAIN W/ SCREENED-IN COVERED PATIO.

VENTILATION REQUIRED:

ATTIC AREA = 100	SQ. FT. / 150	0.67 SQ. FT.
	X 144 =	96 SQ. IN.
	TOTAL HIGH & LOW =	96 SQ. IN.

VENTILATION PROVIDED:

6	LF VENTILATED SOFFIT AT	6.9	SQ. IN. / LF. =	55	SQ. IN.
4	LF RIDGE VENT(S) AT	18	SQ. IN. EA. =	72	SQ. IN.
	TOTAL VENTILATION PROVIDED:			127	SQ. IN.

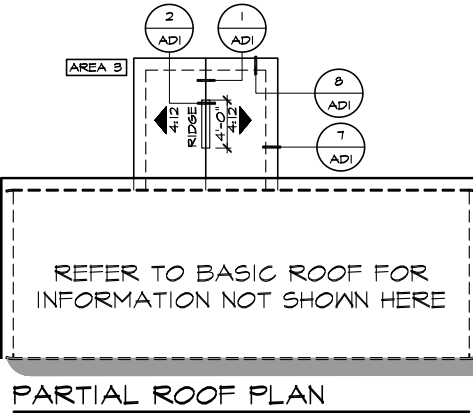

PARTIAL ROOF PLAN

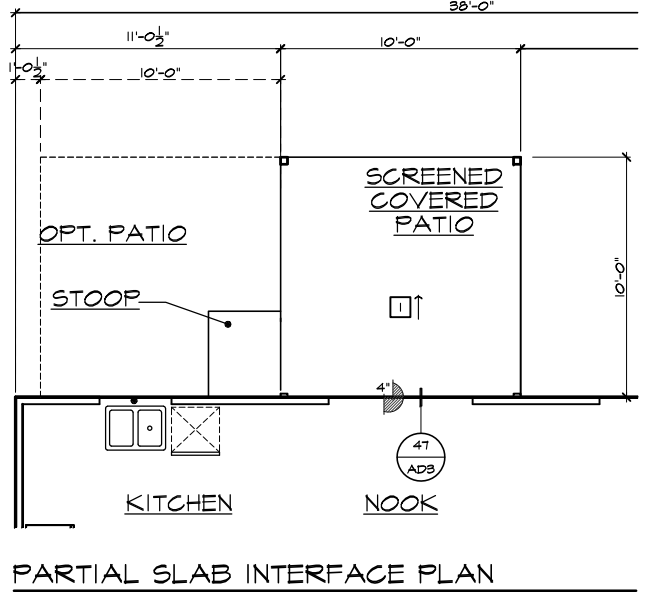

PARTIAL SLAB INTERFACE PLAN

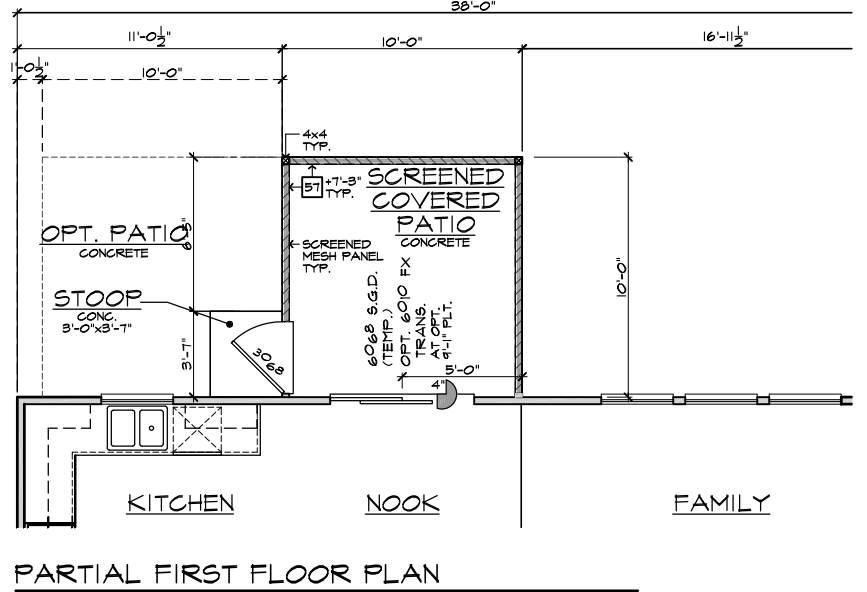

PARTIAL FIRST FLOOR PLAN

- SLAB PLAN NOTES**
- NOTE: NOT ALL KEY NOTES APPLY.
1. CONCRETE PATIO/PORCH SLAB PER STRUCTURAL- SLOPE 1/4" PER FT. MIN.
 2. CONCRETE GARAGE SLAB PER STRUCTURAL- SLOPE 1/8" PER FT. MIN. TOWARD DOOR OPENING.
 3. CONCRETE FOUNDATION PER STRUCTURAL.
 4. CONCRETE STOOP: 36"x36" STANDARD SLOPE 1/4" PER FT. MIN.
 5. CONCRETE DRIVEWAY SLOPE 1/4" PER FT. MIN. AWAY FROM GARAGE DOOR OPENING.
 6. PROVIDE ELECTRICAL CONDUIT UNDER SLAB AT ISLAND. VERIFY LOCATION.
 7. 3" BRICK LEDGE FOR MASONRY VENEER.
 8. 3" DIAMETER CONCRETE FILLED PIPE BOLLARD 36" HIGH WITH MIN. 12" EMBEDMENT INTO CONCRETE.
 9. REFER TO CIVIL DRAWINGS FOR ALL FINISH SURFACE ELEVATIONS.
 10. VERIFY ALL PLUMBING STUD DIMENSIONS SHOWN HERE PRIOR TO POUR OF SLAB.
 11. 4" MIN. @ 1/4" MAX. TO HARD SURFACE.
 12. A/C PAD. VERIFY LOCATION.
 13. 36" WIDE WALKWAY- SLOPE 1/4" PER FT. MIN.

- NOTE: REFER TO BASIC ROOF PLAN FOR INFORMATION NOT SHOWN HERE
- NOTE: REFER TO BASIC ELEVATIONS FOR INFORMATION NOT SHOWN HERE
- NOTE: REFER TO BASIC FLOOR PLAN FOR INFORMATION NOT SHOWN HERE
- NOTE: REFER TO BASIC SLAB PLAN FOR INFORMATION NOT SHOWN HERE

COVERED SCREENED PATIO AT SLAB ON GRADE

SCALE 1/4"=1'-0" (22'x34") - 1/8"=1'-0" (11'x17')

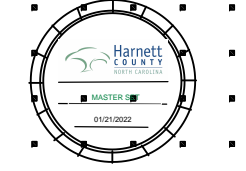
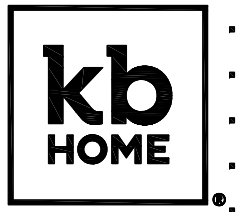

NORTH CAROLINA 40' SERIES

KB HOME
NORTH CAROLINA DIVISION
4506 S. MIAMI BLVD.
SUITE 180
DURHAM, NC 27703
TEL: (919) 768-7980
FAX: (919) 544-2928

2018 NORTH CAROLINA STATE BUILDING CODES

ISSUE DATE: 01/08/15
PROJECT No.: 1350999:56
DIVISION MGR.: DCS

- REVISIONS: 08/20/20
- 11 DIVISION REVISION NC13654NCP - 08/28/19 - FAB
 - 12 DIVISION REVISION NC13657NCP - 09/26/19 - FAB
 - 13 DIVISION REVISION NC20003NCP - 12/19/20 - CL
 - 14 VENTILATION NC20008NCP - 01/17/20 - CL
 - 15 DIVISION REVISION NC20013NCP - 02/10/20 - MCP
 - 16 DIVISION REVISION NC20017NCP - 03/04/20 - KBA
 - 17 HOME OFFICE CORP20009CORP-08/20/20-CTD

FOR INTERNAL USE ONLY

REVIEWED BY:

1.	
2.	
3.	
4.	
5.	
6.	

PLAN: 238.2338
SHEET: 8.3

SPEC. LEVEL 1
RALEIGH-DURHAM 40' SERIES

These designs and drawings are CONFIDENTIAL, and the exclusive property of KB Home Corporation and are not to be disclosed without the express permission of KB Home Corporation. Copyright 2020 © KB Home Corporation, all rights reserved.

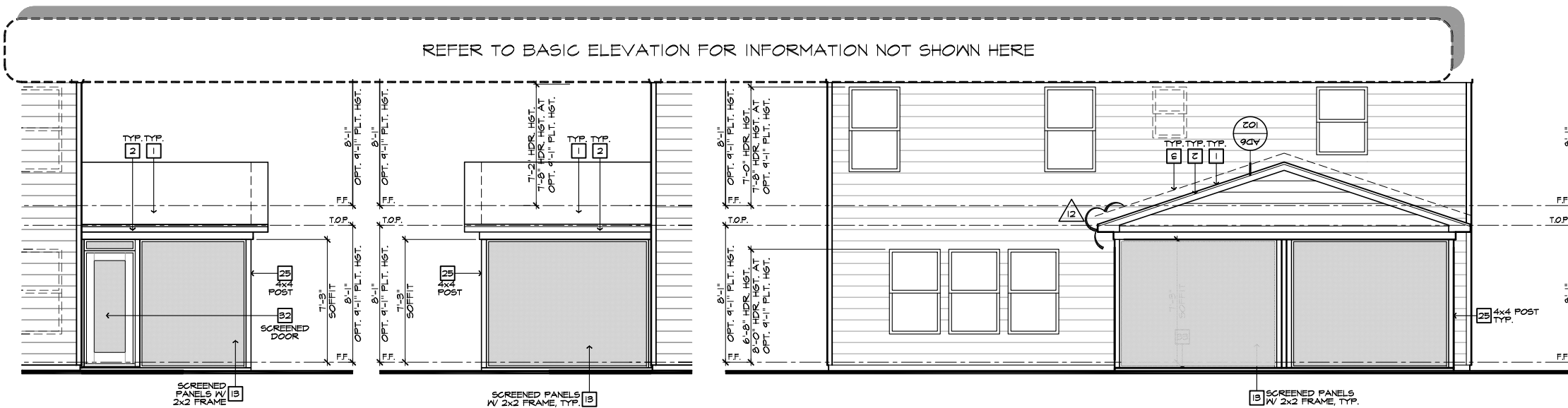

PARTIAL RIGHT ELEVATION

PARTIAL LEFT ELEVATION

PARTIAL REAR ELEVATION

ROOF PLAN NOTES			
	INDICATES ROOF SLOPE AND DIRECTION, U.N.O.		
ROOF MATERIAL: COMPOSITION SHINGLE			
12" (INCHES) TYPICAL ROOF OVERHANGS AT RAKE, U.N.O.			
12" (INCHES) TYPICAL ROOF OVERHANGS AT EAVE, U.N.O.			
LOCATE EAVE/ RAFTER VENTS EQUALLY BALANCED AROUND HOUSE EXCEPT ABOVE SHEARWALL PANELS.			
ATTIC VENT CALCULATIONS			
PROVIDE 1 SQ. IN. OF VENTILATION PER 500 SQ. IN. OF ATTIC SPACE. PROVIDE THAT AT LEAST 50% & NO MORE THAN 80% OF THE REQ. VENTILATING AREA IS PROVIDED BY VENTILATORS LOCATED IN THE UPPER PORTION OF THE ATTIC (HIGH VENTING) AT 9'-0" ABOVE EAVE VENT WITH THE BALANCE BEING PROVIDED BY EAVE VENTS (LOW VENTING) (2018 NC-R 2006.2)			
* CALCULATION BY 1/50, HIGH/LOW VENTING NOT REQUIRED.			
APPROXIMATE RIDGE VENT LOCATIONS SHOWN. ACTUAL LOCATIONS TO BE DETERMINED IN THE FIELD.			
AREA 3 / MAIN IV EXTENDED SCREENED-IN COVERED PATIO:			
VENTILATION REQUIRED:			
ATTIC AREA = 200	SG. FT. / 150	1.33 SQ. FT.	
	X 144 =	192 SQ. IN.	
	TOTAL HIGH & LOW =	192 SQ. IN.	
VENTILATION PROVIDED:			
18	LF VENTILATED SOFFIT AT	6.9 SQ. IN. / LF. =	124 SQ. IN.
7	LF RIDGE VENT(S) AT	18 SQ. IN. EA. =	126 SQ. IN.
TOTAL VENTILATION PROVIDED: 250 SQ. IN.			

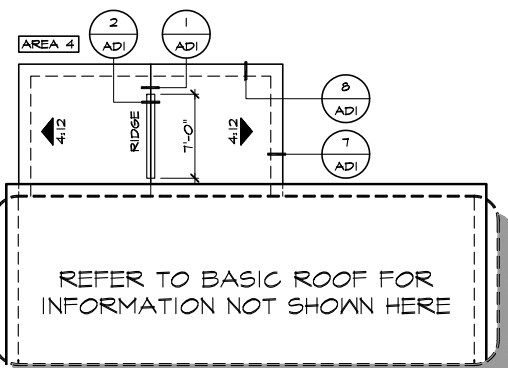

PARTIAL ROOF PLAN

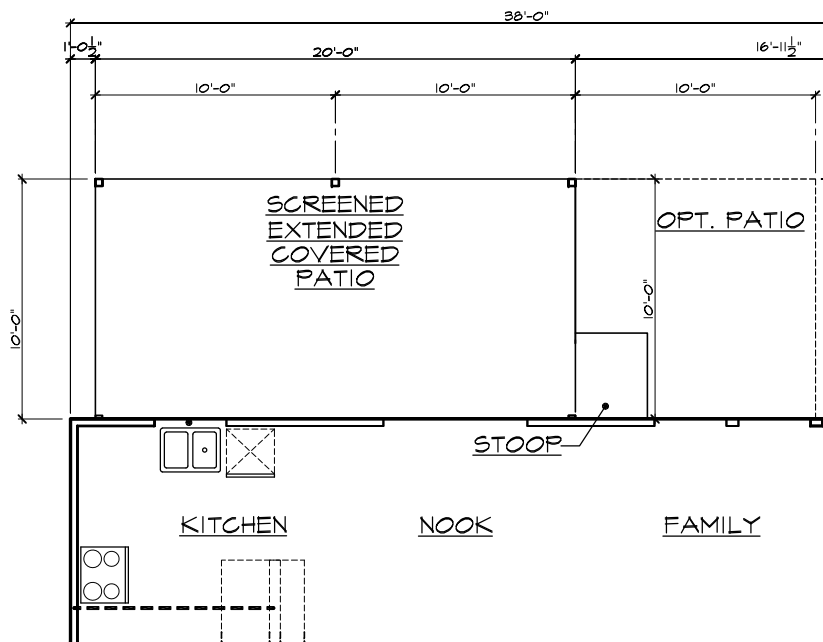

PARTIAL SLAB INTERFACE PLAN

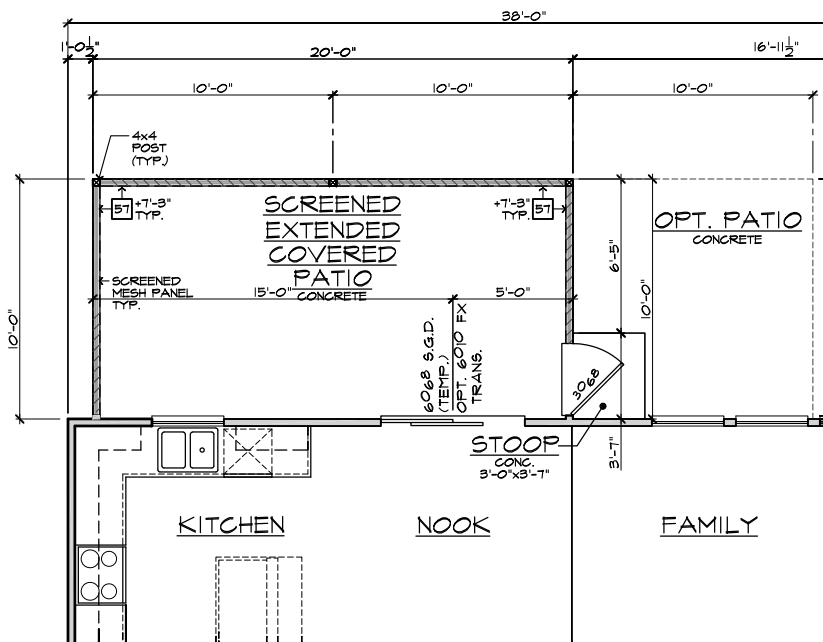

PARTIAL FIRST FLOOR PLAN

EXTENDED COVERED SCREENED PATIO AT SLAB ON GRADE

SCALE 1/4"=1'-0" (22'x34') - 1/8"=1'-0" (11'x17')

#	ELEVATION NOTES
NOTE: NOT ALL KEY NOTES APPLY.	
1.	ROOF MATERIAL - REFER TO ROOF NOTES
2.	2X FASCIA/BARGE BOARD WITH FASCIA CAP
3.	6.1. FLASHING
4.	6.1. FLASHING & SADDLE/CRICKET
5.	6.1. DRIP SCREED
6.	24"x24" CHIMNEY
7.	DECORATIVE VENT
8.	DECORATIVE CORBEL
9.	DECORATIVE SHUTTERS
10.	PEDIMENT. SEE ELEVATION FOR TYPE
11.	RECESSED ELEMENT
12.	DECORATIVE TRIM FYPON OR EQ. SEE ELEVATION FOR TYPE
13.	TRIM PER SPEC- SEE ELEVATION FOR SIZE
14.	SYNTHETIC MATERIAL
15.	PRE-MANUFACTURED DECORATIVE COLUMN (SIZE, SEE ELEV.) FYPON OR EQ. SURROUNDING STRUCTURAL POST.
16.	SITE-BUILT COLUMN - SEE ELEVATION FOR TYPE
17.	SHAKE SIDING
18.	STONE VENEER PER SPECS
19.	BRICK/MASONRY VENEER PER SPECS
20.	BUILT UP BRICK COLUMN
21.	SOLDIER COURSE
22.	ROWLOCK COURSE
23.	FRIEZE BOARD
24.	SIDING W/ 4" CORNER TRIM PER SPECS
25.	P.T. POST IV WRAP - SEE STRUCTURAL FOR SIZE
26.	PRE-FAB DECORATIVE TRIM
27.	LIGHT WEIGHT PRECAST STONE TRIM
28.	P.T. LUMBER RAILINGS (36" U.N.O.)
29.	WRAP
30.	DECORATIVE WINDOW/DOOR TRIM - FYPON OR EQ. SEE ELEVATION FOR SIZE.
31.	BRACKET OR KICKER - FYPON OR EQ.
32.	ENTRY DOOR
33.	CONCRETE STOOP/ PORCH - SEE SLAB INTERFACE PLAN.
34.	SECTIONAL GARAGE DOOR PER SPECS
35.	ALUMINUM WRAP
36.	OPTIONAL DOOR/WINDOW - REFER TO PLAN OPTIONS
37.	OPTIONAL STANDING SEAM METAL ROOF
38.	KEYSTONE
39.	SOLDIER CROWN
40.	JACK SOLDIER COURSE
41.	WATER TABLE
42.	ATRIUM DOOR
43.	PILASTER - SEE ELEVATION FOR TYPE

#	PARTIAL PLAN NOTES
NOTE: NOT ALL KEY NOTES APPLY.	
27.	WATER HEATER LOCATION - FOR GAS - LOCATE ON 18" HIGH PLATFORM - FOR INTERIOR LOCATION - PROVIDE PAN & DRAIN (REFER TO DETAILS)
28.	WATER HEATER 3" VENT TO OUTSIDE AIR
29.	MAIN LINE SHUT-OFF VALVE AND TEMP. & PRESSURE RELIEF VALVE
34.	LINE V. WALL BELOW
41.	LINE OF FLOOR ABOVE
42.	LINE OF FLOOR BELOW
43.	LINE 36" HIGH GUARDRAIL (REFER TO DETAIL SHEETS)
50.	A/C PAD LOCATION
51.	LOW WALL - REFER TO PLAN FOR HEIGHT
52.	2x6 STUD WALL
54.	DBL. 2x4 WALL PER PLAN
55.	INTERIOR SHELF - REFER TO PLAN FOR HEIGHT
57.	FLAT SOFFIT
58.	ARCHED SOFFIT
60.	OPT. DOOR / WINDOW
61.	PRE-MANUFACTURED DECORATIVE COLUMN (SIZE, SEE ELEV.) FYPON OR EQ. SURROUNDING STRUCTURAL POST.
62.	BRICK / STONE VENEER - REFER TO ELEVATIONS
63.	SECTIONAL GARAGE DOOR PER SPECS
66.	3" DIAM. CONCRETE FILLED PIPE BOLLARD 36" HIGH WITH MIN. 12" EMBEDMENT INTO CONCRETE. (NOT REQUIRED AT ELECTRIC WATER HEATERS OR FOR APPLIANCES LOCATED OUT OF THE VEHICLE'S NORMAL TRAVEL PATH)
68.	P.T. POST IV WRAP.
70.	EGRESS WINDOW
75.	WINDOW LEDGE. HEIGHT & WIDTH OF OPENING TO EXTEND 6" BEYOND WINDOW(S) ON ALL SIDES U.N.O.
76.	SITE-BUILT COLUMN - SEE ELEVATION FOR TYPE
77.	CONCRETE SLAB. SLOPE 1/4" PER FT. MIN. SEE PLAN FOR SIZE.

#	SLAB PLAN NOTES
NOTE: NOT ALL KEY NOTES APPLY.	
1.	CONCRETE PATIO/PORCH SLAB PER STRUCTURAL- SLOPE 1/4" PER FT. MIN.
2.	CONCRETE GARAGE SLAB PER STRUCTURAL- SLOPE 1/8" PER FT. MIN. TOWARD DOOR OPENING.
3.	CONCRETE FOUNDATION PER STRUCTURAL.
4.	CONCRETE STOOP: 36"x36" STANDARD SLOPE 1/4" PER FT. MIN.
5.	CONCRETE DRIVEWAY SLOPE 1/4" PER FT. MIN. AWAY FROM GARAGE DOOR OPENING.
6.	PROVIDE ELECTRICAL CONDUIT UNDER SLAB AT ISLAND. VERIFY LOCATION.
7.	5" BRICK LEDGE FOR MASONRY VENEER.
8.	3" DIAMETER CONCRETE FILLED PIPE BOLLARD 36" HIGH WITH MIN. 12" EMBEDMENT INTO CONCRETE.
9.	REFER TO CIVIL DRAWINGS FOR ALL FINISH SURFACE ELEVATIONS.
10.	VERIFY ALL PLUMBING STUD DIMENSIONS SHOWN HERE PRIOR TO POUR OF SLAB.
11.	4" MIN. Ø 1/4" MAX. TO HARD SURFACE.
12.	A/C PAD. VERIFY LOCATION.
13.	36" WIDE WALKWAY- SLOPE 1/4" PER FT. MIN.

NOTE: REFER TO BASIC ROOF PLAN FOR INFORMATION NOT SHOWN HERE
NOTE: REFER TO BASIC ELEVATIONS FOR INFORMATION NOT SHOWN HERE
NOTE: REFER TO BASIC FLOOR PLAN FOR INFORMATION NOT SHOWN HERE
NOTE: REFER TO BASIC SLAB PLAN FOR INFORMATION NOT SHOWN HERE



NORTH CAROLINA 40' SERIES

KB HOME NORTH CAROLINA DIVISION

4506 S. MIAMI BLVD. SUITE 180 DURHAM, NC 27703 TEL: (919) 768-7980 FAX: (919) 544-2928

2018 NORTH CAROLINA STATE BUILDING CODES

ISSUE DATE: 01/08/15 PROJECT No.: 1350999:56 DIVISION MGR.: DCS REVISIONS: 08/20/20

- 11 DIVISION REVISION NC13654NCP - 08/28/19 - FAB
- 12 DIVISION REVISION NC13657NCP - 09/26/19 - FAB
- 13 DIVISION REVISION NC20003NCP - 12/19/19 - CL
- 14 VENTILATION NC20004NCP - 01/17/20 - CL
- 15 DIVISION REVISION NC20005NCP - 02/10/20 - MCP
- 16 DIVISION REVISION NC20017NCP - 03/04/20 - KBA
- 17 HOME OFFICE CORP20005CORP-08/20/20-CTD

FOR INTERNAL USE ONLY	
REVIEWED BY:	
1.	
2.	
3.	
4.	
5.	
6.	

PLAN: 238.2338

SHEET: 8.4

SPEC. LEVEL 1 RALEIGH-DURHAM 40' SERIES

These designs and drawings are CONFIDENTIAL, and the exclusive property of KB Home Corporation and are not to be disclosed without the express permission of KB Home Corporation. Copyright 2020 © KB Home Corporation, all rights reserved.

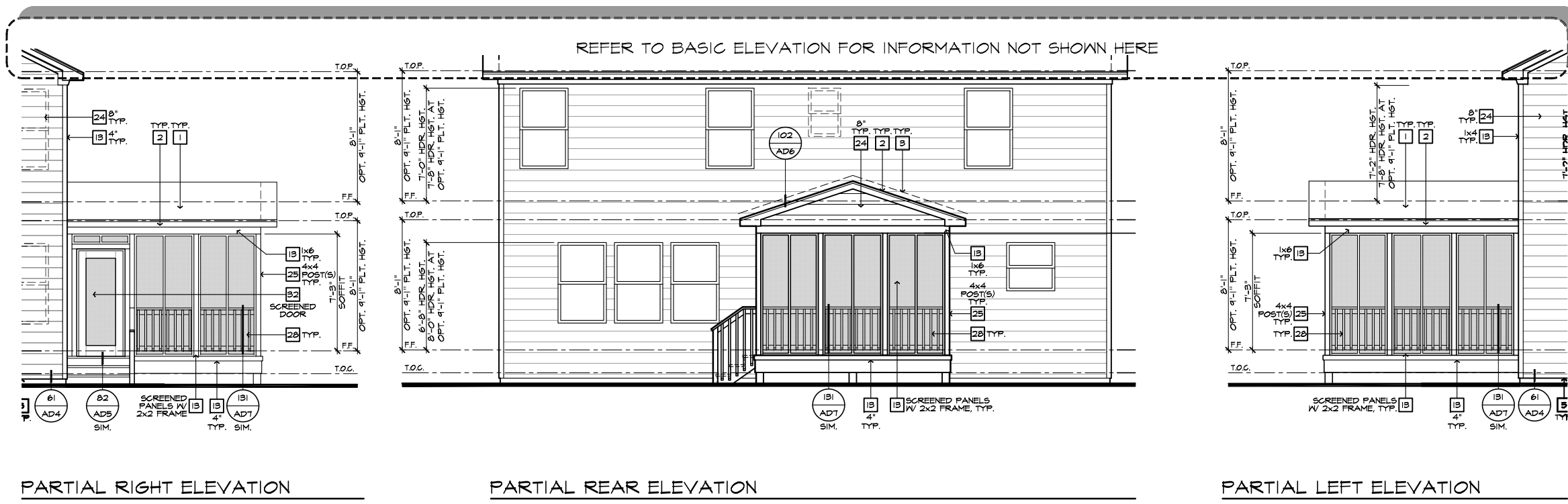

PARTIAL RIGHT ELEVATION

PARTIAL REAR ELEVATION

PARTIAL LEFT ELEVATION

ELEVATION NOTES	
NOTE: NOT ALL KEY NOTES APPLY.	
1.	ROOF MATERIAL - REFER TO ROOF NOTES
2.	2X FASCIA/BARGE BOARD WITH FASCIA CAP
3.	6.1. FLASHING
4.	6.1. FLASHING & SADDLE/CRIKETT
5.	6.1. DRIP SCREED
6.	24"x24" CHIMNEY
7.	DECORATIVE VENT
8.	DECORATIVE CORBEL
9.	DECORATIVE SHUTTERS
10.	PEDIMENT, SEE ELEVATION FOR TYPE
11.	RECESSED ELEMENT
12.	DECORATIVE TRIM FYPON OR EQ. SEE ELEVATION FOR TYPE
13.	TRIM PER SPEC- SEE ELEVATION FOR SIZE
14.	SYNTHETIC MATERIAL
15.	PRE-MANUFACTURED DECORATIVE COLUMN (SIZE, SEE ELEV.) FYPON OR EQ. SURROUNDING STRUCTURAL POST.
16.	SITE-BUILT COLUMN - SEE ELEVATION FOR TYPE
17.	SHAKE SIDING
18.	STONE VENEER PER SPECS
19.	BRICK/MASONRY VENEER PER SPECS
20.	BUILT UP BRICK COLUMN
21.	SOLDIER COURSE
22.	ROCKLOCK COURSE
23.	FRIEZE BOARD
24.	SIDING W/ 4" CORNER TRIM PER SPECS
25.	P.T. POST W/ WRAP - SEE STRUCTURAL FOR SIZE
26.	PRE-FAB DECORATIVE TRIM
27.	LIGHT WEIGHT PRECAST STONE TRIM
28.	P.T. LUMBER RAILINGS (36" U.N.O.)
29.	WRAP
30.	DECORATIVE WINDOW/DOOR TRIM - FYPON OR EQ. SEE ELEVATION FOR SIZE.
31.	BRACKET OR KICKER - FYPON OR EQ.
32.	ENTRY DOOR
33.	CONCRETE STOOP/PORCH - SEE SLAB INTERFACE PLAN.
34.	SECTIONAL GARAGE DOOR PER SPECS
35.	ALUMINUM WRAP
36.	OPTIONAL DOOR/WINDOW - REFER TO PLAN OPTIONS
37.	OPTIONAL STANDING SEAM METAL ROOF
38.	KEYSTONE
39.	SOLDIER CROWN
40.	JACK SOLDIER COURSE
41.	WATER TABLE
42.	ATRIUM DOOR
43.	PILASTER - SEE ELEVATION FOR TYPE

PARTIAL PLAN NOTES	
NOTE: NOT ALL KEY NOTES APPLY.	
21.	WATER HEATER LOCATION - FOR GAS - LOCATE ON 18" HIGH PLATFORM - FOR INTERIOR LOCATION - PROVIDE PAN & DRAIN (REFER TO DETAILS)
22.	WATER HEATER 'B' VENT TO OUTSIDE AIR
23.	MAIN LINE SHUT-OFF VALVE AND TEMP. & PRESSURE RELIEF VALVE
34.	LINE OF WALL BELOW
41.	LINE OF FLOOR ABOVE
42.	LINE OF FLOOR BELOW
43.	MIN. 36" HIGH GUARDRAIL (REFER TO DETAIL SHEETS)
50.	A/C PAD LOCATION
51.	LOW WALL - REFER TO PLAN FOR HEIGHT
52.	2x6 STUD WALL
54.	DEL. 2x4 WALL PER PLAN
55.	INTERIOR SHELF - REFER TO PLAN FOR HEIGHT
57.	FLAT SOFFIT
58.	ARCHED SOFFIT
60.	OPT. DOOR/WINDOW
61.	PRE-MANUFACTURED DECORATIVE COLUMN (SIZE, SEE ELEV.) FYPON OR EQ. SURROUNDING STRUCTURAL POST.
62.	BRICK / STONE VENEER - REFER TO ELEVATIONS
63.	SECTIONAL GARAGE DOOR PER SPECS
66.	3" DIAM. CONCRETE FILLED PIPE BOLLARD 36" HIGH WITH MIN. 12" EMBEDMENT INTO CONCRETE. (NOT REQUIRED AT ELECTRIC WATER HEATERS OR FOR TRAVEL PATHS LOCATED OUT OF THE VEHICLE'S NORMAL TRAVEL PATH.)
68.	P.T. POST W/ WRAP.
70.	EGRESS WINDOW
75.	WINDOW LEDGE, HEIGHT & WIDTH OF OPENING TO EXTEND 6" BEYOND WINDOW(S) ON ALL SIDES U.N.O.
76.	SITE-BUILT COLUMN - SEE ELEVATION FOR TYPE
77.	CONCRETE SLAB - SLOPE 1/4" PER FT. MIN. SEE PLAN FOR SIZE

ROOF PLAN NOTES	
INDICATES ROOF SLOPE AND DIRECTION U.N.O.	
ROOF MATERIAL: COMPOSITION SHINGLE	
12" (INCHES) TYPICAL ROOF OVERHANGS AT RAKE, U.N.O.	
12" (INCHES) TYPICAL ROOF OVERHANGS AT EAVE, U.N.O.	
LOCATE EAVE/ RAFTER VENTS EQUALLY BALANCED AROUND HOUSE EXCEPT ABOVE SHEARWALL PANELS.	
ATTIC VENT CALCULATIONS	
PROVIDE 1 SQ. IN. OF VENTILATION PER 300 SQ. IN. OF ATTIC SPACE. PROVIDE THAT AT LEAST 50% & NO MORE THAN 80% OF THE REQ. VENTILATING AREA IS PROVIDED BY VENTILATORS LOCATED IN THE UPPER PORTION OF THE ATTIC (HIGH VENTING) AT 3'-0" ABOVE EAVE VENT WITH THE BALANCE BEING PROVIDED BY EAVE VENTS (LOW VENTING)	
* CALCULATION BY 1/150, HIGH/LOW VENTING NOT REQUIRED.	
AREA 5 / MAIN W/ W/ SCREENED-IN DECK	
VENTILATION REQUIRED:	
ATTIC AREA = 144	SQ. FT. / 150 = 0.96 SQ. FT.
	X 144 = 138 SQ. IN.
	TOTAL HIGH & LOW = 138 SQ. IN.
VENTILATION PROVIDED:	
10	LF VENTILATED SOFFIT AT 6.4 SQ. IN. / LF. = 64 SQ. IN.
6	LF RIDGE VENT(S) AT 10 SQ. IN. EA. = 100 SQ. IN.
TOTAL VENTILATION PROVIDED: 177 SQ. IN.	

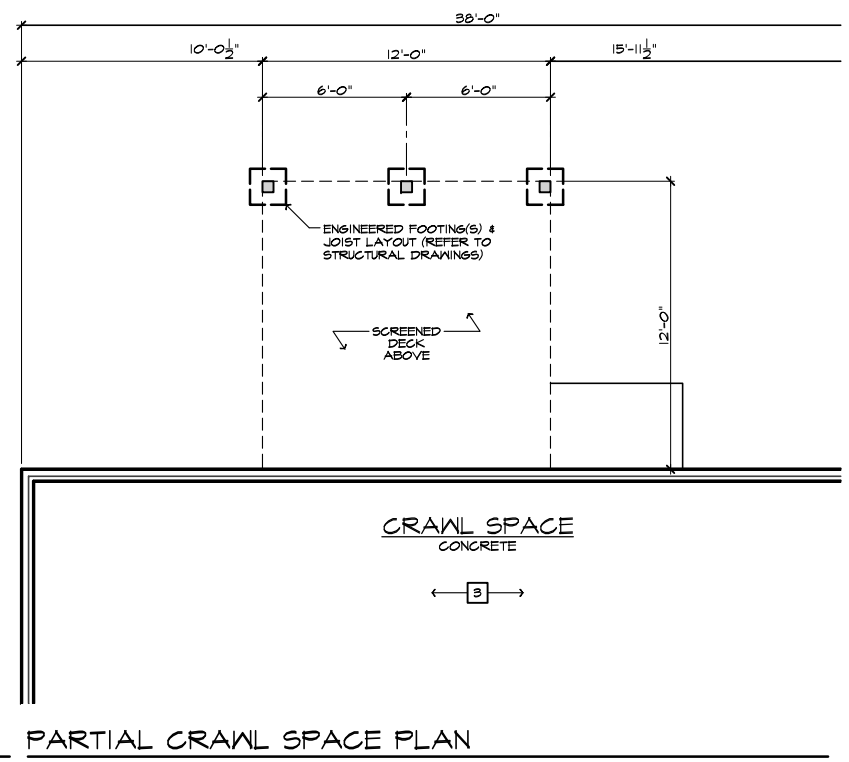

PARTIAL CRAWL SPACE PLAN

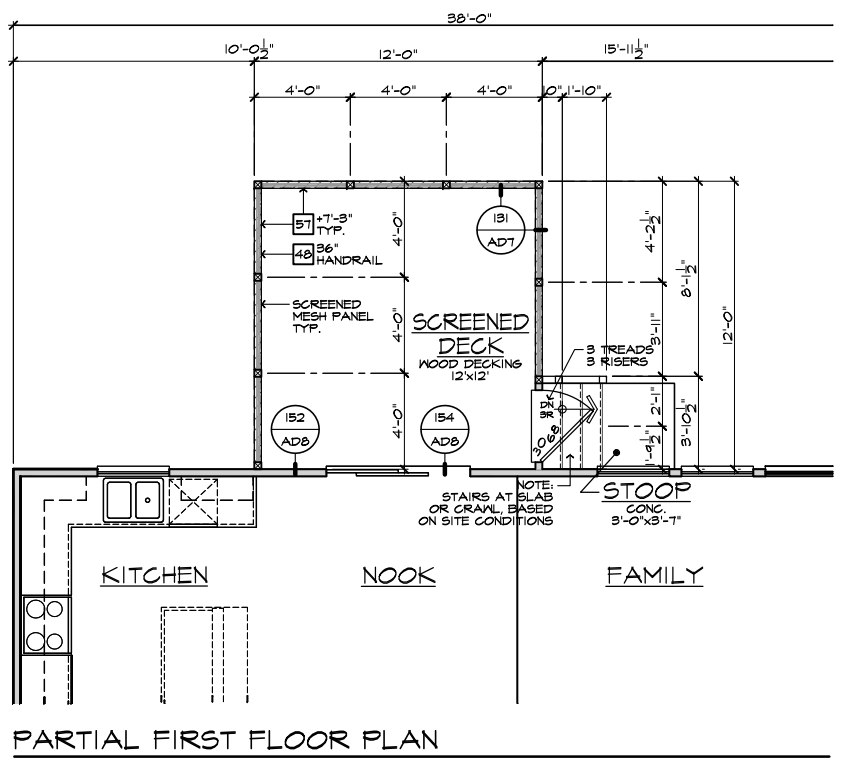

PARTIAL FIRST FLOOR PLAN

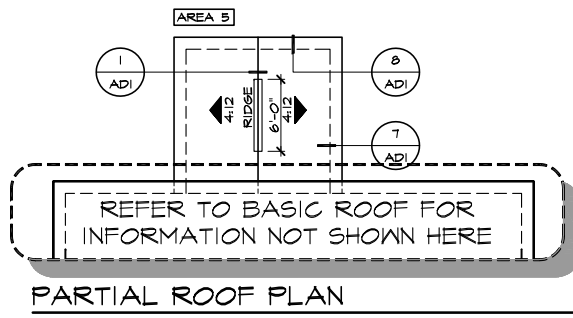

PARTIAL ROOF PLAN

FOUNDATION PLAN NOTES	
NOTE: NOT ALL KEY NOTES APPLY.	
1.	CONCRETE PATIO/PORCH SLAB PER STRUCTURAL- SLOPE 1/4" PER FT. MIN.
2.	CONCRETE GARAGE SLAB PER STRUCTURAL- SLOPE 1/8" PER 1'-0" MIN. TOWARD DOOR OPENINGS.
3.	FOUNDATION PER STRUCTURAL.
4.	STAIR LANDING: 36"x36" MIN.
5.	CONCRETE DRIVEWAY SLOPE 1/4" PER FT. MIN. AWAY FROM GARAGE DOOR OPENING.
6.	PROVIDE UNDER FLOOR VENTILATION
7.	4" TOE KICK FOR MASONRY VENEER.
8.	3" DIAMETER CONCRETE FILLED PIPE BOLLARD 36" HIGH WITH MIN. 12" EMBEDMENT INTO CONCRETE.
9.	REFER TO CIVIL DRAWINGS FOR ALL FINISH SURFACE ELEVATIONS.
10.	VERIFY LOCATION OF PIER FOOTINGS PER STRUCTURAL.
11.	4" MIN. 7 3/4" MAX. TO HARD SURFACE.
12.	A/C PAD, VERIFY LOCATION.
13.	CRAWL SPACE ACCESS
14.	36" WIDE WALKWAY- SLOPE 1/4" PER FT. MIN.
NOTE: THE CRAWL SPACE IS TO BE CONDITIONED PER NC-R SECTION R409.1. THE CRAWL SPACE VAPOR RETARDER (BARRIER) IS TO BE PER NC-R SECTION R409.2.	
NOTE: REFER TO BASIC ROOF PLAN FOR INFORMATION NOT SHOWN HERE	
NOTE: REFER TO BASIC FLOOR PLAN FOR INFORMATION NOT SHOWN HERE	
NOTE: REFER TO BASIC FLOOR PLAN FOR INFORMATION NOT SHOWN HERE	
NOTE: REFER TO BASIC ELEVATIONS FOR INFORMATION NOT SHOWN HERE	

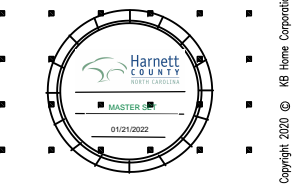

NORTH CAROLINA 40' SERIES
 KB HOME
 NORTH CAROLINA DIVISION
 4506 S. MIAMI BLVD.
 SUITE 180
 DURHAM, NC 27703
 TEL: (919) 768-7980
 FAX: (919) 544-2928

2018 NORTH CAROLINA STATE BUILDING CODES

ISSUE DATE: 01/08/15
 PROJECT No.: 1350999-56
 DIVISION MGR.: DCS
 REVISIONS: 08/20/20

- 11 DIVISION REVISION NC1954NCP - 02/28/19 - FAB
- 12 DIVISION REVISION NC1967NCP - 09/26/19 - FAB
- 13 DIVISION REVISION NC2003NCP - 12/19/19 - CL
- 14 VENTILATION NC2008NCP - 01/17/20 - CL
- 15 DIVISION REVISION NC2003NCP - 02/10/20 - MCP
- 16 DIVISION REVISION NC2007NCP - 03/04/20 - KBA
- 17 HOME OFFICE CORP2005CORP-04/20/20-CTD

FOR INTERNAL USE ONLY	
REVIEWED BY:	
1	
2	
3	
4	
5	
6	

PLAN: 238.2338
 SHEET: 8.5

SPEC. LEVEL 1
RALEIGH-DURHAM 40' SERIES

SCREENED-IN DECK 'A/B/C/D' AT CRAWL SPACE
 SCALE 1/4"=1'-0" (22"X34") - 1/8"=1'-0" (11"X17")

These designs and drawings are CONFIDENTIAL, and the exclusive property of KB Home Corporation and are not to be disclosed without the express permission of KB Home Corporation. Copyright 2020 © KB Home Corporation, all rights reserved.

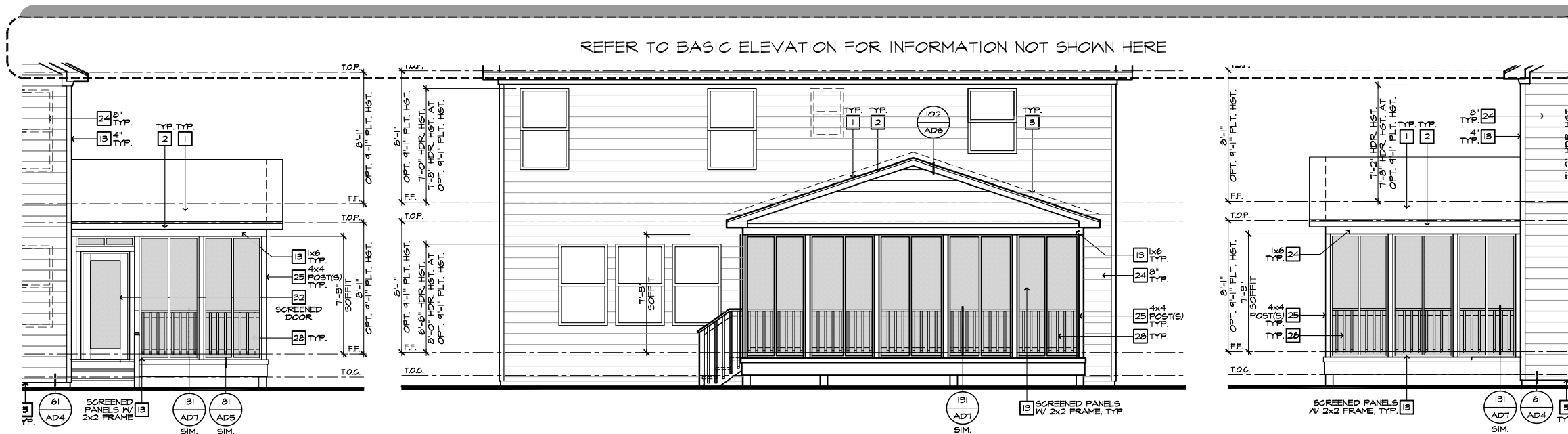

PARTIAL RIGHT ELEVATION

PARTIAL REAR ELEVATION

PARTIAL LEFT ELEVATION

- ### ELEVATION NOTES
- NOTE: NOT ALL KEY NOTES APPLY.
- ROOF MATERIAL - REFER TO ROOF NOTES
 - 2X FASCIA/BARGE BOARD WITH FASCIA CAP
 - 6.1. FLASHING
 - 6.1. FLASHING & SADDLE/CRICKET
 - 6.1. DRIP SCREED
 - 24"x24" CHIMNEY
 - DECORATIVE VENT
 - DECORATIVE CORBEL
 - DECORATIVE SHUTTERS
 - PEDIMENT. SEE ELEVATION FOR TYPE
 - RECESSED ELEMENT
 - DECORATIVE TRIM FYPON OR EQ. SEE ELEVATION FOR TYPE
 - TRIM PER SPEC- SEE ELEVATION FOR SIZE
 - SYNTHETIC MATERIAL
 - PRE-MANUFACTURED DECORATIVE COLUMN (SIZE, SEE ELEV.) FYPON OR EQ. SURROUNDING STRUCTURAL POST.
 - SITE-BUILT COLUMN - SEE ELEVATION FOR TYPE
 - SHAKE SIDING
 - STONE VENEER PER SPECS
 - BRICK/MASONRY VENEER PER SPECS
 - BUILT UP BRICK COLUMN
 - SOLDIER COURSE
 - RONLOCK COURSE
 - FRIEZE BOARD
 - SIDING 1/4" 4" CORNER TRIM PER SPECS
 - P.T. POST 1/4" WRAP - SEE STRUCTURAL FOR SIZE
 - PRE-FAB DECORATIVE TRIM
 - LIGHT WEIGHT PRECAST STONE TRIM
 - P.T. LUMBER RAILINGS (#36" U.N.O.)
 - WRAP
 - DECORATIVE WINDOW/DOOR TRIM - FYPON OR EQ. SEE ELEVATION FOR SIZE
 - BRACKET OR KICKER - FYPON OR EQ.
 - ENTRY DOOR
 - CONCRETE STOOP/PORCH - SEE SLAB INTERFACE PLAN.
 - SECTIONAL GARAGE DOOR PER SPECS
 - ALUMINUM WRAP
 - OPTIONAL DOOR/WINDOW - REFER TO PLAN OPTIONS
 - OPTIONAL STANDING SEAM METAL ROOF
 - KEYSTONE
 - SOLDIER CROWN
 - JACK SOLDIER COURSE
 - WATER TABLE
 - ATRIUM DOOR
 - PILASTER - SEE ELEVATION FOR TYPE

- ### PARTIAL PLAN NOTES
- NOTE: NOT ALL KEY NOTES APPLY.
- WATER HEATER LOCATION - FOR GAS - LOCATE ON 18" HIGH PLATFORM - FOR INTERIOR LOCATION - PROVIDE PAN & DRAIN (REFER TO DETAILS)
 - WATER HEATER 3" VENT TO OUTSIDE AIR
 - MAIN LINE SHUT-OFF VALVE AND TEMP. & PRESSURE RELIEF VALVE
 - LINE VENT WALL BELOW
 - LINE OF FLOOR ABOVE
 - LINE OF FLOOR BELOW
 - 36" HIGH GUARDRAIL (REFER TO DETAIL SHEETS)
 - A/C PAD LOCATION
 - LOW WALL - REFER TO PLAN FOR HEIGHT
 - 2x6 STUD WALL
 - DBL. 2x4 MALL PER PLAN
 - INTERIOR SHELF - REFER TO PLAN FOR HEIGHT
 - FLAT SOFFIT
 - ARCHED SOFFIT
 - OPT. DOOR/WINDOW
 - PRE-MANUFACTURED DECORATIVE COLUMN (SIZE, SEE ELEV.) FYPON OR EQ. SURROUNDING STRUCTURAL POST.
 - BRICK / STONE VENEER - REFER TO ELEVATIONS
 - SECTIONAL GARAGE DOOR PER SPECS
 - 3" DIAM. CONCRETE FILLED PIPE BOLLARD 36" HIGH WITH MIN. 12" EMBEDMENT INTO CONCRETE. (NOT REQUIRED AT ELECTRIC WATER HEATERS OR FOR APPLIANCES LOCATED OUT OF THE VEHICLE'S NORMAL TRAVEL PATH)
 - P.T. POST 1/4" WRAP.
 - EGRESS WINDOW
 - WINDOW LEDGE - HEIGHT & WIDTH OF OPENING TO EXTEND 6" BEYOND WINDOW(S) ON ALL SIDES U.N.O.
 - SITE-BUILT COLUMN - SEE ELEVATION FOR TYPE
 - CONCRETE SLAB. SLOPE 1/4" PER FT. MIN. SEE PLAN FOR SIZE

NOTE: REFER TO BASIC FLOOR PLAN FOR INFORMATION NOT SHOWN HERE

NOTE: REFER TO BASIC ROOF PLAN FOR INFORMATION NOT SHOWN HERE

NOTE: REFER TO BASIC FLOOR PLAN FOR INFORMATION NOT SHOWN HERE

NOTE: REFER TO BASIC ELEVATIONS FOR INFORMATION NOT SHOWN HERE

ROOF PLAN NOTES

4:12 INDICATES ROOF SLOPE AND DIRECTION U.N.O.

ROOF MATERIAL: COMPOSITION SHINGLE
 12" (INCHES) TYPICAL ROOF OVERHANGS AT RAKE, U.N.O.
 12" (INCHES) TYPICAL ROOF OVERHANGS AT EAVE, U.N.O.
 LOCATE EAVE/ RAFTER VENTS EQUALLY BALANCED AROUND HOUSE EXCEPT ABOVE SHEARWALL PANELS.

ATTIC VENT CALCULATIONS

PROVIDE 1 SQ. IN. OF VENTILATION PER 300 SQ. IN. OF ATTIC SPACE. PROVIDE THAT AT LEAST 50% & NO MORE THAN 80% OF THE REQ. VENTILATING AREA IS PROVIDED BY VENTILATORS LOCATED IN THE UPPER PORTION OF THE ATTIC. (HIGH VENTING) AT 3'-0" ABOVE EAVE VENT WITH THE BALANCE BEING PROVIDED BY EAVE VENTS. (LOW VENTING)
 * CALCULATION BY 1/150, HIGH/LOW VENTING NOT REQUIRED.

AREA 5 / MAIN 1/4" EXTENDED SCREENED-IN DECK.

VENTILATION REQUIRED:	
ATTIC AREA = 252	SQ. FT. / 150 = 1.68 SQ. FT.
	X 144 = 242 SQ. IN.
TOTAL HIGH & LOW = 242 SQ. IN.	
VENTILATION PROVIDED:	
22 LF VENTILATED SOFFIT AT 6.1	SQ. IN. / LF. = 152 SQ. IN.
8 LF RIDGE VENT(S) AT 18	SQ. IN. EA. = 144 SQ. IN.
TOTAL VENTILATION PROVIDED: 296 SQ. IN.	

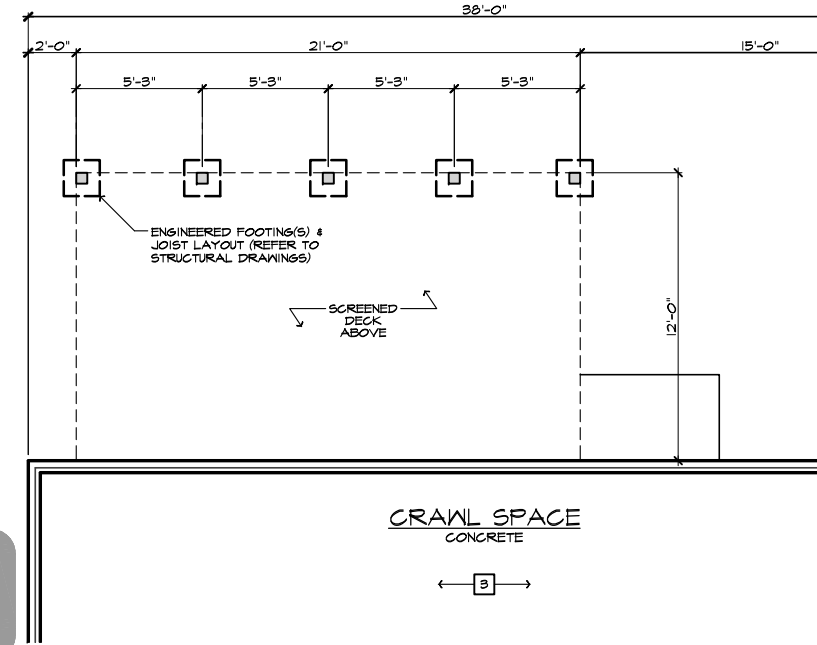

PARTIAL CRAWL SPACE PLAN

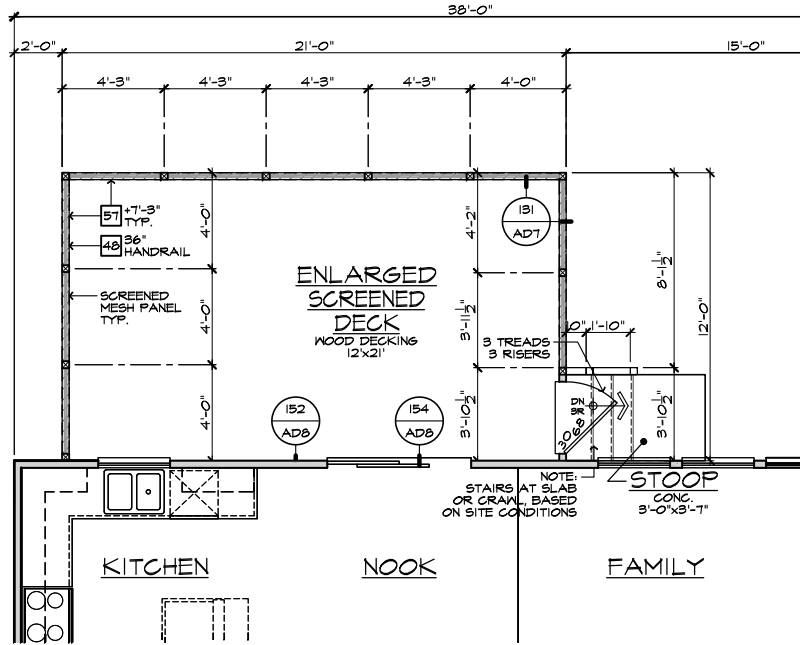

PARTIAL FIRST FLOOR PLAN

- ### FOUNDATION PLAN NOTES
- NOTE: NOT ALL KEY NOTES APPLY.
- CONCRETE PATIO/PORCH SLAB PER STRUCTURAL- SLOPE 1/4" PER FT. MIN.
 - CONCRETE GARAGE SLAB PER STRUCTURAL- SLOPE 1/8" PER 1'-0" MIN. TOWARD DOOR OPENINGS.
 - FOUNDATION PER STRUCTURAL.
 - STAIR LANDING: 36"x36" MIN.
 - CONCRETE DRIVEWAY SLOPE 1/4" PER FT. MIN. AWAY FROM GARAGE DOOR OPENING.
 - PROVIDE UNDER FLOOR VENTILATION
 - 4" TOE KICK FOR MASONRY VENEER.
 - 3" DIAMETER CONCRETE FILLED PIPE BOLLARD 36" HIGH WITH MIN. 12" EMBEDMENT INTO CONCRETE.
 - REFER TO CIVIL DRAWINGS FOR ALL FINISH SURFACE ELEVATIONS.
 - VERIFY LOCATION OF PIER FOOTINGS PER STRUCTURAL
 - 4" MIN. 7 3/4" MAX. TO HARD SURFACE.
 - A/C PAD. VERIFY LOCATION.
 - CRAWL SPACE ACCESS
 - 36" WIDE WALKWAY- SLOPE 1/4" PER FT. MIN.
- NOTE: THE CRAWL SPACE IS TO BE CONDITIONED PER NC-R SECTION R409. THE CRAWL SPACE VAPOR RETARDER (BARRIER) IS TO BE PER NC-R SECTION R409.2.

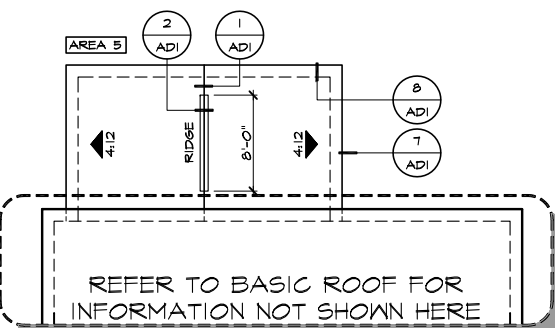

PARTIAL CRAWL SPACE PLAN

EXTENDED SCREENED-IN DECK 'A/B/C/D' AT CRAWL SPACE

SCALE 1/4"=1'-0" (22'x34') - 1/8"=1'-0" (11'x17')



NORTH CAROLINA 40' SERIES

KB HOME
 NORTH CAROLINA DIVISION
 4506 S. MIAMI BLVD.
 SUITE 180
 DURHAM, NC 27703
 TEL: (919) 768-7980
 FAX: (919) 544-2928

2018 NORTH CAROLINA STATE BUILDING CODES

ISSUE DATE: 01/08/15
 PROJECT No.: 1350999:56
 DIVISION MGR.: DCS
 REVISIONS: 08/20/20

- 11 DIVISION REVISION NC13654NCF - 08/28/19 - FAB
- 12 DIVISION REVISION NC13657NCF - 09/26/19 - FAB
- 13 DIVISION REVISION NC22003NCF - 12/19/19 - CL
- 14 VENTILATION NC22004NCF - 01/17/20 - CL
- 15 DIVISION REVISION NC22005NCF - 02/10/20 - MCP
- 16 DIVISION REVISION NC22007NCF - 03/04/20 - KBA
- 17 HOME OFFICE CORP120093CORP-08/20/20-CTD

FOR INTERNAL USE ONLY

REVIEWED BY:

1.	
2.	
3.	
4.	
5.	
6.	

PLAN: 238.2338
 SHEET: 8.6

SPEC. LEVEL 1
 RALEIGH-DURHAM 40' SERIES

These designs and drawings are CONFIDENTIAL, and the exclusive property of KB Home Corporation, and are not to be disclosed without the express permission of KB Home Corporation. Copyright 2020 © KB Home Corporation. All rights reserved.

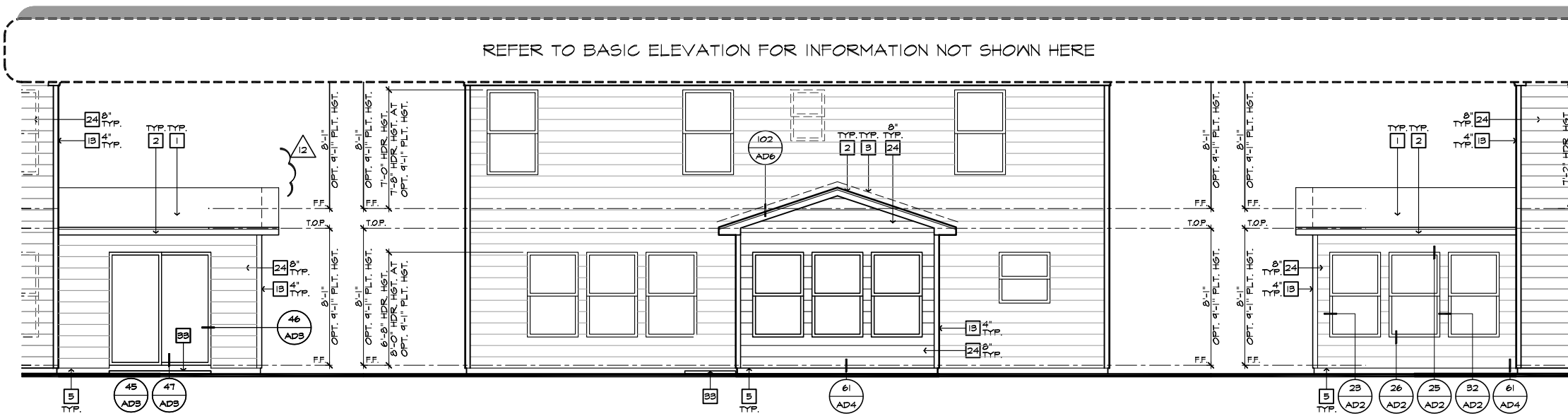

PARTIAL RIGHT ELEVATION

PARTIAL REAR ELEVATION

PARTIAL LEFT ELEVATION

ROOF PLAN NOTES

INDICATES ROOF SLOPE AND DIRECTION, U.N.O.
4:12

ROOF MATERIAL: COMPOSITION SHINGLE
12" (INCHES) TYPICAL ROOF OVERHANGS AT RAKE, U.N.O.
12" (INCHES) TYPICAL ROOF OVERHANGS AT EAVE, U.N.O.
LOCATE EAVE/ RAFTER VENTS EQUALLY BALANCED AROUND HOUSE EXCEPT ABOVE SHEARWALL PANELS.

ATTIC VENT CALCULATIONS

PROVIDE 1 SQ. IN. OF VENTILATION PER 300 SQ. IN. OF ATTIC SPACE. PROVIDE THAT AT LEAST 50% & NO MORE THAN 80% OF THE REQ. VENTILATING AREA IS PROVIDED BY VENTILATORS LOCATED IN THE UPPER PORTION OF THE ATTIC (HIGH VENTING) AT 3'-0" ABOVE EAVE VENT WITH THE BALANCE BEING PROVIDED BY EAVE VENTS (LOW VENTING)
* CALCULATION BY 1/150, HIGH/LOW VENTING NOT REQUIRED.

AREA 5 / MAIN IV SUNROOM:	
VENTILATION REQUIRED:	
ATTIC AREA = 144	SQ. FT. / 150 = 0.96 SQ. FT.
	X 144 = 139 SQ. IN.
	TOTAL HIGH & LOW = 139 SQ. IN.
VENTILATION PROVIDED:	
10	LF VENTILATED SOFFIT AT 6.9 SQ. IN. / LF. = 69 SQ. IN.
6	LF RIDGE VENT(S) AT 18 SQ. IN. EA. = 108 SQ. IN.
	TOTAL VENTILATION PROVIDED: 177 SQ. IN.

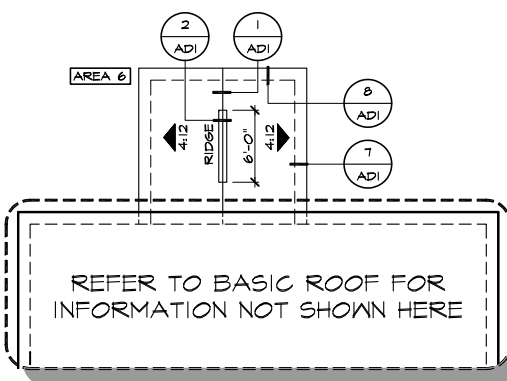

PARTIAL ROOF PLAN

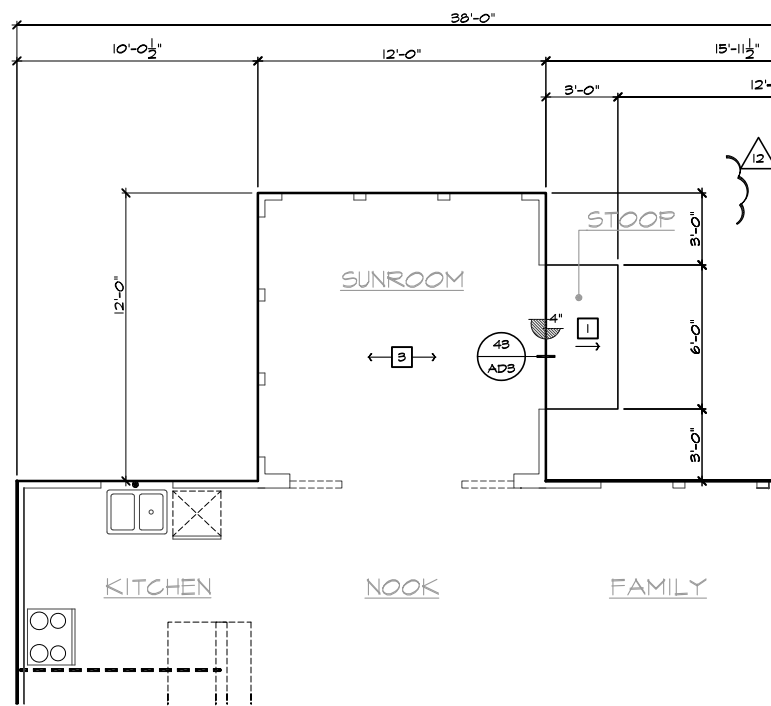

PARTIAL SLAB INTERFACE PLAN

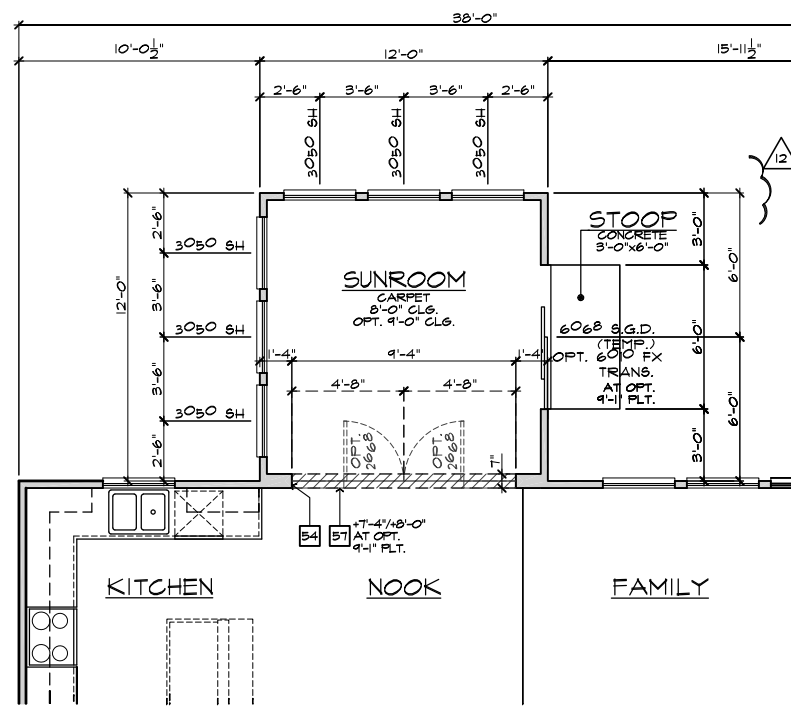

PARTIAL FIRST FLOOR PLAN

- ELEVATION NOTES**
- NOTE: NOT ALL KEY NOTES APPLY.
1. ROOF MATERIAL - REFER TO ROOF NOTES
 2. 2X FASCIA/BARGE BOARD WITH FASCIA CAP
 3. 6:1 FLASHING
 4. 6:1 FLASHING & SADDLE/CRICKET
 5. 6:1 DRIP SCREED
 6. 24"x24" CHIMNEY
 7. DECORATIVE VENT
 8. DECORATIVE CORBEL
 9. DECORATIVE SHUTTERS
 10. PEDIMENT. SEE ELEVATION FOR TYPE
 11. RECESSED ELEMENT
 12. DECORATIVE TRIM FYPON OR EQ. SEE ELEVATION FOR TYPE
 13. TRIM PER SPEC - SEE ELEVATION FOR SIZE
 14. SYNTHETIC MATERIAL
 15. PRE-MANUFACTURED DECORATIVE COLUMN (SIZE, SEE ELEV.) FYPON OR EQ. SURROUNDING STRUCTURAL POST.
 16. SITE-BUILT COLUMN - SEE ELEVATION FOR TYPE
 17. SHAKE SIDING
 18. STONE VENEER PER SPECS
 19. BRICK/MASONRY VENEER PER SPECS
 20. BUILT UP BRICK COLUMN
 21. SOLDIER COURSE
 22. ROWLOCK COURSE
 23. FRIEZE BOARD
 24. SIDING IV 4" CORNER TRIM PER SPECS
 25. P.T. POST IV WRAP - SEE STRUCTURAL FOR SIZE
 26. PRE-FAB DECORATIVE TRIM
 27. LIGHT WEIGHT PRECAST STONE TRIM
 28. P.T. LUMBER RAILINGS (36" U.N.O.)
 29. WRAP
 30. DECORATIVE WINDOW/DOOR TRIM - FYPON OR EQ. SEE ELEVATION FOR SIZE.
 31. BRACKET OR KICKER - FYPON OR EQ.
 32. ENTRY DOOR
 33. CONCRETE STOOP/PORCH - SEE SLAB INTERFACE PLAN.
 34. SECTIONAL GARAGE DOOR PER SPECS
 35. ALUMINUM WRAP
 36. OPTIONAL DOOR/WINDOW - REFER TO PLAN OPTIONS
 37. OPTIONAL STANDING SEAM METAL ROOF
 38. KEYSTONE
 39. SOLDIER CROWN
 40. JACK SOLDIER COURSE
 41. WATER TABLE
 42. ATRIUM DOOR
 43. PILASTER - SEE ELEVATION FOR TYPE

- PARTIAL PLAN NOTES**
- NOTE: NOT ALL KEY NOTES APPLY.
21. WATER HEATER LOCATION - FOR GAS - LOCATE ON 18" HIGH PLATFORM - FOR INTERIOR LOCATION - PROVIDE PAN & DRAIN (REFER TO DETAILS)
 28. WATER HEATER 3" VENT TO OUTSIDE AIR
 29. MAIN LINE SHUT-OFF VALVE AND TEMP. & PRESSURE RELIEF VALVE
 34. LINE V. WALL BELOW
 41. LINE OF FLOOR ABOVE
 42. LINE OF FLOOR BELOW
 43. LINE 36" HIGH GUARDRAIL (REFER TO DETAIL SHEETS)
 50. A/C PAD LOCATION
 51. LOW WALL - REFER TO PLAN FOR HEIGHT
 52. 2x6 STUD WALL
 54. DEL. 2x4 WALL PER PLAN
 55. INTERIOR SHELF - REFER TO PLAN FOR HEIGHT
 57. FLAT SOFFIT
 58. ARCHED SOFFIT
 60. OPT. DOOR / WINDOW
 61. PRE-MANUFACTURED DECORATIVE COLUMN (SIZE, SEE ELEV.) FYPON OR EQ. SURROUNDING STRUCTURAL POST.
 62. BRICK / STONE VENEER - REFER TO ELEVATIONS
 63. SECTIONAL GARAGE DOOR PER SPECS
 66. 3" DIAM. CONCRETE FILLED PIPE BOLLARD 36" HIGH WITH MIN. 12" EMBEDMENT INTO CONCRETE. (NOT REQUIRED AT ELECTRIC WATER HEATERS OR FOR APPLIANCES LOCATED OUT OF THE VEHICLE'S NORMAL TRAVEL PATH)
 68. P.T. POST IV WRAP.
 70. EGRESS WINDOW
 75. WINDOW LEDGE. HEIGHT & WIDTH OF OPENING TO EXTEND 6" BEYOND WINDOW(S) ON ALL SIDES U.N.O.
 76. SITE-BUILT COLUMN - SEE ELEVATION FOR TYPE
 77. CONCRETE SLAB. SLOPE 1/4" PER FT. MIN. SEE PLAN FOR SITE.

- SLAB PLAN NOTES**
- NOTE: NOT ALL KEY NOTES APPLY.
1. CONCRETE PATIO/PORCH SLAB PER STRUCTURAL - SLOPE 1/4" PER FT. MIN.
 2. CONCRETE GARAGE SLAB PER STRUCTURAL - SLOPE 1/8" PER 1'-0" MIN. TOWARD DOOR OPENINGS.
 3. CONCRETE FOUNDATION PER STRUCTURAL.
 4. CONCRETE STOOP: 36"x36" STANDARD SLOPE 1/4" PER FT. MIN.
 5. CONCRETE DRIVEMAY SLOPE 1/4" PER FT. MIN. AWAY FROM GARAGE DOOR OPENINGS.
 6. PROVIDE ELECTRICAL CONDUIT UNDER SLAB AT ISLAND. VERIFY LOCATION.
 7. 5" BRICK LEDGE FOR MASONRY VENEER.
 8. 3" DIAMETER CONCRETE FILLED PIPE BOLLARD 36" HIGH WITH MIN. 12" EMBEDMENT INTO CONCRETE.
 9. REFER TO CIVIL DRAWINGS FOR ALL FINISH SURFACE ELEVATIONS.
 10. VERIFY ALL PLUMBING STUD DIMENSIONS SHOWN HERE PRIOR TO POUR OF SLAB
 11. 4" MIN. 8 1/4" MAX. TO HARD SURFACE.
 12. A/C PAD. VERIFY LOCATION.
 13. 36" WIDE WALKWAY - SLOPE 1/4" PER FT. MIN.

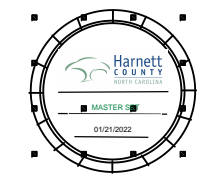

NORTH CAROLINA 40' SERIES

KB HOME
NORTH CAROLINA DIVISION
4506 S. MIAMI BLVD.
SUITE 180
DURHAM, NC 27703
TEL: (919) 768-7980
FAX: (919) 544-2928

2018 NORTH CAROLINA STATE BUILDING CODES

ISSUE DATE: 01/08/15
PROJECT No.: 1350999:56
DIVISION MGR.: DCS
REVISIONS: 08/20/20

- 11 DIVISION REVISION NC13654NCP - 08/28/19 - FAB
- 12 DIVISION REVISION NC19677NCP - 09/26/19 - FAB
- 13 DIVISION REVISION NC20003NCP - 12/19/19 - CL
- 14 VENTILATION NC20008NCP - 01/17/20 - CL
- 15 DIVISION REVISION NC20013NCP - 02/10/20 - MCP
- 16 DIVISION REVISION NC20017NCP - 03/04/20 - KBA
- 17 HOME OFFICE CORP20009CORP-08/20/20-CTD

FOR INTERNAL USE ONLY

REVIEWED BY:

1.	
2.	
3.	
4.	
5.	
6.	

PLAN: 238.2338
SHEET: 91

SPEC. LEVEL 1 RALEIGH-DURHAM 40' SERIES

SUNROOM AT SLAB ON GRADE
SCALE 1/4"=1'-0" (22'x34') - 1/8"=1'-0" (11'x17')

These designs and drawings are CONFIDENTIAL, and the exclusive property of KB Home Corporation and are not to be disclosed without the express permission of KB Home Corporation. Copyright 2020 © KB Home Corporation, all rights reserved.



PARTIAL RIGHT ELEVATION

PARTIAL REAR ELEVATION

PARTIAL LEFT ELEVATION

ROOF PLAN NOTES	
	INDICATES ROOF SLOPE AND DIRECTION, U.N.O.
ROOF MATERIAL: COMPOSITION SHINGLE	
12" (INCHES) TYPICAL ROOF OVERHANGS AT RAKE, U.N.O.	
12" (INCHES) TYPICAL ROOF OVERHANGS AT EAVE, U.N.O.	
LOCATE EAVE/ RAFTER VENTS EQUALLY BALANCED AROUND HOUSE EXCEPT ABOVE SHEARWALL PANELS.	
ATTIC VENT CALCULATIONS	
PROVIDE 1 SQ. IN. OF VENTILATION PER 500 SQ. IN. OF ATTIC SPACE. PROVIDE THAT AT LEAST 50% & NO MORE THAN 80% OF THE REQ. VENTILATING AREA IS PROVIDED BY VENTILATORS LOCATED IN THE UPPER PORTION OF THE ATTIC (HIGH VENTING) AT 3'-0" ABOVE EAVE VENT WITH THE BALANCE BEING PROVIDED BY EAVE VENTS (LOW VENTING)	
* CALCULATION BY 1/150, HIGH/LOW VENTING NOT REQUIRED.	
AREA 5 / MAIN IV SUNROOM:	
VENTILATION REQUIRED:	
ATTIC AREA = 144	SQ. FT. / 150 = 0.96 SQ. FT.
	X 144 = 138 SQ. IN.
	TOTAL HIGH & LOW = 138 SQ. IN.
VENTILATION PROVIDED:	
20	LF VENTILATED SOFFIT AT 6.9 SQ. IN. / LF. = 138 SQ. IN.
4	LF RIDGE VENT(S) AT 18 SQ. IN. EA. = 72 SQ. IN.
TOTAL VENTILATION PROVIDED:	210 SQ. IN.

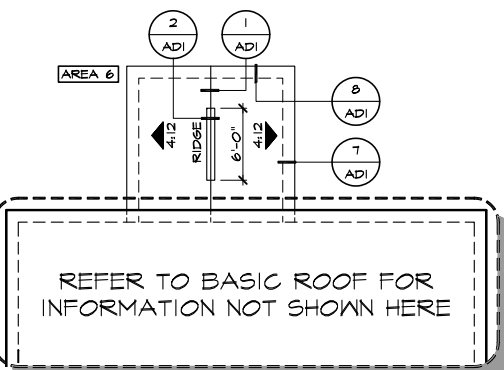

PARTIAL ROOF PLAN

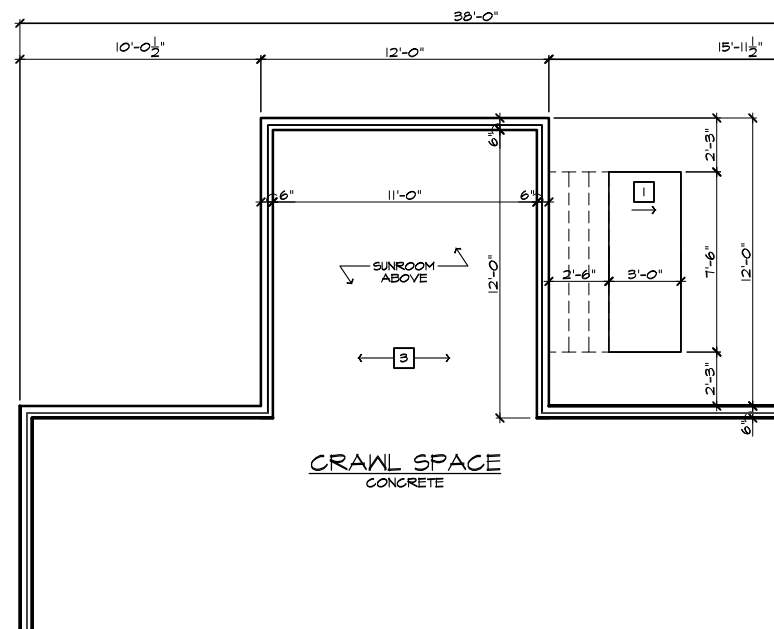

PARTIAL CRAWL SPACE PLAN

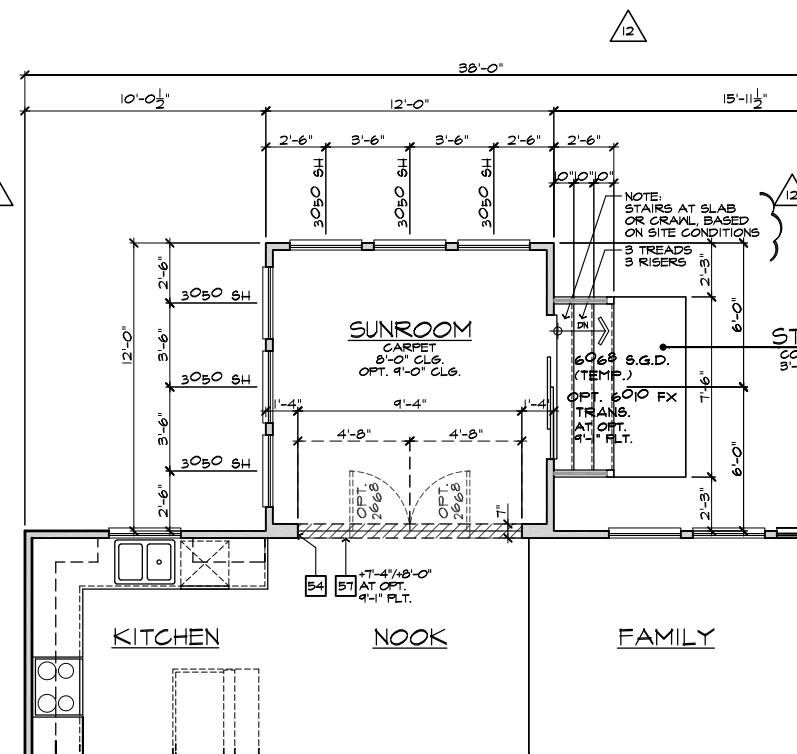

PARTIAL FIRST FLOOR PLAN

SUNROOM AT CRAWL SPACE

SCALE 1/4"=1'-0" (22"X34") - 1/8"=1'-0" (11"X17")

ELEVATION NOTES

- NOTE: NOT ALL KEY NOTES APPLY.
- ROOF MATERIAL - REFER TO ROOF NOTES
 - 2X FASCIA/BARGE BOARD WITH FASCIA CAP
 - G.I. FLASHING
 - G.I. FLASHING & SADDLE/GRICKET
 - G.I. DRIP SCREED
 - 24"X24" CHIMNEY
 - DECORATIVE VENT
 - DECORATIVE CORBEL
 - DECORATIVE SHUTTERS
 - PEDIMENT. SEE ELEVATION FOR TYPE
 - RECESSED ELEMENT
 - DECORATIVE TRIM FYPON OR EQ. SEE ELEVATION FOR TYPE
 - TRIM PER SPEC- SEE ELEVATION FOR SIZE
 - SYNTHETIC MATERIAL
 - PRE-MANUFACTURED DECORATIVE COLUMN (SIZE, SEE ELEV.) FYPON OR EQ. SURROUNDING STRUCTURAL POST.
 - SITE-BUILT COLUMN - SEE ELEVATION FOR TYPE
 - SHAKE SIDING
 - STONE VENEER PER SPECS
 - BRICK/MASONRY VENEER PER SPECS
 - BUILT UP BRICK COLUMN
 - SOLDIER COURSE
 - ROWLOCK COURSE
 - FRIEZE BOARD
 - SIDING W/ 4" CORNER TRIM PER SPECS
 - P.T. POST W/ WRAP - SEE STRUCTURAL FOR SIZE
 - PRE-FAB DECORATIVE TRIM
 - LIGHT WEIGHT PRECAST STONE TRIM
 - P.T. LUMBER RAILINGS (36" U.N.O.)
 - WRAP
 - DECORATIVE WINDOW/DOOR TRIM - FYPON OR EQ. SEE ELEVATION FOR SIZE.
 - SOLDIER COURSE
 - BRACKET OR KICKER - FYPON OR EQ.
 - ENTRY DOOR
 - CONCRETE STOOP/ PORCH - SEE SLAB INTERFACE PLAN.
 - SECTIONAL GARAGE DOOR PER SPECS
 - ALUMINUM WRAP
 - OPTIONAL DOOR/WINDOW - REFER TO PLAN OPTIONS
 - OPTIONAL STANDING SEAM METAL ROOF
 - KEYSTONE
 - SOLDIER CROWN
 - JACK SOLDIER COURSE
 - WATER TABLE
 - ATRIUM DOOR
 - PILASTER - SEE ELEVATION FOR TYPE

PARTIAL PLAN NOTES

- NOTE: NOT ALL KEY NOTES APPLY.
- WATER HEATER LOCATION - FOR GAS - LOCATE ON 18" HIGH PLATFORM - FOR INTERIOR LOCATION - PROVIDE PAN & DRAIN (REFER TO DETAILS)
 - WATER HEATER VENT TO OUTSIDE AIR
 - MAIN LINE SHUT-OFF VALVE AND TEMP. & PRESSURE RELIEF VALVE
 - LINE V. WALL BELOW
 - LINE OF FLOOR ABOVE
 - LINE OF FLOOR BELOW
 - LINE 36" HIGH GUARDRAIL (REFER TO DETAIL SHEETS)
 - A/C PAD LOCATION
 - LOW WALL - REFER TO PLAN FOR HEIGHT
 - 2x6 STUD WALL
 - DEL. 2x4 MALL PER PLAN
 - INTERIOR SHELF - REFER TO PLAN FOR HEIGHT
 - FLAT SOFFIT
 - ARCHED SOFFIT
 - OPT. DOOR / WINDOW
 - PRE-MANUFACTURED DECORATIVE COLUMN (SIZE, SEE ELEV.) FYPON OR EQ. SURROUNDING STRUCTURAL POST.
 - BRICK / STONE VENEER - REFER TO ELEVATIONS
 - SECTIONAL GARAGE DOOR PER SPECS
 - 3" DIAM. CONCRETE FILLED PIPE BOLLARD 36" HIGH WITH MIN. 12" EMBEDMENT INTO CONCRETE. (NOT REQUIRED AT ELECTRIC WATER HEATERS OR FOR APPLIANCES LOCATED OUT OF THE VEHICLE'S NORMAL TRAVEL PATH)
 - P.T. POST W/ WRAP.
 - EGRESS WINDOW
 - WINDOW LEDGE. HEIGHT & WIDTH OF OPENING TO EXTEND 6" BEYOND WINDOW(S) ON ALL SIDES U.N.O.
 - SITE-BUILT COLUMN - SEE ELEVATION FOR TYPE
 - CONCRETE SLAB. SLOPE 1/4" PER FT. MIN. SEE PLAN FOR SITE.

SLAB PLAN NOTES

- NOTE: NOT ALL KEY NOTES APPLY.
- CONCRETE PATIO/PORCH SLAB PER STRUCTURAL- SLOPE 1/4" PER FT. MIN.
 - CONCRETE GARAGE SLAB PER STRUCTURAL- SLOPE 1/8" PER 1'-0" MIN. TOWARD DOOR OPENINGS.
 - CONCRETE FOUNDATION PER STRUCTURAL.
 - CONCRETE STOOP: 36"X36" STANDARD SLOPE 1/4" PER FT. MIN.
 - CONCRETE DRIVEMAY SLOPE 1/4" PER FT. MIN. AWAY FROM GARAGE DOOR OPENINGS.
 - PROVIDE ELECTRICAL CONDUIT UNDER SLAB AT ISLAND. VERIFY LOCATION.
 - 5" BRICK LEDGE FOR MASONRY VENEER.
 - 3" DIAMETER CONCRETE FILLED PIPE BOLLARD 36" HIGH WITH MIN. 12" EMBEDMENT INTO CONCRETE.
 - REFER TO CIVIL DRAWINGS FOR ALL FINISH SURFACE ELEVATIONS.
 - VERIFY ALL PLUMBING STUB DIMENSIONS SHOWN HERE PRIOR TO POOR OF SLAB
 - 4" MIN. 8 1/4" MAX. TO HARD SURFACE.
 - A/C PAD. VERIFY LOCATION.
 - 36" WIDE WALKWAY- SLOPE 1/4" PER FT. MIN.

NOTE: REFER TO BASIC ROOF PLAN FOR INFORMATION NOT SHOWN HERE

NOTE: REFER TO BASIC ELEVATIONS FOR INFORMATION NOT SHOWN HERE

NOTE: REFER TO BASIC FLOOR PLAN FOR INFORMATION NOT SHOWN HERE

NOTE: REFER TO BASIC SLAB PLAN FOR INFORMATION NOT SHOWN HERE



NORTH CAROLINA 40' SERIES

KB HOME
NORTH CAROLINA DIVISION
4506 S. MIAMI BLVD.
SUITE 180
DURHAM, NC 27703
TEL: (919) 768-7980
FAX: (919) 544-2928

2018 NORTH CAROLINA STATE BUILDING CODES

ISSUE DATE: 01/08/15
PROJECT No.: 1350999:56
DIVISION MGR.: DCS
REVISIONS: 08/20/20

- 11 DIVISION REVISION NC13654NCP - 08/28/19 - FAB
- 12 DIVISION REVISION NC19657NCP - 09/26/19 - FAB
- 13 DIVISION REVISION NC20003NCP - 12/19/19 - CL
- 14 VENTILATION NC20008NCP - 01/17/20 - CL
- 15 DIVISION REVISION NC20013NCP - 02/10/20 - MCP
- 16 DIVISION REVISION NC20017NCP - 03/04/20 - KBA
- 17 HOME OFFICE CORP120095CORP-08/20/20-CTD

FOR INTERNAL USE ONLY	
REVIEWED BY:	
1.	
2.	
3.	
4.	
5.	
6.	

PLAN: 238.2338

SHEET: 9.2

SPEC. LEVEL 1 RALEIGH-DURHAM 40' SERIES

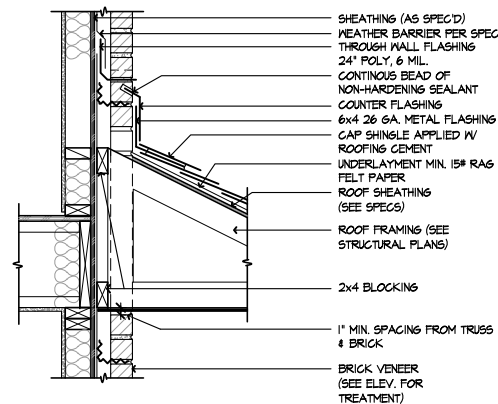

BRICK THROUGH ROOF

SCALE 1/4"=1'-0"

SE-01017a

17

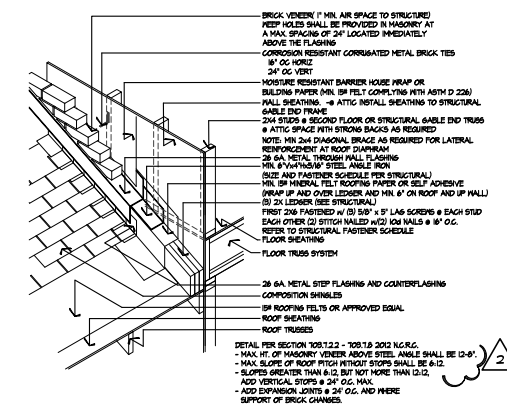

BRICK OVER ROOF

SCALE NTS

13

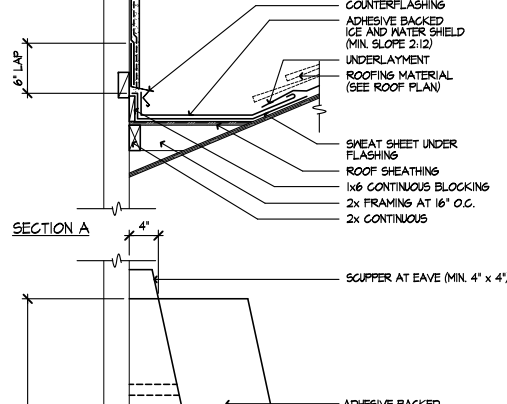

EAVE @ METAL ROOF

SCALE 1/2"=1'-0"

5

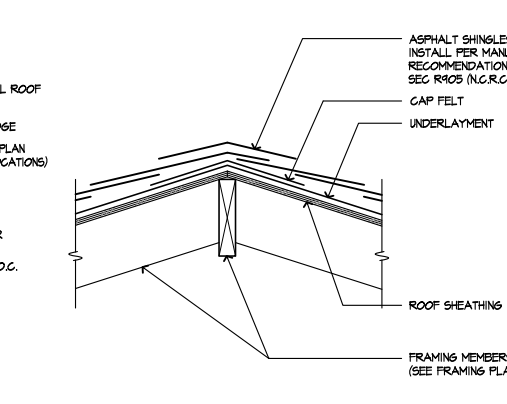

RIDGE

SCALE 1/2"=1'-0"

1

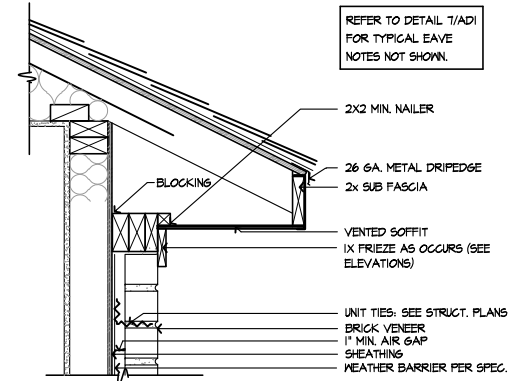

EAVE - BRICK

SCALE 1/2"=1'-0"

SE-01018a

18

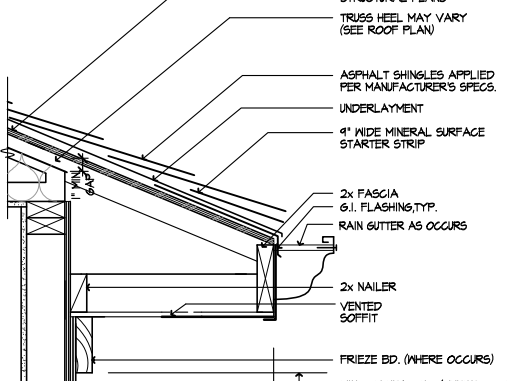

EAVE

SCALE 1/2"=1'-0"

14

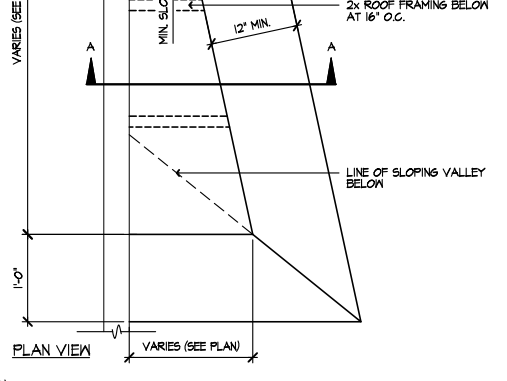

CRICKET

SCALE 1/2"=1'-0"

10

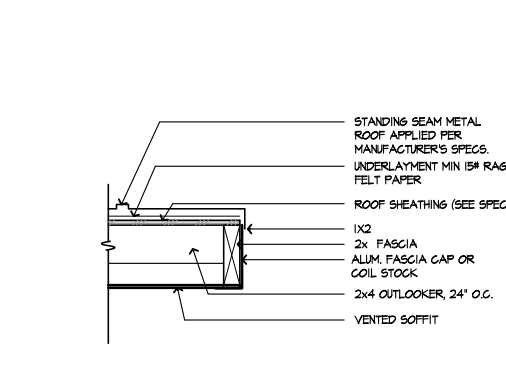

RAKE @ METAL ROOF

SCALE 1/2"=1'-0"

6

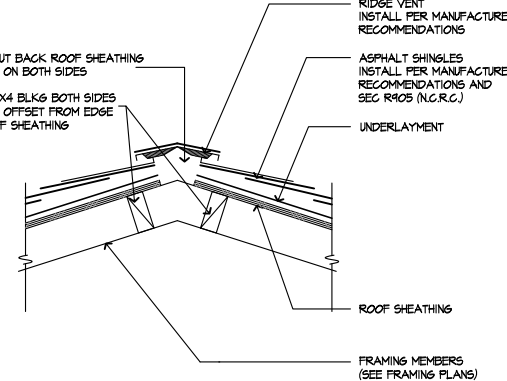

RIDGE VENT

SCALE 1/2"=1'-0"

2

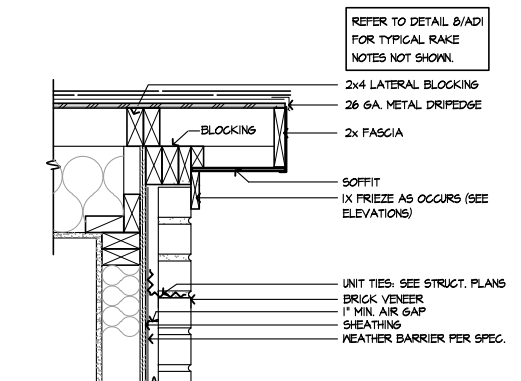

RAKE - BRICK

SCALE 1/2"=1'-0"

SE-01019a

19

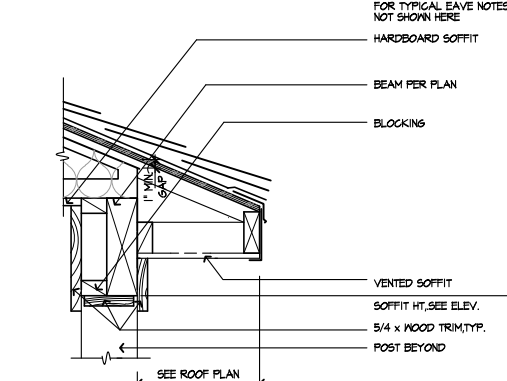

PORCH EAVE

SCALE 1/2"=1'-0"

15

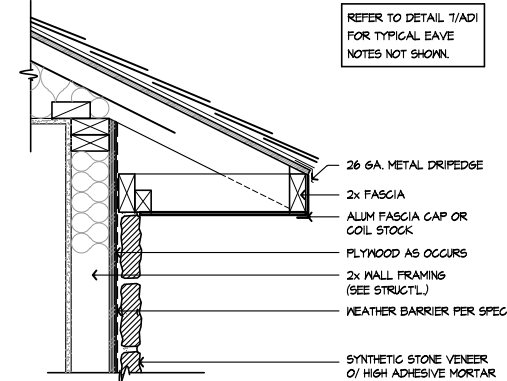

EAVE - STONE

SCALE 1/2"=1'-0"

11

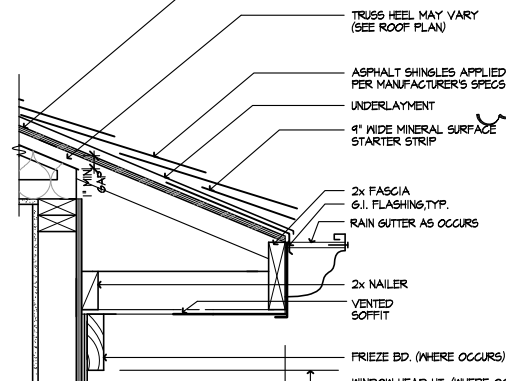

EAVE

SCALE 1/2"=1'-0"

7

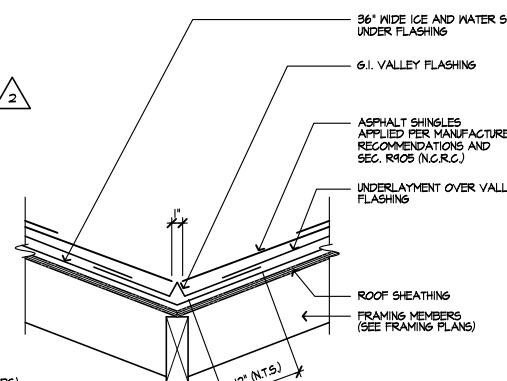

VALLEY

SCALE 1/2"=1'-0"

3

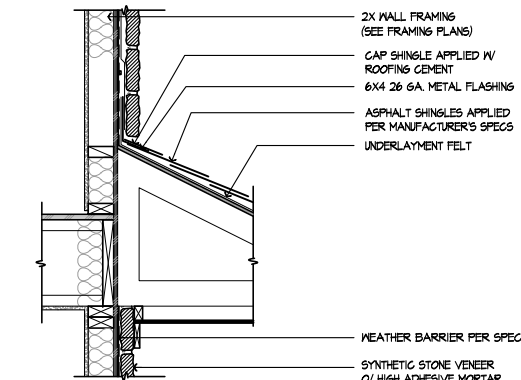

STONE TO ROOF

SCALE 1/4"=1'-0"

SE-01020a

20

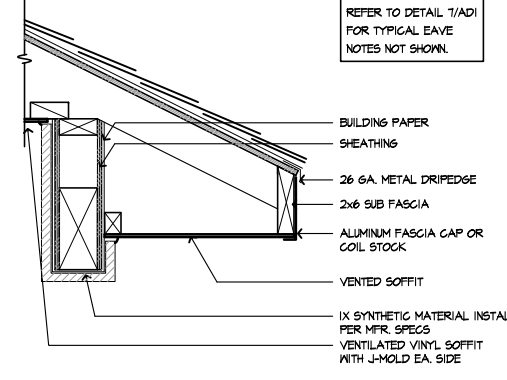

**SOFFIT @ PORCH -
SYNTHETIC MATERIAL**

SCALE 1/2"=1'-0"

16

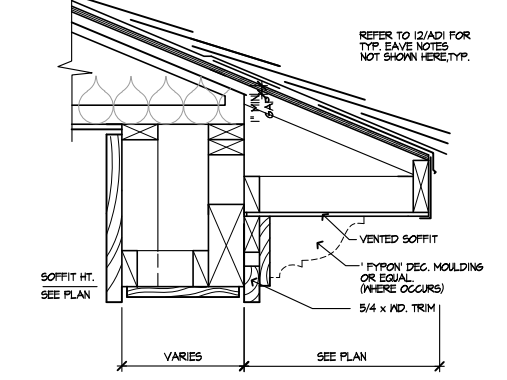

EAVE AT PORCH

SCALE 1/2"=1'-0"

12

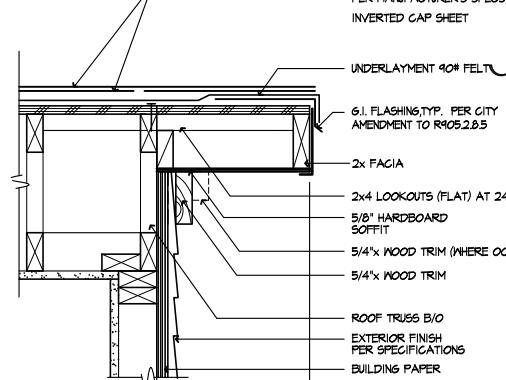

RAKE

SCALE 1/2"=1'-0"

8

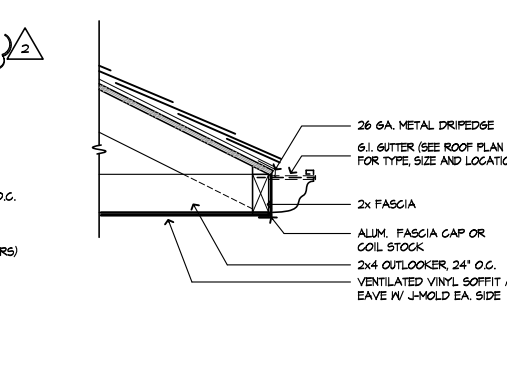

TYPICAL EAVE GUTTER

SCALE 1/2"=1'-0"

4

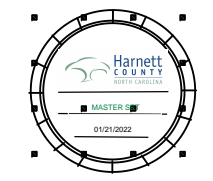

DETAILS

KB HOME
 NORTH CAROLINA DIVISION
 4518 S. MIAMI BLVD.
 SUITE 180
 DURHAM, NC 27703
 TEL: (919) 768-7988
 FAX: (919) 472-0582

ISSUE DATE: 09/28/11
 PROJECT No.: 1350
 DIVISION MGR.: M.C.P.
 REVISIONS: 01/15/20

- 1 COMPLIANCE REVIEW
NC12008 - 02/28/12 - CTD
- 2 2012 NC CODE UPDATE
NC12016 - 03/22/12 - CTD
- 3 DETAIL UPDATES
NC12063 - 11/3/15 - DC3
- 4 2018 NC CODE UPDATE
NC19015 - 01/24/19 - MCP
- 5 DETAIL UPDATE
NC20001NCF - 01/15/20 - MCP

FOR INTERNAL USE ONLY

REVIEWED BY:	DATE:
1. _____	_____
2. _____	_____
3. _____	_____
4. _____	_____
5. _____	_____
6. _____	_____

PLAN: **ALL**
 SHEET: **AD1**

These designs and drawings are CONFIDENTIAL, and the exclusive property of KB Home Corporation and are not to be disclosed without the express permission of KB Home Corporation. Copyright 2014 © KB Home Corporation, all rights reserved.

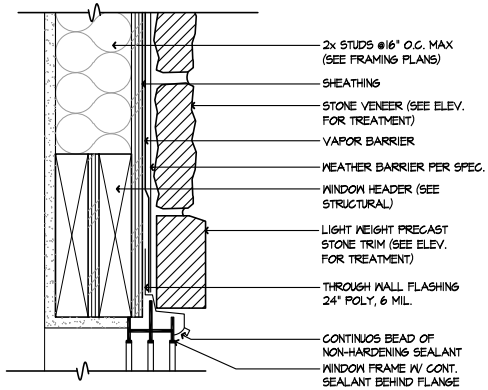

WINDOW HEAD - STONE

SCALE 3/8"=1'-0"

SE-02096a

37

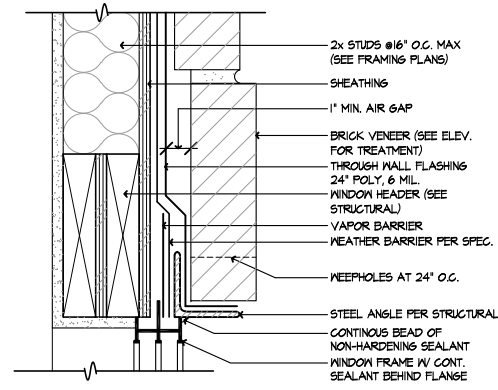

WINDOW HEAD - BRICK

SCALE 3/8"=1'-0"

SE-02096a

33

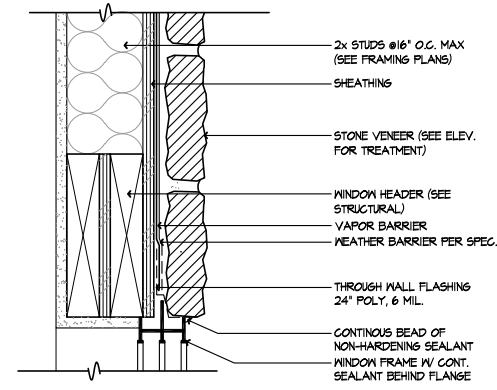

WINDOW HEAD - STONE

SCALE 3/8"=1'-0"

SE-02029a

29

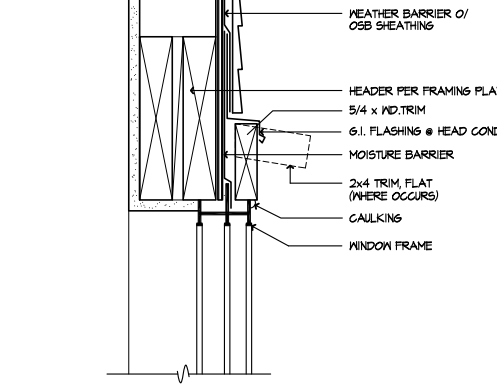

WINDOW HEAD

SCALE 3/8"=1'-0"

0850-01J

25

WINDOW FLASHING

EXTERIOR OPENINGS EXPOSED TO THE WEATHER SHALL BE FLASHED IN SUCH A MANNER AS TO MAKE THEM WATERPROOF.

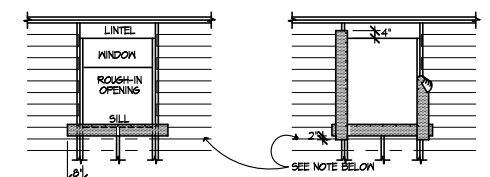

1. ATTACH SILL STRIP WITH TOP EDGE LEVEL WITH ROUGH SILL - EXTEND BEYOND EDGE OF ROUGH OPENING AT LEAST 6". SECURE ALL MOISTOP (OR EQUAL) WITH GALVANIZED NAILS OR POWER-DRIVEN STAPLES.
2. ATTACH JAMB STRIP WITH SIDE EDGE EVEN WITH ROUGH JAMB FRAMING. START STRIP 1" BELOW LOWER EDGE OF SILL STRIP AND EXTEND 4" ABOVE LOWER EDGE OF LINTEL. OR POWER-DRIVEN STAPLES.

NOTE: LINE-WIRE, WHEN USED AS BACKING TO SUPPORT BUILDING PAPER BENEATH WIRE LATH (NETTING) FOR PORTLAND CEMENT PLASTER (STUCCO), SHALL BE INSTALLED AS FOLLOWS:

1. WIRE GAUGE, SPACING, AND ATTACHMENT SHALL BE IN ACCORDANCE WITH REQUIREMENTS OF BUILDING DEPT. ITEMS 25-1.
2. PERIPHERAL FLASHINGS AT ALL EDGES OF WALL OPENINGS, MUST COVER THE WIRE BACKING.
3. NO ATTACHMENT DEVICES NOR THE WIRE BACKING SHALL COVER OR PENETRATE THE FLASHING MATERIAL.

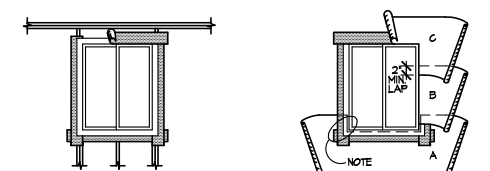

3. INSTALL WINDOW JAMB NAILING FLANGES OVER A CONTINUOUS BEAD OF SEALANT ON THE MOISTOP (OR EQUAL). INSTALL THE WINDOW HEAD MOISTOP (OR EQUAL) ON A CONTINUOUS BEAD OF SEALANT APPLIED TO THE WINDOW HEAD NAILING FLANGE.
4. COMMENCING AT THE BOTTOM (SOLE PLATE) OF THE WALL, LAY BUILDING PAPER UNDER SILL STRIP. NOTE: CUT ANY EXCESS BUILDING PAPER THAT MAY EXTEND ABOVE THE SILL FLANGE LINE ON EACH SIDE OF (SHOWN AS SHORT DASHED LINES). DO NOT SLICE BUILDING PAPER HORIZONTALLY, SO THAT THE PAPER WILL LAP OVER THE JAMB STRIPS. INSTALL SUCCESSIVE LINES OF BUILDING PAPER (5/8\"/>

NOTE: CUT ANY EXCESS BUILDING PAPER THAT MAY EXTEND ABOVE THE SILL FLANGE LINE ON EACH SIDE OF (SHOWN AS SHORT DASHED LINES). DO NOT SLICE BUILDING PAPER HORIZONTALLY, SO THAT THE PAPER WILL LAP OVER THE JAMB STRIPS. INSTALL SUCCESSIVE LINES OF BUILDING PAPER (5/8\"/>

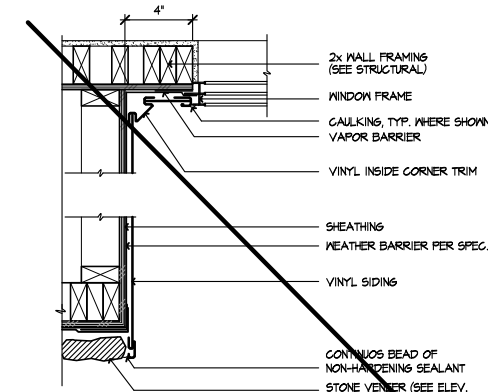

RECESSED WINDOW JAMB - STONE

SCALE 1/2"=1'-0"

SE-02098a

38

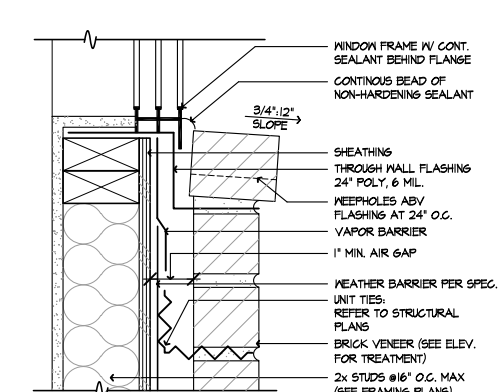

WINDOW SILL - BRICK

SCALE 3/8"=1'-0"

SE-02094a

34

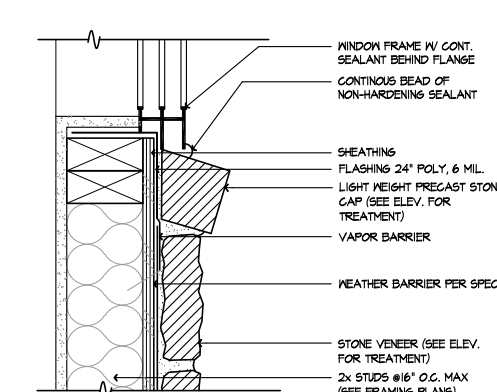

WINDOW SILL - STONE

SCALE 3/8"=1'-0"

SE-02090a

30

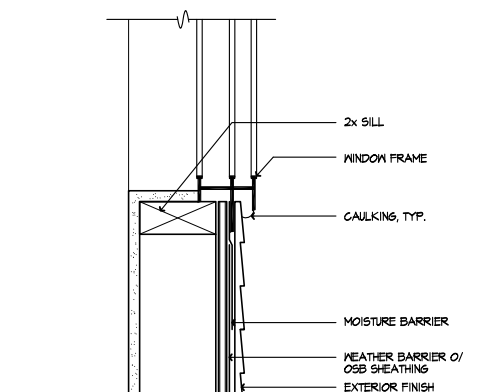

WINDOW SILL

SCALE 3/8"=1'-0"

0850-111

26

VAPOR BARRIER

SCALE 1/4"=1'-0"

SE-02022a

22

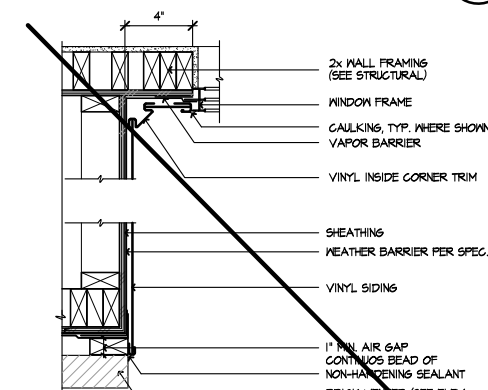

RECESSED WINDOW JAMB - BRICK

SCALE 1/2"=1'-0"

SE-02099a

39

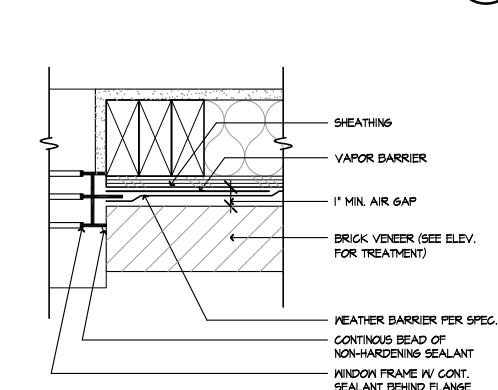

WINDOW JAMB - BRICK

SCALE 3/8"=1'-0"

SE-02095a

35

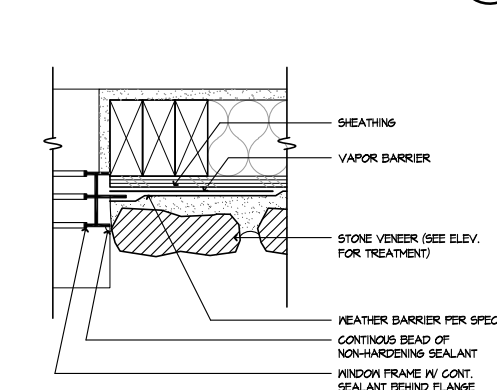

WINDOW JAMB - STONE

SCALE 3/8"=1'-0"

SE-02091a

31

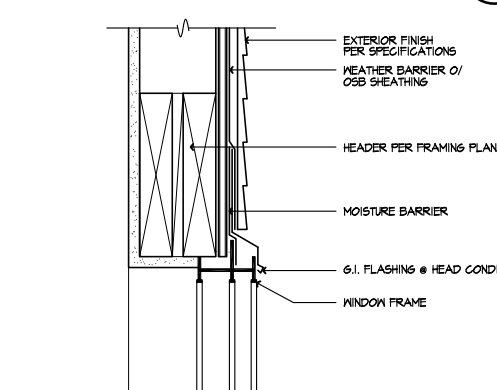

WINDOW HEAD

SCALE 3/8"=1'-0"

0850-15

27

WINDOW JAMB

SCALE 3/8"=1'-0"

0850-02s

23

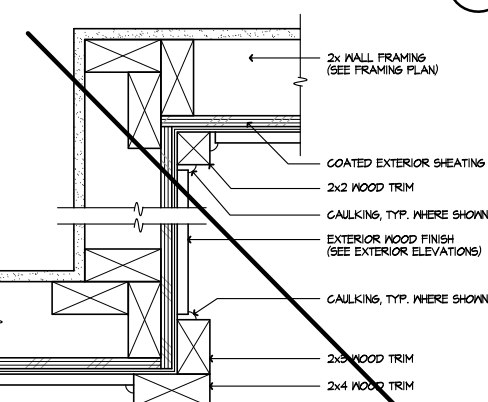

SIDING - CORNER. TRIM

SCALE 3/8"=1'-0"

0746-02

40

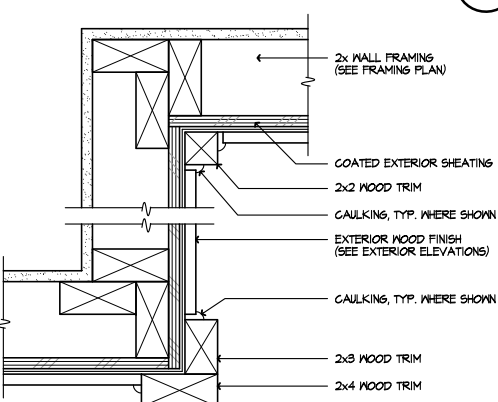

SIDING - CORNER. TRIM

SCALE 3/8"=1'-0"

0746-02

36

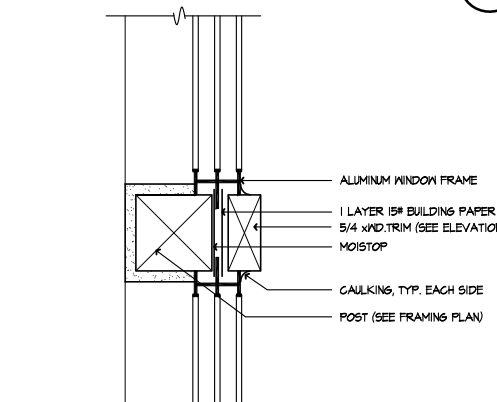

VERT. WINDOW MULL.

SCALE 3/8"=1'-0"

0850-04a

32

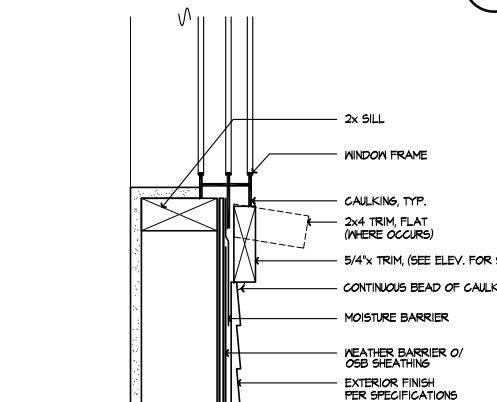

WINDOW SILL

SCALE 3/8"=1'-0"

0850-02s

28

WINDOW JAMB

SCALE 3/8"=1'-0"

0850-02s

24



DETAILS

KB HOME
NORTH CAROLINA DIVISION
4518 S. MIAMI BLVD.
SUITE 180
DURHAM, NC 27703
TEL: (919) 768-7988
FAX: (919) 472-0582

ISSUE DATE: 09/28/11
PROJECT No.: 1350
DIVISION MGR.: M.C.P.
REVISIONS: 01/15/20

- 1 COMPLIANCE REVIEW NC12008 - 02/28/12 - CTD
- 2 2012 NC CODE UPDATE NC12016 - 03/22/12 - CTD
- 3 DETAIL UPDATES NC12953 - 11/15 - DC3
- 4 2018 NC CODE UPDATE NC19015 - 01/24/19 - MCP
- 5 DETAIL UPDATE NC20001NCP - 01/15/20 - MCP

FOR INTERNAL USE ONLY	
REVIEWED BY:	
1.	
2.	
3.	
4.	
5.	
6.	

PLAN: ALL
SHEET: AD2

These designs and drawings are CONFIDENTIAL, and the exclusive property of KB Home Corporation, and are not to be disclosed without the express permission of KB Home Corporation. They may not be used or duplicated without the express permission of KB Home Corporation. Copyright 2014 © KB Home Corporation, all rights reserved.

GARAGE DOOR HEAD - STONE

SCALE 1 1/2"=1'-0" SE-03057b

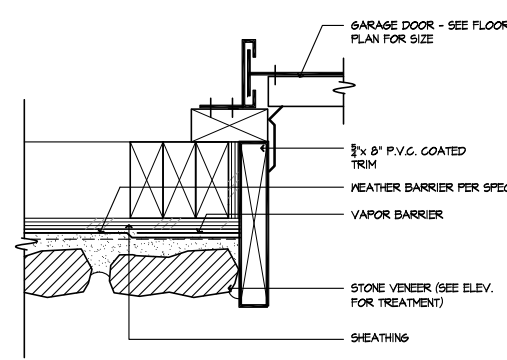

DOOR HEAD - BRICK

SCALE 3\"/>

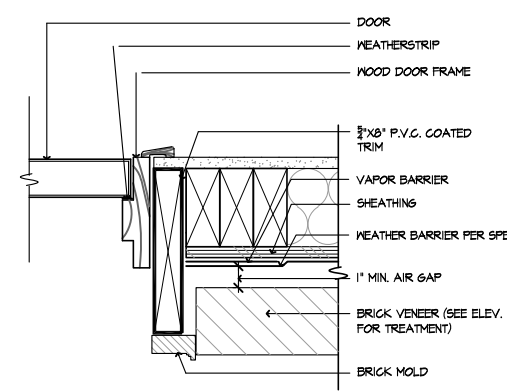

DOOR HEAD - STONE

SCALE 3\"/>

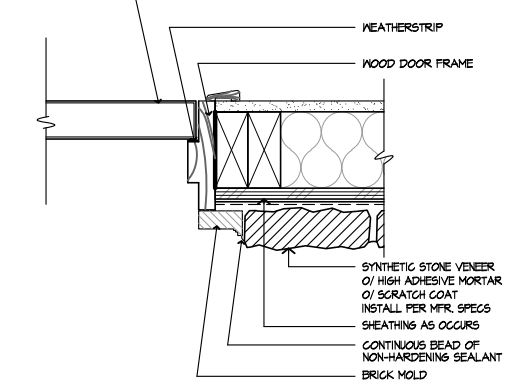

SLIDING DR. HEAD

SCALE 3\"/>

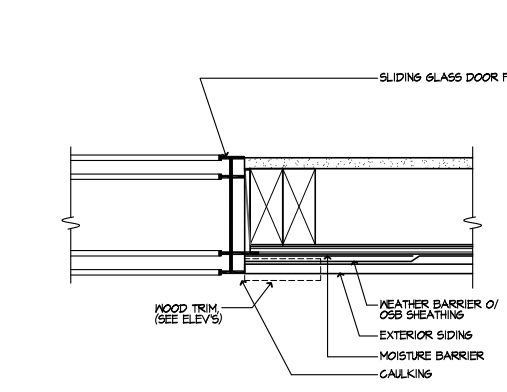

DOOR HEAD

SCALE 3\"/>

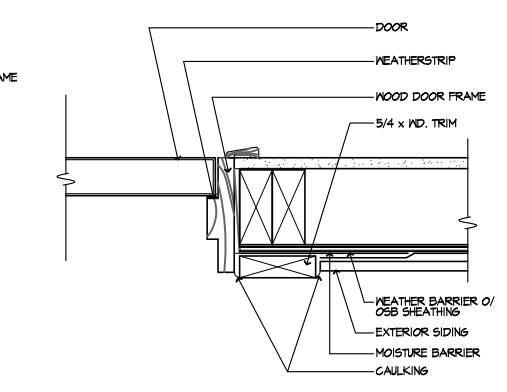

GARAGE DOOR JAMB - STONE

SCALE 3\"/>

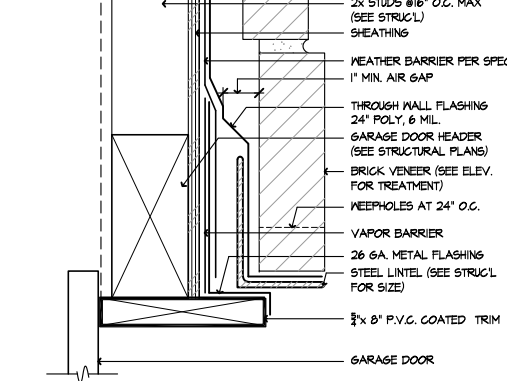

DOOR JAMB - BRICK

SCALE 3\"/>

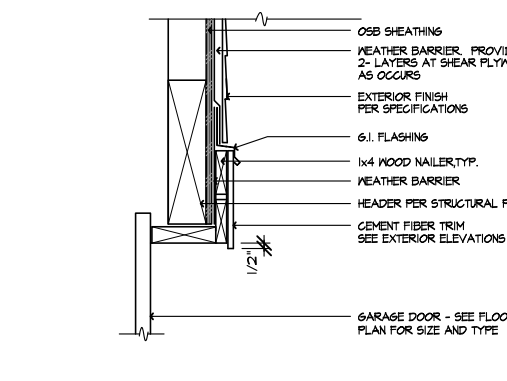

DOOR JAMB - STONE

SCALE 3\"/>

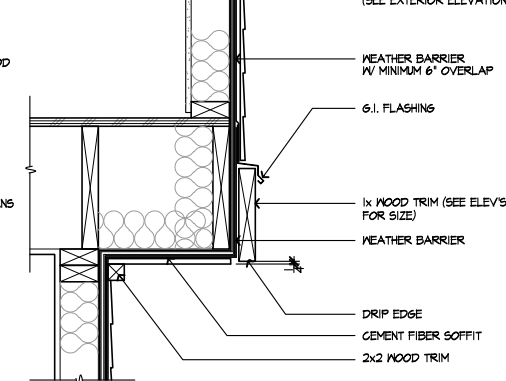

SLIDING DOOR JAMB

SCALE 3\"/>

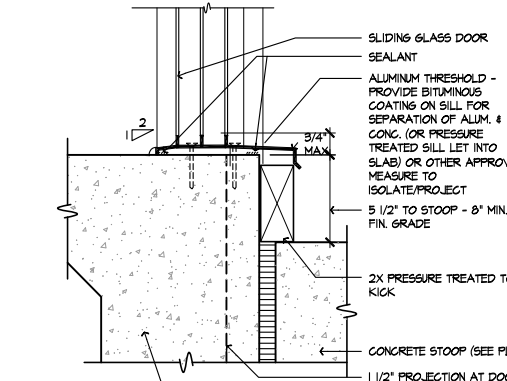

DOOR JAMB

SCALE 3\"/>

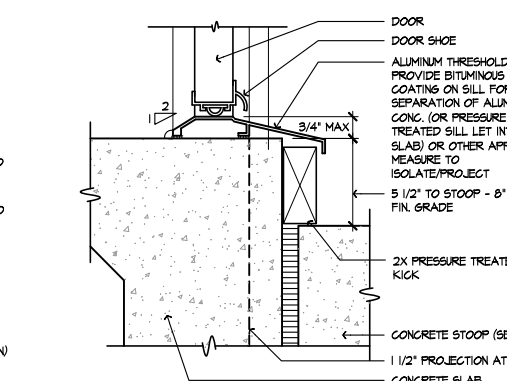

GARAGE DOOR HEAD - BRICK

SCALE 3\"/>

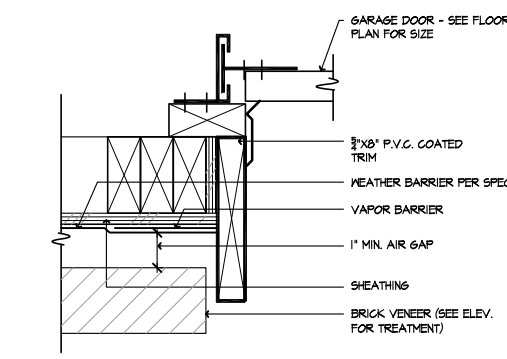

GARAGE DOOR HEAD

SCALE 1 1/2\"/>

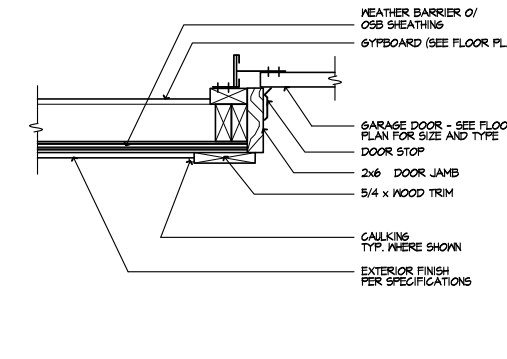

TRIM @ CANTILEVER

SCALE 1 1/2\"/>

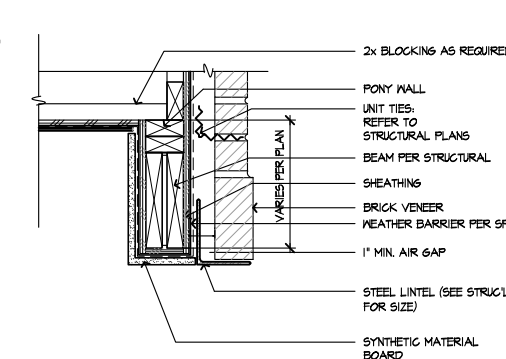

SLDg. DOOR THRESHOLD

SCALE 3\"/>

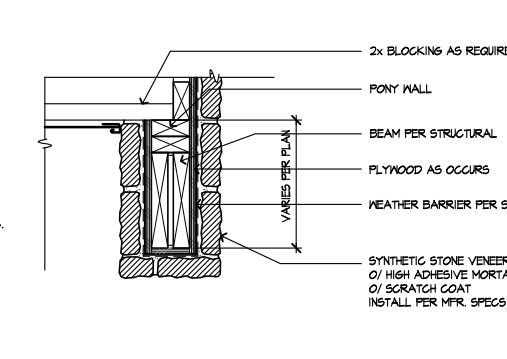

SWING DOOR THRESHOLD

SCALE 3\"/>

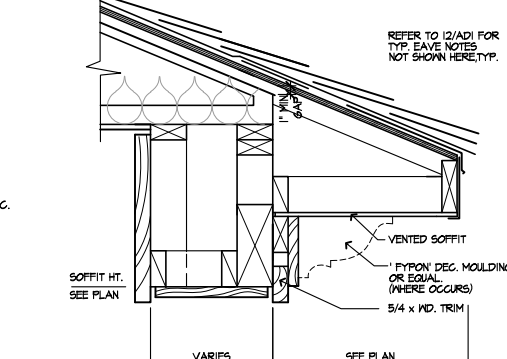

GARAGE DOOR JAMB - BRICK

SCALE 3\"/>



GARAGE DOOR JAMB

SCALE 1 1/2\"/>



SOFFIT @ PORCH - BRICK

SCALE 1 1/2\"/>



SOFFIT @ PORCH - STONE

SCALE 1 1/2\"/>



EAVE AT PORCH

SCALE 1 1/2\"/>

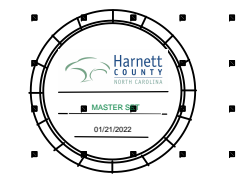
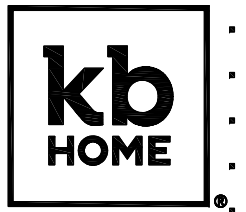
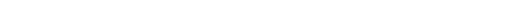

DETAILS

KB HOME
NORTH CAROLINA DIVISION
4518 S. MIAMI BLVD.
SUITE 180
DURHAM, NC 27703
TEL: (919) 768-7988
FAX: (919) 472-0582

ISSUE DATE: 09/28/11
PROJECT No.: 1350
DIVISION MGR.: M.C.P.
REVISIONS: 01/15/20

- 1 COMPLIANCE REVIEW
NC12008 - 02/28/12 - CTD
- 2 2012 NC CODE UPDATE
NC12016 - 03/22/12 - CTD
- 3 DETAIL UPDATES
NC15953 - 11/15 - DC3
- 4 2018 NC CODE UPDATE
NC19015 - 01/24/19 - MCP
- 5 DETAIL UPDATE
NC20001NCP - 01/15/20 - MCP

FOR INTERNAL USE ONLY	
REVIEWED BY:	
1.	
2.	
3.	
4.	
5.	
6.	

PLAN: **ALL**
SHEET: **AD3**

These designs and drawings are CONFIDENTIAL, and the exclusive property of KB Home Corporation and are not to be disclosed without the express permission of KB Home Corporation. Copyright 2014 © KB Home Corporation, all rights reserved.

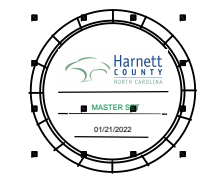

DETAILS

KB HOME
NORTH CAROLINA DIVISION
4518 S. MIAMI BLVD.
SUITE 180
DURHAM, NC 27703
TEL: (919) 768-7988
FAX: (919) 472-0582

ISSUE DATE: 09/28/11
PROJECT No.: 1350
DIVISION MGR.: M.C.P.
REVISIONS: 01/15/20

- 1 COMPLIANCE REVIEW
NC12008 - 02/28/12 - CTD
- 2 2012 NC CODE UPDATE
NC12016 - 03/22/12 - CTD
- 3 DETAIL UPDATES
NC15953 - 11/15 - DC3
- 4 2018 NC CODE UPDATE
NC19015 - 01/24/19 - MCP
- 5 DETAIL UPDATE
NC20001NCP - 01/15/20 - MCP

FOR INTERNAL USE ONLY	
REVIEWED BY:	
1.	
2.	
3.	
4.	
5.	
6.	

PLAN: **ALL**
SHEET: **AD4**

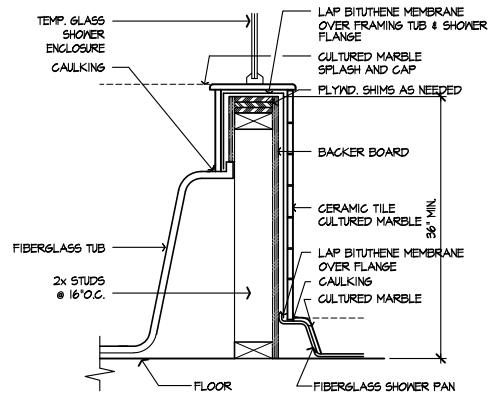

TUB/SHOWER WALL
SCALE 1 1/2"=1'-0"
SE-04071a

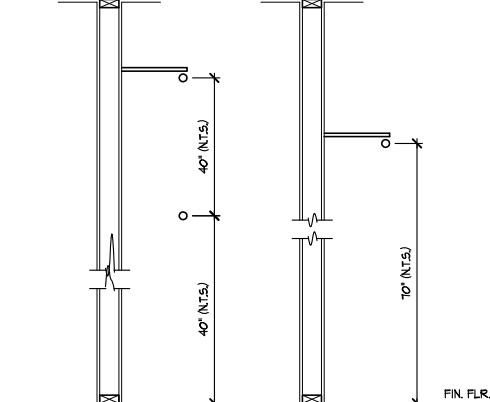

DBL./SGL. POLE & SHELF
SCALE 3/4"=1'-0"
SE-04073a

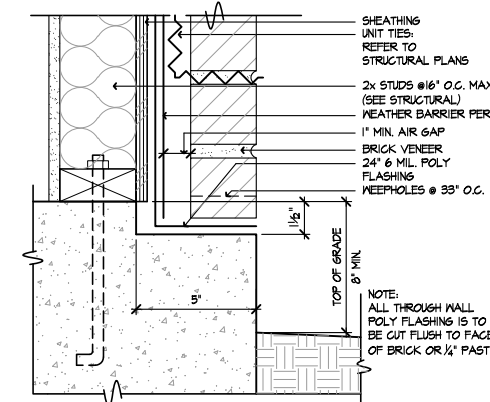

BRICK LEDGE AT SLAB
SCALE 3"=1'-0"
SE-04069a

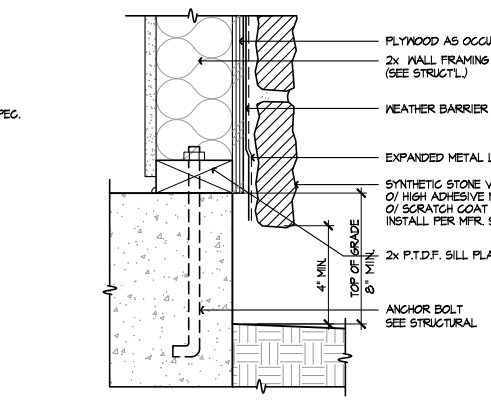

SYN. STONE SCREED
SCALE 3"=1'-0"
SE-04065a

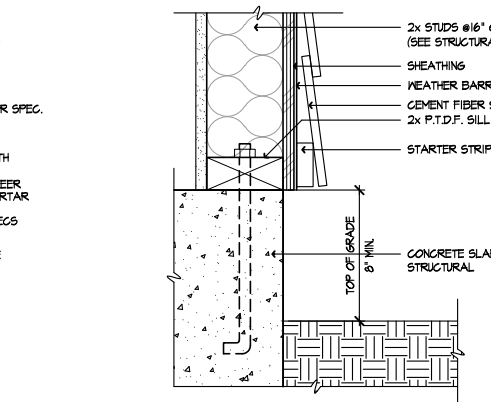

SIDING AT SLAB
SCALE 3"=1'-0"
SE-04061a

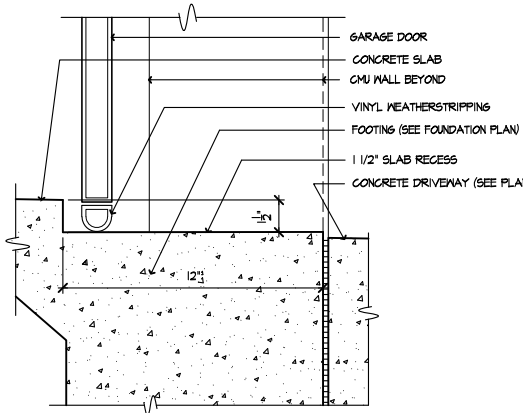

GARAGE SLAB RECESS
SCALE 1 1/2"=1'-0"
0810-01

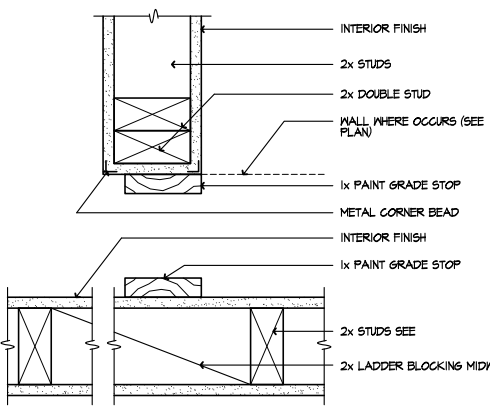

WARDROBE DOOR JAMB
SCALE 3"=1'-0"
SE-04074a

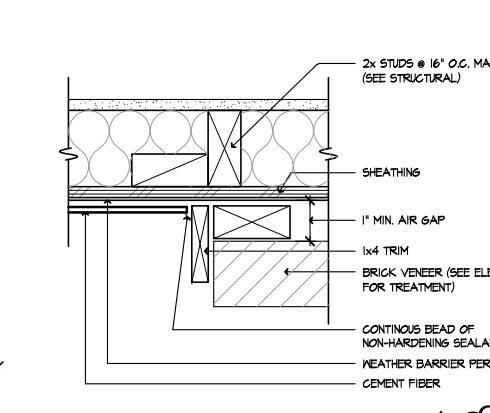

SIDING TO BRICK
SCALE 3"=1'-0"
SE-04070a

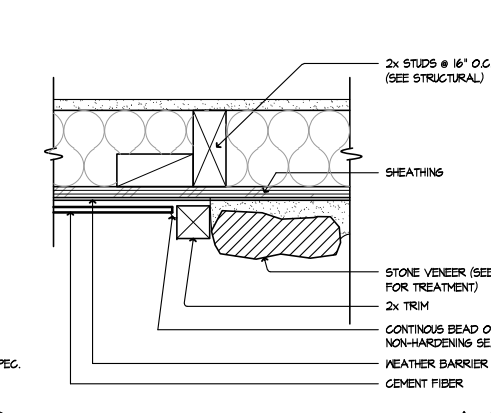

SIDING TO STONE
SCALE 3"=1'-0"
SE-04066a

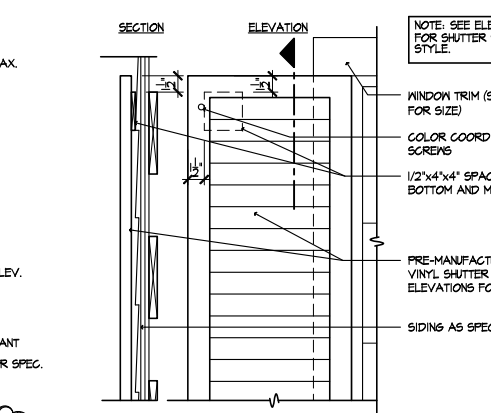

WINDOW SHUTTER
SCALE 1 1/2"=1'-0"
SE-04062a

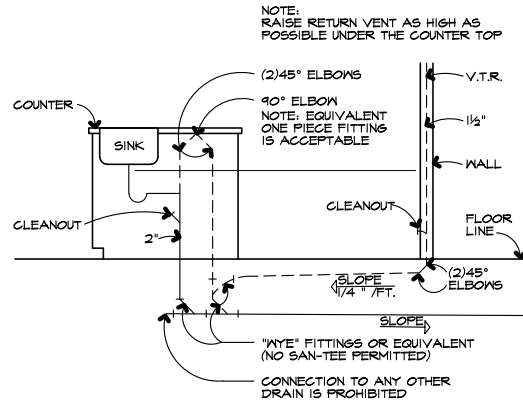

KITCHEN ISLAND
SCALE 1/2"=1'-0"
SE-04079a

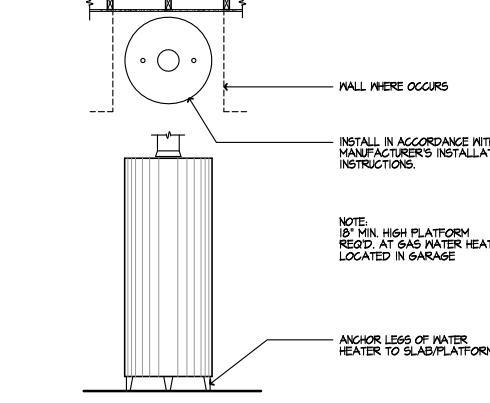

WATER HEATER
SCALE 1/2"=1'-0"
SE-04075a

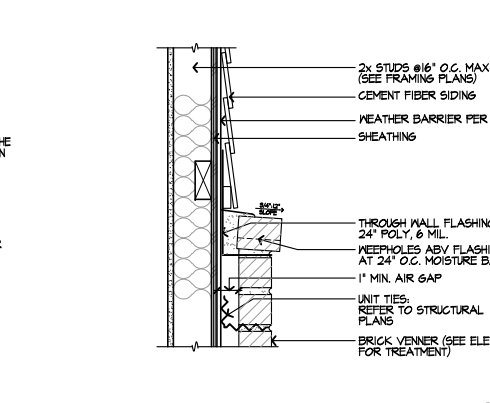

BRICK CAP @ SIDING
SCALE 1 1/2"=1'-0"
SE-04071a

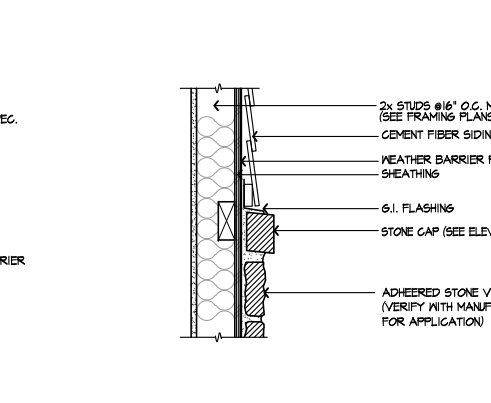

STONE CAP @ SIDING
SCALE 1 1/2"=1'-0"
SE-04067a

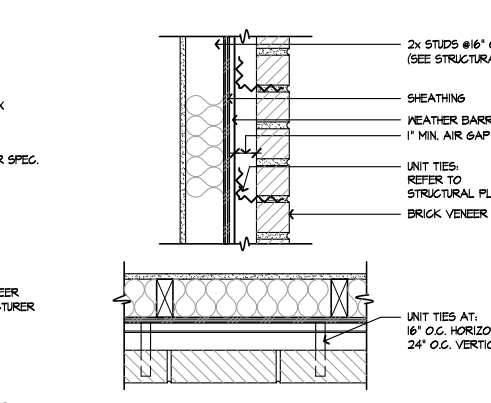

BRICK TIES
SCALE 1 1/2"=1'-0"
SE-04063a

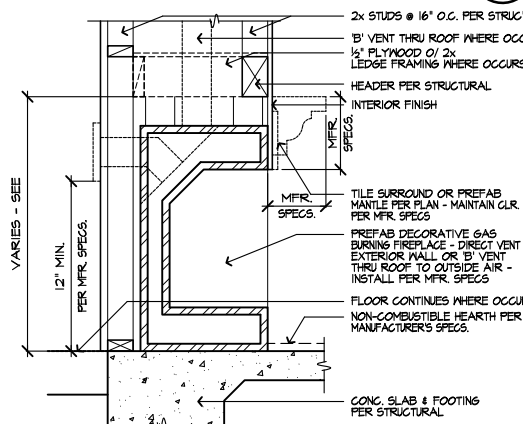

DECORATIVE GAS APPLIANCE
SCALE 1"=1'-0"
SE-04080a

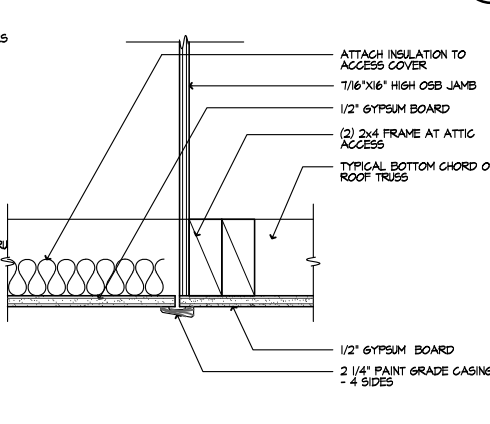

ATTIC ACCESS
SCALE 3"=1'-0"
SE-04076a

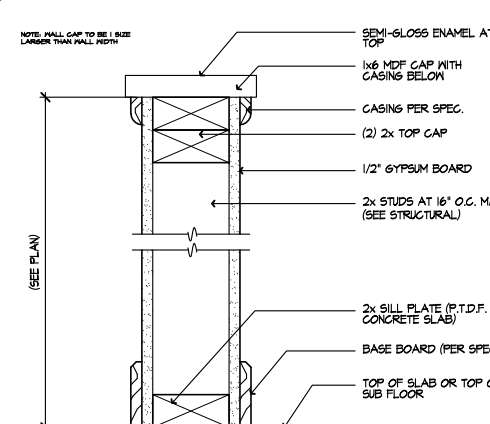

PONY WALL
SCALE 3"=1'-0"
SE-04072a

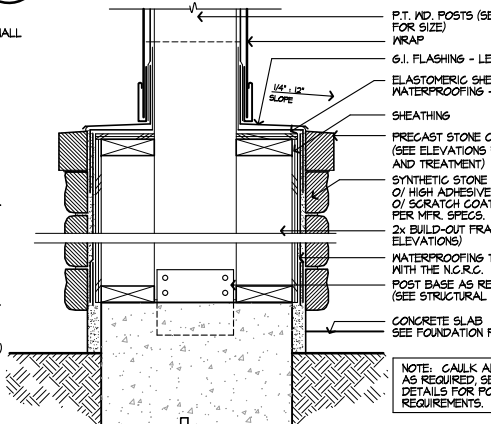

COLUMN BASE W/ STONE
SCALE 1 1/2"=1'-0"
SE-04068a

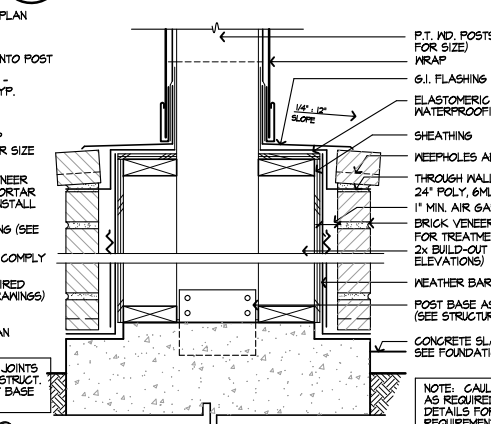

COLUMN BASE W/ BRICK
SCALE 1 1/2"=1'-0"
SE-04064a

These designs and drawings are CONFIDENTIAL, and the exclusive property of KB Home Corporation, and are not to be disclosed without the express permission of KB Home Corporation. Copyright 2014 © KB Home Corporation, all rights reserved.



DETAILS

KB HOME
NORTH CAROLINA DIVISION
4518 S. MIAMI BLVD.
SUITE 180
DURHAM, NC 27703
TEL: (919) 768-7988
FAX: (919) 472-0582

EAVE @ METAL ROOF

SCALE 1/2"=1'-0" SE-05041a

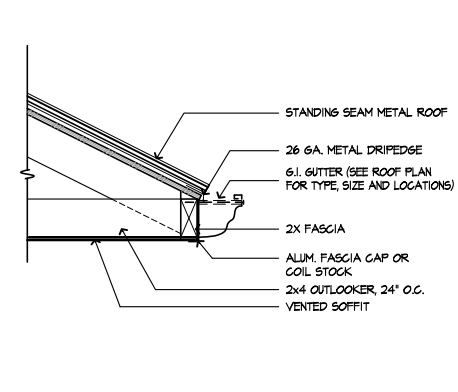

GARAGE DOOR HEAD - STONE

SCALE 1/2"=1'-0" SE-05043a

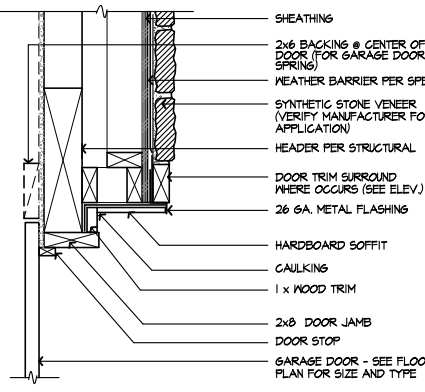

TYP. SHAFT AT 2nd FLR.

SCALE 1"=1'-0" SE-05042a

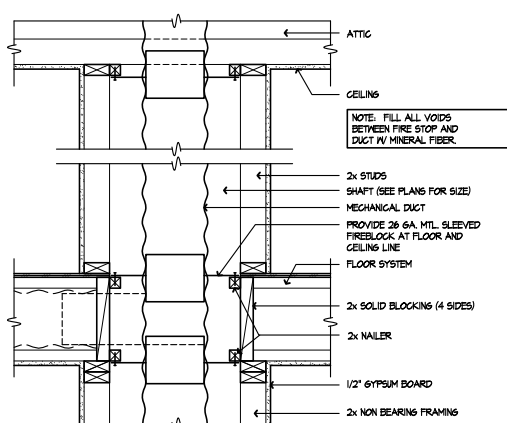

GUARDRAIL

SCALE 3/4"=1'-0" SE-05086a

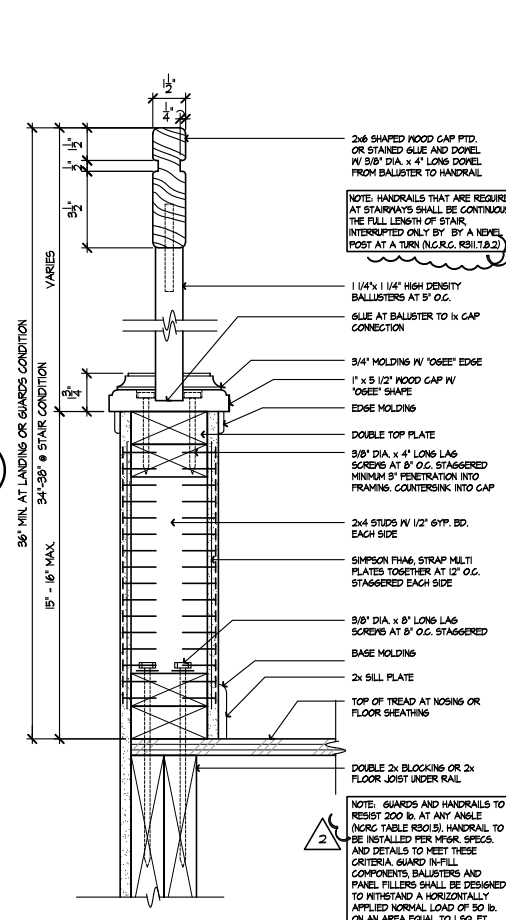

STAIR AT LANDING

SCALE 1/2"=1'-0" SE-05081a

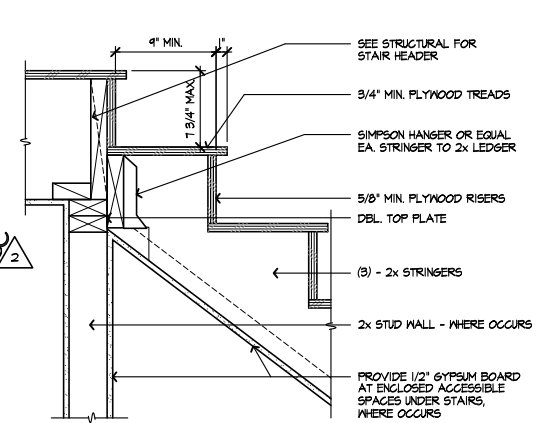

RAKE @ METAL ROOF

SCALE 1/2"=1'-0" SE-05044a

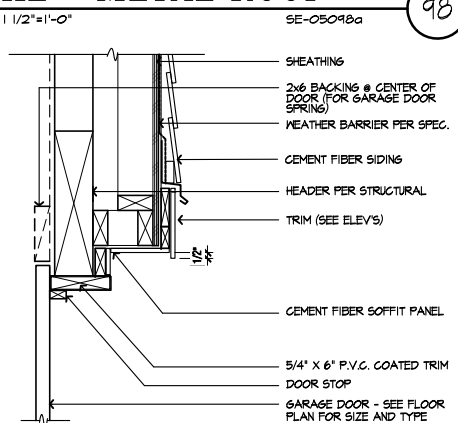

GARAGE DOOR JAMB - STONE

SCALE 1/2"=1'-0" SE-05044a

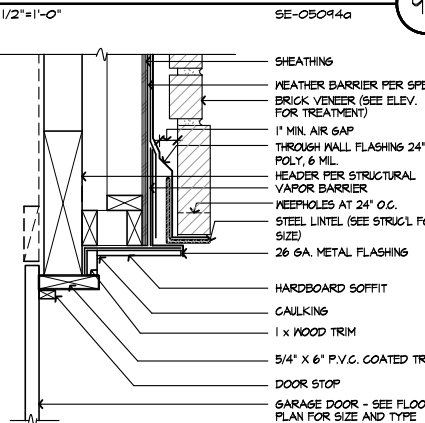

TYP. SHAFT AT 2nd FLR.

SCALE 1"=1'-0" SE-05042a

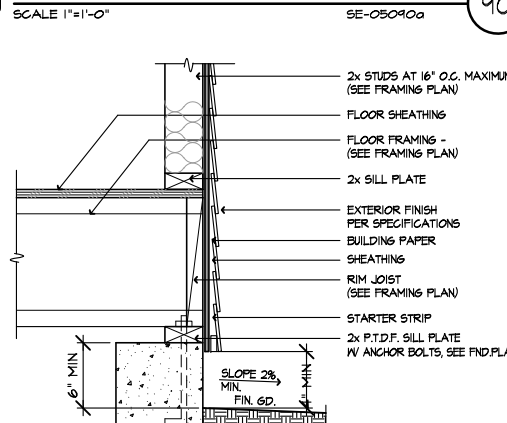

STAIR AT CONC. FLOOR

SCALE 1/2"=1'-0" SE-05082a

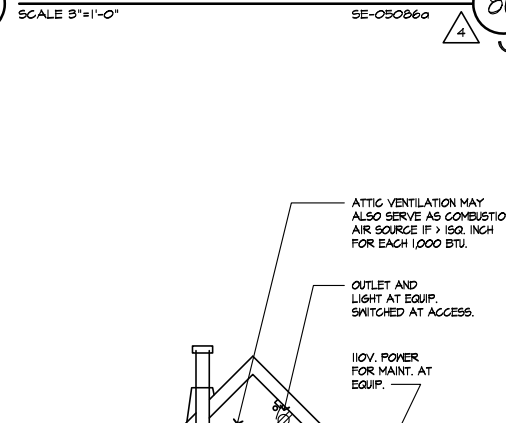

HANDRAIL AT WALL

SCALE 3/4"=1'-0" SE-05083a

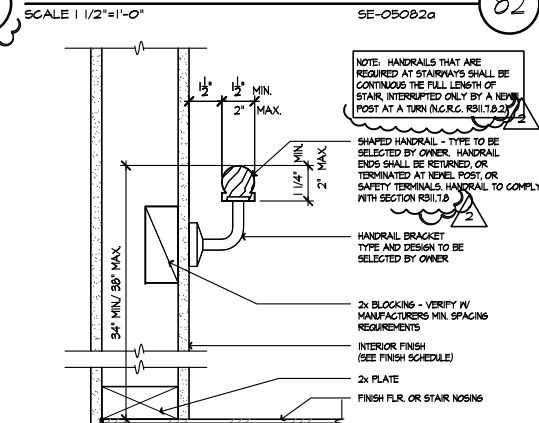

GARAGE DOOR HEAD - BRICK

SCALE 1/2"=1'-0" SE-05045a

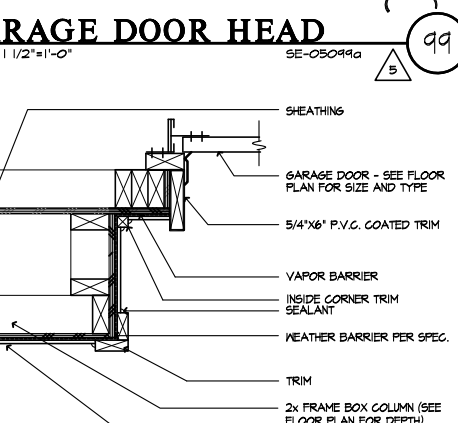

GARAGE DOOR JAMB - BRICK

SCALE 1/2"=1'-0" SE-05045a

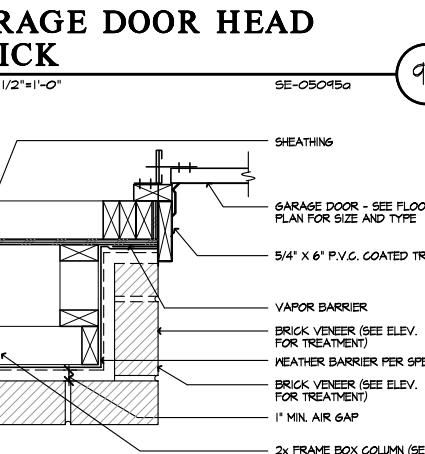

TRAY CEILING

SCALE 1"=1'-0" AD5-41B

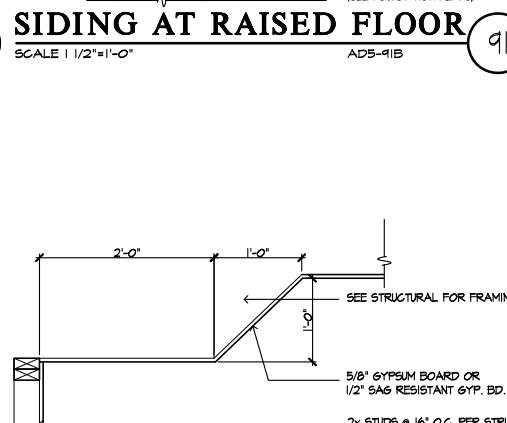

F.A.U. IN ATTIC

SCALE 3/4"=1'-0" SE-05088a

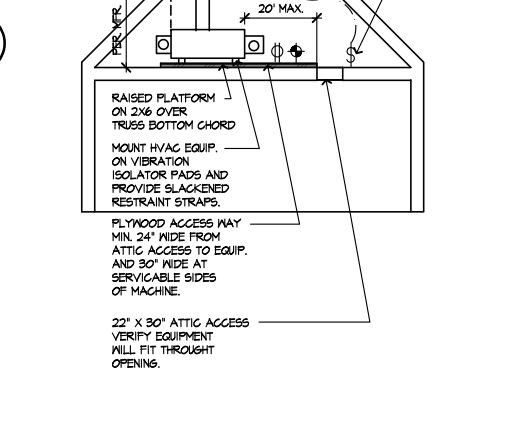

GUARDWALL

SCALE 3/4"=1'-0" SE-05084a

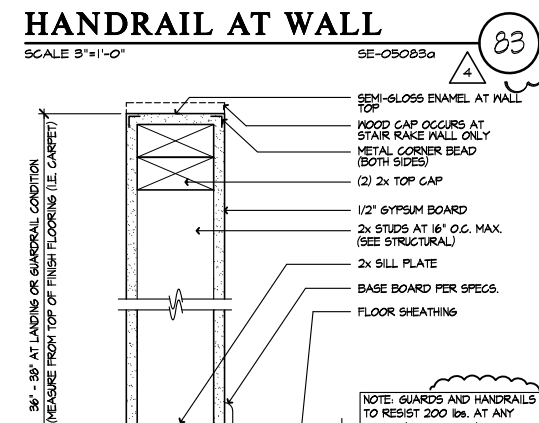

GARAGE DOOR JAMB - BRICK

SCALE 1/2"=1'-0" SE-05100a

TRAY CEILING

SCALE 1"=1'-0" SE-05092a



F.A.U. IN ATTIC

SCALE 3/4"=1'-0" SE-05088a

GUARDWALL

SCALE 3/4"=1'-0" SE-05084a

ISSUE DATE: 09/28/11
PROJECT No.: 1350
DIVISION MGR.: M.C.P.
REVISIONS: 01/15/20

- 1 COMPLIANCE REVIEW NC12006 - 02/28/12 - CTD
- 2 2012 NC CODE UPDATE NC12016 - 03/22/12 - CTD
- 3 DETAIL UPDATES NC15933 - 11/13/13 - DCS
- 4 2018 NC CODE UPDATE NC19013 - 01/24/19 - MCF
- 5 DETAIL UPDATE NC20001MCF - 01/15/20 - MCF

FOR INTERNAL USE ONLY	
REVISION	DATE
1	
2	
3	
4	
5	

PLAN: ALL
SHEET: AD5

These designs and drawings are CONFIDENTIAL, and the exclusive property of KB Home Corporation and are not to be disclosed without the express permission of KB Home Corporation. Copyright 2014 © KB Home Corporation. All rights reserved.

GARAGE DOOR HEAD - SIDING

SCALE 1/2"=1'-0" SE-06117a

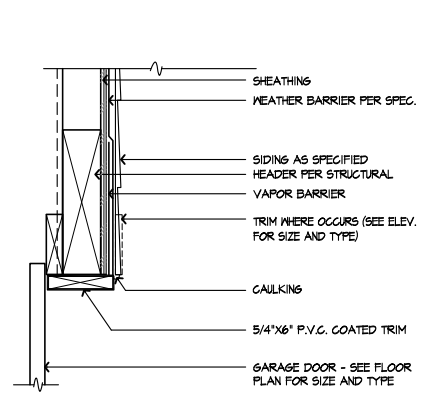

DOOR HEAD - SIDING

SCALE 3/4"=1'-0" SE-06118a

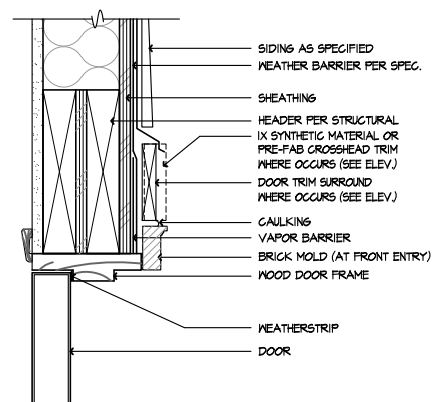

WINDOW HEAD - SIDING

SCALE 3/4"=1'-0" SE-06119a

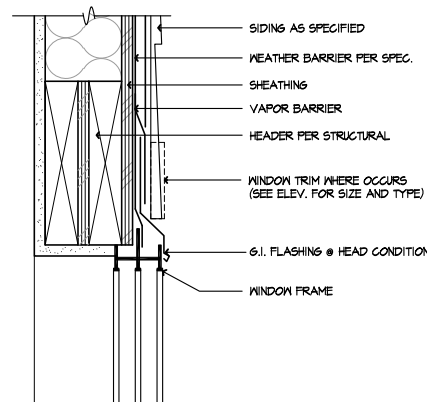

HEEL TRUSS - SIDING

SCALE 1/2"=1'-0" SE-06109a

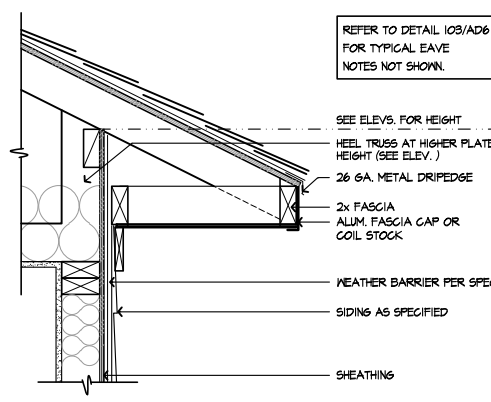

ROOF TO WALL

SCALE 3/4"=1'-0" SE-06101a

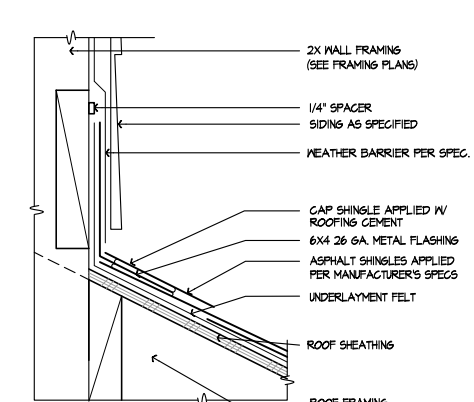

GARAGE DOOR JAMB - SIDING

SCALE 3/4"=1'-0" SE-06118a

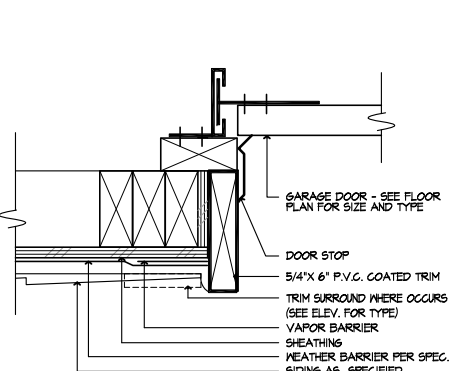

DOOR JAMB - SIDING

SCALE 3/4"=1'-0" SE-06118a

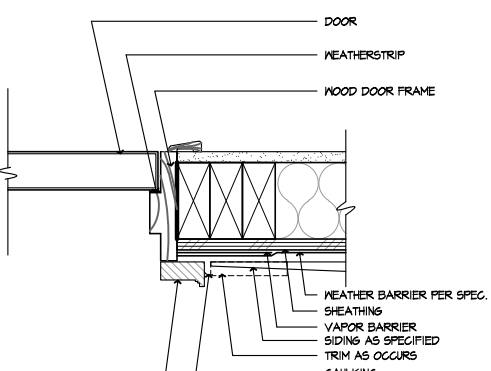

WINDOW SILL - SIDING

SCALE 3/4"=1'-0" SE-06110a

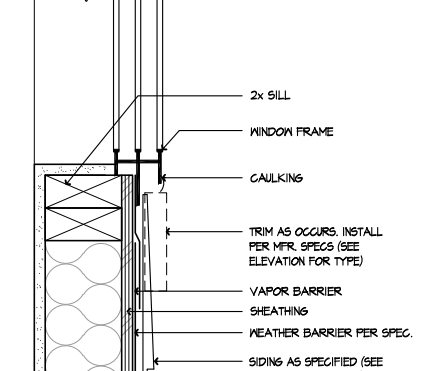

SOFFIT @ PORCH

SCALE 1/2"=1'-0" SE-06106a

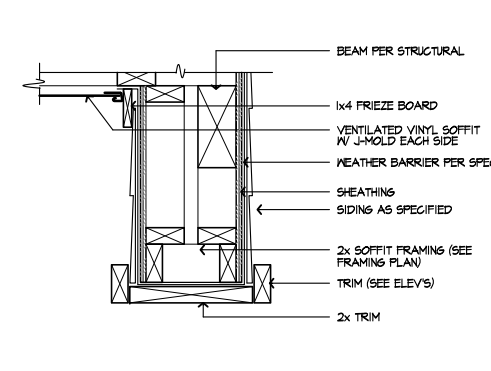

ROOF TO WALL

SCALE 3/4"=1'-0" SE-06102a

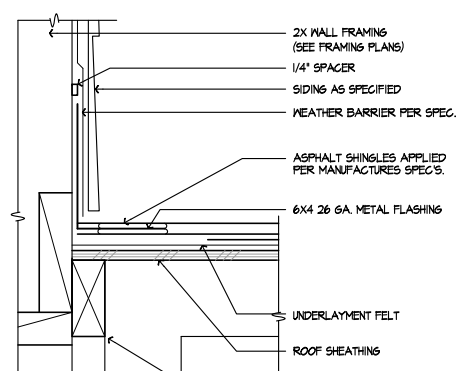

CORNER TRIM - SIDING

SCALE 3/4"=1'-0" SE-06119a

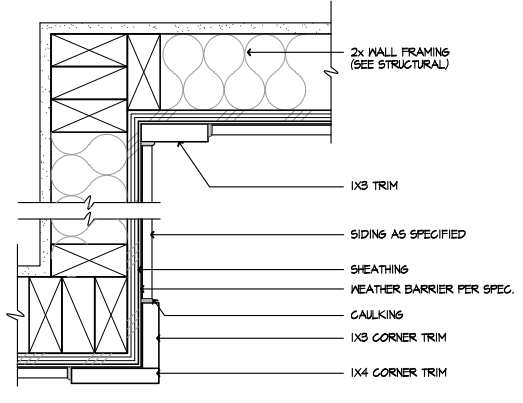

SLDG. DOOR HEAD - SIDING

SCALE 3/4"=1'-0" SE-06118a

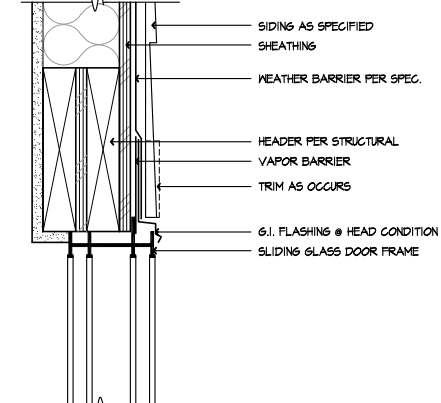

WINDOW JAMB - SIDING

SCALE 3/4"=1'-0" SE-06111a

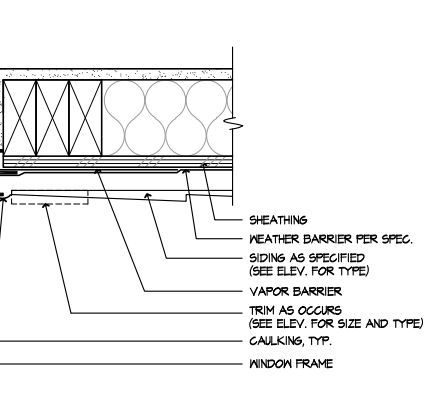

SIDING TO STONE

SCALE 3/4"=1'-0" SE-06107a

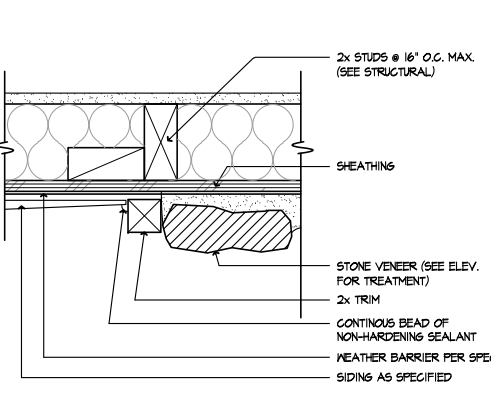

EAVE

SCALE 1/2"=1'-0" SE-010091b

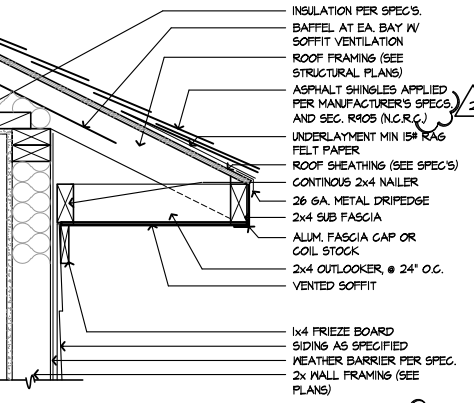

SIDING AT SLAB

SCALE 3/4"=1'-0" SE-06120a

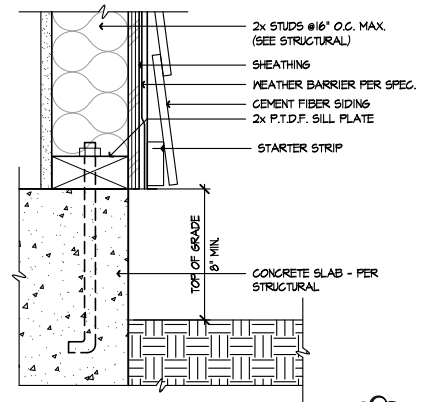

SLDG. DOOR JAMB - SIDING

SCALE 3/4"=1'-0" SE-06118a

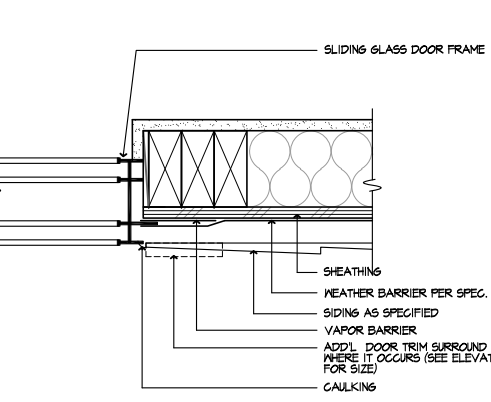

VERT. WDW. MULL. - SIDING

SCALE 3/4"=1'-0" SE-06112a

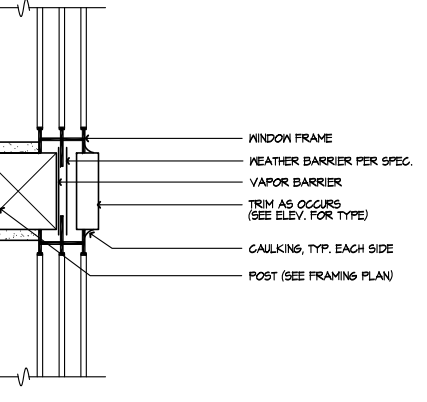

SIDING TO BRICK

SCALE 3/4"=1'-0" SE-06108a

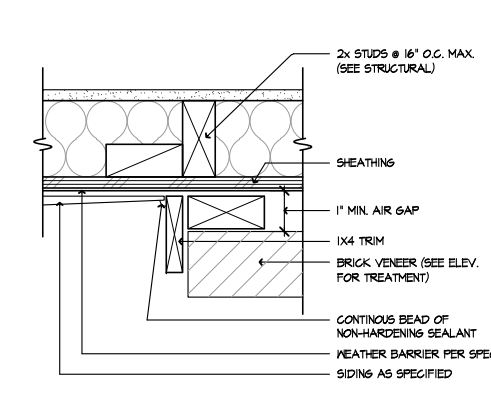

RAKE

SCALE 1/2"=1'-0" SE-06104a

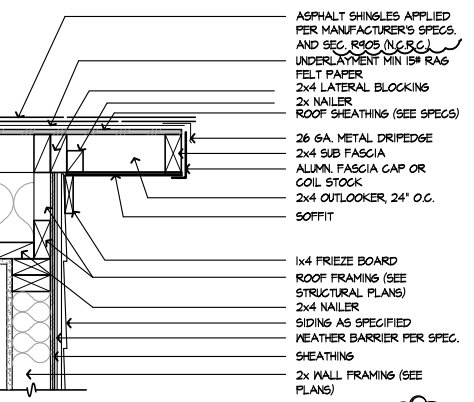

DETAILS

KB HOME
NORTH CAROLINA DIVISION
4518 S. MIAMI BLVD.
SUITE 180
DURHAM, NC 27703
TEL: (919) 768-7988
FAX: (919) 472-0582

ISSUE DATE: 09/28/11
PROJECT No.: 1350
DIVISION MGR.: M.C.P.
REVISIONS: 01/15/20

- 1 COMPLIANCE REVIEW
NC12008 - 02/28/12 - CTD
- 2 2012 NC CODE UPDATE
NC12016 - 03/22/12 - CTD
- 3 DETAIL UPDATES
NC15933 - 11/13 - DCS
- 4 2018 NC CODE UPDATE
NC19015 - 01/24/19 - MCP
- 5 DETAIL UPDATE
NC20001NCF - 01/15/20 - MCP

FOR INTERNAL USE ONLY

REVISED BY:	DATE
1	
2	
3	
4	
5	
6	

PLAN: ALL
SHEET: AD6

These designs and drawings are CONFIDENTIAL, and the exclusive property of KB Home Corporation and are not to be disclosed without the express permission of KB Home Corporation. Copyright 2014 © KB Home Corporation. All rights reserved.

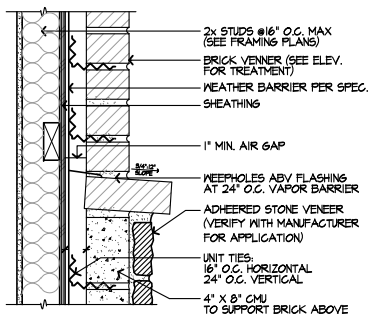

BRICK OVER STONE
NOT TO SCALE

139
AD7

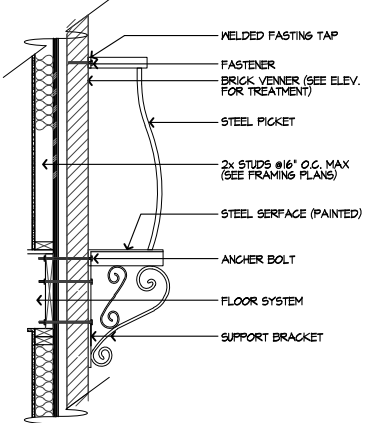

RAILING
NOT TO SCALE

130
AD7

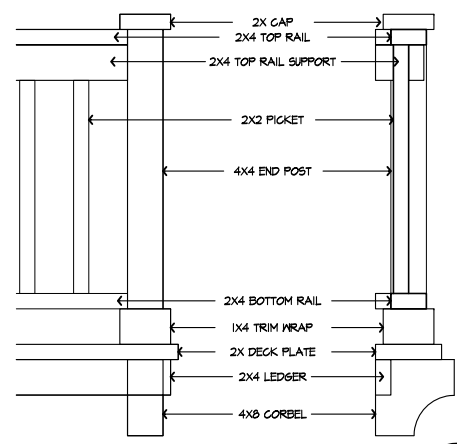

WOOD RAILING
NOT TO SCALE

131
AD7

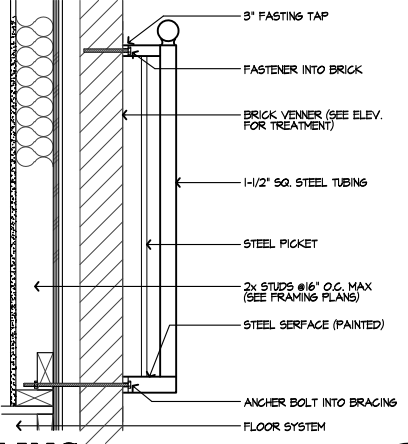

RAILING
NOT TO SCALE

132
AD7

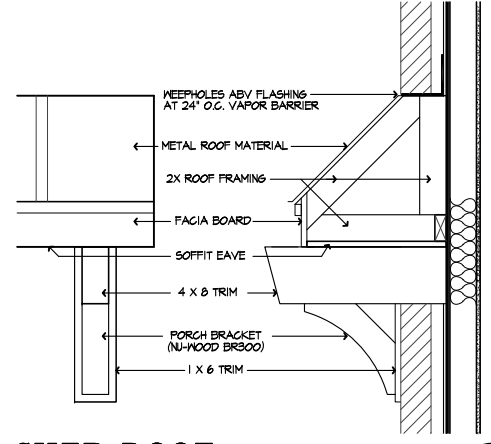

SHED ROOF
NOT TO SCALE

133
AD7

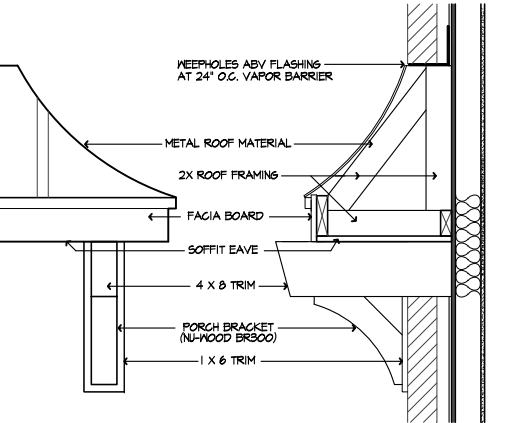

CURVED SHED ROOF
NOT TO SCALE

134
AD7

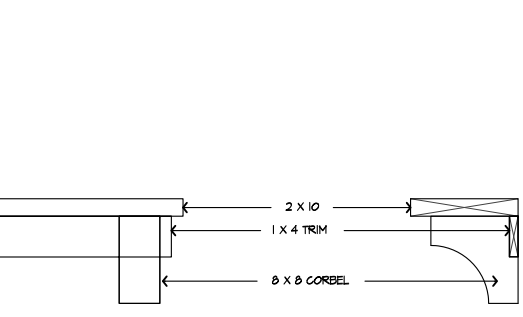

WINDOW LEDGE
NOT TO SCALE

136
AD7

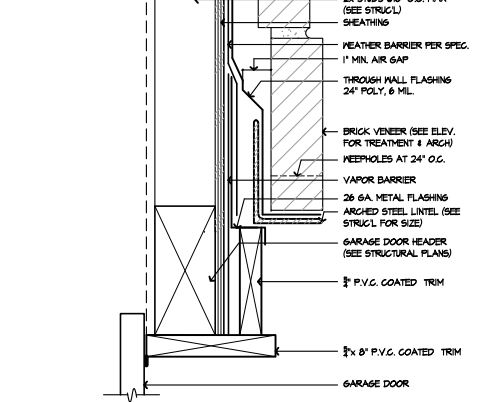

GARAGE DOOR HEAD W/ ARCHED BRICK
NOT TO SCALE

138
AD7

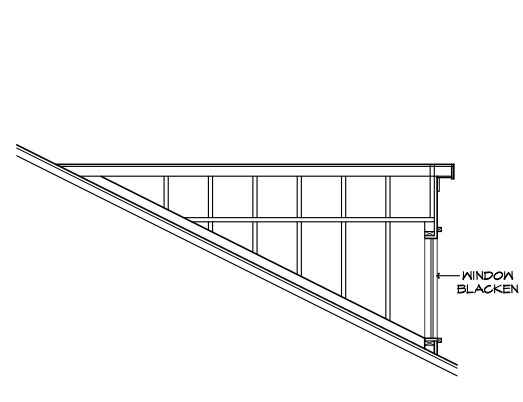

TYP. DORMER
NOT TO SCALE

137
AD7

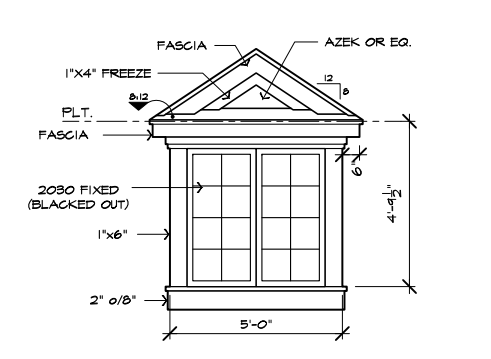

EYEBROW DORMER
NOT TO SCALE

139
AD7

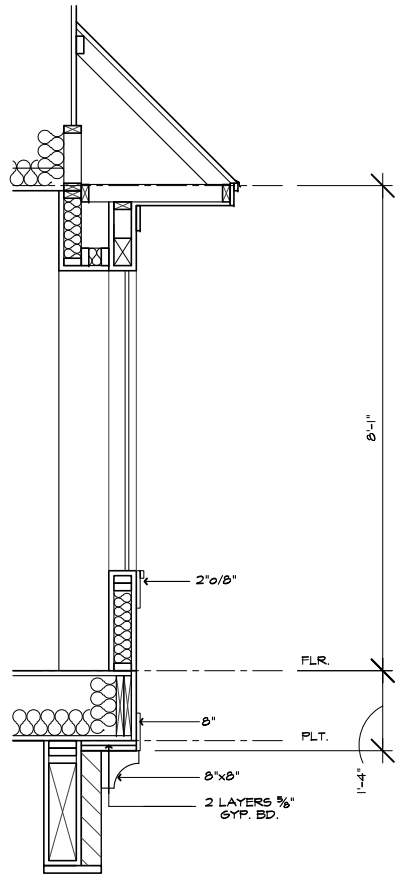

BAY
NOT TO SCALE

135
AD7

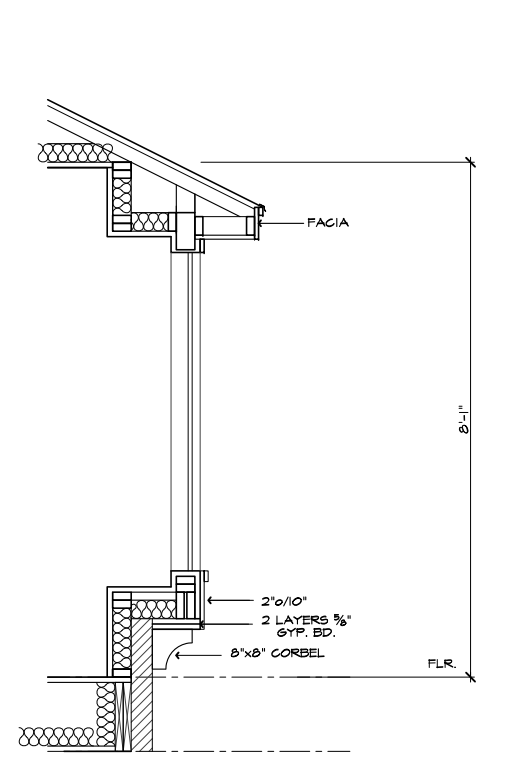

BAY (2)
NOT TO SCALE

144
AD7

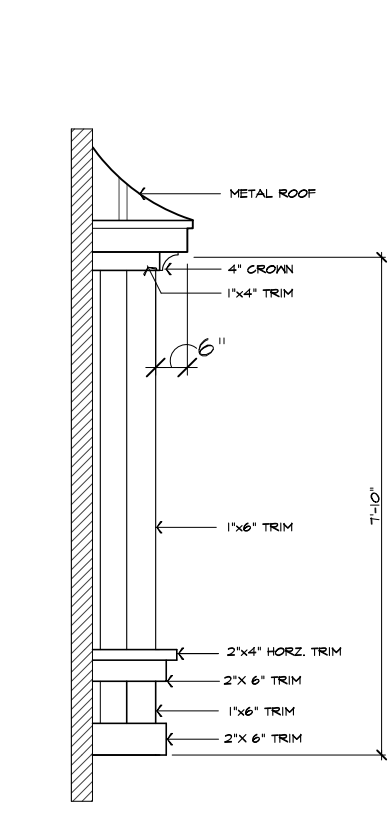

BAY (2)
NOT TO SCALE

145
AD7

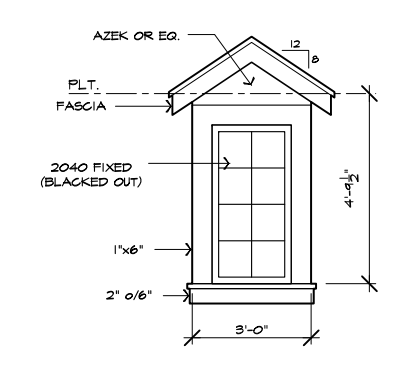

GABLE ROOF DORMER
NOT TO SCALE

140
AD7

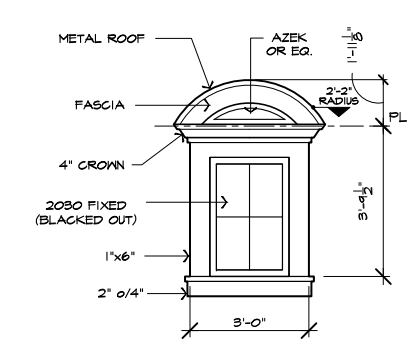

ARCHED ROOF DORMER
NOT TO SCALE

142
AD7

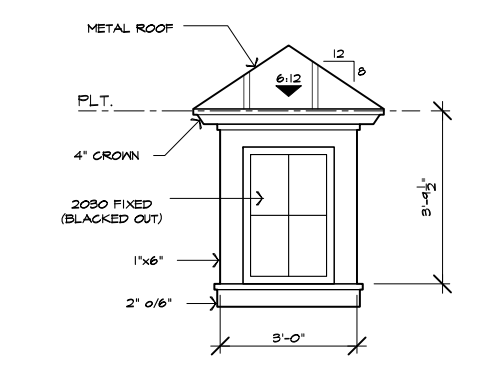

TYP. HIP DORMER
NOT TO SCALE

141
AD7

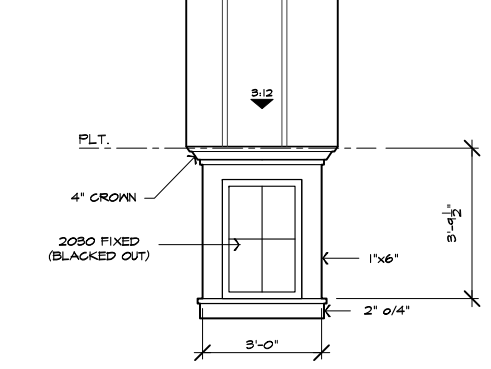

TYP. SHED ROOF DORMER
NOT TO SCALE

143
AD7

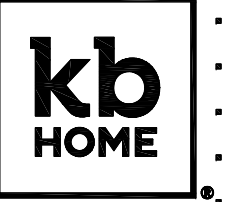

DETAILS

KB HOME
NORTH CAROLINA DIVISION
4518 S. MIAMI BLVD.
SUITE 180
DURHAM, NC 27703
TEL: (919) 768-7988
FAX: (919) 472-0582

ISSUE DATE: 09/28/11
PROJECT No.: 1350
DIVISION MGR.: M.C.P.
REVISIONS: 01/15/20

- 1 COMPLIANCE REVIEW
NC12808 - 02/28/12 - CTD
- 2 2012 NC CODE UPDATE
NC12816 - 03/22/12 - CTD
- 3 DETAIL UPDATES
NC13053 - 11/13 - DCs
- 4 2018 NC CODE UPDATE
NC13015 - 01/24/19 - MCP
- 5 DETAIL UPDATE
NC13001NCP - 01/15/20 - MCP

FOR INTERNAL USE ONLY	
REVIEWED BY:	
1.	
2.	
3.	
4.	
5.	

PLAN: **ALL**
SHEET: **AD7**

These designs and drawings are CONFIDENTIAL and the exclusive property of KB Home Corporation and are not to be disclosed without the express permission of KB Home Corporation. They may not be used or duplicated without the express permission of KB Home Corporation. Copyright 2014 © KB Home Corporation, all rights reserved.

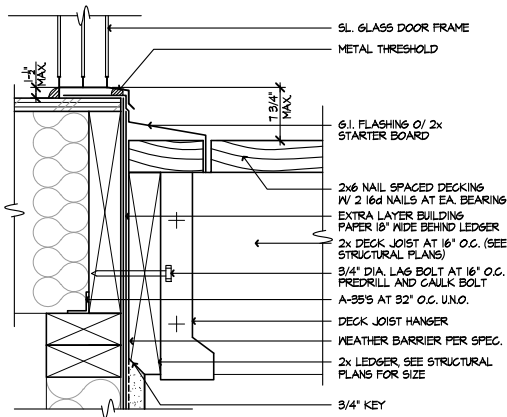

SL. DR. TRESHOLD @ DECK 154
SCALE 3/8"=1'-0"
0910-02 ADB

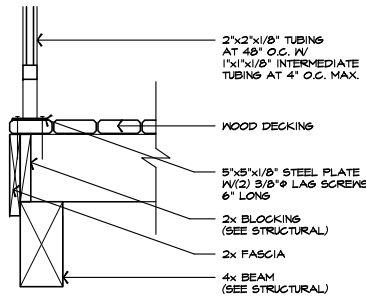

DECK FRAMING 150
SCALE 1/2"=1'-0"
ADB

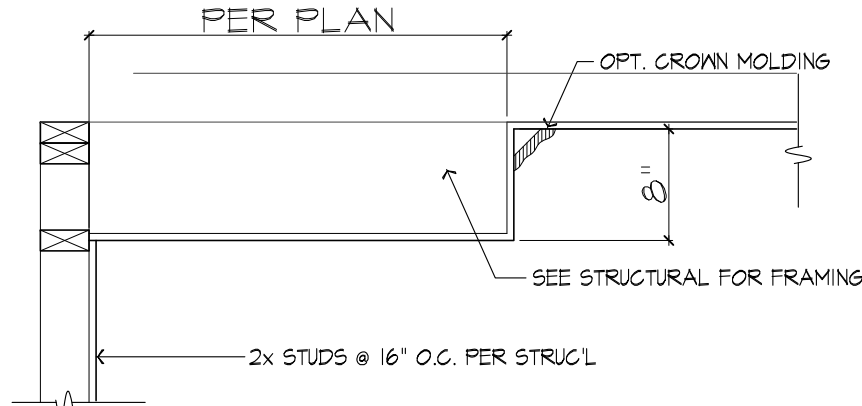

BOX TRAY CEILING 148
NOT TO SCALE
ADB

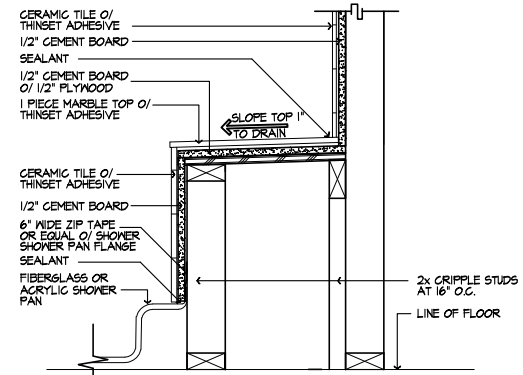

SHOWER PAN SEAT 146
SCALE 1/2"=1'-0"
BA-001A ADB

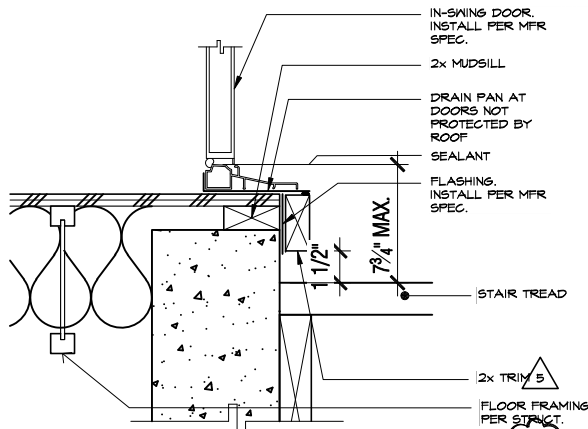

SWING DOOR THRESHOLD 156
SCALE 3/8"=1'-0"
AT CRAWL SPACE ADB

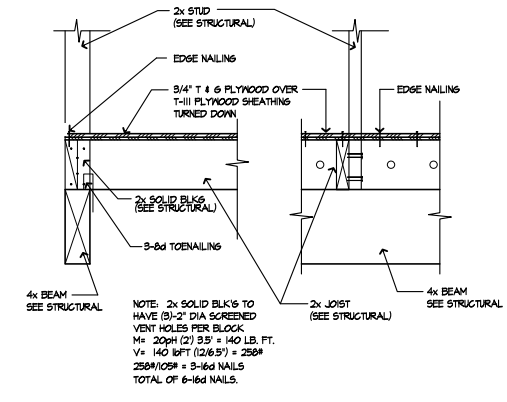

DECK FRAMING 151
SCALE 1/2"=1'-0"
ADB

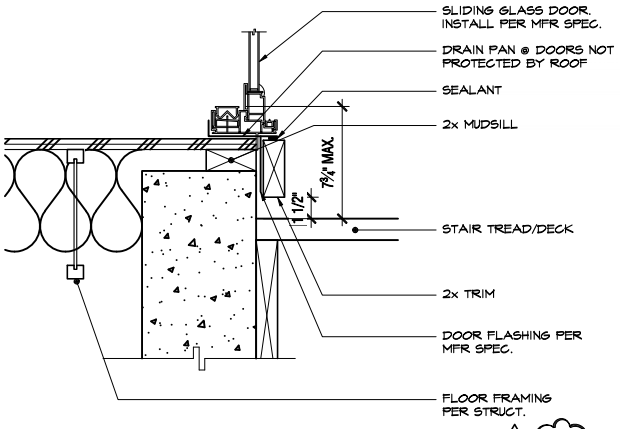

SLIDING GLASS DOOR 157
SCALE 1/2"=1'-0"
AT CRAWL SPACE ADB

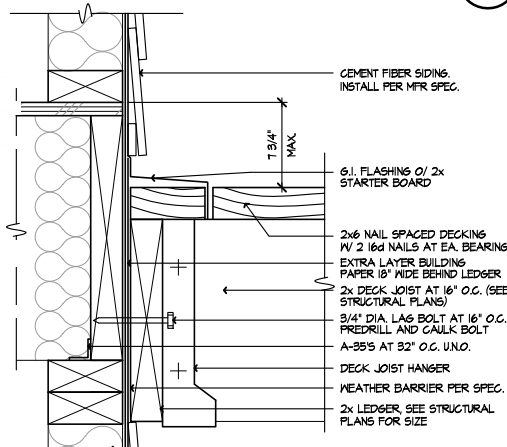

WALL @ DECK 152
SCALE 3/8"=1'-0"
ADB-152 ADB

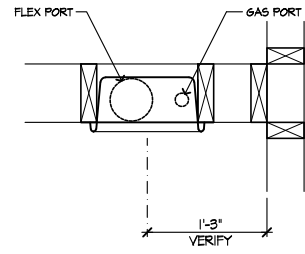

PLAN VIEW

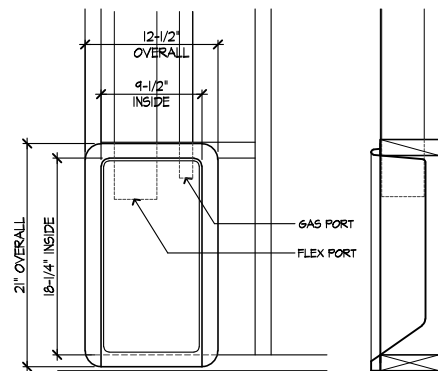

FRONT SIDE

DRYER BOX DETAIL 149
SCALE: N.T.S. ADB-149 ADB

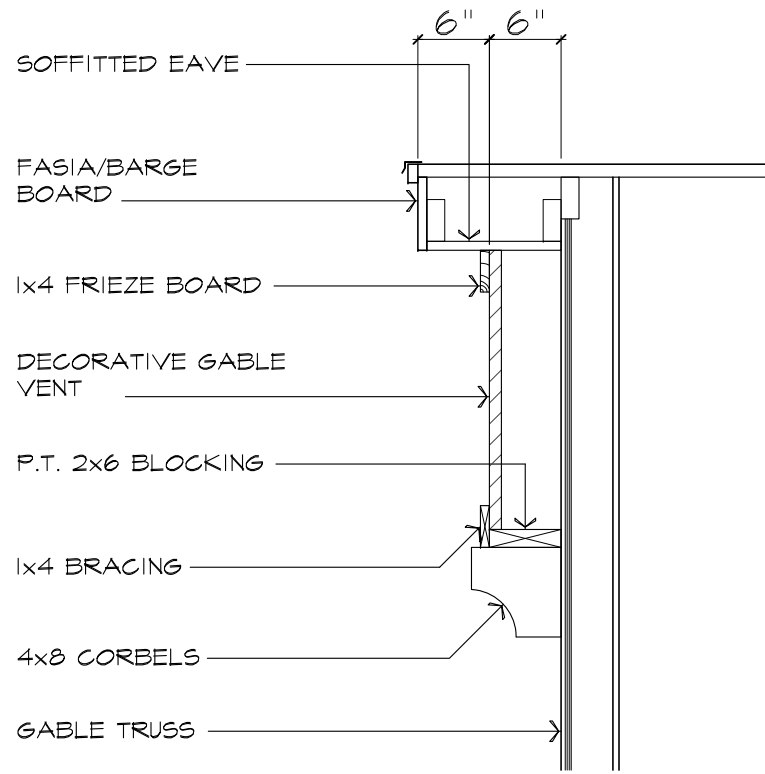

GABLE VENT DETAIL 147
NOT TO SCALE
ADB

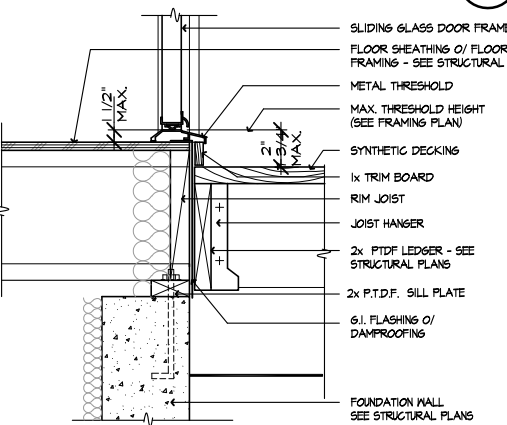

SWING DOOR THRESHOLD 153
SCALE 1/2"=1'-0"
0820-01c ADB

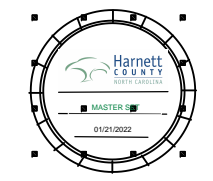

DETAILS

KB HOME
NORTH CAROLINA DIVISION
4518 S. MIAMI BLVD.
SUITE 180
DURHAM, NC 27703
TEL: (919) 768-7988
FAX: (919) 472-0582

- ISSUE DATE: 09/28/11
- PROJECT No.: 1350
- DIVISION MGR.: M.C.P.
- REVISIONS: 01/15/20
- 1 COMPLIANCE REVIEW NCI2008 - 02/28/12 - CTD
- 2 2012 NC CODE UPDATE NCI2016 - 03/22/12 - CTD
- 3 DETAIL UPDATES NCI1903 - 11/3/13 - DC3
- 4 2018 NC CODE UPDATE NCI1915 - 01/24/19 - MCP
- 5 DETAIL UPDATE NC2000INCP - 01/15/20 - MCP

FOR INTERNAL USE ONLY

REVIEWED BY:	DATE:
1.	
2.	
3.	
4.	
5.	
6.	

PLAN: **ALL**
SHEET: **AD8**

These designs and drawings are CONFIDENTIAL, and the exclusive property of KB Home Corporation and are not to be disclosed without the express permission of KB Home Corporation. Copyright 2014 © KB Home Corporation, all rights reserved.

NOTE: ALL CHAPTERS, SECTIONS, TABLES, AND FIGURES CITED WITHOUT A PUBLICATION TITLE ARE FROM THE APPLICABLE RESIDENTIAL CODE (SEE TITLE SHEET).

GENERAL

- IT IS THE CONTRACTOR'S RESPONSIBILITY TO VERIFY ALL DIMENSIONS PRIOR TO CONSTRUCTION. FURTHERMORE, CONTRACTOR IS ULTIMATELY RESPONSIBLE FOR CONSTRUCTION MEANS, METHODS, AND SAFETY ON SITE. NOTIFY JDS CONSULTING, PLLC IMMEDIATELY IF DISCREPANCIES ON PLAN EXIST.
- BRACED-WALL DESIGN IS BASED ON SECTION R602.10 - WALL BRACING. PRIMARY PRESCRIPTIVE METHOD TO BE CS-WSP. SEE WALL BRACING PLANS AND DETAILS FOR ADDITIONAL INFORMATION.

ALL NON-PRESCRIPTIVE SOLUTIONS ARE BASED ON GUIDELINES ESTABLISHED IN THE AMERICAN SOCIETY OF CIVIL ENGINEERS PUBLICATION ASCE 7 AND THE NATIONAL DESIGN SPECIFICATION FOR WOOD CONSTRUCTION - SPECIAL DESIGN PROVISIONS FOR WIND AND SEISMIC.

- SEISMIC DESIGN SHALL BE PER SECTION R301.2.2 - SEISMIC PROVISIONS, INCLUDING ASSOCIATED TABLES AND FIGURES, BASED ON LOCAL SEISMIC DESIGN CATEGORY.

DESIGN LOADS

ASSUMED SOIL BEARING-CAPACITY	2,000 PSF
LIVE LOAD	
ULTIMATE DESIGN WIND SPEED	115 MPH, EXPOSURE B
GROUND SNOW	15 PSF
ROOF	20 PSF
RESIDENTIAL CODE TABLE R301.5 LIVE LOAD (PSF)	
DWELLING UNITS	40
SLEEPING ROOMS	30
ATTICS WITH STORAGE	20
ATTICS WITHOUT STORAGE	10
STAIRS	40
DECKS	40
EXTERIOR BALCONIES	60
PASSENGER VEHICLE GARAGES	50
FIRE ESCAPES	40
GUARDS AND HANDRAILS	200 (pounds, concentrated)

COMPONENT AND CLADDING LOADS, INCLUDING THOSE FOR DOORS AND WINDOWS, SHALL BE DERIVED FROM TABLES R301.2(2) AND R301.2(3) FOR A BUILDING WITH A MEAN ROOF HEIGHT OF 35 FEET, LOCATED IN EXPOSURE B.

ABBREVIATIONS

ABV	ABOVE	KS	KING STUD COLUMN
AFF	ABOVE FINISHED FLOOR	LVL	LAMINATED VENEER LUMBER
ALT	ALTERNATE	MAX	MAXIMUM
BRG	BEARING	MECH	MECHANICAL
BSMT	BASEMENT	MFR	MANUFACTURER
CANT	CANTILEVER	MIN	MINIMUM
CJ	CEILING JOIST	NTS	NOT TO SCALE
CLG	CEILING	OA	OVERALL
CMU	CONCRETE MASONRY UNIT	OC	ON CENTER
CO	CASED OPENING	PT	PRESSURE TREATED
COL	COLUMN	R	RISER
CONC	CONCRETE	REF	REFRIGERATOR
CONT	CONTINUOUS	RFG	ROOFING
D	CLOTHES DRYER	RO	ROUGH OPENING
DBL	DOUBLE	RS	ROOF SUPPORT
DIAM	DIAMETER	SC	STUD COLUMN
DJ	DOUBLE JOIST	SF	SQUARE FOOT (FEET)
DN	DOWN	SH	SHELF / SHELVES
DP	DEEP	SHTG	SHEATHING
DR	DOUBLE RAFTER	SHW	SHOWER
DSP	DOUBLE STUD POCKET	SIM	SIMILAR
EA	EACH	SJ	SINGLE JOIST
EE	EACH END	SP	STUD POCKET
EQ	EQUAL	SPEC'D	SPECIFIED
EX	EXTERIOR	SQ	SQUARE
FAU	FORCED-AIR UNIT	T	TREAD
FDN	FOUNDATION	TEMP	TEMPERED GLASS
FF	FINISHED FLOOR	THK	THICK(NESS)
FLR	FLOOR(ING)	TJ	TRIPLE JOIST
FP	FIREPLACE	TOC	TOP OF CURB / CONCRETE
FTG	FOOTING	TR	TRIPLE RAFTER
HB	HOSE BIBB	TYP	TYPICAL
HDR	HEADER	UNO	UNLESS NOTED OTHERWISE
HGR	HANGER	W	CLOTHES WASHER
JS	JACK STUD COLUMN	WH	WATER HEATER
		WWF	WELDED WIRE FABRIC
		XJ	EXTRA JOIST

MATERIALS

- INTERIOR / TRIMMED FRAMING LUMBER SHALL BE #2 SPRUCE PINE FIR (SPF) WITH THE FOLLOWING DESIGN PROPERTIES (#2 SOUTHERN YELLOW PINE MAY BE SUBSTITUTED):

Fb = 875 PSI Fv = 70 PSI E = 1.4E6 PSI

- FRAMING LUMBER EXPOSED TO WEATHER OR IN CONTACT WITH THE GROUND, CONCRETE, OR MASONRY SHALL BE PRESSURE TREATED #2 SOUTHERN YELLOW PINE (SYP) WITH THE FOLLOWING DESIGN PROPERTIES:

Fb = 975 PSI Fv = 95 PSI E = 1.6E6 PSI

- LVL STRUCTURAL MEMBERS TO BE LAMINATED VENEER LUMBER WITH THE FOLLOWING MINIMUM DESIGN PROPERTIES:

Fb = 2600 PSI Fv = 285 PSI E = 1.9E6 PSI

- PSL STRUCTURAL MEMBERS TO BE PARALLEL STRAND LUMBER WITH THE FOLLOWING MINIMUM DESIGN PROPERTIES:

Fb = 2900 PSI Fv = 290 PSI E = 2.0E6 PSI

- LSL STRUCTURAL MEMBERS TO BE LAMINATED STRAND LUMBER WITH THE FOLLOWING MINIMUM DESIGN PROPERTIES:

Fb = 2250 PSI Fv = 400 PSI E = 1.55E6 PSI

- STRUCTURAL STEEL WIDE-FLANGE BEAMS SHALL CONFORM TO ASTM A992. Fy = 50 KSI

- REBAR SHALL BE DEFORMED STEEL CONFORMING TO ASTM A615, GRADE 60.

- POURED CONCRETE COMPRESSIVE STRENGTH TO BE A MINIMUM 3,000 PSI AT 28 DAYS. MATERIALS USED TO PRODUCE CONCRETE SHALL COMPLY WITH THE APPLICABLE STANDARDS LISTED IN AMERICAN CONCRETE INSTITUTE STANDARD ACI 318 OR ASTM C1157.

- CONCRETE SUBJECT TO MODERATE OR SEVERE WEATHERING PROBABILITY PER TABLE R301.2(1) SHALL BE AIR-ENTRAINED WHEN REQUIRED BY TABLE R402.2.

- CONCRETE MASONRY UNITS (CMU) SHALL CONFORM TO AMERICAN CONCRETE INSTITUTE PUBLICATION 530: BUILDING CODE REQUIREMENTS AND SPECIFICATIONS FOR MASONRY STRUCTURES AND COMPANION COMMENTARIES AND THE MASONRY SOCIETY PUBLICATION TMS 402/602: BUILDING CODE REQUIREMENTS AND SPECIFICATIONS FOR MASONRY STRUCTURES.

- MORTAR SHALL COMPLY WITH ASTM INTERNATIONAL STANDARD C270.

- INDICATED MODEL NUMBERS FOR ALL METAL HANGERS, STRAPS, FRAMING CONNECTORS, AND HOLD-DOWNS ARE SIMPSON STRONG-TIE BRAND. EQUIVALENT USP BRAND PRODUCTS ARE ACCEPTABLE.

- REFER TO I-JOIST EQUIVALENCE CHART ON I-JOIST DETAIL SHEET FOR SUBSTITUTION OF MANUFACTURER SERIES.

FOUNDATION

- MINIMUM ALLOWABLE SOIL BEARING CAPACITY IS ASSUMED TO BE 2,000 PSF. IT IS THE CONTRACTOR'S RESPONSIBILITY TO VERIFY SOIL BEARING CAPACITY IF UNSATISFACTORY CONDITIONS EXIST.

- CONCRETE FOUNDATION WALLS TO BE SELECTED AND CONSTRUCTED PER SECTION R404 OR AMERICAN CONCRETE INSTITUTE STANDARD ACI 318.

- MASONRY FOUNDATION WALLS TO BE SELECTED AND CONSTRUCTED PER SECTION R404 AND/OR AMERICAN CONCRETE INSTITUTE PUBLICATION 530: BUILDING CODE REQUIREMENTS AND SPECIFICATIONS FOR MASONRY STRUCTURES AND COMPANION COMMENTARIES AND/OR THE MASONRY SOCIETY PUBLICATION TMS 402/602: BUILDING CODE REQUIREMENTS AND SPECIFICATIONS FOR MASONRY STRUCTURES.

- CONCRETE WALL HORIZONTAL REINFORCEMENT TO BE PER TABLE R404.1.2(1) OR AS NOTED OR DETAILED. CONCRETE WALL VERTICAL REINFORCEMENT TO BE PER TABLES R404.1.2(3 AND 4) OR AS NOTED OR DETAILED. ALL CONCRETE WALLS SHALL COMPLY WITH APPLICABLE PROVISIONS OF CHAPTER 6.

- TABLES ASSUME THAT WALLS HAVE PERMANENT LATERAL SUPPORT AT THE TOP AND BOTTOM.
- FOUNDATION DRAINS ARE ASSUMED AT ALL WALLS PER SECTION R405.

- PLAIN-MASONRY WALL DESIGN TO BE PER TABLE R404.1.1(1) OR AS NOTED OR DETAILED. MASONRY WALLS WITH VERTICAL REINFORCEMENT TO BE PER TABLES R404.1.1 (2 THROUGH 4) OR AS NOTED OR DETAILED. ALL MASONRY WALLS SHALL COMPLY WITH APPLICABLE PROVISIONS OF CHAPTER 6.

- TABLES ASSUME THAT WALLS HAVE PERMANENT LATERAL SUPPORT AT THE TOP AND BOTTOM.
- WALL REINFORCING SHALL BE PLACED ACCORDING TO FOOTNOTE (c) OF THE TABLES (REINFORCING IS NOT CENTERED IN WALL).
- FOUNDATION DRAINS ARE ASSUMED AT ALL WALLS PER SECTION R405.

- WOOD SILL PLATES TO BE ANCHORED TO THE FOUNDATION WITH 1/2" DIAMETER ANCHOR BOLTS WITH MINIMUM 7" EMBEDMENT, SPACED A MAXIMUM OF 6'-0" OC AND WITHIN 12" FROM THE ENDS OF EACH PLATE SECTION. INSTALL MINIMUM (2) ANCHOR BOLTS PER SECTION. SEE SECTION R403.1.6 FOR SPECIFIC CONDITIONS.

- THE UNSUPPORTED HEIGHT OF SOLID MASONRY PIERS SHALL NOT EXCEED TEN TIMES THEIR LEAST DIMENSION. UNFILLED, HOLLOW PIERS MAY BE USED IF THE UNSUPPORTED HEIGHT IS NOT MORE THAN FOUR TIMES THEIR LEAST DIMENSION.

- CENTERS OF PIERS TO BEAR IN THE MIDDLE THIRD OF THE FOOTINGS, AND GIRDERS SHALL CENTER IN THE MIDDLE THIRD OF THE PIERS.

- ALL FOOTINGS TO HAVE MINIMUM 2" PROJECTION ON EACH SIDE OF FOUNDATION WALLS (SEE DETAILS).

- ALL REBAR NOTED IN CONCRETE TO HAVE AT LEAST 2" COVER FROM EDGE OF CONCRETE TO EDGE OF REBAR.

- FRAMING TO BE FLUSH WITH FOUNDATION WALLS.

- WITH CLASS 1 SOILS, VAPOR BARRIER AND CRUSHED STONE MAY BE OMITTED.

FRAMING

- ALL BEARING HEADERS TO BE (2) 2x6 SUPPORTED W/ MIN (1) JACK STUD AND (1) KING STUD EACH END, UNO.

- ALL NON-BEARING HEADERS TO BE (2) 2x4, UNO.

- NON-BEARING INTERIOR WALLS NOT MORE THAN 10' NOMINAL HEIGHT AND NOT SHOWN AS BRACED WALLS MAY BE FRAMED WITH 2x4 STUDS @ 24" OC.

- SOLID BLOCKING TO BE PROVIDED AT ALL POINT LOADS THROUGH FLOOR LEVELS TO THE FOUNDATION OR TO OTHER STRUCTURAL COMPONENTS.

- ALL BEAMS SPECIFIED ARE MINIMUM SIZES ONLY. LARGER MEMBERS MAY SUBSTITUTED AS NEEDED FOR EASE OF CONSTRUCTION.

- ALL EXTERIOR WALLS TO BE FULLY SHEATHED WITH 7/16" OSB.

- PORCH / PATIO COLUMNS TO BE 4x4 MINIMUM PRESSURE-TREATED LUMBER.

- ATTACH PORCH COLUMNS TO SLAB / FDN WALL USING ABA, ABU, ABW, OR CPT SIMPSON POST BASES TO FIT COLUMN SIZES NOTED ON PLAN -OR- ANY OTHER COLUMN CONNECTION WITH 500# UPLIFT CAPACITY.
- ATTACH PORCH COLUMNS TO PORCH BEAMS USING AC OR BC SIMPSON POST CAPS TO FIT COLUMN SIZES NOTED ON PLAN -OR- ANY OTHER COLUMN CONNECTION WITH 500# UPLIFT CAPACITY.
- TRIM OUT COLUMN(S) AND BEAM(S) PER BUILDER AND DETAILS.

- ALL ENGINEERED WOOD PRODUCTS (LVL, PSL, LSL, ETC.) SHALL BE INSTALLED WITH CONNECTIONS PER MANUFACTURER SPECIFICATIONS.

- ENGINEERED WOOD FLOOR SYSTEMS AND ROOF TRUSS SYSTEMS:
 - SHOP DRAWINGS FOR THE SYSTEMS SHALL BE PROVIDED TO THE ENGINEER OF RECORD FOR REVIEW AND COORDINATION BEFORE CONSTRUCTION.
 - TRUSS PROFILES SHALL BE SEALED BY THE TRUSS MANUFACTURER.
 - INSTALLATION OF THE SYSTEMS SHALL BE PER MANUFACTURER'S INSTRUCTIONS.
 - TRUSS LAYOUT AND PLACEMENT BY MANUFACTURER TO COINCIDE WITH THE SUPPORT LOCATIONS SHOWN IN THESE DRAWINGS.

- ALL BEAMS TO BE CONTINUOUSLY SUPPORTED Laterally AND SHALL BEAR FULL WIDTH ON THE SUPPORTING WALLS OR COLUMNS INDICATED, WITH A MINIMUM OF THREE STUDS, UNO.

- ALL STEEL BEAMS TO BE SUPPORTED AT EACH END WITH A MIN BEARING LENGTH OF 3 1/2" AND FULL FLANGE WIDTH. BEAMS MUST BE ATTACHED AT EACH END WITH A MINIMUM OF FOUR 16d NAILS OR TWO 1/2" x 4" LAG SCREWS, UNO.

- STEEL FLITCH BEAMS TO BE BOLTED TOGETHER USING (2) ROWS OF 1/2" DIAMETER BOLTS (ASTM 307) WITH WASHERS PLACED UNDER THE THREADED END OF THE BOLT. BOLTS TO BE SPACED AT 24" OC (MAX) AND STAGGERED TOP AND BOTTOM OF BEAM (2" EDGE DISTANCE), WITH TWO BOLTS TO BE LOCATED AT 6" FROM EACH END OF FLITCH BEAM.

- WHEN A 4-PLY LVL BEAM IS USED, ATTACH WITH (1) 1/2" DIAMETER BOLT, 12" OC, STAGGERED TOP AND BOTTOM, 1 1/2" MIN FROM ENDS. ALTERNATE EQUIVALENT ATTACHMENT METHOD MAY BE USED, SUCH AS SDS, SDW, OR TRUSSLOK SCREWS (SEE MANUFACTURER SPECIFICATIONS).

- FOR STUD COLUMNS OF 4-OR-MORE STUDS, INSTALL SIMPSON STRONG-TIE CS16 STRAPS ACROSS STUDS @ 30" OC, 6" MAX FROM PLATES, ON INSIDE FACE OF COLUMN (EXTERIOR WALL), ON BOTH FACES OF COLUMN (INTERIOR WALL).

- FLOOR JOISTS ADJACENT AND PARALLEL TO THE EXTERIOR FOUNDATION WALL SHALL BE PROVIDED WITH FULL-DEPTH SOLID BLOCKING, NOT LESS THAN TWO (2) INCHES NOMINAL IN THICKNESS, PLACED PERPENDICULAR TO THE JOIST AT SPACING NOT MORE THAN FOUR (4) FEET. THE BLOCKING SHALL BE NAILED TO THE FLOOR SHEATHING, THE SILL PLATE, THE JOIST, AND THE EXTERIOR RIM JOIST / BOARD.

- BRACED WALL PANELS SHALL BE FASTENED TO MEET THE UPLIFT-RESISTANCE REQUIREMENTS IN CHAPTERS 6 AND 8 OF THE APPLICABLE CODE (SEE TITLE SHEET). REQUIREMENTS OF THE STRUCTURAL DRAWINGS THAT EXCEED THE CODE MINIMUM SHALL BE MET.



KB HOME
NORTH CAROLINA DIVISION
4518 S. MIAMI BLVD.
SUITE 180
DURHAM, NC 27703
TEL: (919) 768-7988
FAX: (919) 472-0582

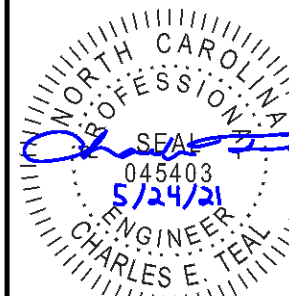

P-0961

JDS Consulting, PLLC HAS PERFORMED A STRUCTURAL REVIEW OF THESE PLANS. THE STRUCTURAL COMPONENTS COMPLY WITH THE 2018 NORTH CAROLINA RESIDENTIAL CODE FOR ONE- AND TWO-FAMILY DWELLINGS FOR NC PLAN REVIEW. DEVIATION OF ANY STRUCTURAL REQUIREMENTS OF THESE PLANS WITHOUT THE APPROVAL OF THE EOR IS PROHIBITED.



8600 D' JERSEY CT, RALEIGH, NC 27617-919-480-1075
INFO@JDSCONSULTING.NET - WWW.JDSCONSULTING.NET

PROJECT NO.: 21901127
DATE: 05/21/2021

PLAN:
238.2338

GENERAL NOTES
GN1.0

These designs and drawings are CONFIDENTIAL, and the exclusive property of KB Home Corporation and are not to be disclosed without the express permission of KB Home Corporation. Copyright 2019 © KB Home Corporation. All rights reserved.

FASTENER SCHEDULE		
CONNECTION	3" x 0.131" NAIL	3" x 0.120" NAIL
JOIST TO SILL PLATE	(4) TOE NAILS	(4) TOE NAILS
SOLE PLATE TO JOIST / BLOCKING	NAILS @ 8" OC (typical) (4) PER 16" SPACE (at braced panels)	NAILS @ 8" OC (typical) (4) PER 16" SPACE (at braced panels)
STUD TO SOLE PLATE	(4) TOE NAILS	(4) TOE NAILS
TOP OR SOLE PLATE TO STUD	(3) FACE NAILS	(4) FACE NAILS
RIM JOIST OR BAND JOIST TO TOP PLATE OR SILL PLATE	TOE NAILS @ 6" OC	TOE NAILS @ 4" OC
BLOCKING BETWEEN JOISTS TO TOP PLATE OR SILL PLATE	(4) TOE NAILS	(4) TOE NAILS
DOUBLE STUD	NAILS @ 8" OC	NAILS @ 8" OC
DOUBLE TOP PLATES	NAILS @ 12" OC	NAILS @ 12" OC
DOUBLE TOP PLATES LAP (24" MIN LAP LENGTH)	(12) NAILS IN LAPPED AREA, EA SIDE OF JOINT	(12) NAILS IN LAPPED AREA, EA SIDE OF JOINT
TOP PLATE LAP AT CORNERS AND INTERSECTING WALLS	(3) FACE NAILS	(3) FACE NAILS
OPEN-WEB TRUSS BOTTOM CHORD TO TOP PLATES OR SILL PLATE (PARALLEL TO WALL)	NAILS @ 6" OC	NAILS @ 4" OC
BOTTOM CHORD OF TRUSS TO TOP PLATES OR SILL PLATE (PERPENDICULAR TO WALL)	(3) TOE NAILS	(3) TOE NAILS

SEE TABLE R602.3(1) FOR ADDITIONAL STRUCTURAL-MEMBER FASTENING REQUIREMENTS.

DETAILS AND NOTES ON DRAWINGS GOVERN.

BALLOON WALL FRAMING SCHEDULE
(USE THESE STANDARDS UNLESS NOTED OTHERWISE ON THE FRAMING PLAN SHEETS)

FRAMING MEMBER SIZE	MAX HEIGHT (PLATE TO PLATE) 115 MPH ULTIMATE DESIGN WIND SPEED
2x4 @ 16" OC	10'-0"
2x4 @ 12" OC	12'-0"
2x6 @ 16" OC	15'-0"
2x6 @ 12" OC	17'-9"
2x8 @ 16" OC	19'-0"
2x8 @ 12" OC	22'-0"
(2) 2x4 @ 16" OC	14'-6"
(2) 2x4 @ 12" OC	17'-0"
(2) 2x6 @ 16" OC	21'-6"
(2) 2x6 @ 12" OC	25'-0"
(2) 2x8 @ 16" OC	27'-0"
(2) 2x8 @ 12" OC	31'-0"

- ALL HEIGHTS ARE MEASURED SUBFLOOR TO TOP OF WALL PLATE.
- WHEN SPLIT-FRAMED WALLS ARE USED FOR HEIGHTS OVER 12', THE CONTRACTOR SHALL ADD 6' MINIMUM OF CS16 COIL STRAPPING (FULLY NAILED), CENTERED OVER THE WALL BREAK.
- FINGER-JOINTED MEMBERS MAY BE USED FOR CONTINUOUS HEIGHTS WHERE TRADITIONALLY MILLED LUMBER LENGTHS ARE LIMITED.
- FOR GREATER WIND SPEED, SEE ENGINEERED SOLUTION FOR CONDITION IN DRAWINGS.

ROOF SYSTEMS

TRUSSED ROOF - STRUCTURAL NOTES

- PROVIDE CONTINUOUS BLOCKING THROUGH STRUCTURE FOR ALL POINT LOADS.
-  DENOTES OVER-FRAMED AREA
- MINIMUM 7/16" OSB ROOF SHEATHING
- TRUSS LAYOUT AND PLACEMENT BY MANUFACTURER TO COINCIDE WITH THE SUPPORT LOCATIONS SHOWN. TRUSS PROFILES SHALL BE SEALED BY THE TRUSS MANUFACTURER. TRUSS PLANS TO BE COORDINATED WITH THE SEALED STRUCTURAL DRAWINGS. INSTALLATION SHALL BE IN ACCORDANCE WITH THE MANUFACTURER'S INSTRUCTIONS.
- MANUFACTURER TO PROVIDE REQUIRED UPLIFT CONNECTION.
- PROVIDE H2.5A (MINIMUM) OR EQUIVALENT AT EACH TRUSS-TO-TOP PLATE CONNECTION AT OVER-FRAMED AREAS, UNLESS NOTED OTHERWISE.
- UPLIFT CONNECTION TO BE CARRIED THROUGH TO FLOOR SYSTEM.

STICK-FRAMED ROOF - STRUCTURAL NOTES

- PROVIDE 2x4 COLLAR TIES AT 48" OC AT UPPER THIRD OF RAFTERS, UNLESS NOTED OTHERWISE.
- FUR RIDGES FOR FULL RAFTER CONTACT.
- PROVIDE CONTINUOUS BLOCKING THROUGH STRUCTURE FOR ALL POINT LOADS.
-  DENOTES OVER-FRAMED AREA
- MINIMUM 7/16" OSB ROOF SHEATHING
- PROVIDE 2x4 RAFTER TIES AT 16" OC AT 45° BETWEEN RAFTERS AND CEILING JOISTS. USE (4) 16d NAILS AT EACH CONNECTION. RAFTER TIES MAY BE SPACED AT 48" OC AT LOCATIONS WHERE NO KNEE WALLS ARE INSTALLED.
- PROVIDE H2.5A (MINIMUM) OR EQUIVALENT AT EACH RAFTER-TO-TOP PLATE CONNECTION AT OVER-FRAMED AREAS, UNLESS NOTED OTHERWISE.
- UPLIFT CONNECTION TO BE CARRIED THROUGH TO FLOOR SYSTEM.

BRICK VENEER LINTEL SCHEDULE

SPAN	STEEL ANGLE SIZE	END BEARING LENGTH
UP TO 42"	L3-1/2"x3-1/2"x1/4"	8" (MIN. @ EACH END)
UP TO 72"	L6"x4"x5/16" (LLV)	8" (MIN. @ EACH END)
OVER 72"	L6"x4"x5/16" (LLV) ATTACH LINTEL w/ 1/2" THRU BOLT @ 12" OC, 3" FROM EACH END	

* FOR QUEEN BRICK: LINTELS AT THIS CONDITION MAY BE 5"x3-1/2"x5/16"

NOTE: BRICK LINTELS AT SLOPED AREAS TO BE 4"x3-1/2"x1/4" STEEL ANGLE WITH 16D NAILS IN 3/16" HOLES IN 4" ANGLE LEG AT 12" OC TO TRIPLE RAFTER. WHEN THE SLOPE EXCEEDS 4:12 A MINIMUM OF 3"x3"x1/4" PLATES SHALL BE WELDED AT 24" OC ALONG THE STEEL ANGLE.



KB HOME
NORTH CAROLINA DIVISION
4518 S. MIAMI BLVD.
SUITE 180
DURHAM, NC 27703
TEL: (919) 768-7988
FAX: (919) 472-0582



P-0961

JDS Consulting, PLLC HAS PERFORMED A STRUCTURAL REVIEW OF THESE PLANS. THE STRUCTURAL COMPONENTS COMPLY WITH THE 2018 NORTH CAROLINA RESIDENTIAL CODE FOR ONE- AND TWO-FAMILY DWELLINGS FOR NC PLAN REVIEW. DEVIATION OF ANY STRUCTURAL REQUIREMENTS OF THESE PLANS WITHOUT THE APPROVAL OF THE EOR IS PROHIBITED.



8600 D' JERSEY CT, RALEIGH, NC 27617-919-480-1075
INFO@JDSCONSULTING.NET; WWW.JDSCONSULTING.NET

PROJECT NO.: 21901127
DATE: 05/21/2021

PLAN:
238.2338

GENERAL NOTES

GN1.1

These designs and drawings are CONFIDENTIAL, and the exclusive property of KB Home Corporation and are not to be disclosed without the express permission of KB Home Corporation. Copyright 2019 © KB Home Corporation. All rights reserved.

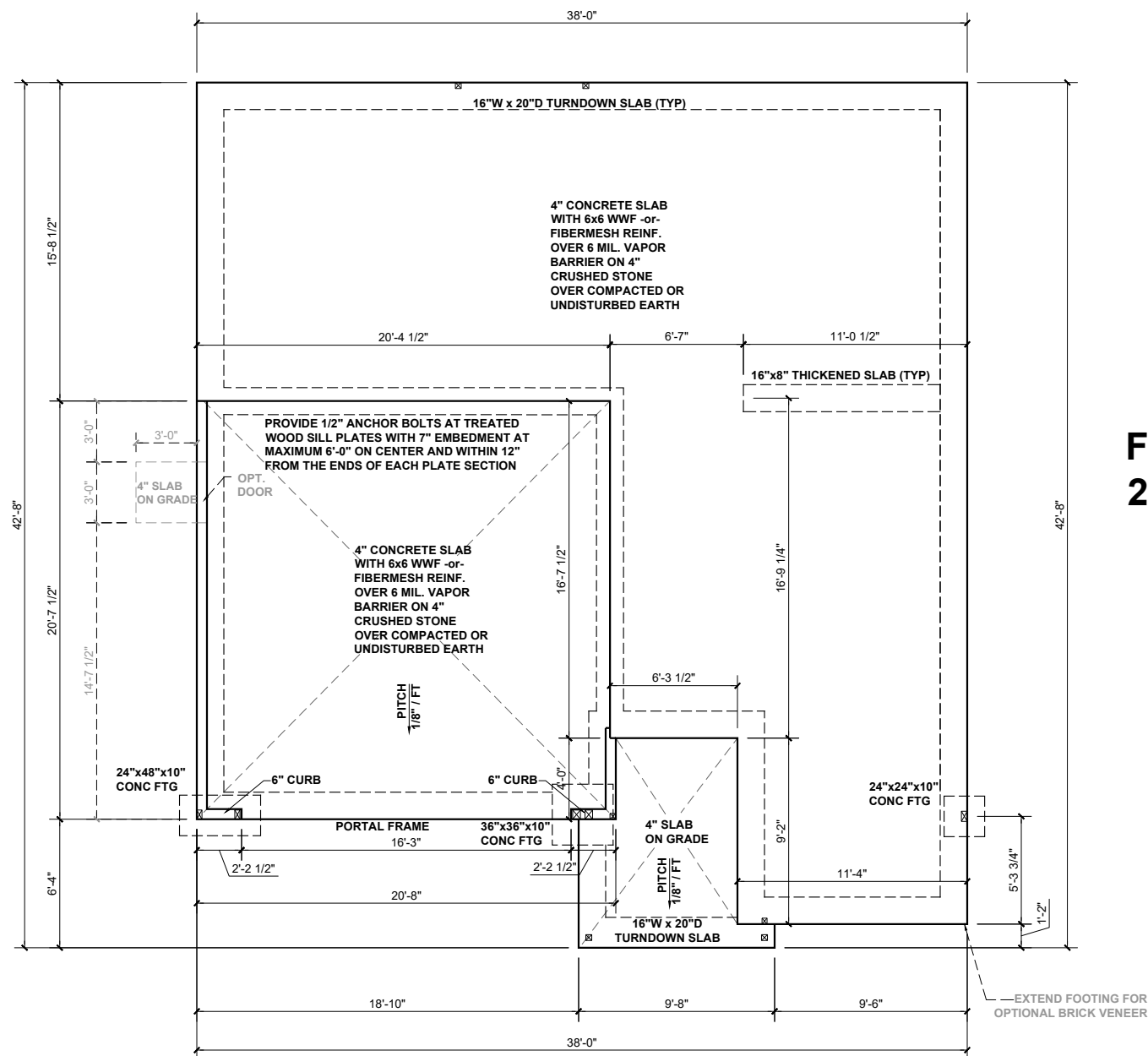

SLAB FOUNDATION PLAN - 'A'
SCALE: 1/8"=1'-0"

BEAM & POINT LOAD LEGEND

	INTERIOR LOAD BEARING WALL
	ROOF RAFTER / TRUSS SUPPORT
	DOUBLE RAFTER / DOUBLE JOIST
	STRUCTURAL BEAM / GIRDER
	WINDOW / DOOR HEADER
	POINT LOAD TRANSFER
	POINT LOAD FROM ABOVE BEARING ON BEAM / GIRDER

(1) #5 REBAR @ CENTER OF ALL PERIMETER AND INTERNAL LOAD BEARING FOOTINGS. (2" C.C. MIN)

ALL CONCRETE CURBS SUPPORTING PORTAL FRAMED OR ENGINEERED OPENINGS IN GARAGES WITH A PONY WALL OVER 24" ABOVE THE GARAGE DOOR HEADER SHALL BE REQUIRED TO BE AT LEAST 8" WIDE.

CONCRETE SLAB REINFORCING SUBSTITUTION OF SYNTHETIC FIBER MIX IN LIEU OF WWF IN NON STRUCTURAL SLABS:

- NO SUBSTITUTION ALLOWED IN SLABS INSTALLED ON RAISED METAL DECKING
- NO SUBSTITUTION ALLOWED IN SLABS WITH GRADE BEAMS UNLESS A REBAR MAT IS INSTALLED
- NO SUBSTITUTION ALLOWED IF ANY SOILS HAVE BEEN FOUND TO BE EXPANSIVE SOILS ON SITE
- NO SUBSTITUTION ALLOWED FOR SLAB POURS DIRECTLY ON GRADE; A 4" BASE MATERIAL OF CRUSHED STONE OR WELL DRAINING CLEAN SAND IS REQUIRED FOR SUBSTITUTION
- NO SUBSTITUTION ALLOWED FOR ANY SITES WITH A DCP BLOW COUNT OF 10 OR LESS.
- FIBER MIX VOLUMES MUST BE FOLLOWED PER THE MANUFACTURES SPECIFICATIONS

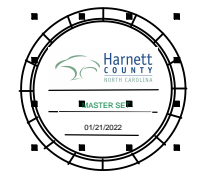

KB HOME
NORTH CAROLINA DIVISION
4518 S. MIAMI BLVD.
SUITE 180
DURHAM, NC 27703
TEL: (919) 768-7988
FAX: (919) 472-0582

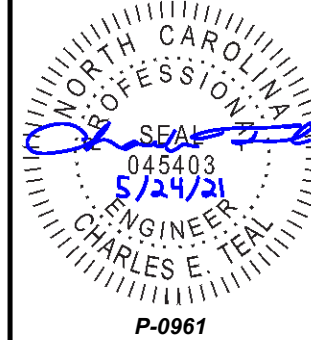

JDS Consulting
8600 D JERSEY CT, RALEIGH, NC 27617-919-480-1075
INFO@JDSCONSULTING.NET | WWW.JDSCONSULTING.NET

PROJECT NO.: 21901127
DATE: 05/21/2021

PLAN:
238.2338

SLAB
FOUNDATION PLAN
S.10A

These design and drawings are CONFIDENTIAL, and the exclusive property of KB Home Corporation and are not to be disclosed without the express permission of KB Home Corporation. Copyright 2019 © KB Home Corporation, all rights reserved.



KB HOME
NORTH CAROLINA DIVISION
4518 S. MIAMI BLVD.
SUITE 180
DURHAM, NC 27703
TEL: (919) 768-7988
FAX: (919) 472-0582



P-0961

JDS Consulting, PLLC HAS PERFORMED A STRUCTURAL REVIEW OF THESE PLANS. THE STRUCTURAL COMPONENTS COMPLY WITH THE 2018 NORTH CAROLINA RESIDENTIAL CODE FOR ONE- AND TWO-FAMILY DWELLINGS FOR NC PLAN REVIEW. DEVIATION OF ANY STRUCTURAL REQUIREMENTS OF THESE PLANS WITHOUT THE APPROVAL OF THE EOR IS PROHIBITED.



8600 D' JERSEY CT, RALEIGH, NC 27617-919-480-1075
INFO@JDSCONSULTING.NET | WWW.JDSCONSULTING.NET

PROJECT NO.: 21901127

DATE: 05/21/2021

PLAN:
238.2338

FIRST FLOOR
CEILING FRAMING PLAN

S1.0A

BEAM & POINT LOAD LEGEND

	INTERIOR LOAD BEARING WALL
	ROOF RAFTER / TRUSS SUPPORT
	DOUBLE RAFTER / DOUBLE JOIST
	STRUCTURAL BEAM / GIRDER
	WINDOW / DOOR HEADER
	POINT LOAD TRANSFER
	POINT LOAD FROM ABOVE BEARING ON BEAM / GIRDER

- STRUCTURAL FRAMING NOTES - (SEE GENERAL NOTES SHEET FOR ADDITIONAL REQUIREMENTS.)**
- ALL FRAMING TO BE #2 SPF MINIMUM.
 - ALL BEARING HEADERS TO BE (2) 2x6 SUPPORTED w/ MIN (1) JACK AND (1) KING EACH END, UNO.
 - EXTERIOR WALL OPENINGS OVER 3' TO HAVE MULTIPLE KING STUDS AS NOTED ON PLAN.
 - ALL NON-BEARING HEADERS TO BE (2) 2x4 (1) J / (1) K, UNO.
 - PROVIDE CONTINUOUS BLOCKING THROUGH STRUCTURE FOR ALL POINT LOADS.
 - ALL HANGERS AND CONNECTORS SPECIFIED ARE TO BE SIMPSON STRONG-TIE OR EQUIVALENT.
 - ALL BEAMS SPECIFIED ARE MINIMUM SIZES ONLY. LARGER MEMBERS MAY SUBSTITUTED AS NEEDED FOR EASE OF CONSTRUCTION. MINIMUM BEAM SUPPORT IS (1) 2x4 STUD.
 - ALL EXTERIOR WALLS TO BE FULLY SHEATHED WITH 7/16" OSB.
 - FRONT PORCH COLUMNS TO BE MIN 4x4 PT ATTACHED AT TOP AND BOTTOM USING SIMPSON (OR EQUIV) COLUMN BASE OR SST A24 BRACKETS. TRIM OUT PER BUILDER.
 - PORCH COLUMNS TO BE MIN 4x4 PT ATTACHED AT BOTTOM USING SIMPSON (OR EQUIV) ABA44 AND AT TOP USING CS 16 STRAPPING (12" MIN) TO PORCH HEADER / BAND.
 - WHEN A 4-PLY LVL IS USED, ATTACH WITH (1) 1/2" Ø BOLT 12" OC STAGGERED, TOP AND BOTTOM, 1-1/2" MIN FROM ENDS. ALTERNATE ATTACHMENT EQUIVALENT METHOD MAY BE USED, SUCH AS SDW OR TRUSSLOK SCREWS (SEE MANUFACTURER'S SPECIFICATIONS).
 - FOR STUD COLUMNS OF 4 OR MORE, INSTALL SST CS16 STRAPS @ 30" OC, 6" MAX FROM PLATES, ON INSIDE FACE OF COLUMN (EXTERIOR WALL), ON BOTH FACES OF COLUMN (INTERIOR WALL).

I-JOIST SPACING NOT TO EXCEED 19.2" OC IN LOCATIONS WITH TILE FINISH FLOOR

ALL FLUSH BEAMS TO BE DIRECTLY SUPPORTED BY (2) 2X STUDS UNLESS OTHERWISE NOTED. STUD COLUMNS TO BE SUPPORTED BY SOLID BLOCKING TO FOUNDATION OR TO BEARING COMPONENT BELOW.

FLOOR FRAMING TO BE 14" DEEP TJI 210 SERIES OR EQUAL, 19.2" OC MAXIMUM SPACING, U.N.O.

**REFER TO I-JOIST EQUIVALENCE CHART ON I-JOIST DETAIL SHEET FOR SUBSTITUTION OF MANUFACTURER SERIES

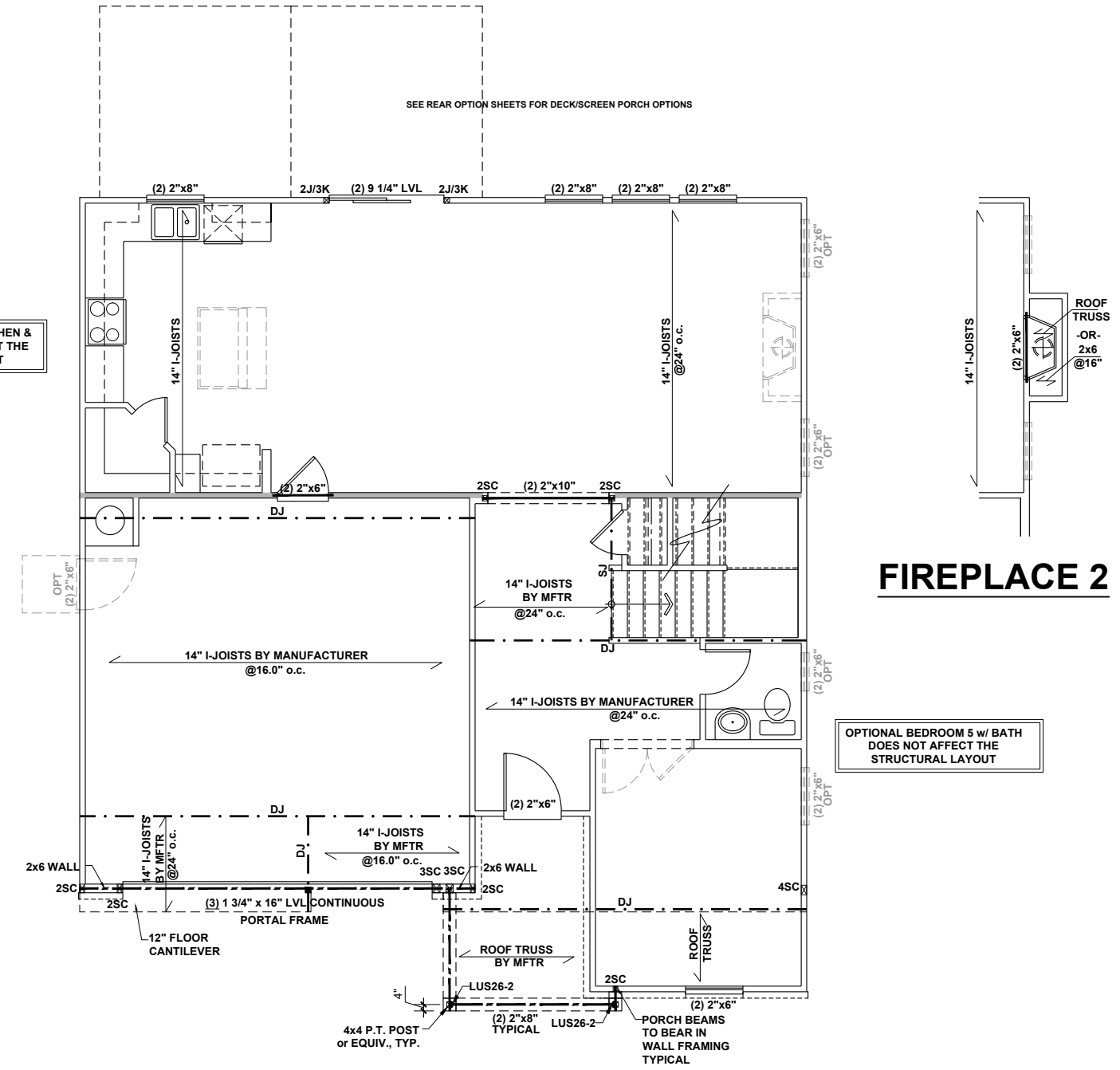

FIRST FLOOR CEILING FRAMING PLAN - 'A'

SCALE: 1/8"=1'-0"

These designs and drawings are CONFIDENTIAL, and the exclusive property of KB Home Corporation and are not to be disclosed without the express permission of KB Home Corporation. Copyright © 2019 KB Home Corporation, all rights reserved.



KB HOME
NORTH CAROLINA DIVISION
4518 S. MIAMI BLVD.
SUITE 180
DURHAM, NC 27703
TEL: (919) 768-7988
FAX: (919) 472-0582

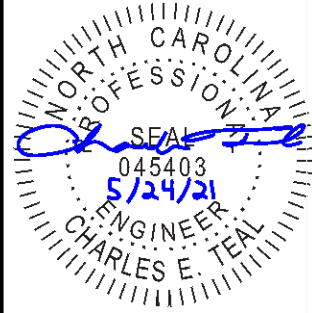

P-0961

JDS Consulting, PLLC HAS PERFORMED A STRUCTURAL REVIEW OF THESE PLANS. THE STRUCTURAL COMPONENTS COMPLY WITH THE 2018 NORTH CAROLINA RESIDENTIAL CODE FOR ONE- AND TWO-FAMILY DWELLINGS FOR NC PLAN REVIEW. DEVIATION OF ANY STRUCTURAL REQUIREMENTS OF THESE PLANS WITHOUT THE APPROVAL OF THE EOR IS PROHIBITED.



8600 D' JERSEY CT, RALEIGH, NC 27617-919-480-1075
INFO@JDSCONSULTING.NET - WWW.JDSCONSULTING.NET

PROJECT NO.: 21901127
DATE: 05/21/2021

PLAN:
238.2338

SECOND FLOOR
CEILING FRAMING PLAN

S2.0A

BEAM & POINT LOAD LEGEND	
	INTERIOR LOAD BEARING WALL
	ROOF RAFTER / TRUSS SUPPORT
	DOUBLE RAFTER / DOUBLE JOIST
	STRUCTURAL BEAM / GIRDER
	WINDOW / DOOR HEADER
	POINT LOAD TRANSFER
	POINT LOAD FROM ABOVE BEARING ON BEAM / GIRDER

- STRUCTURAL FRAMING NOTES - (SEE GENERAL NOTES SHEET FOR ADDITIONAL REQUIREMENTS.)**
- ALL FRAMING TO BE #2 SPF MINIMUM.
 - ALL BEARING HEADERS TO BE (2) 2x6 SUPPORTED w/ MIN (1) JACK AND (1) KING EACH END, UNO.
 - EXTERIOR WALL OPENINGS OVER 3' TO HAVE MULTIPLE KING STUDS AS NOTED ON PLAN.
 - ALL NON-BEARING HEADERS TO BE (2) 2x4 (1) J / (1) K, UNO.
 - PROVIDE CONTINUOUS BLOCKING THROUGH STRUCTURE FOR ALL POINT LOADS.
 - ALL HANGERS AND CONNECTORS SPECIFIED ARE TO BE SIMPSON STRONG-TIE OR EQUIVALENT.
 - ALL BEAMS SPECIFIED ARE MINIMUM SIZES ONLY. LARGER MEMBERS MAY SUBSTITUTED AS NEEDED FOR EASE OF CONSTRUCTION. MINIMUM BEAM SUPPORT IS (1) 2x4 STUD.
 - ALL EXTERIOR WALLS TO BE FULLY SHEATHED WITH 7/16" OSB.
 - FRONT PORCH COLUMNS TO BE MIN 4x4 PT ATTACHED AT TOP AND BOTTOM USING SIMPSON (OR EQUIV) COLUMN BASE OR SST A24 BRACKETS. TRIM OUT PER BUILDER.
 - PORCH COLUMNS TO BE MIN 4x4 PT ATTACHED AT BOTTOM USING SIMPSON (OR EQUIV) ABA44 AND AT TOP USING CS 16 STRAPPING (12" MIN) TO PORCH HEADER / BAND.
 - WHEN A 4-PLY LVL IS USED, ATTACH WITH (1) 1/2" Ø BOLT 12" OC STAGGERED, TOP AND BOTTOM, 1-1/2" MIN FROM ENDS. ALTERNATE ATTACHMENT EQUIVALENT METHOD MAY BE USED, SUCH AS SDW OR TRUSSEK SCREWS (SEE MANUFACTURER'S SPECIFICATIONS).
 - FOR STUD COLUMNS OF 4 OR MORE, INSTALL SST CS16 STRAPS @ 30" OC, 6" MAX FROM PLATES, ON INSIDE FACE OF COLUMN (EXTERIOR WALL), ON BOTH FACES OF COLUMN (INTERIOR WALL).

ALL FLUSH BEAMS TO BE DIRECTLY SUPPORTED BY (2) 2X STUDS UNLESS OTHERWISE NOTED. STUD COLUMNS TO BE SUPPORTED BY SOLID BLOCKING TO FOUNDATION OR TO BEARING COMPONENT BELOW.

MASTER BATH OPTIONS DO NOT AFFECT THE STRUCTURAL LAYOUT

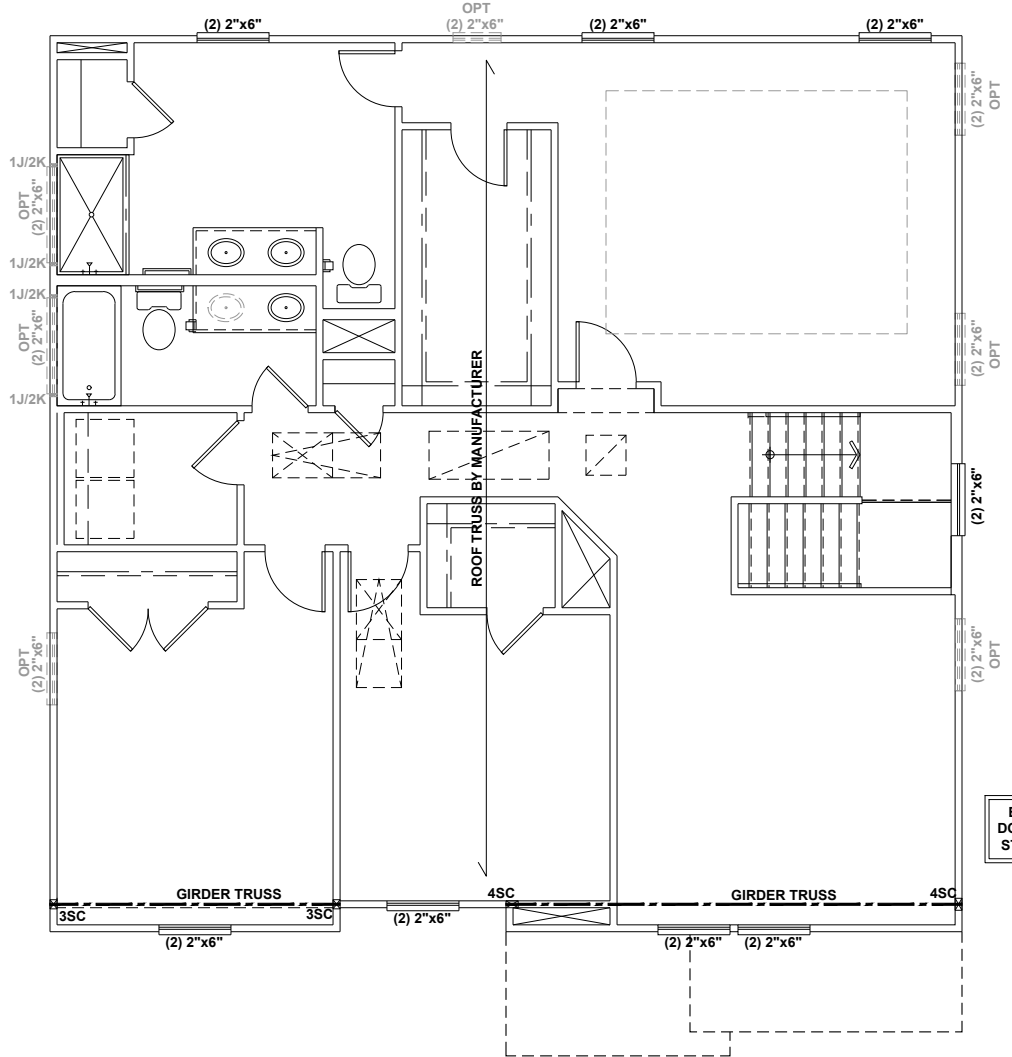

BEDROOM 4 OPTION DOES NOT AFFECT THE STRUCTURAL LAYOUT

SECOND FLOOR CEILING FRAMING PLAN - 'A'

SCALE: 1/8"=1'-0"

These designs and drawings are CONFIDENTIAL, and the exclusive property of KB Home Corporation and are not to be disclosed without the express permission of KB Home Corporation. Copyright 2019 © KB Home Corporation, all rights reserved.

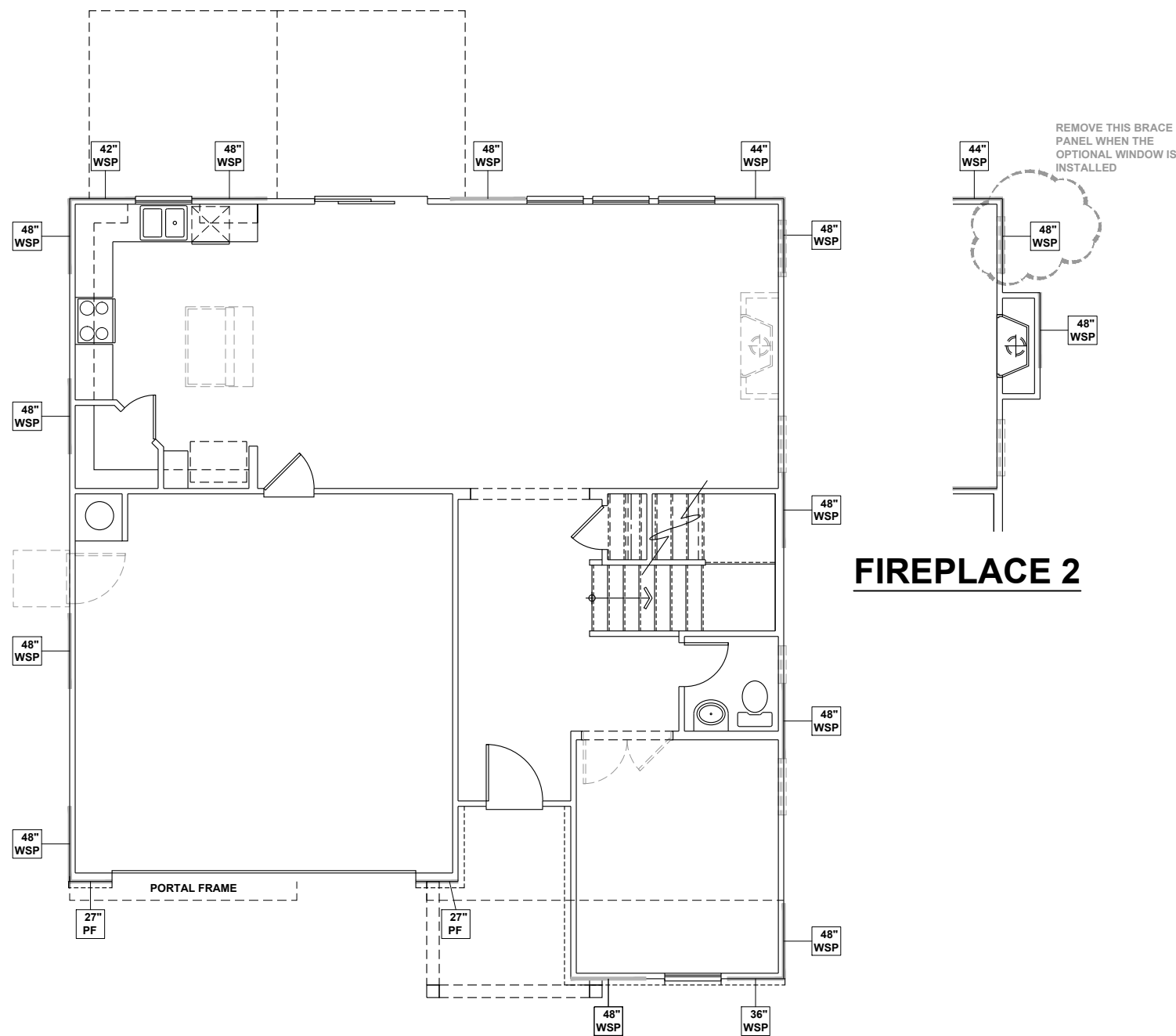

WALL BRACING REQUIREMENTS

- MINIMUM PANEL WIDTH IS 24"
- FIGURES BASED ON THE CONTINUOUS SHEATHING METHOD USING THE RECTANGLE CIRCUMSCRIBED AROUND THE FLOOR PLAN OR PORTION OF THE FLOOR PLAN. IF NO RECTANGLE IS NOTED, THE STRUCTURE HAS BEEN FIGURED ALL WITHIN ONE RECTANGLE.
- PANELS MAY SHIFT UP TO 36" EITHER DIRECTION FOR EASE OF CONSTRUCTION (NAILING & BLOCK REQUIREMENTS STILL APPLY).
- FOR ADDITIONAL WALL BRACING INFORMATION, REFER TO WALL BRACING DETAIL SHEET(S).
- SCHEMATIC BELOW INDICATES HOW SIDES OF RECTANGLE ARE TO BE INTERPRETED IN BRACING CHART WHEN APPLIED TO STRUCTURE:

- ◆ CS16 STRAP FROM STUD, CROSS HEADER, TO WALL TOP PLATE, 36" LONG MINIMUM
- ▶ SIMPSON MSTA15 HOLD DOWN CAPACITY OF 970 POUNDS PER ANCHOR WITH (12) 10d NAILS. STRAP TO BE LOCATED AT EDGE OF BRACED WALL PANEL. (CS16 STRAPPING MAY BE SUBSTITUTED w/ SIMILAR LENGTH AND NAILING PATTERN.) USE HTT4 FOR ATTACHMENT TO CONCRETE.

SCALED LENGTH OF WALL PANEL AT LOCATION: 24" WSP, NUMERICAL LENGTH OF PANEL: 48" WSP, PANEL TYPE

ENGINEERED WALL SCHEDULE

ENG1: CONTINUOUSLY SHEATH WITH 7/16" OSB ATTACHED WITH 8d NAILS @ 6" OC EDGE AND 12" OC FIELD. FULLY BLOCKED AT ALL PANEL EDGES.

ENG2: CONTINUOUSLY SHEATH WITH 7/16" OSB WITH 10d NAILS @ 3" OC EDGE AND 3" OC FIELD. FULLY BLOCKED AT ALL PANEL EDGES.

ENG3: CONTINUOUSLY SHEATH 7/16" OSB ATTACHED BOTH SIDES WITH 8d NAILS @ 4" OC EDGE AND 8" OC FIELD. FULLY BLOCKED AT ALL PANEL EDGES.

ENG4: CONTINUOUSLY SHEATH 7/16" OSB ATTACHED WITH 8d NAILS @ 4" OC EDGE AND 8" OC FIELD. FULLY BLOCKED AT ALL PANEL EDGES.

WALL BRACING NOTE:

WALLS WITH PROVIDED LENGTH LISTED AS "N/A" DO NOT MEET THE REQUIREMENTS OF PRESCRIPTIVE WALL BRACING FOUND IN THE NCRC. THESE WALLS HAVE BEEN ENGINEERED BASED ON DESIGN GUIDELINES ESTABLISHED IN ASCE-07 AND THE NDS: WIND & SEISMIC PROVISIONS SUPPLEMENT.

WALL BRACING: RECTANGLE 1

SIDE	REQUIRED LENGTH	PROVIDED LENGTH
FRONT	13.5 FT.	16.0 FT.
LEFT	11.0 FT.	16.0 FT.
REAR	13.5 FT.	15.16 FT.
RIGHT	11.0 FT.	16.0 FT.



KB HOME
NORTH CAROLINA DIVISION
4518 S. MIAMI BLVD.
SUITE 180
DURHAM, NC 27703
TEL: (919) 768-7988
FAX: (919) 472-0582

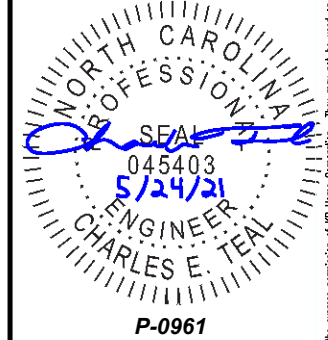

P-0961

JDS Consulting, PLLC HAS PERFORMED A STRUCTURAL REVIEW OF THESE PLANS. THE STRUCTURAL COMPONENTS COMPLY WITH THE 2018 NORTH CAROLINA RESIDENTIAL CODE FOR ONE- AND TWO-FAMILY DWELLINGS FOR NC PLAN REVIEW. DEVIATION OF ANY STRUCTURAL REQUIREMENTS OF THESE PLANS WITHOUT THE APPROVAL OF THE EOR IS PROHIBITED.

JDS Consulting
8600 D' JERSEY CT, RALEIGH, NC 27617-919-480-1075
INFO@JDSCONSULTING.NET · WWW.JDSCONSULTING.NET

PROJECT NO.: 21901127
DATE: 05/21/2021

PLAN:
238.2338

FIRST FLOOR
WALL BRACING PLAN
S4.0A

FIRST FLOOR WALL BRACING PLAN - 'A'
SCALE: 1/8"=1'-0"

These designs and drawings are CONFIDENTIAL, and the exclusive property of KB Home Corporation and are not to be disclosed without the express permission of KB Home Corporation. Copyright 2019 © KB Home Corporation, all rights reserved.

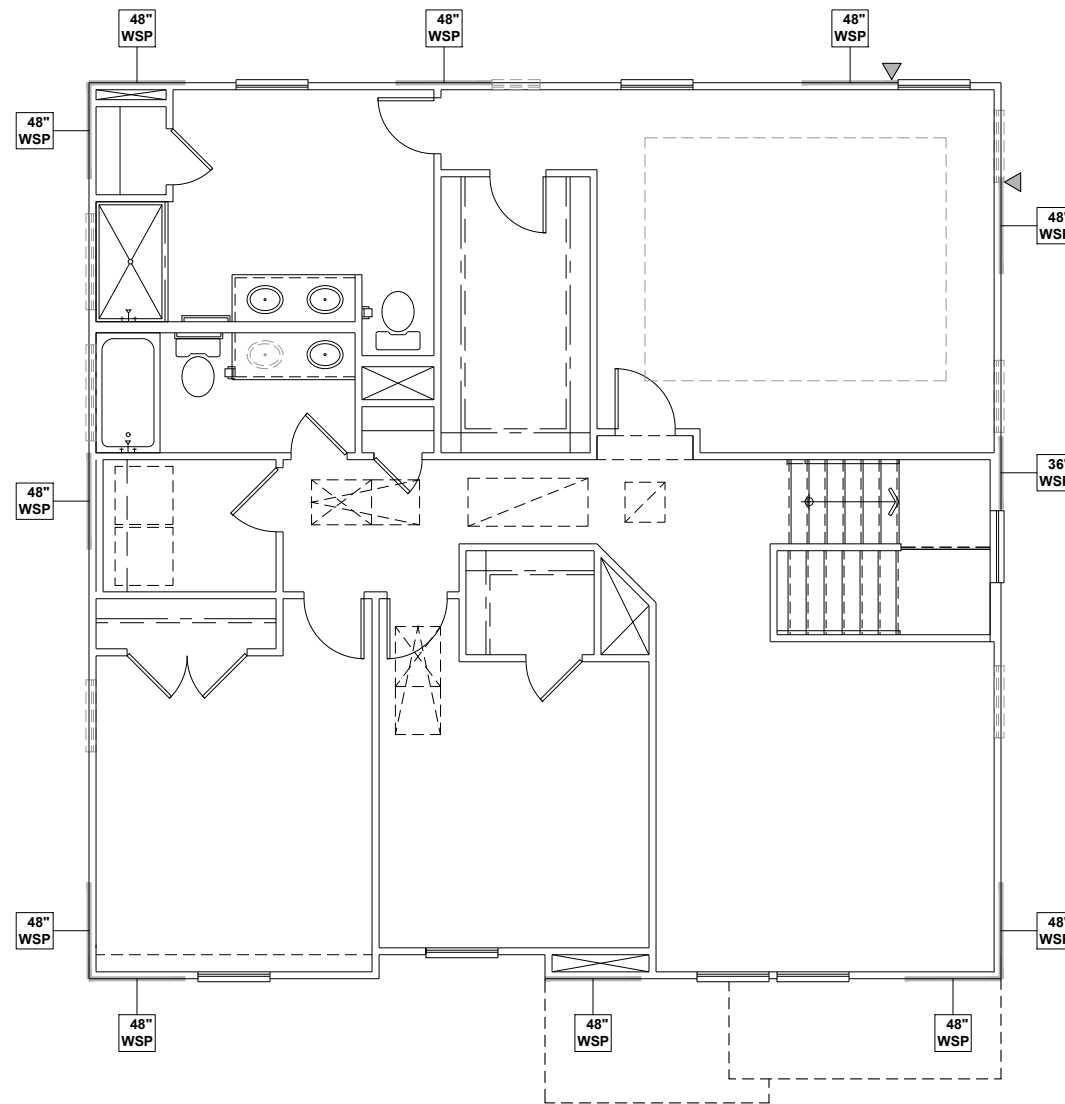

WALL BRACING REQUIREMENTS

- MINIMUM PANEL WIDTH IS 24"
- FIGURES BASED ON THE CONTINUOUS SHEATHING METHOD USING THE RECTANGLE CIRCUMSCRIBED AROUND THE FLOOR PLAN OR PORTION OF THE FLOOR PLAN. IF NO RECTANGLE IS NOTED, THE STRUCTURE HAS BEEN FIGURED ALL WITHIN ONE RECTANGLE.
- PANELS MAY SHIFT UP TO 36" EITHER DIRECTION FOR EASE OF CONSTRUCTION (NAILING & BLOCK REQUIREMENTS STILL APPLY).
- FOR ADDITIONAL WALL BRACING INFORMATION, REFER TO WALL BRACING DETAIL SHEET(S).
- SCHEMATIC BELOW INDICATES HOW SIDES OF RECTANGLE ARE TO BE INTERPRETED IN BRACING CHART WHEN APPLIED TO STRUCTURE:

- ◆ CS16 STRAP FROM STUD, CROSS HEADER, TO WALL TOP PLATE, 36" LONG MINIMUM
- ▶ SIMPSON MSTA15 HOLD DOWN CAPACITY OF 970 POUNDS PER ANCHOR WITH (12) 10d NAILS. STRAP TO BE LOCATED AT EDGE OF BRACED WALL PANEL. (CS16 STRAPPING MAY BE SUBSTITUTED w/ SIMILAR LENGTH AND NAILING PATTERN.) USE HTT4 FOR ATTACHMENT TO CONCRETE.

SCALED LENGTH OF WALL PANEL AT LOCATION

24" WSP

NUMERICAL LENGTH OF PANEL

PANEL TYPE

ENGINEERED WALL SCHEDULE

ENG1: CONTINUOUSLY SHEATH WITH 7/16" OSB ATTACHED WITH 8d NAILS @ 6" OC EDGE AND 12" OC FIELD. FULLY BLOCKED AT ALL PANEL EDGES.

ENG2: CONTINUOUSLY SHEATH WITH 7/16" OSB WITH 10d NAILS @ 3" OC EDGE AND 3" OC FIELD. FULLY BLOCKED AT ALL PANEL EDGES.

ENG3: CONTINUOUSLY SHEATH 7/16" OSB ATTACHED BOTH SIDES WITH 8d NAILS @ 4" OC EDGE AND 8" OC FIELD. FULLY BLOCKED AT ALL PANEL EDGES.

ENG4: CONTINUOUSLY SHEATH 7/16" OSB ATTACHED WITH 8d NAILS @ 4" OC EDGE AND 8" OC FIELD. FULLY BLOCKED AT ALL PANEL EDGES.

WALL BRACING NOTE:

WALLS WITH PROVIDED LENGTH LISTED AS "N/A" DO NOT MEET THE REQUIREMENTS OF PRESCRIPTIVE WALL BRACING FOUND IN THE NCRC. THESE WALLS HAVE BEEN ENGINEERED BASED ON DESIGN GUIDELINES ESTABLISHED IN ASCE-07 AND THE NDS: WIND & SEISMIC PROVISIONS SUPPLEMENT.

WALL BRACING: RECTANGLE 1

SIDE	REQUIRED LENGTH	PROVIDED LENGTH
FRONT	6.5 FT.	12.0 FT.
LEFT	5.5 FT.	12.0 FT.
REAR	6.5 FT.	12.0 FT.
RIGHT	5.5 FT.	11.0 FT.



KB HOME
NORTH CAROLINA DIVISION
4518 S. MIAMI BLVD.
SUITE 180
DURHAM, NC 27703
TEL: (919) 768-7988
FAX: (919) 472-0582

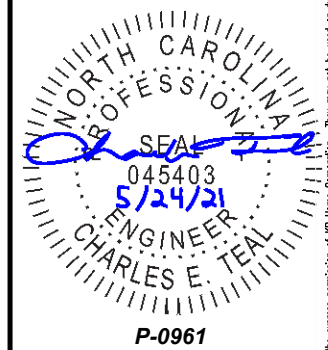

P-0961

JDS Consulting, PLLC HAS PERFORMED A STRUCTURAL REVIEW OF THESE PLANS. THE STRUCTURAL COMPONENTS COMPLY WITH THE 2018 NORTH CAROLINA RESIDENTIAL CODE FOR ONE- AND TWO-FAMILY DWELLINGS FOR NC PLAN REVIEW. DEVIATION OF ANY STRUCTURAL REQUIREMENTS OF THESE PLANS WITHOUT THE APPROVAL OF THE EOR IS PROHIBITED.

JDS Consulting
8600 D' JERSEY CT, RALEIGH, NC 27617-919-480-1075
INFO@JDSCONSULTING.NET | WWW.JDSCONSULTING.NET

PROJECT NO.: 21901127
DATE: 05/21/2021

PLAN:
238.2338

SECOND FLOOR
WALL BRACING PLAN
S5.0A

SECOND FLOOR WALL BRACING PLAN - 'A'
SCALE: 1/8"=1'-0"

These designs and drawings are CONFIDENTIAL, and the exclusive property of KB Home Corporation and are not to be disclosed without the express permission of KB Home Corporation. Copyright 2019 © KB Home Corporation, all rights reserved.

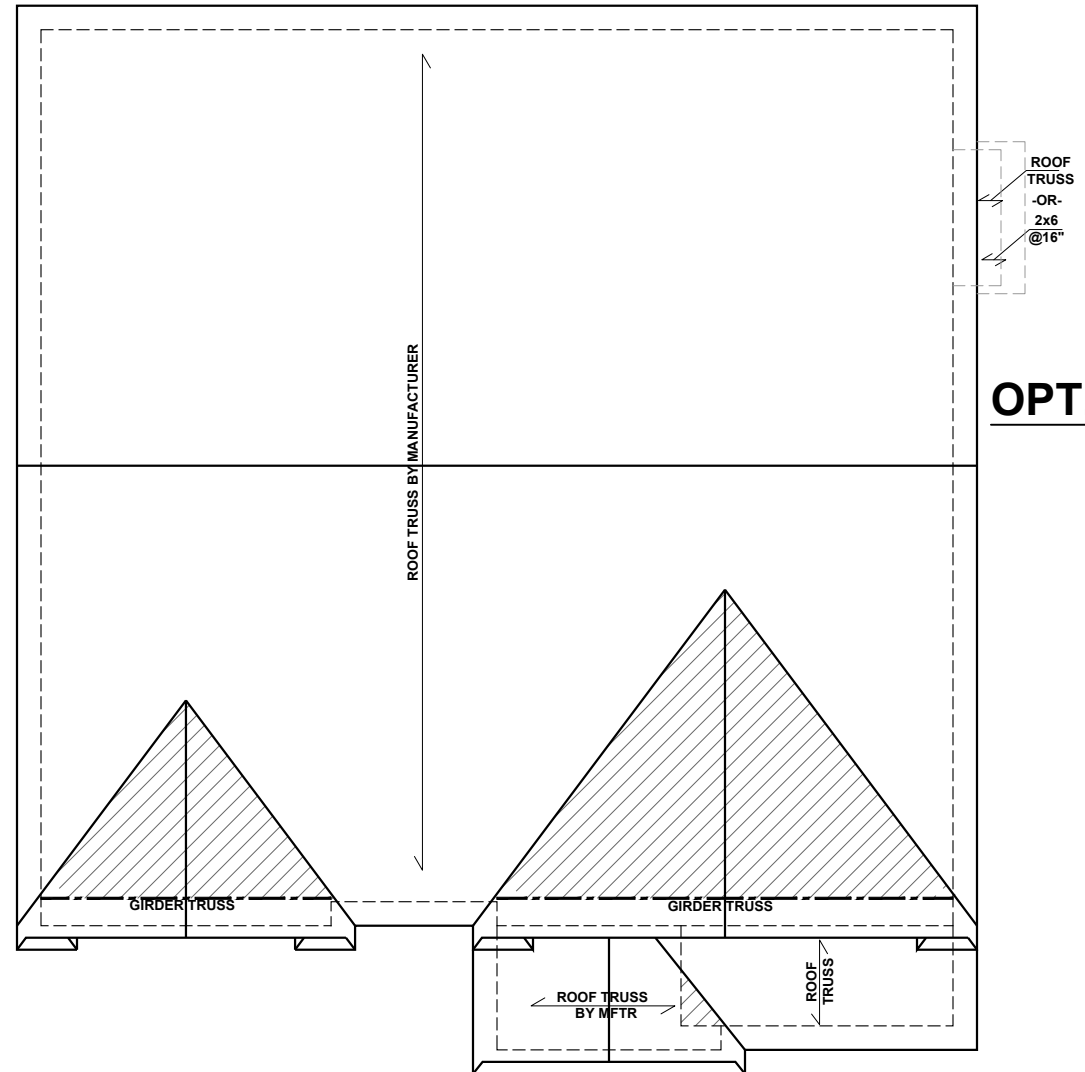

OPT. FIREPLACE 2

ROOF FRAMING PLAN - 'A'

SCALE: 1/8"=1'-0"

BEAM & POINT LOAD LEGEND

	INTERIOR LOAD BEARING WALL
	ROOF RAFTER / TRUSS SUPPORT
	DOUBLE RAFTER / DOUBLE JOIST
	STRUCTURAL BEAM / GIRDER
	WINDOW / DOOR HEADER
	POINT LOAD TRANSFER
	POINT LOAD FROM ABOVE BEARING ON BEAM / GIRDER

- TRUSSED ROOF - STRUCTURAL NOTES**
1. PROVIDE CONTINUOUS BLOCKING THROUGH STRUCTURE FOR ALL POINT LOADS.
 2. DENOTES OVER-FRAMED AREA
 3. MINIMUM 7/16" OSB ROOF SHEATHING
 4. TRUSS LAYOUT AND PLACEMENT BY MANUFACTURER TO COINCIDE WITH THE SUPPORT LOCATIONS SHOWN. TRUSS PROFILES SHALL BE SEALED BY THE TRUSS MANUFACTURER. TRUSS PLANS TO BE COORDINATED WITH THE SEALED STRUCTURAL DRAWINGS. INSTALLATION SHALL BE IN ACCORDANCE WITH THE MANUFACTURER'S INSTRUCTIONS.
 5. MANUFACTURER TO PROVIDE REQUIRED UPLIFT CONNECTION.
 6. PROVIDE H2.5A (MINIMUM) OR EQUIVALENT AT EACH TRUSS-TO-TOP PLATE CONNECTION AT OVER-FRAMED AREAS, UNLESS NOTED OTHERWISE.
 7. UPLIFT CONNECTION TO BE CARRIED THROUGH TO FLOOR SYSTEM.

TRUSS UPLIFT CONNECTORS: EXPOSURE B, 115 MPH, ANY PITCH, 24" O.C. MAX ROOF TRUSS SPACING

TRUSSES SHALL BE ATTACHED TO SUPPORT WALL FOR UPLIFT RESISTANCE. CONTINUOUS OSB WALL SHEATHING BELOW PROVIDES CONTINUOUS UPLIFT RESISTANCE TO FOUNDATION. ALL TRUSSES SUPPORTED BY INTERMEDIATE SUPPORT WALLS, KNEEWALLS, OR BEAMS SHALL BE ATTACHED TO SUPPORTING MEMBER PER SCHEDULE:

ROOF SPAN IS MEASURED HORIZONTALLY BETWEEN FURTHEST SUPPORT POINTS.

ROOF PLAN UP TO 28'	CONNECTOR NAILING PER TABLE 602.3(1) NCRBC 2018 EDITION
OVER 28'	(1) SIMPSON H2.5A HURRICANE CLIP TO DBL TOP PLATE OR BEAM OR (1) SIMPSON H3 CLIP TO SINGLE 2x4 PLATE

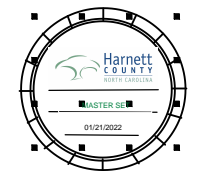

KB HOME
NORTH CAROLINA DIVISION
4518 S. MIAMI BLVD.
SUITE 180
DURHAM, NC 27703
TEL: (919) 768-7988
FAX: (919) 472-0582

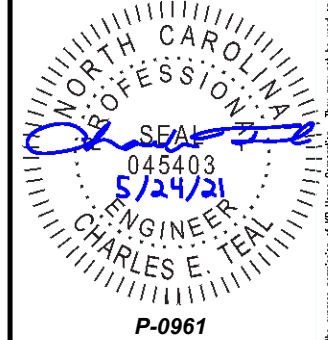

JDS Consulting, PLLC HAS PERFORMED A STRUCTURAL REVIEW OF THESE PLANS. THE STRUCTURAL COMPONENTS COMPLY WITH THE 2018 NORTH CAROLINA RESIDENTIAL CODE FOR ONE- AND TWO-FAMILY DWELLINGS FOR NC PLAN REVIEW. DEVIATION OF ANY STRUCTURAL REQUIREMENTS OF THESE PLANS WITHOUT THE APPROVAL OF THE EOR IS PROHIBITED.

JDS Consulting
8600 D JERSEY CT, RALEIGH, NC 27617-919-480-1075
INFO@JDSCONSULTING.NET | WWW.JDSCONSULTING.NET

PROJECT NO.: 21901127
DATE: 05/21/2021

PLAN:
238.2338

ROOF FRAMING PLAN
S7.0A

These designs and drawings are CONFIDENTIAL, and the exclusive property of KB Home Corporation and are not to be disclosed without the express permission of KB Home Corporation. Copyright © KB Home Corporation, all rights reserved.

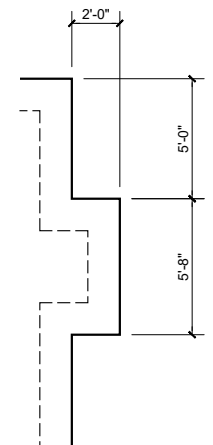
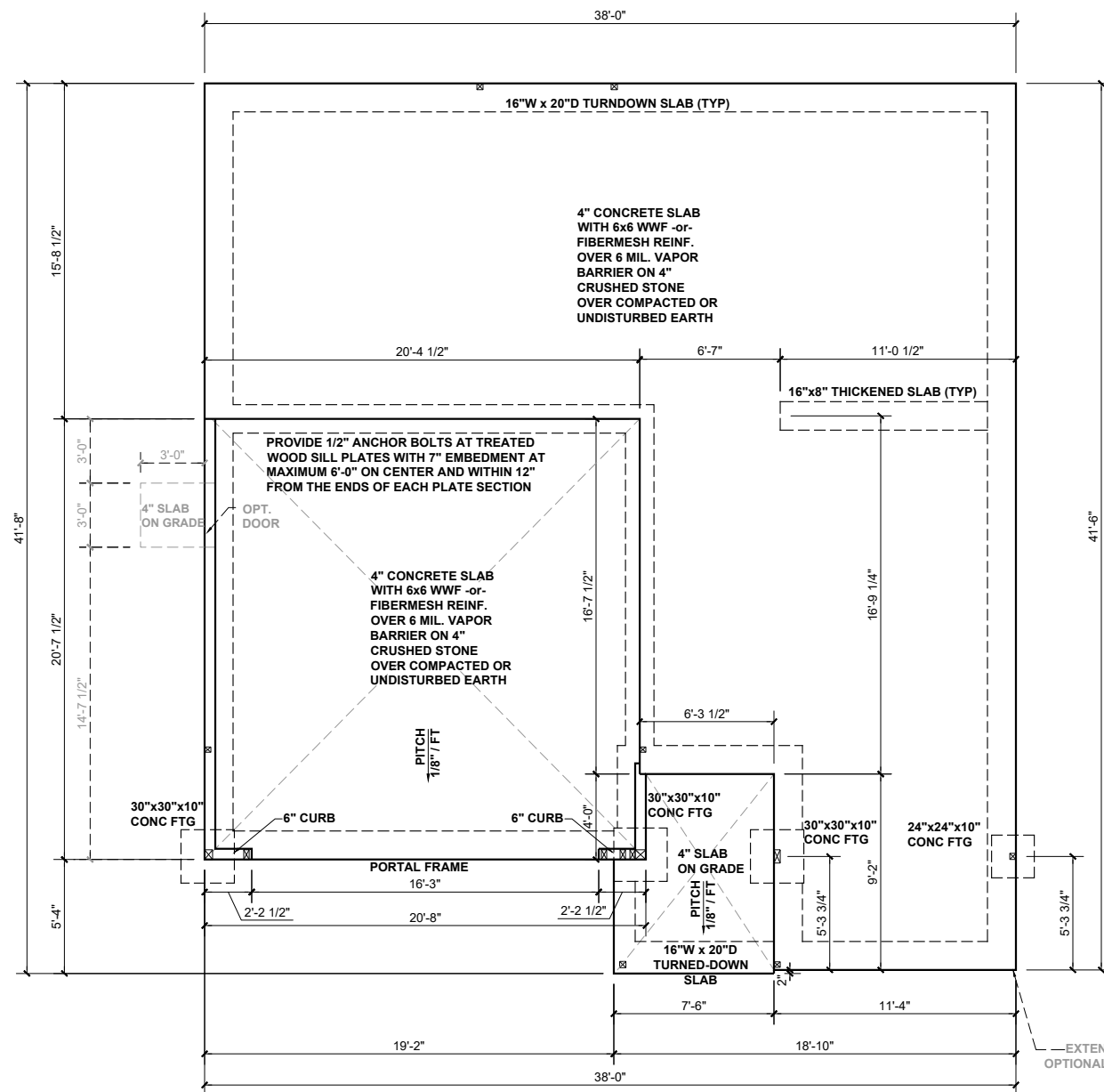

**FIREPLACE
2**

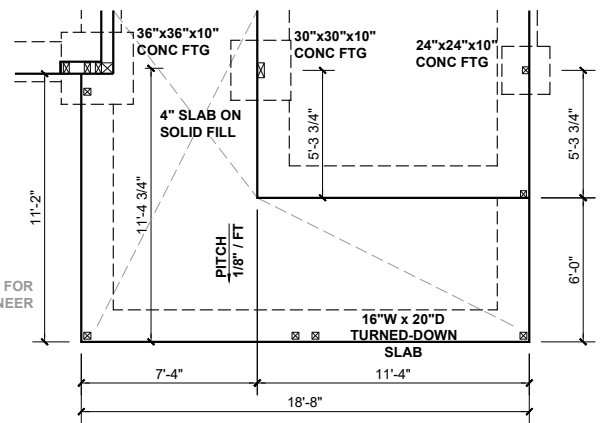

OPT. ENLARGED PORCH

BEAM & POINT LOAD LEGEND

- INTERIOR LOAD BEARING WALL
- - - ROOF RAFTER / TRUSS SUPPORT
- · - · - DOUBLE RAFTER / DOUBLE JOIST
- STRUCTURAL BEAM / GIRDER
- WINDOW / DOOR HEADER
- ⊠ POINT LOAD TRANSFER
- POINT LOAD FROM ABOVE BEARING ON BEAM / GIRDER

(1) #5 REBAR @ CENTER OF ALL PERIMETER AND INTERNAL LOAD BEARING FOOTINGS. (2" C.C. MIN)

ALL CONCRETE CURBS SUPPORTING PORTAL FRAMED OR ENGINEERED OPENINGS IN GARAGES WITH A PONY WALL OVER 24" ABOVE THE GARAGE DOOR HEADER SHALL BE REQUIRED TO BE AT LEAST 8" WIDE.

CONCRETE SLAB REINFORCING SUBSTITUTION OF SYNTHETIC FIBER MIX IN LIEU OF WWF IN NON STRUCTURAL SLABS:

- NO SUBSTITUTION ALLOWED IN SLABS INSTALLED ON RAISED METAL DECKING
- NO SUBSTITUTION ALLOWED IN SLABS WITH GRADE BEAMS UNLESS A REBAR MAT IS INSTALLED
- NO SUBSTITUTION ALLOWED IF ANY SOILS HAVE BEEN FOUND TO BE EXPANSIVE SOILS ON SITE
- NO SUBSTITUTION ALLOWED FOR SLAB POURS DIRECTLY ON GRADE; A 4" BASE MATERIAL OF CRUSHED STONE OR WELL DRAINING CLEAN SAND IS REQUIRED FOR SUBSTITUTION
- NO SUBSTITUTION ALLOWED FOR ANY SITES WITH A DCP BLOW COUNT OF 10 OR LESS.
- FIBER MIX VOLUMES MUST BE FOLLOWED PER THE MANUFACTURES SPECIFICATIONS

SLAB FOUNDATION PLAN - 'B'
SCALE: 1/8"=1'-0"

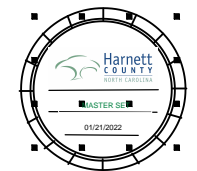

KB HOME
NORTH CAROLINA DIVISION
4518 S. MIAMI BLVD.
SUITE 180
DURHAM, NC 27703
TEL: (919) 768-7988
FAX: (919) 472-0582

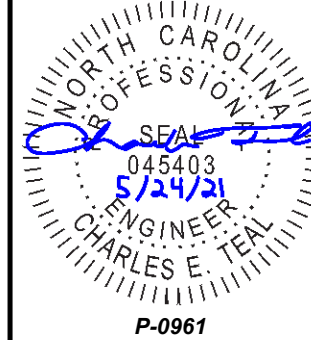

JDS Consulting, PLLC HAS PERFORMED A STRUCTURAL REVIEW OF THESE PLANS. THE STRUCTURAL COMPONENTS COMPLY WITH THE 2018 NORTH CAROLINA RESIDENTIAL CODE FOR ONE- AND TWO-FAMILY DWELLINGS FOR NC PLAN REVIEW. DEVIATION OF ANY STRUCTURAL REQUIREMENTS OF THESE PLANS WITHOUT THE APPROVAL OF THE EOR IS PROHIBITED.



PROJECT NO.: 21901127
DATE: 05/21/2021

PLAN:
238.2338

SLAB
FOUNDATION PLAN
S.10B

These designs and drawings are CONFIDENTIAL, and the exclusive property of KB Home Corporation and are not to be disclosed without the express permission of KB Home Corporation. Copyright © 2019 KB Home Corporation. All rights reserved.

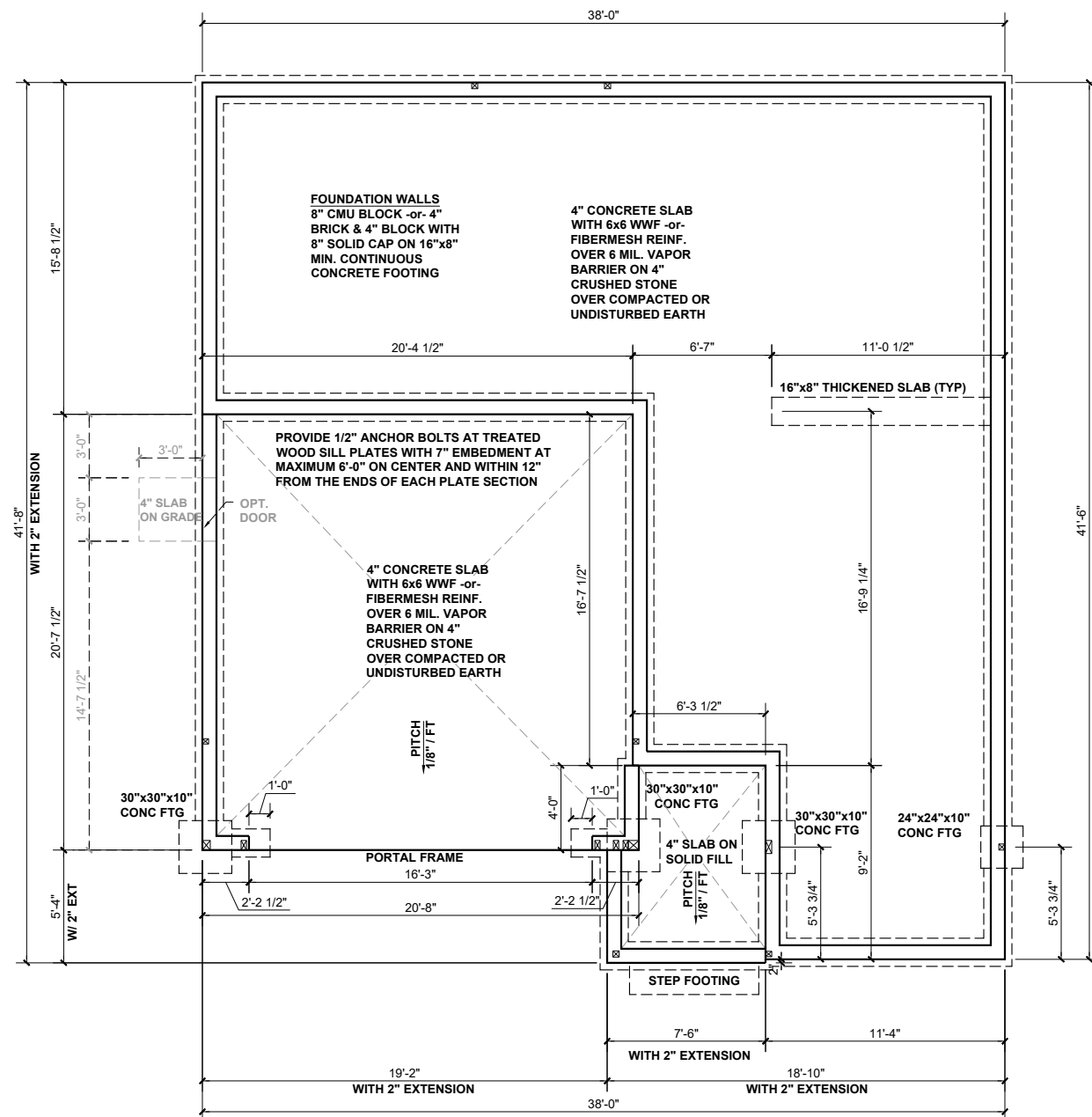

FIREPLACE 2

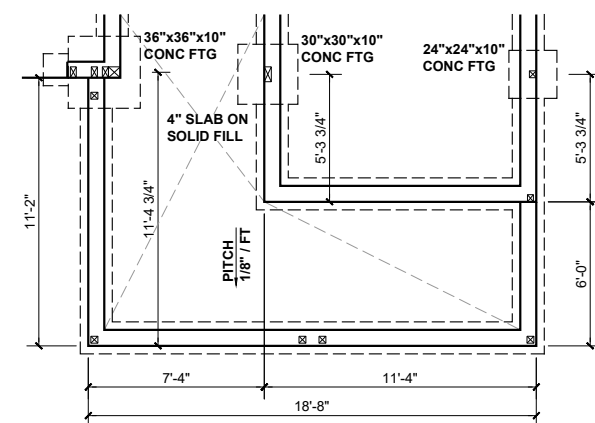

OPT. ENLARGED PORCH

STEM WALL FOUNDATION PLAN - 'B'

SCALE: 1/8"=1'-0"

BEAM & POINT LOAD LEGEND

	INTERIOR LOAD BEARING WALL
	ROOF RAFTER / TRUSS SUPPORT
	DOUBLE RAFTER / DOUBLE JOIST
	STRUCTURAL BEAM / GIRDER
	WINDOW / DOOR HEADER
	POINT LOAD TRANSFER
	POINT LOAD FROM ABOVE BEARING ON BEAM / GIRDER

(1) #5 REBAR @ CENTER OF ALL PERIMETER AND INTERNAL LOAD BEARING FOOTINGS. (2" C.C. MIN)

ALL CONCRETE CURBS SUPPORTING PORTAL FRAMED OR ENGINEERED OPENINGS IN GARAGES WITH A PONY WALL OVER 24" ABOVE THE GARAGE DOOR HEADER SHALL BE REQUIRED TO BE AT LEAST 8" WIDE.

CONCRETE SLAB REINFORCING SUBSTITUTION OF SYNTHETIC FIBER MIX IN LIEU OF WWF IN NON STRUCTURAL SLABS:

- NO SUBSTITUTION ALLOWED IN SLABS INSTALLED ON RAISED METAL DECKING
- NO SUBSTITUTION ALLOWED IN SLABS WITH GRADE BEAMS UNLESS A REBAR MAT IS INSTALLED
- NO SUBSTITUTION ALLOWED IF ANY SOILS HAVE BEEN FOUND TO BE EXPANSIVE SOILS ON SITE
- NO SUBSTITUTION ALLOWED FOR SLAB POURS DIRECTLY ON GRADE; A 4" BASE MATERIAL OF CRUSHED STONE OR WELL DRAINING CLEAN SAND IS REQUIRED FOR SUBSTITUTION
- NO SUBSTITUTION ALLOWED FOR ANY SITES WITH A DCP BLOW COUNT OF 10 OR LESS.
- FIBER MIX VOLUMES MUST BE FOLLOWED PER THE MANUFACTURES SPECIFICATIONS



KB HOME
NORTH CAROLINA DIVISION
4518 S. MIAMI BLVD.
SUITE 180
DURHAM, NC 27703
TEL: (919) 768-7988
FAX: (919) 472-0582

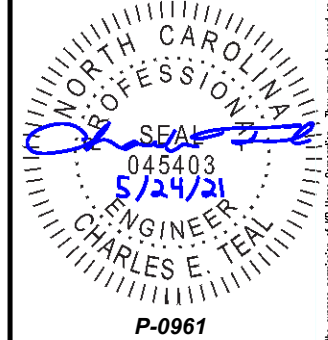

P-0961

JDS Consulting, PLLC HAS PERFORMED A STRUCTURAL REVIEW OF THESE PLANS. THE STRUCTURAL COMPONENTS COMPLY WITH THE 2018 NORTH CAROLINA RESIDENTIAL CODE FOR ONE- AND TWO-FAMILY DWELLINGS FOR NC PLAN REVIEW. DEVIATION OF ANY STRUCTURAL REQUIREMENTS OF THESE PLANS WITHOUT THE APPROVAL OF THE EOR IS PROHIBITED.



PROJECT NO.: 21901127
DATE: 05/21/2021

PLAN:
238.2338

STEM WALL
FOUNDATION PLAN
S.20B

These designs and drawings are CONFIDENTIAL, and the exclusive property of KB Home Corporation and are not to be disclosed without the express permission of KB Home Corporation. Copyright 2019 © KB Home Corporation. All rights reserved.

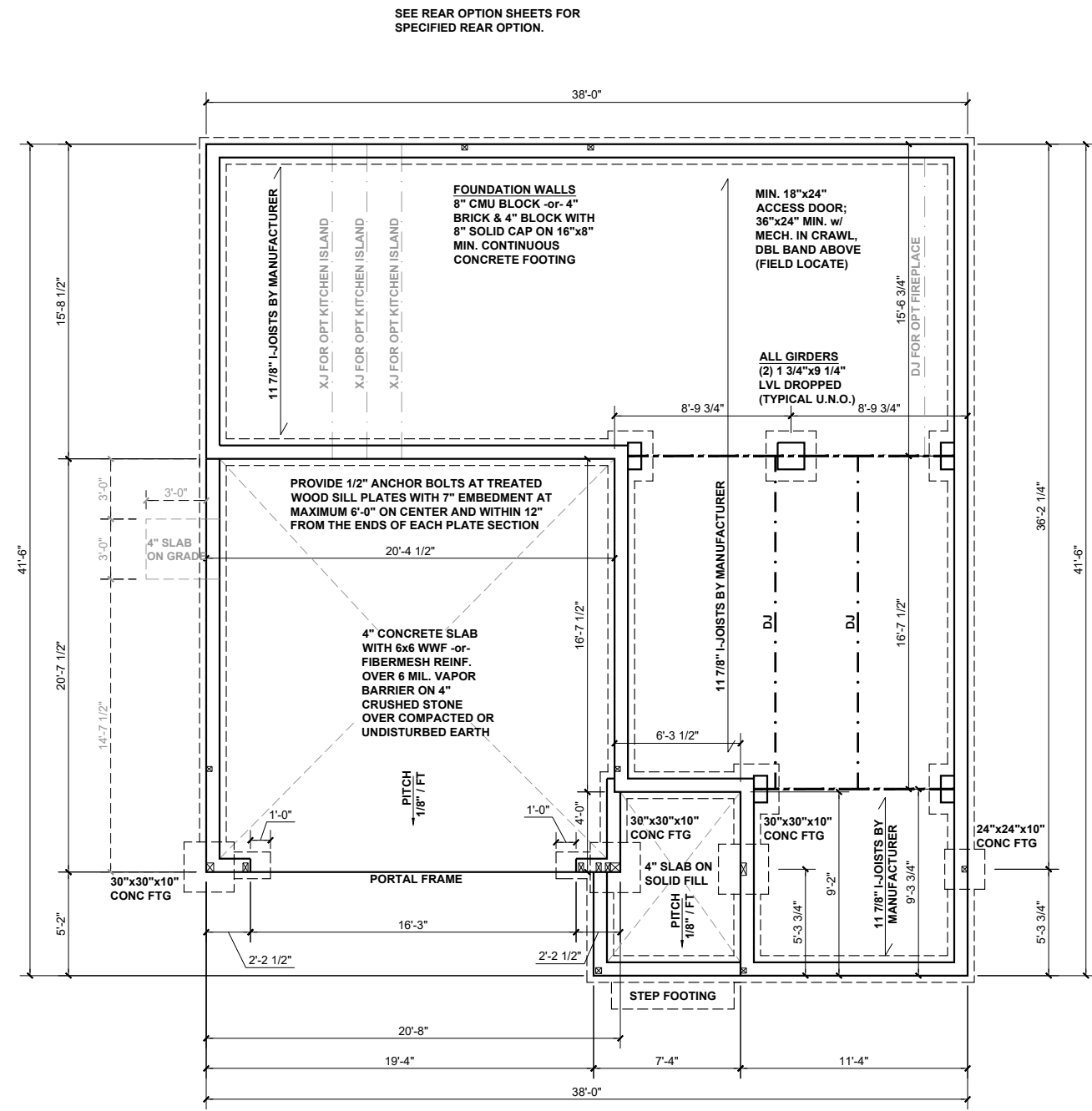

CRAWL SPACE FOUNDATION PLAN - 'B'

SCALE: 1/8"=1'-0"

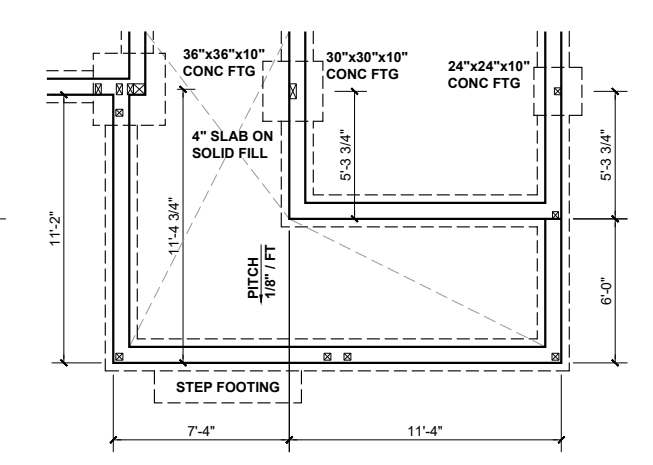
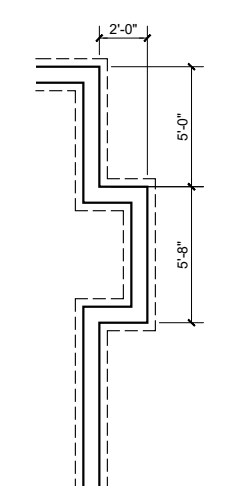

BEAM & POINT LOAD LEGEND

- INTERIOR LOAD BEARING WALL
- ROOF RAFTER / TRUSS SUPPORT
- DOUBLE RAFTER / DOUBLE JOIST
- STRUCTURAL BEAM / GIRDER
- WINDOW / DOOR HEADER
- POINT LOAD TRANSFER
- POINT LOAD FROM ABOVE BEARING ON BEAM / GIRDER

FOUNDATION STRUCTURAL NOTES:

1. CONCRETE BLOCK PIER SIZE SHALL BE:

SIZE	HOLLOW MASONRY	SOLID MASONRY
8x16	UP TO 32" HIGH	UP TO 5'-0" HIGH
12x16	UP TO 48" HIGH	UP TO 9'-0" HIGH
16x16	UP TO 64" HIGH	UP TO 12'-0" HIGH
24x24	UP TO 96" HIGH	

WITH 30" x 30" x 10" CONCRETE FOOTING, UNO.

- FLOOR FRAMING TO BE 11 7/8" DEEP TJI 210 SERIES OR EQUAL, 19.2" OC MAXIMUM SPACING
- **REFER TO I-JOIST EQUIVALENCE CHART ON I-JOIST DETAIL SHEET FOR SUBSTITUTION OF MANUFACTURER SERIES
- I-JOIST SPACING NOT TO EXCEED 19.2" OC IN LOCATIONS WITH TILE FINISH FLOOR
- 8"x16" PIERS AT FOUNDATION WALL SUPPORTING DROPPED GIRDER TO HAVE A 30"x10"x8" FOOTING PROJECTION FROM THE MAIN WALL FOOTING.
- (1) #5 REBAR @ CENTER OF ALL PERIMETER FOOTINGS. (2" C.C. MIN)



KB HOME
NORTH CAROLINA DIVISION
4518 S. MIAMI BLVD.
SUITE 180
DURHAM, NC 27703
TEL: (919) 768-7988
FAX: (919) 472-0582

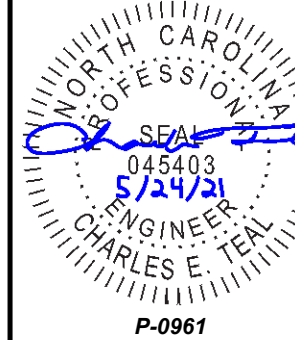

P-0961

JDS Consulting, PLLC HAS PERFORMED A STRUCTURAL REVIEW OF THESE PLANS. THE STRUCTURAL COMPONENTS COMPLY WITH THE 2018 NORTH CAROLINA RESIDENTIAL CODE FOR ONE- AND TWO-FAMILY DWELLINGS FOR NC PLAN REVIEW. DEVIATION OF ANY STRUCTURAL REQUIREMENTS OF THESE PLANS WITHOUT THE APPROVAL OF THE EOR IS PROHIBITED.



PROJECT NO.: 21901127
DATE: 05/21/2021

PLAN:
238.2338

CRAWL SPACE
FOUNDATION PLAN

S.30B

These designs and drawings are CONFIDENTIAL, and the exclusive property of KB Home Corporation and are not to be disclosed without the express permission of KB Home Corporation. Copyright © 2019 KB Home Corporation, all rights reserved.



KB HOME
NORTH CAROLINA DIVISION
4518 S. MIAMI BLVD.
SUITE 180
DURHAM, NC 27703
TEL: (919) 768-7988
FAX: (919) 472-0582



P-0961

JDS Consulting, PLLC HAS PERFORMED A STRUCTURAL REVIEW OF THESE PLANS. THE STRUCTURAL COMPONENTS COMPLY WITH THE 2018 NORTH CAROLINA RESIDENTIAL CODE FOR ONE- AND TWO-FAMILY DWELLINGS FOR NC PLAN REVIEW. DEVIATION OF ANY STRUCTURAL REQUIREMENTS OF THESE PLANS WITHOUT THE APPROVAL OF THE EOR IS PROHIBITED.



8600 D' JERSEY CT, RALEIGH, NC 27617-919-480-1075
INFO@JDSCONSULTING.NET | WWW.JDSCONSULTING.NET

PROJECT NO.: 21901127

DATE: 05/21/2021

PLAN:
238.2338

FIRST FLOOR
CEILING FRAMING PLAN

S1.0B

BEAM & POINT LOAD LEGEND	
	INTERIOR LOAD BEARING WALL
	ROOF RAFTER / TRUSS SUPPORT
	DOUBLE RAFTER / DOUBLE JOIST
	STRUCTURAL BEAM / GIRDER
	WINDOW / DOOR HEADER
	POINT LOAD TRANSFER
	POINT LOAD FROM ABOVE BEARING ON BEAM / GIRDER

- STRUCTURAL FRAMING NOTES - (SEE GENERAL NOTES SHEET FOR ADDITIONAL REQUIREMENTS.)**
- ALL FRAMING TO BE #2 SPF MINIMUM.
 - ALL BEARING HEADERS TO BE (2) 2x6 SUPPORTED w/ MIN (1) JACK AND (1) KING EACH END, UNO.
 - EXTERIOR WALL OPENINGS OVER 3' TO HAVE MULTIPLE KING STUDS AS NOTED ON PLAN.
 - ALL NON-BEARING HEADERS TO BE (2) 2x4 (1) J / (1) K, UNO.
 - PROVIDE CONTINUOUS BLOCKING THROUGH STRUCTURE FOR ALL POINT LOADS.
 - ALL HANGERS AND CONNECTORS SPECIFIED ARE TO BE SIMPSON STRONG-TIE OR EQUIVALENT.
 - ALL BEAMS SPECIFIED ARE MINIMUM SIZES ONLY. LARGER MEMBERS MAY SUBSTITUTED AS NEEDED FOR EASE OF CONSTRUCTION. MINIMUM BEAM SUPPORT IS (1) 2x4 STUD.
 - ALL EXTERIOR WALLS TO BE FULLY SHEATHED WITH 7/16" OSB.
 - FRONT PORCH COLUMNS TO BE MIN 4x4 PT ATTACHED AT TOP AND BOTTOM USING SIMPSON (OR EQUIV) COLUMN BASE OR SST A24 BRACKETS. TRIM OUT PER BUILDER.
 - PORCH COLUMNS TO BE MIN 4x4 PT ATTACHED AT BOTTOM USING SIMPSON (OR EQUIV) ABA44 AND AT TOP USING CS 16 STRAPPING (12" MIN) TO PORCH HEADER / BAND.
 - WHEN A 4-PLY LVL IS USED, ATTACH WITH (1) 1/2" Ø BOLT 12" OC STAGGERED, TOP AND BOTTOM, 1-1/2" MIN FROM ENDS. ALTERNATE ATTACHMENT EQUIVALENT METHOD MAY BE USED, SUCH AS SDW OR TRUSSLOK SCREWS (SEE MANUFACTURER'S SPECIFICATIONS).
 - FOR STUD COLUMNS OF 4 OR MORE, INSTALL SST CS16 STRAPS @ 30" OC, 6" MAX FROM PLATES, ON INSIDE FACE OF COLUMN (EXTERIOR WALL), ON BOTH FACES OF COLUMN (INTERIOR WALL).

I-JOIST SPACING NOT TO EXCEED 19.2" OC IN LOCATIONS WITH TILE FINISH FLOOR

ALL FLUSH BEAMS TO BE DIRECTLY SUPPORTED BY (2) 2X STUDS UNLESS OTHERWISE NOTED. STUD COLUMNS TO BE SUPPORTED BY SOLID BLOCKING TO FOUNDATION OR TO BEARING COMPONENT BELOW.

FLOOR FRAMING TO BE 14" DEEP TJI 210 SERIES OR EQUAL, 19.2" OC MAXIMUM SPACING, U.N.O.

**REFER TO I-JOIST EQUIVALENCE CHART ON I-JOIST DETAIL SHEET FOR SUBSTITUTION OF MANUFACTURER SERIES

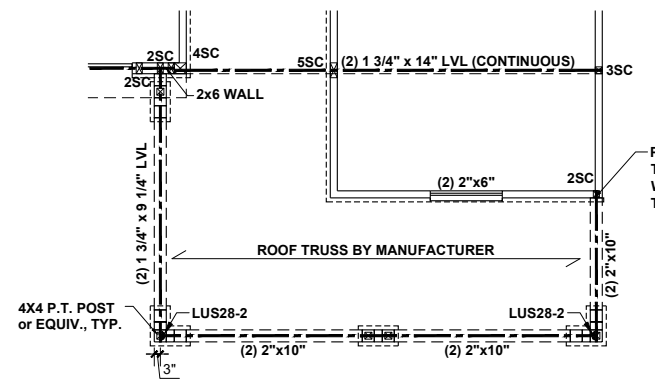
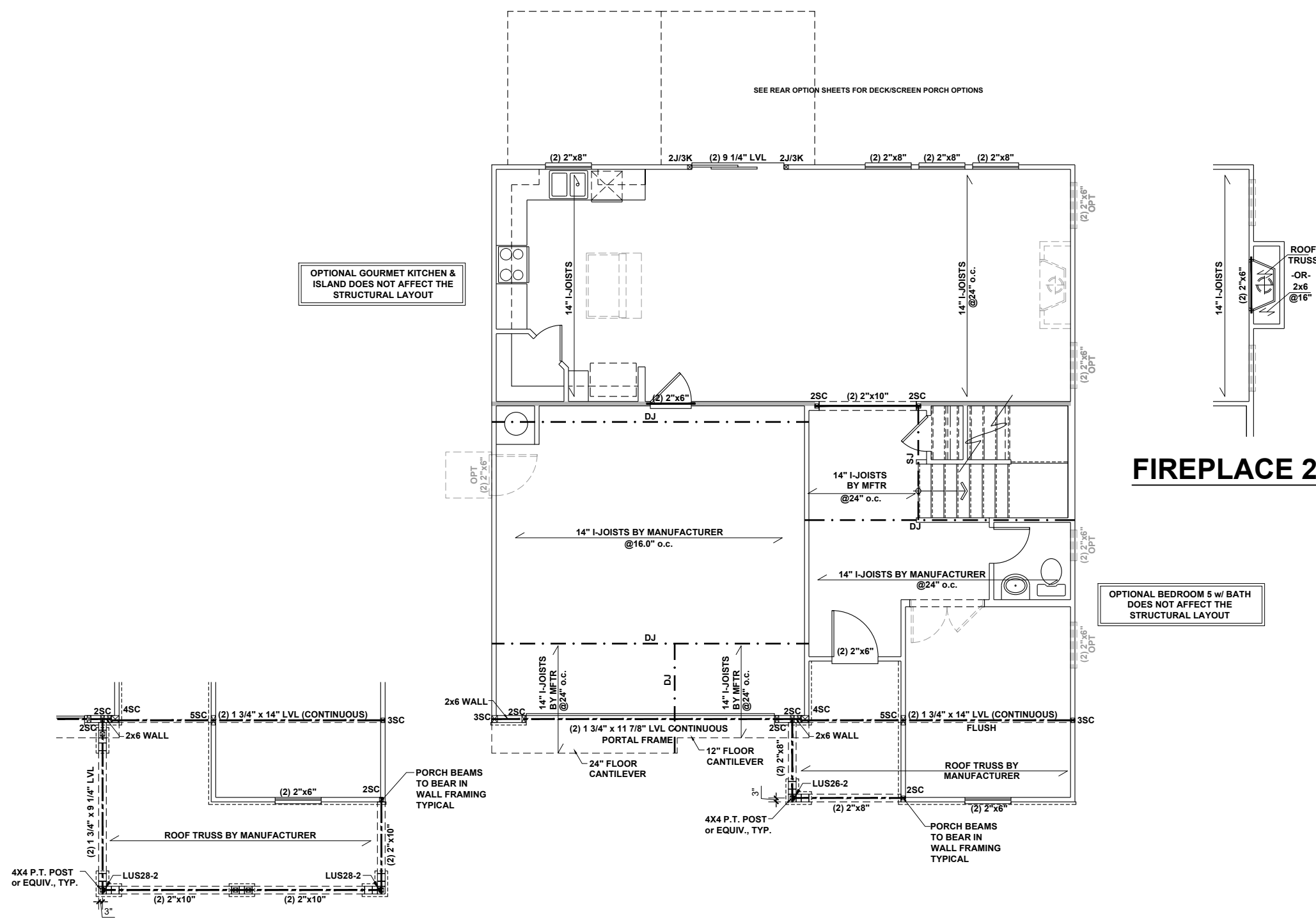

ENLARGED PORCH OPTION

FIRST FLOOR CEILING FRAMING PLAN - 'B'

SCALE: 1/8"=1'-0"

These design and drawings are CONFIDENTIAL, and the exclusive property of KB Home Corporation and are not to be disclosed without the express permission of KB Home Corporation. Copyright © 2019 KB Home Corporation, all rights reserved.



KB HOME
NORTH CAROLINA DIVISION
4518 S. MIAMI BLVD.
SUITE 180
DURHAM, NC 27703
TEL: (919) 768-7988
FAX: (919) 472-0582

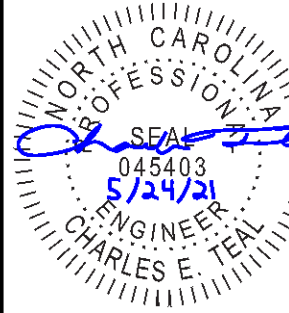

P-0961

JDS Consulting, PLLC HAS PERFORMED A STRUCTURAL REVIEW OF THESE PLANS. THE STRUCTURAL COMPONENTS COMPLY WITH THE 2018 NORTH CAROLINA RESIDENTIAL CODE FOR ONE- AND TWO-FAMILY DWELLINGS FOR NC PLAN REVIEW. DEVIATION OF ANY STRUCTURAL REQUIREMENTS OF THESE PLANS WITHOUT THE APPROVAL OF THE EOR IS PROHIBITED.



8600 D' JERSEY CT, RALEIGH, NC 27617-919-480-1075
INFO@JDSCONSULTING.NET | WWW.JDSCONSULTING.NET

PROJECT NO.: 21901127

DATE: 05/21/2021

PLAN:
238.2338

SECOND FLOOR
CEILING FRAMING PLAN

S2.0B

BEAM & POINT LOAD LEGEND	
	INTERIOR LOAD BEARING WALL
	ROOF RAFTER / TRUSS SUPPORT
	DOUBLE RAFTER / DOUBLE JOIST
	STRUCTURAL BEAM / GIRDER
	WINDOW / DOOR HEADER
	POINT LOAD TRANSFER
	POINT LOAD FROM ABOVE BEARING ON BEAM / GIRDER

- STRUCTURAL FRAMING NOTES - (SEE GENERAL NOTES SHEET FOR ADDITIONAL REQUIREMENTS.)**
- ALL FRAMING TO BE #2 SPF MINIMUM.
 - ALL BEARING HEADERS TO BE (2) 2x6 SUPPORTED w/ MIN (1) JACK AND (1) KING EACH END, UNO.
 - EXTERIOR WALL OPENINGS OVER 3' TO HAVE MULTIPLE KING STUDS AS NOTED ON PLAN.
 - ALL NON-BEARING HEADERS TO BE (2) 2x4 (1) J / (1) K, UNO.
 - PROVIDE CONTINUOUS BLOCKING THROUGH STRUCTURE FOR ALL POINT LOADS.
 - ALL HANGERS AND CONNECTORS SPECIFIED ARE TO BE SIMPSON STRONG-TIE OR EQUIVALENT.
 - ALL BEAMS SPECIFIED ARE MINIMUM SIZES ONLY. LARGER MEMBERS MAY SUBSTITUTED AS NEEDED FOR EASE OF CONSTRUCTION. MINIMUM BEAM SUPPORT IS (1) 2x4 STUD.
 - ALL EXTERIOR WALLS TO BE FULLY SHEATHED WITH 7/16" OSB.
 - FRONT PORCH COLUMNS TO BE MIN 4x4 PT ATTACHED AT TOP AND BOTTOM USING SIMPSON (OR EQUIV) COLUMN BASE OR SST A24 BRACKETS. TRIM OUT PER BUILDER.
 - PORCH COLUMNS TO BE MIN 4x4 PT ATTACHED AT BOTTOM USING SIMPSON (OR EQUIV) ABA44 AND AT TOP USING CS 16 STRAPPING (12" MIN) TO PORCH HEADER / BAND.
 - WHEN A 4-PLY LVL IS USED, ATTACH WITH (1) 1/2" Ø BOLT 12" OC STAGGERED, TOP AND BOTTOM, 1-1/2" MIN FROM ENDS. ALTERNATE ATTACHMENT EQUIVALENT METHOD MAY BE USED, SUCH AS SDW OR TRUSSLOK SCREWS (SEE MANUFACTURER'S SPECIFICATIONS).
 - FOR STUD COLUMNS OF 4 OR MORE, INSTALL SST CS16 STRAPS @ 30" OC, 6" MAX FROM PLATES, ON INSIDE FACE OF COLUMN (EXTERIOR WALL), ON BOTH FACES OF COLUMN (INTERIOR WALL).

ALL FLUSH BEAMS TO BE DIRECTLY SUPPORTED BY (2) 2X STUDS UNLESS OTHERWISE NOTED. STUD COLUMNS TO BE SUPPORTED BY SOLID BLOCKING TO FOUNDATION OR TO BEARING COMPONENT BELOW.

MASTER BATH OPTIONS DO NOT AFFECT THE STRUCTURAL LAYOUT

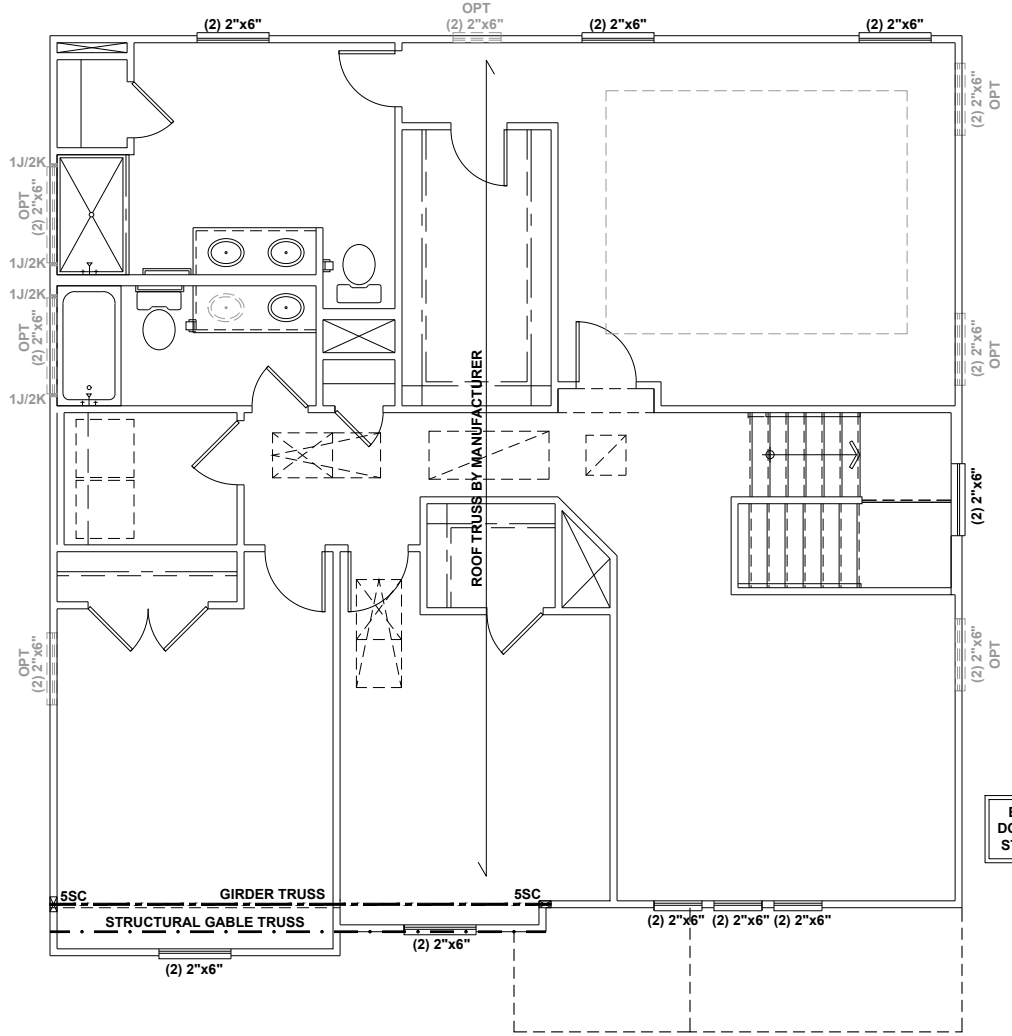

BEDROOM 4 OPTION DOES NOT AFFECT THE STRUCTURAL LAYOUT

SECOND FLOOR CEILING FRAMING PLAN - 'B'

SCALE: 1/8"=1'-0"

These designs and drawings are CONFIDENTIAL, and the exclusive property of KB Home Corporation and are not to be disclosed without the express permission of KB Home Corporation. Copyright © 2019 KB Home Corporation, all rights reserved.

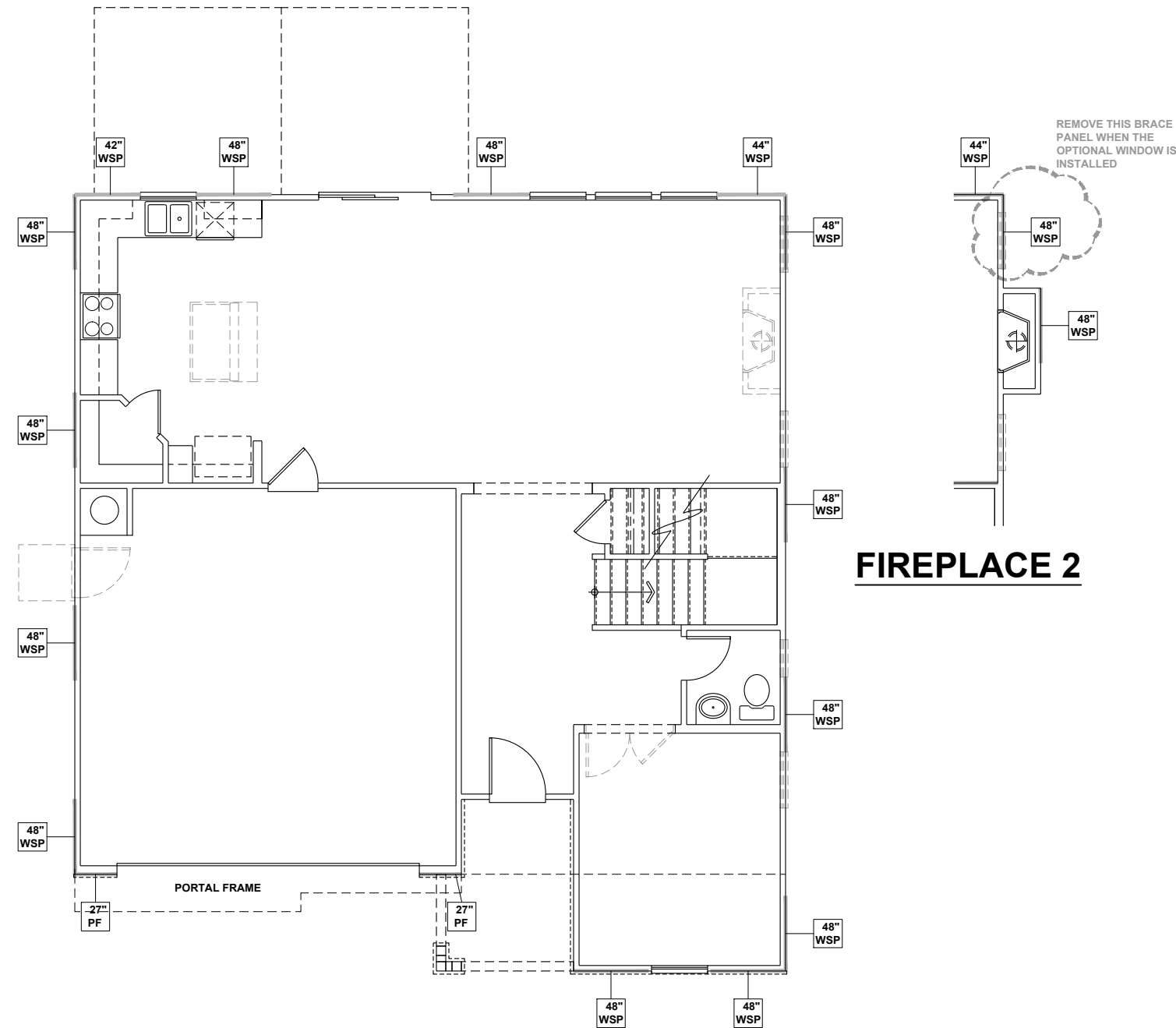

WALL BRACING REQUIREMENTS

- MINIMUM PANEL WIDTH IS 24"
- FIGURES BASED ON THE CONTINUOUS SHEATHING METHOD USING THE RECTANGLE CIRCUMSCRIBED AROUND THE FLOOR PLAN OR PORTION OF THE FLOOR PLAN. IF NO RECTANGLE IS NOTED, THE STRUCTURE HAS BEEN FIGURED ALL WITHIN ONE RECTANGLE.
- PANELS MAY SHIFT UP TO 36" EITHER DIRECTION FOR EASE OF CONSTRUCTION (NAILING & BLOCK REQUIREMENTS STILL APPLY).
- FOR ADDITIONAL WALL BRACING INFORMATION, REFER TO WALL BRACING DETAIL SHEET(S).
- SCHEMATIC BELOW INDICATES HOW SIDES OF RECTANGLE ARE TO BE INTERPRETED IN BRACING CHART WHEN APPLIED TO STRUCTURE:

- ◆ CS16 STRAP FROM STUD, CROSS HEADER, TO WALL TOP PLATE, 36" LONG MINIMUM
- ▶ SIMPSON MSTA15 HOLD DOWN CAPACITY OF 970 POUNDS PER ANCHOR WITH (12) 10d NAILS. STRAP TO BE LOCATED AT EDGE OF BRACED WALL PANEL. (CS16 STRAPPING MAY BE SUBSTITUTED w/ SIMILAR LENGTH AND NAILING PATTERN.) USE HTT4 FOR ATTACHMENT TO CONCRETE.

SCALED LENGTH OF WALL PANEL AT LOCATION: 24" WSP, NUMERICAL LENGTH OF PANEL, PANEL TYPE

ENGINEERED WALL SCHEDULE

ENG1: CONTINUOUSLY SHEATH WITH 7/16" OSB ATTACHED WITH 8d NAILS @ 6" OC EDGE AND 12" OC FIELD. FULLY BLOCKED AT ALL PANEL EDGES.

ENG2: CONTINUOUSLY SHEATH WITH 7/16" OSB WITH 10d NAILS @ 3" OC EDGE AND 3" OC FIELD. FULLY BLOCKED AT ALL PANEL EDGES.

ENG3: CONTINUOUSLY SHEATH 7/16" OSB ATTACHED BOTH SIDES WITH 8d NAILS @ 4" OC EDGE AND 8" OC FIELD. FULLY BLOCKED AT ALL PANEL EDGES.

ENG4: CONTINUOUSLY SHEATH 7/16" OSB ATTACHED WITH 8d NAILS @ 4" OC EDGE AND 8" OC FIELD. FULLY BLOCKED AT ALL PANEL EDGES.

WALL BRACING NOTE:

WALLS WITH PROVIDED LENGTH LISTED AS "N/A" DO NOT MEET THE REQUIREMENTS OF PRESCRIPTIVE WALL BRACING FOUND IN THE NCRC. THESE WALLS HAVE BEEN ENGINEERED BASED ON DESIGN GUIDELINES ESTABLISHED IN ASCE-07 AND THE NDS: WIND & SEISMIC PROVISIONS SUPPLEMENT.

WALL BRACING: RECTANGLE 1

SIDE	REQUIRED LENGTH	PROVIDED LENGTH
FRONT	13.5 FT.	17.0 FT.
LEFT	11.0 FT.	16.0 FT.
REAR	13.5 FT.	15.16 FT.
RIGHT	11.0 FT.	16.0 FT.



KB HOME
NORTH CAROLINA DIVISION
4518 S. MIAMI BLVD.
SUITE 180
DURHAM, NC 27703
TEL: (919) 768-7988
FAX: (919) 472-0582

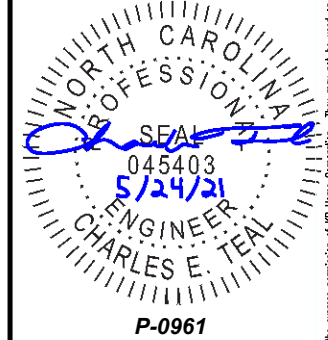

P-0961

JDS Consulting, PLLC HAS PERFORMED A STRUCTURAL REVIEW OF THESE PLANS. THE STRUCTURAL COMPONENTS COMPLY WITH THE 2018 NORTH CAROLINA RESIDENTIAL CODE FOR ONE- AND TWO-FAMILY DWELLINGS FOR NC PLAN REVIEW. DEVIATION OF ANY STRUCTURAL REQUIREMENTS OF THESE PLANS WITHOUT THE APPROVAL OF THE EOR IS PROHIBITED.

JDS Consulting
8600 D JERSEY CT, RALEIGH, NC 27617-919-480-1075
INFO@JDSCONSULTING.NET · WWW.JDSCONSULTING.NET

PROJECT NO.: 21901127
DATE: 05/21/2021

PLAN:
238.2338

FIRST FLOOR
WALL BRACING PLAN
S4.0B

FIRST FLOOR WALL BRACING PLAN - 'B'
SCALE: 1/8"=1'-0"

These designs and drawings are CONFIDENTIAL, and the exclusive property of KB Home Corporation and are not to be disclosed without the express permission of KB Home Corporation. Copyright 2019 © KB Home Corporation, all rights reserved.

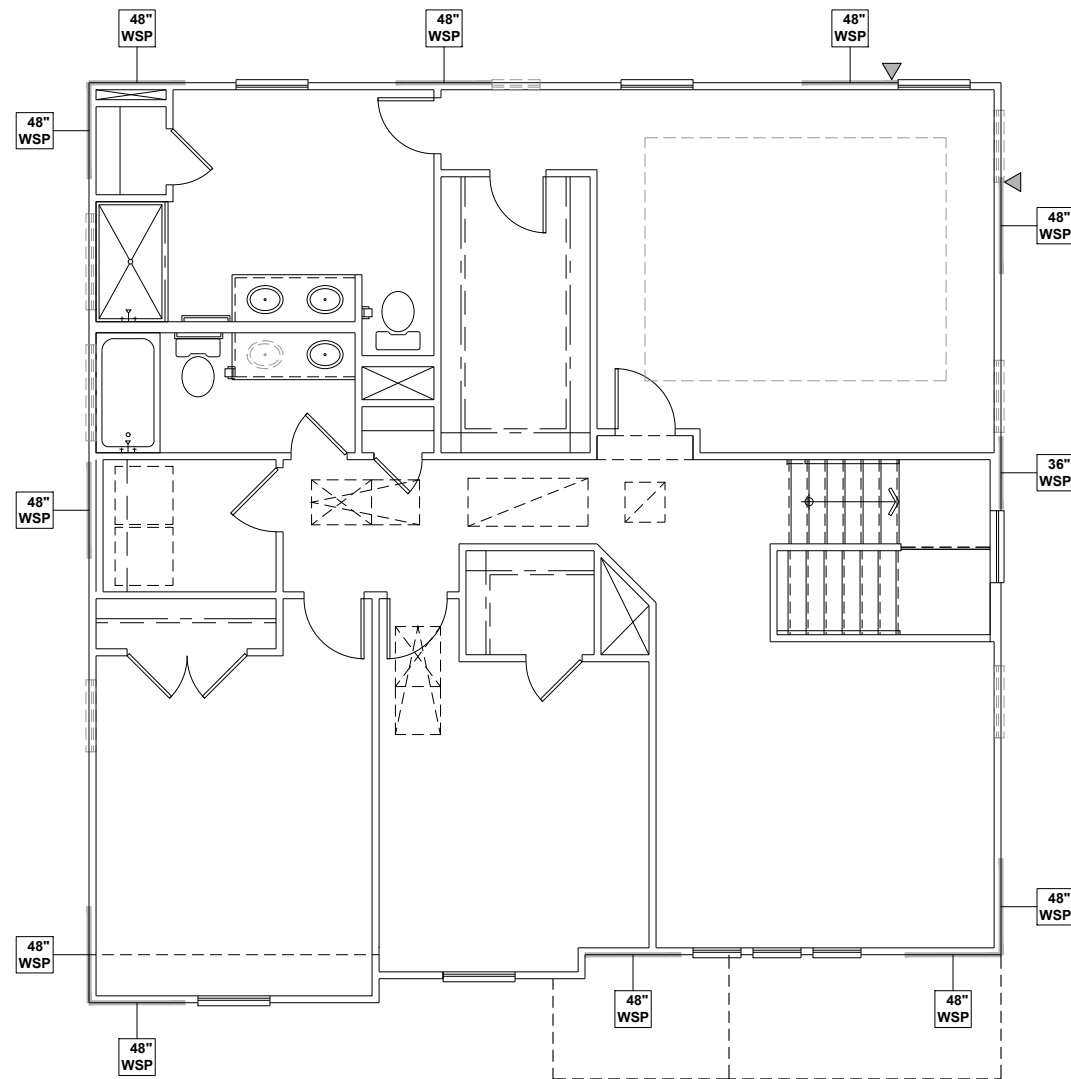

WALL BRACING REQUIREMENTS

- MINIMUM PANEL WIDTH IS 24"
- FIGURES BASED ON THE CONTINUOUS SHEATHING METHOD USING THE RECTANGLE CIRCUMSCRIBED AROUND THE FLOOR PLAN OR PORTION OF THE FLOOR PLAN. IF NO RECTANGLE IS NOTED, THE STRUCTURE HAS BEEN FIGURED ALL WITHIN ONE RECTANGLE.
- PANELS MAY SHIFT UP TO 36" EITHER DIRECTION FOR EASE OF CONSTRUCTION (NAILING & BLOCK REQUIREMENTS STILL APPLY).
- FOR ADDITIONAL WALL BRACING INFORMATION, REFER TO WALL BRACING DETAIL SHEET(S).
- SCHEMATIC BELOW INDICATES HOW SIDES OF RECTANGLE ARE TO BE INTERPRETED IN BRACING CHART WHEN APPLIED TO STRUCTURE:

- ◆ CS16 STRAP FROM STUD, CROSS HEADER, TO WALL TOP PLATE, 36" LONG MINIMUM
- ▶ SIMPSON MSTA15 HOLD DOWN CAPACITY OF 970 POUNDS PER ANCHOR WITH (12) 10d NAILS. STRAP TO BE LOCATED AT EDGE OF BRACED WALL PANEL. (CS16 STRAPPING MAY BE SUBSTITUTED w/ SIMILAR LENGTH AND NAILING PATTERN.) USE HTT4 FOR ATTACHMENT TO CONCRETE.

SCALED LENGTH OF WALL PANEL AT LOCATION

24" WSP

NUMERICAL LENGTH OF PANEL

PANEL TYPE

ENGINEERED WALL SCHEDULE

ENG1: CONTINUOUSLY SHEATH WITH 7/16" OSB ATTACHED WITH 8d NAILS @ 6" OC EDGE AND 12" OC FIELD. FULLY BLOCKED AT ALL PANEL EDGES.

ENG2: CONTINUOUSLY SHEATH WITH 7/16" OSB WITH 10d NAILS @ 3" OC EDGE AND 3" OC FIELD. FULLY BLOCKED AT ALL PANEL EDGES.

ENG3: CONTINUOUSLY SHEATH 7/16" OSB ATTACHED BOTH SIDES WITH 8d NAILS @ 4" OC EDGE AND 8" OC FIELD. FULLY BLOCKED AT ALL PANEL EDGES.

ENG4: CONTINUOUSLY SHEATH 7/16" OSB ATTACHED WITH 8d NAILS @ 4" OC EDGE AND 8" OC FIELD. FULLY BLOCKED AT ALL PANEL EDGES.

WALL BRACING NOTE:

WALLS WITH PROVIDED LENGTH LISTED AS "N/A" DO NOT MEET THE REQUIREMENTS OF PRESCRIPTIVE WALL BRACING FOUND IN THE NCRC. THESE WALLS HAVE BEEN ENGINEERED BASED ON DESIGN GUIDELINES ESTABLISHED IN ASCE-07 AND THE NDS: WIND & SEISMIC PROVISIONS SUPPLEMENT.

WALL BRACING: RECTANGLE 1

SIDE	REQUIRED LENGTH	PROVIDED LENGTH
FRONT	6.5 FT.	12.0 FT.
LEFT	5.5 FT.	12.0 FT.
REAR	6.5 FT.	12.0 FT.
RIGHT	5.5 FT.	11.0 FT.



KB HOME
NORTH CAROLINA DIVISION
4518 S. MIAMI BLVD.
SUITE 180
DURHAM, NC 27703
TEL: (919) 768-7988
FAX: (919) 472-0582

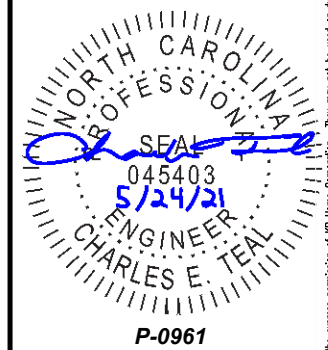

P-0961

JDS Consulting, PLLC HAS PERFORMED A STRUCTURAL REVIEW OF THESE PLANS. THE STRUCTURAL COMPONENTS COMPLY WITH THE 2018 NORTH CAROLINA RESIDENTIAL CODE FOR ONE- AND TWO-FAMILY DWELLINGS FOR NC PLAN REVIEW. DEVIATION OF ANY STRUCTURAL REQUIREMENTS OF THESE PLANS WITHOUT THE APPROVAL OF THE EOR IS PROHIBITED.

JDS Consulting
8600 D' JERSEY CT, RALEIGH, NC 27617-919-480-1075
INFO@JDSCONSULTING.NET | WWW.JDSCONSULTING.NET

PROJECT NO.: 21901127
DATE: 05/21/2021

PLAN:
238.2338

SECOND FLOOR
WALL BRACING PLAN
S5.0B

SECOND FLOOR WALL BRACING PLAN - 'B'
SCALE: 1/8"=1'-0"

These designs and drawings are CONFIDENTIAL, and the exclusive property of KB Home Corporation and are not to be disclosed without the express permission of KB Home Corporation. Copyright 2019 © KB Home Corporation, all rights reserved.

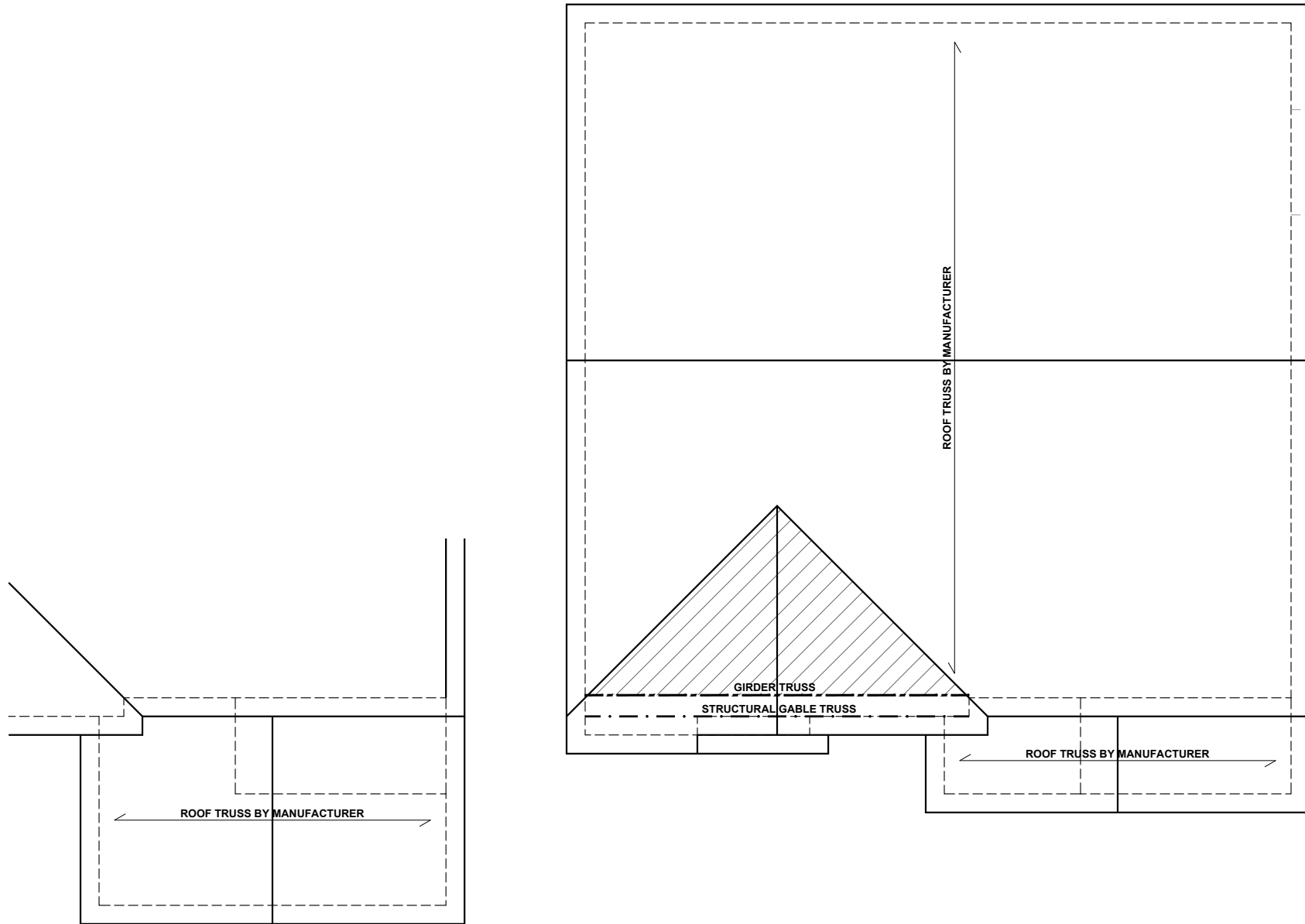

ENLARGED PORCH OPTION

OPT. FIREPLACE 2

ROOF FRAMING PLAN - 'B'

SCALE: 1/8"=1'-0"

BEAM & POINT LOAD LEGEND

	INTERIOR LOAD BEARING WALL
	ROOF RAFTER / TRUSS SUPPORT
	DOUBLE RAFTER / DOUBLE JOIST
	STRUCTURAL BEAM / GIRDER
	WINDOW / DOOR HEADER
	POINT LOAD TRANSFER
	POINT LOAD FROM ABOVE BEARING ON BEAM / GIRDER

- TRUSSED ROOF - STRUCTURAL NOTES**
1. PROVIDE CONTINUOUS BLOCKING THROUGH STRUCTURE FOR ALL POINT LOADS.
 2. DENOTES OVER-FRAMED AREA
 3. MINIMUM 7/16" OSB ROOF SHEATHING
 4. TRUSS LAYOUT AND PLACEMENT BY MANUFACTURER TO COINCIDE WITH THE SUPPORT LOCATIONS SHOWN. TRUSS PROFILES SHALL BE SEALED BY THE TRUSS MANUFACTURER. TRUSS PLANS TO BE COORDINATED WITH THE SEALED STRUCTURAL DRAWINGS. INSTALLATION SHALL BE IN ACCORDANCE WITH THE MANUFACTURER'S INSTRUCTIONS.
 5. MANUFACTURER TO PROVIDE REQUIRED UPLIFT CONNECTION.
 6. PROVIDE H2.5A (MINIMUM) OR EQUIVALENT AT EACH TRUSS-TO-TOP PLATE CONNECTION AT OVER-FRAMED AREAS, UNLESS NOTED OTHERWISE.
 7. UPLIFT CONNECTION TO BE CARRIED THROUGH TO FLOOR SYSTEM.

TRUSS UPLIFT CONNECTORS: EXPOSURE B, 115 MPH, ANY PITCH, 24" O.C. MAX ROOF TRUSS SPACING

TRUSSES SHALL BE ATTACHED TO SUPPORT WALL FOR UPLIFT RESISTANCE. CONTINUOUS OSB WALL SHEATHING BELOW PROVIDES CONTINUOUS UPLIFT RESISTANCE TO FOUNDATION. ALL TRUSSES SUPPORTED BY INTERMEDIATE SUPPORT WALLS, KNEEWALLS, OR BEAMS SHALL BE ATTACHED TO SUPPORTING MEMBER PER SCHEDULE:

ROOF SPAN IS MEASURED HORIZONTALLY BETWEEN FURTHEST SUPPORT POINTS.

ROOF PLAN UP TO 28'	CONNECTOR NAILING PER TABLE 602.3(1) NCRBC 2018 EDITION
OVER 28'	(1) SIMPSON H2.5A HURRICANE CLIP TO DBL TOP PLATE OR BEAM OR (1) SIMPSON H3 CLIP TO SINGLE 2x4 PLATE

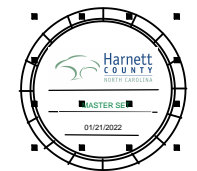

KB HOME
NORTH CAROLINA DIVISION
4518 S. MIAMI BLVD.
SUITE 180
DURHAM, NC 27703
TEL: (919) 768-7988
FAX: (919) 472-0582

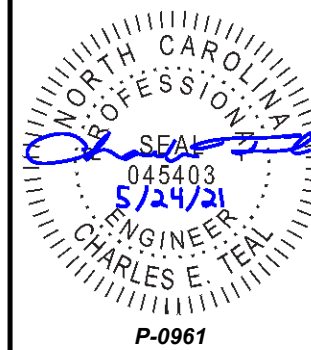

JDS Consulting, PLLC HAS PERFORMED A STRUCTURAL REVIEW OF THESE PLANS. THE STRUCTURAL COMPONENTS COMPLY WITH THE 2018 NORTH CAROLINA RESIDENTIAL CODE FOR ONE- AND TWO-FAMILY DWELLINGS FOR NC PLAN REVIEW. DEVIATION OF ANY STRUCTURAL REQUIREMENTS OF THESE PLANS WITHOUT THE APPROVAL OF THE EOR IS PROHIBITED.

JDS Consulting
8600 D' JERSEY CT, RALEIGH, NC 27617-919-480-1075
INFO@JDSCONSULTING.NET · WWW.JDSCONSULTING.NET

PROJECT NO.: 21901127
DATE: 05/21/2021

PLAN:
238.2338

ROOF FRAMING PLAN

S7.0B

These designs and drawings are CONFIDENTIAL, and the exclusive property of KB Home Corporation and are not to be disclosed without the express permission of KB Home Corporation. Copyright © 2019 KB Home Corporation. All rights reserved.

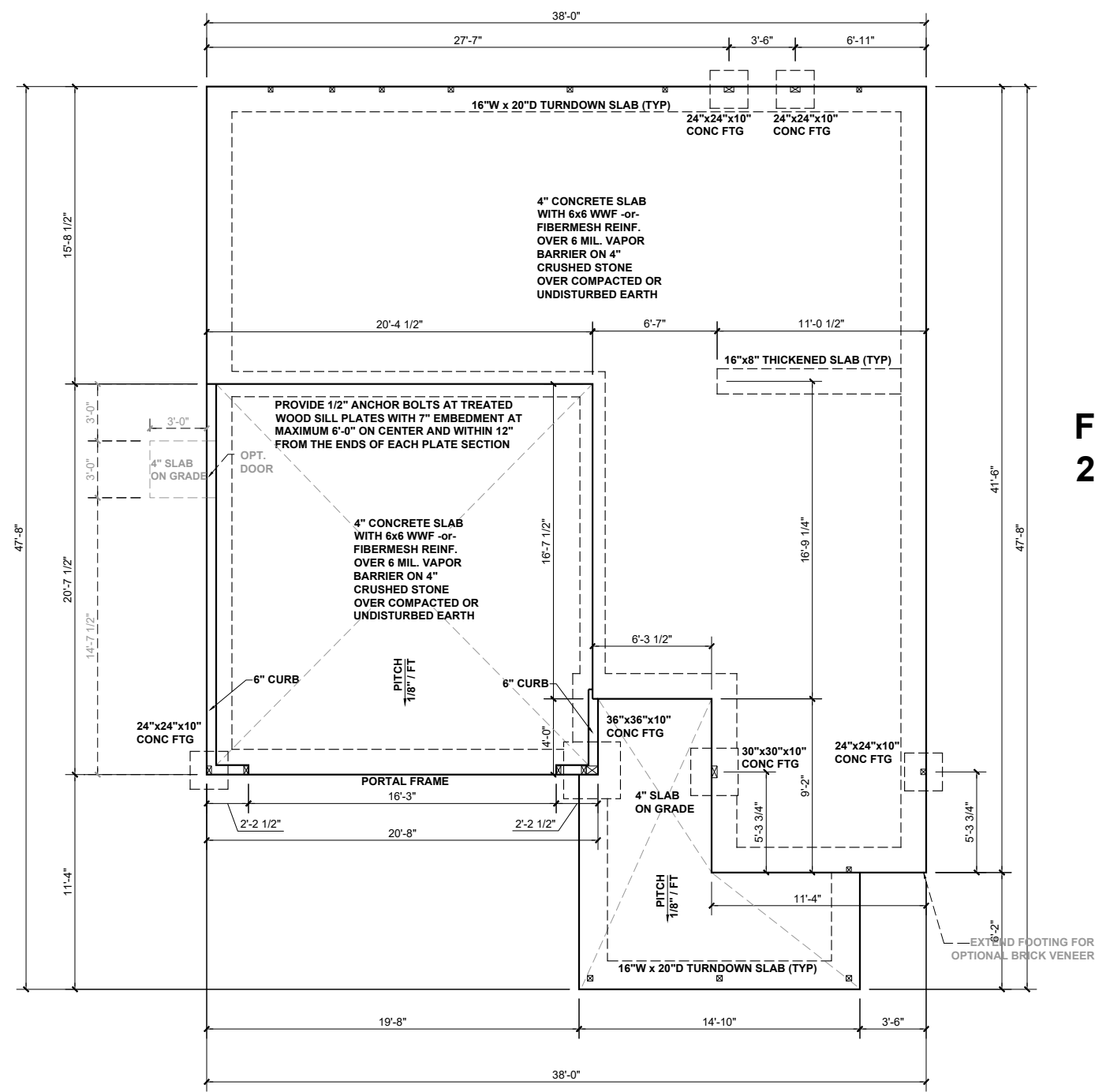

**FIREPLACE
2**

BEAM & POINT LOAD LEGEND

—	INTERIOR LOAD BEARING WALL
- - -	ROOF RAFTER / TRUSS SUPPORT
- · - · -	DOUBLE RAFTER / DOUBLE JOIST
—	STRUCTURAL BEAM / GIRDER
—	WINDOW / DOOR HEADER
⊠	POINT LOAD TRANSFER
■	POINT LOAD FROM ABOVE BEARING ON BEAM / GIRDER

(1) #5 REBAR @ CENTER OF ALL PERIMETER AND INTERNAL LOAD BEARING FOOTINGS. (2" C.C. MIN)

ALL CONCRETE CURBS SUPPORTING PORTAL FRAMED OR ENGINEERED OPENINGS IN GARAGES WITH A PONY WALL OVER 24" ABOVE THE GARAGE DOOR HEADER SHALL BE REQUIRED TO BE AT LEAST 8" WIDE.

CONCRETE SLAB REINFORCING SUBSTITUTION OF SYNTHETIC FIBER MIX IN LIEU OF WWF IN NON STRUCTURAL SLABS:

- NO SUBSTITUTION ALLOWED IN SLABS INSTALLED ON RAISED METAL DECKING
- NO SUBSTITUTION ALLOWED IN SLABS WITH GRADE BEAMS UNLESS A REBAR MAT IS INSTALLED
- NO SUBSTITUTION ALLOWED IF ANY SOILS HAVE BEEN FOUND TO BE EXPANSIVE SOILS ON SITE
- NO SUBSTITUTION ALLOWED FOR SLAB POURS DIRECTLY ON GRADE; A 4" BASE MATERIAL OF CRUSHED STONE OR WELL DRAINING CLEAN SAND IS REQUIRED FOR SUBSTITUTION
- NO SUBSTITUTION ALLOWED FOR ANY SITES WITH A DCP BLOW COUNT OF 10 OR LESS.
- FIBER MIX VOLUMES MUST BE FOLLOWED PER THE MANUFACTURERS SPECIFICATIONS



KB HOME
NORTH CAROLINA DIVISION
4518 S. MIAMI BLVD.
SUITE 180
DURHAM, NC 27703
TEL: (919) 768-7988
FAX: (919) 472-0582

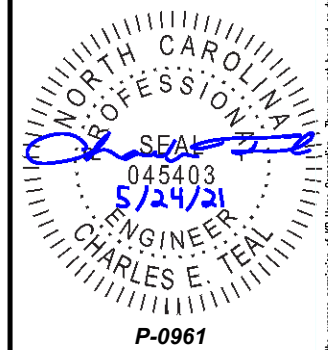

JDS Consulting, PLLC HAS PERFORMED A STRUCTURAL REVIEW OF THESE PLANS. THE STRUCTURAL COMPONENTS COMPLY WITH THE 2018 NORTH CAROLINA RESIDENTIAL CODE FOR ONE- AND TWO-FAMILY DWELLINGS FOR NC PLAN REVIEW. DEVIATION OF ANY STRUCTURAL REQUIREMENTS OF THESE PLANS WITHOUT THE APPROVAL OF THE EOR IS PROHIBITED.



PROJECT NO.: 21901127
DATE: 05/21/2021

PLAN:
238.2338

SLAB
FOUNDATION PLAN
S.10C

SLAB FOUNDATION PLAN - 'C'
SCALE: 1/8"=1'-0"

These designs and drawings are CONFIDENTIAL, and the exclusive property of KB Home Corporation and are not to be disclosed without the express permission of KB Home Corporation. Copyright 2019 © KB Home Corporation, all rights reserved.

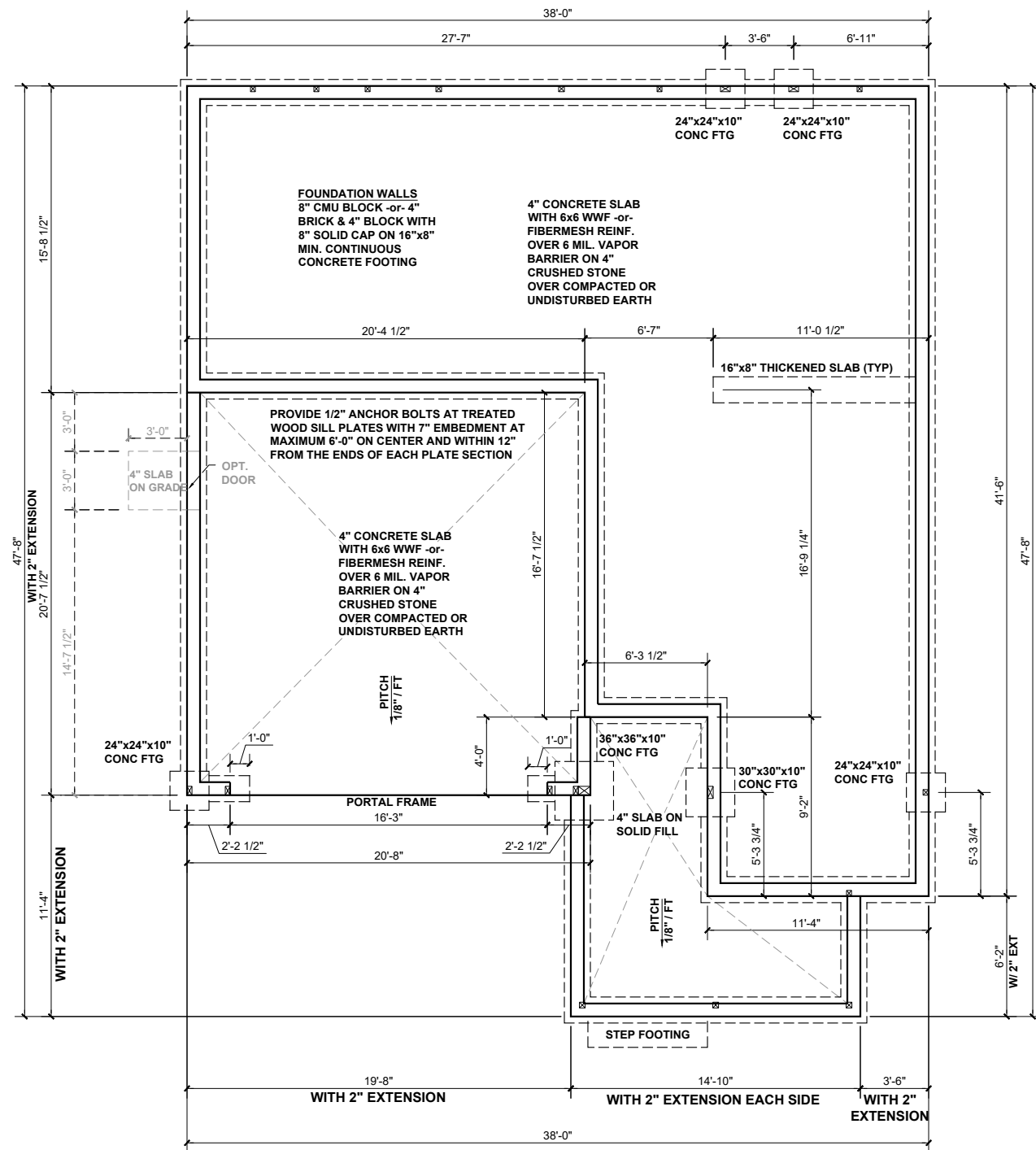

FIREPLACE 2

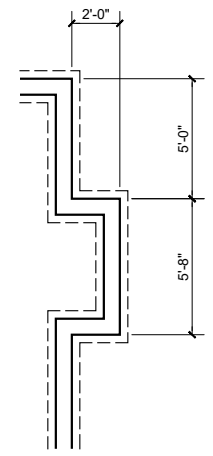

STEM WALL FOUNDATION PLAN - 'C'
SCALE: 1/8"=1'-0"

BEAM & POINT LOAD LEGEND

	INTERIOR LOAD BEARING WALL
	ROOF RAFTER / TRUSS SUPPORT
	DOUBLE RAFTER / DOUBLE JOIST
	STRUCTURAL BEAM / GIRDER
	WINDOW / DOOR HEADER
	POINT LOAD TRANSFER
	POINT LOAD FROM ABOVE BEARING ON BEAM / GIRDER

(1) #5 REBAR @ CENTER OF ALL PERIMETER AND INTERNAL LOAD BEARING FOOTINGS. (2" C.C. MIN)

ALL CONCRETE CURBS SUPPORTING PORTAL FRAMED OR ENGINEERED OPENINGS IN GARAGES WITH A PONY WALL OVER 24" ABOVE THE GARAGE DOOR HEADER SHALL BE REQUIRED TO BE AT LEAST 8" WIDE.

CONCRETE SLAB REINFORCING SUBSTITUTION OF SYNTHETIC FIBER MIX IN LIEU OF WWF IN NON STRUCTURAL SLABS:

- NO SUBSTITUTION ALLOWED IN SLABS INSTALLED ON RAISED METAL DECKING
- NO SUBSTITUTION ALLOWED IN SLABS WITH GRADE BEAMS UNLESS A REBAR MAT IS INSTALLED
- NO SUBSTITUTION ALLOWED IF ANY SOILS HAVE BEEN FOUND TO BE EXPANSIVE SOILS ON SITE
- NO SUBSTITUTION ALLOWED FOR SLAB POURS DIRECTLY ON GRADE; A 4" BASE MATERIAL OF CRUSHED STONE OR WELL DRAINING CLEAN SAND IS REQUIRED FOR SUBSTITUTION
- NO SUBSTITUTION ALLOWED FOR ANY SITES WITH A DCP BLOW COUNT OF 10 OR LESS.
- FIBER MIX VOLUMES MUST BE FOLLOWED PER THE MANUFACTURES SPECIFICATIONS



KB HOME
NORTH CAROLINA DIVISION
4518 S. MIAMI BLVD.
SUITE 180
DURHAM, NC 27703
TEL: (919) 768-7988
FAX: (919) 472-0582

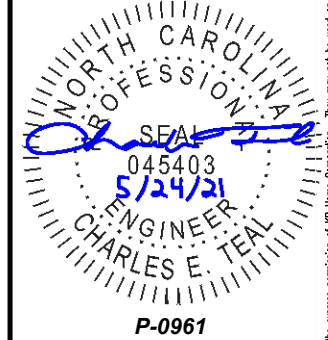

JDS Consulting, PLLC HAS PERFORMED A STRUCTURAL REVIEW OF THESE PLANS. THE STRUCTURAL COMPONENTS COMPLY WITH THE 2018 NORTH CAROLINA RESIDENTIAL CODE FOR ONE- AND TWO-FAMILY DWELLINGS FOR NC PLAN REVIEW. DEVIATION OF ANY STRUCTURAL REQUIREMENTS OF THESE PLANS WITHOUT THE APPROVAL OF THE EOR IS PROHIBITED.



PROJECT NO.: 21901127
DATE: 05/21/2021

PLAN:
238.2338

STEM WALL
FOUNDATION PLAN
S.20C

These designs and drawings are CONFIDENTIAL, and the exclusive property of KB Home Corporation and are not to be disclosed without the express permission of KB Home Corporation. Copyright 2019 © KB Home Corporation. All rights reserved.

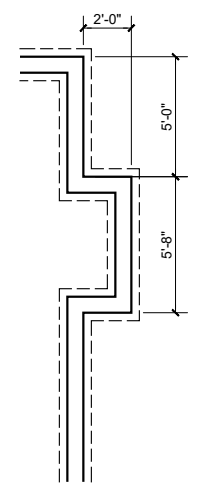
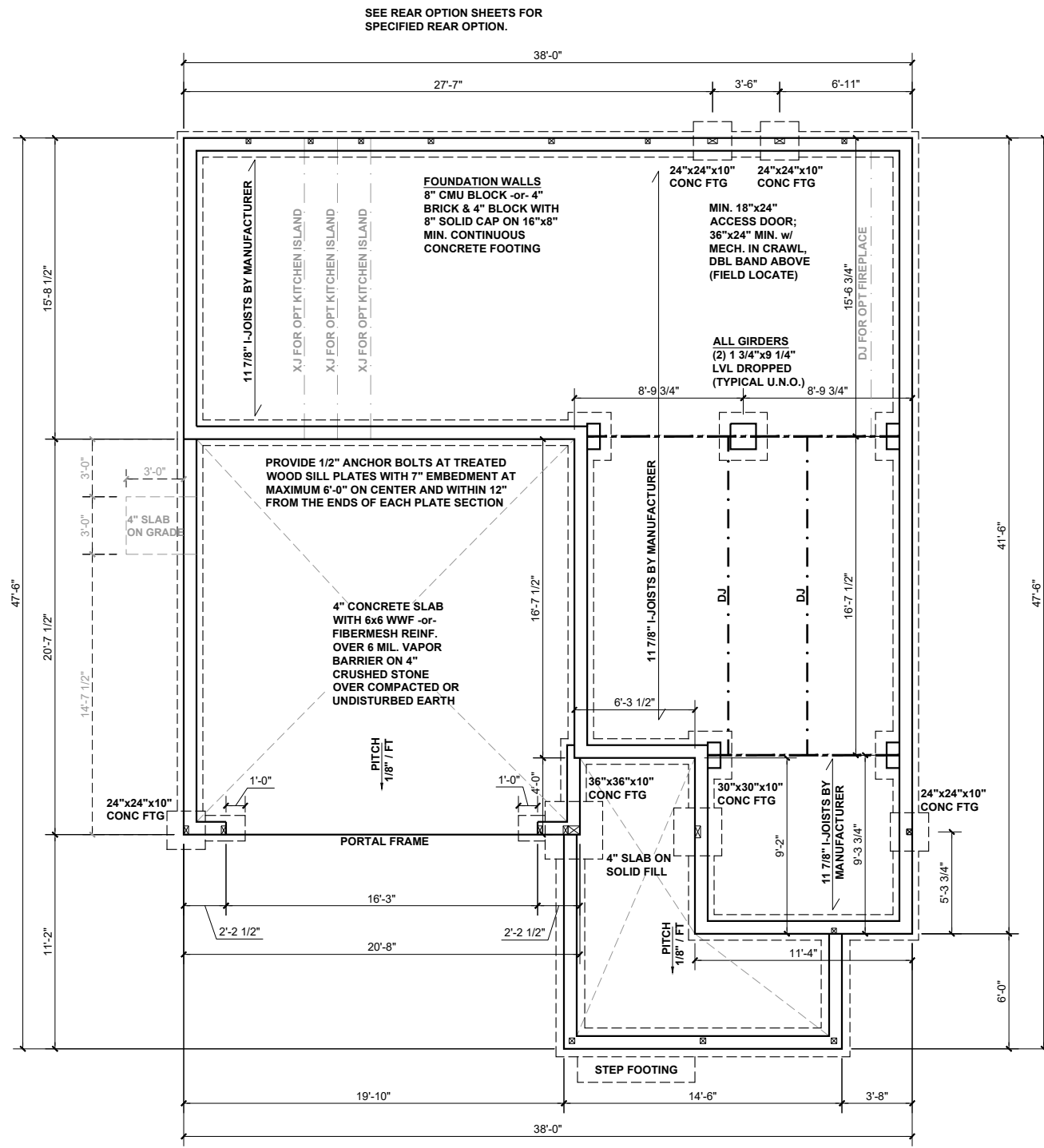

FIREPLACE 2

BEAM & POINT LOAD LEGEND

- INTERIOR LOAD BEARING WALL
- - - ROOF RAFTER / TRUSS SUPPORT
- - - - DOUBLE RAFTER / DOUBLE JOIST
- STRUCTURAL BEAM / GIRDER
- WINDOW / DOOR HEADER
- POINT LOAD TRANSFER
- POINT LOAD FROM ABOVE BEARING ON BEAM / GIRDER

FOUNDATION STRUCTURAL NOTES:

1. CONCRETE BLOCK PIER SIZE SHALL BE:

SIZE	HOLLOW MASONRY	SOLID MASONRY
8x16	UP TO 32" HIGH	UP TO 5'-0" HIGH
12x16	UP TO 48" HIGH	UP TO 9'-0" HIGH
16x16	UP TO 64" HIGH	UP TO 12'-0" HIGH
24x24	UP TO 96" HIGH	

WITH 30" x 30" x 10" CONCRETE FOOTING, UNO.

FLOOR FRAMING TO BE 11 7/8" DEEP TJI 210 SERIES OR EQUAL, 19.2" OC MAXIMUM SPACING

**REFER TO I-JOIST EQUIVALENCE CHART ON I-JOIST DETAIL SHEET FOR SUBSTITUTION OF MANUFACTURER SERIES

I-JOIST SPACING NOT TO EXCEED 19.2" OC IN LOCATIONS WITH TILE FINISH FLOOR

8"x16" PIERS AT FOUNDATION WALL SUPPORTING DROPPED GIRDER TO HAVE A 30"x10"x8" FOOTING PROJECTION FROM THE MAIN WALL FOOTING.

(1) #5 REBAR @ CENTER OF ALL PERIMETER FOOTINGS. (2" C.C. MIN)



KB HOME
NORTH CAROLINA DIVISION
4518 S. MIAMI BLVD.
SUITE 180
DURHAM, NC 27703
TEL: (919) 768-7988
FAX: (919) 472-0582

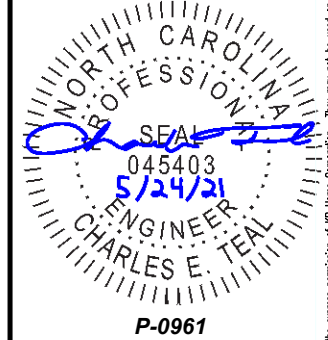

JDS Consulting, PLLC HAS PERFORMED A STRUCTURAL REVIEW OF THESE PLANS. THE STRUCTURAL COMPONENTS COMPLY WITH THE 2018 NORTH CAROLINA RESIDENTIAL CODE FOR ONE- AND TWO-FAMILY DWELLINGS FOR NC PLAN REVIEW. DEVIATION OF ANY STRUCTURAL REQUIREMENTS OF THESE PLANS WITHOUT THE APPROVAL OF THE EOR IS PROHIBITED.

JDS Consulting
8600 D' JERSEY CT, RALEIGH, NC 27617-919-480-1075
INFO@JDSCONSULTING.NET | WWW.JDSCONSULTING.NET

PROJECT NO.: 21901127
DATE: 05/21/2021

PLAN:
238.2338

CRAWL SPACE
FOUNDATION PLAN
S.30C

CRAWL SPACE FOUNDATION PLAN - 'C'
SCALE: 1/8"=1'-0"

These design and drawings are CONFIDENTIAL, and the exclusive property of KB Home Corporation and are not to be disclosed without the express permission of KB Home Corporation. Copyright 2019 © KB Home Corporation, all rights reserved.



KB HOME
NORTH CAROLINA DIVISION
4518 S. MIAMI BLVD.
SUITE 180
DURHAM, NC 27703
TEL: (919) 768-7988
FAX: (919) 472-0582

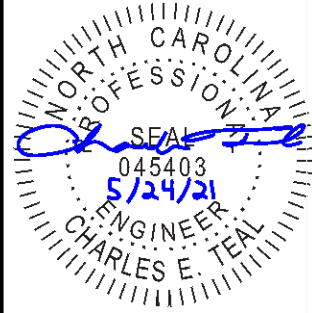

P-0961

JDS Consulting, PLLC HAS PERFORMED A STRUCTURAL REVIEW OF THESE PLANS. THE STRUCTURAL COMPONENTS COMPLY WITH THE 2018 NORTH CAROLINA RESIDENTIAL CODE FOR ONE- AND TWO-FAMILY DWELLINGS FOR NC PLAN REVIEW. DEVIATION OF ANY STRUCTURAL REQUIREMENTS OF THESE PLANS WITHOUT THE APPROVAL OF THE EOR IS PROHIBITED.



8600 D' JERSEY CT, RALEIGH, NC 27617-919-480-1075
INFO@JDSCONSULTING.NET | WWW.JDSCONSULTING.NET

PROJECT NO.: 21901127
DATE: 05/21/2021

PLAN:
238.2338

SECOND FLOOR
CEILING FRAMING PLAN

S2.0C

BEAM & POINT LOAD LEGEND	
	INTERIOR LOAD BEARING WALL
	ROOF RAFTER / TRUSS SUPPORT
	DOUBLE RAFTER / DOUBLE JOIST
	STRUCTURAL BEAM / GIRDER
	WINDOW / DOOR HEADER
	POINT LOAD TRANSFER
	POINT LOAD FROM ABOVE BEARING ON BEAM / GIRDER

- STRUCTURAL FRAMING NOTES - (SEE GENERAL NOTES SHEET FOR ADDITIONAL REQUIREMENTS.)**
- ALL FRAMING TO BE #2 SPF MINIMUM.
 - ALL BEARING HEADERS TO BE (2) 2x6 SUPPORTED w/ MIN (1) JACK AND (1) KING EACH END, UNO.
 - EXTERIOR WALL OPENINGS OVER 3' TO HAVE MULTIPLE KING STUDS AS NOTED ON PLAN.
 - ALL NON-BEARING HEADERS TO BE (2) 2x4 (1) J / (1) K, UNO.
 - PROVIDE CONTINUOUS BLOCKING THROUGH STRUCTURE FOR ALL POINT LOADS.
 - ALL HANGERS AND CONNECTORS SPECIFIED ARE TO BE SIMPSON STRONG-TIE OR EQUIVALENT.
 - ALL BEAMS SPECIFIED ARE MINIMUM SIZES ONLY. LARGER MEMBERS MAY SUBSTITUTED AS NEEDED FOR EASE OF CONSTRUCTION. MINIMUM BEAM SUPPORT IS (1) 2x4 STUD.
 - ALL EXTERIOR WALLS TO BE FULLY SHEATHED WITH 7/16" OSB.
 - FRONT PORCH COLUMNS TO BE MIN 4x4 PT ATTACHED AT TOP AND BOTTOM USING SIMPSON (OR EQUIV) COLUMN BASE OR SST A24 BRACKETS. TRIM OUT PER BUILDER.
 - PORCH COLUMNS TO BE MIN 4x4 PT ATTACHED AT BOTTOM USING SIMPSON (OR EQUIV) ABA44 AND AT TOP USING CS 16 STRAPPING (12" MIN) TO PORCH HEADER / BAND.
 - WHEN A 4-PLY LVL IS USED, ATTACH WITH (1) 1/2" Ø BOLT 12" OC STAGGERED, TOP AND BOTTOM, 1-1/2" MIN FROM ENDS. ALTERNATE ATTACHMENT EQUIVALENT METHOD MAY BE USED, SUCH AS SDW OR TRUSSEK SCREWS (SEE MANUFACTURER'S SPECIFICATIONS).
 - FOR STUD COLUMNS OF 4 OR MORE, INSTALL SST CS16 STRAPS @ 30" OC, 6" MAX FROM PLATES, ON INSIDE FACE OF COLUMN (EXTERIOR WALL), ON BOTH FACES OF COLUMN (INTERIOR WALL).

ALL FLUSH BEAMS TO BE DIRECTLY SUPPORTED BY (2) 2x STUDS UNLESS OTHERWISE NOTED. STUD COLUMNS TO BE SUPPORTED BY SOLID BLOCKING TO FOUNDATION OR TO BEARING COMPONENT BELOW.

MASTER BATH OPTIONS DO NOT AFFECT THE STRUCTURAL LAYOUT

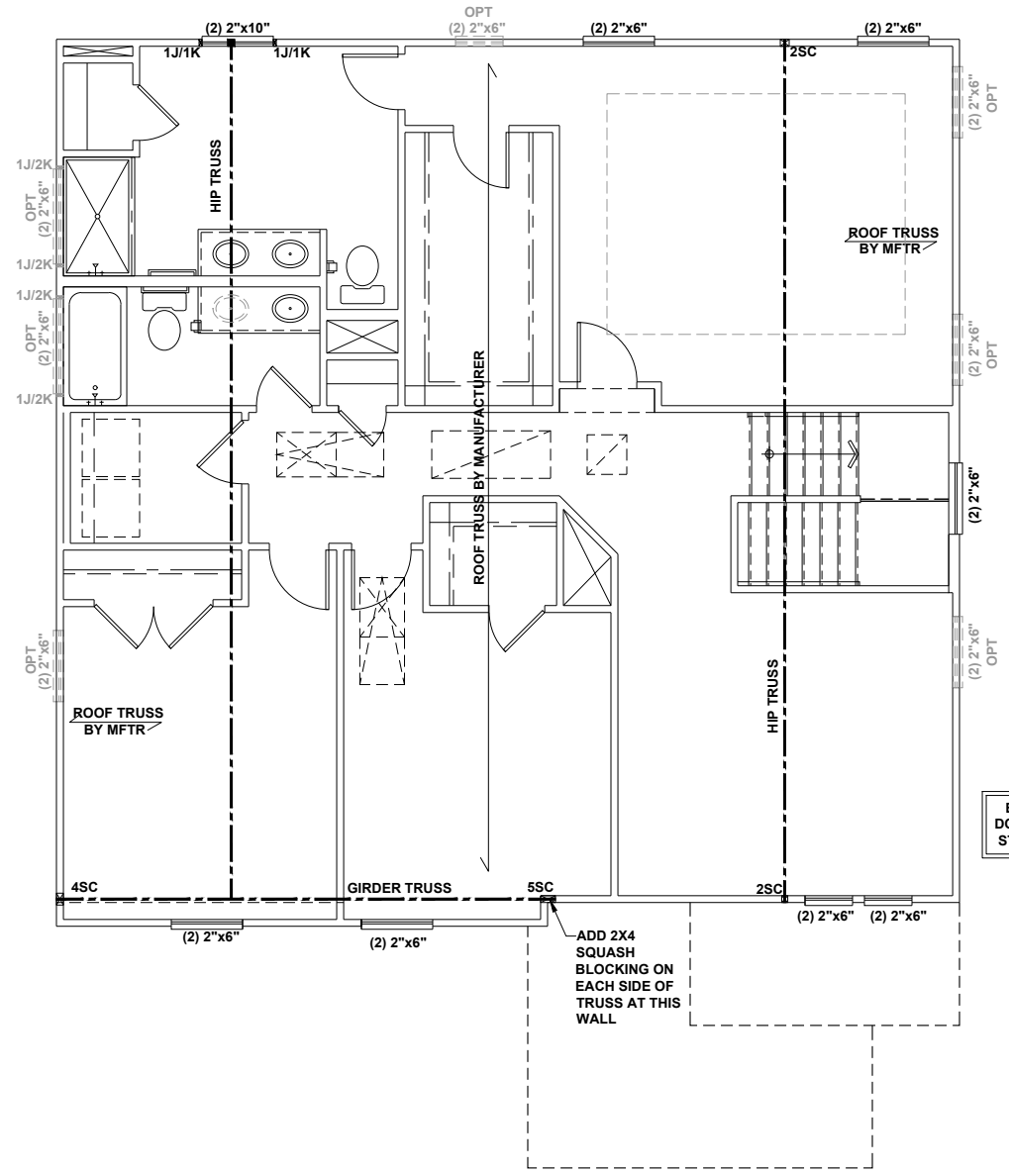

SECOND FLOOR CEILING FRAMING PLAN - 'C'

SCALE: 1/8"=1'-0"

These designs and drawings are CONFIDENTIAL, and the exclusive property of KB Home Corporation and are not to be disclosed without the express permission of KB Home Corporation. Copyright 2019 © KB Home Corporation, all rights reserved.

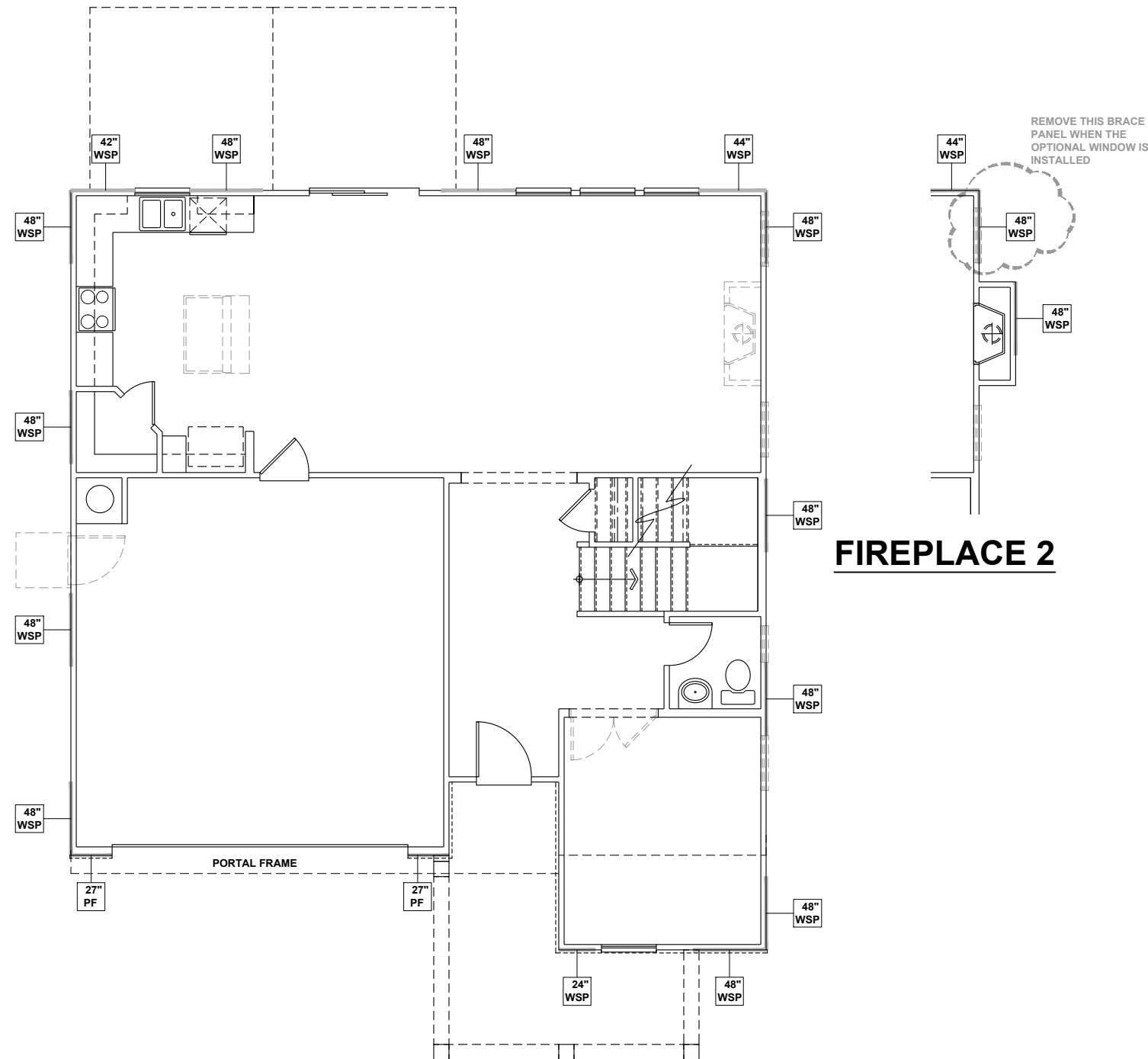

WALL BRACING REQUIREMENTS

- MINIMUM PANEL WIDTH IS 24"
- FIGURES BASED ON THE CONTINUOUS SHEATHING METHOD USING THE RECTANGLE CIRCUMSCRIBED AROUND THE FLOOR PLAN OR PORTION OF THE FLOOR PLAN. IF NO RECTANGLE IS NOTED, THE STRUCTURE HAS BEEN FIGURED ALL WITHIN ONE RECTANGLE.
- PANELS MAY SHIFT UP TO 36" EITHER DIRECTION FOR EASE OF CONSTRUCTION (NAILING & BLOCK REQUIREMENTS STILL APPLY).
- FOR ADDITIONAL WALL BRACING INFORMATION, REFER TO WALL BRACING DETAIL SHEET(S).
- SCHEMATIC BELOW INDICATES HOW SIDES OF RECTANGLE ARE TO BE INTERPRETED IN BRACING CHART WHEN APPLIED TO STRUCTURE:

- ◆ CS16 STRAP FROM STUD, CROSS HEADER, TO WALL TOP PLATE, 36" LONG MINIMUM
- ▶ SIMPSON MSTA15 HOLD DOWN CAPACITY OF 970 POUNDS PER ANCHOR WITH (12) 10d NAILS. STRAP TO BE LOCATED AT EDGE OF BRACED WALL PANEL. (CS16 STRAPPING MAY BE SUBSTITUTED w/ SIMILAR LENGTH AND NAILING PATTERN.) USE HTT4 FOR ATTACHMENT TO CONCRETE.

SCALED LENGTH OF WALL PANEL AT LOCATION: 24" WSP

NUMERICAL LENGTH OF PANEL: 48" WSP

PANEL TYPE

ENGINEERED WALL SCHEDULE

ENG1: CONTINUOUSLY SHEATH WITH 7/16" OSB ATTACHED WITH 8d NAILS @ 6" OC EDGE AND 12" OC FIELD. FULLY BLOCKED AT ALL PANEL EDGES.

ENG2: CONTINUOUSLY SHEATH WITH 7/16" OSB WITH 10d NAILS @ 3" OC EDGE AND 3" OC FIELD. FULLY BLOCKED AT ALL PANEL EDGES.

ENG3: CONTINUOUSLY SHEATH 7/16" OSB ATTACHED BOTH SIDES WITH 8d NAILS @ 4" OC EDGE AND 8" OC FIELD. FULLY BLOCKED AT ALL PANEL EDGES.

ENG4: CONTINUOUSLY SHEATH 7/16" OSB ATTACHED WITH 8d NAILS @ 4" OC EDGE AND 8" OC FIELD. FULLY BLOCKED AT ALL PANEL EDGES.

WALL BRACING NOTE:

WALLS WITH PROVIDED LENGTH LISTED AS "N/A" DO NOT MEET THE REQUIREMENTS OF PRESCRIPTIVE WALL BRACING FOUND IN THE NCRC. THESE WALLS HAVE BEEN ENGINEERED BASED ON DESIGN GUIDELINES ESTABLISHED IN ASCE-07 AND THE NDS: WIND & SEISMIC PROVISIONS SUPPLEMENT.

WALL BRACING: RECTANGLE 1

SIDE	REQUIRED LENGTH	PROVIDED LENGTH
FRONT	13.5 FT.	15.0 FT.
LEFT	11.0 FT.	16.0 FT.
REAR	13.5 FT.	15.16 FT.
RIGHT	11.0 FT.	16.0 FT.



KB HOME
NORTH CAROLINA DIVISION
4518 S. MIAMI BLVD.
SUITE 180
DURHAM, NC 27703
TEL: (919) 768-7988
FAX: (919) 472-0582

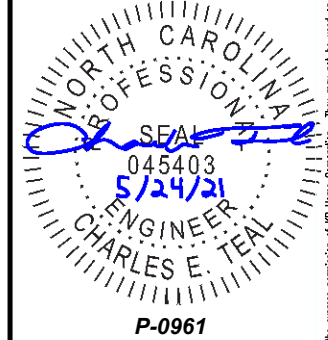

P-0961

JDS Consulting, PLLC HAS PERFORMED A STRUCTURAL REVIEW OF THESE PLANS. THE STRUCTURAL COMPONENTS COMPLY WITH THE 2018 NORTH CAROLINA RESIDENTIAL CODE FOR ONE- AND TWO-FAMILY DWELLINGS FOR NC PLAN REVIEW. DEVIATION OF ANY STRUCTURAL REQUIREMENTS OF THESE PLANS WITHOUT THE APPROVAL OF THE EOR IS PROHIBITED.

JDS Consulting
8600 D' JERSEY CT, RALEIGH, NC 27617-919-480-1075
INFO@JDSCONSULTING.NET · WWW.JDSCONSULTING.NET

PROJECT NO.: 21901127
DATE: 05/21/2021

PLAN:
238.2338

FIRST FLOOR
WALL BRACING PLAN
S4.0C

FIRST FLOOR WALL BRACING PLAN - 'C'
SCALE: 1/8"=1'-0"

These designs and drawings are CONFIDENTIAL, and the exclusive property of KB Home Corporation and are not to be disclosed without the express permission of KB Home Corporation. Copyright 2019 © KB Home Corporation, all rights reserved.

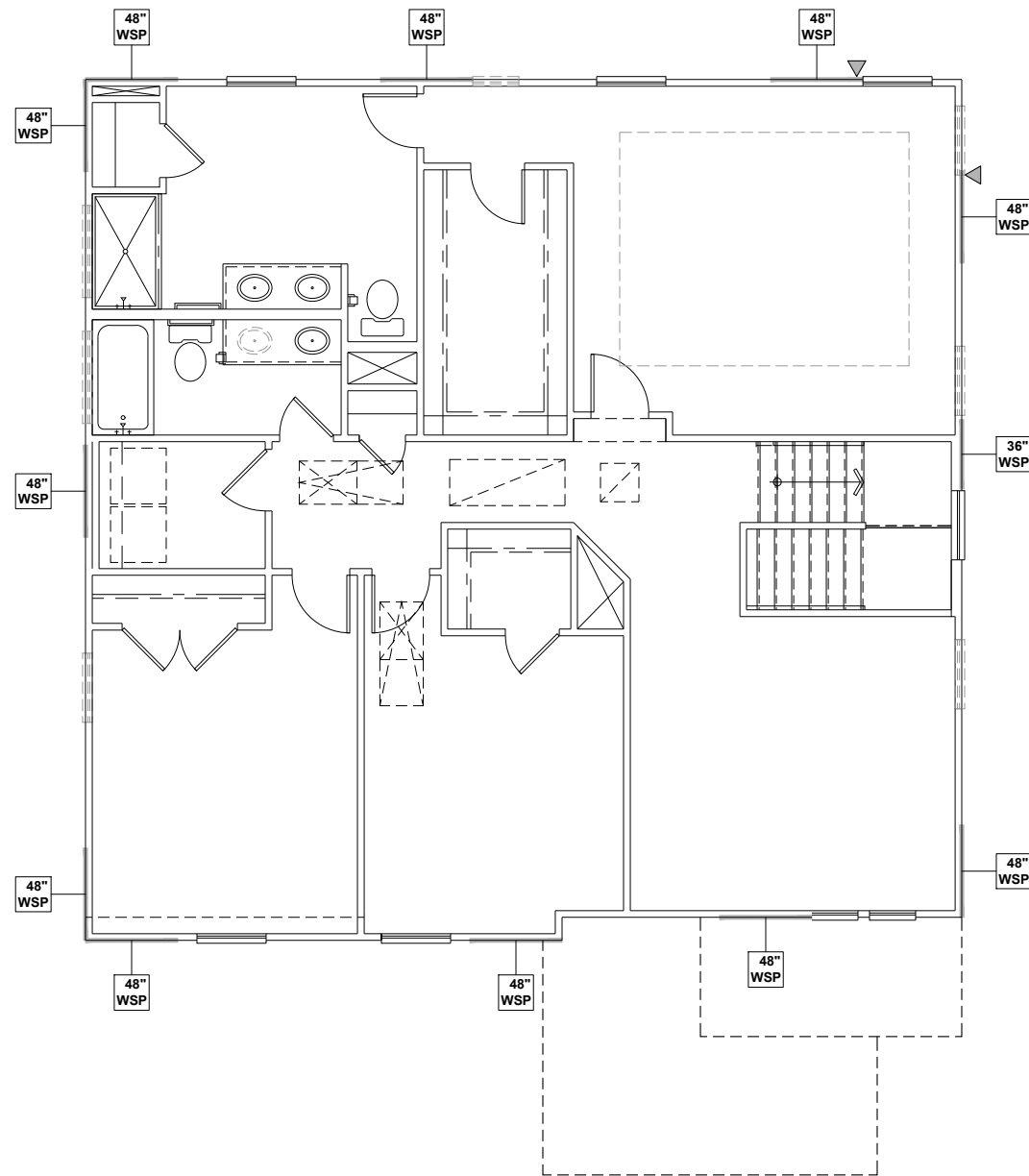

WALL BRACING REQUIREMENTS

- MINIMUM PANEL WIDTH IS 24"
- FIGURES BASED ON THE CONTINUOUS SHEATHING METHOD USING THE RECTANGLE CIRCUMSCRIBED AROUND THE FLOOR PLAN OR PORTION OF THE FLOOR PLAN. IF NO RECTANGLE IS NOTED, THE STRUCTURE HAS BEEN FIGURED ALL WITHIN ONE RECTANGLE.
- PANELS MAY SHIFT UP TO 36" EITHER DIRECTION FOR EASE OF CONSTRUCTION (NAILING & BLOCK REQUIREMENTS STILL APPLY).
- FOR ADDITIONAL WALL BRACING INFORMATION, REFER TO WALL BRACING DETAIL SHEET(S).
- SCHEMATIC BELOW INDICATES HOW SIDES OF RECTANGLE ARE TO BE INTERPRETED IN BRACING CHART WHEN APPLIED TO STRUCTURE:

- ◆ CS16 STRAP FROM STUD, CROSS HEADER, TO WALL TOP PLATE, 36" LONG MINIMUM
- ▶ SIMPSON MSTA15 HOLD DOWN CAPACITY OF 970 POUNDS PER ANCHOR WITH (12) 10d NAILS. STRAP TO BE LOCATED AT EDGE OF BRACED WALL PANEL. (CS16 STRAPPING MAY BE SUBSTITUTED w/ SIMILAR LENGTH AND NAILING PATTERN.) USE HTT4 FOR ATTACHMENT TO CONCRETE.

SCALED LENGTH OF WALL PANEL AT LOCATION

24" WSP

NUMERICAL LENGTH OF PANEL

PANEL TYPE

ENGINEERED WALL SCHEDULE

ENG1: CONTINUOUSLY SHEATH WITH 7/16" OSB ATTACHED WITH 8d NAILS @ 6" OC EDGE AND 12" OC FIELD. FULLY BLOCKED AT ALL PANEL EDGES.

ENG2: CONTINUOUSLY SHEATH WITH 7/16" OSB WITH 10d NAILS @ 3" OC EDGE AND 3" OC FIELD. FULLY BLOCKED AT ALL PANEL EDGES.

ENG3: CONTINUOUSLY SHEATH 7/16" OSB ATTACHED BOTH SIDES WITH 8d NAILS @ 4" OC EDGE AND 8" OC FIELD. FULLY BLOCKED AT ALL PANEL EDGES.

ENG4: CONTINUOUSLY SHEATH 7/16" OSB ATTACHED WITH 8d NAILS @ 4" OC EDGE AND 8" OC FIELD. FULLY BLOCKED AT ALL PANEL EDGES.

WALL BRACING NOTE:

WALLS WITH PROVIDED LENGTH LISTED AS "N/A" DO NOT MEET THE REQUIREMENTS OF PRESCRIPTIVE WALL BRACING FOUND IN THE NCRC. THESE WALLS HAVE BEEN ENGINEERED BASED ON DESIGN GUIDELINES ESTABLISHED IN ASCE-07 AND THE NDS: WIND & SEISMIC PROVISIONS SUPPLEMENT.

WALL BRACING: RECTANGLE 1

SIDE	REQUIRED LENGTH	PROVIDED LENGTH
FRONT	6.5 FT.	12.0 FT.
LEFT	5.5 FT.	12.0 FT.
REAR	6.5 FT.	12.0 FT.
RIGHT	5.5 FT.	11.0 FT.



KB HOME
NORTH CAROLINA DIVISION
4518 S. MIAMI BLVD.
SUITE 180
DURHAM, NC 27703
TEL: (919) 768-7988
FAX: (919) 472-0582

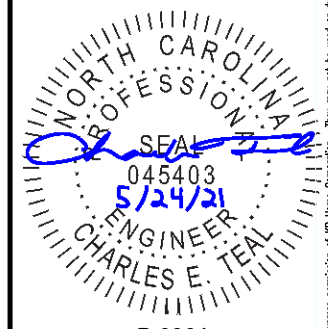

P-0961

JDS Consulting, PLLC HAS PERFORMED A STRUCTURAL REVIEW OF THESE PLANS. THE STRUCTURAL COMPONENTS COMPLY WITH THE 2018 NORTH CAROLINA RESIDENTIAL CODE FOR ONE- AND TWO-FAMILY DWELLINGS FOR NC PLAN REVIEW. DEVIATION OF ANY STRUCTURAL REQUIREMENTS OF THESE PLANS WITHOUT THE APPROVAL OF THE EOR IS PROHIBITED.

JDS Consulting
8600 D' JERSEY CT, RALEIGH, NC 27617-919-480-1075
INFO@JDSCONSULTING.NET | WWW.JDSCONSULTING.NET

PROJECT NO.: 21901127
DATE: 05/21/2021

PLAN:
238.2338

SECOND FLOOR
WALL BRACING PLAN

S5.0C

SECOND FLOOR WALL BRACING PLAN - 'C'
SCALE: 1/8"=1'-0"

These designs and drawings are CONFIDENTIAL, and the exclusive property of KB Home Corporation and are not to be disclosed without the express permission of KB Home Corporation. Copyright 2019 © KB Home Corporation. All rights reserved.

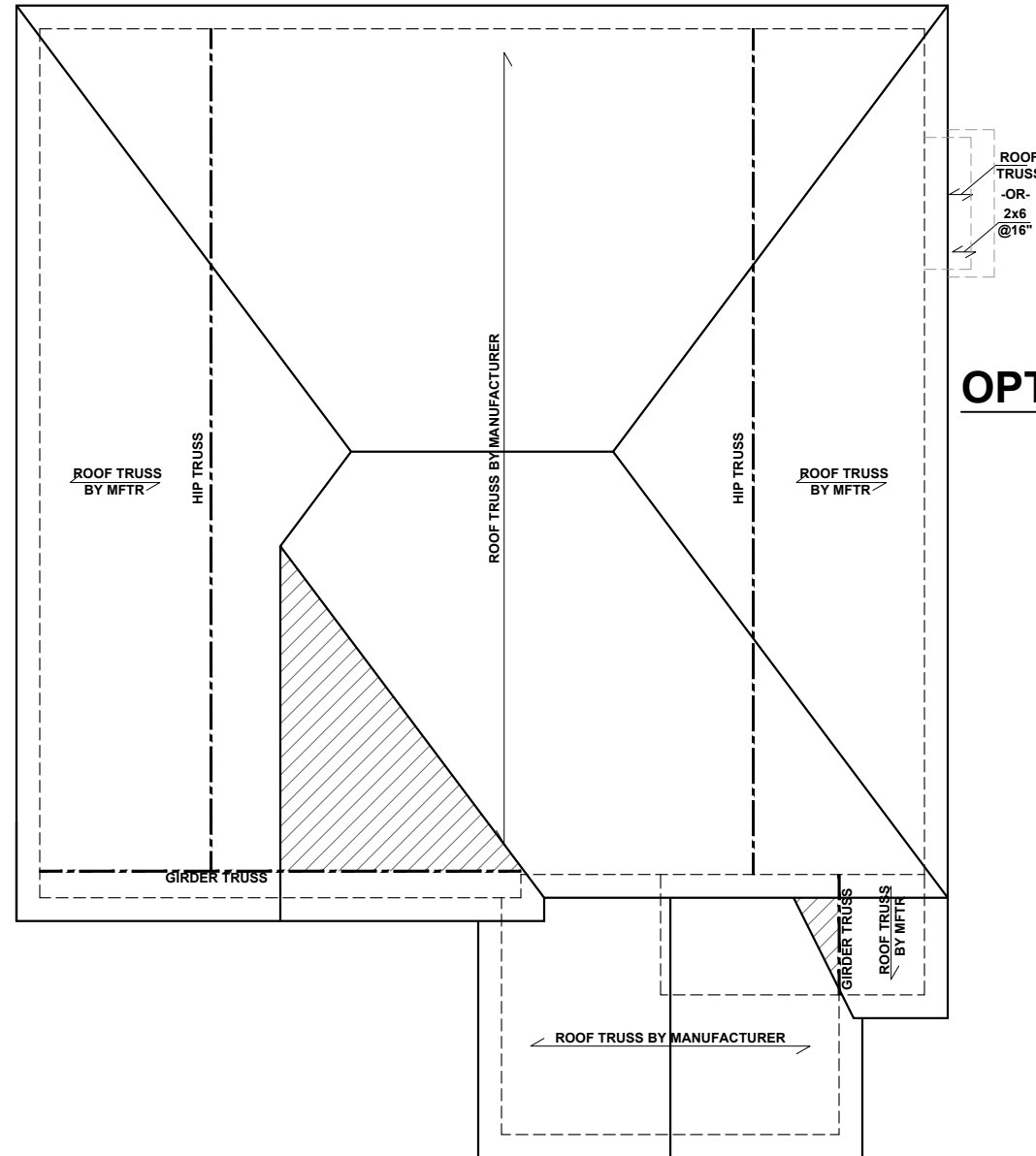

OPT. FIREPLACE 2

ROOF FRAMING PLAN - 'C'

SCALE: 1/8"=1'-0"

BEAM & POINT LOAD LEGEND

	INTERIOR LOAD BEARING WALL
	ROOF RAFTER / TRUSS SUPPORT
	DOUBLE RAFTER / DOUBLE JOIST
	STRUCTURAL BEAM / GIRDER
	WINDOW / DOOR HEADER
	POINT LOAD TRANSFER
	POINT LOAD FROM ABOVE BEARING ON BEAM / GIRDER

- TRUSSED ROOF - STRUCTURAL NOTES**
- PROVIDE CONTINUOUS BLOCKING THROUGH STRUCTURE FOR ALL POINT LOADS.
 - DENOTES OVER-FRAMED AREA
 - MINIMUM 7/16" OSB ROOF SHEATHING
 - TRUSS LAYOUT AND PLACEMENT BY MANUFACTURER TO COINCIDE WITH THE SUPPORT LOCATIONS SHOWN. TRUSS PROFILES SHALL BE SEALED BY THE TRUSS MANUFACTURER. TRUSS PLANS TO BE COORDINATED WITH THE SEALED STRUCTURAL DRAWINGS. INSTALLATION SHALL BE IN ACCORDANCE WITH THE MANUFACTURER'S INSTRUCTIONS.
 - MANUFACTURER TO PROVIDE REQUIRED UPLIFT CONNECTION.
 - PROVIDE H2.5A (MINIMUM) OR EQUIVALENT AT EACH TRUSS-TO-TOP PLATE CONNECTION AT OVER-FRAMED AREAS, UNLESS NOTED OTHERWISE.
 - UPLIFT CONNECTION TO BE CARRIED THROUGH TO FLOOR SYSTEM.

TRUSS UPLIFT CONNECTORS: EXPOSURE B, 115 MPH, ANY PITCH, 24" O.C. MAX ROOF TRUSS SPACING

TRUSSES SHALL BE ATTACHED TO SUPPORT WALL FOR UPLIFT RESISTANCE. CONTINUOUS OSB WALL SHEATHING BELOW PROVIDES CONTINUOUS UPLIFT RESISTANCE TO FOUNDATION. ALL TRUSSES SUPPORTED BY INTERMEDIATE SUPPORT WALLS, KNEEWALLS, OR BEAMS SHALL BE ATTACHED TO SUPPORTING MEMBER PER SCHEDULE:

ROOF SPAN IS MEASURED HORIZONTALLY BETWEEN FURTHEST SUPPORT POINTS.

ROOF PLAN UP TO 28'	CONNECTOR NAILING PER TABLE 602.3(1) NCRBC 2018 EDITION
OVER 28'	(1) SIMPSON H2.5A HURRICANE CLIP TO DBL TOP PLATE OR BEAM (OR) (1) SIMPSON H3 CLIP TO SINGLE 2x4 PLATE

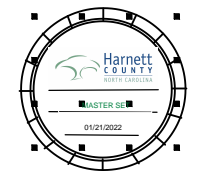

KB HOME
NORTH CAROLINA DIVISION
4518 S. MIAMI BLVD.
SUITE 180
DURHAM, NC 27703
TEL: (919) 768-7988
FAX: (919) 472-0582

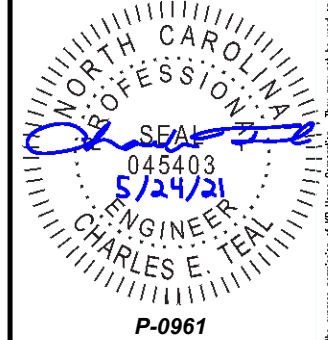

JDS Consulting, PLLC HAS PERFORMED A STRUCTURAL REVIEW OF THESE PLANS. THE STRUCTURAL COMPONENTS COMPLY WITH THE 2018 NORTH CAROLINA RESIDENTIAL CODE FOR ONE- AND TWO-FAMILY DWELLINGS FOR NC PLAN REVIEW. DEVIATION OF ANY STRUCTURAL REQUIREMENTS OF THESE PLANS WITHOUT THE APPROVAL OF THE EOR IS PROHIBITED.

JDS Consulting
8600 D' JERSEY CT, RALEIGH, NC 27617-919-480-1075
INFO@JDSCONSULTING.NET | WWW.JDSCONSULTING.NET

PROJECT NO.: 21901127
DATE: 05/21/2021

PLAN:
238.2338

ROOF FRAMING PLAN
S7.0C

These designs and drawings are CONFIDENTIAL, and the exclusive property of KB Home Corporation and are not to be disclosed without the express permission of KB Home Corporation. Copyright 2019 © KB Home Corporation, all rights reserved.

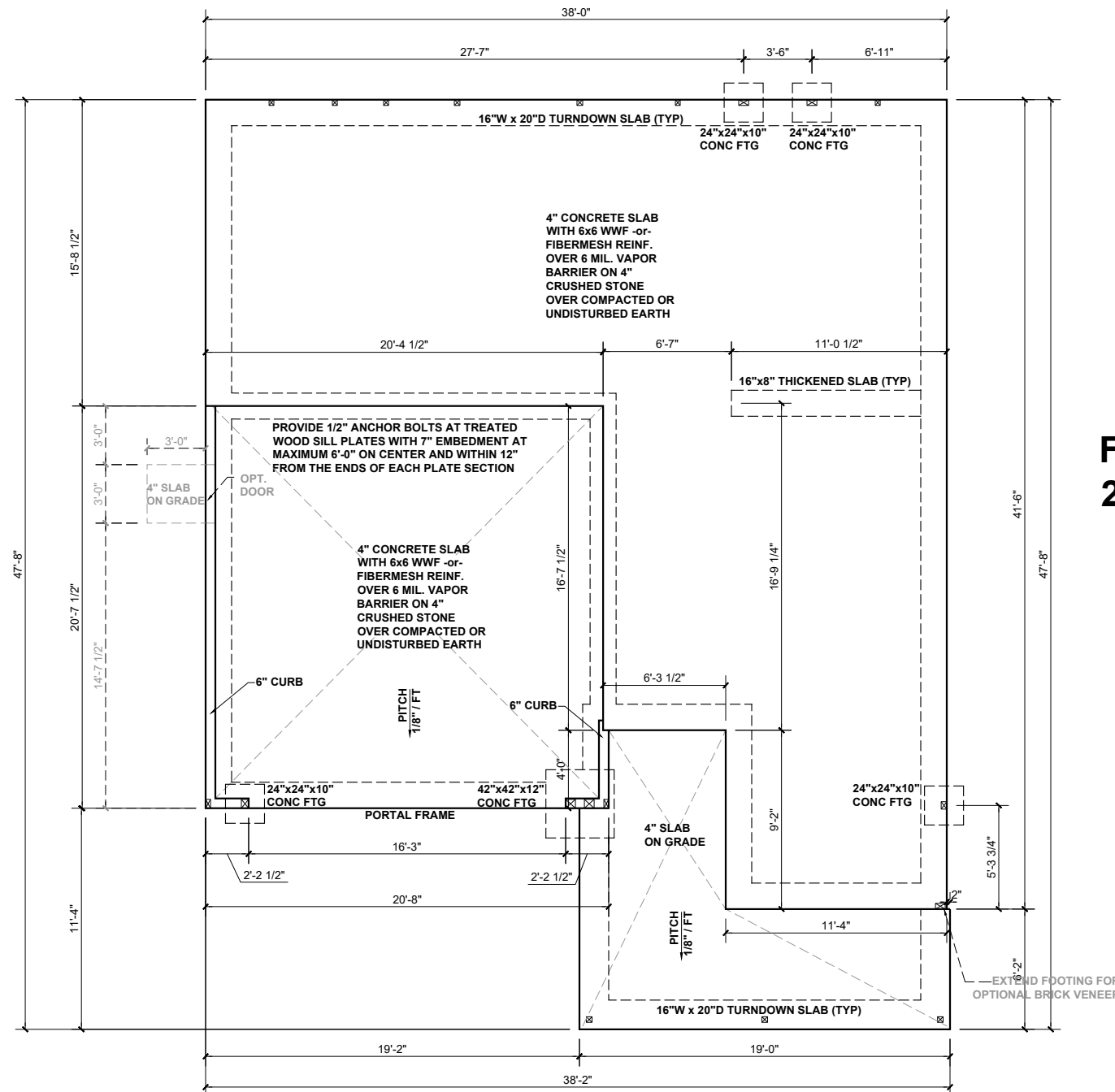

**FIREPLACE
2**

BEAM & POINT LOAD LEGEND

	INTERIOR LOAD BEARING WALL
	ROOF RAFTER / TRUSS SUPPORT
	DOUBLE RAFTER / DOUBLE JOIST
	STRUCTURAL BEAM / GIRDER
	WINDOW / DOOR HEADER
	POINT LOAD TRANSFER
	POINT LOAD FROM ABOVE BEARING ON BEAM / GIRDER

(1) #5 REBAR @ CENTER OF ALL PERIMETER AND INTERNAL LOAD BEARING FOOTINGS. (2" C.C. MIN)

ALL CONCRETE CURBS SUPPORTING PORTAL FRAMED OR ENGINEERED OPENINGS IN GARAGES WITH A PONY WALL OVER 24" ABOVE THE GARAGE DOOR HEADER SHALL BE REQUIRED TO BE AT LEAST 8" WIDE.

CONCRETE SLAB REINFORCING SUBSTITUTION OF SYNTHETIC FIBER MIX IN LIEU OF WWF IN NON STRUCTURAL SLABS:

- NO SUBSTITUTION ALLOWED IN SLABS INSTALLED ON RAISED METAL DECKING
- NO SUBSTITUTION ALLOWED IN SLABS WITH GRADE BEAMS UNLESS A REBAR MAT IS INSTALLED
- NO SUBSTITUTION ALLOWED IF ANY SOILS HAVE BEEN FOUND TO BE EXPANSIVE SOILS ON SITE
- NO SUBSTITUTION ALLOWED FOR SLAB POURS DIRECTLY ON GRADE; A 4" BASE MATERIAL OF CRUSHED STONE OR WELL DRAINING CLEAN SAND IS REQUIRED FOR SUBSTITUTION
- NO SUBSTITUTION ALLOWED FOR ANY SITES WITH A DCP BLOW COUNT OF 10 OR LESS.
- FIBER MIX VOLUMES MUST BE FOLLOWED PER THE MANUFACTURES SPECIFICATIONS



KB HOME
NORTH CAROLINA DIVISION
4518 S. MIAMI BLVD.
SUITE 180
DURHAM, NC 27703
TEL: (919) 768-7988
FAX: (919) 472-0582

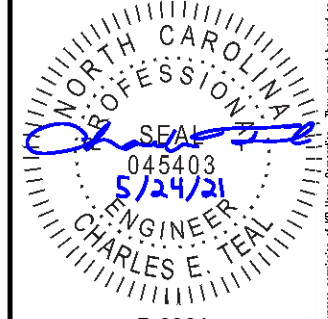

P-0961

JDS Consulting, PLLC HAS PERFORMED A STRUCTURAL REVIEW OF THESE PLANS. THE STRUCTURAL COMPONENTS COMPLY WITH THE 2018 NORTH CAROLINA RESIDENTIAL CODE FOR ONE- AND TWO-FAMILY DWELLINGS FOR NC PLAN REVIEW. DEVIATION OF ANY STRUCTURAL REQUIREMENTS OF THESE PLANS WITHOUT THE APPROVAL OF THE EOR IS PROHIBITED.



PROJECT NO.: 21901127
DATE: 05/21/2021

PLAN:
238.2338

SLAB
FOUNDATION PLAN
S.10D

SLAB FOUNDATION PLAN - 'D'
SCALE: 1/8"=1'-0"

These designs and drawings are CONFIDENTIAL, and the exclusive property of KB Home Corporation and are not to be disclosed without the express permission of KB Home Corporation. Copyright 2019 © KB Home Corporation, all rights reserved.

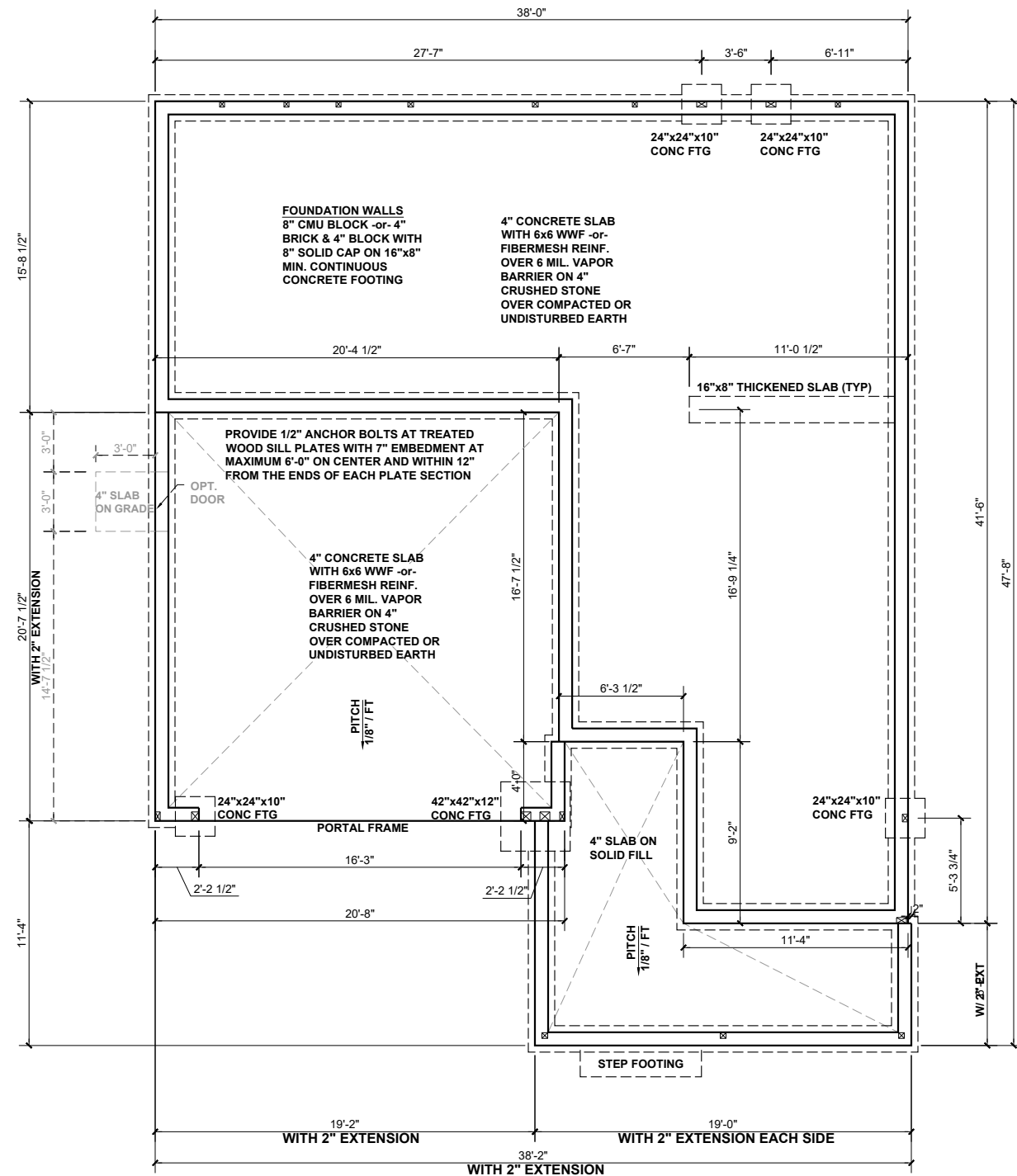

FIREPLACE 2

BEAM & POINT LOAD LEGEND

	INTERIOR LOAD BEARING WALL
	ROOF RAFTER / TRUSS SUPPORT
	DOUBLE RAFTER / DOUBLE JOIST
	STRUCTURAL BEAM / GIRDER
	WINDOW / DOOR HEADER
	POINT LOAD TRANSFER
	POINT LOAD FROM ABOVE BEARING ON BEAM / GIRDER

(1) #5 REBAR @ CENTER OF ALL PERIMETER AND INTERNAL LOAD BEARING FOOTINGS. (2" C.C. MIN)

ALL CONCRETE CURBS SUPPORTING PORTAL FRAMED OR ENGINEERED OPENINGS IN GARAGES WITH A PONY WALL OVER 24" ABOVE THE GARAGE DOOR HEADER SHALL BE REQUIRED TO BE AT LEAST 8" WIDE.

CONCRETE SLAB REINFORCING SUBSTITUTION OF SYNTHETIC FIBER MIX IN LIEU OF WWF IN NON STRUCTURAL SLABS:

- NO SUBSTITUTION ALLOWED IN SLABS INSTALLED ON RAISED METAL DECKING
- NO SUBSTITUTION ALLOWED IN SLABS WITH GRADE BEAMS UNLESS A REBAR MAT IS INSTALLED
- NO SUBSTITUTION ALLOWED IF ANY SOILS HAVE BEEN FOUND TO BE EXPANSIVE SOILS ON SITE
- NO SUBSTITUTION ALLOWED FOR SLAB POURS DIRECTLY ON GRADE; A 4" BASE MATERIAL OF CRUSHED STONE OR WELL DRAINING CLEAN SAND IS REQUIRED FOR SUBSTITUTION
- NO SUBSTITUTION ALLOWED FOR ANY SITES WITH A DCP BLOW COUNT OF 10 OR LESS.
- FIBER MIX VOLUMES MUST BE FOLLOWED PER THE MANUFACTURES SPECIFICATIONS



KB HOME
NORTH CAROLINA DIVISION
4518 S. MIAMI BLVD.
SUITE 180
DURHAM, NC 27703
TEL: (919) 768-7988
FAX: (919) 472-0582

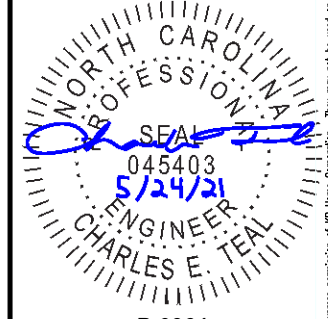

P-0961

JDS Consulting, PLLC HAS PERFORMED A STRUCTURAL REVIEW OF THESE PLANS. THE STRUCTURAL COMPONENTS COMPLY WITH THE 2018 NORTH CAROLINA RESIDENTIAL CODE FOR ONE- AND TWO-FAMILY DWELLINGS FOR NC PLAN REVIEW. DEVIATION OF ANY STRUCTURAL REQUIREMENTS OF THESE PLANS WITHOUT THE APPROVAL OF THE EOR IS PROHIBITED.

JDS Consulting
8600 D' JERSEY CT, RALEIGH, NC 27617-919-480-1075
INFO@JDSCONSULTING.NET | WWW.JDSCONSULTING.NET

PROJECT NO.: 21901127
DATE: 05/21/2021

PLAN:
238.2338

STEM WALL
FOUNDATION PLAN
S.20D

STEM WALL FOUNDATION PLAN - 'D'
SCALE: 1/8"=1'-0"

These designs and drawings are CONFIDENTIAL, and the exclusive property of KB Home Corporation and are not to be disclosed without the express permission of KB Home Corporation. Copyright 2019 © KB Home Corporation. All rights reserved.

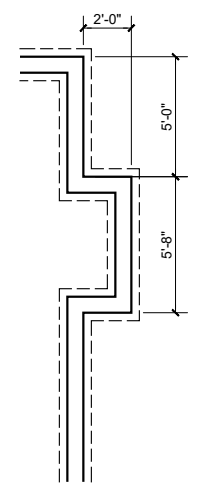
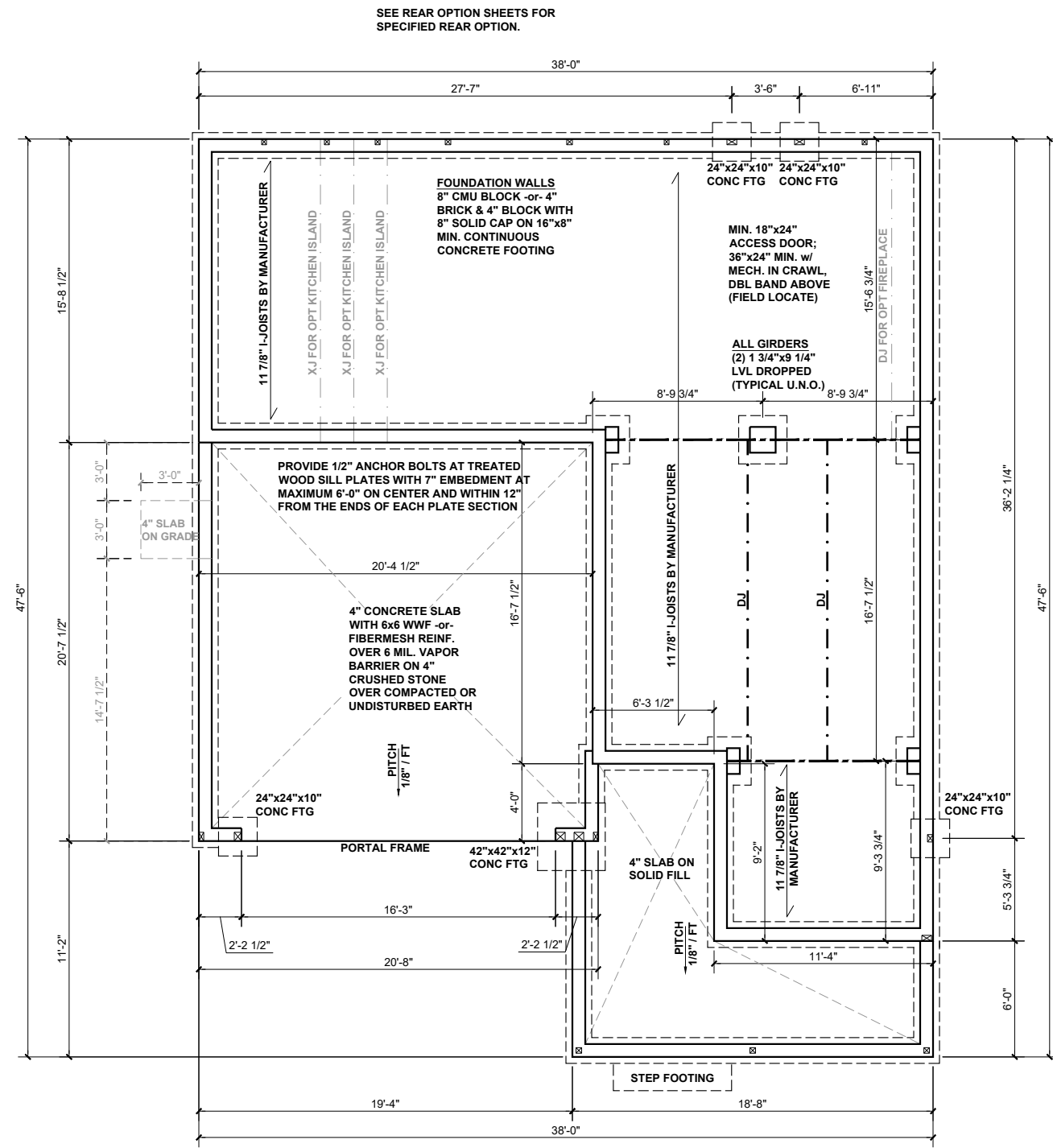

FIREPLACE 2

BEAM & POINT LOAD LEGEND

- INTERIOR LOAD BEARING WALL
- - - ROOF RAFTER / TRUSS SUPPORT
- · - · - DOUBLE RAFTER / DOUBLE JOIST
- STRUCTURAL BEAM / GIRDER
- WINDOW / DOOR HEADER
- ⊠ POINT LOAD TRANSFER
- POINT LOAD FROM ABOVE BEARING ON BEAM / GIRDER

FOUNDATION STRUCTURAL NOTES:

1. CONCRETE BLOCK PIER SIZE SHALL BE:

SIZE	HOLLOW MASONRY	SOLID MASONRY
8x16	UP TO 32" HIGH	UP TO 5'-0" HIGH
12x16	UP TO 48" HIGH	UP TO 9'-0" HIGH
16x16	UP TO 64" HIGH	UP TO 12'-0" HIGH
24x24	UP TO 96" HIGH	

WITH 30" x 30" x 10" CONCRETE FOOTING, UNO.

FLOOR FRAMING TO BE 11 7/8" DEEP TJI 210 SERIES OR EQUAL, 19.2" OC MAXIMUM SPACING

**REFER TO I-JOIST EQUIVALENCE CHART ON I-JOIST DETAIL SHEET FOR SUBSTITUTION OF MANUFACTURER SERIES

I-JOIST SPACING NOT TO EXCEED 19.2" OC IN LOCATIONS WITH TILE FINISH FLOOR

8"x16" PIERS AT FOUNDATION WALL SUPPORTING DROPPED GIRDER TO HAVE A 30"x10"x8" FOOTING PROJECTION FROM THE MAIN WALL FOOTING.

(1) #5 REBAR @ CENTER OF ALL PERIMETER FOOTINGS. (2" C.C. MIN)

CRAWL SPACE FOUNDATION PLAN - 'D'
SCALE: 1/8"=1'-0"



KB HOME
NORTH CAROLINA DIVISION
4518 S. MIAMI BLVD.
SUITE 180
DURHAM, NC 27703
TEL: (919) 768-7988
FAX: (919) 472-0582

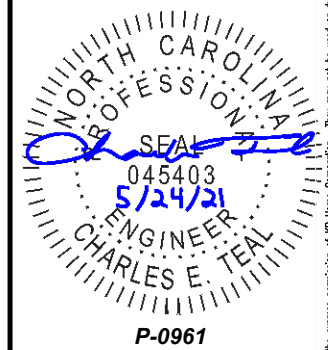

JDS Consulting, PLLC HAS PERFORMED A STRUCTURAL REVIEW OF THESE PLANS. THE STRUCTURAL COMPONENTS COMPLY WITH THE 2018 NORTH CAROLINA RESIDENTIAL CODE FOR ONE- AND TWO-FAMILY DWELLINGS FOR NC PLAN REVIEW. DEVIATION OF ANY STRUCTURAL REQUIREMENTS OF THESE PLANS WITHOUT THE APPROVAL OF THE EOR IS PROHIBITED.

JDS Consulting
8600 D' JERSEY CT, RALEIGH, NC 27617-919-480-1075
INFO@JDSCONSULTING.NET; WWW.JDSCONSULTING.NET

PROJECT NO.: 21901127
DATE: 05/21/2021

PLAN:
238.2338

CRAWL SPACE
FOUNDATION PLAN
S.30D

These design and drawings are CONFIDENTIAL, and the exclusive property of KB Home Corporation and are not to be disclosed without the express permission of KB Home Corporation. Copyright 2019 © KB Home Corporation, all rights reserved.



KB HOME
NORTH CAROLINA DIVISION
4518 S. MIAMI BLVD.
SUITE 180
DURHAM, NC 27703
TEL: (919) 768-7988
FAX: (919) 472-0582

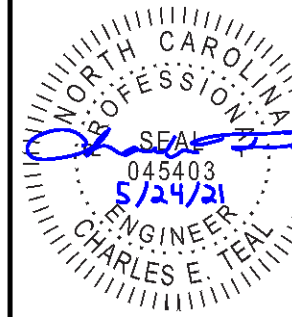

P-0961

JDS Consulting, PLLC HAS PERFORMED A STRUCTURAL REVIEW OF THESE PLANS. THE STRUCTURAL COMPONENTS COMPLY WITH THE 2018 NORTH CAROLINA RESIDENTIAL CODE FOR ONE- AND TWO-FAMILY DWELLINGS FOR NC PLAN REVIEW. DEVIATION OF ANY STRUCTURAL REQUIREMENTS OF THESE PLANS WITHOUT THE APPROVAL OF THE EOR IS PROHIBITED.



8600 D' JERSEY CT, RALEIGH, NC 27617-919-480-1075
INFO@JDSCONSULTING.NET | WWW.JDSCONSULTING.NET

PROJECT NO.: 21901127
DATE: 05/21/2021

PLAN:
238.2338

FIRST FLOOR
CEILING FRAMING PLAN

S1.0D

BEAM & POINT LOAD LEGEND	
	INTERIOR LOAD BEARING WALL
	ROOF RAFTER / TRUSS SUPPORT
	DOUBLE RAFTER / DOUBLE JOIST
	STRUCTURAL BEAM / GIRDER
	WINDOW / DOOR HEADER
	POINT LOAD TRANSFER
	POINT LOAD FROM ABOVE BEARING ON BEAM / GIRDER

- STRUCTURAL FRAMING NOTES - (SEE GENERAL NOTES SHEET FOR ADDITIONAL REQUIREMENTS.)
- ALL FRAMING TO BE #2 SPF MINIMUM.
 - ALL BEARING HEADERS TO BE (2) 2x6 SUPPORTED w/ MIN (1) JACK AND (1) KING EACH END, UNO.
 - EXTERIOR WALL OPENINGS OVER 3' TO HAVE MULTIPLE KING STUDS AS NOTED ON PLAN.
 - ALL NON-BEARING HEADERS TO BE (2) 2x4 (1) J / (1) K, UNO.
 - PROVIDE CONTINUOUS BLOCKING THROUGH STRUCTURE FOR ALL POINT LOADS.
 - ALL HANGERS AND CONNECTORS SPECIFIED ARE TO BE SIMPSON STRONG-TIE OR EQUIVALENT.
 - ALL BEAMS SPECIFIED ARE MINIMUM SIZES ONLY. LARGER MEMBERS MAY SUBSTITUTED AS NEEDED FOR EASE OF CONSTRUCTION. MINIMUM BEAM SUPPORT IS (1) 2x4 STUD.
 - ALL EXTERIOR WALLS TO BE FULLY SHEATHED WITH 7/16" OSB.
 - FRONT PORCH COLUMNS TO BE MIN 4x4 PT ATTACHED AT TOP AND BOTTOM USING SIMPSON (OR EQUIV) COLUMN BASE OR SST A24 BRACKETS. TRIM OUT PER BUILDER.
 - PORCH COLUMNS TO BE MIN 4x4 PT ATTACHED AT BOTTOM USING SIMPSON (OR EQUIV) ABA44 AND AT TOP USING CS 16 STRAPPING (12" MIN) TO PORCH HEADER / BAND.
 - WHEN A 4-PLY LVL IS USED, ATTACH WITH (1) 1/2" Ø BOLT 12" OC STAGGERED, TOP AND BOTTOM, 1-1/2" MIN FROM ENDS. ALTERNATE ATTACHMENT EQUIVALENT METHOD MAY BE USED, SUCH AS SDW OR TRUSSLOK SCREWS (SEE MANUFACTURER'S SPECIFICATIONS).
 - FOR STUD COLUMNS OF 4 OR MORE, INSTALL SST CS16 STRAPS @ 30" OC, 6" MAX FROM PLATES, ON INSIDE FACE OF COLUMN (EXTERIOR WALL), ON BOTH FACES OF COLUMN (INTERIOR WALL).

I-JOIST SPACING NOT TO EXCEED 19.2" OC IN LOCATIONS WITH TILE FINISH FLOOR

ALL FLUSH BEAMS TO BE DIRECTLY SUPPORTED BY (2) 2X STUDS UNLESS OTHERWISE NOTED. STUD COLUMNS TO BE SUPPORTED BY SOLID BLOCKING TO FOUNDATION OR TO BEARING COMPONENT BELOW.

FLOOR FRAMING TO BE 14" DEEP TJI 210 SERIES OR EQUAL, 19.2" OC MAXIMUM SPACING, U.N.O.

**REFER TO I-JOIST EQUIVALENCE CHART ON I-JOIST DETAIL SHEET FOR SUBSTITUTION OF MANUFACTURER SERIES

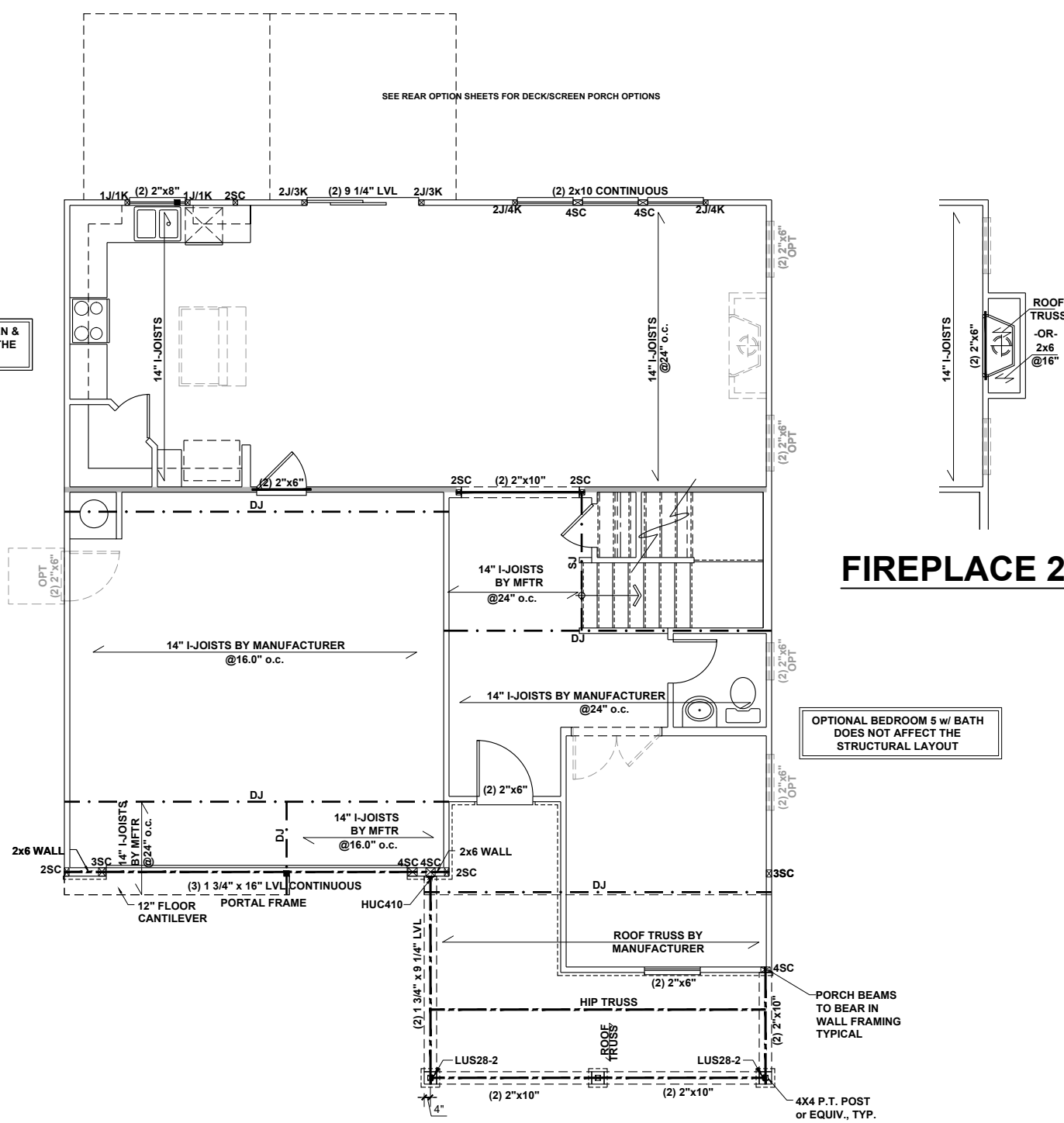

FIREPLACE 2

FIRST FLOOR CEILING FRAMING PLAN - 'D'

SCALE: 1/8"=1'-0"

OPTIONAL GOURMET KITCHEN & ISLAND DOES NOT AFFECT THE STRUCTURAL LAYOUT

OPTIONAL BEDROOM 5 w/ BATH DOES NOT AFFECT THE STRUCTURAL LAYOUT

These designs and drawings are CONFIDENTIAL, and the exclusive property of KB Home Corporation and are not to be disclosed without the express permission of KB Home Corporation. Copyright © 2019 KB Home Corporation, all rights reserved.

MASTER BATH OPTIONS
DO NOT AFFECT THE
STRUCTURAL LAYOUT

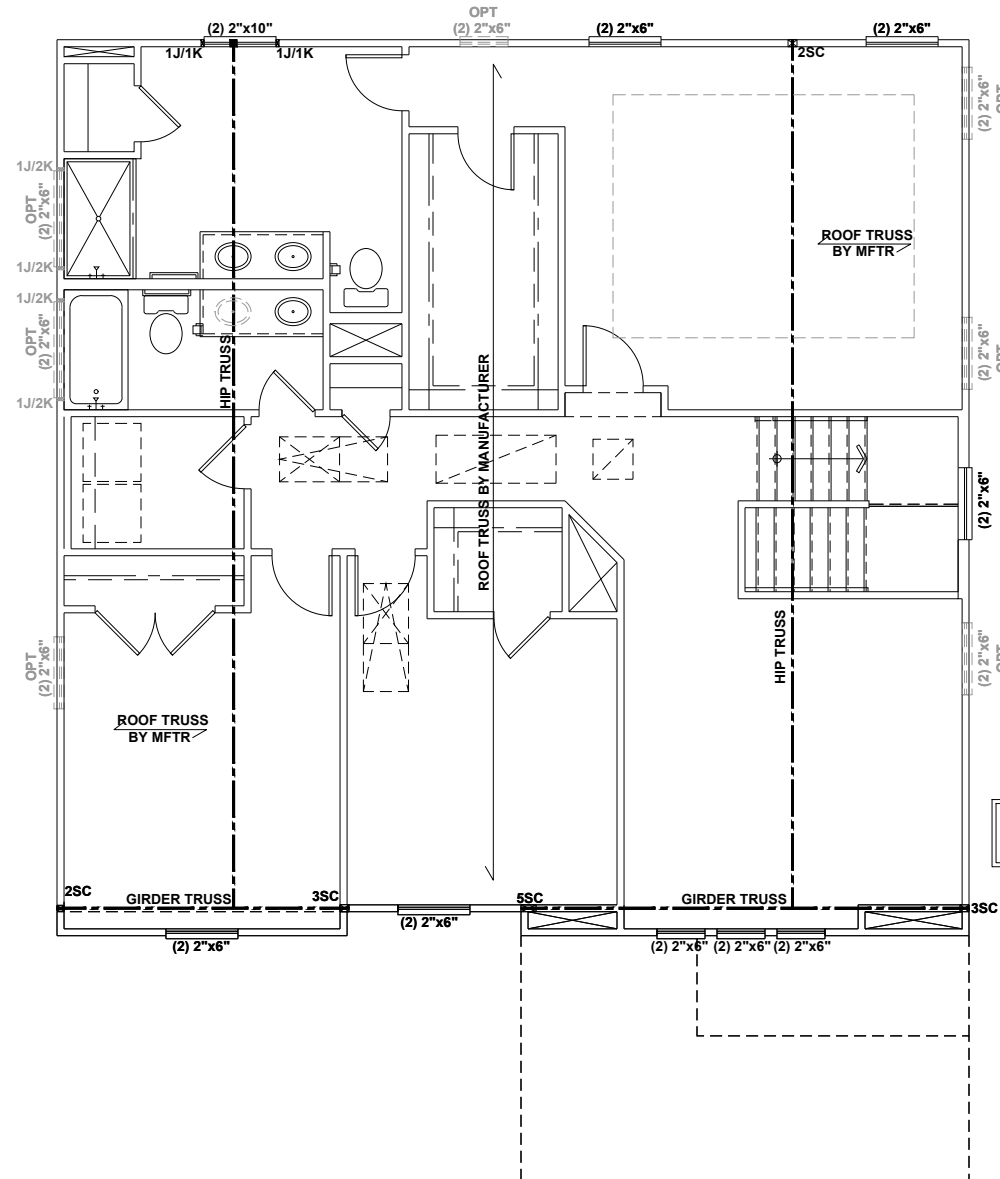

BEDROOM 4 OPTION
DOES NOT AFFECT THE
STRUCTURAL LAYOUT

BEAM & POINT LOAD LEGEND	
	INTERIOR LOAD BEARING WALL
	ROOF RAFTER / TRUSS SUPPORT
	DOUBLE RAFTER / DOUBLE JOIST
	STRUCTURAL BEAM / GIRDER
	WINDOW / DOOR HEADER
	POINT LOAD TRANSFER
	POINT LOAD FROM ABOVE BEARING ON BEAM / GIRDER

- STRUCTURAL FRAMING NOTES - (SEE GENERAL NOTES SHEET FOR ADDITIONAL REQUIREMENTS.)
- ALL FRAMING TO BE #2 SPF MINIMUM.
 - ALL BEARING HEADERS TO BE (2) 2x6 SUPPORTED w/ MIN (1) JACK AND (1) KING EACH END, UNO.
 - EXTERIOR WALL OPENINGS OVER 3' TO HAVE MULTIPLE KING STUDS AS NOTED ON PLAN.
 - ALL NON-BEARING HEADERS TO BE (2) 2x4 (1) J / (1) K, UNO.
 - PROVIDE CONTINUOUS BLOCKING THROUGH STRUCTURE FOR ALL POINT LOADS.
 - ALL HANGERS AND CONNECTORS SPECIFIED ARE TO BE SIMPSON STRONG-TIE OR EQUIVALENT.
 - ALL BEAMS SPECIFIED ARE MINIMUM SIZES ONLY. LARGER MEMBERS MAY SUBSTITUTED AS NEEDED FOR EASE OF CONSTRUCTION. MINIMUM BEAM SUPPORT IS (1) 2x4 STUD.
 - ALL EXTERIOR WALLS TO BE FULLY SHEATHED WITH 7/16" OSB.
 - FRONT PORCH COLUMNS TO BE MIN 4x4 PT ATTACHED AT TOP AND BOTTOM USING SIMPSON (OR EQUIV) COLUMN BASE OR SST A24 BRACKETS. TRIM OUT PER BUILDER.
 - PORCH COLUMNS TO BE MIN 4x4 PT ATTACHED AT BOTTOM USING SIMPSON (OR EQUIV) ABA44 AND AT TOP USING CS 16 STRAPPING (12" MIN) TO PORCH HEADER / BAND.
 - WHEN A 4-PLY LVL IS USED, ATTACH WITH (1) 1/2" Ø BOLT 12" OC STAGGERED, TOP AND BOTTOM, 1-1/2" MIN FROM ENDS. ALTERNATE ATTACHMENT EQUIVALENT METHOD MAY BE USED, SUCH AS SDW OR TRUSSEK SCREWS (SEE MANUFACTURER'S SPECIFICATIONS).
 - FOR STUD COLUMNS OF 4 OR MORE, INSTALL SST CS16 STRAPS @ 30" OC, 6" MAX FROM PLATES, ON INSIDE FACE OF COLUMN (EXTERIOR WALL), ON BOTH FACES OF COLUMN (INTERIOR WALL).

ALL FLUSH BEAMS TO BE DIRECTLY SUPPORTED BY (2) 2X STUDS UNLESS OTHERWISE NOTED. STUD COLUMNS TO BE SUPPORTED BY SOLID BLOCKING TO FOUNDATION OR TO BEARING COMPONENT BELOW.



KB HOME
NORTH CAROLINA DIVISION
4518 S. MIAMI BLVD.
SUITE 180
DURHAM, NC 27703
TEL: (919) 768-7988
FAX: (919) 472-0582

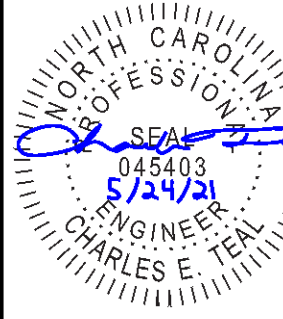

P-0961

JDS Consulting, PLLC HAS PERFORMED A STRUCTURAL REVIEW OF THESE PLANS. THE STRUCTURAL COMPONENTS COMPLY WITH THE 2018 NORTH CAROLINA RESIDENTIAL CODE FOR ONE- AND TWO-FAMILY DWELLINGS FOR NC PLAN REVIEW. DEVIATION OF ANY STRUCTURAL REQUIREMENTS OF THESE PLANS WITHOUT THE APPROVAL OF THE EOR IS PROHIBITED.



8600 D' JERSEY CT, RALEIGH, NC 27617-919-480-1075
INFO@JDSCONSULTING.NET · WWW.JDSCONSULTING.NET

PROJECT NO.: 21901127
DATE: 05/21/2021

PLAN:
238.2338

SECOND FLOOR
CEILING FRAMING PLAN

S2.0D

SECOND FLOOR CEILING FRAMING PLAN - 'D'

SCALE: 1/8"=1'-0"

These designs and drawings are CONFIDENTIAL, and the exclusive property of KB Home Corporation and are not to be disclosed without the express permission of KB Home Corporation. Copyright © 2019 KB Home Corporation, all rights reserved.

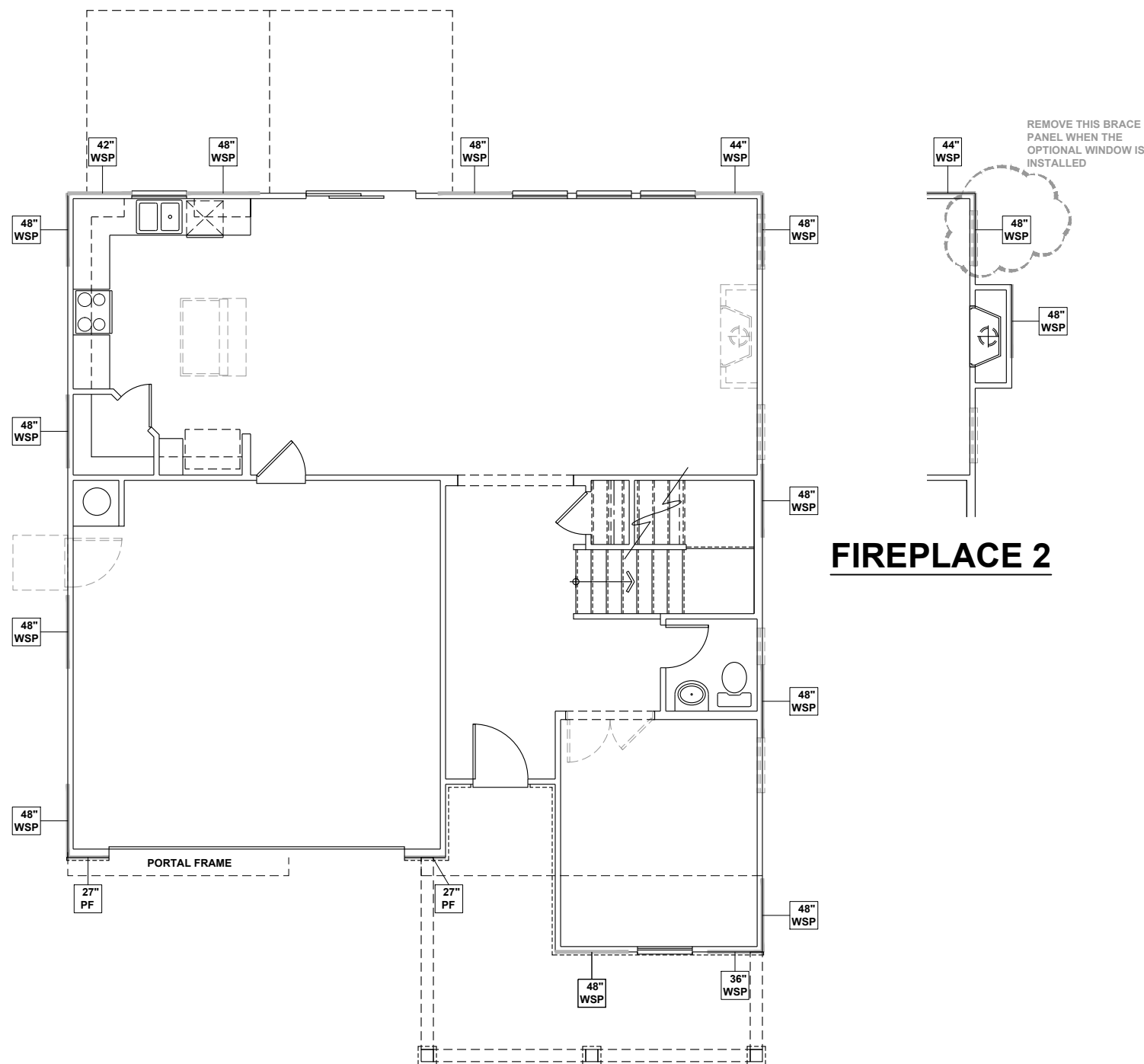

WALL BRACING REQUIREMENTS

- MINIMUM PANEL WIDTH IS 24"
- FIGURES BASED ON THE CONTINUOUS SHEATHING METHOD USING THE RECTANGLE CIRCUMSCRIBED AROUND THE FLOOR PLAN OR PORTION OF THE FLOOR PLAN. IF NO RECTANGLE IS NOTED, THE STRUCTURE HAS BEEN FIGURED ALL WITHIN ONE RECTANGLE.
- PANELS MAY SHIFT UP TO 36" EITHER DIRECTION FOR EASE OF CONSTRUCTION (NAILING & BLOCK REQUIREMENTS STILL APPLY).
- FOR ADDITIONAL WALL BRACING INFORMATION, REFER TO WALL BRACING DETAIL SHEET(S).
- SCHEMATIC BELOW INDICATES HOW SIDES OF RECTANGLE ARE TO BE INTERPRETED IN BRACING CHART WHEN APPLIED TO STRUCTURE:

- ◆ CS16 STRAP FROM STUD, CROSS HEADER, TO WALL TOP PLATE, 36" LONG MINIMUM
- ▶ SIMPSON MSTA15 HOLD DOWN CAPACITY OF 970 POUNDS PER ANCHOR WITH (12) 10d NAILS. STRAP TO BE LOCATED AT EDGE OF BRACED WALL PANEL. (CS16 STRAPPING MAY BE SUBSTITUTED w/ SIMILAR LENGTH AND NAILING PATTERN.) USE HTT4 FOR ATTACHMENT TO CONCRETE.

SCALED LENGTH OF WALL PANEL AT LOCATION

NUMERICAL LENGTH OF PANEL

PANEL TYPE

ENGINEERED WALL SCHEDULE

ENG1: CONTINUOUSLY SHEATH WITH 7/16" OSB ATTACHED WITH 8d NAILS @ 6" OC EDGE AND 12" OC FIELD. FULLY BLOCKED AT ALL PANEL EDGES.

ENG2: CONTINUOUSLY SHEATH WITH 7/16" OSB WITH 10d NAILS @ 3" OC EDGE AND 3" OC FIELD. FULLY BLOCKED AT ALL PANEL EDGES.

ENG3: CONTINUOUSLY SHEATH 7/16" OSB ATTACHED BOTH SIDES WITH 8d NAILS @ 4" OC EDGE AND 8" OC FIELD. FULLY BLOCKED AT ALL PANEL EDGES.

ENG4: CONTINUOUSLY SHEATH 7/16" OSB ATTACHED WITH 8d NAILS @ 4" OC EDGE AND 8" OC FIELD. FULLY BLOCKED AT ALL PANEL EDGES.

WALL BRACING NOTE:

WALLS WITH PROVIDED LENGTH LISTED AS "N/A" DO NOT MEET THE REQUIREMENTS OF PRESCRIPTIVE WALL BRACING FOUND IN THE NCRC. THESE WALLS HAVE BEEN ENGINEERED BASED ON DESIGN GUIDELINES ESTABLISHED IN ASCE-07 AND THE NDS: WIND & SEISMIC PROVISIONS SUPPLEMENT.

WALL BRACING: RECTANGLE 1

SIDE	REQUIRED LENGTH	PROVIDED LENGTH
FRONT	13.5 FT.	16.0 FT.
LEFT	11.0 FT.	16.0 FT.
REAR	13.5 FT.	15.16 FT.
RIGHT	11.0 FT.	16.0 FT.



KB HOME
NORTH CAROLINA DIVISION
4518 S. MIAMI BLVD.
SUITE 180
DURHAM, NC 27703
TEL: (919) 768-7988
FAX: (919) 472-0582

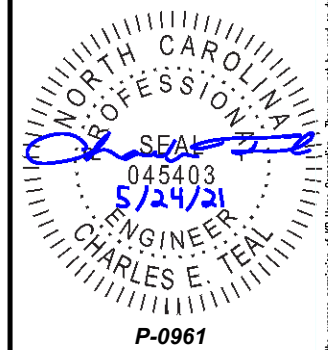

P-0961

JDS Consulting, PLLC HAS PERFORMED A STRUCTURAL REVIEW OF THESE PLANS. THE STRUCTURAL COMPONENTS COMPLY WITH THE 2018 NORTH CAROLINA RESIDENTIAL CODE FOR ONE- AND TWO-FAMILY DWELLINGS FOR NC PLAN REVIEW. DEVIATION OF ANY STRUCTURAL REQUIREMENTS OF THESE PLANS WITHOUT THE APPROVAL OF THE EOR IS PROHIBITED.



PROJECT NO.: 21901127
DATE: 05/21/2021

PLAN:
238.2338

FIRST FLOOR
WALL BRACING PLAN
S4.0D

FIRST FLOOR WALL BRACING PLAN - 'D'
SCALE: 1/8"=1'-0"

These designs and drawings are CONFIDENTIAL, and the exclusive property of KB Home Corporation and are not to be disclosed without the express permission of KB Home Corporation. Copyright 2019 © KB Home Corporation, all rights reserved.

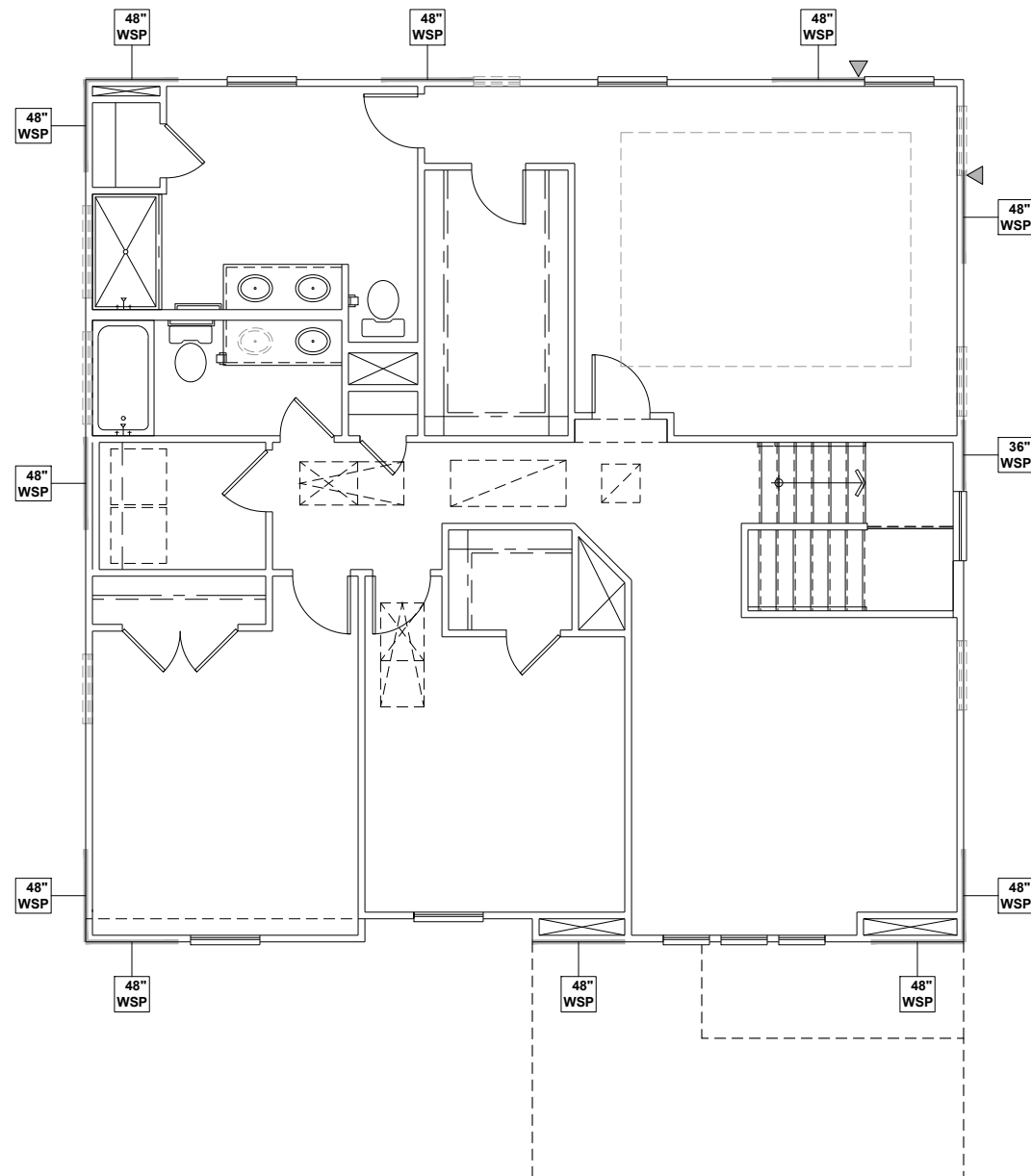

WALL BRACING REQUIREMENTS

- MINIMUM PANEL WIDTH IS 24"
- FIGURES BASED ON THE CONTINUOUS SHEATHING METHOD USING THE RECTANGLE CIRCUMSCRIBED AROUND THE FLOOR PLAN OR PORTION OF THE FLOOR PLAN. IF NO RECTANGLE IS NOTED, THE STRUCTURE HAS BEEN FIGURED ALL WITHIN ONE RECTANGLE.
- PANELS MAY SHIFT UP TO 36" EITHER DIRECTION FOR EASE OF CONSTRUCTION (NAILING & BLOCK REQUIREMENTS STILL APPLY).
- FOR ADDITIONAL WALL BRACING INFORMATION, REFER TO WALL BRACING DETAIL SHEET(S).
- SCHEMATIC BELOW INDICATES HOW SIDES OF RECTANGLE ARE TO BE INTERPRETED IN BRACING CHART WHEN APPLIED TO STRUCTURE:

- ◆ CS16 STRAP FROM STUD, CROSS HEADER, TO WALL TOP PLATE, 36" LONG MINIMUM
- ▶ SIMPSON MSTA15 HOLD DOWN CAPACITY OF 970 POUNDS PER ANCHOR WITH (12) 10d NAILS. STRAP TO BE LOCATED AT EDGE OF BRACED WALL PANEL. (CS16 STRAPPING MAY BE SUBSTITUTED w/ SIMILAR LENGTH AND NAILING PATTERN.) USE HTT4 FOR ATTACHMENT TO CONCRETE.

SCALED LENGTH OF WALL PANEL AT LOCATION

24" WSP

NUMERICAL LENGTH OF PANEL

PANEL TYPE

ENGINEERED WALL SCHEDULE

ENG1: CONTINUOUSLY SHEATH WITH 7/16" OSB ATTACHED WITH 8d NAILS @ 6" OC EDGE AND 12" OC FIELD. FULLY BLOCKED AT ALL PANEL EDGES.

ENG2: CONTINUOUSLY SHEATH WITH 7/16" OSB WITH 10d NAILS @ 3" OC EDGE AND 3" OC FIELD. FULLY BLOCKED AT ALL PANEL EDGES.

ENG3: CONTINUOUSLY SHEATH 7/16" OSB ATTACHED BOTH SIDES WITH 8d NAILS @ 4" OC EDGE AND 8" OC FIELD. FULLY BLOCKED AT ALL PANEL EDGES.

ENG4: CONTINUOUSLY SHEATH 7/16" OSB ATTACHED WITH 8d NAILS @ 4" OC EDGE AND 8" OC FIELD. FULLY BLOCKED AT ALL PANEL EDGES.

WALL BRACING NOTE:

WALLS WITH PROVIDED LENGTH LISTED AS "N/A" DO NOT MEET THE REQUIREMENTS OF PRESCRIPTIVE WALL BRACING FOUND IN THE NCRC. THESE WALLS HAVE BEEN ENGINEERED BASED ON DESIGN GUIDELINES ESTABLISHED IN ASCE-07 AND THE NDS: WIND & SEISMIC PROVISIONS SUPPLEMENT.

WALL BRACING: RECTANGLE 1

SIDE	REQUIRED LENGTH	PROVIDED LENGTH
FRONT	6.5 FT.	12.0 FT.
LEFT	5.5 FT.	12.0 FT.
REAR	6.5 FT.	12.0 FT.
RIGHT	5.5 FT.	11.0 FT.



KB HOME
NORTH CAROLINA DIVISION
4518 S. MIAMI BLVD.
SUITE 180
DURHAM, NC 27703
TEL: (919) 768-7988
FAX: (919) 472-0582

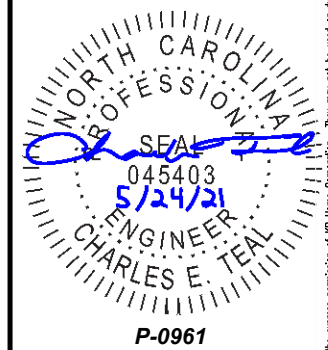

P-0961

JDS Consulting, PLLC HAS PERFORMED A STRUCTURAL REVIEW OF THESE PLANS. THE STRUCTURAL COMPONENTS COMPLY WITH THE 2018 NORTH CAROLINA RESIDENTIAL CODE FOR ONE- AND TWO-FAMILY DWELLINGS FOR NC PLAN REVIEW. DEVIATION OF ANY STRUCTURAL REQUIREMENTS OF THESE PLANS WITHOUT THE APPROVAL OF THE EOR IS PROHIBITED.

JDS Consulting
8600 D' JERSEY CT, RALEIGH, NC 27617-919-480.1075
INFO@JDSCONSULTING.NET | WWW.JDSCONSULTING.NET

PROJECT NO.: 21901127
DATE: 05/21/2021

PLAN:
238.2338

SECOND FLOOR
WALL BRACING PLAN
S5.0D

SECOND FLOOR WALL BRACING PLAN - 'D'
SCALE: 1/8"=1'-0"

These designs and drawings are CONFIDENTIAL, and the exclusive property of KB Home Corporation and are not to be disclosed without the express permission of KB Home Corporation. Copyright 2019 © KB Home Corporation, all rights reserved.

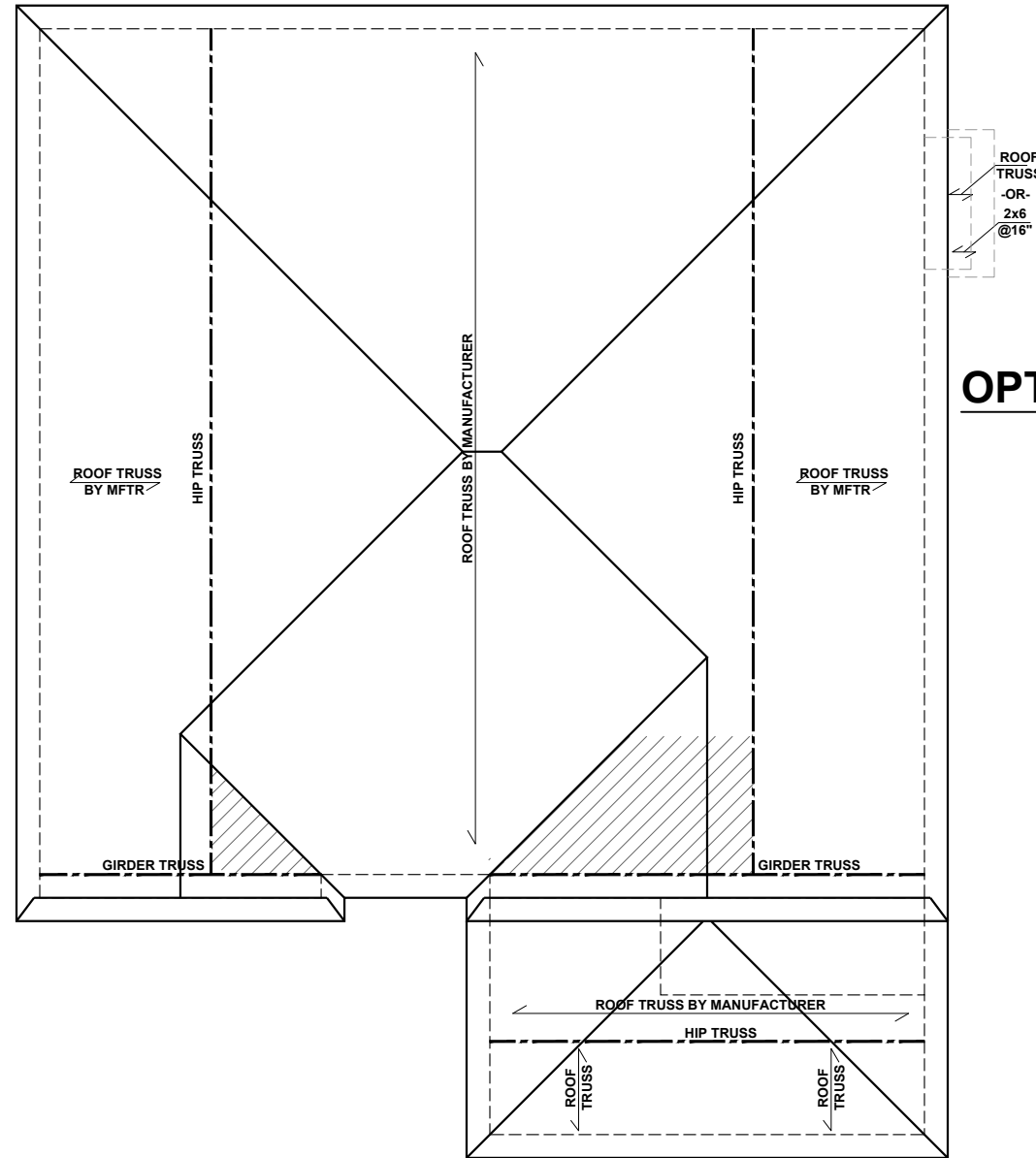

OPT. FIREPLACE 2

ROOF FRAMING PLAN - 'D'

SCALE: 1/8"=1'-0"

BEAM & POINT LOAD LEGEND

	INTERIOR LOAD BEARING WALL
	ROOF RAFTER / TRUSS SUPPORT
	DOUBLE RAFTER / DOUBLE JOIST
	STRUCTURAL BEAM / GIRDER
	WINDOW / DOOR HEADER
	POINT LOAD TRANSFER
	POINT LOAD FROM ABOVE BEARING ON BEAM / GIRDER

- TRUSSED ROOF - STRUCTURAL NOTES**
- PROVIDE CONTINUOUS BLOCKING THROUGH STRUCTURE FOR ALL POINT LOADS.
 - DENOTES OVER-FRAMED AREA
 - MINIMUM 7/16" OSB ROOF SHEATHING
 - TRUSS LAYOUT AND PLACEMENT BY MANUFACTURER TO COINCIDE WITH THE SUPPORT LOCATIONS SHOWN. TRUSS PROFILES SHALL BE SEALED BY THE TRUSS MANUFACTURER. TRUSS PLANS TO BE COORDINATED WITH THE SEALED STRUCTURAL DRAWINGS. INSTALLATION SHALL BE IN ACCORDANCE WITH THE MANUFACTURER'S INSTRUCTIONS.
 - MANUFACTURER TO PROVIDE REQUIRED UPLIFT CONNECTION.
 - PROVIDE H2.5A (MINIMUM) OR EQUIVALENT AT EACH TRUSS-TO-TOP PLATE CONNECTION AT OVER-FRAMED AREAS, UNLESS NOTED OTHERWISE.
 - UPLIFT CONNECTION TO BE CARRIED THROUGH TO FLOOR SYSTEM.

TRUSS UPLIFT CONNECTORS: EXPOSURE B, 115 MPH, ANY PITCH, 24" O.C. MAX ROOF TRUSS SPACING

TRUSSES SHALL BE ATTACHED TO SUPPORT WALL FOR UPLIFT RESISTANCE. CONTINUOUS OSB WALL SHEATHING BELOW PROVIDES CONTINUOUS UPLIFT RESISTANCE TO FOUNDATION. ALL TRUSSES SUPPORTED BY INTERMEDIATE SUPPORT WALLS, KNEEWALLS, OR BEAMS SHALL BE ATTACHED TO SUPPORTING MEMBER PER SCHEDULE:

ROOF SPAN IS MEASURED HORIZONTALLY BETWEEN FURTHEST SUPPORT POINTS.

ROOF PLAN UP TO 28'	CONNECTOR NAILING PER TABLE 602.3(1) NCRBC 2018 EDITION
OVER 28'	(1) SIMPSON H2.5A HURRICANE CLIP TO DBL TOP PLATE OR BEAM (OR) (1) SIMPSON H3 CLIP TO SINGLE 2x4 PLATE

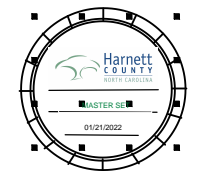

KB HOME
NORTH CAROLINA DIVISION
4518 S. MIAMI BLVD.
SUITE 180
DURHAM, NC 27703
TEL: (919) 768-7988
FAX: (919) 472-0582

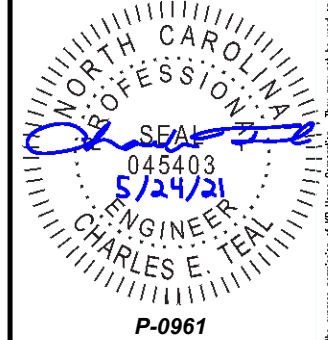

JDS Consulting, PLLC HAS PERFORMED A STRUCTURAL REVIEW OF THESE PLANS. THE STRUCTURAL COMPONENTS COMPLY WITH THE 2018 NORTH CAROLINA RESIDENTIAL CODE FOR ONE- AND TWO-FAMILY DWELLINGS FOR NC PLAN REVIEW. DEVIATION OF ANY STRUCTURAL REQUIREMENTS OF THESE PLANS WITHOUT THE APPROVAL OF THE EOR IS PROHIBITED.

JDS Consulting
8600 D JERSEY CT, RALEIGH, NC 27617-919-480-1075
INFO@JDSCONSULTING.NET | WWW.JDSCONSULTING.NET

PROJECT NO.: 21901127
DATE: 05/21/2021

PLAN:
238.2338

ROOF FRAMING PLAN
S7.0D

These designs and drawings are CONFIDENTIAL, and the exclusive property of KB Home Corporation and are not to be disclosed without the express permission of KB Home Corporation. Copyright © 2019 KB Home Corporation, all rights reserved.

PARTIN/MASON ONLY

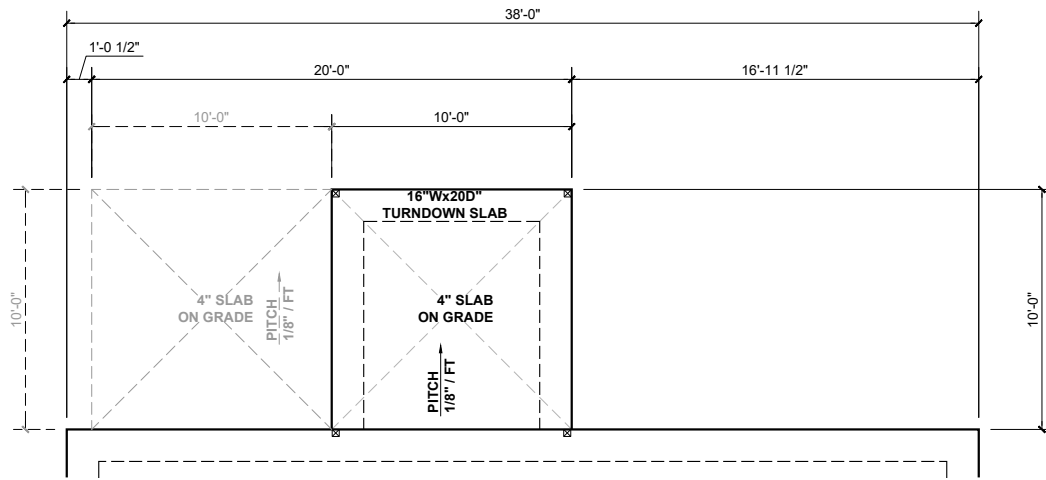

SLAB FDN - 10' COVERED PATIO

SCALE: 1/8" = 1'-0"

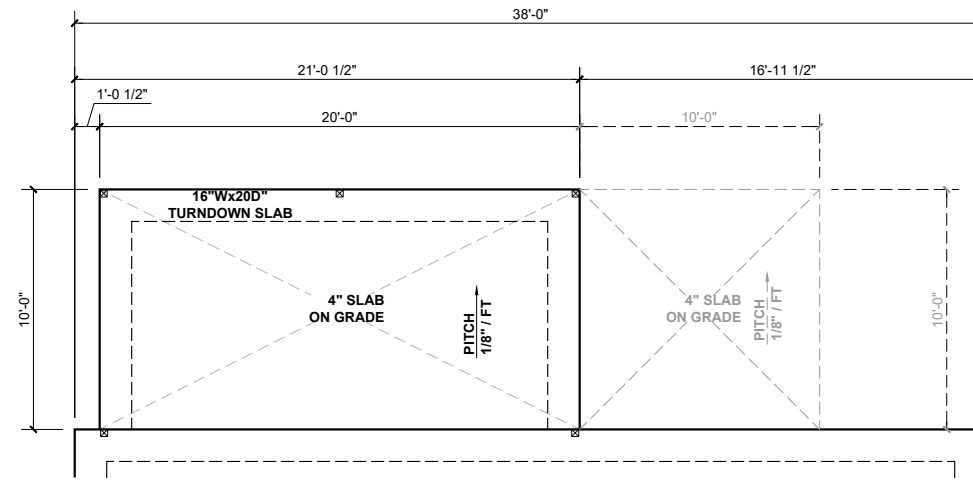

SLAB FDN - EXT. COVERED PATIO

SCALE: 1/8" = 1'-0"

BEAM & POINT LOAD LEGEND

- INTERIOR LOAD BEARING WALL
- - - ROOF RAFTER / TRUSS SUPPORT
- - - DOUBLE RAFTER / DOUBLE JOIST
- STRUCTURAL BEAM / GIRDER
- WINDOW / DOOR HEADER
- ☒ POINT LOAD TRANSFER
- POINT LOAD FROM ABOVE BEARING ON BEAM / GIRDER

SEE FULL PLAN FOR ADDITIONAL INFORMATION

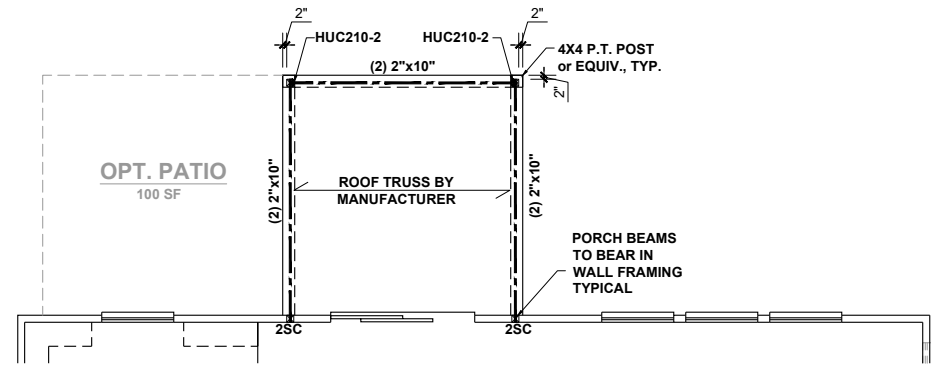

10' COVERED PATIO

SCALE: 1/8" = 1'-0"

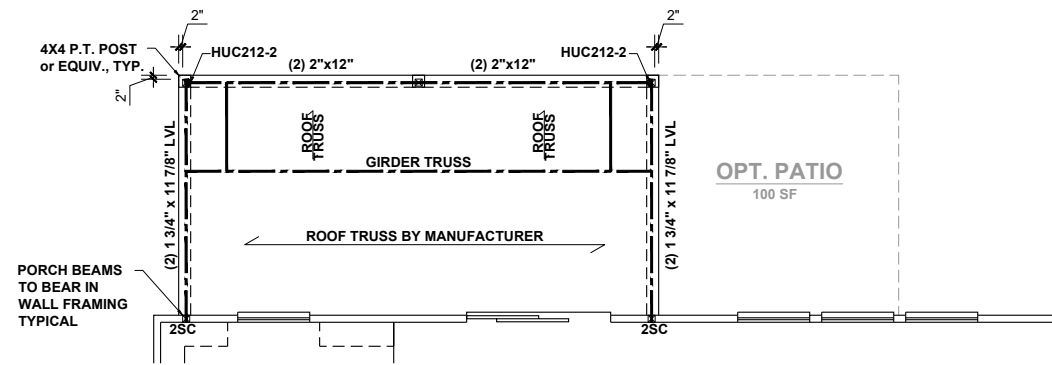

EXT. COVERED PATIO

SCALE: 1/8" = 1'-0"

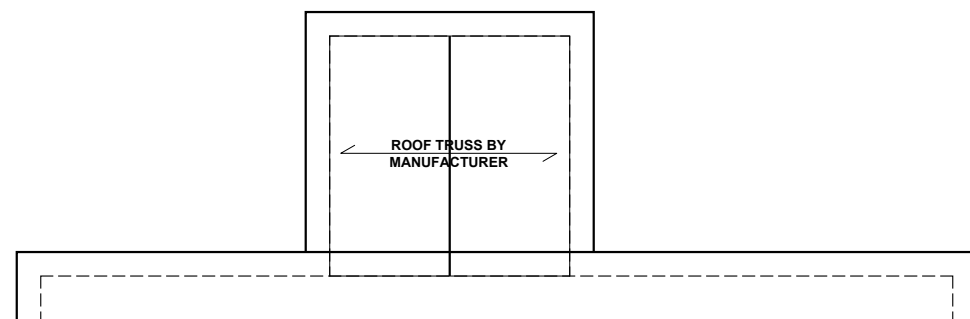

ROOF PLAN

SCALE: 1/8" = 1'-0"

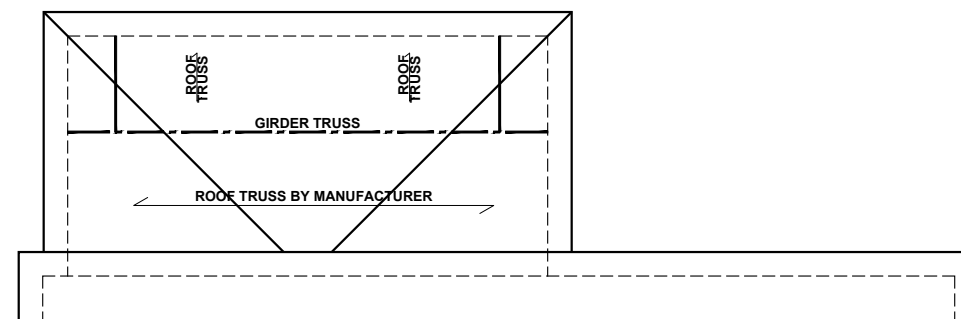

ROOF PLAN

SCALE: 1/8" = 1'-0"

COVERED PATIO



KB HOME
NORTH CAROLINA DIVISION
4518 S. MIAMI BLVD.
SUITE 180
DURHAM, NC 27703
TEL: (919) 768-7988
FAX: (919) 472-0582

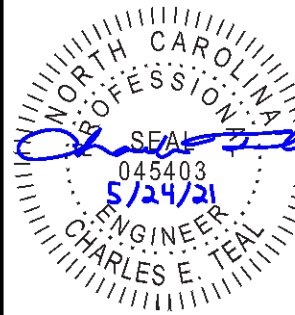

P-0961

JDS Consulting, PLLC HAS PERFORMED A STRUCTURAL REVIEW OF THESE PLANS. THE STRUCTURAL COMPONENTS COMPLY WITH THE 2018 NORTH CAROLINA RESIDENTIAL CODE FOR ONE- AND TWO-FAMILY DWELLINGS FOR NC PLAN REVIEW. DEVIATION OF ANY STRUCTURAL REQUIREMENTS OF THESE PLANS WITHOUT THE APPROVAL OF THE EOR IS PROHIBITED.



8600 D JERSEY CT, RALEIGH, NC 27617-919-480-1075
INFO@JDSCONSULTING.NET ; WWW.JDSCONSULTING.NET

PROJECT NO.: 21901127

DATE: 05/21/2021

PLAN:
238.2338

REAR OPTIONS

R01

These designs and drawings are CONFIDENTIAL, and the exclusive property of KB Home Corporation and are not to be disclosed without the express permission of KB Home Corporation. Copyright 2019 © KB Home Corporation, all rights reserved.

PARTIN/MASON ONLY

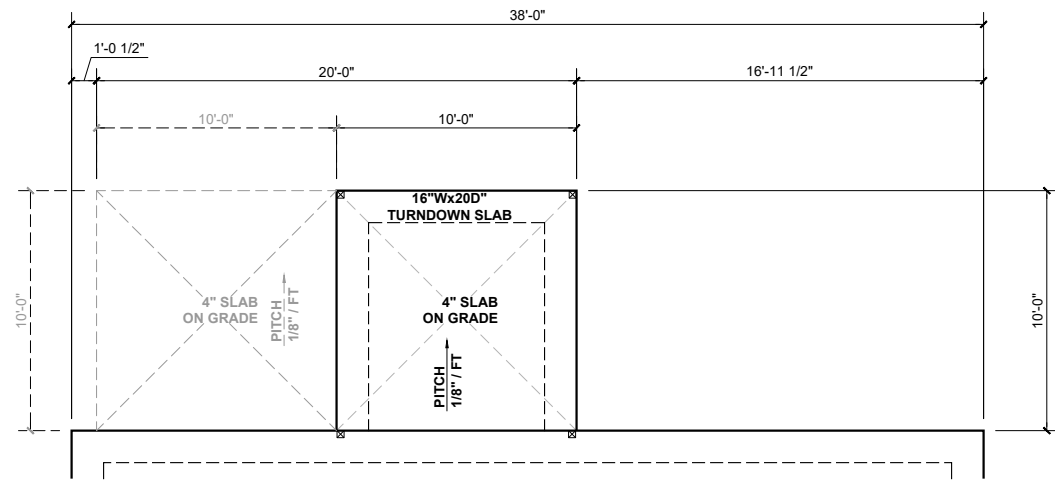

**SLAB FDN - 10' COVERED
SCREENED PATIO**

SCALE: 1/8" = 1'-0"

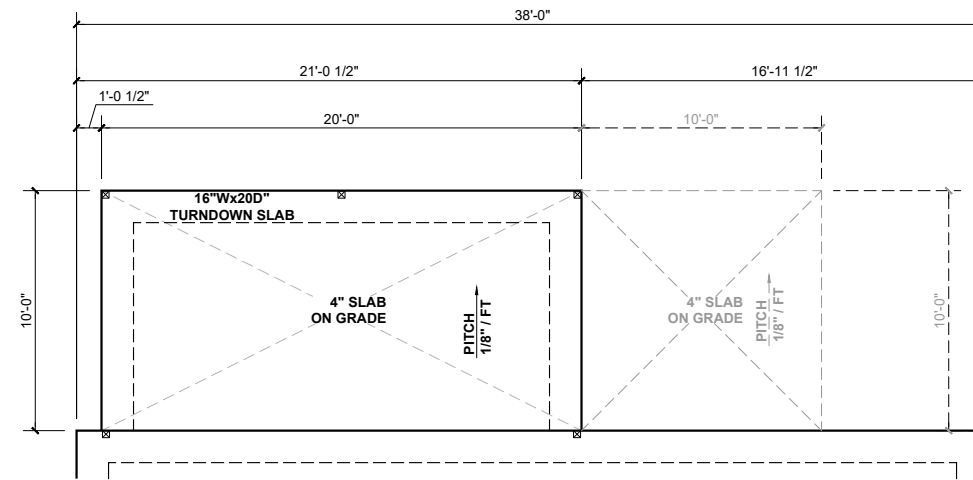

**SLAB FDN - EXT. COVERED
SCREENED PATIO**

SCALE: 1/8" = 1'-0"

BEAM & POINT LOAD LEGEND

- INTERIOR LOAD BEARING WALL
- - - ROOF RAFTER / TRUSS SUPPORT
- - - DOUBLE RAFTER / DOUBLE JOIST
- STRUCTURAL BEAM / GIRDER
- WINDOW / DOOR HEADER
- ⊠ POINT LOAD TRANSFER
- POINT LOAD FROM ABOVE BEARING ON BEAM / GIRDER

SEE FULL PLAN FOR ADDITIONAL INFORMATION



KB HOME
NORTH CAROLINA DIVISION
4518 S. MIAMI BLVD.
SUITE 180
DURHAM, NC 27703
TEL: (919) 768-7988
FAX: (919) 472-0582

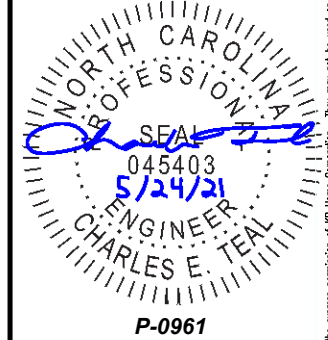

P-0961

JDS Consulting, PLLC HAS PERFORMED A STRUCTURAL REVIEW OF THESE PLANS. THE STRUCTURAL COMPONENTS COMPLY WITH THE 2018 NORTH CAROLINA RESIDENTIAL CODE FOR ONE- AND TWO-FAMILY DWELLINGS FOR NC PLAN REVIEW. DEVIATION OF ANY STRUCTURAL REQUIREMENTS OF THESE PLANS WITHOUT THE APPROVAL OF THE EOR IS PROHIBITED.



PROJECT NO.: 21901127
DATE: 05/21/2021

PLAN:
238.2338

REAR OPTIONS
R02

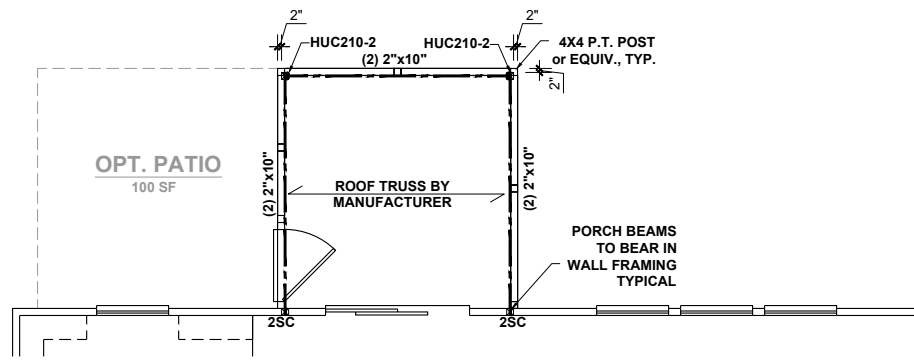

10' COVERED SCREENED PATIO

SCALE: 1/8" = 1'-0"

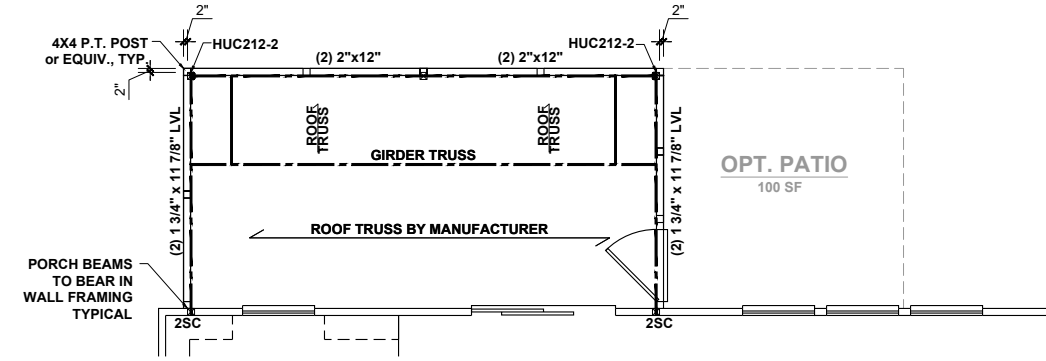

EXT. COVERED SCREENED PATIO

SCALE: 1/8" = 1'-0"

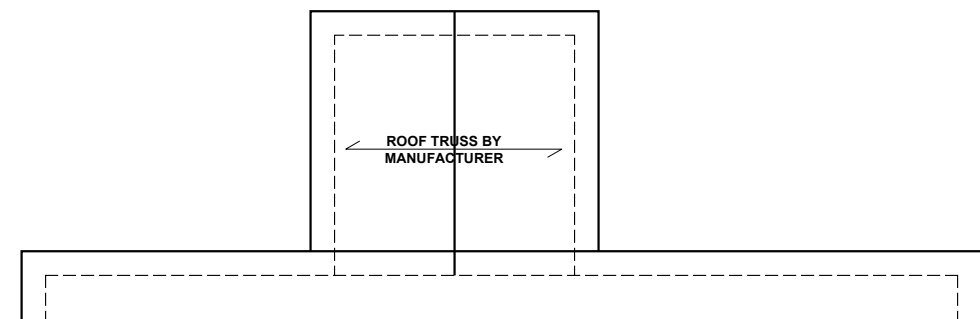

ROOF PLAN

SCALE: 1/8" = 1'-0"

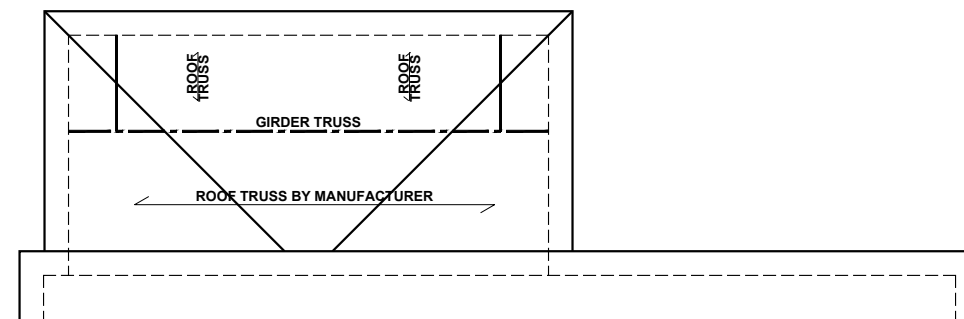

ROOF PLAN

SCALE: 1/8" = 1'-0"

SCREENED COVERED PATIO

These designs and drawings are CONFIDENTIAL, and the exclusive property of KB Home Corporation and are not to be disclosed without the express permission of KB Home Corporation. Copyright 2019 © KB Home Corporation, all rights reserved.

NEW/OLD COMMUNITIES

BEAM & POINT LOAD LEGEND

- INTERIOR LOAD BEARING WALL
- - - ROOF RAFTER / TRUSS SUPPORT
- · - · - DOUBLE RAFTER / DOUBLE JOIST
- STRUCTURAL BEAM / GIRDER
- WINDOW / DOOR HEADER
- ☒ POINT LOAD TRANSFER
- POINT LOAD FROM ABOVE BEARING ON BEAM / GIRDER

SEE FULL PLAN FOR ADDITIONAL INFORMATION



KB HOME
NORTH CAROLINA DIVISION
4518 S. MIAMI BLVD.
SUITE 180
DURHAM, NC 27703
TEL: (919) 768-7988
FAX: (919) 472-0582

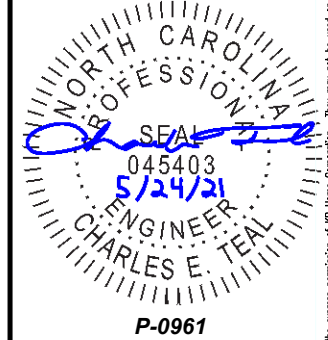

P-0961

JDS Consulting, PLLC HAS PERFORMED A STRUCTURAL REVIEW OF THESE PLANS. THE STRUCTURAL COMPONENTS COMPLY WITH THE 2018 NORTH CAROLINA RESIDENTIAL CODE FOR ONE- AND TWO-FAMILY DWELLINGS FOR NC PLAN REVIEW. DEVIATION OF ANY STRUCTURAL REQUIREMENTS OF THESE PLANS WITHOUT THE APPROVAL OF THE EOR IS PROHIBITED.

JDS Consulting
8600 D JERSEY CT, RALEIGH, NC 27617-919-480.1075
INFO@JDSCONSULTING.NET WWW.JDSCONSULTING.NET

PROJECT NO.: 21901127
DATE: 05/21/2021

PLAN:
238.2338

REAR OPTIONS
R03

OPEN DECK

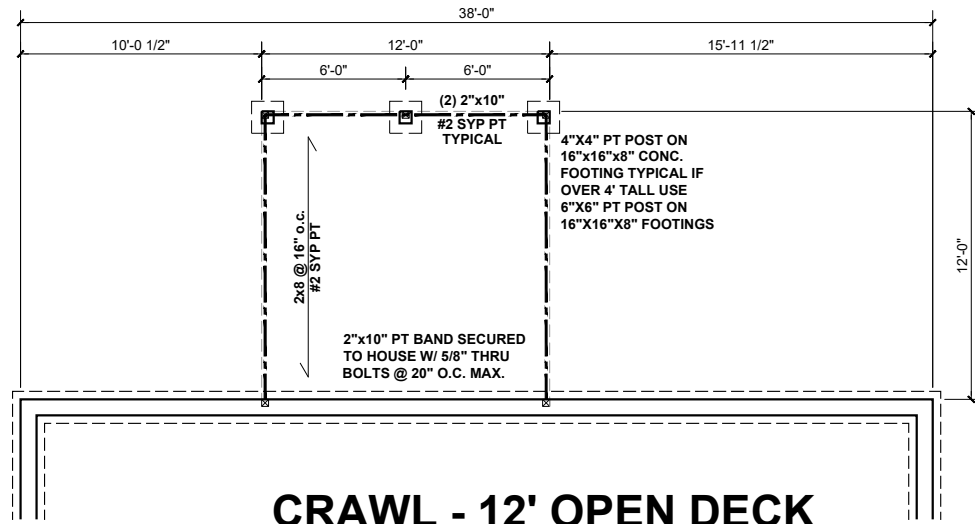

CRAWL - 12' OPEN DECK
SCALE: 1/8" = 1'-0"

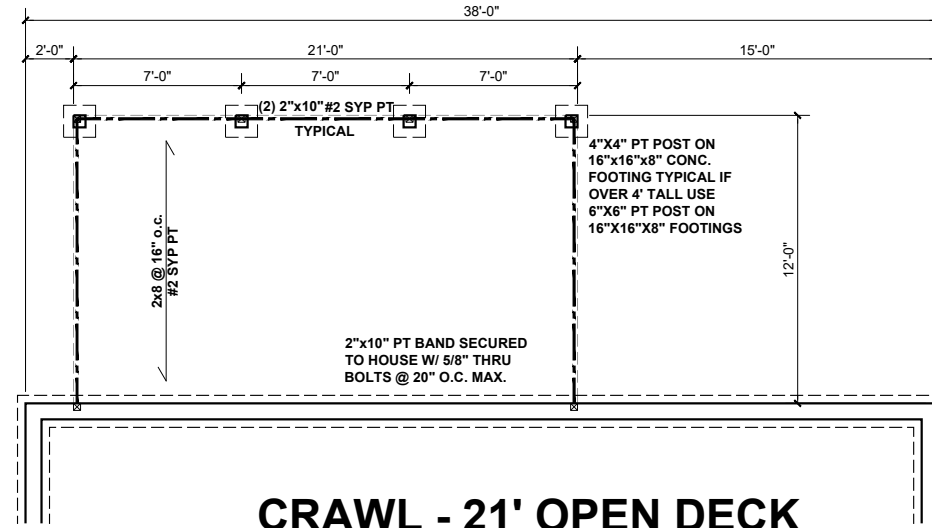

CRAWL - 21' OPEN DECK
SCALE: 1/8" = 1'-0"

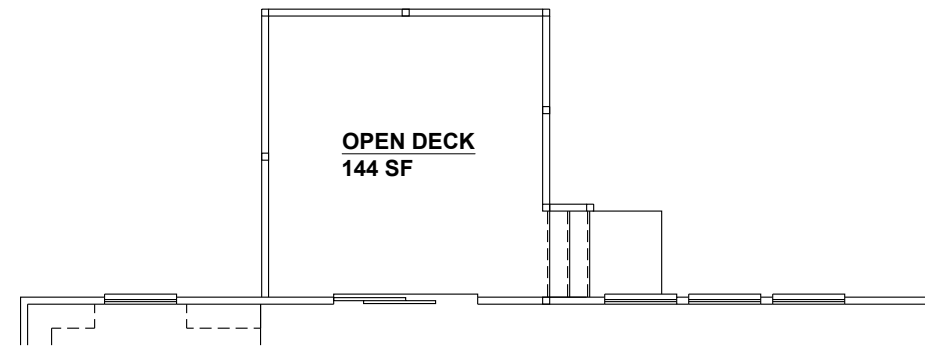

12' OPEN DECK
SCALE: 1/8" = 1'-0"

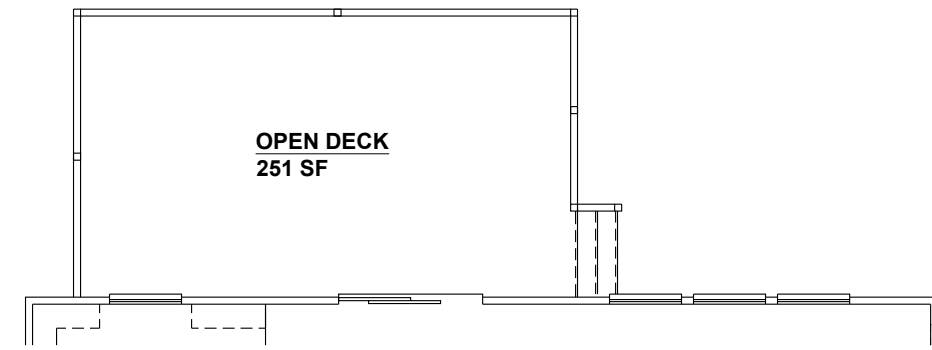

21' OPEN DECK
SCALE: 1/8" = 1'-0"

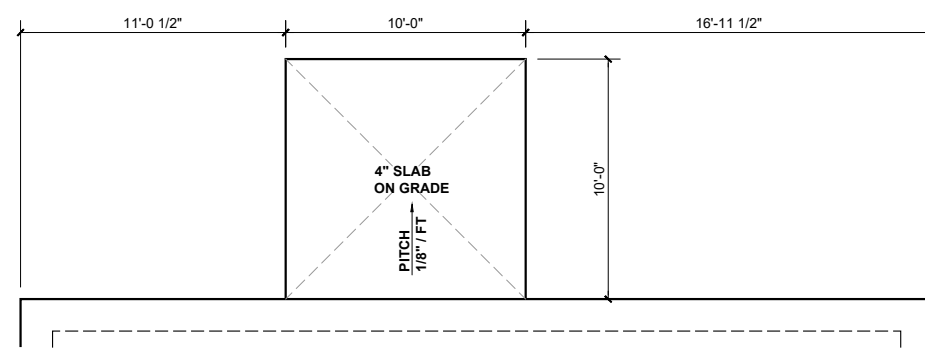

PATIO SLAB
SCALE: 1/8" = 1'-0"

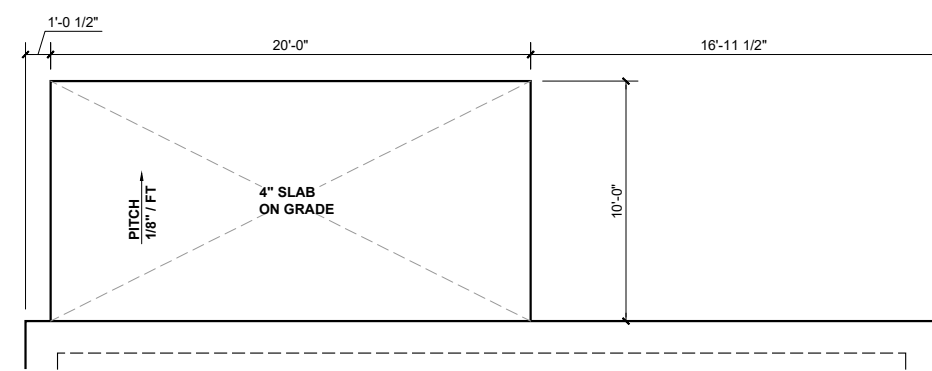

EXT. PATIO SLAB
SCALE: 1/8" = 1'-0"

These designs and drawings are CONFIDENTIAL, and the exclusive property of KB Home Corporation and are not to be disclosed without the express permission of KB Home Corporation. They may not be used or duplicated without the express permission of KB Home Corporation. Copyright 2019 © KB Home Corporation, all rights reserved.

PARTIN/MASON ONLY

BEAM & POINT LOAD LEGEND	
	INTERIOR LOAD BEARING WALL
	ROOF RAFTER / TRUSS SUPPORT
	DOUBLE RAFTER / DOUBLE JOIST
	STRUCTURAL BEAM / GIRDER
	WINDOW / DOOR HEADER
	POINT LOAD TRANSFER
	POINT LOAD FROM ABOVE BEARING ON BEAM / GIRDER

SEE FULL PLAN FOR ADDITIONAL INFORMATION

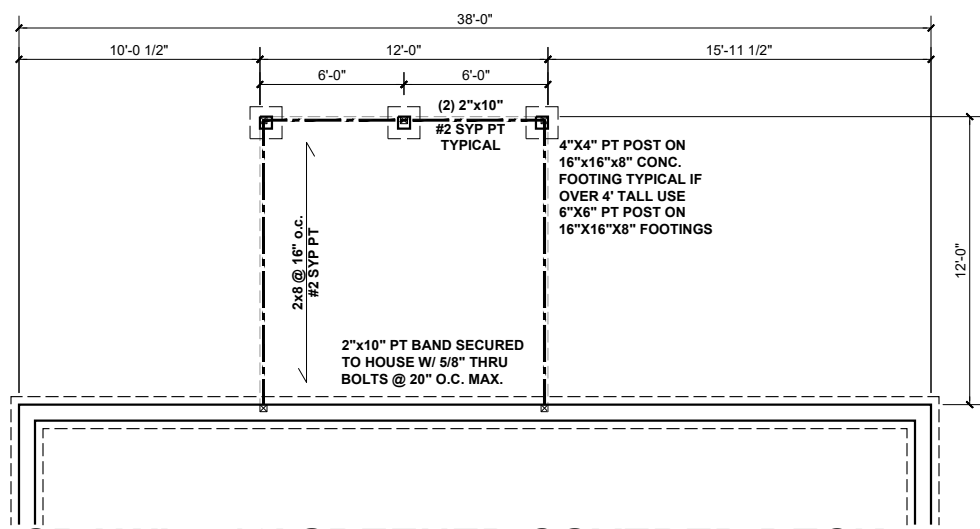

CRAWL - 12' SREENED COVERED DECK
SCALE: 1/8" = 1'-0"

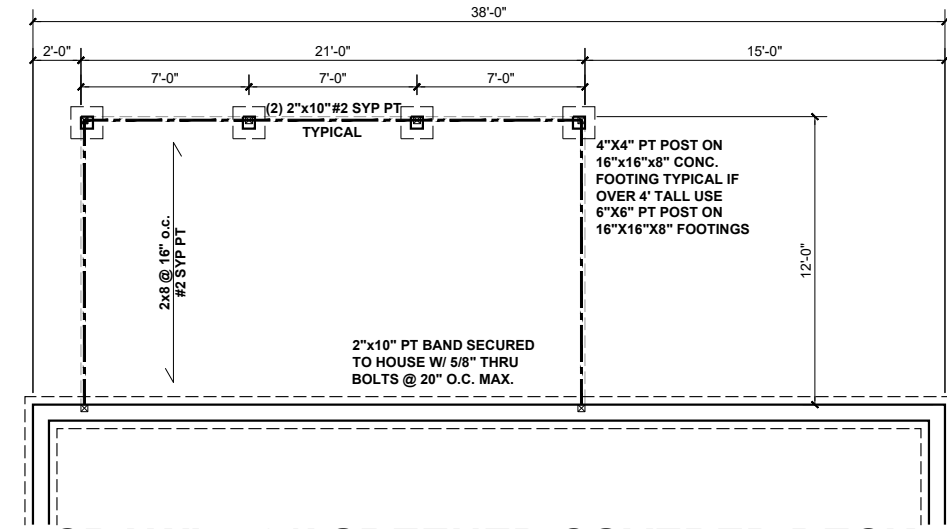

CRAWL - 21' SREENED COVERED DECK
SCALE: 1/8" = 1'-0"

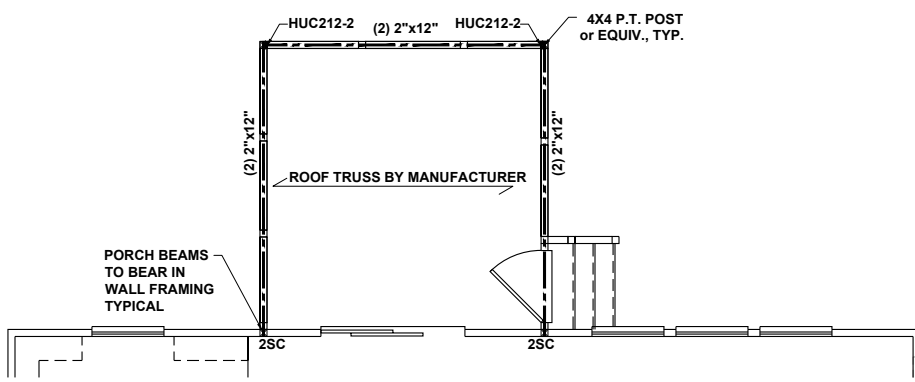

12' SCREENED COVERED DECK
SCALE: 1/8" = 1'-0"

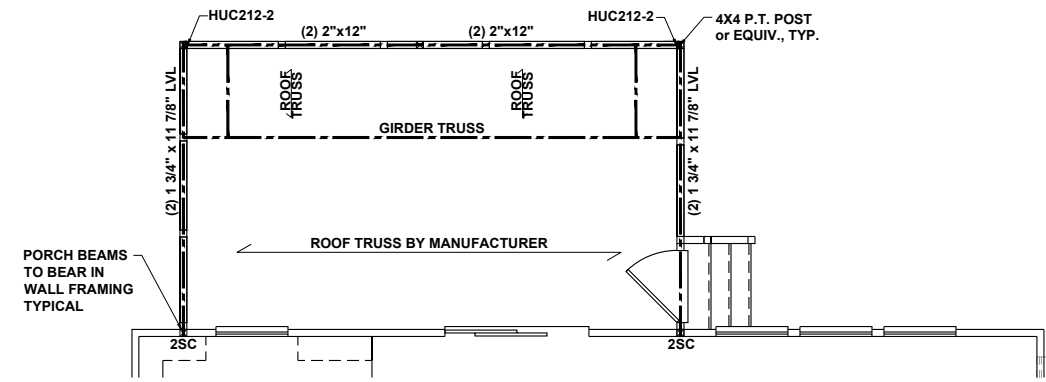

21' SCREENED COVERED DECK
SCALE: 1/8" = 1'-0"

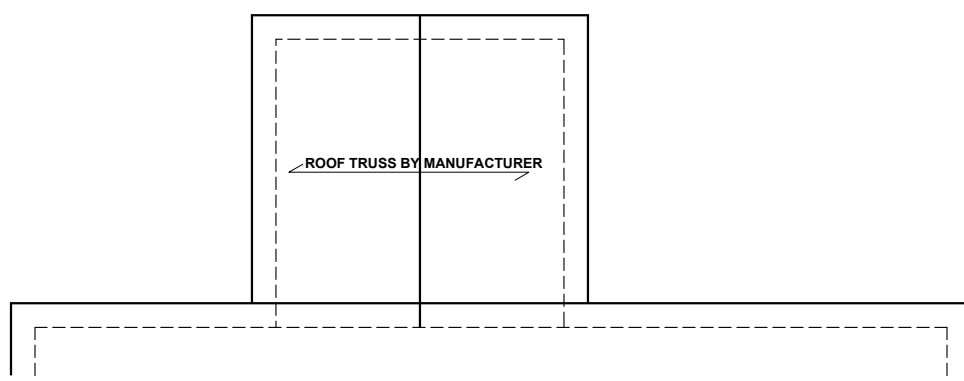

ROOF PLAN
SCALE: 1/8" = 1'-0"

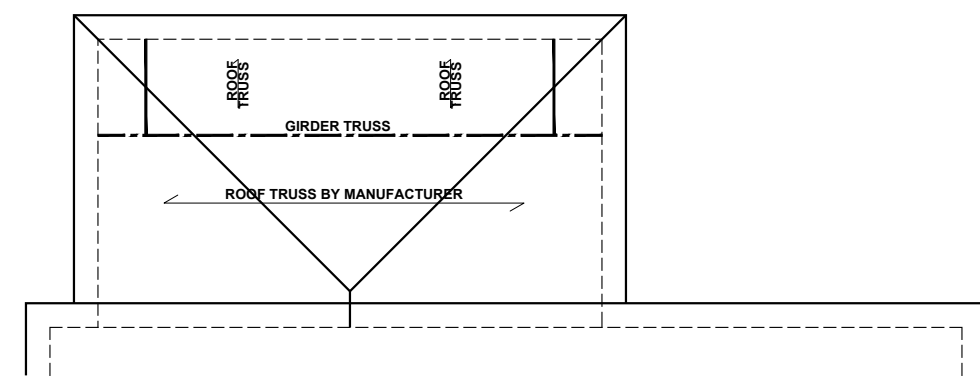

ROOF PLAN
SCALE: 1/8" = 1'-0"

SCREENED COVERED DECK



KB HOME
NORTH CAROLINA DIVISION
4518 S. MIAMI BLVD.
SUITE 180
DURHAM, NC 27703
TEL: (919) 768-7988
FAX: (919) 472-0582

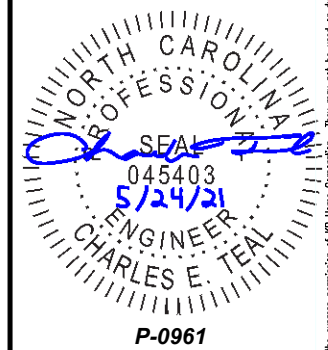

P-0961

JDS Consulting, PLLC HAS PERFORMED A STRUCTURAL REVIEW OF THESE PLANS. THE STRUCTURAL COMPONENTS COMPLY WITH THE 2018 NORTH CAROLINA RESIDENTIAL CODE FOR ONE- AND TWO-FAMILY DWELLINGS FOR NC PLAN REVIEW. DEVIATION OF ANY STRUCTURAL REQUIREMENTS OF THESE PLANS WITHOUT THE APPROVAL OF THE EOR IS PROHIBITED.



PROJECT NO.: 21901127
DATE: 05/21/2021

PLAN:
238.2338

REAR OPTIONS
R04

These designs and drawings are CONFIDENTIAL, and the exclusive property of KB Home Corporation and are not to be disclosed without the express permission of KB Home Corporation. Copyright 2019 © KB Home Corporation. All rights reserved.