

ELEVATION NOTES:
 GRADE ELEVATIONS SHOWN DO NOT NECESSARILY REFER TO THIS OR ANY OTHER LOT; THEY ARE FOR DIAGRAMMATIC PURPOSES ONLY AND MAY VARY. BUILDER IS RESPONSIBLE FOR ADAPTING THIS PLAN TO SUIT THE EXISTING TOPOGRAPHY OF THE SITE.

ROOF VENTILATION TO BE DETERMINED BY BUILDER AS PER CODE.

ALL EGRESS OR RESCUE WINDOWS FROM SLEEPING ROOMS MUST HAVE A MIN. NET CLEAR OPENING OF 4.0 SQ FT. THE MIN NET CLEAR OPENING HEIGHT DIMENSION SHALL BE 22". THE MIN NET CLEAR OPENING WIDTH SHALL BE 20".

EACH EGRESS WINDOW FROM SLEEPING ROOMS MUST HAVE A SILL HGT. OF NO MORE THAN 44" FROM THE FLOOR. ALL WINDOW SIZES ARE NOMINAL AND ARE TO BE VERIFIED WITH MANUFACTURER FOR AVAILABILITY AND CONFORMITY TO STATE AND LOCAL CODE REQUIREMENTS.

PORCHES, BALCONIES, OR RAISED FLOOR SURFACES LOCATED MORE THAN 30" ABOVE THE FLOOR OR GRADE BELOW SHALL HAVE GUARDRAILS NOT LESS THAN 32" IN HEIGHT.

ASSUME NO RESPONSIBILITY FOR ANY DISTANCES AFTER START OF CONSTRUCTION. CONTRACTOR/BUILDER SHALL CONSULT WITH HOME OWNER ON ALL INTERIOR AND EXTERIOR HOLDINGS, TRIMS, COLORS, FINISHES, CABINET LAYOUTS, AND MANUFACTURERS BEFORE CONSTRUCTION BEGINS. ALL BEAMS AND FRAMING MEMBERS ARE SIZED BY OTHERS.

1.1 This plan has been drawn to comply with the 2018 NC Building Code

- 1.2 Minimum Design Loads for Building and Other Structures ASCE 7-98
- 2 Roof Dead Load 15 P&F
 - 3 Roof Live Load 20 P&F
 - 4 Typical Floor Dead Load 10 P&F
 - 5 Floor Live Loads
 - 5.1 Rooms other than sleeping rooms 40 P&F
 - 5.2 Sleeping Rooms 30 P&F
 - 5.3 Stairs 40 P&F
 - 5.4 Decks 40 P&F
 - 5.5 Exterior Balconies 60 P&F
 - 6 Wind Loads
 - 6.1 Ultimate Design Wind Speeds 15 MPH
 - 6.2 Wind Importance Factor, I_W 1.00
 - 6.3 Exposure B
 - 6.4 Walls (Component and Cladding) 25 P&F
 - 6.5 Roofs (Component and Cladding)
 - 6.5.1 Roof Slopes 2.25/12 to 7/12 34.8 P&F
 - 6.5.2 Roof Slopes 7/12 to 12/12 21 P&F

It is the sole responsibility of the Contractor and/or Builder to conform to all standards, provisions, requirements, methods of construction and uses of materials provided in buildings and/or structures as required by NC Uniform Building Code, Local Agencies and in accordance with good engineering practices. Verify all dimensions prior to construction.



FRONT ELEVATION
 SCALE: 1" = 1/4"



REAR ELEVATION
 SCALE: 1" = 1/4"



RIGHT ELEVATION
SCALE: 1" = 1/4"

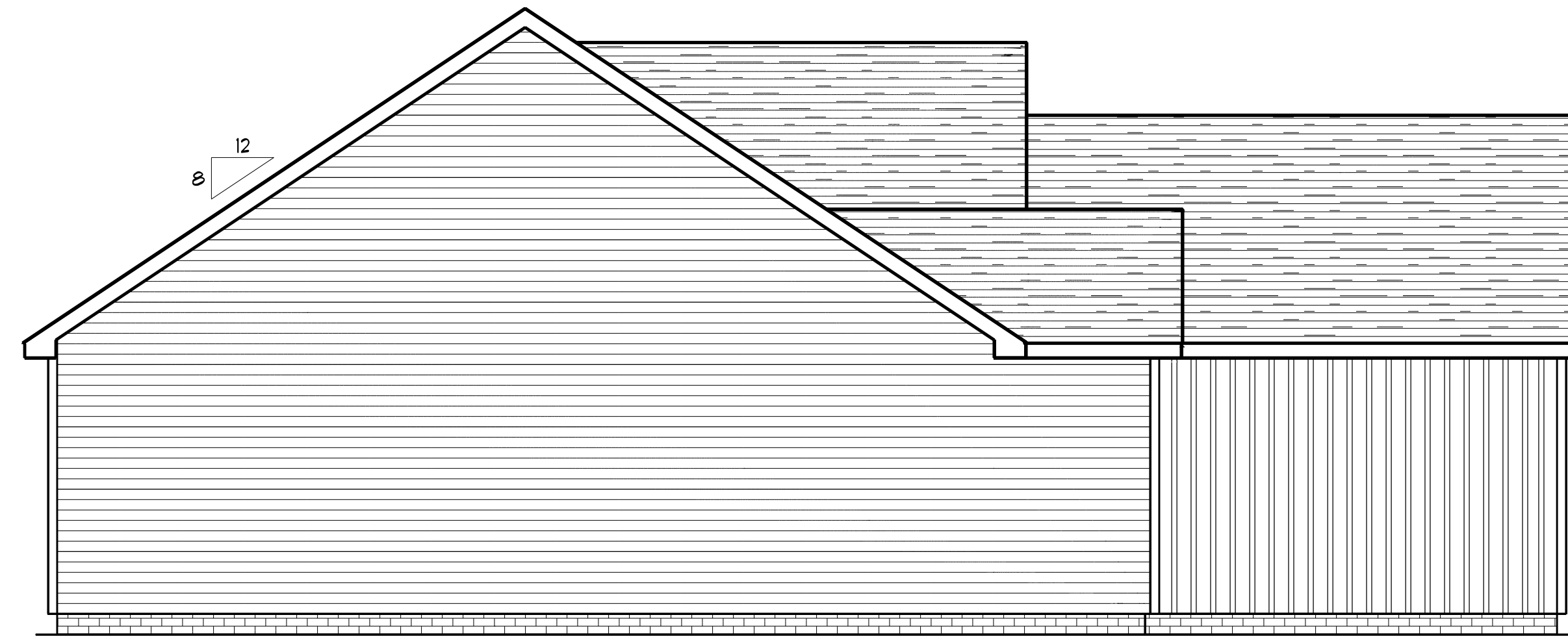

LEFT ELEVATION
SCALE: 1" = 1/4"

FOUNDATION NOTES:
 ALL FOOTINGS SHALL BEAR ON ORIGINAL UNDISTURBED SOIL.
 THE 28 DAY COMPRESSIVE STRENGTH OF ALL FOOTINGS IS 3000 PSI.
 PROVIDE WATER PROOFING AND PERIMETER DRAINS AS REQUIRED.
 FOUNDATION CONCRETE MIX TO HAVE 1-1/2" MAX AGGREGATE SIZE. CONCRETE FILL MIX TO HAVE 1/2" MAX AGGREGATE SIZE.
 FOOTING WIDTHS ARE BASED ON A LOAD-BEARING SOIL CAPACITY OF 2000 PSI.
 PROVIDE 6 MIL POLY VAPOR BARRIER TO COVER GROUND SURFACE IN CRAWL SPACE.
 ALL ANCHOR BOLTS TO BE 12" LONG, 1/2" DIA. A36 UNO ANCHOR BOLTS SHALL BE SPACE AT A MAX OF 6' OC AND NO MORE THAN 1' FROM EA CORNER.

Termite Soil Treatment: Treat entire slab area soil or crawl space surface before vapor barrier is installed and slab is poured with a state approved termiticide. Termiticide should be applied by a licensed and certified pest control professional by the state of North Carolina.

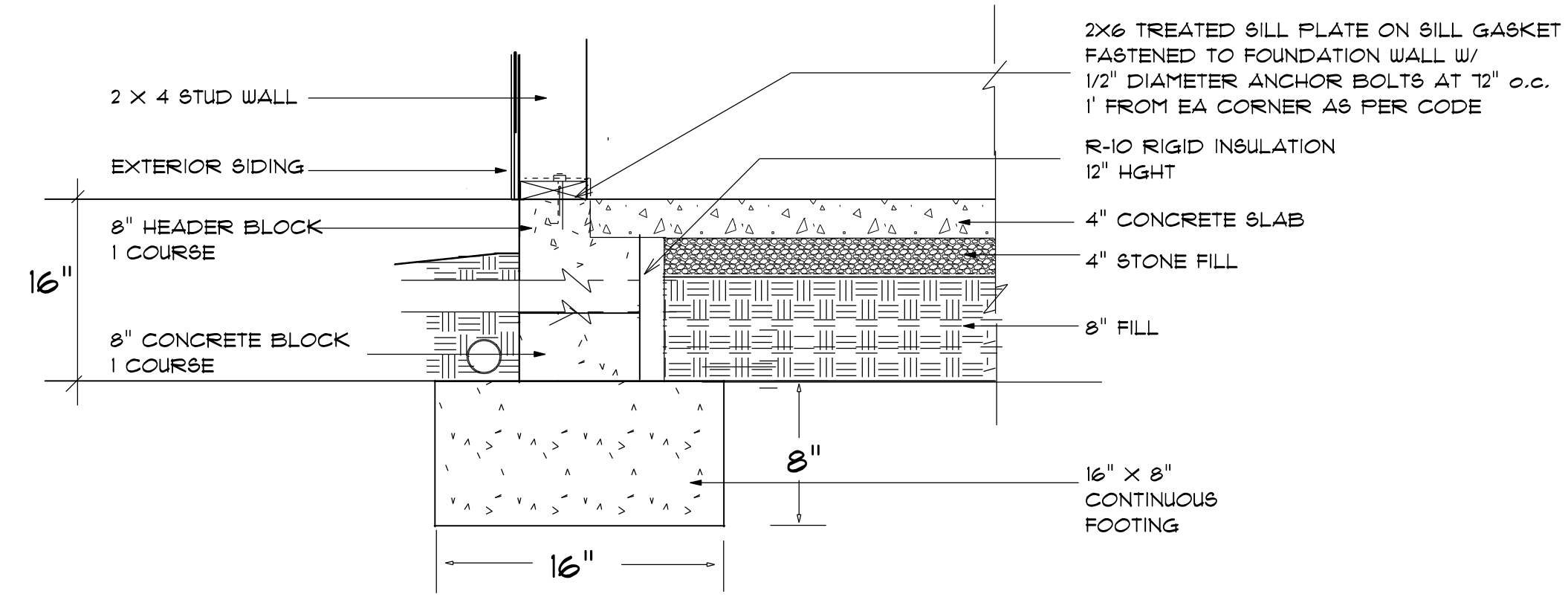

STEM WALL FOUNDATION Detail
 not to scale

PROVIDE EXPANSION JOINTS AT THE EDGES OF SLABS THAT ARE NOT HEATED OR THAT ARE EXPECTED TO CHANGE TEMPERATURE SIGNIFICANTLY OVER THEIR LIFETIMES
 ALSO PROVIDE EXPANSION JOINTS TO ISOLATE BUILDING ELEMENTS THAT PENETRATE SLABS SUCH AS STRUCTURAL COLUMNS, WALLS, OR PLUMBING

WELDED WIRE MESH OR REBAR REINFORCEMENT
 4" MINIMUM CONCRETE SLAB
 6 MIL POLYETHYLENE CONCRETE RATED MOISTURE BARRIER
 4" MIN. COMPACTED GRAVEL -- GRAVEL MUST BE CLEAN AND FREE FROM ORGANIC MATTER
 SOIL MUST BE SOLID AND FREE OF ORGANIC MATERIAL -- SOME SOILS REQUIRE COMPACTION -- IN TERMITE AREAS THE SOIL MAY REQUIRE CHEMICAL TREATMENT -- CONTRACTOR TO VERIFY COMPACTION AND SOIL TREATMENT REQUIREMENTS OF LOCAL AREA

CONTROL JOINTS
 PROVIDE CONTROL JOINTS TO INDUCE CRACKING AT SELECTED LOCATIONS -- TROWEL OR CUT JOINTS INTO THE SURFACE OF SLABS TO ABOUT 1/4 OF THE SLAB DEPTH AND AT 20 FT. INTERVALS -- COLD JOINTS CAN ACT AS CONTROL JTS

CONCRETE SLAB DETAILS / NOTES

not to scale

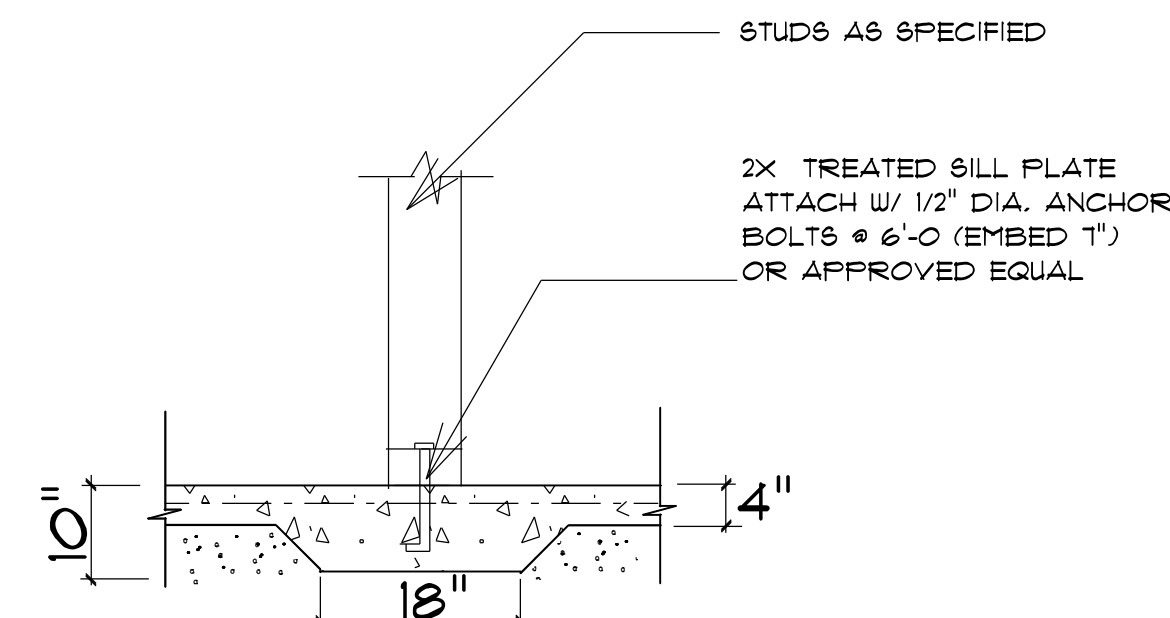

TYPICAL THICKENED SLAB
 not to scale

FOUNDATION NUTS, BOLTS, WASHERS 6'-0, OC 1'-0 FROM EACH CORNER

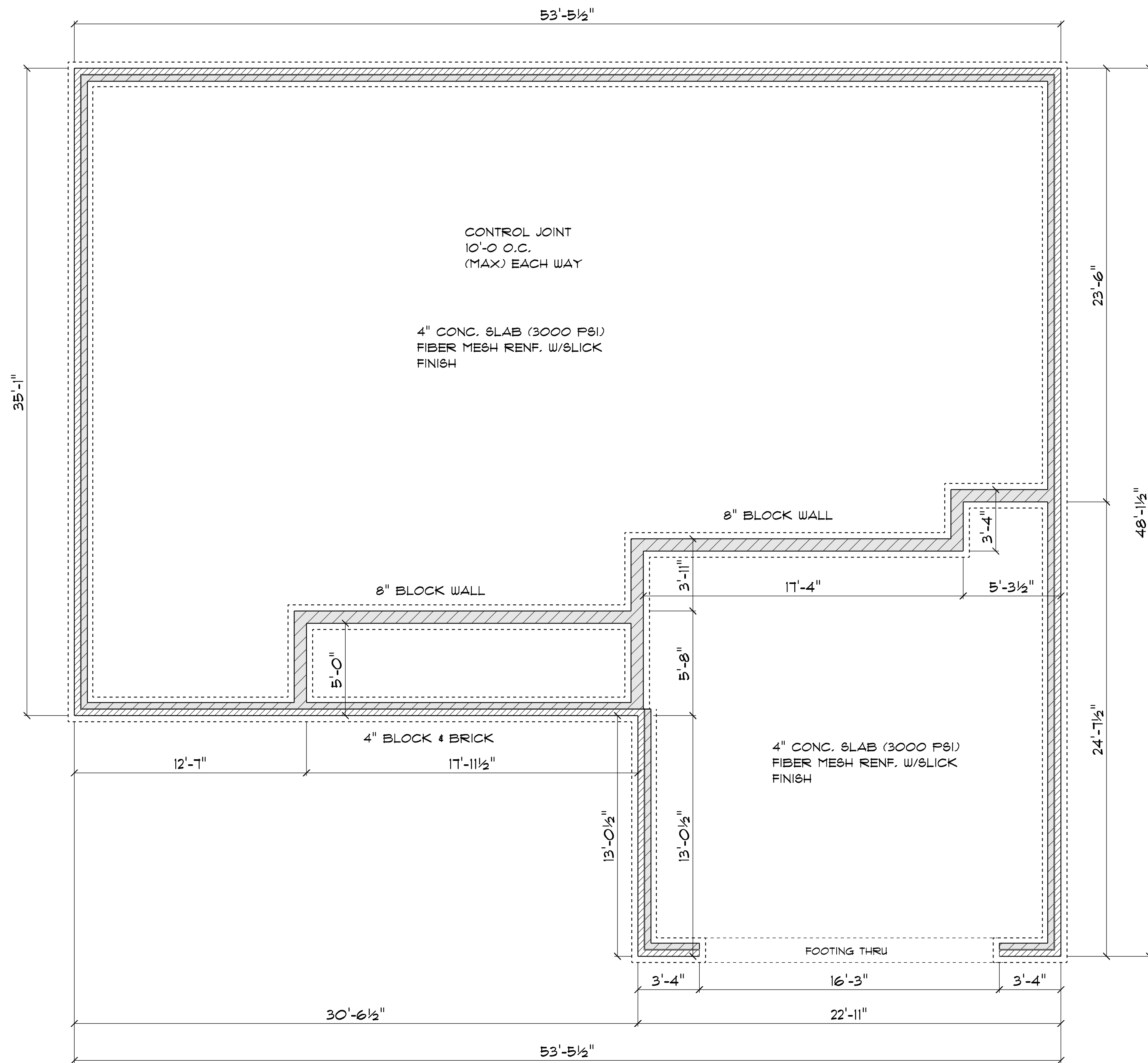

FOUNDATION PLAN
 SCALE: 1" = 1/4"

GENERAL FRAMING NOTES:

ALL LUMBER IN CONTACT WITH CONCRETE OR MASONRY SHALL BE PRESSURE TREATED.

FRAMING LUMBER SHALL BE SYP #2 GRADE AND/OR SPRUCE PINE FIR #1 AND/OR #2, KILN DRIED.

WHERE PRE-ENGINEERED JOISTS ARE USED, JOIST MANUFACTURER SHALL PROVIDE SHOP DRAWINGS, WHICH BEAR SEAL OF A N.C. ENGINEER.

STUDS AND JOISTS SHALL NOT BE CUT TO INSTALL PLUMBING OR WIRING WITHOUT ADDING METAL OR WOOD SIDE PANELS TO STRENGTHEN THE MEMBER TO ITS ORIGINAL CAPACITY.

NAIL MULTIPLE MEMBERS WITH 2 ROWS OF 16d NAILS STAGGERED 32" OC AN USE 3-16d NAILS 2" IN AT EACH END. DOUBLE ALL STUDS UNDER ROOF POST DOWNS UNO.

NAIL FLOOR JOISTS TO BILL PLATE WITH 8d TOE NAILS.

ALL EXPOSED FRAMING ON PORCHES AND DECKS SHALL BE PRESSURE TREATED.

PROVIDE WATERPROOFING AND DRAINS AS REQUIRED.

ALL FRAMING TO BE 16" OC UNO. WALL FRAMING DIMENSIONS ARE BASED ON 2 X 4 STUDS UNO. DOUBLE STUDS UNDER ALL HEADERS.

LVL'S AND TJS TO BE SIZED BY OTHERS

EXTERIOR WALLS IN LIVING AREAS ARE 2 X 4

WINDOW SCHEDULE				
SIZE	COUNT	LIBRARY NAME	R.O. WIDTH	R.O. HEIGHT
2'-0" x 3'-0"	2	Window\Single Hung	24"	36"
2'-8" x 3'-0"	1	Window\Single Hung	32"	36"
2'-8" x 5'-0"	5	Window\Single Hung	32"	60-1/2"
2'-8" x 5'-0" Twin	2	Window\Single Hung	64"	60-1/2"

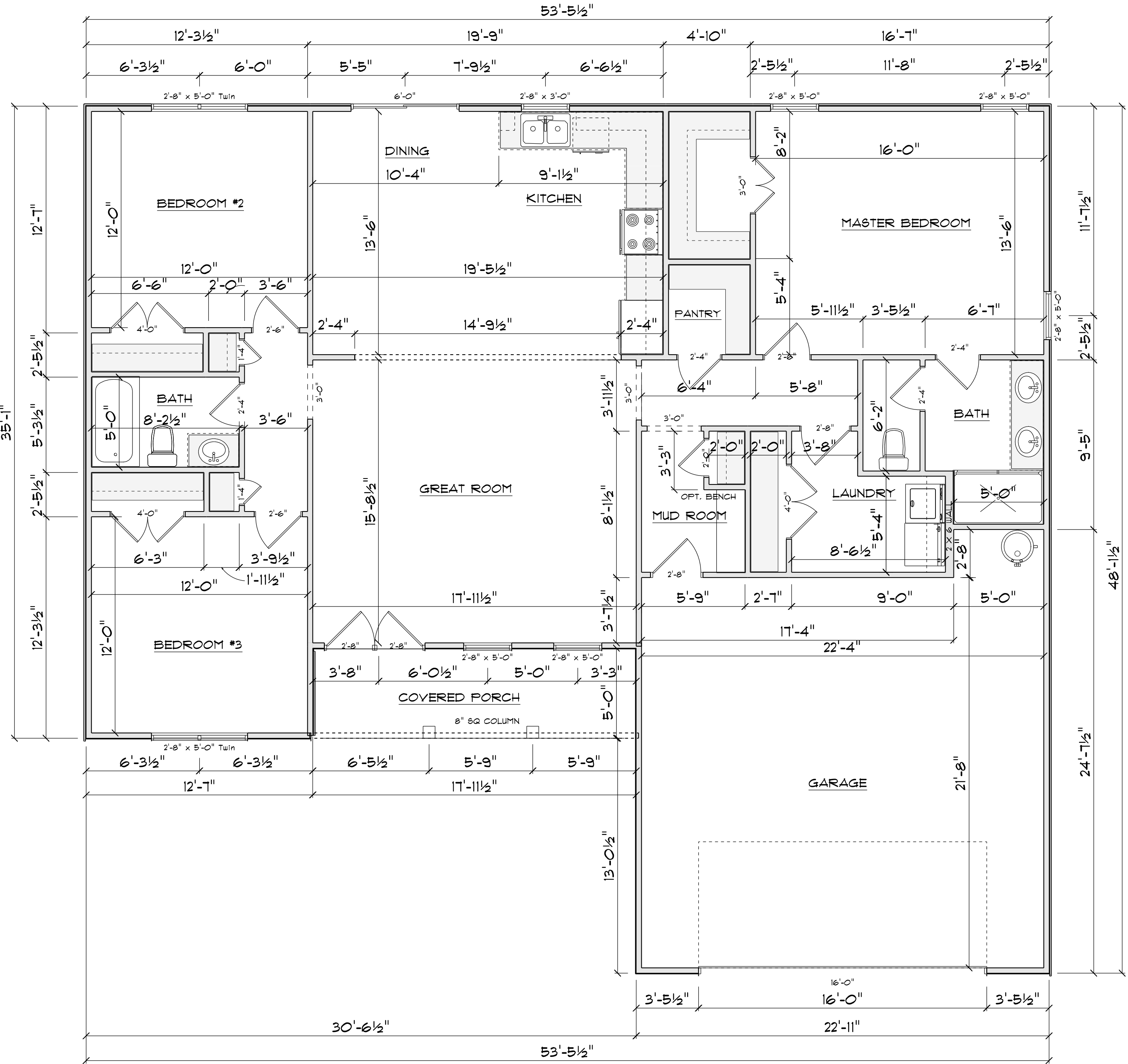

FLOOR PLAN
SCALE: 1/4"

AREA SCHEDULE	
NAME	AREA
Heated	1568 sq ft.
Covered Front Porch	87 sq ft.
Garage	515 sq ft.

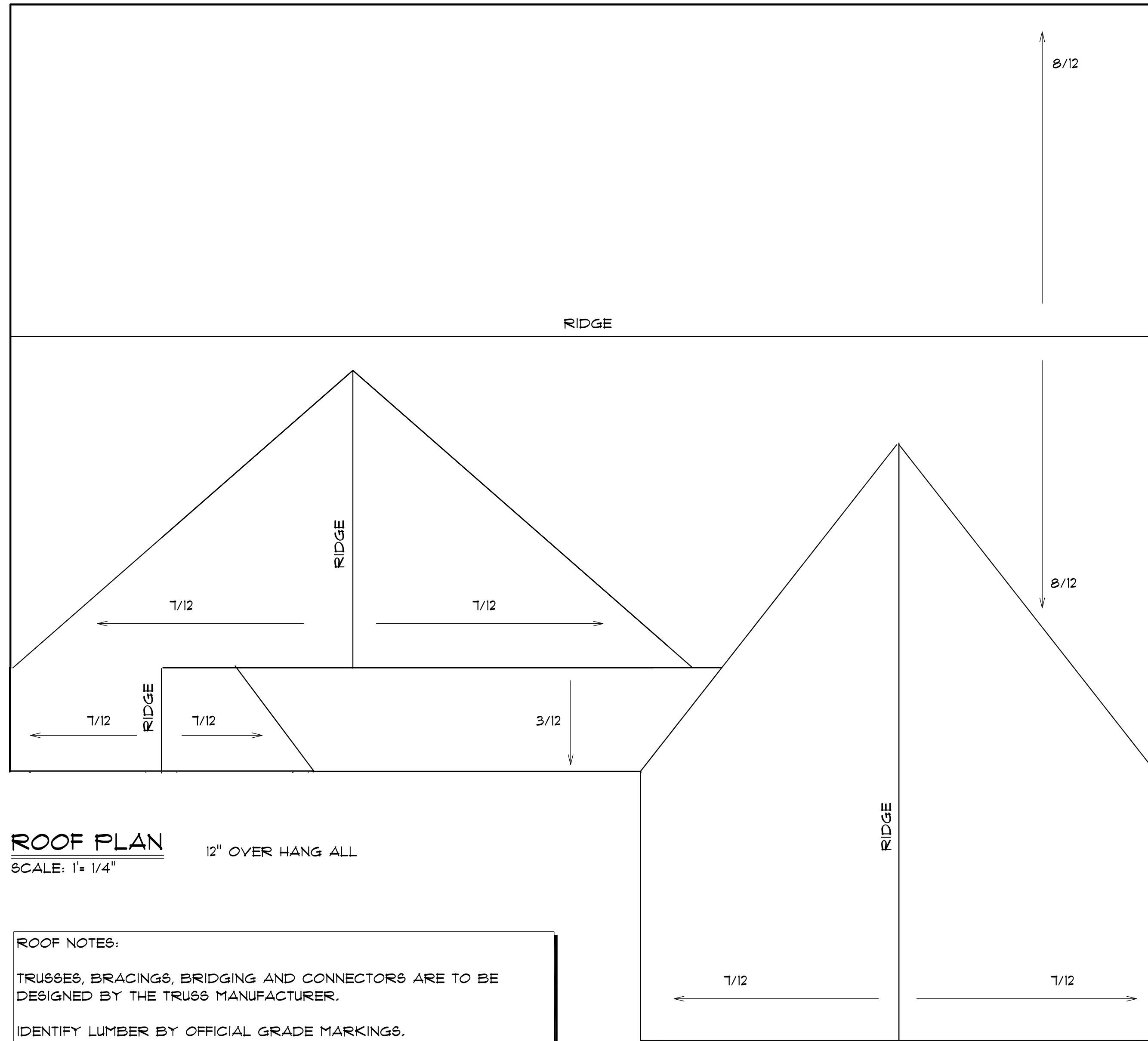

ROOF PLAN 12" OVER HANG ALL
SCALE: 1" = 1/4"

ROOF NOTES:

TRUSSES, BRACINGS, BRIDGING AND CONNECTORS ARE TO BE DESIGNED BY THE TRUSS MANUFACTURER.

IDENTIFY LUMBER BY OFFICIAL GRADE MARKINGS.

DO NOT CUT OR REMOVE CHORDS OR OTHER TRUSS MEMBERS. DO NOT NOTCH OR DRILL TRUSS MEMBERS.

WHERE PRE-ENGINEERED ROOF TRUSSES ARE USED, TRUSS MANUFACTURER SHALL PROVIDE SHOP DRAWINGS, WHICH BEAR SEAL OF A N. C. REGISTERED ENGINEER.



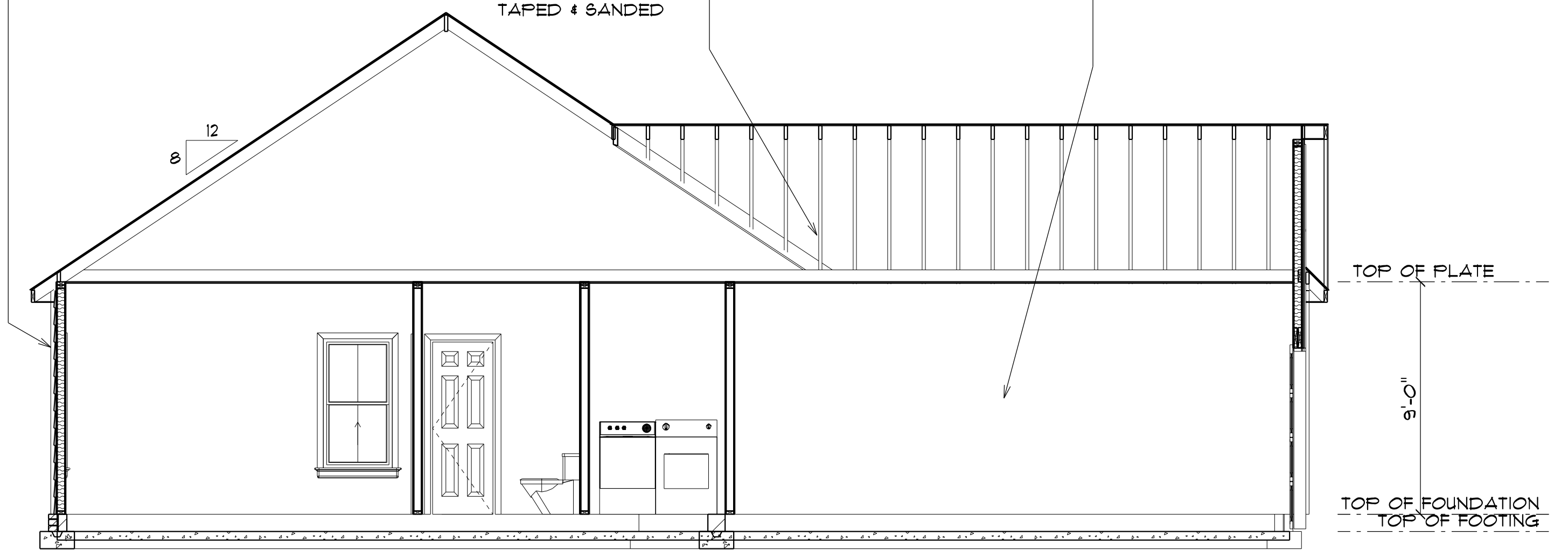

TYPICAL 2x4 SIDING EXTERIOR WALL:
HORIZONTAL SIDING OR BOARD & BATTEN
1/16" PLYWOOD SHEATHING
2x4 STUDS @ 16" o.c.
R15 BATT INSULATION
1/2" DRYWALL
TAPED & SANDED

TYPICAL TRUSS ROOF:
SHINGLES
1/16" ROOFING PLYWOOD c/w
1/4" CLIPS
BLOCK & BRACE PER TRUSS MGR.
PRE-ENGINEERED TRUSSES @ 24" o.c.
2x4 TRUSS BRACING
R30 BLOWN INSULATION
1/2" CEILING BOARD
TAPED & SANDED

TYPICAL 2x4 WALL:
1/2" DRYWALL
TAPED & SANDED
2x4 STUDS @ 16" o.c.
1/2" DRYWALL
TAPED & SANDED

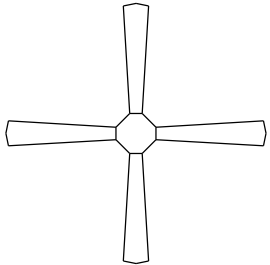

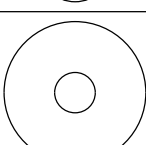
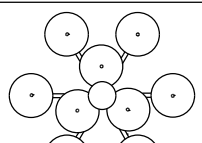
SECTION THROUGH
SCALE: 1" = 1/4"

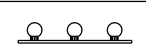
ELECTRICAL LEGEND		
ELECTRICAL	COUNT	SYMBOL
ceiling fan	2	
10" led	6	
7" led	11	
foyer light	1	
dinning room light	1	
coach light	3	
exterior over head light	2	
vanity bar light	3	

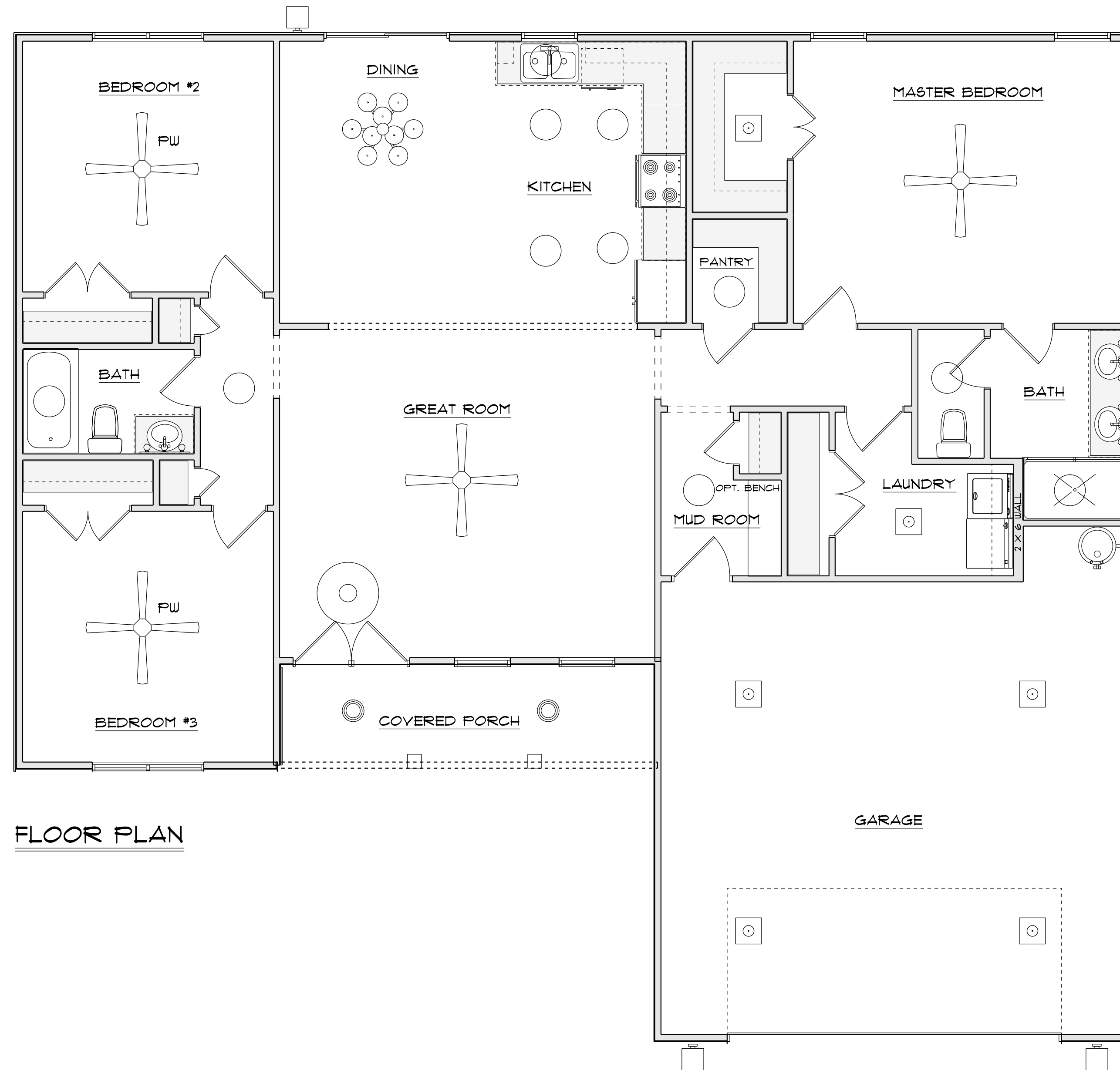

FLOOR PLAN