

RE: J0423-1985  
Lot 52 Williams Farms

Trenco  
818 Soundside Rd  
Edenton, NC 27932

**Site Information:**

Customer: Project Name: J0423-1985  
Lot/Block: Model:  
Address: Subdivision:  
City: State:

**General Truss Engineering Criteria & Design Loads (Individual Truss Design Drawings Show Special Loading Conditions):**

Design Code: IRC2015/TPI2014 Design Program: MiTek 20/20 8.4  
Wind Code: N/A Wind Speed: N/A mph  
Roof Load: N/A psf Floor Load: 55.0 psf

This package includes 6 individual, dated Truss Design Drawings and 0 Additional Drawings.

No.	Seal#	Truss Name	Date
1	I51635712	F01	4/29/2022
2	I51635713	F02	4/29/2022
3	I51635714	F03	4/29/2022
4	I51635715	F04	4/29/2022
5	I51635716	FKW1	4/29/2022
6	I51635717	FKW2	4/29/2022

The truss drawing(s) referenced above have been prepared by Truss Engineering Co. under my direct supervision based on the parameters provided by Comtech, Inc - Fayetteville.

Truss Design Engineer's Name: Gilbert, Eric

My license renewal date for the state of North Carolina is December 31, 2023.

North Carolina COA: C-0844

IMPORTANT NOTE: The seal on these truss component designs is a certification that the engineer named is licensed in the jurisdiction(s) identified and that the designs comply with ANSI/TPI 1. These designs are based upon parameters shown (e.g., loads, supports, dimensions, shapes and design codes), which were given to TRENCO. Any project specific information included is for TRENCO customers file reference purpose only, and was not taken into account in the preparation of these designs. TRENCO has not independently verified the applicability of the design parameters or the designs for any particular building. Before use, the building designer should verify applicability of design parameters and properly incorporate these designs into the overall building design per ANSI/TPI 1, Chapter 2.



April 29, 2022

Job	Truss	Truss Type	Qty	Ply	Lot 52 Williams Farms	151635712
J0423-1985	F01	FLOOR	4	1	Job Reference (optional)	

Comtech, Inc., Fayetteville, NC - 28314,

8.430 s Aug 16 2021 MiTek Industries, Inc. Thu Apr 28 09:01:46 2022 Page 1  
ID:QdRWmBS7rn75moFzg6tYesyW6Ye-cO83RWQlo?zBpjBm8h\_4jfgJmhON?eXT4VBP1zMEOp

0-1-8

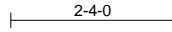
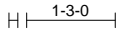

Scale = 1:32.5

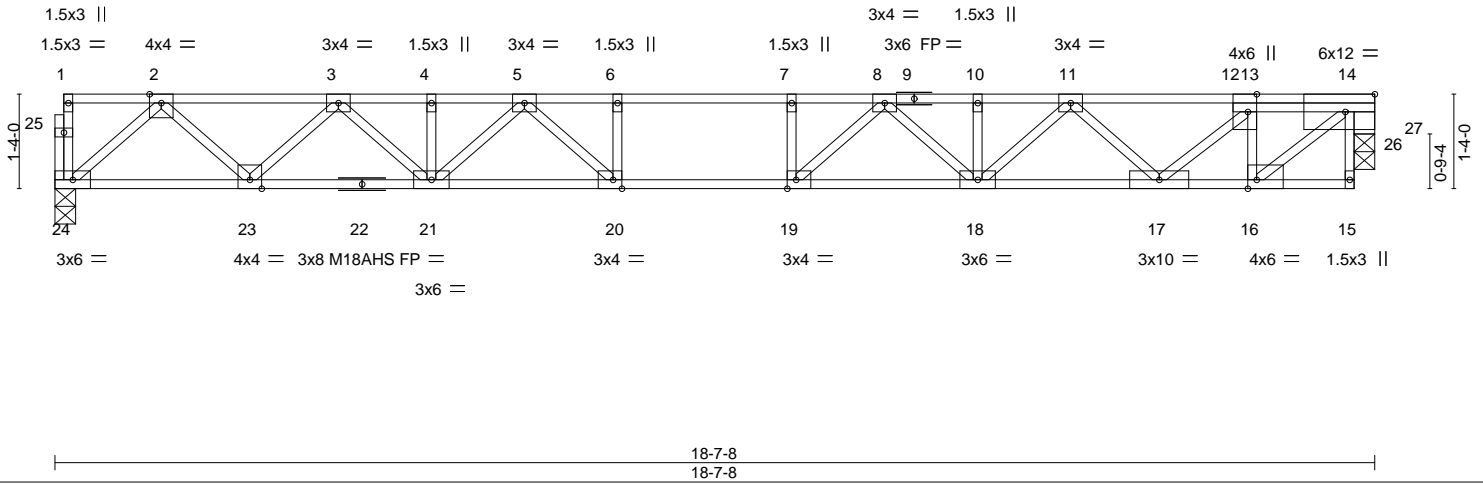

Plate Offsets (X,Y)-- [13:0-3-0,Edge], [14:0-5-0,Edge], [16:0-1-8,Edge], [19:0-1-8,Edge], [20:0-1-8,Edge]

LOADING (psf)	SPACING-	CSI.	DEFL.	PLATES	GRIP
TCLL 40.0	2-0-0	TC 0.74	in (loc) l/defl L/d	MT20	244/190
TCDL 10.0	Plate Grip DOL 1.00	BC 0.85	Vert(LL) -0.26 18-19 >831 480	M18AHS	186/179
BCLL 0.0	Lumber DOL 1.00	WB 0.69	Vert(CT) -0.36 18-19 >617 360		
BCDL 5.0	Rep Stress Incr YES	Matrix-S	Horz(CT) 0.03 27 n/a n/a		
	Code IRC2015/TPI2014			Weight: 100 lb	FT = 20%F, 11%E

**LUMBER-**  
 TOP CHORD 2x4 SP No.1(flat)  
 BOT CHORD 2x4 SP No.1(flat)  
 WEBS 2x4 SP No.3(flat)  
 OTHERS 4x4 SP No.2(flat)

**BRACING-**  
 TOP CHORD Structural wood sheathing directly applied or 6-0-0 oc purlins, except end verticals.  
 BOT CHORD Rigid ceiling directly applied or 10-0-0 oc bracing.

**REACTIONS.** (size) 24=0-3-8, 27=0-3-8  
 Max Grav 24=999(LC 1), 27=991(LC 1)

**FORCES.** (lb) - Max. Comp./Max. Ten. - All forces 250 (lb) or less except when shown.  
 TOP CHORD 2-3=-1839/0, 3-4=-3087/0, 4-5=-3087/0, 5-6=-3753/0, 6-7=-3753/0, 7-8=-3753/0,  
 8-10=-3158/0, 10-11=-3158/0, 11-13=-1955/0, 13-14=-1179/0  
 BOT CHORD 23-24=0/1085, 21-23=0/2562, 20-21=0/3474, 19-20=0/3753, 18-19=0/3517, 17-18=0/2639,  
 16-17=0/1179  
 WEBS 13-16=-907/0, 14-16=0/1440, 2-24=-1442/0, 2-23=0/1048, 3-23=-1006/0, 3-21=0/714,  
 5-21=-526/0, 5-20=-22/698, 6-20=-353/0, 13-17=0/1031, 11-17=-951/0, 11-18=0/705,  
 8-18=-489/0, 8-19=-62/658, 7-19=-336/0, 14-27=-1021/0

- NOTES-**
- Unbalanced floor live loads have been considered for this design.
  - All plates are MT20 plates unless otherwise indicated.
  - Plates checked for a plus or minus 1 degree rotation about its center.
  - Bearing at joint(s) 27 considers parallel to grain value using ANSI/TPI 1 angle to grain formula. Building designer should verify capacity of bearing surface.
  - Recommend 2x6 strongbacks, on edge, spaced at 10-0-0 oc and fastened to each truss with 3-10d (0.131" X 3") nails. Strongbacks to be attached to walls at their outer ends or restrained by other means.
  - CAUTION, Do not erect truss backwards.

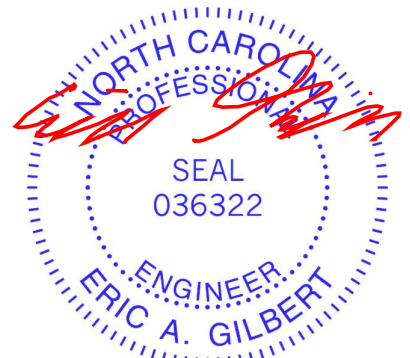

April 29, 2022

**WARNING - Verify design parameters and READ NOTES ON THIS AND INCLUDED MITEK REFERENCE PAGE MII-7473 rev. 5/19/2020 BEFORE USE.**  
 Design valid for use only with MiTek® connectors. This design is based only upon parameters shown, and is for an individual building component, not a truss system. Before use, the building designer must verify the applicability of design parameters and properly incorporate this design into the overall building design. Bracing indicated is to prevent buckling of individual truss web and/or chord members only. Additional temporary and permanent bracing is always required for stability and to prevent collapse with possible personal injury and property damage. For general guidance regarding the fabrication, storage, delivery, erection and bracing of trusses and truss systems, see **ANSI/TPI1 Quality Criteria, DSB-89 and BCSI Building Component Safety Information** available from Truss Plate Institute, 2670 Crain Highway, Suite 203 Waldorf, MD 20601



Job	Truss	Truss Type	Qty	Ply	Lot 52 Williams Farms	151635713
J0423-1985	F02	FLOOR	2	1	Job Reference (optional)	

Comtech, Inc., Fayetteville, NC - 28314,

8.430 s Aug 16 2021 MiTek Industries, Inc. Thu Apr 28 09:01:47 2022 Page 1  
ID:QdRWmBS7rn75moFzg6tYesyW6Ye-5aiResRwYJ52RtlyiPVJGsrddA1J6VkhikEkxTzMEo

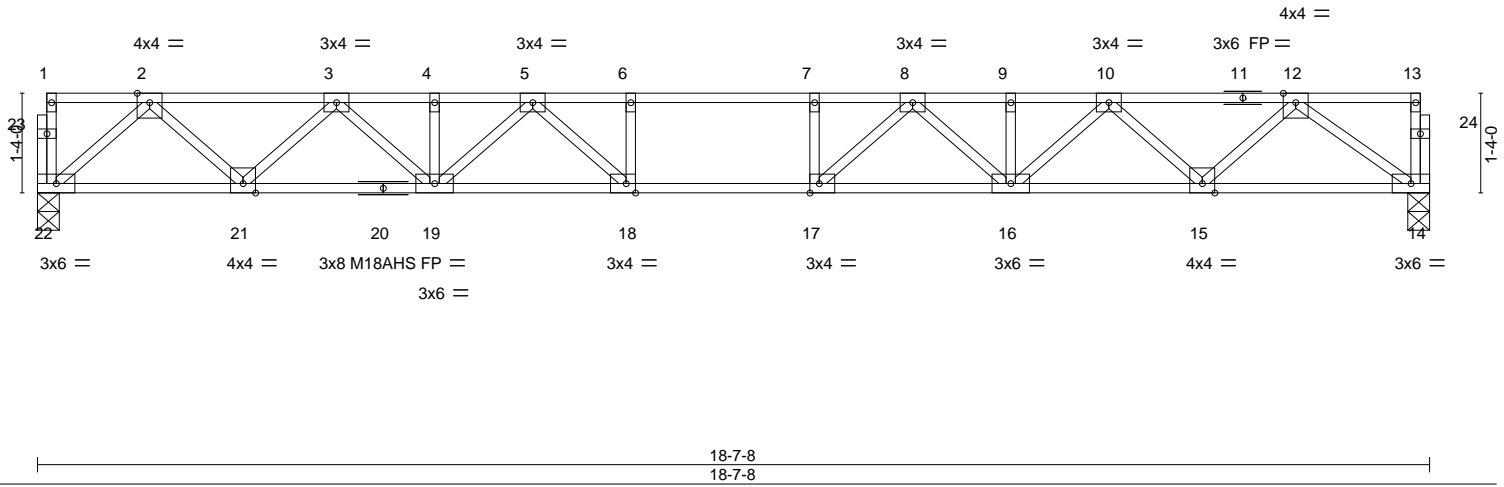
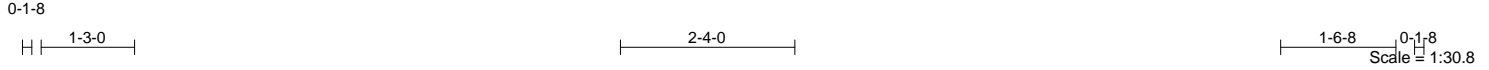

Plate Offsets (X,Y)-- [17:0-1-8,Edge], [18:0-1-8,Edge]

LOADING (psf)	SPACING-	2-0-0	CSI.	DEFL.	in (loc)	l/defl	L/d	PLATES	GRIP
TCLL 40.0	Plate Grip DOL	1.00	TC 0.77	Vert(LL)	-0.27 16-17	>810	480	MT20	244/190
TCDL 10.0	Lumber DOL	1.00	BC 0.87	Vert(CT)	-0.37 16-17	>600	360	M18AHS	186/179
BCLL 0.0	Rep Stress Incr	YES	WB 0.50	Horz(CT)	0.07 14	n/a	n/a		
BCDL 5.0	Code	IRC2015/TPI2014	Matrix-S						
								Weight: 97 lb	FT = 20%F, 11%E

**LUMBER-**  
 TOP CHORD 2x4 SP No.1(flat)  
 BOT CHORD 2x4 SP No.1(flat)  
 WEBS 2x4 SP No.3(flat)

**BRACING-**  
 TOP CHORD Structural wood sheathing directly applied or 6-0-0 oc purlins, except end verticals.  
 BOT CHORD Rigid ceiling directly applied or 10-0-0 oc bracing.

**REACTIONS.** (size) 22=0-3-8, 14=0-3-8  
 Max Grav 22=1004(LC 1), 14=1004(LC 1)

**FORCES.** (lb) - Max. Comp./Max. Ten. - All forces 250 (lb) or less except when shown.  
 TOP CHORD 2-3=-1851/0, 3-4=-3112/0, 4-5=-3112/0, 5-6=-3796/0, 6-7=-3796/0, 7-8=-3796/0,  
 8-9=-3216/0, 9-10=-3216/0, 10-12=-2022/0  
 BOT CHORD 21-22=0/1092, 19-21=0/2580, 18-19=0/3505, 17-18=0/3796, 16-17=0/3573, 15-16=0/2718,  
 14-15=0/1295  
 WEBS 2-22=-1451/0, 2-21=0/1057, 3-21=-1014/0, 3-19=0/722, 5-19=-535/0, 5-18=-13/712,  
 6-18=-360/0, 12-14=-1596/0, 12-15=0/1011, 10-15=-969/0, 10-16=0/676, 8-16=-485/0,  
 8-17=-76/650, 7-17=-332/0

- NOTES-**
- 1) Unbalanced floor live loads have been considered for this design.
  - 2) All plates are MT20 plates unless otherwise indicated.
  - 3) All plates are 1.5x3 MT20 unless otherwise indicated.
  - 4) Plates checked for a plus or minus 1 degree rotation about its center.
  - 5) Recommend 2x6 strongbacks, on edge, spaced at 10-0-0 oc and fastened to each truss with 3-10d (0.131" X 3") nails. Strongbacks to be attached to walls at their outer ends or restrained by other means.



April 29, 2022

**WARNING - Verify design parameters and READ NOTES ON THIS AND INCLUDED MITEK REFERENCE PAGE MII-7473 rev. 5/19/2020 BEFORE USE.**

Design valid for use only with MiTek® connectors. This design is based only upon parameters shown, and is for an individual building component, not a truss system. Before use, the building designer must verify the applicability of design parameters and properly incorporate this design into the overall building design. Bracing indicated is to prevent buckling of individual truss web and/or chord members only. Additional temporary and permanent bracing is always required for stability and to prevent collapse with possible personal injury and property damage. For general guidance regarding the fabrication, storage, delivery, erection and bracing of trusses and truss systems, see

**ANSI/TPI1 Quality Criteria, DSB-89 and BCSI Building Component**

**Safety Information** available from Truss Plate Institute, 2670 Crain Highway, Suite 203 Waldorf, MD 20601



818 Soundside Road  
 Edenton, NC 27932

Job	Truss	Truss Type	Qty	Ply	Lot 52 Williams Farms	151635714
J0423-1985	F03	FLOOR	3	1	Job Reference (optional)	

Comtech, Inc., Fayetteville, NC - 28314,

8.430 s Aug 16 2021 MiTek Industries, Inc. Thu Apr 28 09:01:48 2022 Page 1  
ID:QdRWmBS7rn75moFzg6tYesyW6Ye-ZnGpsBSZJdDv30K8F61Yo4N0UZOCr\_tqxN\_ITvzMEOn

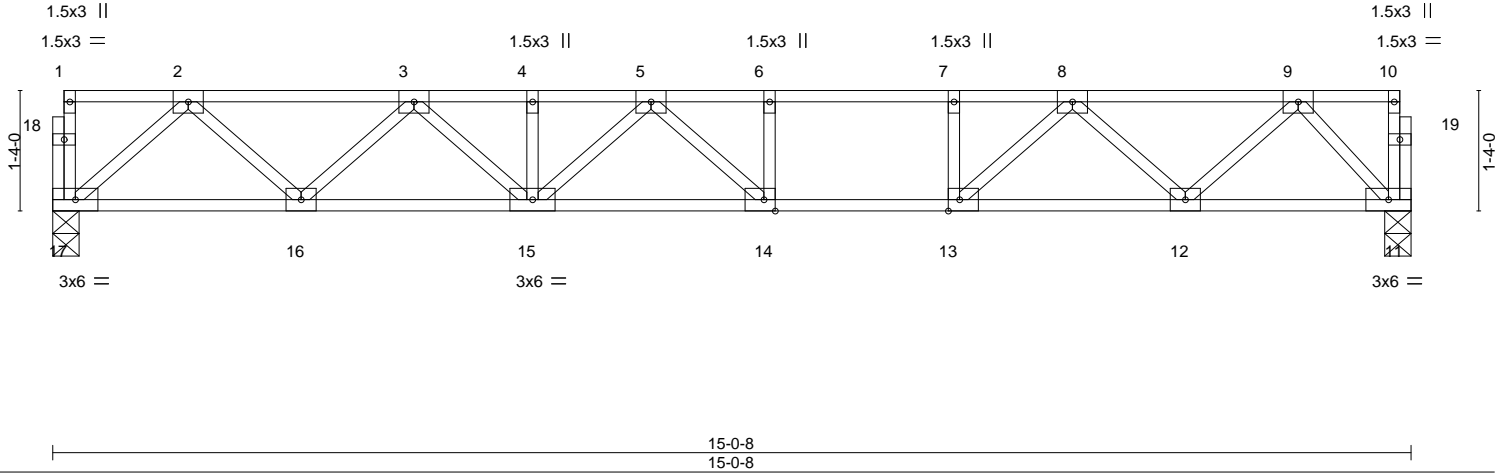
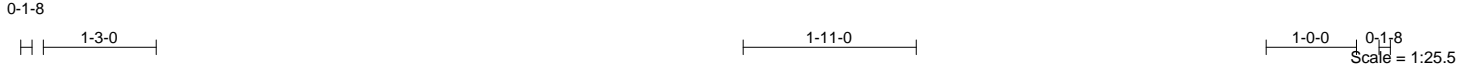

Plate Offsets (X,Y)-- [13:0-1-8,Edge], [14:0-1-8,Edge]

LOADING (psf)	SPACING-	CSI.	DEFL.	in (loc)	l/defl	L/d	PLATES	GRIP
TCLL 40.0	Plate Grip DOL 1.00	TC 0.76	Vert(LL) -0.20	14-15	>896	480	MT20	244/190
TCDL 10.0	Lumber DOL 1.00	BC 0.83	Vert(CT) -0.27	14-15	>661	360		
BCLL 0.0	Rep Stress Incr YES	WB 0.38	Horz(CT) 0.04	11	n/a	n/a		
BCDL 5.0	Code IRC2015/TPI2014	Matrix-S					Weight: 79 lb	FT = 20%F, 11%E

**LUMBER-**  
TOP CHORD 2x4 SP No.1 (flat)  
BOT CHORD 2x4 SP No.1 (flat)  
WEBS 2x4 SP No.3 (flat)

**BRACING-**  
TOP CHORD Structural wood sheathing directly applied or 6-0-0 oc purlins, except end verticals.  
BOT CHORD Rigid ceiling directly applied or 10-0-0 oc bracing.

**REACTIONS.** (size) 17=0-3-8, 11=0-3-8  
Max Grav 17=807(LC 1), 11=807(LC 1)

**FORCES.** (lb) - Max. Comp./Max. Ten. - All forces 250 (lb) or less except when shown.  
TOP CHORD 2-3=-1421/0, 3-4=-2278/0, 4-5=-2278/0, 5-6=-2364/0, 6-7=-2364/0, 7-8=-2364/0, 8-9=-1293/0  
BOT CHORD 16-17=0/866, 15-16=0/1958, 14-15=0/2452, 13-14=0/2364, 12-13=0/1870, 11-12=0/729  
WEBS 2-17=-1150/0, 2-16=0/772, 3-16=-746/0, 3-15=0/436, 5-14=-292/251, 9-11=-1069/0, 9-12=0/785, 8-12=-802/0, 8-13=0/803, 7-13=-385/0

- NOTES-**
- Unbalanced floor live loads have been considered for this design.
  - All plates are 3x4 MT20 unless otherwise indicated.
  - Plates checked for a plus or minus 1 degree rotation about its center.
  - Recommend 2x6 strongbacks, on edge, spaced at 10-0-0 oc and fastened to each truss with 3-10d (0.131" X 3") nails. Strongbacks to be attached to walls at their outer ends or restrained by other means.

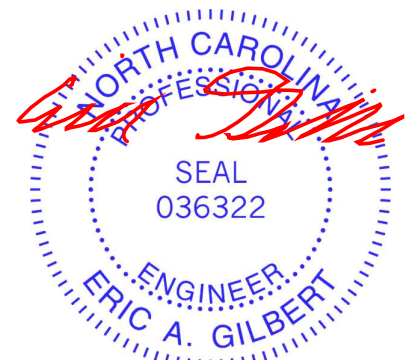

April 29, 2022

Job	Truss	Truss Type	Qty	Ply	Lot 52 Williams Farms	151635715
J0423-1985	F04	FLOOR	5	1	Job Reference (optional)	

Comtech, Inc., Fayetteville, NC - 28314,

8.430 s Aug 16 2021 MiTek Industries, Inc. Thu Apr 28 09:01:49 2022 Page 1  
ID:QdRWmBS7m75moFzg6tYesyW6Ye-1zqB3XTB4wLmgAvKpQYnLHwHvzp4aTQzA1jr0MzMEOm

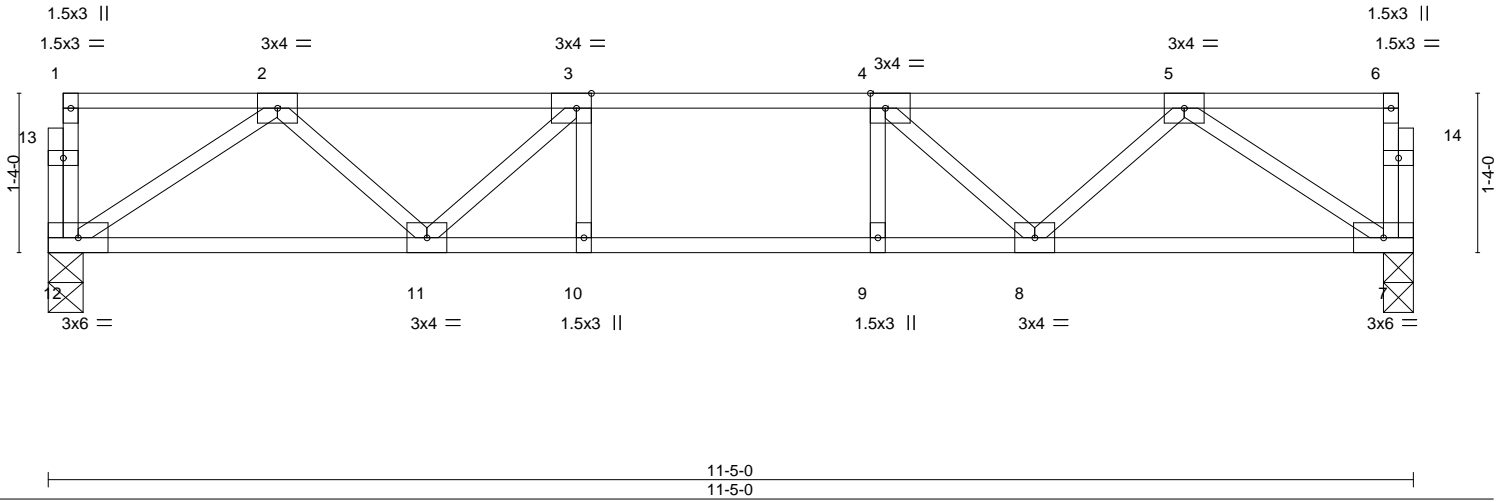
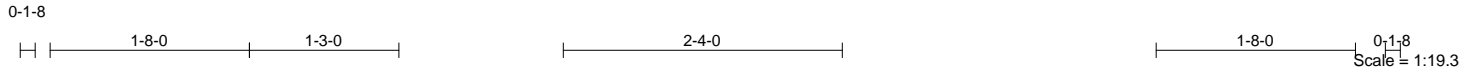

Plate Offsets (X,Y)-- [3:0-1-8,Edge], [4:0-1-8,Edge]

LOADING (psf)	SPACING-	2-0-0	CSI.	DEFL.	in (loc)	l/defl	L/d	PLATES	GRIP
TCLL 40.0	Plate Grip DOL	1.00	TC 0.33	Vert(LL)	-0.08 10-11	>999	480	MT20	244/190
TCDL 10.0	Lumber DOL	1.00	BC 0.47	Vert(CT)	-0.09 10	>999	360		
BCLL 0.0	Rep Stress Incr	YES	WB 0.23	Horz(CT)	0.02 7	n/a	n/a		
BCDL 5.0	Code	IRC2015/TPI2014	Matrix-S						
								Weight: 58 lb	FT = 20%F, 11%E

**LUMBER-**  
TOP CHORD 2x4 SP No.1 (flat)  
BOT CHORD 2x4 SP No.1 (flat)  
WEBS 2x4 SP No.3 (flat)

**BRACING-**  
TOP CHORD Structural wood sheathing directly applied or 6-0-0 oc purlins, except end verticals.  
BOT CHORD Rigid ceiling directly applied or 10-0-0 oc bracing.

**REACTIONS.** (size) 12=0-3-8, 7=0-3-0  
Max Grav 12=608(LC 1), 7=608(LC 1)

**FORCES.** (lb) - Max. Comp./Max. Ten. - All forces 250 (lb) or less except when shown.  
TOP CHORD 2-3=-1100/0, 3-4=-1391/0, 4-5=-1100/0  
BOT CHORD 11-12=0/795, 10-11=0/1391, 9-10=0/1391, 8-9=0/1391, 7-8=0/795  
WEBS 2-12=-955/0, 2-11=0/425, 3-11=-459/0, 5-7=-955/0, 5-8=0/425, 4-8=-459/0

- NOTES-**
- Unbalanced floor live loads have been considered for this design.
  - Plates checked for a plus or minus 1 degree rotation about its center.
  - Recommend 2x6 strongbacks, on edge, spaced at 10-0-0 oc and fastened to each truss with 3-10d (0.131" X 3") nails. Strongbacks to be attached to walls at their outer ends or restrained by other means.



April 29, 2022

**WARNING - Verify design parameters and READ NOTES ON THIS AND INCLUDED MITEK REFERENCE PAGE MII-7473 rev. 5/19/2020 BEFORE USE.**  
Design valid for use only with MiTek® connectors. This design is based only upon parameters shown, and is for an individual building component, not a truss system. Before use, the building designer must verify the applicability of design parameters and properly incorporate this design into the overall building design. Bracing indicated is to prevent buckling of individual truss web and/or chord members only. Additional temporary and permanent bracing is always required for stability and to prevent collapse with possible personal injury and property damage. For general guidance regarding the fabrication, storage, delivery, erection and bracing of trusses and truss systems, see **ANSI/TPI1 Quality Criteria, DSB-89 and BCSI Building Component Safety Information** available from Truss Plate Institute, 2670 Crain Highway, Suite 203 Waldorf, MD 20601



818 Soundside Road  
Edenton, NC 27932

Job	Truss	Truss Type	Qty	Ply	Lot 52 Williams Farms	151635716
J0423-1985	FKW1	GABLE	1	1	Job Reference (optional)	

Comtech, Inc., Fayetteville, NC - 28314,

8.430 s Aug 16 2021 MiTek Industries, Inc. Thu Apr 28 09:01:50 2022 Page 1  
ID:QdRWmBS7rn75moFzg6tYesyW6Ye-V9OZGtPrETdIKUXNX30tVSWmNGVJzr7OhTOYozMEOI

0 1/8

0 1/8

Scale = 1:19.0

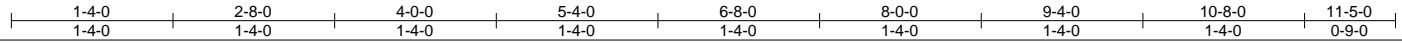
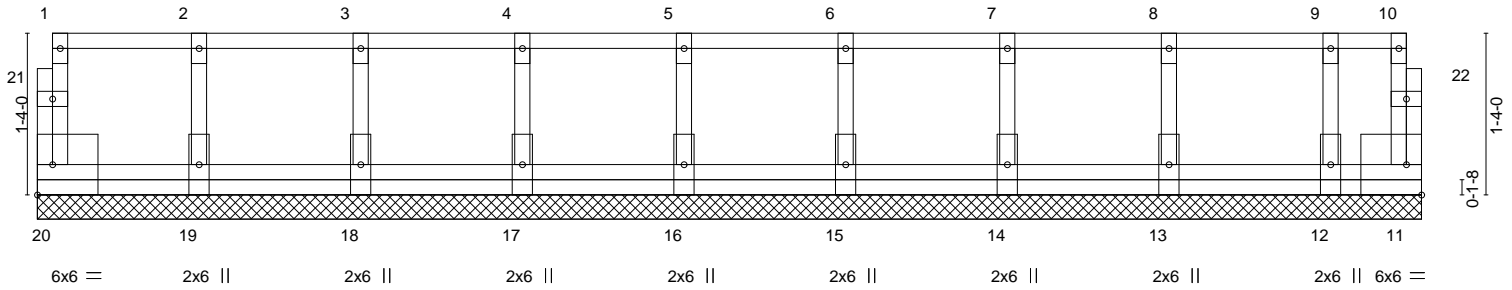

<b>LOADING</b> (psf)	<b>SPACING-</b>	2-0-0	<b>CSI.</b>	<b>DEFL.</b>	in	(loc)	l/defl	L/d	<b>PLATES</b>	<b>GRIP</b>
TCLL 40.0	Plate Grip DOL	1.00	TC 0.07	Vert(LL)	n/a	-	n/a	999	MT20	244/190
TCDL 10.0	Lumber DOL	1.00	BC 0.01	Vert(CT)	n/a	-	n/a	999		
BCLL 0.0	Rep Stress Incr	NO	WB 0.03	Horz(CT)	0.00	11	n/a	n/a		
BCDL 5.0	Code IRC2015/TPI2014		Matrix-R						Weight: 67 lb	FT = 20%F, 11%E

**LUMBER-**

TOP CHORD 2x4 SP No.1(flat)  
BOT CHORD 2x4 SP No.1(flat)  
WEBS 2x4 SP No.3(flat)  
OTHERS 2x4 SP No.3(flat)

**BRACING-**

TOP CHORD Structural wood sheathing directly applied or 6-0-0 oc purlins, except end verticals.  
BOT CHORD Rigid ceiling directly applied or 10-0-0 oc bracing.

**REACTIONS.**

All bearings 11-5-0.  
(lb) - Max Grav All reactions 250 lb or less at joint(s) 20, 11, 19, 18, 17, 16, 15, 14, 13, 12

**FORCES.**

(lb) - Max. Comp./Max. Ten. - All forces 250 (lb) or less except when shown.

**NOTES-**

- All plates are 1.5x3 MT20 unless otherwise indicated.
- Plates checked for a plus or minus 1 degree rotation about its center.
- Gable requires continuous bottom chord bearing.
- Truss to be fully sheathed from one face or securely braced against lateral movement (i.e. diagonal web).
- Gable studs spaced at 1-4-0 oc.
- Recommend 2x6 strongbacks, on edge, spaced at 10-0-0 oc and fastened to each truss with 3-10d (0.131" X 3") nails. Strongbacks to be attached to walls at their outer ends or restrained by other means.

**LOAD CASE(S)** Standard

- Dead + Floor Live (balanced): Lumber Increase=1.00, Plate Increase=1.00  
Uniform Loads (plf)  
Vert: 11-20=-10, 1-10=-100  
Concentrated Loads (lb)  
Vert: 1=-104



April 29, 2022

**WARNING - Verify design parameters and READ NOTES ON THIS AND INCLUDED MITEK REFERENCE PAGE MII-7473 rev. 5/19/2020 BEFORE USE.**

Design valid for use only with MiTek® connectors. This design is based only upon parameters shown, and is for an individual building component, not a truss system. Before use, the building designer must verify the applicability of design parameters and properly incorporate this design into the overall building design. Bracing indicated is to prevent buckling of individual truss web and/or chord members only. Additional temporary and permanent bracing is always required for stability and to prevent collapse with possible personal injury and property damage. For general guidance regarding the fabrication, storage, delivery, erection and bracing of trusses and truss systems, see

**ANSI/TPI1 Quality Criteria, DSB-89 and BCSI Building Component**

**Safety Information** available from Truss Plate Institute, 2670 Crain Highway, Suite 203 Waldorf, MD 20601



818 Soundside Road  
Edenton, NC 27932

Job J0423-1985	Truss FKW2	Truss Type FLOOR SUPPORTED GABL	Qty 1	Ply 1	Lot 52 Williams Farms Job Reference (optional)	I51635717
-------------------	---------------	------------------------------------	----------	----------	---	-----------

Comtech, Inc, Fayetteville, NC - 28314,

8.430 s Aug 16 2021 MiTek Industries, Inc. Thu Apr 28 09:01:51 2022 Page 1  
ID:QdRWmBS7rn75moFzg6tYesyW6Ye-zLyyUDURcYbUwU3jxFaqGQi?aqnXb2QMgDLcy4EzMEok

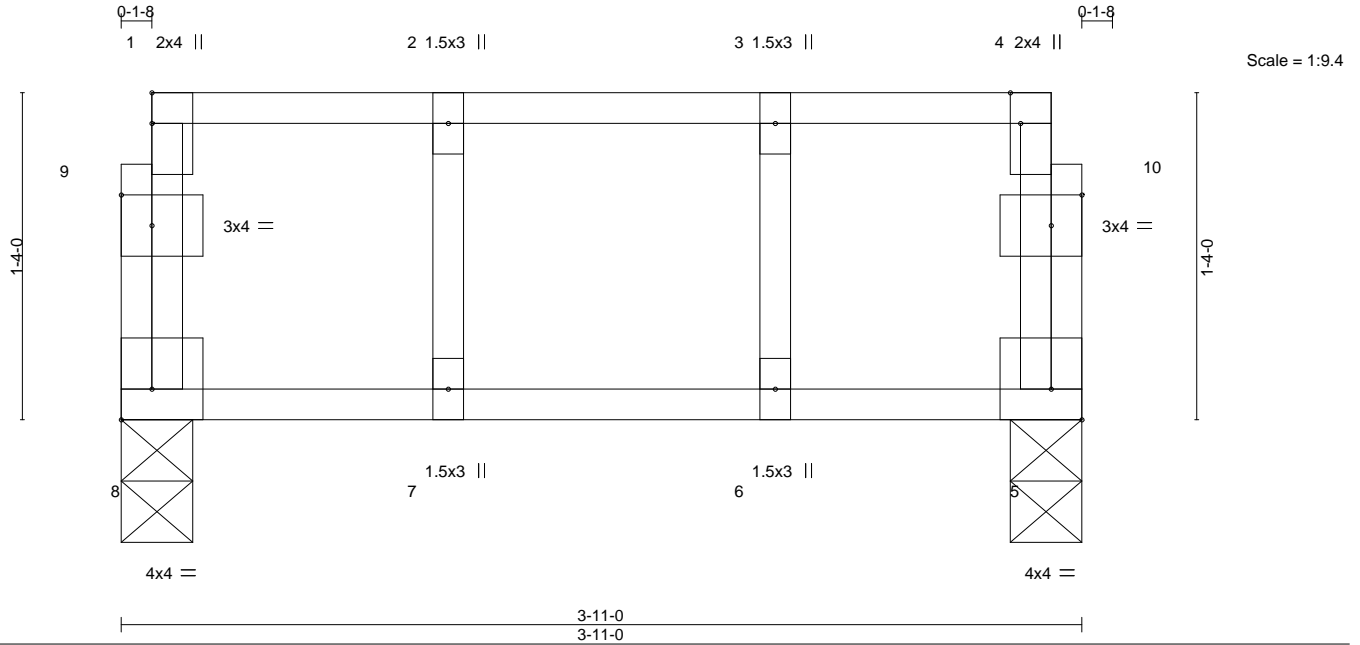

Plate Offsets (X,Y)-- [4:0-1-8,Edge], [5:Edge,0-1-8], [8:Edge,0-1-8], [9:0-1-8,0-1-8], [10:0-1-8,0-1-8]

LOADING (psf)	SPACING-	CSI.	DEFL.	in (loc)	l/defl	L/d	PLATES	GRIP
TCLL 40.0	Plate Grip DOL 1.00	TC 0.52	Vert(LL) -0.02	6-7	>999	480	MT20	244/190
TCDL 10.0	Lumber DOL 1.00	BC 0.28	Vert(CT) -0.03	6-7	>999	360		
BCLL 0.0	Rep Stress Incr YES	WB 0.01	Horz(CT) 0.00	5	n/a	n/a		
BCDL 5.0	Code IRC2015/TPI2014	Matrix-R					Weight: 20 lb	FT = 20%F, 11%E

**LUMBER-**  
TOP CHORD 2x4 SP No.1(flat)  
BOT CHORD 2x4 SP No.1(flat)  
WEBS 2x4 SP No.3(flat)  
OTHERS 2x4 SP No.3(flat)

**BRACING-**  
TOP CHORD Structural wood sheathing directly applied or 3-11-0 oc purlins, except end verticals.  
BOT CHORD Rigid ceiling directly applied or 10-0-0 oc bracing.

**REACTIONS.** (size) 8=0-3-8, 5=0-3-8  
Max Grav 8=195(LC 1), 5=195(LC 1)

**FORCES.** (lb) - Max. Comp./Max. Ten. - All forces 250 (lb) or less except when shown.

- NOTES-**
- Plates checked for a plus or minus 1 degree rotation about its center.
  - Truss to be fully sheathed from one face or securely braced against lateral movement (i.e. diagonal web).
  - Gable studs spaced at 1-4-0 oc.
  - Recommend 2x6 strongbacks, on edge, spaced at 10-0-0 oc and fastened to each truss with 3-10d (0.131" X 3") nails. Strongbacks to be attached to walls at their outer ends or restrained by other means.



April 29, 2022

**WARNING - Verify design parameters and READ NOTES ON THIS AND INCLUDED MITEK REFERENCE PAGE MII-7473 rev. 5/19/2020 BEFORE USE.**  
Design valid for use only with MiTek® connectors. This design is based only upon parameters shown, and is for an individual building component, not a truss system. Before use, the building designer must verify the applicability of design parameters and properly incorporate this design into the overall building design. Bracing indicated is to prevent buckling of individual truss web and/or chord members only. Additional temporary and permanent bracing is always required for stability and to prevent collapse with possible personal injury and property damage. For general guidance regarding the fabrication, storage, delivery, erection and bracing of trusses and truss systems, see **ANSI/TPI1 Quality Criteria, DSB-89 and BCSI Building Component Safety Information** available from Truss Plate Institute, 2670 Crain Highway, Suite 203 Waldorf, MD 20601



818 Soundside Road  
Edenton, NC 27932

# Symbols

## PLATE LOCATION AND ORIENTATION

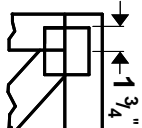

Center plate on joint unless x, y offsets are indicated. Dimensions are in ft-in-sixteenths. Apply plates to both sides of truss and fully embed teeth.

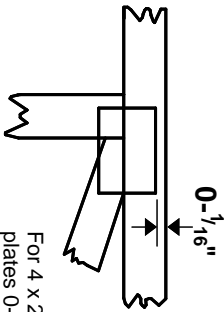

For 4 x 2 orientation, locate plates 0- 1/16" from outside edge of truss.



This symbol indicates the required direction of slots in connector plates.

\* Plate location details available in **MITek 20/20 software** or upon request.

## PLATE SIZE

**4 X 4**

The first dimension is the plate width measured perpendicular to slots. Second dimension is the length parallel to slots.

## LATERAL BRACING LOCATION



Indicated by symbol shown and/or by text in the bracing section of the output. Use T or I bracing if indicated.

## BEARING

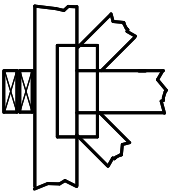

Indicates location where bearings (supports) occur. Icons vary but reaction section indicates joint number where bearings occur. Min size shown is for crushing only.

### Industry Standards:

ANSI/TPI 1: National Design Specification for Metal Plate Connected Wood Truss Construction.  
DSB-89: Design Standard for Bracing, Building Component Safety Information, Guide to Good Practice for Handling, Installing & Bracing of Metal Plate Connected Wood Trusses.

# Numbering System

6-4-8  
dimensions shown in ft-in-sixteenths  
(Drawings not to scale)

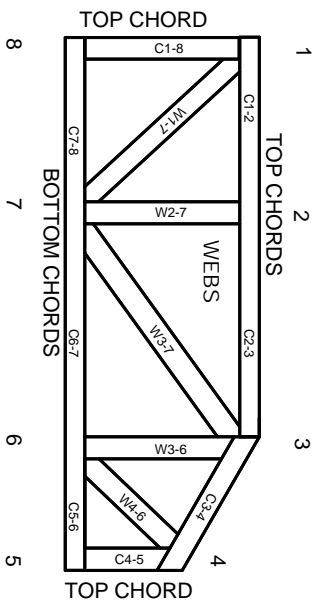

**JOINTS ARE GENERALLY NUMBERED/LETTERED CLOCKWISE AROUND THE TRUSS STARTING AT THE JOINT FARTHEST TO THE LEFT.**

**CHORDS AND WEBS ARE IDENTIFIED BY END JOINT NUMBERS/LETTERS.**

## PRODUCT CODE APPROVALS

ICC-ES Reports:

ESR-1311, ESR-1352, ESR1988  
ER-3907, ESR-2362, ESR-1397, ESR-3282

Trusses are designed for wind loads in the plane of the truss unless otherwise shown.

Lumber design values are in accordance with ANSI/TPI 1 section 6.3 These truss designs rely on lumber values established by others.

© 2012 MITteK® All Rights Reserved



MITek Engineering Reference Sheet: Mill-7473 rev. 5/19/2020



# General Safety Notes

## Failure to Follow Could Cause Property Damage or Personal Injury

1. Additional stability bracing for truss system, e.g. diagonal or X-bracing, is always required. See BCSI.
2. Truss bracing must be designed by an engineer. For wide truss spacing, individual lateral braces themselves may require bracing, or alternative Tor I bracing should be considered.
3. Never exceed the design loading shown and never stack materials on inadequately braced trusses.
4. Provide copies of this truss design to the building designer, erection supervisor, property owner and all other interested parties.
5. Cut members to bear tightly against each other.
6. Place plates on each face of truss at each joint and embed fully. Knots and wane at joint locations are regulated by ANSI/TPI 1.
7. Design assumes trusses will be suitably protected from the environment in accord with ANSI/TPI 1.
8. Unless otherwise noted, moisture content of lumber shall not exceed 19% at time of fabrication.
9. Unless expressly noted, this design is not applicable for use with fire retardant, preservative treated, or green lumber.
10. Camber is a non-structural consideration and is the responsibility of truss fabricator. General practice is to camber for dead load deflection.
11. Plate type, size, orientation and location dimensions indicated are minimum plating requirements.
12. Lumber used shall be of the species and size, and in all respects, equal to or better than that specified.
13. Top chords must be sheathed or purlins provided at spacing indicated on design.
14. Bottom chords require lateral bracing at 10 ft. spacing, or less, if no ceiling is installed, unless otherwise noted.
15. Connections not shown are the responsibility of others.
16. Do not cut or alter truss member or plate without prior approval of an engineer.
17. Install and load vertically unless indicated otherwise.
18. Use of green or treated lumber may pose unacceptable environmental, health or performance risks. Consult with project engineer before use.
19. Review all portions of this design (front, back, words and pictures) before use. Reviewing pictures alone is not sufficient.
20. Design assumes manufacture in accordance with ANSI/TPI 1 Quality Criteria.
21. The design does not take into account any dynamic or other loads other than those expressly stated.