

Trenco
818 Soundside Rd
Edenton, NC 27932

Re: J0523-2758
Lot 9 Williams Farms

The truss drawing(s) referenced below have been prepared by Truss Engineering Co. under my direct supervision based on the parameters provided by Comtech, Inc - Fayetteville.

Pages or sheets covered by this seal: I59958060 thru I59958060

My license renewal date for the state of North Carolina is December 31, 2023.

North Carolina COA: C-0844



August 4, 2023

Gilbert, Eric

IMPORTANT NOTE: The seal on these truss component designs is a certification that the engineer named is licensed in the jurisdiction(s) identified and that the designs comply with ANSI/TPI 1. These designs are based upon parameters shown (e.g., loads, supports, dimensions, shapes and design codes), which were given to MiTek or TRENCO. Any project specific information included is for MiTek's or TRENCO's customers file reference purpose only, and was not taken into account in the preparation of these designs. MiTek or TRENCO has not independently verified the applicability of the design parameters or the designs for any particular building. Before use, the building designer should verify applicability of design parameters and properly incorporate these designs into the overall building design per ANSI/TPI 1, Chapter 2.

Job J0523-2758	Truss B2	Truss Type Piggyback Base	Qty 6	Ply 1	Lot 9 Williams Farms	159958060
-------------------	-------------	------------------------------	----------	----------	----------------------	-----------

Comtech, Inc. Fayetteville, NC - 28314,

8.430 s Jan 6 2022 MiTek Industries, Inc. Fri Aug 4 09:05:41 2023 Page 1

ID:2GNsYO62BI49KgBFP3SlmayOXVO-RfC?PsB70Hq3NSgPqnL8w3uITXbGKWrCDoi7J4zJC?f

0-11-0	4-3-8	11-1-10	17-11-13	22-11-8	27-11-4	35-9-2	43-11-0	44-10-0
0-11-0	4-3-8	6-10-2	6-10-2	4-11-11	4-11-11	7-9-14	8-1-14	0-11-0

REPAIR: REPLACE BOTTOM CHORD FROM JUST LEFT OF PLATE AT 18 TO JOINT 2.
REPLACE TOP CHORD 1-3 FROM JOINT 1 TO MID POINT.

Scale = 1:84.7

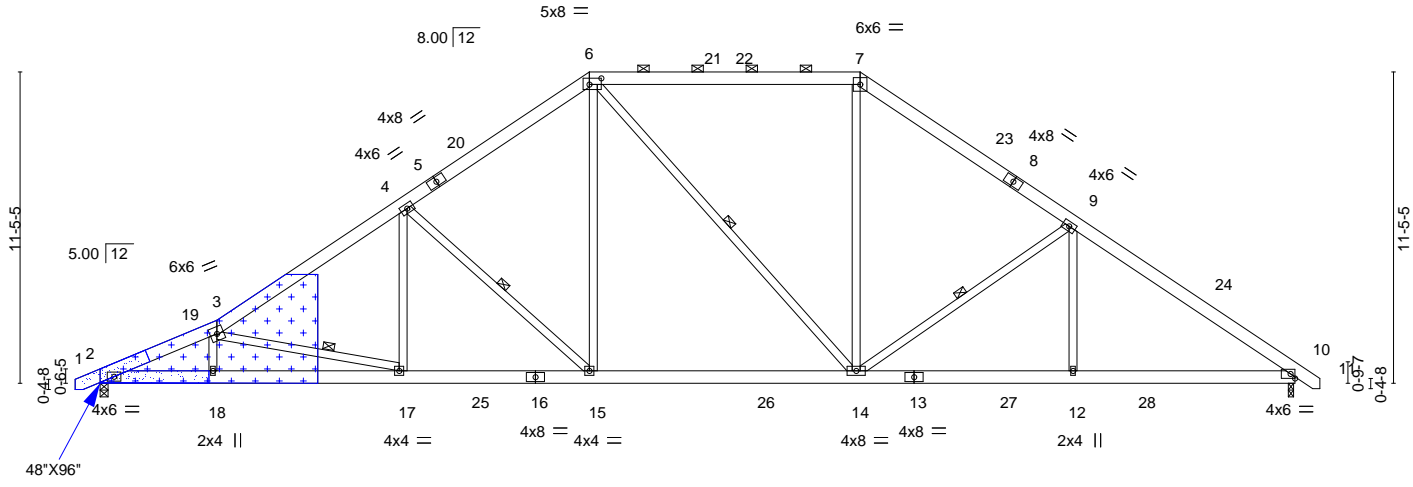

Plate Offsets (X,Y)--	[6:0-5-4,0-2-12]
-----------------------	------------------

LOADING (psf)	SPACING-	2-0-0	CSI.	DEFL.	in (loc)	l/defl	L/d	PLATES	GRIP
TCLL 20.0	Plate Grip DOL	1.15	TC 0.59	Vert(LL)	-0.20	14-15	>999	MT20	244/190
TCDL 10.0	Lumber DOL	1.15	BC 0.55	Vert(CT)	-0.34	14-15	>999		
BCLL 0.0 *	Rep Stress Incr	YES	WB 0.37	Horz(CT)	0.10	10	n/a		
BCDL 10.0	Code IRC2015/TP12014		Matrix-S	Wind(LL)	0.08	17-18	>999		
								Weight: 335 lb	FT = 20%

LUMBER-	BRACING-
TOP CHORD 2x6 SP No.1	TOP CHORD Structural wood sheathing directly applied or 3-9-12 oc purlins, except
BOT CHORD 2x6 SP No.1	2-0-0 oc purlins (4-10-3 max.): 6-7.
WEBS 2x4 SP No.2	BOT CHORD Rigid ceiling directly applied or 9-9-2 oc bracing.
	WEBS 1 Row at midpt 3-17, 4-15, 6-14, 9-14

REACTIONS.	(size)	2=0-3-8, 10=0-2-5
Max Horz	2=272(LC 11)	
Max Uplift	2=92(LC 12), 10=-77(LC 13)	
Max Grav	2=1848(LC 2), 10=1951(LC 20)	

FORCES.	(lb) - Max. Comp./Max. Ten. - All forces 250 (lb) or less except when shown.
TOP CHORD	2-3=-4045/768, 3-4=-3046/625, 4-6=-2376/598, 6-7=-1810/553, 7-9=-2279/574, 9-10=-2903/555
BOT CHORD	2-18=-641/3816, 17-18=-648/3813, 15-17=-338/2617, 14-15=-128/1944, 12-14=-321/2304, 10-12=-321/2304
WEBS	3-17=-1242/328, 4-17=-12/557, 4-15=-930/286, 6-15=-88/1044, 6-14=-266/145, 7-14=-52/804, 9-14=-766/246, 9-12=0/414

- NOTES-**
- 1) Unbalanced roof live loads have been considered for this design.
 - 2) Wind: ASCE 7-10; Vult=130mph Vasd=103mph; TCCL=6.0psf; BCDL=6.0psf; h=15ft; Cat. II; Exp C; Enclosed; MWFRS (envelope) and C-C Exterior(2) -0-9-4 to 3-7-9, Interior(1) 3-7-9 to 17-11-13, Exterior(2) 17-11-13 to 22-4-9, Interior(1) 22-4-9 to 27-11-4, Exterior(2) 27-11-4 to 32-4-0, Interior(1) 32-4-0 to 44-8-7 zone; C-C for members and forces & MWFRS for reactions shown; Lumber DOL=1.60 plate grip DOL=1.60
 - 3) Provide adequate drainage to prevent water ponding.
 - 4) This truss has been designed for a 10.0 psf bottom chord live load nonconcurrent with any other live loads.
 - 5) * This truss has been designed for a live load of 30.0psf on the bottom chord in all areas where a rectangle 3-6-0 tall by 2-0-0 wide will fit between the bottom chord and any other members, with BCDL = 10.0psf.
 - 6) Provide mechanical connection (by others) of truss to bearing plate at joint(s) 10.
 - 7) Provide mechanical connection (by others) of truss to bearing plate capable of withstanding 100 lb uplift at joint(s) 2, 10.
 - 8) Graphical purlin representation does not depict the size or the orientation of the purlin along the top and/or bottom chord.

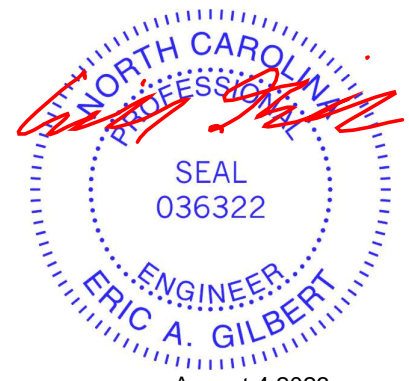

WARNING - Verify design parameters and READ NOTES ON THIS AND INCLUDED MITEK REFERENCE PAGE MII-7473 rev. 1/2/2023 BEFORE USE.

Design valid for use only with MiTek® connectors. This design is based only upon parameters shown, and is for an individual building component, not a truss system. Before use, the building designer must verify the applicability of design parameters and properly incorporate this design into the overall building design. Bracing indicated is to prevent buckling of individual truss web and/or chord members only. Additional temporary and permanent bracing is always required for stability and to prevent collapse with possible personal injury and property damage. For general guidance regarding the fabrication, storage, delivery, erection and bracing of trusses and truss systems, see **ANSI/TP1 Quality Criteria and DSB-22** available from Truss Plate Institute (www.tpinst.org) and **BCSI Building Component Safety Information** available from the Structural Building Component Association (www.sbccomponents.com)

ENGINEERING BY
TRENCO
A MiTek Affiliate

818 Soundside Road
Edenton, NC 27932

Symbols

PLATE LOCATION AND ORIENTATION

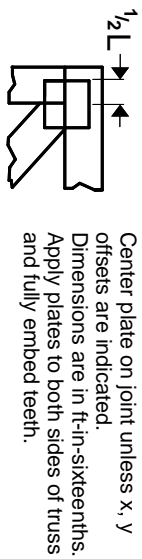

Center plate on joint unless x, y offsets are indicated. Dimensions are in ft-in-sixteenths. Apply plates to both sides of truss and fully embed teeth.

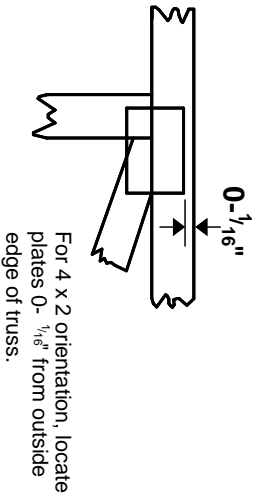

For 4 x 2 orientation, locate plates 0- 1/16\" from outside edge of truss.

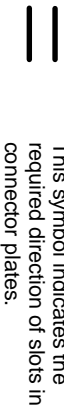

This symbol indicates the required direction of slots in connector plates.

* Plate location details available in MITek software or upon request.

PLATE SIZE

4 X 4

The first dimension is the plate width measured perpendicular to slots. Second dimension is the length parallel to slots.

LATERAL BRACING LOCATION

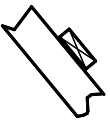

Indicated by symbol shown and/or by text in the bracing section of the output. Use T or I bracing if indicated.

BEARING

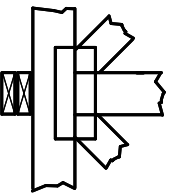

Indicates location where bearings (supports) occur. Icons vary but reaction section indicates joint number/letter where bearings occur. Min size shown is for crushing only.

Industry Standards:

ANSI/TP1: National Design Specification for Metal Plate Connected Wood Truss Construction.
DSB-22: Design Standard for Bracing.
BCSI: Building Component Safety Information, Guide to Good Practice for Handling, Installing, Restraining & Bracing of Metal Plate Connected Wood Trusses.

Numbering System

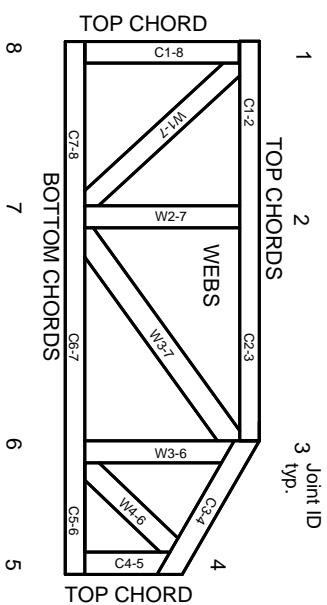

JOINTS ARE GENERALLY NUMBERED/LETTERED CLOCKWISE AROUND THE TRUSS STARTING AT THE JOINT FARTHEST TO THE LEFT.

CHORDS AND WEBS ARE IDENTIFIED BY END JOINT NUMBERS/LETTERS.

Product Code Approvals

ICC-ES Reports:

ESR-1988, ESR-2362, ESR-2685, ESR-3282
ESR-4722, ESL-1388

Design General Notes

Trusses are designed for wind loads in the plane of the truss unless otherwise shown.

Lumber design values are in accordance with ANSI/TP1 section 6.3. These truss designs rely on Lumber values established by others.

© 2023 MITek® All Rights Reserved

MITek

ENGINEERING BY
TRENGO
A MITek Affiliate

MITek Engineering Reference Sheet: MIL-7473 rev. 1/2/2023

General Safety Notes

Failure to Follow Could Cause Property Damage or Personal Injury

1. Additional stability/bracing for truss system, e.g. diagonal or X-bracing, is always required. See BCSI.
2. Truss bracing must be designed by an engineer. For wide truss spacing, individual lateral braces themselves may require bracing, or alternative Tor I bracing should be considered.
3. Never exceed the design loading shown and never stack materials on inadequately braced trusses.
4. Provide copies of this truss design to the building designer, erection supervisor, property owner and all other interested parties.
5. Cut members to bear tightly against each other.
6. Place plates on each face of truss at each joint and embed fully. Knots and wane at joint locations are regulated by ANSI/TP1 1.
7. Design assumes trusses will be suitably protected from the environment in accord with ANSI/TP1 1.
8. Unless otherwise noted, moisture content of lumber shall not exceed 19% at time of fabrication.
9. Unless expressly noted, this design is not applicable for use with fire retardant, preservative treated, or green lumber.
10. Camber is a non-structural consideration and is the responsibility of truss fabricator. General practice is to camber for dead load deflection.
11. Plate type, size, orientation and location dimensions indicated are minimum plating requirements.
12. Lumber used shall be of the species and size, and in all respects, equal to or better than that specified.
13. Top chords must be sheathed or purlins provided at spacing indicated on design.
14. Bottom chords require lateral bracing at 10 ft. spacing, or less, if no ceiling is installed, unless otherwise noted.
15. Connections not shown are the responsibility of others.
16. Do not cut or alter truss member or plate without prior approval of an engineer.
17. Install and load vertically unless indicated otherwise.
18. Use of green or treated lumber may pose unacceptable environmental, health or performance risks. Consult with project engineer before use.
19. Review all portions of this design (front, back, words and pictures) before use. Reviewing pictures alone is not sufficient.
20. Design assumes manufacture in accordance with ANSI/TP1 1 Quality Criteria.
21. The design does not take into account any dynamic or other loads other than those expressly stated.