

RE: J0724-4211
Lot 15 Williams Farm

Trenco
818 Soundside Rd
Edenton, NC 27932

Site Information:

Customer: Project Name: J0724-4211
Lot/Block: Model:
Address: Subdivision:
City: State:

General Truss Engineering Criteria & Design Loads (Individual Truss Design Drawings Show Special Loading Conditions):

Design Code: IRC2015/TPI2014 Design Program: MiTek 20/20 8.4
Wind Code: N/A Wind Speed: N/A mph
Roof Load: N/A psf Floor Load: 55.0 psf

This package includes 6 individual, dated Truss Design Drawings and 0 Additional Drawings.

No.	Seal#	Truss Name	Date
1	I63950703	F01	3/4/2024
2	I63950704	F02	3/4/2024
3	I63950705	F03	3/4/2024
4	I63950706	F04	3/4/2024
5	I63950707	FKW1	3/4/2024
6	I63950708	FKW2	3/4/2024

The truss drawing(s) referenced above have been prepared by Truss Engineering Co. under my direct supervision based on the parameters provided by Comtech, Inc - Fayetteville.

Truss Design Engineer's Name: Gilbert, Eric

My license renewal date for the state of North Carolina is December 31, 2024.

North Carolina COA: C-0844

IMPORTANT NOTE: The seal on these truss component designs is a certification that the engineer named is licensed in the jurisdiction(s) identified and that the designs comply with ANSI/TPI 1. These designs are based upon parameters shown (e.g., loads, supports, dimensions, shapes and design codes), which were given to TRENCO. Any project specific information included is for TRENCO customers file reference purpose only, and was not taken into account in the preparation of these designs. TRENCO has not independently verified the applicability of the design parameters or the designs for any particular building. Before use, the building designer should verify applicability of design parameters and properly incorporate these designs into the overall building design per ANSI/TPI 1, Chapter 2.

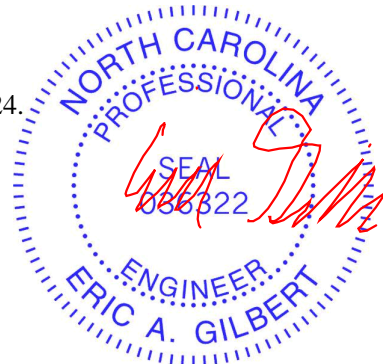

March 04, 2024

Job J0724-4211	Truss F01	Truss Type FLOOR	Qty 4	Ply 1	Lot 15 Williams Farm Job Reference (optional)	163950703
-------------------	--------------	---------------------	----------	----------	--	-----------

Comtech, Inc. Fayetteville, NC - 28314,

8.430 s Jan 6 2022 MiTek Industries, Inc. Thu Feb 29 11:47:51 2024 Page 1

ID:QdRWmBS7rn75moFzg6tYesyW6Ye-RfC?PsB70Hq3NSgPqnL8w3uITXbGKWrCDoi7J4zJC?f

0-1-8



Scale: 3/8"=1'

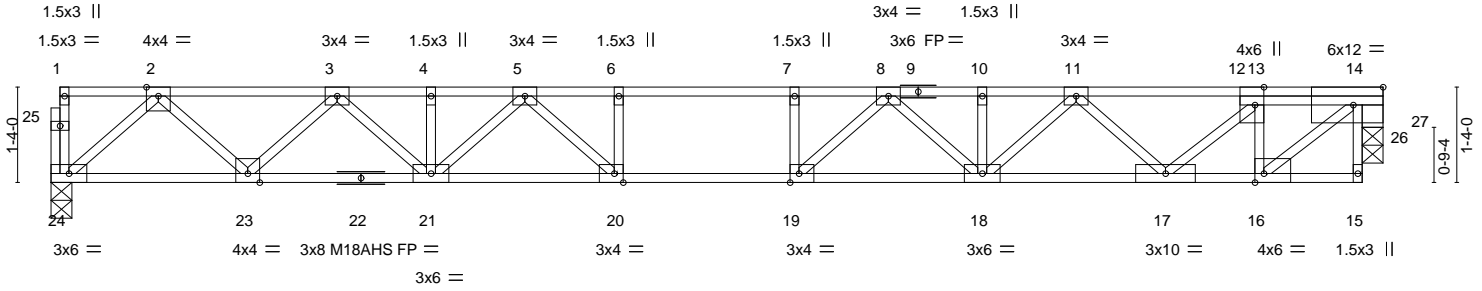

Plate Offsets (X,Y)--	[13:0-3-0,Edge], [14:0-5-0,Edge], [16:0-1-8,Edge], [19:0-1-8,Edge], [20:0-1-8,Edge]
-----------------------	---

LOADING (psf)	SPACING-	2-0-0	CSI.	DEFL.	in (loc)	l/defl	L/d	PLATES	GRIP
TCLL 40.0	Plate Grip DOL	1.00	TC 0.74	Vert(LL)	-0.26 18-19	>831	480	MT20	244/190
TCDL 10.0	Lumber DOL	1.00	BC 0.85	Vert(CT)	-0.36 18-19	>617	360	M18AHS	186/179
BCLL 0.0	Rep Stress Incr	YES	WB 0.69	Horz(CT)	0.03 27	n/a	n/a		
BCDL 5.0	Code IRC2015/TPI2014		Matrix-S						
								Weight: 100 lb	FT = 20%F, 11%E

LUMBER-	BRACING-
TOP CHORD 2x4 SP No.1(flat)	TOP CHORD Structural wood sheathing directly applied or 6-0-0 oc purlins, except end verticals.
BOT CHORD 2x4 SP No.1(flat)	BOT CHORD Rigid ceiling directly applied or 10-0-0 oc bracing.
WEBS 2x4 SP No.3(flat)	
OTHERS 4x4 SP No.2(flat)	

REACTIONS. (size) 24=0-3-8, 27=0-3-8
Max Grav 24=999(LC 1), 27=991(LC 1)

FORCES. (lb) - Max. Comp./Max. Ten. - All forces 250 (lb) or less except when shown.
 TOP CHORD 2-3=-1839/0, 3-4=-3087/0, 4-5=-3087/0, 5-6=-3753/0, 6-7=-3753/0, 7-8=-3753/0,
 8-10=-3158/0, 10-11=-3158/0, 11-13=-1955/0, 13-14=-1179/0
 BOT CHORD 23-24=0/1085, 21-23=0/2562, 20-21=0/3474, 19-20=0/3753, 18-19=0/3517, 17-18=0/2639,
 16-17=0/1179
 WEBS 13-16=-907/0, 14-16=0/1440, 2-24=-1442/0, 2-23=0/1048, 3-23=-1006/0, 3-21=0/714,
 5-21=-526/0, 5-20=-22/698, 6-20=-353/0, 13-17=0/1031, 11-17=-951/0, 11-18=0/705,
 8-18=-489/0, 8-19=-62/658, 7-19=-336/0, 14-27=-1021/0

- NOTES-**
- 1) Unbalanced floor live loads have been considered for this design.
 - 2) All plates are MT20 plates unless otherwise indicated.
 - 3) Plates checked for a plus or minus 1 degree rotation about its center.
 - 4) Bearing at joint(s) 27 considers parallel to grain value using ANSI/TPI 1 angle to grain formula. Building designer should verify capacity of bearing surface.
 - 5) Recommend 2x6 strongbacks, on edge, spaced at 10-0-0 oc and fastened to each truss with 3-10d (0.131" X 3") nails. Strongbacks to be attached to walls at their outer ends or restrained by other means.
 - 6) CAUTION, Do not erect truss backwards.

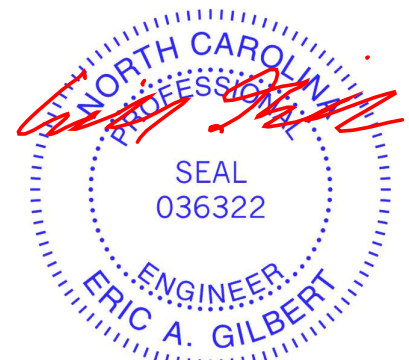

March 4, 2024

<p>WARNING - Verify design parameters and READ NOTES ON THIS AND INCLUDED MITEK REFERENCE PAGE MII-7473 rev. 1/2/2023 BEFORE USE.</p> <p>Design valid for use only with MiTek® connectors. This design is based only upon parameters shown, and is for an individual building component, not a truss system. Before use, the building designer must verify the applicability of design parameters and properly incorporate this design into the overall building design. Bracing indicated is to prevent buckling of individual truss web and/or chord members only. Additional temporary and permanent bracing is always required for stability and to prevent collapse with possible personal injury and property damage. For general guidance regarding the fabrication, storage, delivery, erection and bracing of trusses and truss systems, see ANSI/TPI Quality Criteria and DSB-22 available from Truss Plate Institute (www.tpinst.org) and BCSI Building Component Safety Information available from the Structural Building Component Association (www.sbcacomponents.com)</p>	<p>ENGINEERING BY</p> <p>TRENCO</p> <p>A MiTek Affiliate</p> <p>818 Soundside Road Edenton, NC 27932</p>
--	---

Job J0724-4211	Truss F02	Truss Type FLOOR	Qty 2	Ply 1	Lot 15 Williams Farm 63950704
-------------------	--------------	---------------------	----------	----------	----------------------------------

Comtech, Inc. Fayetteville, NC - 28314,

8.430 s Jan 6 2022 MiTek Industries, Inc. Thu Feb 29 11:47:52 2024 Page 1

ID:QdRWmBS7rn75moFzg6tYesyW6Ye-RfC?PsB70Hq3NSgPqnL8w3uITXbGKWrcDOI7J4zJC?f

0-1-8

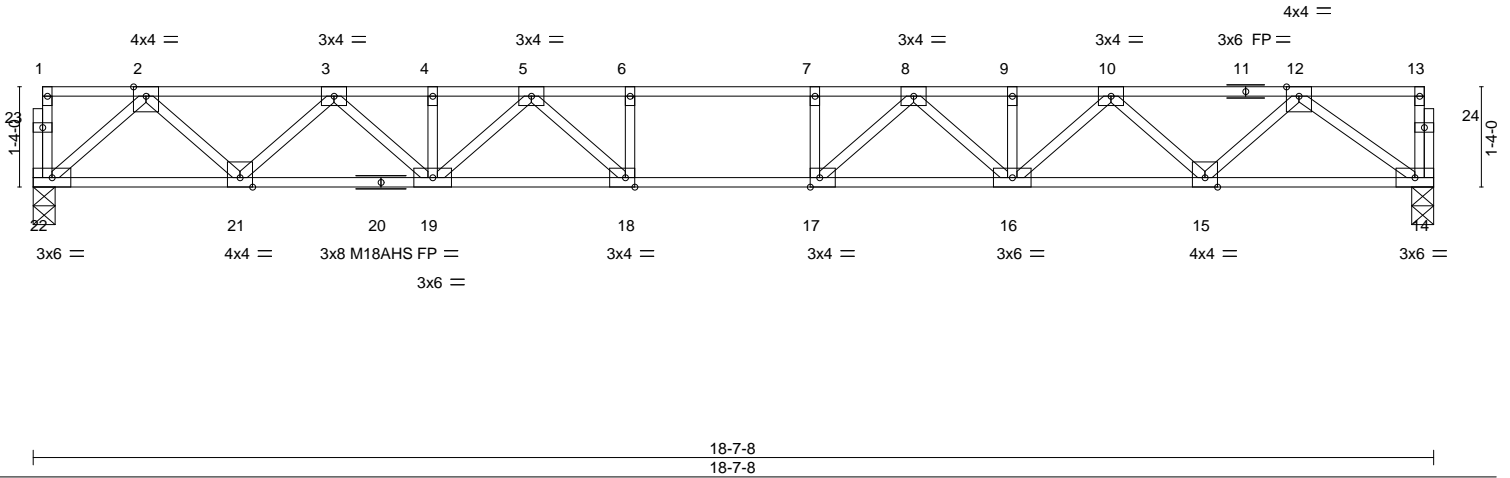

Plate Offsets (X,Y)--	[17:0-1-8,Edge], [18:0-1-8,Edge]				
LOADING (psf)	SPACING- 2-0-0	CSI.	DEFL. in (loc) l/defl L/d	PLATES	GRIP
TCLL 40.0	Plate Grip DOL 1.00	TC 0.77	Vert(LL) -0.27 16-17 >810 480	MT20	244/190
TCDL 10.0	Lumber DOL 1.00	BC 0.87	Vert(CT) -0.37 16-17 >600 360	M18AHS	186/179
BCLL 0.0	Rep Stress Incr YES	WB 0.50	Horz(CT) 0.07 14 n/a n/a		
BCDL 5.0	Code IRC2015/TPI2014	Matrix-S		Weight: 97 lb	FT = 20%F, 11%E

LUMBER-	BRACING-
TOP CHORD 2x4 SP No.1(flat)	TOP CHORD Structural wood sheathing directly applied or 6-0-0 oc purlins, except end verticals.
BOT CHORD 2x4 SP No.1(flat)	BOT CHORD Rigid ceiling directly applied or 10-0-0 oc bracing.
WEBS 2x4 SP No.3(flat)	

REACTIONS. (size) 22=0-3-8, 14=0-3-8
Max Grav 22=1004(LC 1), 14=1004(LC 1)

FORCES. (lb) - Max. Comp./Max. Ten. - All forces 250 (lb) or less except when shown.
 TOP CHORD 2-3=-1851/0, 3-4=-3112/0, 4-5=-3112/0, 5-6=-3796/0, 6-7=-3796/0, 7-8=-3796/0,
 8-9=-3216/0, 9-10=-3216/0, 10-12=-2022/0
 BOT CHORD 21-22=0/1092, 19-21=0/2580, 18-19=0/3505, 17-18=0/3796, 16-17=0/3573, 15-16=0/2718,
 14-15=0/1295
 WEBS 2-22=-1451/0, 2-21=0/1057, 3-21=-1014/0, 3-19=0/722, 5-19=-535/0, 5-18=-13/712,
 6-18=-360/0, 12-14=-1596/0, 12-15=0/1011, 10-15=-969/0, 10-16=0/676, 8-16=-485/0,
 8-17=-76/650, 7-17=-332/0

- NOTES-**
- 1) Unbalanced floor live loads have been considered for this design.
 - 2) All plates are MT20 plates unless otherwise indicated.
 - 3) All plates are 1.5x3 MT20 unless otherwise indicated.
 - 4) Plates checked for a plus or minus 1 degree rotation about its center.
 - 5) Recommend 2x6 strongbacks, on edge, spaced at 10-0-0 oc and fastened to each truss with 3-10d (0.131" X 3") nails. Strongbacks to be attached to walls at their outer ends or restrained by other means.

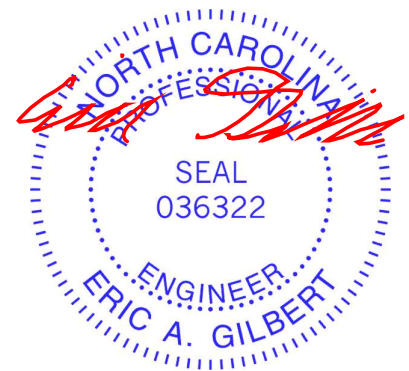

March 4, 2024

<p>WARNING - Verify design parameters and READ NOTES ON THIS AND INCLUDED MITEK REFERENCE PAGE MII-7473 rev. 1/2/2023 BEFORE USE.</p> <p>Design valid for use only with MiTek® connectors. This design is based only upon parameters shown, and is for an individual building component, not a truss system. Before use, the building designer must verify the applicability of design parameters and properly incorporate this design into the overall building design. Bracing indicated is to prevent buckling of individual truss web and/or chord members only. Additional temporary and permanent bracing is always required for stability and to prevent collapse with possible personal injury and property damage. For general guidance regarding the fabrication, storage, delivery, erection and bracing of trusses and truss systems, see ANSI/TPH Quality Criteria and DSB-22 available from Truss Plate Institute (www.tpinst.org) and BCSI Building Component Safety Information available from the Structural Building Component Association (www.sbcacomponents.com)</p>	<p>818 Soundside Road Edenton, NC 27932</p>
--	---

Job J0724-4211	Truss F03	Truss Type FLOOR	Qty 3	Ply 1	Lot 15 Williams Farm Job Reference (optional)	163950705
-------------------	--------------	---------------------	----------	----------	--	-----------

Comtech, Inc. Fayetteville, NC - 28314,

8.430 s Jan 6 2022 MiTek Industries, Inc. Thu Feb 29 11:47:53 2024 Page 1
ID:QdRWmBS7rn75moFzg6tYesyW6Ye-RfC?PsB70Hq3NSgPqnL8w3uITXbGKWrcDoi7J4zJC?f

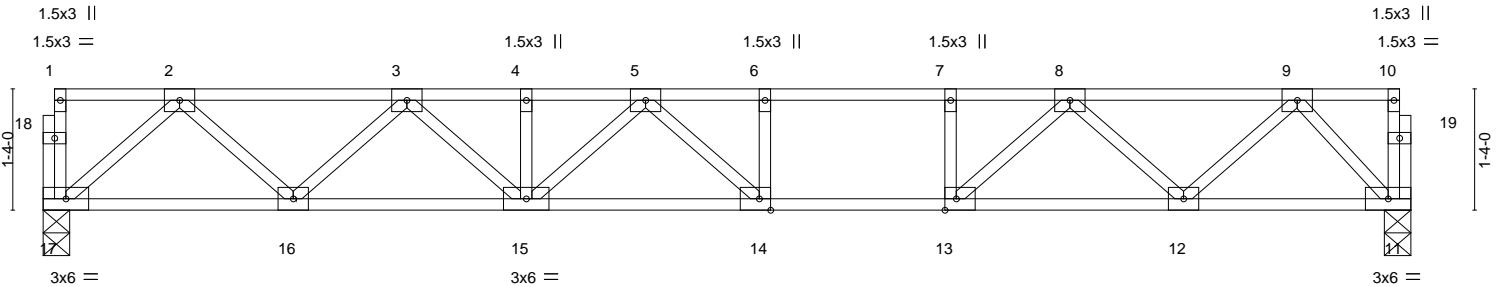
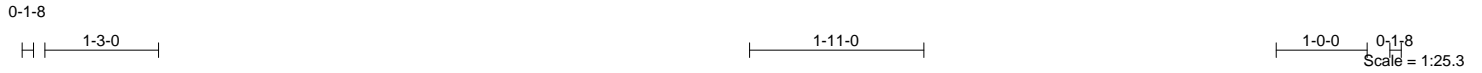

Plate Offsets (X,Y)--	[13:0-1-8,Edge], [14:0-1-8,Edge]								
LOADING (psf)	SPACING-	2-0-0	CSI.	DEFL.	in (loc)	l/defl	L/d	PLATES	GRIP
TCLL 40.0	Plate Grip DOL 1.00		TC 0.76	Vert(LL) -0.20	14-15	>896	480	MT20	244/190
TCDL 10.0	Lumber DOL 1.00		BC 0.83	Vert(CT) -0.27	14-15	>661	360		
BCLL 0.0	Rep Stress Incr YES		WB 0.38	Horz(CT) 0.04	11	n/a	n/a		
BCDL 5.0	Code IRC2015/TPI2014		Matrix-S						
								Weight: 79 lb	FT = 20%F, 11%E

LUMBER-	BRACING-
TOP CHORD 2x4 SP No.1(flat)	TOP CHORD Structural wood sheathing directly applied or 6-0-0 oc purlins, except end verticals.
BOT CHORD 2x4 SP No.1(flat)	BOT CHORD Rigid ceiling directly applied or 10-0-0 oc bracing.
WEBS 2x4 SP No.3(flat)	

REACTIONS. (size) 17=0-3-8, 11=0-3-8
Max Grav 17=807(LC 1), 11=807(LC 1)

FORCES. (lb) - Max. Comp./Max. Ten. - All forces 250 (lb) or less except when shown.
TOP CHORD 2-3=-1421/0, 3-4=-2278/0, 4-5=-2278/0, 5-6=-2364/0, 6-7=-2364/0, 7-8=-2364/0, 8-9=-1293/0
BOT CHORD 16-17=0/866, 15-16=0/1958, 14-15=0/2452, 13-14=0/2364, 12-13=0/1870, 11-12=0/729
WEBS 2-17=-1150/0, 2-16=0/772, 3-16=-746/0, 3-15=0/436, 5-14=-292/251, 9-11=-1069/0, 9-12=0/785, 8-12=-802/0, 8-13=0/803, 7-13=-385/0

- NOTES-**
- 1) Unbalanced floor live loads have been considered for this design.
 - 2) All plates are 3x4 MT20 unless otherwise indicated.
 - 3) Plates checked for a plus or minus 1 degree rotation about its center.
 - 4) Recommend 2x6 strongbacks, on edge, spaced at 10-0-0 oc and fastened to each truss with 3-10d (0.131" X 3") nails. Strongbacks to be attached to walls at their outer ends or restrained by other means.



Job J0724-4211	Truss F04	Truss Type FLOOR	Qty 5	Ply 1	Lot 15 Williams Farm Job Reference (optional)	163950706
-------------------	--------------	---------------------	----------	----------	--	-----------

Comtech, Inc. Fayetteville, NC - 28314,

8.430 s Jan 6 2022 MiTek Industries, Inc. Thu Feb 29 11:47:53 2024 Page 1

ID:QdRWmBS7rn75moFzg6tYesyW6Ye-RfC?PsB70Hq3NSgPqnL8w3uITXbGKWrCdoi7J4zJC?f

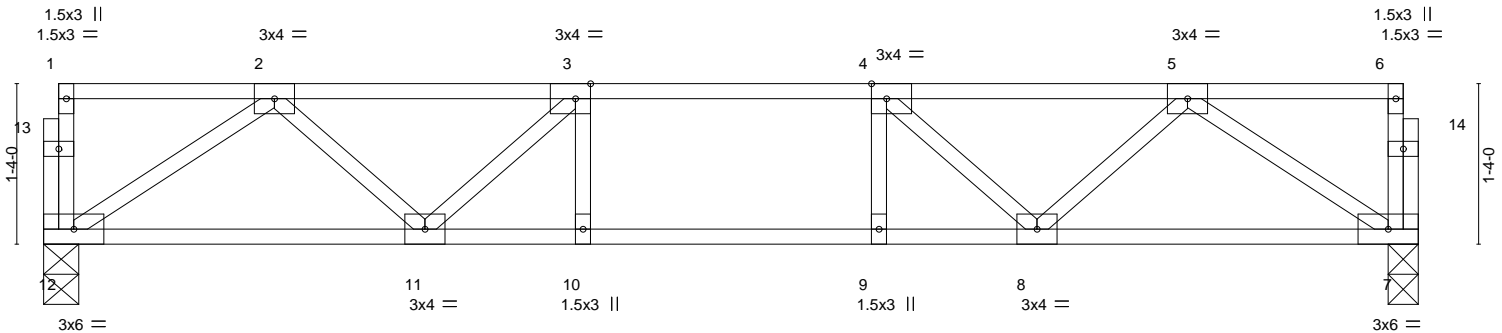
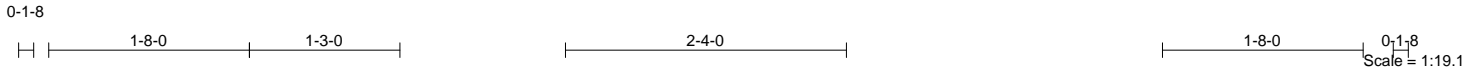

11-5-0
11-5-0

Plate Offsets (X,Y)--	[3:0-1-8,Edge], [4:0-1-8,Edge]				
LOADING (psf)	SPACING- 2-0-0	CSI.	DEFL. in (loc) l/defl L/d	PLATES	GRIP
TCLL 40.0	Plate Grip DOL 1.00	TC 0.33	Vert(LL) -0.08 10-11 >999 480	MT20	244/190
TCDL 10.0	Lumber DOL 1.00	BC 0.47	Vert(CT) -0.09 10 >999 360		
BCLL 0.0	Rep Stress Incr YES	WB 0.23	Horz(CT) 0.02 7 n/a n/a		
BCDL 5.0	Code IRC2015/TPI2014	Matrix-S		Weight: 58 lb	FT = 20%F, 11%E

LUMBER-	BRACING-
TOP CHORD 2x4 SP No.1(flat)	TOP CHORD Structural wood sheathing directly applied or 6-0-0 oc purlins, except end verticals.
BOT CHORD 2x4 SP No.1(flat)	BOT CHORD Rigid ceiling directly applied or 10-0-0 oc bracing.
WEBS 2x4 SP No.3(flat)	

REACTIONS. (size) 12=0-3-8, 7=0-3-0
Max Grav 12=608(LC 1), 7=608(LC 1)

FORCES. (lb) - Max. Comp./Max. Ten. - All forces 250 (lb) or less except when shown.
TOP CHORD 2-3=-1100/0, 3-4=-1391/0, 4-5=-1100/0
BOT CHORD 11-12=0/795, 10-11=0/1391, 9-10=0/1391, 8-9=0/1391, 7-8=0/795
WEBS 2-12=-955/0, 2-11=0/425, 3-11=-459/0, 5-7=-955/0, 5-8=0/425, 4-8=-459/0

NOTES-
1) Unbalanced floor live loads have been considered for this design.
2) Plates checked for a plus or minus 1 degree rotation about its center.
3) Recommend 2x6 strongbacks, on edge, spaced at 10-0-0 oc and fastened to each truss with 3-10d (0.131" X 3") nails. Strongbacks to be attached to walls at their outer ends or restrained by other means.

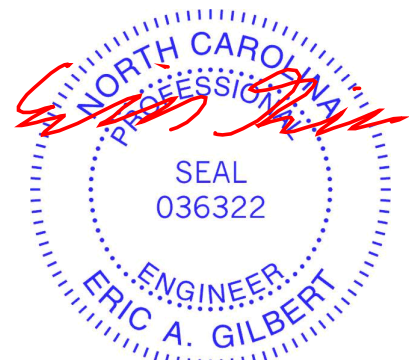

March 4, 2024

<p>WARNING - Verify design parameters and READ NOTES ON THIS AND INCLUDED MITEK REFERENCE PAGE MII-7473 rev. 1/2/2023 BEFORE USE.</p> <p>Design valid for use only with MiTek® connectors. This design is based only upon parameters shown, and is for an individual building component, not a truss system. Before use, the building designer must verify the applicability of design parameters and properly incorporate this design into the overall building design. Bracing indicated is to prevent buckling of individual truss web and/or chord members only. Additional temporary and permanent bracing is always required for stability and to prevent collapse with possible personal injury and property damage. For general guidance regarding the fabrication, storage, delivery, erection and bracing of trusses and truss systems, see ANSI/TPH Quality Criteria and DSB-22 available from Truss Plate Institute (www.tpinst.org) and BCSI Building Component Safety Information available from the Structural Building Component Association (www.sbcacomponents.com)</p>	<p>ENGINEERING BY</p> <p>A MiTek Affiliate</p> <p>818 Soundside Road Edenton, NC 27932</p>
--	--

Job J0724-4211	Truss FKW1	Truss Type GABLE	Qty 1	Ply 1	Lot 15 Williams Farm Job Reference (optional)	I63950707
-------------------	---------------	---------------------	----------	----------	--	-----------

Comtech, Inc. Fayetteville, NC - 28314,

8.430 s Jan 6 2022 MiTek Industries, Inc. Thu Feb 29 11:47:54 2024 Page 1
ID:QdRWmBS7rn75moFzg6tYesyW6Ye-RfC?PsB70Hq3NSgPqnL8w3uITXbGKWrCDoi7J4zJC?f

0.1-8

0.1-8

Scale = 1:18.9

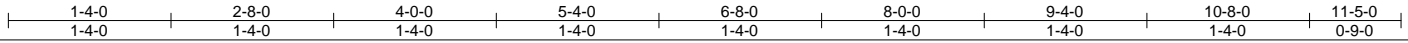
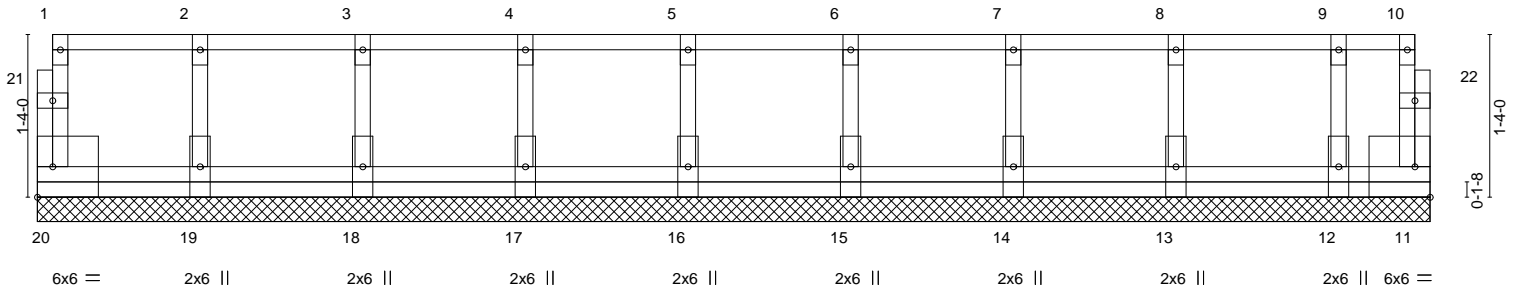

LOADING (psf)	SPACING-	2-0-0	CSI.	DEFL.	in (loc)	l/defl	L/d	PLATES	GRIP	
TCLL 40.0	Plate Grip DOL	1.00	TC 0.07	Vert(LL)	n/a	-	n/a	999	MT20	244/190
TCDL 10.0	Lumber DOL	1.00	BC 0.01	Vert(CT)	n/a	-	n/a	999		
BCLL 0.0	Rep Stress Incr	NO	WB 0.03	Horz(CT)	0.00	11	n/a	n/a		
BCDL 5.0	Code IRC2015/TPI2014		Matrix-R							
									Weight: 67 lb	FT = 20%F, 11%E

LUMBER-
TOP CHORD 2x4 SP No.1(flat)
BOT CHORD 2x4 SP No.1(flat)
WEBS 2x4 SP No.3(flat)
OTHERS 2x4 SP No.3(flat)

BRACING-
TOP CHORD Structural wood sheathing directly applied or 6-0-0 oc purlins, except end verticals.
BOT CHORD Rigid ceiling directly applied or 10-0-0 oc bracing.

REACTIONS. All bearings 11-5-0.
(lb) - Max Grav All reactions 250 lb or less at joint(s) 20, 11, 19, 18, 17, 16, 15, 14, 13, 12

FORCES. (lb) - Max. Comp./Max. Ten. - All forces 250 (lb) or less except when shown.

- NOTES-**
- 1) All plates are 1.5x3 MT20 unless otherwise indicated.
 - 2) Plates checked for a plus or minus 1 degree rotation about its center.
 - 3) Gable requires continuous bottom chord bearing.
 - 4) Truss to be fully sheathed from one face or securely braced against lateral movement (i.e. diagonal web).
 - 5) Gable studs spaced at 1-4-0 oc.
 - 6) Recommend 2x6 strongbacks, on edge, spaced at 10-0-0 oc and fastened to each truss with 3-10d (0.131" X 3") nails. Strongbacks to be attached to walls at their outer ends or restrained by other means.

LOAD CASE(S) Standard
1) Dead + Floor Live (balanced): Lumber Increase=1.00, Plate Increase=1.00
Uniform Loads (plf)
Vert: 11-20=-10, 1-10=-100
Concentrated Loads (lb)
Vert: 1=-104

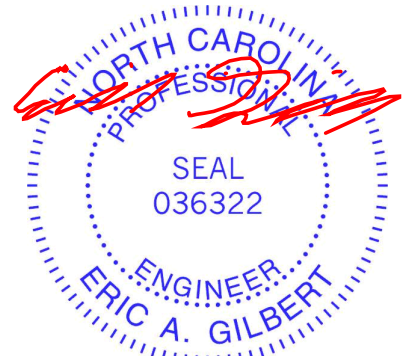

March 4, 2024

WARNING - Verify design parameters and READ NOTES ON THIS AND INCLUDED MITEK REFERENCE PAGE MII-7473 rev. 1/2/2023 BEFORE USE.
Design valid for use only with MiTek® connectors. This design is based only upon parameters shown, and is for an individual building component, not a truss system. Before use, the building designer must verify the applicability of design parameters and properly incorporate this design into the overall building design. Bracing indicated is to prevent buckling of individual truss web and/or chord members only. Additional temporary and permanent bracing is always required for stability and to prevent collapse with possible personal injury and property damage. For general guidance regarding the fabrication, storage, delivery, erection and bracing of trusses and truss systems, see **ANSI/TP1 Quality Criteria and DSB-22** available from Truss Plate Institute (www.tpinst.org) and **BCSI Building Component Safety Information** available from the Structural Building Component Association (www.sbcacomponents.com)



818 Soundside Road
Edenton, NC 27932

Job J0724-4211	Truss FKW2	Truss Type FLOOR SUPPORTED GABL	Qty 1	Ply 1	Lot 15 Williams Farm Job Reference (optional)	163950708
-------------------	---------------	------------------------------------	----------	----------	--	-----------

Comtech, Inc. Fayetteville, NC - 28314,

8.430 s Jan 6 2022 MiTek Industries, Inc. Thu Feb 29 11:47:55 2024 Page 1
ID:QdRWmBS7rn75moFzg6tYesyW6Ye-RfC?PsB70Hq3NSgPqnL8w3uITXbGKWrCDoi7J4zJC?f

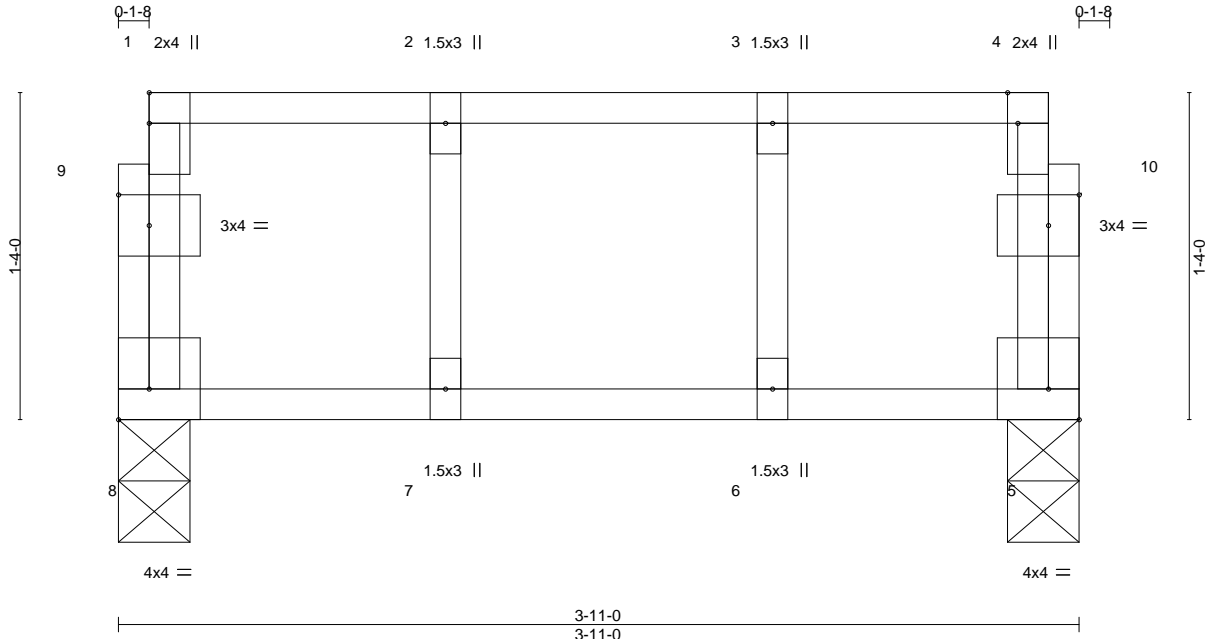

Scale = 1:9.4

Plate Offsets (X,Y)--	[4:0-1-8,Edge], [5:Edge,0-1-8], [8:Edge,0-1-8], [9:0-1-8,0-1-8], [10:0-1-8,0-1-8]
-----------------------	---

LOADING (psf)	SPACING-	2-0-0	CSI.	DEFL.	in (loc)	l/defl	L/d	PLATES	GRIP	
TCLL 40.0	Plate Grip DOL	1.00	TC 0.52	Vert(LL)	-0.02	6-7	>999	480	MT20	244/190
TCDL 10.0	Lumber DOL	1.00	BC 0.28	Vert(CT)	-0.03	6-7	>999	360		
BCLL 0.0	Rep Stress Incr	YES	WB 0.01	Horz(CT)	0.00	5	n/a	n/a		
BCDL 5.0	Code	IRC2015/TPI2014	Matrix-R							
									Weight: 20 lb	FT = 20%F, 11%E

LUMBER-	BRACING-
TOP CHORD 2x4 SP No.1(flat)	TOP CHORD Structural wood sheathing directly applied or 3-11-0 oc purlins, except end verticals.
BOT CHORD 2x4 SP No.1(flat)	BOT CHORD Rigid ceiling directly applied or 10-0-0 oc bracing.
WEBS 2x4 SP No.3(flat)	
OTHERS 2x4 SP No.3(flat)	

REACTIONS. (size) 8=0-3-8, 5=0-3-8
Max Grav 8=195(LC 1), 5=195(LC 1)

FORCES. (lb) - Max. Comp./Max. Ten. - All forces 250 (lb) or less except when shown.

- NOTES-**
- 1) Plates checked for a plus or minus 1 degree rotation about its center.
 - 2) Truss to be fully sheathed from one face or securely braced against lateral movement (i.e. diagonal web).
 - 3) Gable studs spaced at 1-4-0 oc.
 - 4) Recommend 2x6 strongbacks, on edge, spaced at 10-0-0 oc and fastened to each truss with 3-10d (0.131" X 3") nails. Strongbacks to be attached to walls at their outer ends or restrained by other means.

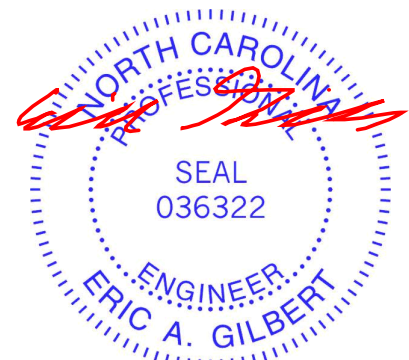

March 4, 2024

Symbols

PLATE LOCATION AND ORIENTATION

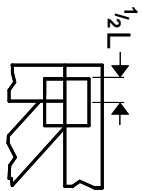

Center plate on joint unless x, y offsets are indicated. Dimensions are in ft-in-sixteenths. Apply plates to both sides of truss and fully embed teeth.

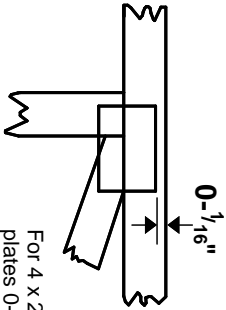

For 4 x 2 orientation, locate plates 0- 1/16\"/>



This symbol indicates the required direction of slots in connector plates.

* Plate location details available in MITek software or upon request.

PLATE SIZE

4 X 4

The first dimension is the plate width measured perpendicular to slots. Second dimension is the length parallel to slots.

LATERAL BRACING LOCATION



Indicated by symbol shown and/or by text in the bracing section of the output. Use T or I bracing if indicated.

BEARING

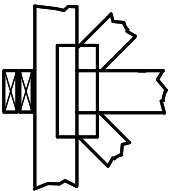

Indicates location where bearings (supports) occur. Icons vary but reaction section indicates joint number/letter where bearings occur. Min size shown is for crushing only.

Industry Standards:

ANSI/TP1: National Design Specification for Metal Plate Connected Wood Truss Construction.
DSB-22: Design Standard for Bracing.
BCSI: Building Component Safety Information, Guide to Good Practice for Handling, Installing, Restraining & Bracing of Metal Plate Connected Wood Trusses.

Numbering System

6-4-8 dimensions shown in ft-in-sixteenths (Drawings not to scale)

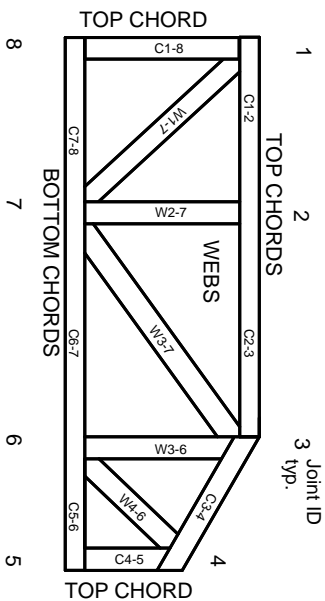

JOINTS ARE GENERALLY NUMBERED/LETTERED CLOCKWISE AROUND THE TRUSS STARTING AT THE JOINT FARTHEST TO THE LEFT.

CHORDS AND WEBS ARE IDENTIFIED BY END JOINT NUMBERS/LETTERS.

Product Code Approvals

ICC-ES Reports:

ESR-1988, ESR-2362, ESR-2685, ESR-3282
ESR-4722, ESL-1388

Design General Notes

Trusses are designed for wind loads in the plane of the truss unless otherwise shown.

Lumber design values are in accordance with ANSI/TP1 section 6.3. These truss designs rely on Lumber values established by others.

© 2023 MITek® All Rights Reserved

MITek

ENGINEERING BY
TRENGO
A MITek Affiliate

MITek Engineering Reference Sheet: MIL-7473 rev. 1/2/2023

General Safety Notes

Failure to Follow Could Cause Property Damage or Personal Injury

1. Additional stability/bracing for truss system, e.g. diagonal or X-bracing, is always required. See BCSI.
2. Truss bracing must be designed by an engineer. For wide truss spacing, individual lateral braces themselves may require bracing, or alternative Tor I bracing should be considered.
3. Never exceed the design loading shown and never stack materials on inadequately braced trusses.
4. Provide copies of this truss design to the building designer, erection supervisor, property owner and all other interested parties.
5. Cut members to bear tightly against each other.
6. Place plates on each face of truss at each joint and embed fully. Knots and wane at joint locations are regulated by ANSI/TP1 1.
7. Design assumes trusses will be suitably protected from the environment in accord with ANSI/TP1 1.
8. Unless otherwise noted, moisture content of lumber shall not exceed 19% at time of fabrication.
9. Unless expressly noted, this design is not applicable for use with fire retardant, preservative treated, or green lumber.
10. Camber is a non-structural consideration and is the responsibility of truss fabricator. General practice is to camber for dead load deflection.
11. Plate type, size, orientation and location dimensions indicated are minimum plating requirements.
12. Lumber used shall be of the species and size, and in all respects, equal to or better than that specified.
13. Top chords must be sheathed or purlins provided at spacing indicated on design.
14. Bottom chords require lateral bracing at 10 ft. spacing, or less, if no ceiling is installed, unless otherwise noted.
15. Connections not shown are the responsibility of others.
16. Do not cut or alter truss member or plate without prior approval of an engineer.
17. Install and load vertically unless indicated otherwise.
18. Use of green or treated lumber may pose unacceptable environmental, health or performance risks. Consult with project engineer before use.
19. Review all portions of this design (front, back, words and pictures) before use. Reviewing pictures alone is not sufficient.
20. Design assumes manufacture in accordance with ANSI/TP1 1 Quality Criteria.
21. The design does not take into account any dynamic or other loads other than those expressly stated.