

Mitchell Environmental, P.A.

SEPTIC SYSTEM DESIGN

for

PRINCE PLACE SUBDIVISION- LOT 25
Fuquay-Varina, Harnett County, North Carolina

Submitted to:

Harnett County Health Department
307 Cornelius Harnett Blvd.
Lillington, NC 27546

Prepared for:

Davidson Homes, LLC
336 James Record Road
Huntsville, Alabama 35824

Prepared by:

Scott Mitchell, PE, LSS
Adam Aycock, EI

DATE: January 12, 2022
PROJECT NO.: 4321

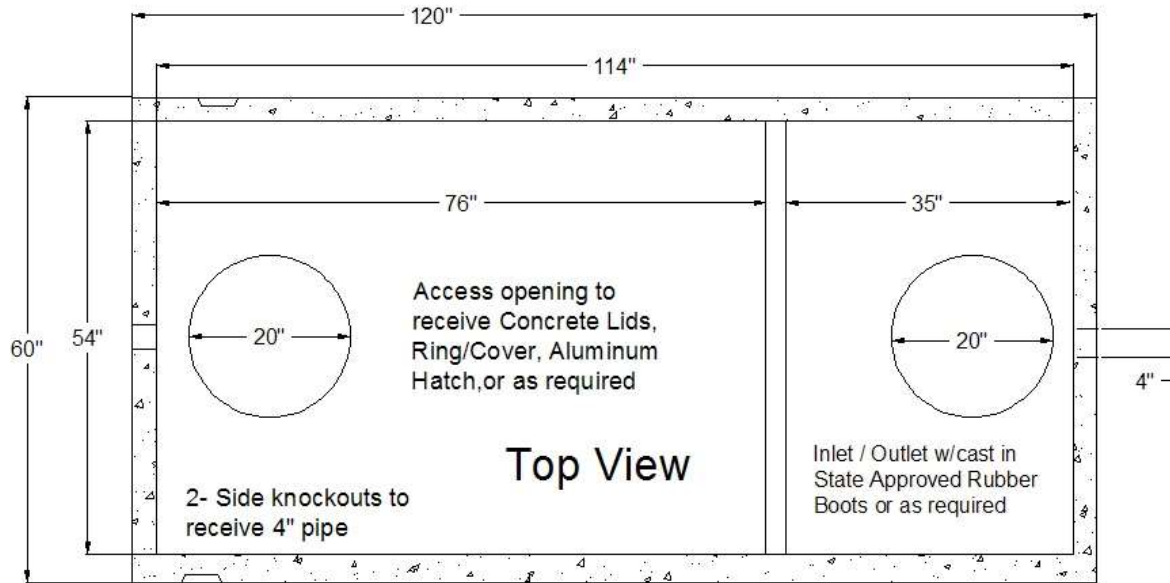

STB - 345 - Top Seam

Approval Date: 12 - 09 - 99

Liquid Capacity 1007 Gallons

Non Traffic Rated

Reinforcing Schedule: # 3 Grade 60 Rebar

4500 PSI Concrete w/ State Approved Structural Fiber

Est. Weight: 8,200 lbs.

Manufactured By:

GARNERS

Septic Tanks, Inc.

Eddie Garner, President

919-718-5181

121 Stanton Hill Road

Carthage, NC 28327

Fax 919-775-2229

Eddie@garnersseptic tanks.com

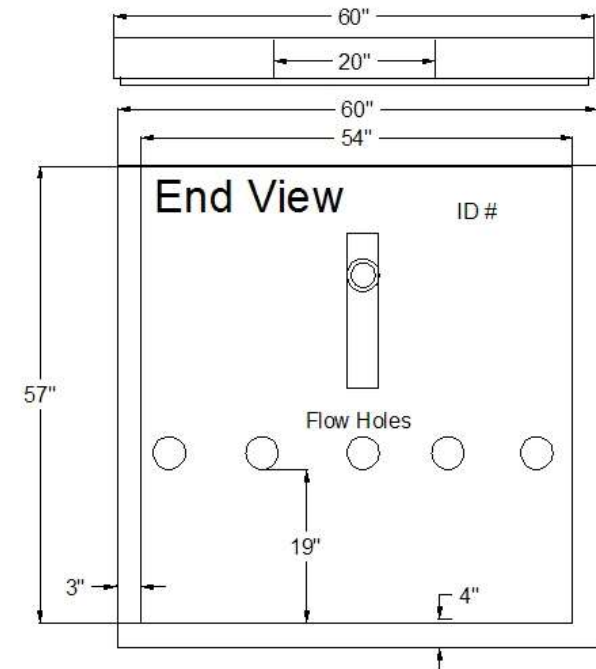
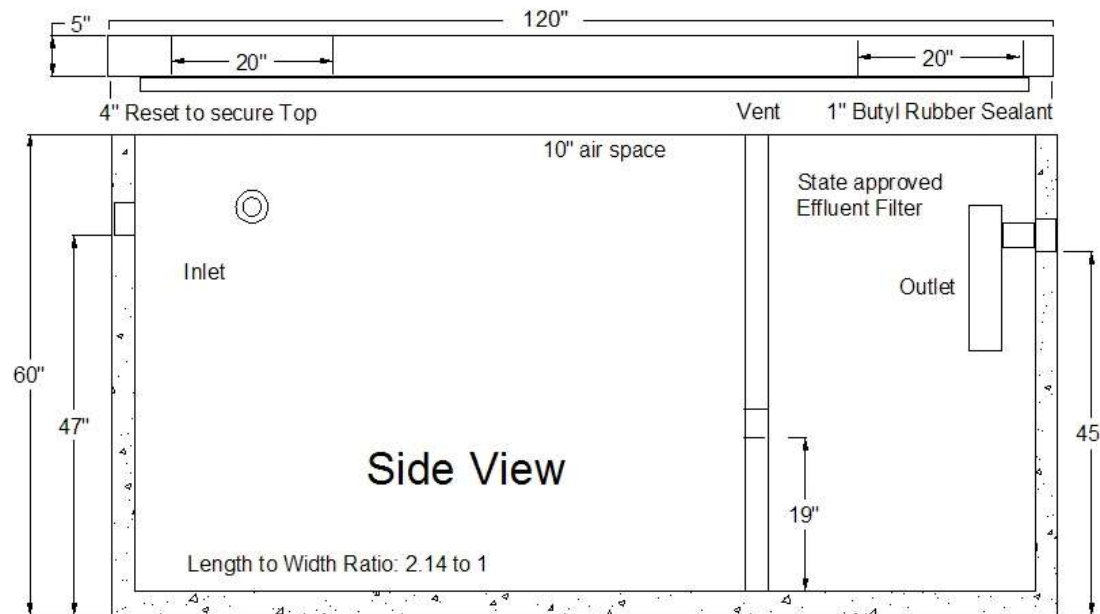

PL-68 Filter and Tee

PL-68 is much more than just an effluent filter. The housing can also be used as an inlet baffle (tee) or an outlet baffle. The housing is designed to accept Polylok’s snap in gas deflector to deflect gas bubbles away from the tee and to keep the solids in the tank.

Features:

- Offers 68 linear feet of 1/16” filter slots, which significantly extends time between cleaning.
- Accepts 3/4” PVC handle.
- Locks in any 360° position when used with PL-68 Tee.
- PL-68 Housing can be used as an inlet or outlet tee.
- Gasket prevents bypass.

PL-68 Installation:

Ideal for residential waste flows up to 800 gallons per day (GPD). Easily installs in any new or existing 4” outlet tee.

1. Locate the outlet of the septic tank.
2. Remove the tank cover and pump tank if necessary.
3. Glue the filter housing to the outlet pipe, or use a Polylok Extend & Lok if not enough pipe exists.
4. Insert the PL-68 filter into tee.
5. Replace and secure the septic tank cover.

PL-68 Maintenance:

The PL-68 Effluent Filter will operate efficiently for several years under normal conditions before requiring cleaning. It is recommended that the filter be cleaned every time the tank is pumped, or at least every three years.

1. Do not use plumbing when filter is removed.
2. Pull PL-68 out of the tee.
3. Hose off filter over the septic tank. Make sure all solids fall back into septic tank.
4. Insert filter back into tee/housing.

Related Products:

PL-68 Filter Concrete Baffle
 Extend & Lok™

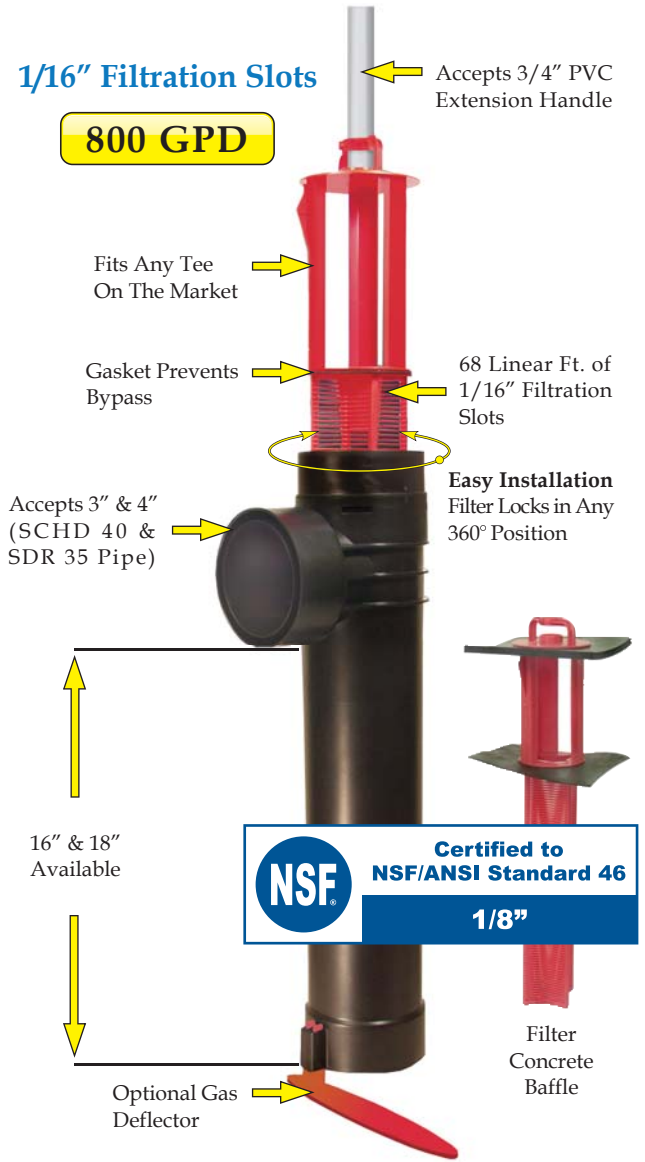

Extend & Lok™
 Easily installs into existing tanks.



Spacer Bushing
 4” SCHD 40 to SDR 35



Spacer Bushing
 4” SCHD 40 to 110mm Pipe



2” Extender



EZflow by Infiltrator is an environmentally friendly replacement to traditional stone and pipe drainfields using an engineered geosynthetic aggregate modular design. The EZflow system is designed to improve infiltration performance by eliminating the fines associated with crushed stone, and reducing compaction and embedment associated with stone. Preassembled units include a 3" or 4" perforated pipe surrounded by aggregate and held in place with a durable high-strength netting. This product comes in easy-to-contour 5' and 10' lengths and in diameters of 7, 8, 9, 10, 12, 13, or 14 inches.

Lightweight expanded polystyrene

construction offers structural integrity and resists compaction. Engineered flow-channels increase void space creating improved water flow and greater storage.



Compared with stone and pipe, benefits include:

- Always clean and free of fines
- Bundles are quick to install, saving costs on heavy machinery and labor
- Modular construction allows configurations to match trench dimensions for most system shapes and sizes
- Engineered for optimal storage and absorption efficiencies
- Ability to contour along sloped sites and around trees or landscaping
- Lightweight system is perfect for repairs and tight job sites
- Easily hand-carried into position reducing time and labor
- 5' or 10' lengths with simple snap, internal couplers
- Easier cleanup at the job site with the elimination of stone
- Manufactured from recycled materials rather than a mined natural resource
- A wide variety of diameters and configurations to meet any installation professional's needs
- Approved in many jurisdictions with an increased efficiency rating, reducing drainfield size
- Backed by the leader in the onsite wastewater industry

Bundle System Configurations: Available in 7", 8", 9", 10", 12", 13" and 14" diameter bundles.

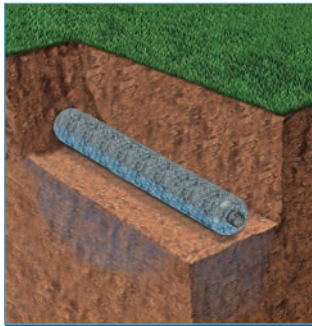

Single Bundle

0701P-GEO 1201P-GEO
0801P-GEO 1401P-GEO
1201P-GEO 1801P-GEO
1001P-GEO

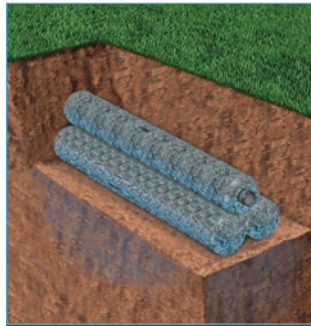

Triangular Bundle

1003T-GEO 1303T-GEO
1203T-GEO 1403T-GEO

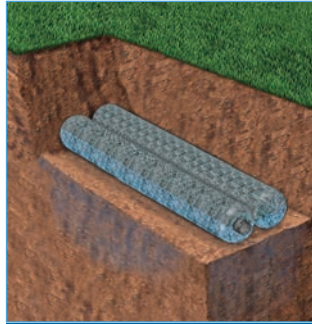

Horizontal Bundles

0705H-GEO 1303H-GEO
0904H-GEO 1202H-GEO
1002H-GEO 1203H-GEO

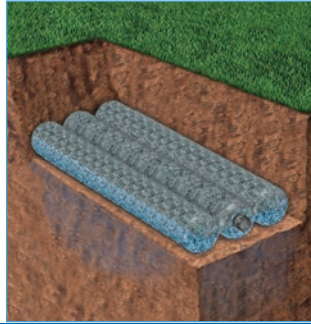

1206H-GEO 1402H-GEO
1303H-GEO 1802H-GEO

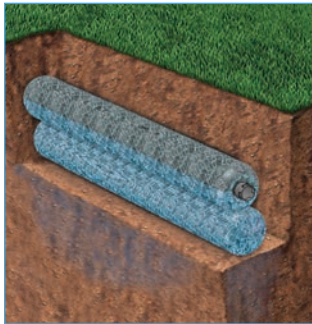

Vertical Bundles

1002V-GEO 1006V-GEO 1203V-GEO 1206V-GEO
1003V-GEO 1202V-GEO 1204V-GEO 1402V-GEO
1004V-GEO

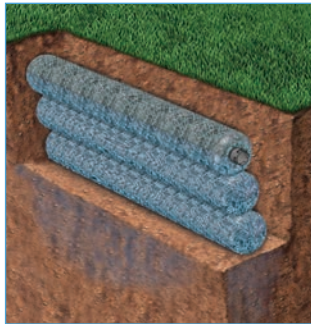

Notes:

1. Other systems include 10" and 12" bed systems. Bed size will dictate the number of bundles.
2. System dimensions are dependent upon bundle diameter and configuration.
3. LLP is for "Low Pressure Pipe" in which a pressurized distribution pipe is field installed within the corrugated pipe.
4. Internal pipe and couplings meet the requirements of ASTM F405.
5. Bundles are also available without geotextile between the netting and synthetic aggregate.

INFILTRATOR WATER TECHNOLOGIES STANDARD LIMITED WARRANTY

(a) The structural integrity of each EZflow by Infiltrator expanded polystyrene drainfield system and other accessories manufactured by EZflow by Infiltrator ("Units"), when installed and operated in a leachfield of an onsite septic system in accordance with Infiltrator's instructions, is warranted to the original purchaser ("Holder") against defective materials and workmanship for one year from the date that the septic permit is issued for the septic system containing the Units; provided, however, that if a septic permit is not required by applicable law, the warranty period will begin upon the date that installation of the septic system commences. To exercise its warranty rights, Holder must notify Infiltrator in writing at its Corporate Headquarters in Old Saybrook, Connecticut within fifteen (15) days of the alleged defect. Infiltrator will supply replacement Units for Units determined by EZflow by Infiltrator to be covered by this Limited Warranty. EZflow by Infiltrator's liability specifically excludes the cost of removal and/or installation of the Units.

(b) THE LIMITED WARRANTY AND REMEDIES IN SUBPARAGRAPH (a) ARE EXCLUSIVE. THERE ARE NO OTHER WARRANTIES WITH RESPECT TO THE UNITS, INCLUDING NO IMPLIED WARRANTIES OF MERCHANTABILITY OR FITNESS FOR A PARTICULAR PURPOSE

(c) This Limited Warranty shall be void if any part of the EZflow system is manufactured by anyone other than EZflow by Infiltrator. The Limited Warranty does not extend to incidental, consequential, special or indirect damages. Infiltrator shall not be liable for penalties or liquidated damages, including loss of production and profits, labor and materials, overhead costs, or other losses or expenses incurred by the Holder or any third party. Specifically excluded from Limited Warranty coverage are damage to the Units due to ordinary wear and tear, alteration, accident, misuse, abuse or neglect of the Units; the Units being subjected to vehicle traffic or other conditions which are not permitted by the installation instructions; failure to maintain the minimum ground covers set forth in the installation instructions; the placement of improper materials into the system containing the Units; failure of the Units or the septic system due to improper siting or improper sizing, excessive water usage, improper grease disposal, or improper operation; or any other event not caused by Infiltrator. This Limited Warranty shall be void if the Holder fails to comply with all of the terms set forth in this Limited Warranty. Further, in no event shall Infiltrator be responsible for any loss or damage to the Holder, the Units, or any third party resulting from installation or shipment, or from any product liability claims of Holder or any third party. For this Limited Warranty to apply, the Units must be installed in accordance with all site conditions required by state and local codes; all other applicable laws; and Infiltrator's installation instructions.

(d) No representative of Infiltrator has the authority to change or extend this Limited Warranty. No warranty applies to any party other than the original Holder.

The above represents the Standard Limited Warranty offered by Infiltrator. A limited number of states and counties have different warranty requirements. Any purchaser of Units should contact Infiltrator's Corporate Headquarters in Old Saybrook, Connecticut, prior to such purchase, to obtain a copy of the applicable warranty, and should carefully read that warranty prior to the purchase of Units.



4 Business Park Road
P.O. Box 768
Old Saybrook, CT 06475
860-577-7000 • Fax 860-577-7001
1-800-221-4436
www.infiltratorwater.com

U.S. Patents: 4,759,661; 5,017,041; 5,156,488; 5,336,017; 5,401,116; 5,401,459; 5,511,903; 5,716,163; 5,588,778; 5,839,844 Canadian Patents: 1,329,959; 2,004,564 Other patents pending. Infiltrator, Equalizer, Quick4, and SideWinder are registered trademarks of Infiltrator Water Technologies. Infiltrator is a registered trademark in France. Infiltrator Water Technologies is a registered trademark in Mexico. Contour, MicroLeaching, PolyTuff, ChamberSpacer, MultiPort, PosiLock, QuickCut, QuickPlay, SnapLock and StraightLock are trademarks of Infiltrator Water Technologies. PolyLok is a trademark of PolyLok, Inc. TUF-TITE is a registered trademark of TUF-TITE, INC. Ultra-Rib is a trademark of IPEX Inc.

© 2015 Infiltrator Water Technologies, LLC. All rights reserved. Printed in U.S.A.

EZ01 0315AG

Contact Infiltrator Water Technologies' Technical Services Department for assistance at 1-800-221-4436

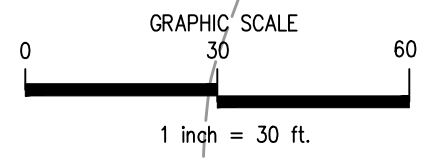

3-Bedroom
 LTAR: 0.3 gpd/ft²
 Initial: Gravity conventional
 utilizing lines 7-9 (300')
 Repair: Gravity conventional
 utilizing lines 5-6 (300')

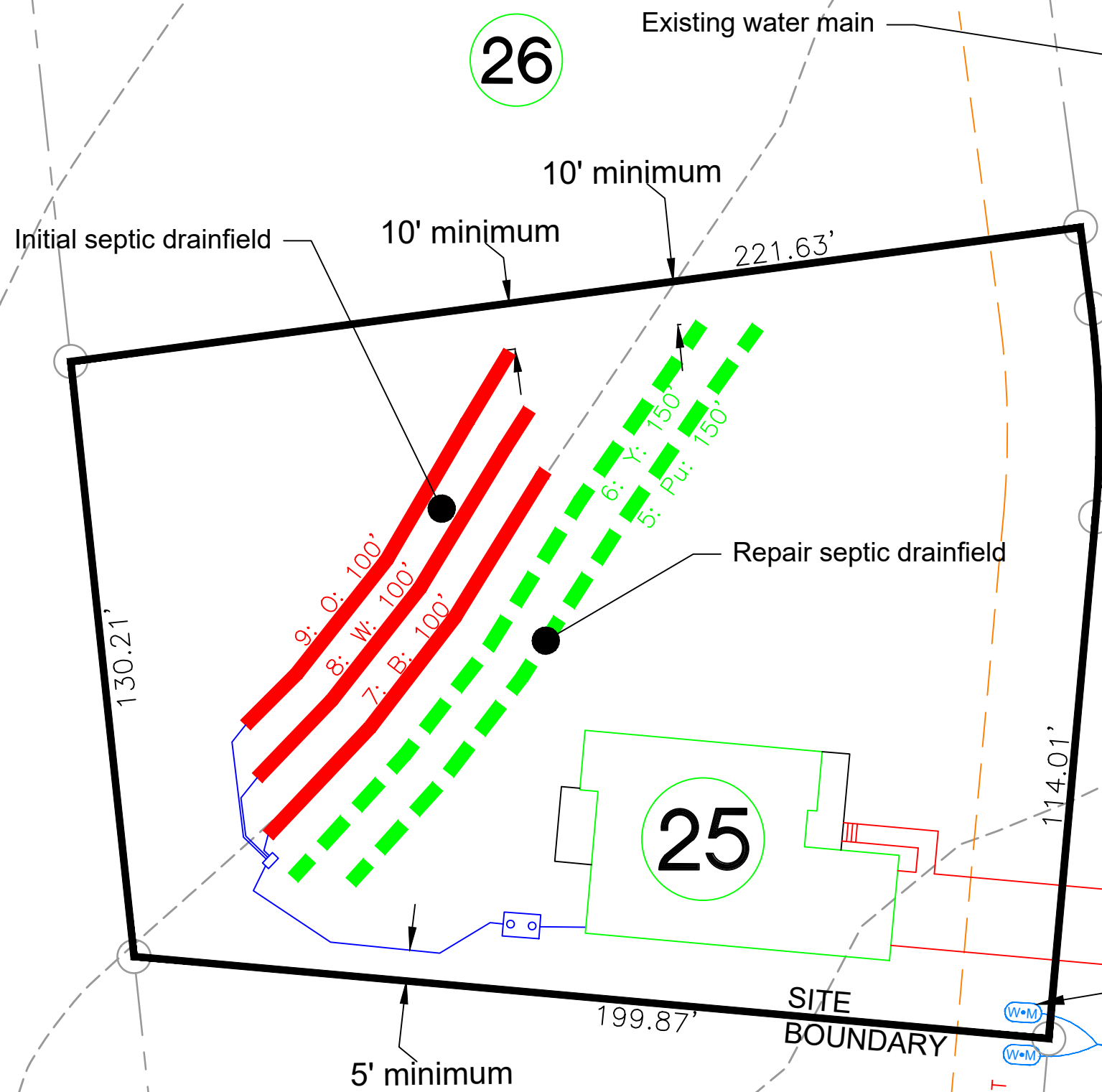

26

Existing water main

10' minimum

Initial septic drainfield

10' minimum

221.63'

9: O: 100'
 8: W: 100'
 7: B: 100'

Repair septic drainfield

25

SITE BOUNDARY

199.87'

114.01'

BLUE MONARCH LANE

Existing water meter (Typical)

5' minimum

24

20' PUBLIC UTILITY EASEMENT

MITCHELL ENVIRONMENTAL, PA C-2917		SHEET NUMBER 1 of 5
1501 LAKESTONE VILLAGE LANE SUITE 205 FUQUAY VARINA, NC 27526		Prince Place Lot 25 Overall Septic
PREPARED FOR : Davison Homes 336 James Record Road Huntsville, AL 35824	REVISION NO. Original Submittal Revision 1 Revision 2 Revision 3 Master Set	DATE January 12, 2022
DATE : January 12, 2022 ENGINEER AND SOIL SCIENTIST CONTACT: SCOTT MITCHELL, PE, LSS	DRAWN BY: ADAM AYCOCK, EI	

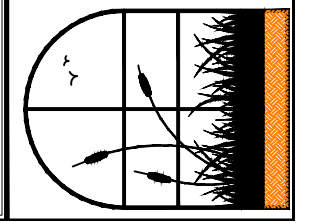

26

25

24

10' minimum

5' minimum

221.63'

130.21'

199.87'

114.01'

BLUE MONARCH LANE

20' PUBLIC UTILITY EASEMENT

SITE BOUNDARY

1,000 gallon Septic Tank

3 inch SCH 40 PVC (typ.)

Distribution Box

3 inch SCH 40 PVC

9: O: 100'
8: W: 100'
7: B: 100'

GRAPHIC SCALE

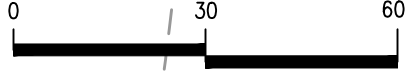

1/ inch = 30 ft.

ES. 0.00V

SHEET NUMBER	
2 of 5	
Prince Place Lot 25 Initial Nitritification Field	

REVISION NO.	DATE
Original Submittal	January 12, 2022
Revision 1	-----
Revision 2	-----
Revision 3	-----
Master Set	-----

PREPARED FOR : Davidson Homes
336 James Record Road
Huntsville, AL 35824

DATE : January 12, 2022

ENGINEER AND SOIL SCIENTIST CONTACT:
SCOTT MITCHELL, PE, LSS

DRAWN BY:
ADAM AYCOCK, EI

MITCHELL ENVIRONMENTAL, PA
C-2917

1501 LAKESTONE VILLAGE LANE
SUITE 205
FUQUAY VARINA, NC 27526

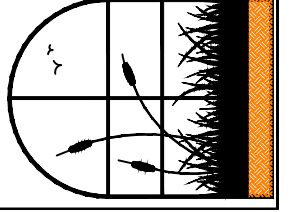

26

10' minimum

221.63'

130.21'

199.87'

114.01'

25

BLUE MONARCH LANE

SITE BOUNDARY

20' PUBLIC UTILITY EASEMENT

24

6: Y: 150'
5: PU: 150'

2" W 2" Z 2" W 2" Z 2" W 2" Z 2" W 2" Z 2" W 2" Z 2" W 2" Z

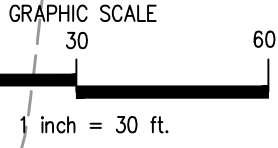
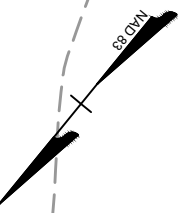

MITCHELL ENVIRONMENTAL, PA
C-2917

1501 LAKESTONE VILLAGE LANE
SUITE 205
FUQUAY VARINA, NC 27526

PREPARED FOR : Davidson Homes
336 James Record Road
Huntsville, AL 35824

DATE : January 12, 2022

ENGINEER AND SOIL SCIENTIST CONTACT:
SCOTT MITCHELL, PE, LSS

DRAWN BY:
ADAM AYCOCK, EI

REVISION NO.	DATE
Original Submittal	January 12, 2022
Revision 1	-----
Revision 2	-----
Revision 3	-----
Master Set	-----

SHEET NUMBER
3 of 5

Prince Place
Lot 25
Repair Nitrification Field

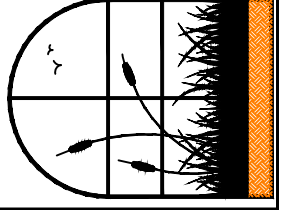

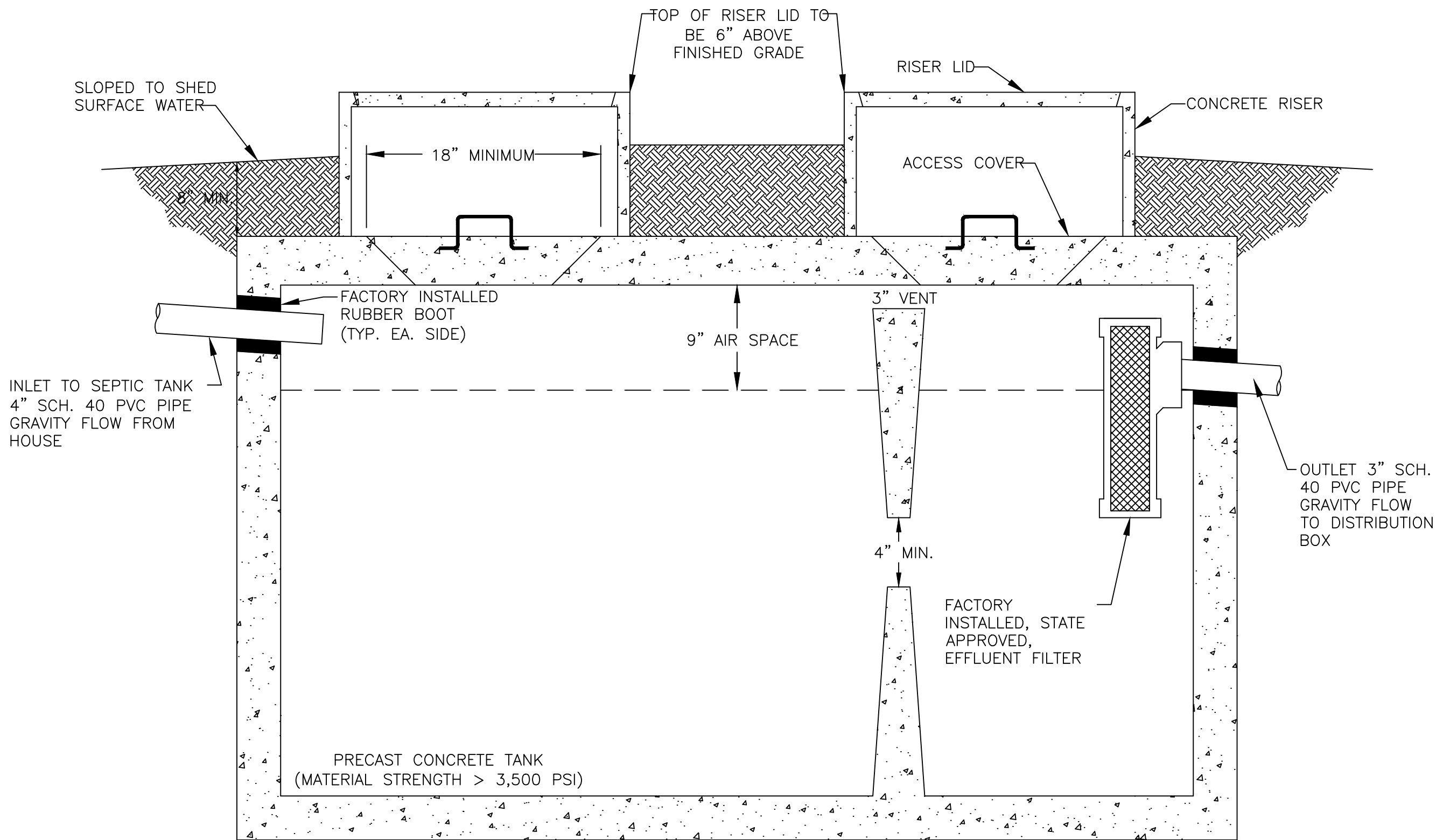

1,000 GALLON SEPTIC TANK

SEPTIC TANK DETAIL

N.T.S.

SHEET NUMBER		4 of 5	
PREPARED FOR : Davison Homes 336 James Record Road Huntsville, AL 35824		PRINCE PLACE Lot 25 Septic Tank Detail	
REVISION NO. Original Submittal	DATE January 12, 2022	REVISION 1 REVISION 2 REVISION 3 Master Set	DATE January 12, 2022
ENGINEER AND SOIL SCIENTIST CONTACT: SCOTT MITCHELL, PE, LSS		DRAWN BY: ADAM AYCOCK, EI	
MITCHELL ENVIRONMENTAL, PA C-2917 1501 LAKESTONE VILLAGE LANE SUITE 205 FUQUAY VARINA, NC 27526			

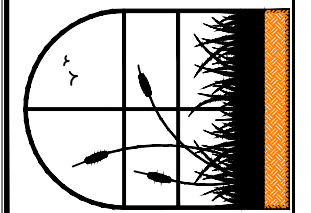

NITRIFICATION TRENCH DETAIL FOR EZ-FLOW

N.T.S.

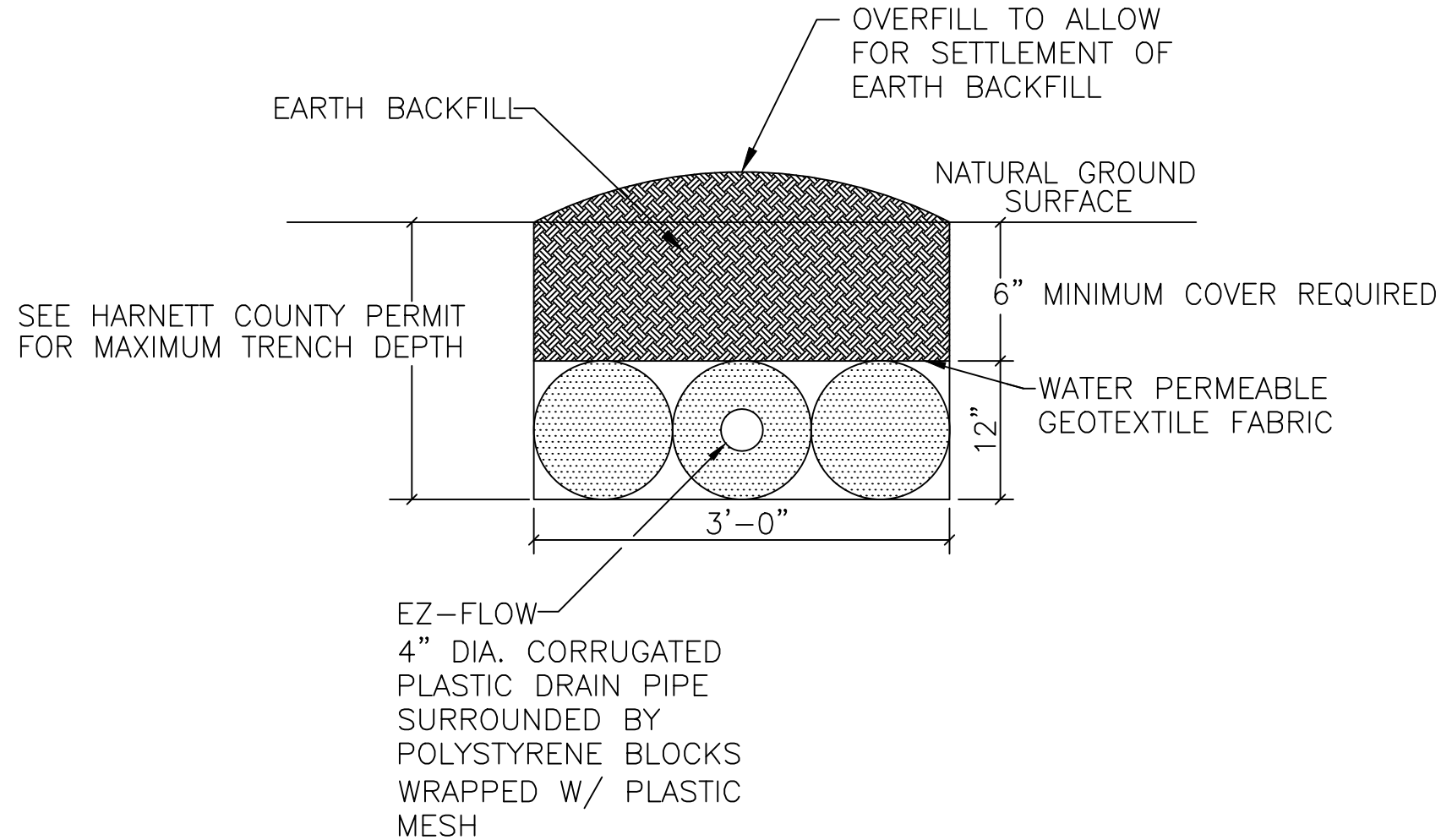

NOTES:

1. PERFORATED CORRUGATED PLASTIC PIPE SHALL MEET REQUIREMENTS OF ASTM D 2729.
2. PIPE SHALL BE LEVEL.
3. ENDCAP SHALL BE PROVIDED AT END OF ALL CORRUGATED PLASTIC PIPE LINES.
4. TRENCH BOTTOM SHALL BE LEVEL.
5. HAND RAKE TRENCH WALLS PRIOR TO PLACEMENT OF TRENCH MEDIA IF SOIL SMEARING IS PRESENT.

SHEET NUMBER

5 of 5

Prince Place
Lot 25
Trench Detail

DATE
January 12, 2022

REVISION NO.
Original Submittal

Revision 1

Revision 2

Revision 3

Master Set

PREPARED FOR : Davidson Homes
336 James Record Road
Huntsville, AL 35824

DATE : January 12, 2022

ENGINEER AND SOIL SCIENTIST CONTACT:

SCOTT MITCHELL, PE, LSS

DRAWN BY:

ADAM AYCOCK, EI

MITCHELL ENVIRONMENTAL, PA
C-2917

1501 LAKESTONE VILLAGE LANE
SUITE 205
FUQUAY VARINA, NC 27526

