

# PLANS FOR:



# MATTAMY HOMES - SEQUOIA RH



MATTAMY HOMES  
**CHARLOTTE DIVISION**  
 PH: 704-375-9373

MATTAMY HOMES  
**RALEIGH DIVISION**  
 PH: 919-752-4898

## ABBREVIATION LEGEND

AB	Anchor Bolt	EQ	Equal	MIN	Minimum	SQ	Square
ABV	Above	EW	Each Way	MIR	Mirror	SS	Solid Surface
ACC	Air Conditioner	EXIST	Existing	MISC	Miscellaneous	SS	Sanitary Sewer
AC	Access/ Accessible	EXP	Exposed	MM	Millimeter	SST	Stainless Steel
ACFL	Access Floor	EXT	Exterior	MO	Masonry Opening	ST	Steel
ADJ	Adjacent	F.A.	Flat Archway	MOV	Movable	STA	Station
ADJ	Adjustable	FD	Floor Drain	MTD	Mounted	STC	Sound Transmission Class
AFF	Above Finished Floor	FDTN	Foundation	MTFR	Metal Furring	STD	Standard
AGGR	Aggregate	FF	Finish Floor	MTL	Metal	STOR	Storage
ALT	Alternate	FG	Fixed Glass	MULL	Mullion	STRUCT	Structural
ALUM	Aluminum	FIN	Finish	MULL	Not In Contract	SYS	System
ANC	Anchor/Anchorage	FLEX	Flexible	NOM	Nominal	T	Tread
AP	Access Panel	FLR	Floor	NR	Noise Reduction	T.A.	Trimmed Archway
APPROX	Approximate	F.O.	Framed Opening	NRC	Noise Reduction Coefficient	TB	Towel Bar
ARCH	Architect(ural)	FOC	Face of Concrete	NTS	Not to Scale	TEL	Telephone
AUTO	Automatic	FOF	Face of Finish	OA	Overall	TEMP	Temporary/ Temperature
BD	Board	FOM	Face of Masonry	OC	On Center	T&G	Tongue and Groove
BLDG	Building	FOS	Face of Studs	OD	Outside Diameter	THK	Thick(ness)
BLK	Block(ing)	FPL	Fireplace	OH	Overhead (Overhang)	THRES	Threshold
BOC	Bottom of Curb	FR	Frame	OPNG	Opening	TJ	Triple Joist
BRG	Bearing	FTG	Footing	PED	Pedestal	TMPD	Tempered
BRG PL	Bearing Plate	FJR	Furring/ Furred	PL	Plaste	TOC	Top of Curb/ Concrete
RSMT	Basement	GA	Gauge	PL	Property Line	TOL	Tolerance
BUR	Built up Roof	GALV	Galvanized	PLAM	Plastic Laminate	TOS	Top of Slab
C.A.	Curved Archway	GD	Grade/ Grading	PLAS	Plastic	TOST	Top of Steel
CAB	Cabinet	GL	Glass/ Glazing	PLAS	Plaster	TOW	Top of Wall
CB	Catch Basin	G.T.	Girder Truss	PL GL	Plate Glass	TPD	Toilet Paper Dispenser
CER	Ceramic	GYP	Gypsum	PLYWD	PLYWOOD	TV	Television
CIR	Circle	HC	Hollow Core	PNL	Panel	TYP	Typical
CJ	Control Joint	HC	Hollow Core	P.T.	Pressure Treated Lumber	UNFIN	Unfinish(ed)
CLG	Ceiling	HDBD	Hard Board	PT	Paint(ed)	UNO	Unless Noted Otherwise
CLG HT	Ceiling Height	HDR	Header	PT	Point	UR	Urinal
CLO	Closet	HM	Hollow Metal	PT	Porcelain Tile	VB	Vinyl Base
CM	Centimeter	HORIZ	Horizontal	PTN	Partition	VCT	Vinyl Composition Tile
CMU	Concrete Masonry Unit	HP	High Point	PR	Pair	VER	Verify
COL	Column	HT	Height	PRKG	Parking	VERT	Vertical
CONC	Concrete	HTG	Heating	PSI	Pounds per Square Inch	VEST	Vestibule
CONST	Construction	HVAC	Heating/ Ventilation/	PVC	Polyvinyl Chloride	VF	Vinyl Flooring
CONT	Continuous/ Continue	AC	Air Conditioning	PVMT	Pavement	VJ	(Vee) Joint
CORR	Corridor	ID	Inside Diameter	QT	Quarry Tile	VNR	Veneer
CPB	Carpet Base	INCL	Include(d)	R	Radius	VWC	Vinyl Wall Covering
CPT	Carpet	INSUL	Insulate/ Insulation	R	Riser	WB	Wood Base
CSMT	Casement	INT	Interior	RA	Return Air	WD	Wood
CT	Ceramic Tile	INV	Invert	RB	Rubber Base	WDW	Window
CTR	Center	J-Box	Junction Box	RCP	Reinforced Concrete Pipe	WGL	Wired Glass
CU FT	Cubic Foot	JST	Joist	RD	Roof Drain	WH	Water Heater
CU YD	Cubic Yard	JO	Joint	REF	Reference	WM	Wire Mesh
CWT	Ceramic Wall Tile	KT	Kitchen	REFR	Refrigerator	W/O	Without
DBL	Double	L	Length	REINF	Reinforced	WPT	Working Point
DH	Double Hung	LAM	Laminated	REQD	Required	WSC	Wainscot
DIA	Diameter	LB	Lag Bolt	RESIL	Resilient	WTC	Wall Tile
DIAG	Diagonal	LH	Left Hand	RET	Return	WT	Weight
DIM	Dimension	LT	Light	REV	Revision	WWF	Welded Wire Fabric
DISP.	Garbage Disposal	LTL	Lintel	RFG	Roofing		
DJ	Double Joist	LT WT	Light Weight	RM	Room	±	Center Line
DN	Down	LVL	Laminated Veneer Lumber	RO	Rough Opening	C	Channel
DP	Deep	LVR	Louver	ROW	Right of Way	PL	Plate
DS	Downspout	M	Meter	RVS	Reverse	±	Plus or Minus
DTL	Detail	MAS	Masonry	SCHED	Schedule	±	Property Line
DWG	Drawing	MATL	Material	SECT	Section		
DWR	Drawer	MAX	Maximum	SECT	Section		
EA	Each	MC	Medicine Cabinet	SF	Square Foot		
EJ	Expansion Joint	MECH	Mechanical	SHT	Sheet		
ELEC	Electric	MED	Medium	SHT GL	Sheet Glass		
ELEV	Elevation	MEMB	Membrane	SHTWR	Shower		
EMER	Emergency	MFR	Manufacture(er)(ing)	SIM	Similar		
EPB	Electric Panel Board	MH	Man Hole	SPEC	Specification		

## PLAN SET COMPOSITION

PAGE #	LAYOUT
T1.0-T1.1	TITLE SHEET AND REVISION LOG
GN1.0-GN1.1	GENERAL NOTES
0.10-0.15	ELEVATIONS
0.20-0.21	BASEMENT FLOOR PLANS
1.0-1.4	1ST FLOOR PLANS
2.0-2.2	2ND FLOOR PLANS
3.0-3.1	3RD FLOOR PLANS
4.0-4.1	SECTIONS / DETAILS
5.0-8.0	ELECTRICAL / HVAC PLANS

## ELEVATION

# FARMHOUSE

## CODE

2018  
 NORTH CAROLINA STATE BUILDING CODE:  
 RESIDENTIAL CODE

## SEQUOIA SQUARE FOOTAGES

AREA	COLONIAL	CRAFTSMAN	FRENCH COUNTRY	TUDOR	FARM HOUSE
1st FLOOR	1306 SQ. FT.	1306 SQ. FT.	1306 SQ. FT.	1306 SQ. FT.	1306 SQ. FT.
2nd FLOOR	1524 SQ. FT.	1505 SQ. FT.	1524 SQ. FT.	1522 SQ. FT.	1522 SQ. FT.
TOTAL LIVING	<b>2830 SQ. FT.</b>	<b>2811 SQ. FT.</b>	<b>2830 SQ. FT.</b>	<b>2828 SQ. FT.</b>	<b>2828 SQ. FT.</b>
OPT. UPGRADE SIDE ELEVATION	N/A	+6 SQ. FT.	+6 SQ. FT.	N/A	N/A
GARAGE - 2 CAR	475 SQ. FT.	475 SQ. FT.	475 SQ. FT.	475 SQ. FT.	475 SQ. FT.
FRONT PORCH COVERED	56 SQ. FT.	34 SQ. FT.	49 SQ. FT.	36 SQ. FT.	42 SQ. FT.

## GLOBAL OPTIONAL SQUARE FOOTAGES

OPT. COVERED VERANDA	120 SQ. FT.
OPT. SCREENED PORCH	120 SQ. FT.
OPT. SUNROOM	120 SQ. FT.

**JDS Consulting**  
 DESIGN • ENGINEERING • SURVEYING • ENERGY

JDS Consulting P.L.L.C., 8600 DP JERSEY, CT, RALEIGH, NC 27617 919.480.1075  
 INFO@JDSCONSULTING.NET WWW.JDSCONSULTING.NET

JDS Consulting, P.L.L.C. IS NOT LIABLE FOR CHANGES MADE TO PLANS DUE TO CONSTRUCTION METHODS OR ANY CHANGES TO PLANS MADE IN THE FIELD BY CONTRACTOR OR BY OTHERS. DRAWINGS ARE PROVIDED TO CLIENT FOR THEIR USE ONLY. ALL DIMENSIONS SHALL GOVERN OVER SCALE, AND CODE SHALL GOVERN OVER DIMENSIONS ON DRAWINGS.

CLIENT: **MATTAMY HOMES**

PROJECT: **SEQUOIA - RH**

LOCATION: **NORTH CAROLINA**

SCALE: 1/8" = 1'-0" FOR 11x17 PAPER, 1/4" = 1'-0" FOR 22x34 PAPER, OR AS NOTED.

PROJECT NO. **21901607**

DATE: **11/08/2021** DRAWN BY: **CAR**

TITLE SHEET

# T1.0



**1. ROOF CONSTRUCTION**  
 ROOF SHINGLES OVER #15 FELT PAPER (DOUBLE LAYER UNDERLAYMENT FOR ROOFS WITH A PITCH OF LESS THAN 4:12), 1/4" OSB SHEATHING WITH "X" CLIPS ON APPROVED ROOF TRUSSES. (SEE ROOF TRUSS DESIGNS), FROFIN ALUM. EAVESTROUGH, FASCIA, & VENTED SOFFIT U.N.O. (REFER TO SHEET GN.1 FOR N.C. ENERGY REQUIREMENTS.)

**ROOF VENTILATION**  
 OPTION 1: MIN. VENTILATION AREA OF 1:300 OF TOTAL ATTIC AREA WITH MIN. 50% & MAX. 80% OF REQUIRED CROSS VENTILATION PROVIDED VENTILATORS LOCATED IN THE UPPER PORTION OF THE SPACE ARE MIN. 36" ABOVE EAVE OR CORNICE VENTS WITH THE BALANCE OF THE REQUIRED VENTILATION PROVIDED BY EAVE OR CORNICE VENTS  
 OPTION 2: MIN. VENTILATION AREA OF 1:300 OF TOTAL ATTIC AREA WITH REDUCTION IN CROSS VENTILATION WITH USE OF VAPOR BARRIER LOCATED BETWEEN INSULATION & DRYWALL.

**2. FRAME WALL CONSTRUCTION (2"x4") - SIDING**  
 SIDING AS PER ELEVATION, APPROVED HOUSE WRAP, 7/16" OSB EXTERIOR SHEATHING, 2"x4" STUDS @ 16" O.C. TO 10' MAX HEIGHT. R13 BATT INSULATION, 1/2" INT. DRYWALL FINISH.  
 (REFER TO SHEET GN.1 FOR N.C. ENERGY REQUIREMENTS.)

**3. FRAME WALL CONSTRUCTION (2"x4") - STONE**  
 SYNTHETIC STONE, SCRATCH COAT PER MANUFACTURERS SPECS. OVER GALV. MTL LATH & APPROVED WEATHER RESISTANT BARRIER, 7/16" OSB EXTERIOR SHEATHING, 2"x4" STUDS @ 16" O.C. TO 10' MAX. HEIGHT. 1/2" INT. DRYWALL FINISH.  
 (REFER TO SHEET GN.1 FOR N.C. ENERGY REQUIREMENTS.)

**4. DRAINAGE**  
 SITE SHALL GRADE TO PROVIDE DRAINAGE UNDER ALL PORTIONS OF STRUCTURE & TO DRAIN SURFACE WATER AWAY FROM THE STRUCTURE. GRADE SHALL FALL 6" WITHIN FIRST 10'. ALL PLUMBING WORK SHALL COMPLY WITH THE CURRENT RESIDENTIAL & PLUMBING CODES.

**5. GROUND FLOOR SLAB ON GRADE**  
 CONCRETE SLAB PER STRUCTURAL DRAWINGS OVER CLEAN TERMITE TREATED COMPACT FILL. CHEMICAL PRE-TREATMENT OF SOL IS REQUIRED BEFORE CASTING OF SLAB. SAW CUT EVERY 1200' 8".

**6. EXPOSED FLOOR TO EXTERIOR**  
 PROVIDE MIN. R19 BATT INSULATION IN FLOORS BETWEEN CONDITIONED & UNCONDITIONED SPACES, APPROVED HOUSE WRAP, FINISHED SOFFIT.

**7. ATTIC INSULATION:** REFER TO SHEET GN.1. FOR N.C. REQUIREMENT. 1/2" INT. DRYWALL CEILING FINISH OR APPROVED EQUAL.

**8. INTERIOR STAIRS: SITE BUILT**  
 1. STRINGERS SHALL BE 2"x12" 5YP.#2 (PRESSURE TREATED AT BASE) EQUALLY SPACED & ANCHORED TO 2"x8" HEADER & FT. 2"x4" PLATE  
 2. TREADS SHALL BE 2"x12" 5YP.#2 RIPPED DOWN AS REQUIRED. (GLUED & NAILED)  
 3. RISERS SHALL BE 1"x8" 5YP.#2 RIPPED DOWN AS REQUIRED. (GLUED & NAILED)  
 4. MIN. TREAD = 9"  
 MAX. NOSING = 1-1/4"  
 MIN. TREAD & NOSING = 9-3/4"  
 MAX. RISER = 8-1/4"  
 MIN. HEADROOM = 6'-8"  
 MAX. VERTICAL RISE FOR SLOPE OF STAIRS = 12'-0"  
 MIN. STAIR WIDTH = 3'-0"  
 MIN. CLEAR STAIR WIDTH = 31.5"

**FOR WINDER STAIRS**  
 MIN. WINDER TREAD MEASURED 12" FROM INSIDE EDGE = 9"  
 MIN. WINDER TREAD MEASURED AT ANY POINT = 4"  
 MAX. WINDER DEPTH = 12"

**9. HAND RAIL**  
 MIN. STAIR / RAMP HANDRAIL HEIGHT = 34"  
 MAX. STAIR / RAMP HANDRAIL HEIGHT = 38"  
 MIN. INTERIOR GUARD HEIGHT = 36"  
 MIN. EXTERIOR GUARD HEIGHT = 36"

FINISHED RAILING AND GUARD RAIL PICKETS SHALL BE SPACED 4" O.C. MAXIMUM BETWEEN PICKETS. GUARDS AND RAILINGS SHALL NOT HAVE OPENINGS FROM THE WALKING SURFACE TO THE REQUIRED GUARD HEIGHT WHICH ALLOW THE PASSAGE OF A SPHERE 4" IN DIAMETER.

**10. WALLS BACKING ONTO ATTIC**  
 WALLS WHICH SEPARATE CONDITIONED LIVING SPACE FROM UNCONDITIONED ATTIC SPACE SHALL BE INSULATED AND SEALED WITH AN AIR BARRIER SYSTEM TO LIMIT INFILTRATION. I.E. VAULTED CEILING, SKYLIGHT, RAISED CORNERED CEILING. (REFER TO SHEET GN.1 FOR N.C. ENERGY REQUIREMENTS.)

**11. BEAM POCKET OR 8"x8" CONCRETE BLOCK NB WALLS.** MINIMUM BEARING 3'-1/2".

**12. WALL & CEILING BETWEEN GARAGE & LIVING SPACE**  
 5/8" TYPE 'X' DRYWALL ON WALLS OF GARAGE W/ LIVING SPACE ABOVE & 1/2" DRYWALL ON CEILING SUPPORTING 5/8" TYPE 'X' GUBB W/ HABITABLE SPACE ABOVE AND BETWEEN HOUSE AND GARAGE. INSULATE WALLS AND CEILING BETWEEN GARAGE AND CONDITIONED SPACE. TAPE, SEAL & STRUCTURALLY SUPPORT ALL JOINTS, IN ORDER TO BE GAS/TIGHT. (REFER TO SHEET GN.1 FOR N.C. ENERGY REQUIREMENTS.)

**13. DOOR AND FRAME GAS/P.N.C.** DOOR EQUIPPED WITH SELF CLOSING DEVICE AND WEATHERSTRIPPING.

**14. CLOTHES DRYER VENT**  
 DRYER EXHAUST VENTED TO EXTERIOR & EQUIPPED W/ BACK DRAFT DAMPER. MAX. 35' DUCT LENGTH FROM THE CONNECTION TO THE TRANSITION DUCT FROM THE DRYER TO THE OUTLET TERMINAL. WHERE FITTINGS ARE USED REFER TO MECHANICAL CODE FOR MAX. LENGTH REDUCTIONS. SEAL WITH NON-COMBUSTIBLE MATERIAL, APPROVED FIRE CALKING OR NON-COMBUSTIBLE DRYER EXHAUST DUCT WALL RECEPTACLE.

**15. ATTIC ACCESS**  
 ATTIC ACCESS HATCH 20"x30" WITH WEATHER-STRIPPING INTO ANY ATTIC EXCEEDING 30" X 30" VERT. HEIGHT. ALLOW 30" HEADROOM IN ATTIC AT HATCH LOCATION. R-10 MIN INSULATION OR  
 PULL DOWN STAIR (PDS) (9/12 PER PLAN) WITH WEATHER-STRIPPING & INSULATED WITH (R5) RIGID INSULATION. (NON-RIGID INSULATION MATERIALS ARE NOT ALLOWED)

**PREPLACE CHIMNEYS**  
 TOP OF FIREPLACE CHIMNEY SHALL BE MIN. 3'-0" ABOVE THE HIGHEST POINT AT WHICH IT COMES IN CONTACT WITH THE ROOF AND 2'-0" FROM THE ROOF SURFACE WITHIN A HORIZ. DISTANCE OF 10'-0" FROM THE CHIMNEY.

**17. LINEN CLOSET OR PANTRY W/ MIN. 12" DEEP SHELVES.** PROVIDE MAX. OF 4 SHELVES.

**MECHANICAL VENTILATION**  
 MECHANICAL EXHAUST FAN, VENTED DIRECTLY TO EXTERIOR, TO PROVIDE 50CFM INTERMITTENT OR 20CFM CONTINUOUS IN BATHROOMS & TOILET ROOMS. PROVIDE DUCT SCREEN. SEE HVAC DESIGNS.

**19. CABINET BLOCKING**  
 36" A.F.F. FOR BASE CABINETS  
 54" A.F.F. FOR BOTTOM OF UPPER CABINETS  
 84" A.F.F. FOR TOP OF A 30" UPPER CABINET  
 96" A.F.F. FOR TOP OF OPTIONAL 42" UPPIERS

**20. STUD WALL REIN. FOR HANDICAP BATHROOM**  
 WHERE HANDICAPPED ACCESSIBILITY IS REQUIRED, PROVIDE WOOD BLOCKING REINFORCEMENT TO STUD WALLS FOR GRAB BAR INSTALLATION IN BATHROOM. 33"-36" A.F.F. BEHIND TOILET. 33" A.F.F. ON THE WALL OPPOSITE THE THE ENTRANCE TO THE BATHTUB OR SHOWER.

**21. RANGE HOOD VENT**  
 RANGE HOOD VENTED TO EXTERIOR & EQUIPPED W/ BACK DRAFT DAMPER. MICRODRAVES LOCATED ABOVE A COOKING APPLIANCE SHALL CONFORM TO UL913.

**22. SLAB ON GRADE PORCH**  
 CONCRETE SLAB PER STRUCTURAL DRAWINGS OVER CLEAN TERMITE TREATED COMPACT FILL. SUBTERRANEAN TERMITE POST-TREATMENT MAY BE BORACARE APPLIED TO GROUND FLOOR WOOD SURFACES: ILO SOIL TREATMENT.

**23. DIRECT VENT FURNACE TERMINAL.** SEE APPENDIX-C "EXIT TERMINALS OF MECHANICAL DRAFT AND DIRECT VENT VENTING SYSTEM" FOR MINIMUM CLEARANCES TO WINDOW & DOOR OPENINGS, GRADE, EXHAUST & INTAKE VENTS. REFER TO GAS UTILIZATION CODE.

**24. DIRECT VENT GAS FIREPLACE.** SEE APPENDIX-C "EXIT TERMINALS OF MECHANICAL DRAFT AND DIRECT VENT VENTING SYSTEM" FOR MINIMUM CLEARANCES TO WINDOW & DOOR OPENINGS, GRADE, EXHAUST & INTAKE VENTS. REFER TO GAS UTILIZATION CODE.

**25. SUBFLOOR & FLOOR TRUSSES**  
 3/4" T & G SUBFLOOR ON PRE-ENGINEERED FLOOR TRUSSES BY REGISTERED TRUSS MANUFACTURER. (SEE STRUCT. ENGINEER'S NAILING SCHEDULE)  
 PROVIDE DRAFT STOPPING EVERY 1000 SF. BRACING IN ACCORDANCE W/ TPI/UTCA BC91 (1/4") PANEL TYPE UNDERLAY UNDER RESILIENT & PARQUET FLOORING.

**26. EXPOSED BUILDING FACE**  
 WALLS LESS THAN 5'-0" FROM PROPERTY LINE SHALL HAVE A FIRE RATING OF NO LESS THAN 1 HOUR IN ACCORDANCE WITH ASTM E 119 OR UL 263 WITH EXPOSURE FROM BOTH SIDES. PROJECTIONS BETWEEN 2'-0" & 5'-0" FROM PROPERTY LINE MUST HAVE A RATING ON THE UNDERSIDE OF NO LESS THAN 1 HOUR IN ACCORDANCE WITH ASTM E 119 OR UL 263. PROJECTIONS LESS THAN 5'-0" FROM PROPERTY LINE CANNOT HAVE A VENTILATED SOFFIT. OPENINGS IN A WALL LESS THAN 3'-0" FROM PROPERTY LINE ARE NOT ALLOWED. OPENINGS IN A WALL BETWEEN 3'-0" & 5'-0" FROM THE PROPERTY LINE CANNOT EXCEED 25% OF THE MAXIMUM WALL AREA. PENETRATIONS LESS THAN 5'-0" FROM THE PROPERTY LINE MUST COMPLY WITH CURRENT NC CODE. WHERE BUILDING FACE IS WITHIN 10'-0" OF PROPERTY LINE, ADD 5/8" GYPSUM BOARD UNDERLAYMENT @ SOFFIT.

**27. STEMWALL FOUNDATION & FOOTING**  
 WHERE GROUND FLOOR SLAB EXTENDS TOO FAR ABOVE FIN. GRADE FOR A MONOLITHIC SLAB, CONSTRUCT STEMWALL DETAIL PER STRUCTURAL ENGINEER'S SPECIFICATIONS.

**28. TWO STORY VOLUME SPACERS**  
 BALLOON FRAMING PER STRUCTURAL ENGINEER - REFER TO FLOOR PLANS.

**29. TYP. 1 HOUR RATED PARTWALL.** REFER TO DETAILS FOR TYPE AND SPECS.

**WOOD FRAME & CONCRETE BLOCK CONSTRUCTION NOTES:**

- TERMITE & DECAY PROTECTION  
**CHEMICAL SOL TREATMENT**  
 THE CONCENTRATION RATE OF APPLICATION AND TREATMENT METHOD OF THE TERMITICIDE SHALL BE CONSISTENT WITH AND NEVER LESS THAN THE TERMITICIDE LABEL AND SHALL BE APPLIED ACCORDING TO THE STANDARDS OF THE NORTH CAROLINA DEPARTMENT OF AGRICULTURE  
 FIELD CUTS, NOTCHES AND DRILLED HOLES SHALL BE TREATED IN THE FIELD IN ACCORDANCE WITH AUPA M4.  
 ALL WOOD IN DIRECT CONTACT WITH CONCRETE OR MASONRY FOUNDATION WALLS SHALL EITHER BE PRESSURE TREATED WOOD IN ACCORDANCE WITH AUPA UI STANDARDS OR PROTECTED FROM CONTACT BY AN APPROVED IMPERVIOUS MOISTURE BARRIER.  
 2. SEE STRUCTURAL ENGINEER'S DRAWINGS FOR STEEL LINTELS SUPPORTING ANY BRICK VENEER.

**WINDOWS:**

- MIN. EMERGENCY ESCAPE WINDOW OPENING SIZES  
 MIN. OF ONE EMERGENCY ESCAPE WINDOW REQ. IN EVERY SLEEPING ROOM  
 MIN. AREA FOR GROUND FLOOR EMERGENCY ESCAPE OPENING = 5.0 SQ.FT.  
 MIN. AREA FOR SECOND FLOOR EMERGENCY ESCAPE OPENING = 5.1 SQ.FT.  
 MIN. HEIGHT DIMENSION FOR EMERGENCY ESCAPE OPENING = 22"  
 MIN. WIDTH DIMENSION FOR EMERGENCY ESCAPE OPENING = 20"  
 MAX. SILL HEIGHT FOR EMERGENCY ESCAPE OPENING = 44" ABOVE FLOOR
- MINIMUM WINDOW SILL HEIGHT  
 IN DWELLING UNITS WHERE THE OPENING OF AN OPERABLE WINDOW IS MORE THAN 12" ABOVE FINISHED GRADE, OR SURFACE BELOW, THE LOWEST PART OF THE CLEAR OPENING SHALL BE A MINIMUM OF 24" ABOVE THE FINISHED FLOOR. ANY WINDOW 24" OR LESS FROM FINISHED FLOOR SHALL BE EQUIPPED WITH AN OPENING LIMITING DEVICE.

3. FIXED GLASS REQUIREMENTS: FIXED GLASS IS REQ. FOR WINDOWS LESS THAN 24" ABOVE FINISHED FLOOR.

4. FLASHING, SEALANTS AND WEATHERSTRIPPING INSTALL APPROVED CORROSION-RESISTANT FLASHING AT ALL EXTERIOR DOORS & WINDOWS TO EXTEND TO THE SURFACE OF THE EXTERIOR WALL FINISH OR WATER RESISTIVE BARRIER. WINDOWS SHALL BE SEALED WITH MINIMUM QUALITY OF CALKING TO BE ASTM SPEC 320 OR 1281 WITH TESTING & PERFORMANCE CLASS 25 OR AAMA CLASS 8000 OR B2. RECOMMEND SIKKA 201.

5. MAXIMUM TOLERANCE FOR MASONRY ROUGH OPENING SIZE MASONRY ROUGH OPENING DIMENSIONS SHALL PROVIDE FOR A WINDOW PERIMETER SEALANT JOINT A MAXIMUM OF 1/4" IN WIDTH.

6. MINIMUM ENERGY CODE REQUIREMENTS FOR WINDOWS. INSTALLED WINDOWS SHALL HAVE PROPERTIES AS EFFICIENT AS WINDOWS USED TO CALCULATE FORM 1100A. WINDOW PERFORMANCE CRITERIA ARE CONTAINED IN THE ENERGY GAUGE USA/FLA/RES COMPUTER PROGRAM. REFER TO SHEET GN.1 FOR MINIMUM N.C. SOLAR HEAT GAIN COEFFICIENT (SHGC). WINDOWS WITH CERTIFIED PERFORMANCE SHALL HAVE THE NFRC LABEL PROVIDING U-VALUE & SHGC TO REMAIN ON THE WINDOW UNTIL FINAL ENERGY INSPECTION.

7. ANY GLASS OR WINDOW MUST BE TEMPERED THAT IS:  
 LESS THAN 18" ABOVE FINISH FLOOR.  
 WITHIN 60" OF A TUB OR SHOWER.  
 WHERE NEAREST VERTICAL EDGE IS WITHIN 24" OF A DOOR AND BOTTOM WINDOW EDGE IS LESS THAN 60" ABOVE FLOOR.  
 OVER 9 SF. OF GLASS AREA.  
 LESS THAN 60" FROM STAIR TREAD OR LANDING.

**GENERAL**

- THE FOLLOWING, WHERE PRESENT, SHALL BE CALKED, GASKETED, WEATHER-STRIPPED OR OTHERWISE SEALED WITH AN AIR BARRIER MATERIAL:
  - BLOCKING AND SEALING FLOOR / CEILING SYSTEMS AND UNDER KNEE WALLS OPEN TO UNCONDITIONED OR EXTERIOR SPACE.
  - CAPPING AND SEALING SHAFTS OR CHASES INCLUDING FLUE SHAFTS
  - CAPPING AND SEALING SOFFIT OR DROPPED CEILING AREAS
  - TOP AND BOTTOM PLATES
- PENETRATIONS WILL BE SEALED WITH A PRODUCT THAT MEETS ASTM E119. FIBERGLASS INSULATION IS NOT PERMITTED TO SEAL ANY PENETRATIONS.
- GUARDS SHALL BE LOCATED ALONG OPEN-SIDED WALKING SURFACES, INCLUDING FLOORED ATTIC AREAS.



**MATTAMY HOMES**  
**CHARLOTTE DIVISION**  
**PH: 704-375-9373**

**MATTAMY HOMES**  
**RALEIGH DIVISION**  
**PH: 919-752-4898**



JDS Consulting P.L.L.C. 8600 D JERSEY CT. RALEIGH, NC 27617-9194 800.1075  
 INFO@JDSCONSULTING.NET WWW.JDSCONSULTING.NET

JDS Consulting, P.L.L.C. IS NOT LIABLE FOR CHANGES MADE TO THE PLAN OR FIELD CONSTRUCTION METHODS OR ANY CHANGES TO PLANS MADE IN THE FIELD BY CONTRACTOR OR BY OTHERS. DRAWINGS ARE PROVIDED TO CLIENT FOR ALL INFORMATION AND CONSTRUCTION PURPOSES ONLY. ALL DIMENSIONS SHALL GOVERN OVER SCALE, AND COPY SHALL GOVERN OVER DIMENSIONS ON DRAWINGS.



**MATTAMY HOMES**  
**SEQUOIA - RH**  
**NORTH CAROLINA**

CLIENT: MATTAMY HOMES  
 PROJECT: SEQUOIA - RH  
 LOCATION: NORTH CAROLINA

SCALE: 1/8" = 1'-0" FOR 11x17 PAPER, 1/4" = 1'-0" FOR 24x36 PAPER, OR AS NOTED.

PROJECT NO. 21901607

DATE: 11/08/2021 DRAWN BY: CAR

**GENERAL NOTES**

**GN1.0**

**North Carolina**  
**INSULATION AND FENESTRATION REQUIREMENTS BY COMPONENT**  
(note a)

CLIMATE ZONE	FENESTRATION U-FACTOR (notes b, j)	SKYLIGHT U-FACTOR (note b)	GLAZED FENESTRATION SHGC (notes b, k)	CEILING R-VALUE (note m)	WOOD FRAME WALL R-VALUE	MASS WALL R-VALUE (note l)	FLOOR R-VALUE	BASEMENT WALL R-VALUE (notes c, o)	SLAB R-VALUE AND DEPTH (note d)	CRAWL SPACE WALL R-VALUE (note c)
<b>3</b>	0.35	0.55	0.30	38 or 30ci	15 or 13 + 2.5 (note h)	5/13 or 5/10ci	19	5/13 (note f)	0	5/13
<b>4</b>	0.35	0.55	0.30	38 or 30ci	15 or 13 + 2.5 (note h)	5/13 or 5/10ci	19	10/15	10	10/15
<b>5</b>	0.35	0.55	NR	38 or 30ci	19 (note n) or 13 + 5 or 15 + 3 (note h)	13/17 or 13/12.5ci	30 (note g)	10/15	10	10/19

- a. R-VALUES ARE MINIMUMS. U-FACTORS AND SHGC ARE MAXIMUMS.
- b. THE FENESTRATION U-FACTOR COLUMN EXCLUDES SKYLIGHTS. THE SHGC COLUMN APPLIES TO ALL GLAZED FENESTRATION.
- c. "10/15" MEANS R-10 CONTINUOUS INSULATED SHEATHING ON THE INTERIOR OR EXTERIOR OF THE HOME OR R-15 CAVITY INSULATION AT THE INTERIOR OF THE BASEMENT WALL OR CRAWL SPACE WALL.
- d. R-5 SHALL BE ADDED TO THE REQUIRED SLAB EDGE R-VALUES FOR HEATED SLABS. FOR MONOLITHIC SLABS, INSULATION SHALL BE APPLIED FROM THE INSPECTION GAP DOWNWARD TO THE BOTTOM OF THE FOOTING OR A MAXIMUM OF 24 INCHES BELOW GRADE, WHICHEVER IS LESS. FOR FLOATING SLABS, INSULATION SHALL EXTEND TO THE BOTTOM OF THE FOUNDATION WALL OR 24", WHICHEVER IS LESS.
- e. NOT USED.
- f. BASEMENT WALL INSULATION IS NOT REQUIRED IN WARM-HUMID LOCATIONS AS DEFINED BY FIGURE N1101.7 AND TABLE N1101.7.
- g. OR INSULATION SUFFICIENT TO FILL THE FRAMING CAVITY, R-19 MINIMUM.
- h. THE FIRST VALUE IS CAVITY INSULATION, THE SECOND VALUE IS CONTINUOUS INSULATION, SO "13 + 5" MEANS R-13 CAVITY INSULATION PLUS R-5 CONTINUOUS INSULATION. IF STRUCTURAL SHEATHING COVERS 25 PERCENT OR LESS OF THE EXTERIOR, INSULATING SHEATHING IS NOT REQUIRED WHERE STRUCTURAL SHEATHING IS USED. IF STRUCTURAL SHEATHING COVERS MORE THAN 25 PERCENT OF EXTERIOR, STRUCTURAL SHEATHING SHALL BE SUPPLEMENTED WITH INSULATED SHEATHING OF AT LEAST R-2.
- i. THE SECOND R-VALUE APPLIES WHEN MORE THAN HALF THE INSULATION IS ON THE INTERIOR OF THE MASS WALL.
- j. IN ADDITION TO THE EXEMPTION IN SECTION N1102.3.3, A MAXIMUM OF TWO GLAZED FENESTRATION PRODUCT ASSEMBLIES HAVING A U-FACTOR NO GREATER THAN 0.55 SHALL BE PERMITTED TO BE SUBSTITUTED FOR MINIMUM CODE COMPLIANT FENESTRATION PRODUCT ASSEMBLIES WITHOUT PENALTY.
- k. IN ADDITION TO THE EXEMPTION IN SECTION N1102.3.3, A MAXIMUM OF TWO GLAZED FENESTRATION PRODUCT ASSEMBLIES HAVING A SHGC NO GREATER THAN 0.70 SHALL BE PERMITTED TO BE SUBSTITUTED FOR MINIMUM CODE COMPLIANT FENESTRATION PRODUCT ASSEMBLIES WITHOUT PENALTY.
- l. R-30 SHALL BE DEEMED TO SATISFY THE CEILING INSULATION REQUIREMENT WHEREVER THE FULL HEIGHT OF UNCOMPRESSED R-30 INSULATION EXTENDS OVER THE WALL TOP PLATE AT THE EAVES. OTHERWISE R-38 INSULATION IS REQUIRED WHERE ADEQUATE CLEARANCE EXISTS OR INSULATION MUST EXTEND TO EITHER THE INSULATION Baffle OR WITHIN 1" OF THE ATTIC ROOF DECK.
- m. TABLE VALUE REQUIRED EXCEPT FOR ROOF EDGE WHERE THE SPACE IS LIMITED BY THE PITCH OF THE ROOF, THERE THE INSULATION MUST FILL THE SPACE UP TO THE AIR Baffle.
- n. R-19 FIBERGLASS BATTS COMPRESSED AND INSTALLED IN A NOMINAL 2x6 FRAMING CAVITY IS DEEMED TO COMPLY. FIBERGLASS BATTS RATED R-19 OR HIGHER COMPRESSED AND INSTALLED IN A 2x4 WALL IS NOT DEEMED TO COMPLY.
- o. BASEMENT WALL MEETING THE MINIMUM MASS WALL SPECIFIC HEAT CONTENT REQUIREMENT MAY USE THE MASS WALL R-VALUE AS THE MINIMUM REQUIREMENT.



**MATTAMY HOMES**  
**CHARLOTTE DIVISION**  
**PH: 704-375-9373**

**MATTAMY HOMES**  
**RALEIGH DIVISION**  
**PH: 919-752-4898**



JDS Consulting P.L.L.C. 8600 DP JERSEY CT. RALEIGH, NC 27617-9195-480-075  
INFO@JDSCONSULTING.NET WWW.JDSCONSULTING.NET

JDS Consulting, P.L.L.C. IS NOT LIABLE FOR DAMAGES MADE TO BE MADE IN THE FIELD BY CONTRACTOR OR BY OTHERS. DRAWINGS ARE PROVIDED TO CLIENT FOR THEIR USE ONLY. ALL DIMENSIONS SHALL GOVERN OVER DIMENSIONS ON DRAWINGS.



CLIENT: **MATTAMY HOMES**

PRODUCT: **SEQUOIA - RH**

LOCATION: **NORTH CAROLINA**

SCALE: 1/8" = 1'-0" FOR 11x17 PAPER, 1/4" = 1'-0" FOR 22x34 PAPER, OR AS NOTED.

PROJECT NO.: **21901607**

DATE: **11/08/2021**

DRAWN BY: **CAR**

GENERAL NOTES

**GN1.1**

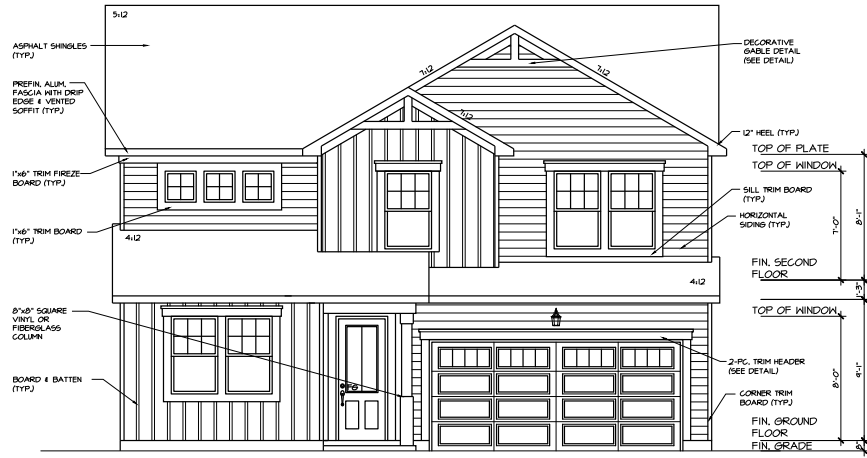

FRONT ELEVATION - FARMHOUSE



REAR ELEVATION - FARMHOUSE

USE CORROSION-RESISTANT FLASHING AT ALL ROOF-TO-WALL INTERSECTIONS

**mattamyHOMES**

MATTAMY HOMES  
**CHARLOTTE DIVISION**  
 PH: 704-375-9373

MATTAMY HOMES  
**RALEIGH DIVISION**  
 PH: 919-752-4898

**JDS Consulting**  
 DESIGN • ENGINEERING • SURVEYING • ENERGY

JDS Consulting P.L.L.C. 8600 DP JERSEY CT. RALEIGH, NC 27617-9198-1075  
 INFO@JDSCONSULTING.NET WWW.JDSCONSULTING.NET

JDS Consulting, P.L.L.C. IS NOT LIABLE FOR CHANGES MADE TO PLANS OR FIELD CONSTRUCTION METHODS OR ANY CHANGES TO PLANS MADE IN THE FIELD BY CONTRACTOR OR BY OTHERS. DRAWINGS ARE PROVIDED TO CLIENT FOR THEIR USE ONLY. CONTRACTOR SHALL GOVERN OVER SCALE AND CODE SHALL GOVERN OVER DIMENSIONS ON DRAWINGS.

Harnett COUNTY  
 LICENSED SET  
 08/12/2020

CLIENT: **MATTAMY HOMES**

PROJECT: **SEQUOIA - RH**

LOCATION: **NORTH CAROLINA**

SCALE: 1/8" = 1'-0" FOR 11x17 PAPER, 1/4" = 1'-0" FOR 22x34 PAPER, OR AS NOTED

PROJECT NO. **21901607**

DATE: **11/08/2021** DRAWN BY: **CAR**

**EXTERIOR ELEVATIONS**

**0.10**

USE CORROSION-RESISTANT FLASHING AT ALL ROOF-TO-WALL INTERSECTIONS

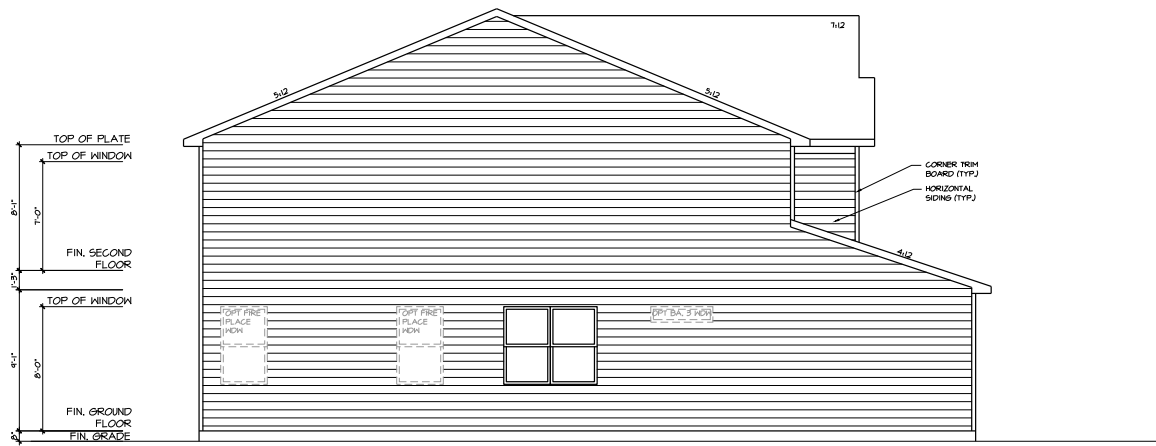

LEFT SIDE ELEVATION - FARMHOUSE

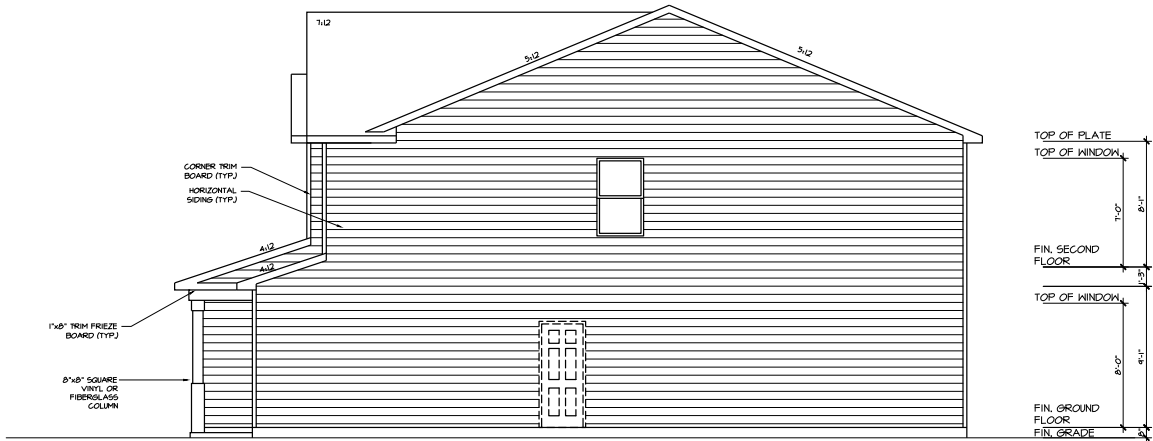

RIGHT ELEVATION - FARMHOUSE



MATTAMY HOMES  
**CHARLOTTE DIVISION**  
 PH: 704-375-9373

MATTAMY HOMES  
**RALEIGH DIVISION**  
 PH: 919-752-4898



JDS Consulting, PLLC, 8600 DP JERSEY, CT, RALEIGH, NC 27617-9198/480.1075  
 INFO@JDSCONSULTING.NET WWW.JDSCONSULTING.NET  
 JDS Consulting, PLLC IS NOT LIABLE FOR CHANGES MADE TO PLANS DUE TO  
 CONSTRUCTION METHODS OR ANY CHANGES TO PLANS MADE IN THE FIELD  
 BY CONTRACTOR OR BY OTHERS. DRAWINGS ARE PROVIDED TO CLIENT FOR  
 INFORMATION ONLY. ALL DIMENSIONS SHALL GOVERN OVER SCALE, AND CODE SHALL  
 GOVERN OVER DIMENSIONS ON DRAWINGS.



CLIENT: **MATTAMY HOMES**  
 PROJECT: **SEQUOIA - RH**  
 LOCATION: **NORTH CAROLINA**

PROJECT NO.: **21901607**  
 DATE: **11/08/2021** DRAWN BY: **CAR**

**EXTERIOR ELEVATIONS**

**0.11**

SCALE: 1/8" = 1'-0" FOR 11x17 PAPER, 1/4" = 1'-0" FOR 22x34 PAPER, OR AS NOTED

USE CORROSION-RESISTANT FLASHING AT ALL ROOF-TO-WALL INTERSECTIONS

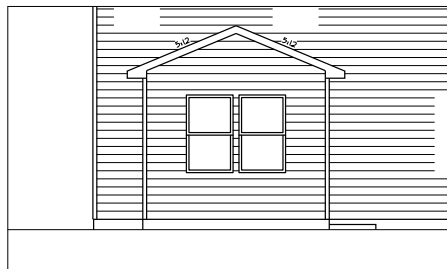

SUNROOM PPO - REAR ELEVATION

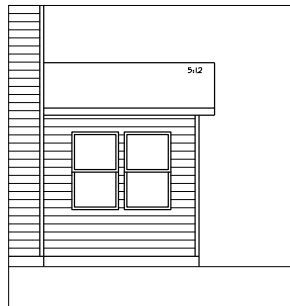

SUNROOM PPO - RIGHT ELEVATION

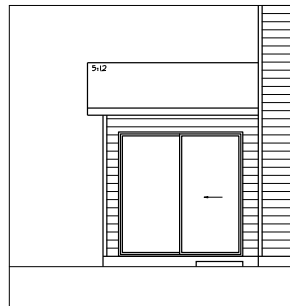

SUNROOM PPO - LEFT ELEVATION

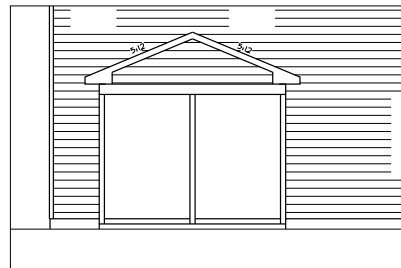

SCREENED PORCH PPO - REAR ELEVATION RALEIGH

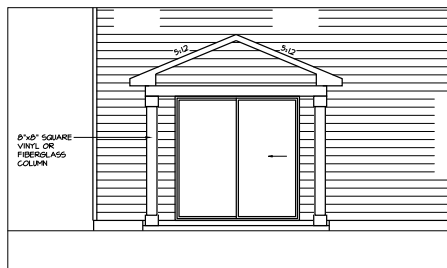

COVERED PORCH PPO - REAR ELEVATION

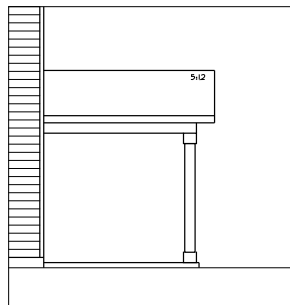

COVERED PORCH PPO - RIGHT ELEVATION

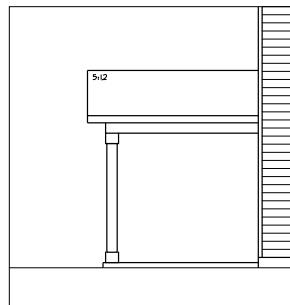

COVERED PORCH PPO - LEFT ELEVATION

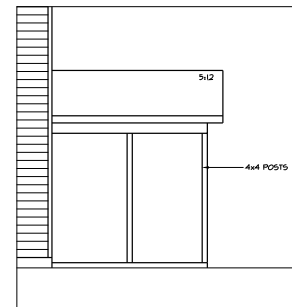

SCREENED PORCH PPO - RIGHT ELEVATION RALEIGH

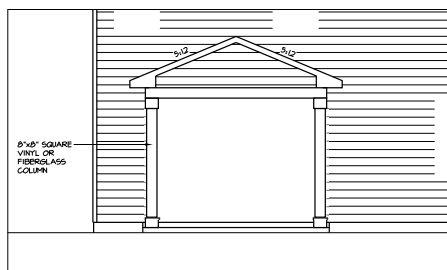

SCREENED PORCH PPO - REAR ELEVATION

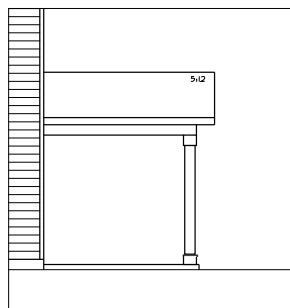

SCREENED PORCH PPO - RIGHT ELEVATION

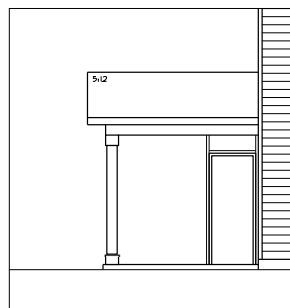

SCREENED PORCH PPO - LEFT ELEVATION

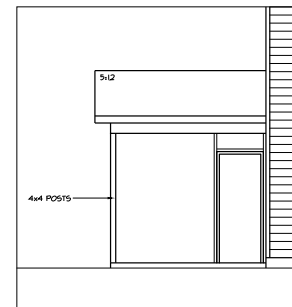

SCREENED PORCH PPO - LEFT ELEVATION RALEIGH



MATTAMY HOMES  
CHARLOTTE DIVISION  
PH: 704-375-9373

MATTAMY HOMES  
RALEIGH DIVISION  
PH: 919-752-4898

**JDS Consulting**  
DESIGN • ENGINEERING • SURVEYING • ENERGY

JDS Consulting PLLC, 8600 DP JERSEY CT, RALEIGH, NC 27617-9198, 480.1075  
INFO@JDSCONSULTING.NET, WWW.JDSCONSULTING.NET

JDS Consulting, PLLC IS NOT LIABLE FOR CHANGES MADE TO PLANS OR FIELD CONSTRUCTION METHODS OR ANY CHANGES TO PLANS MADE IN THE FIELD BY CONTRACTOR OR BY OTHERS. DRAWINGS ARE PROVIDED TO CLIENT FOR THEIR USE ONLY. ALL DIMENSIONS SHALL GOVERN OVER SCALE, AND CODE SHALL GOVERN OVER DIMENSIONS ON DRAWINGS.

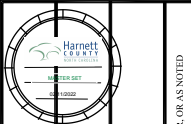

CLIENT: MATTAMY HOMES  
PROJECT: SEQUOIA - RH  
LOCATION: NORTH CAROLINA

PROJECT NO.: 21901607  
DATE: 11/08/2021  
DRAWN BY: CAR

EXTERIOR ELEVATIONS  
**0.12**

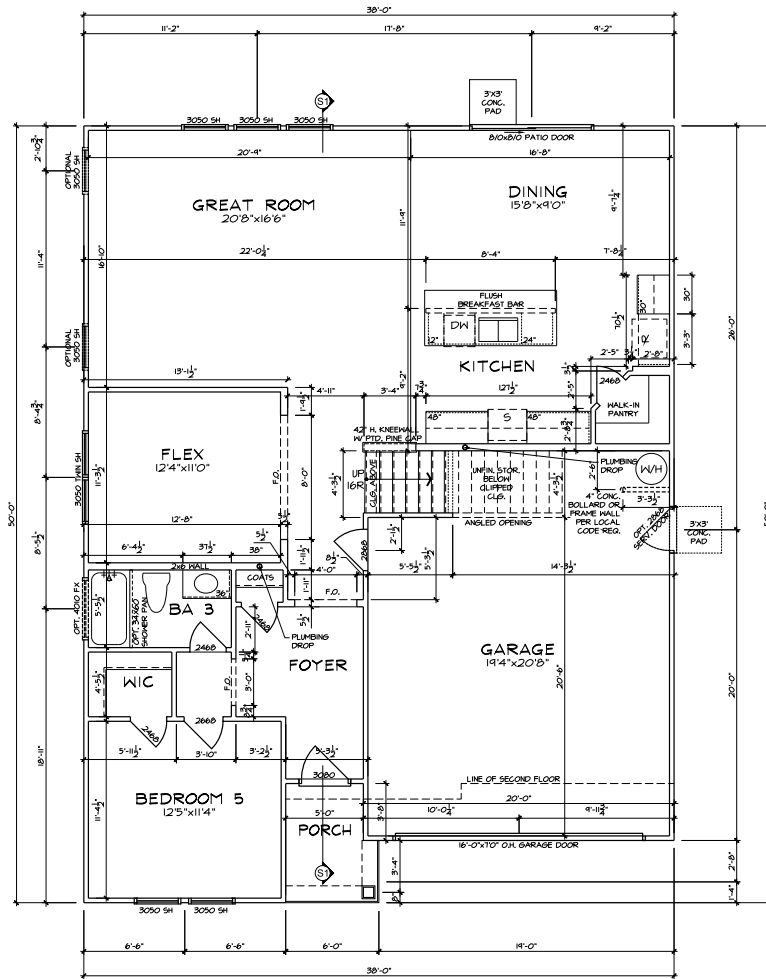

GROUND FLOOR PLAN - FARMHOUSE

**FLOOR PLAN NOTES**

1. ALL FRAMED OPENINGS (F.O.) @ 80" ON 1ST & 96" ON 2ND U.N.O.
2. 4 SHELVES MAX. @ ALL LINEN & PANTRIES.
3. INSTALL HOUSE WRAP AT ALL ATTIC WALLS NEXT TO HEATED SPACES I.L.O. T-PLY.
4. REFER TO GARAGE FRAMING DETAIL ON SHT. DTA3 FOR GOAL POST FRAMING.
5. ALL STUD POCKETS TO BE 4 1/2" (3) STUDS U.N.O.
6. ALL STUDS BEHIND SHOWER STALLS @ 16" O.C.



**MATTAMY HOMES  
CHARLOTTE DIVISION  
PH: 704-375-9373**

**MATTAMY HOMES  
RALEIGH DIVISION  
PH: 919-752-4898**



JDS Consulting PLLC, 8600 DP JERSEY, CT, RALEIGH, NC 27617 919-848-1075  
INFO@JDSCONSULTING.NET WWW.JDSCONSULTING.NET

JDS Consulting, PLLC IS NOT LIABLE FOR CHANGES MADE TO PLANS OR FIELD CONSTRUCTION METHODS OR ANY CHANGES TO PLANS MADE IN THE FIELD BY CONTRACTOR OR BY OTHERS. DRAWINGS ARE PROVIDED TO CLIENT FOR THEIR USE ONLY. ALL DIMENSIONS SHALL GOVERN OVER SCALE AND COORDINATE SHALL GOVERN OVER DIMENSIONS ON DRAWINGS.



CLIENT: **MATTAMY HOMES**

PROJECT: **SEQUOIA - RH**

LOCATION: **NORTH CAROLINA**

SCALE: 1/8" = 1'-0" FOR 11x17 PAPER, 1/4" = 1'-0" FOR 24x36 PAPER, OR AS NOTED

PROJECT NO. **21901607**

DATE: **11/08/2021**

DRAWN BY: **CAR**

**FIRST FLOOR PLAN**

**1.0**



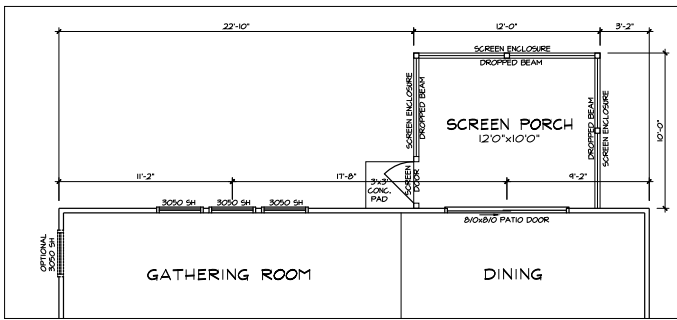

PPO - GROUND FLOOR PLAN  
SCREEN PORCH - RALEIGH

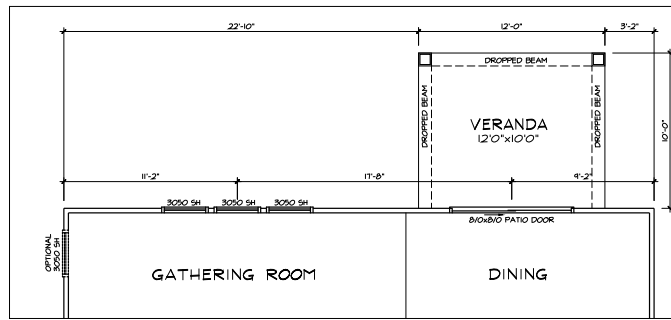

PPO - GROUND FLOOR PLAN  
COVERED VERANDA

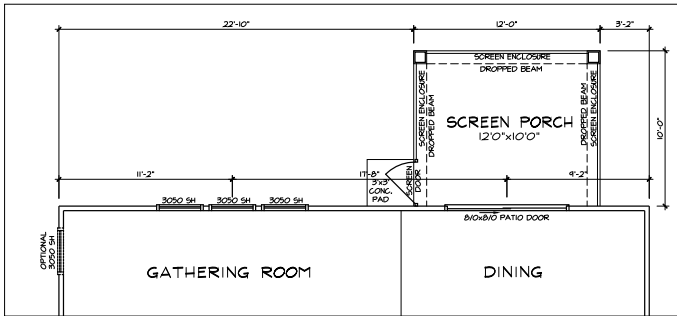

PPO - GROUND FLOOR PLAN  
SCREEN PORCH - CHARLOTTE

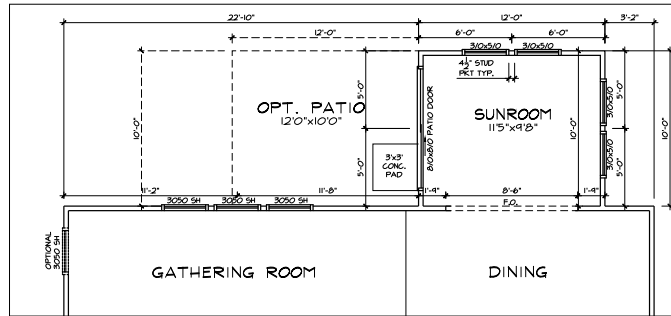

PPO - GROUND FLOOR PLAN  
SUNROOM

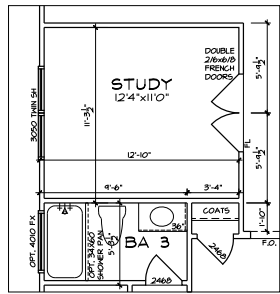

PPO - GROUND FLOOR  
PLAN - CRAFTSMAN  
STUDY

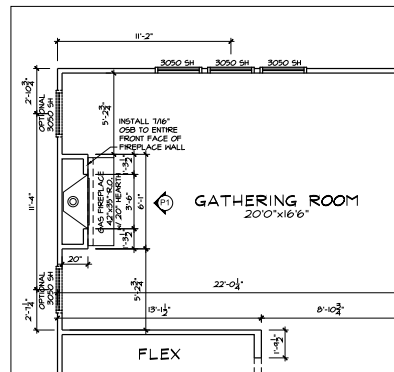

PPO - GROUND FLOOR PLAN  
GAS FIREPLACE

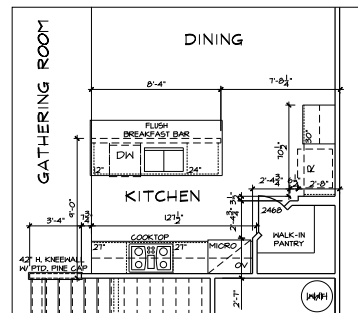

PPO - GROUND  
FLOOR PLAN  
SIGNATURE KITCHEN

- FLOOR PLAN NOTES**
1. ALL FRAMED OPENINGS (F.O.) @ 80" ON 1ST & 96" ON 2ND U.N.O.
  2. 4 SHELVES MAX. @ ALL LINEN & PANTRIES.
  3. INSTALL HOUSE WRAP AT ALL ATTIC WALLS NEXT TO HEATED SPACES I.L.O. T-PLY.
  4. REFER TO GARAGE FRAMING DETAIL ON SHT. DTA3 FOR GOAL POST FRAMING.
  5. ALL STUD POCKETS TO BE 4 1/2" (3) STUDS U.N.O.
  6. ALL STUDS BEHIND SHOWER STALLS @ 16" O.C.



MATTAMY HOMES  
**CHARLOTTE DIVISION**  
PH: 704-375-9373

MATTAMY HOMES  
**RALEIGH DIVISION**  
PH: 919-752-4898



JDS Consulting, PLLC, 8600 DP JERSEY, CT, RALEIGH, NC 27617 919-848-1075  
INFO@JDSCONSULTING.NET, WWW.JDSCONSULTING.NET  
JDS Consulting, PLLC IS NOT LIABLE FOR CHANGES MADE TO PLANS OR FIELD CONSTRUCTION METHODS OR ANY CHANGES TO PLANS MADE IN THE FIELD BY CONTRACTOR OR BY OTHERS. DRAWINGS ARE PROVIDED TO CLIENT FOR THEIR USE ONLY. ALL DIMENSIONS SHALL GOVERN OVER SCALE, AND CODE SHALL GOVERN OVER DIMENSIONS ON DRAWINGS.



CLIENT: **MATTAMY HOMES**  
PROJECT: **SEQUOIA - RH**  
LOCATION: **NORTH CAROLINA**

PROJECT NO. **21901607**

DATE: **11/08/2021** DRAWN BY: **CA**

**FIRST FLOOR OPTIONS  
FLOOR PLANS**

**1.1**

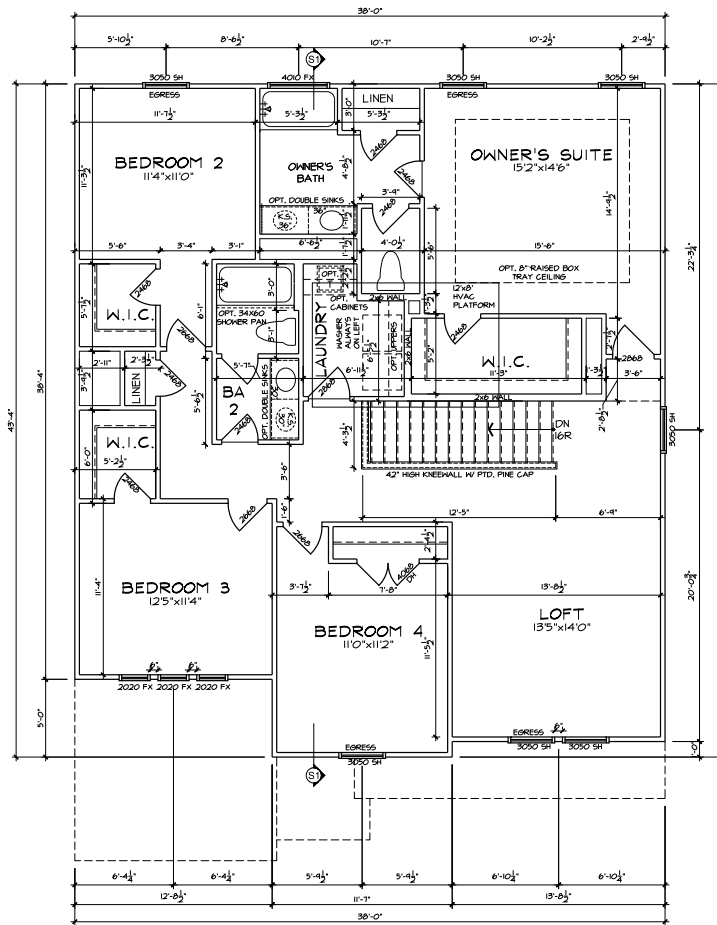

- FLOOR PLAN NOTES**
1. ALL FRAMED OPENINGS (F.O.) @ 80° ON 1ST & 96° ON 2ND U.N.O.
  2. 4 SHELVES MAX. @ ALL LINEN & PANTRIES.
  3. INSTALL HOUSE WRAP AT ALL ATTIC WALLS NEXT TO HEATED SPACES I.L.O. T-PLY.
  4. REFER TO GARAGE FRAMING DETAIL ON SHT. DTA3 FOR GOAL POST FRAMING.
  5. ALL STUD POCKETS TO BE 4 1/2" (3) STUDS U.N.O.
  6. ALL STUDS BEHIND SHOWER STALLS @ 16" O.C.

SECOND FLOOR PLAN - FARMHOUSE

**mattamyHOMES**

MATTAMY HOMES  
**CHARLOTTE DIVISION**  
 PH: 704-375-9373

MATTAMY HOMES  
**RALEIGH DIVISION**  
 PH: 919-752-4898

**JDS Consulting**  
 DESIGN • ENGINEERING • SURVEYING • ENERGY

JDS Consulting, PLLC, 8600 D' JERSEY, CT, RALEIGH, NC 27617-9198/480.1075  
 INFO@JDSCONSULTING.NET, WWW.JDSCONSULTING.NET

JDS Consulting, PLLC IS NOT LIABLE FOR CHANGES MADE TO PLANS OR FIELD CONSTRUCTION METHODS OR ANY CHANGES TO PLANS MADE IN THE FIELD BY CONTRACTOR OR BY OTHERS. DRAWINGS ARE PROVIDED TO CLIENT FOR THEIR USE ONLY. ALL DIMENSIONS SHALL GOVERN OVER SCALE AND COPY SHALL GOVERN OVER DIMENSIONS ON DRAWINGS.

**Harnett COUNTY**  
 PLANNING DEPARTMENT

MATTAMY HOMES  
 PRODUCT: SEQUOIA - RH  
 LOCATION: NORTH CAROLINA

SCALE: 1/8" = 1'-0" FOR 11x17 PAPER, 1/4" = 1'-0" FOR 22x34 PAPER, OR AS NOTED.

CLIENT: MATTAMY HOMES

PROJECT NO. 21901607

DATE: 11/08/2021 DRAWN BY: CAR

SECOND FLOOR PLAN

**2.0**

- FLOOR PLAN NOTES**
1. ALL FRAMED OPENINGS (F.O.) @ 80" ON 1ST & 96" ON 2ND U.N.O.
  2. 4 SHELVES MAX. @ ALL LINEN & PANTRIES.
  3. INSTALL HOUSE WRAP AT ALL ATTIC WALLS NEXT TO HEATED SPACES I.L.O. T-PLY.
  4. REFER TO GARAGE FRAMING DETAIL ON SHT. DTA3 FOR GOAL POST FRAMING.
  5. ALL STUD POCKETS TO BE 4 1/2" (3) STUDS U.N.O.
  6. ALL STUDS BEHIND SHOWER STALLS @ 16" O.C.

**mattamyHOMES**

MATTAMY HOMES  
**CHARLOTTE DIVISION**  
 PH: 704-375-9373

MATTAMY HOMES  
**RALEIGH DIVISION**  
 PH: 919-752-4898

**JDS Consulting**  
 DESIGN • ENGINEERING • SURVEYING • ENERGY

JDS Consulting PLLC, 8600 DP JERSEY CT, RALEIGH, NC 27617 919.480.1075  
 INFO@JDSCONSULTING.NET, WWW.JDSCONSULTING.NET

JDS Consulting, PLLC IS NOT LIABLE FOR CHANGES MADE TO PLANS OR FIELD CONSTRUCTION METHODS OR ANY CHANGES TO PLANS MADE IN THE FIELD BY CONTRACTOR OR BY OTHERS. DRAWINGS ARE PROVIDED TO CLIENT FOR THEIR USE ONLY. ALL DIMENSIONS SHALL GOVERN OVER SCALE, AND CODE SHALL GOVERN OVER DIMENSIONS ON DRAWINGS.

**Harnett COUNTY**  
 HARNETT COUNTY  
 HARNETT COUNTY  
 HARNETT COUNTY

MATTAMY HOMES  
 PROJECT: SEQUOIA - RH  
 LOCATION: NORTH CAROLINA

SCALE: 1/8" = 1'-0" FOR 11x17 PAPER, 1/4" = 1'-0" FOR 24x36 PAPER, OR AS NOTED.

CLIENT: MATTAMY HOMES  
 PROJECT: SEQUOIA - RH  
 LOCATION: NORTH CAROLINA

PROJECT NO. 21901607  
 DATE: 11/08/2021 DRAWN BY: CAR  
 SECOND FLOOR OPTIONS FLOOR PLANS  
**2.1**

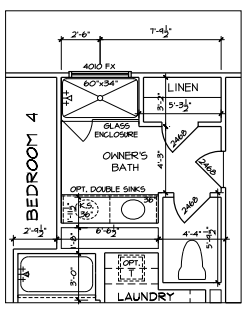
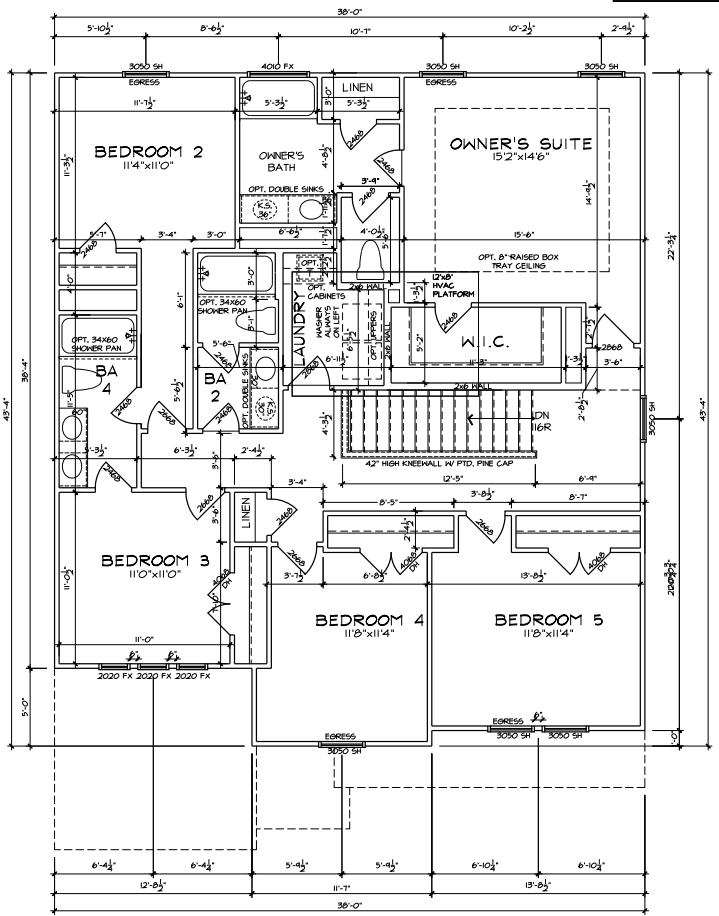

PPO - SECOND FLOOR PLAN  
 STAND-IN SHOWER

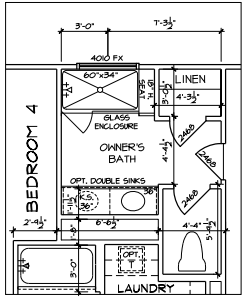

PPO - SECOND FLOOR PLAN  
 STAND-IN SHOWER w/ SEAT

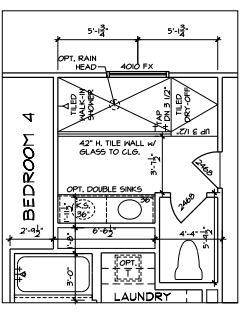

PPO - SECOND FLOOR PLAN  
 BATH OASIS

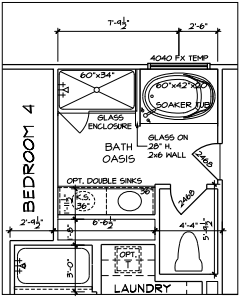

PPO - SECOND FLOOR PLAN  
 BATH OASIS

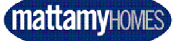
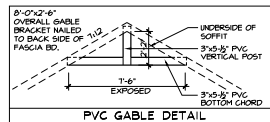
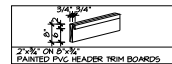
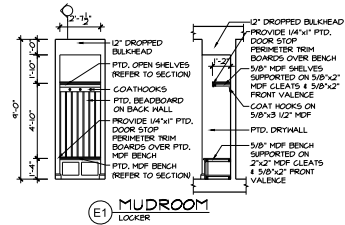
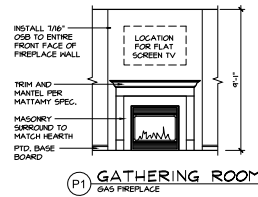
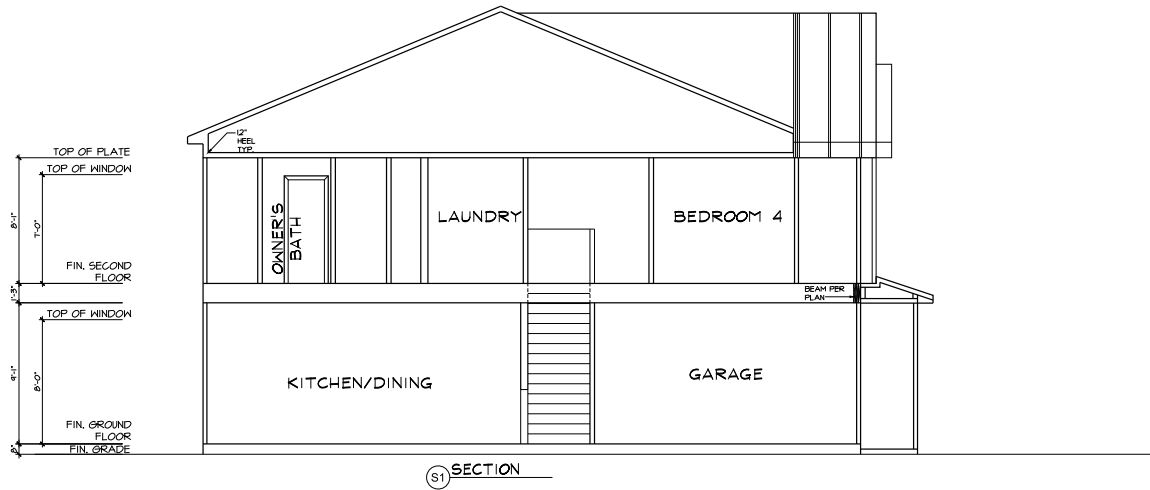

**MATTAMY HOMES  
CHARLOTTE DIVISION  
PH: 704-375-9373**

**MATTAMY HOMES  
RALEIGH DIVISION  
PH: 919-752-4898**



JDS Consulting, PLLC, 8600 DP JERSEY, CT, RALEIGH, NC 27617-9198-480-1075  
 INFO@JDSCONSULTING.NET, WWW.JDSCONSULTING.NET  
 JDS Consulting, PLLC IS NOT LIABLE FOR CHANGES MADE TO PLANS OR FIELD CONSTRUCTION METHODS OR ANY CHANGES TO PLANS MADE IN THE FIELD BY CONTRACTOR OR BY OTHERS. DRAWINGS ARE PROVIDED TO CLIENT FOR THEIR USE ONLY. ALL DIMENSIONS SHALL GOVERN OVER SCALE AND CODE SHALL GOVERN OVER DIMENSIONS ON DRAWINGS.



**CLIENT: MATTAMY HOMES**  
**PROJECT: SEQUOIA - RH**  
**LOCATION: NORTH CAROLINA**

**PROJECT NO. 21901607**  
**DATE: 11/08/2021** **DRAWN BY: CAR**

**SECTIONS & DETAILS**  
**4.0**

SCALE: 1/8" = 1'-0" FOR 11x17 PAPER, 1/4" = 1'-0" FOR 22x34 PAPER, OR AS NOTED

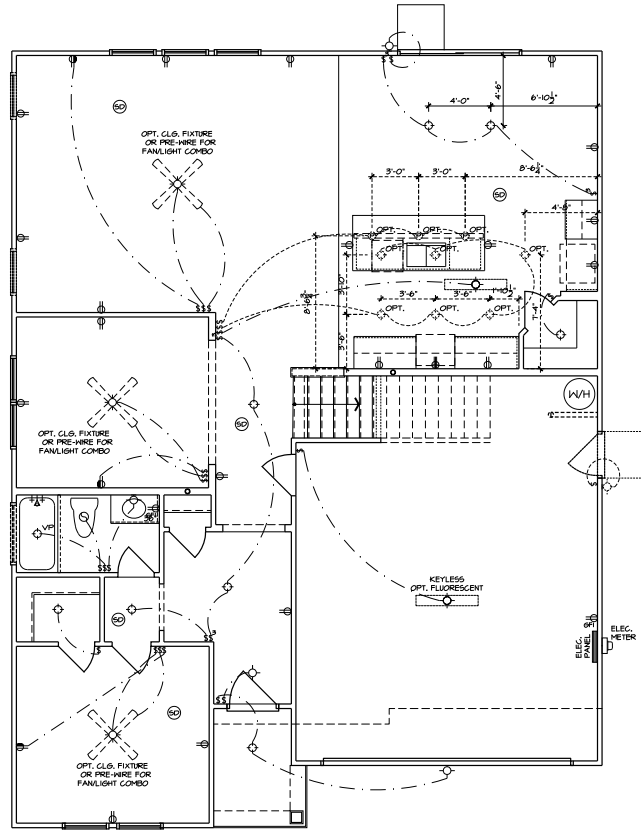

ELECTRICAL PLAN - FARMHOUSE

**ELECTRICAL LEGEND**

- ⊕ 110V RECEPTACLE
- ⊕ 110V SWITCHED OUTLET
- ⊕ 220V RECEPTACLE
- ⊕ 110V GFI RECEPTACLE (WATER PROOF)
- ⊕ 110V GFI RECEPTACLE
- ⊕ RECESSED, VAPOR PROOF LIGHT FIXTURE
- ⊕ LIGHT FIXTURE
- ⊕ RECESSED CAN LIGHT FIX.
- ⊕ OPT RECESSED CAN LIGHT FIX.
- ⊕ PENDANT LIGHT FIX.
- ⊕ 4' FLUORESCENT LIGHT
- ⊕ 2' FLUORESCENT LIGHT
- ⊕ 6" x 8" FLUORESCENT LIGHT
- ⊕ LIGHT SWITCH
- ⊕ 3-WAY LIGHT SWITCH
- ⊕ 4-WAY LIGHT SWITCH
- ⊕ EXHAUST FAN
- ⊕ EXHAUST FAN/ LIGHT COMBO
- ⊕ SMOKE DETECTOR
- ⊕ CARBON MONOXIDE
- ⊕ ON TO PANEL
- ⊕ DOOR CHIME
- ⊕ ELECTRICAL PANEL
- ⊕ OPT CEILING FAN W/ LIGHT
- ⊕ OPT FLOOD LIGHT

NOTE: ALL SMOKE DETECTORS TO BE INTERCONNECTED PER APPLICABLE CODE (SEE TITLE SHEET)

**mattamyHOMES**

**MATTAMY HOMES  
CHARLOTTE DIVISION  
PH: 704-375-9373**

**MATTAMY HOMES  
RALEIGH DIVISION  
PH: 919-752-4898**

**JDS Consulting**  
DESIGN • ENGINEERING • SURVEYING • ENERGY

JDS Consulting P.L.L.C., 8600 D'JERSEY CT, RALEIGH, NC 27617-9198, 1075 INFO@JDSCONSULTING.NET, WWW.JDSCONSULTING.NET

JDS Consulting, P.L.L.C. IS NOT LIABLE FOR CHANGES MADE TO PLANS OR FIELD CONSTRUCTION METHODS OR ANY CHANGES TO PLANS MADE IN THE FIELD BY CONTRACTOR OR BY OTHERS. DRAWINGS ARE PROVIDED TO CLIENT FOR THEIR USE ONLY. ALL DIMENSIONS SHALL GOVERN OVER SCALE, AND CODE SHALL GOVERN OVER DIMENSIONS ON DRAWINGS.

**MATTAMY HOMES**

**SEQUOIA - RH**

**NORTH CAROLINA**

CLIENT: MATTAMY HOMES  
PROJECT: SEQUOIA - RH  
LOCATION: NORTH CAROLINA

SCALE: 1/8" = 1'-0" FOR 11x17 PAPER, 1/4" = 1'-0" FOR 22x34 PAPER, OR AS NOTED

PROJECT NO. **21901607**

DATE: **11/08/2021** DRAWN BY: **CAR**

**FIRST FLOOR  
ELECTRICAL PLAN**

**6.0**

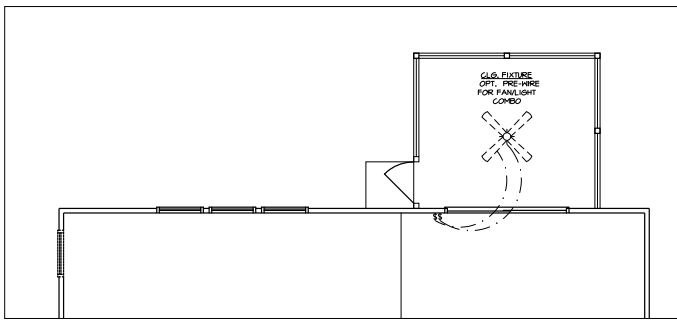

PPO - GROUND FLOOR ELECT. PLAN  
SCREEN PORCH (RALEIGH)

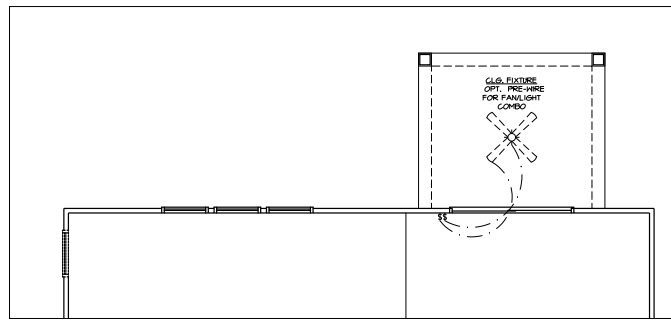

PPO - GROUND FLOOR ELECT. PLAN  
COVERED VERANDA

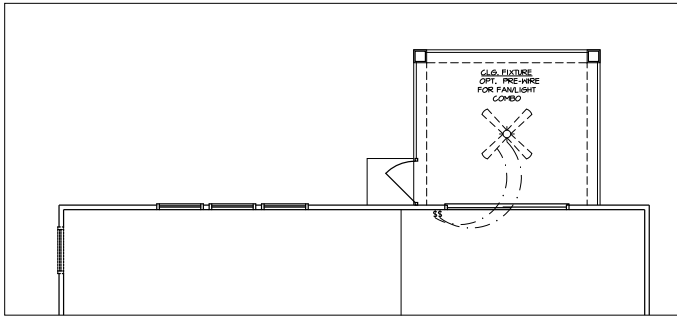

PPO - GROUND FLOOR ELECT. PLAN  
SCREEN PORCH (CHARLOTTE)

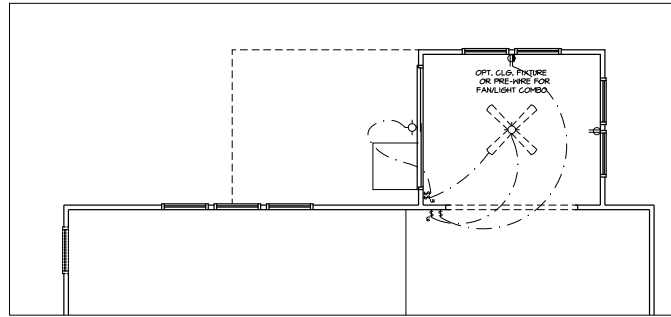

PPO - GROUND FLOOR ELECT. PLAN  
SUNROOM

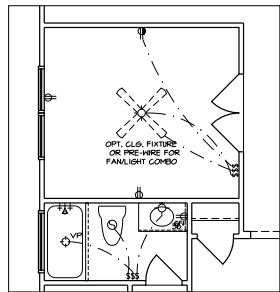

PPO - GROUND FLOOR  
ELECT. PLAN - CRAFTSMAN  
STUDY

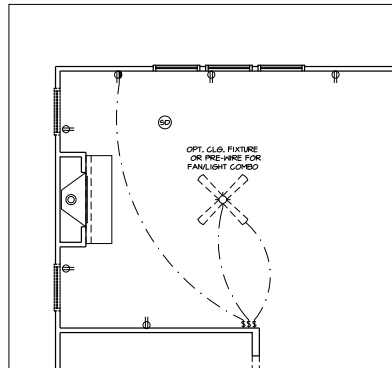

PPO - GROUND  
FLOOR ELECT. PLAN  
GAS FIREPLACE

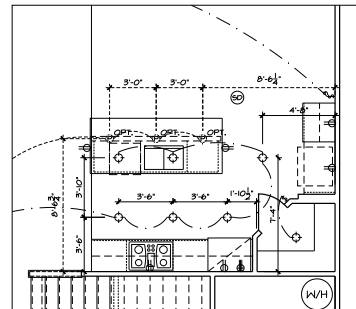

PPO - GROUND  
FLOOR ELECT. PLAN  
SIGNATURE KITCHEN

ELECTRICAL LEGEND	
	110V RECEPTACLE
	110V SWITCHED OUTLET
	220V RECEPTACLE
	110V RECEPTACLE (WATER PROOF)
	110V GFI RECEPTACLE
	RECESSED, VAPOR PROOF LIGHT FIXTURE
	LIGHT FIXTURE
	RECESSED CAN LIGHT FIX.
	OPT RECESSED CAN LIGHT FIX.
	PENDANT LIGHT FIX.
	4' FLUORESCENT LIGHT
	2' FLUORESCENT LIGHT
	6' x 8' FLUORESCENT LIGHT
	LIGHT SWITCH
	3-WAY LIGHT SWITCH
	4-WAY LIGHT SWITCH
	EXHAUST FAN
	EXHAUST FAN / LIGHT COMBO
	SMOKE DETECTOR
	CARBON MONOXIDE
	ON / OFF PANEL
	DOOR CHAMFER
	ELECTRICAL PANEL
	OPT CEILING FAN W/ LIGHT
	OPT FLOOD LIGHT

NOTE: ALL SMOKE DETECTORS TO BE INTERCONNECTED PER APPLICABLE CODE (SEE TITLE SHEET)

**MATTAMY HOMES  
CHARLOTTE DIVISION  
PH: 704-375-9373**

**MATTAMY HOMES  
RALEIGH DIVISION  
PH: 919-752-4898**

---

JDS Consulting P.L.L.C. 8600 DP JERSEY CT. RALEIGH, NC 27617-9195-480-1075  
INFO@JDSCONSULTING.NET WWW.JDSCONSULTING.NET

JDS Consulting, P.L.L.C. IS NOT LIABLE FOR DAMAGES MADE TO PLANS OR FIELD CONSTRUCTION METHODS OR ANY CHANGES TO PLANS MADE IN THE FIELD BY CONTRACTOR OR BY OTHERS. DRAWINGS ARE PROVIDED TO CLIENT FOR THEIR USE ONLY. ALL DIMENSIONS SHALL GOVERN OVER SCALE, AND CODE SHALL GOVERN OVER DIMENSIONS ON DRAWINGS.

---

**MATTAMY HOMES**  
PROJECT: **SEQUOIA - RH**  
LOCATION: **NORTH CAROLINA**

SCALE: 1/8" = 1'-0" FOR 11x17 PAPER, 1/4" = 1'-0" FOR 22x34 PAPER, OR AS NOTED.

---

CLIENT: **MATTAMY HOMES**

PROJECT: **SEQUOIA - RH**

LOCATION: **NORTH CAROLINA**

PROJECT NO. **21901607**

DATE: **11/08/2021** DRAWN BY: **CAV**

---

**FIRST FLOOR OPTIONS  
ELECTRICAL PLANS**

**6.1**

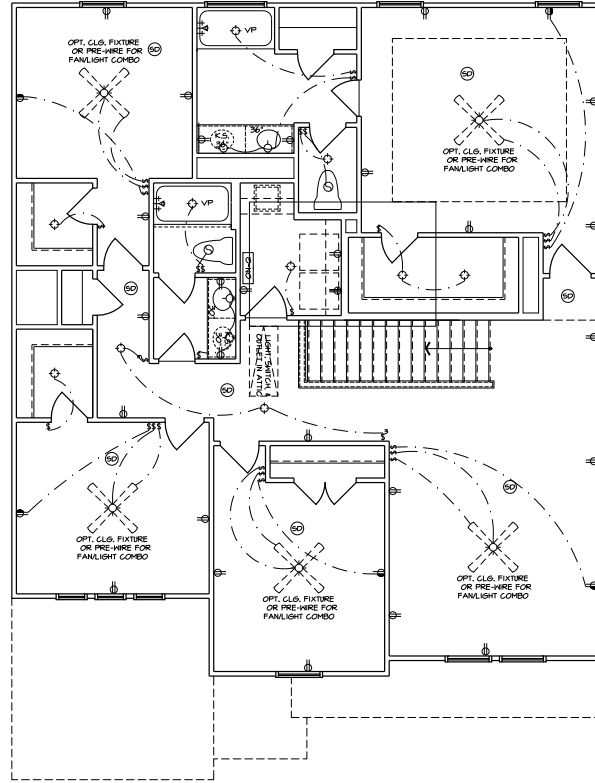

SECOND FLOOR ELECTRICAL PLAN - FARMHOUSE

ELECTRICAL LEGEND	
	110V RECEPTACLE
	110V SWITCHED OUTLET
	220V RECEPTACLE
	110V RECEPTACLE (WATER PROOF)
	110V GFI RECEPTACLE
	RECESSED, VAPOR PROOF LIGHT FIXTURE
	LIGHT FIXTURE
	RECESSED CAN LIGHT FIX.
	OPT RECESSED CAN LIGHT FIX.
	PENDANT LIGHT FIX.
	4' FLUORESCENT LIGHT
	2' FLUORESCENT LIGHT
	6' x 8' FLUORESCENT LIGHT
	LIGHT SWITCH
	3-WAY LIGHT SWITCH
	4-WAY LIGHT SWITCH
	EXHAUST FAN
	EXHAUST FAN/ LIGHT COMBO
	SMOKE DETECTOR
	CARBON MONOXIDE
	ON/OFF PANEL
	DOOR CHAMFER
	ELECTRICAL PANEL
	OPT CEILING FAN W/ LIGHT
	OPT FLOOD LIGHT

NOTE: ALL SMOKE DETECTORS TO BE INTERCONNECTED PER APPLICABLE CODE (SEE TITLE SHEET)

**mattamyHOMES**

MATTAMY HOMES  
**CHARLOTTE DIVISION**  
 PH: 704-375-9373

MATTAMY HOMES  
**RALEIGH DIVISION**  
 PH: 919-752-4898

**JDS Consulting**  
 DESIGN • ENGINEERING • SURVEYING • ENERGY

JDS Consulting PLLC, 8600 DP JERSEY, CT, RALEIGH, NC 27617-9195-480-1075  
 INFO@JDSCONSULTING.NET, WWW.JDSCONSULTING.NET

JDS Consulting, PLLC IS NOT LIABLE FOR CHANGES MADE TO PLANS OR FIELD CONSTRUCTION METHODS OR ANY CHANGES TO PLANS MADE IN THE FIELD BY CONTRACTOR OR BY OTHERS. DRAWINGS ARE PROVIDED TO CLIENT FOR THEIR USE ONLY. ALL DIMENSIONS SHALL GOVERN OVER SCALE, AND CODE SHALL GOVERN OVER DIMENSIONS ON DRAWINGS.

**Harnett COUNTY**  
 HARNETT COUNTY  
 HARNETT COUNTY  
 HARNETT COUNTY

CLIENT: **MATTAMY HOMES**

PROJECT: **SEQUOIA - RH**

LOCATION: **NORTH CAROLINA**

SCALE: 1/8" = 1'-0" FOR 11x17 PAPER, 1/4" = 1'-0" FOR 22x34 PAPER, OR AS NOTED

PROJECT NO. **21901607**

DATE: **11/08/2021** DRAWN BY: **CAR**

**SECOND FLOOR ELECTRICAL PLAN**

**7.0**

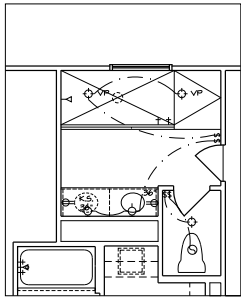

PPO - SECOND FLOOR  
ELECT. PLAN  
BATH OASIS

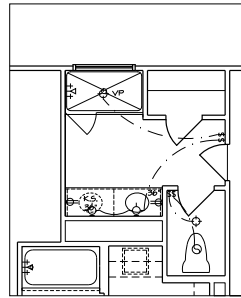

PPO - SECOND FLOOR ELECT. PLAN  
STAND-IN SHOWER

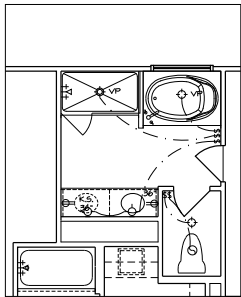

PPO - SECOND FLOOR ELECT. PLAN  
BATH OASIS

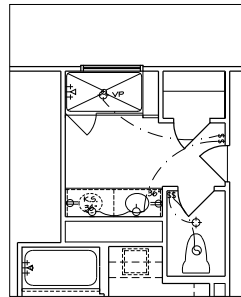

PPO - SECOND FLOOR ELECT. PLAN  
STAND-IN SHOWER w/ SEAT

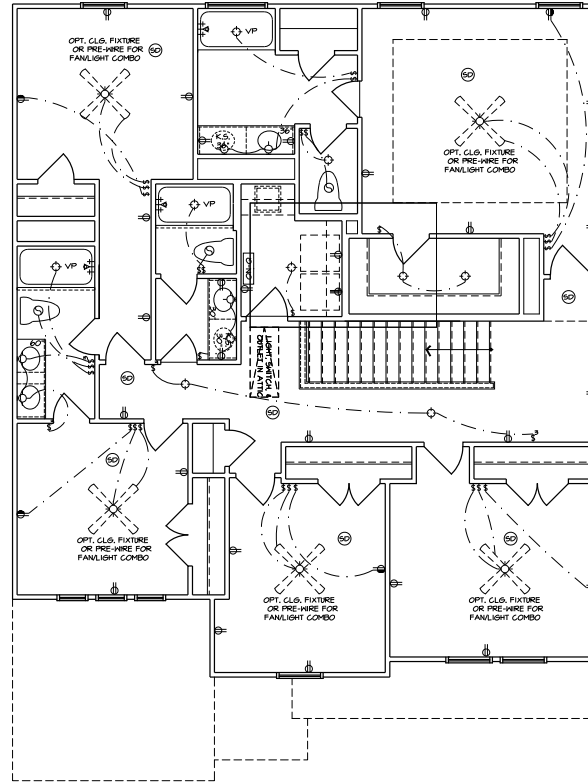

PPO - SECOND FLOOR ELECTRICAL PLAN  
BEDROOM 5/BATH 4 -  
FARMHOUSE

**ELECTRICAL LEGEND**

- ⊕ 110V RECEPTACLE
- ⊕ 110V SWITCHED OUTLET
- ⊕ 220V RECEPTACLE
- ⊕ 110V RECEPTACLE (WATER PROOF)
- ⊕ 110V GFI RECEPTACLE
- ⊕ RECESSED, VAPOR PROOF LIGHT FIXTURE
- ⊕ LIGHT FIXTURE
- ⊕ RECESSED CAN LIGHT FIX.
- ⊕ OPT RECESSED CAN LIGHT FIX.
- ⊕ PENDANT LIGHT FIX.
- ⊕ 4' FLUORESCENT LIGHT
- ⊕ 2' FLUORESCENT LIGHT
- ⊕ 4' x 8' FLUORESCENT LIGHT
- ⊕ LIGHT SWITCH
- ⊕ 3-WAY LIGHT SWITCH
- ⊕ 4-WAY LIGHT SWITCH
- ⊕ EXHAUST FAN
- ⊕ EXHAUST FAN/ LIGHT COMBO
- ⊕ SMOKE DETECTOR
- ⊕ CARBON MONOXIDE
- ⊕ ON 10' PANEL
- ⊕ DOOR CHAMES
- ⊕ ELECTRICAL PANEL
- ⊕ OPT CEILING FAN w/ LIGHT
- ⊕ OPT FLOOD LIGHT

NOTE: ALL SMOKE DETECTORS TO BE INTERCONNECTED PER APPLICABLE CODE (SEE TITLE SHEET)

**mattamyHOMES**

MATTAMY HOMES  
**CHARLOTTE DIVISION**  
PH: 704-375-9373

MATTAMY HOMES  
**RALEIGH DIVISION**  
PH: 919-752-4898

**JDS Consulting**  
DESIGN • ENGINEERING • SURVEYING • ENERGY

JDS Consulting PLLC, 8600 DP JERSEY, CT, RALEIGH, NC 27617-9195-480-075  
INFO@JDSCONSULTING.NET, WWW.JDSCONSULTING.NET

JDS Consulting, PLLC IS NOT LIABLE FOR CHANGES MADE TO PLANS OR FIELD CONSTRUCTION METHODS OR ANY CHANGES TO PLANS MADE IN THE FIELD BY CONTRACTOR OR BY OTHERS. DRAWINGS ARE PROVIDED TO CLIENT FOR THEIR USE ONLY. ALL DIMENSIONS SHALL GOVERN OVER SCALE, AND CODE SHALL GOVERN OVER DIMENSIONS ON DRAWINGS.

**MATTAMY HOMES**

PROJECT: SEQUOIA - RH

LOCATION: NORTH CAROLINA

SCALE: 1/8" = 1'-0" FOR 11x17 PAPER, 1/4" = 1'-0" FOR 24x36 PAPER, OR AS NOTED

CLIENT: MATTAMY HOMES

PROJECT NO. 21901607

DATE: 11/08/2021 DRAWN BY: CAR

SECOND FLOOR OPTIONS  
ELECTRICAL PLANS

**7.1**





NOTE: ALL CHAPTERS, SECTIONS, TABLES, AND FIGURES CITED WITHOUT A PUBLICATION TITLE ARE FROM THE APPLICABLE RESIDENTIAL CODE (SEE TITLE SHEET).

**GENERAL**

- IT IS THE CONTRACTOR'S RESPONSIBILITY TO VERIFY ALL DIMENSIONS PRIOR TO CONSTRUCTION. FURTHERMORE, CONTRACTOR IS ULTIMATELY RESPONSIBLE FOR CONSTRUCTION MEANS, METHODS, AND SAFETY ON SITE. NOTIFY JDS CONSULTING, PLLC IMMEDIATELY IF DISCREPANCIES ON PLAN EXIST.
- BRACED-WALL DESIGN IS BASED ON SECTION R602.10 - WALL BRACING. PRIMARY PRESCRIPTIVE METHOD TO BE CS-WSP. SEE WALL BRACING PLANS AND DETAILS FOR ADDITIONAL INFORMATION.  
ALL NON-PRESCRIPTIVE SOLUTIONS ARE BASED ON GUIDELINES ESTABLISHED IN THE AMERICAN SOCIETY OF CIVIL ENGINEERS PUBLICATION ASCE 7 AND THE NATIONAL DESIGN SPECIFICATION FOR WOOD CONSTRUCTION - SPECIAL DESIGN PROVISIONS FOR WIND AND SEISMIC.
- SEISMIC DESIGN SHALL BE PER SECTION R301.2.2 - SEISMIC PROVISIONS, INCLUDING ASSOCIATED TABLES AND FIGURES, BASED ON LOCAL SEISMIC DESIGN CATEGORY.

**DESIGN LOADS**

ASSUMED SOIL BEARING-CAPACITY	2,000 PSF
<b>LIVE LOAD</b>	
ULTIMATE DESIGN WIND SPEED	115 MPH, EXPOSURE B
GROUND SNOW	15 PSF
ROOF	20 PSF
<b>RESIDENTIAL CODE TABLE R301.5</b>	
DWELLING UNITS	40
SLEEPING ROOMS	30
ATTICS WITH STORAGE	20
ATTICS WITHOUT STORAGE	10
STAIRS	40
DECKS	40
EXTERIOR BALCONIES	60
PASSENGER VEHICLE GARAGES	50
FIRE ESCAPES	40
GUARDS AND HANDRAILS	200 (pounds, concentrated)
COMPONENT AND CLADDING LOADS, INCLUDING THOSE FOR DOORS AND WINDOWS, SHALL BE DERIVED FROM TABLES R301.2(2) AND R301.2(3) FOR A BUILDING WITH A MEAN ROOF HEIGHT OF 35 FEET, LOCATED IN EXPOSURE B.	

**ABBREVIATIONS**

ABV	ABOVE	KS	KING STUD COLUMN
AFF	ABOVE FINISHED FLOOR	LVL	LAMINATED VENEER LUMBER
ALT	ALTERNATE	MAX	MAXIMUM
BRG	BEARING	MECH	MECHANICAL
BSMT	BASEMENT	MFR	MANUFACTURER
CANT	CANTILEVER	MIN	MINIMUM
CJ	CEILING JOIST	NTS	NOT TO SCALE
CLG	CEILING	OA	OVERALL
CMU	CONCRETE MASONRY UNIT	OC	ON CENTER
CO	CASED OPENING	PT	PRESSURE TREATED
COL	COLUMN	R	RISER
CONC	CONCRETE	REF	REFRIGERATOR
CONT	CONTINUOUS	RFG	ROOFING
D	CLOTHES DRYER	RO	ROUGH OPENING
DBL	DOUBLE	RS	ROOT SUPPORT
DIAM	DIAMETER	SC	STUD COLUMN
DJ	DOUBLE JOIST	SF	SQUARE FOOT (FEET)
DN	DOWN	SH	SHELF / SHELVES
DP	DEEP	SHTG	SHEATHING
DR	DOUBLE RAFTER	SHW	SHOWER
DSP	DOUBLE STUD POCKET	SIM	SIMILAR
EA	EACH	SJ	SINGLE JOIST
EE	EACH END	SP	STUD POCKET
EQ	EQUAL	SPEC'D	SPECIFIED
EX	EXTERIOR	SQ	SQUARE
FAU	FORCED-AIR UNIT	T	TREAD
FDN	FOUNDATION	TEMP	TEMPERED GLASS
FF	FINISHED FLOOR	THK	THICK(NESS)
FLR	FLOORING	TJ	TRIPLE JOIST
FP	FIREPLACE	TOC	TOP OF CURB / CONCRETE
FTG	FOOTING	TR	TRIPLE RAFTER
HB	HOSE BIBB	TYP	TYPICAL
HDR	HEADER	UNO	UNLESS NOTED OTHERWISE
HGR	HANGER	W	CLOTHES WASHER
JS	JACK STUD COLUMN	WH	WATER HEATER
		WWF	WELDED WIRE FABRIC
		XJ	EXTRA JOIST

**MATERIALS**

- INTERIOR / TRIMMED FRAMING LUMBER SHALL BE #2 SPRUCE PINE FIR (SPF) WITH THE FOLLOWING DESIGN PROPERTIES (#2 SOUTHERN YELLOW PINE MAY BE SUBSTITUTED):  
Fb = 875 PSI Fv = 70 PSI E = 1.4E6 PSI
- FRAMING LUMBER EXPOSED TO WEATHER OR IN CONTACT WITH THE GROUND, CONCRETE, OR MASONRY SHALL BE PRESSURE TREATED #2 SOUTHERN YELLOW PINE (SYP) WITH THE FOLLOWING DESIGN PROPERTIES:  
Fb = 975 PSI Fv = 95 PSI E = 1.6E6 PSI
- LVL STRUCTURAL MEMBERS TO BE LAMINATED VENEER LUMBER WITH THE FOLLOWING MINIMUM DESIGN PROPERTIES:  
Fb = 2600 PSI Fv = 285 PSI E = 1.9E6 PSI
- PSL STRUCTURAL MEMBERS TO BE PARALLEL STRAND LUMBER WITH THE FOLLOWING MINIMUM DESIGN PROPERTIES:  
Fb = 2900 PSI Fv = 290 PSI E = 2.0E6 PSI
- LVL STRUCTURAL MEMBERS TO BE LAMINATED STRAND LUMBER WITH THE FOLLOWING MINIMUM DESIGN PROPERTIES:  
Fb = 2250 PSI Fv = 400 PSI E = 1.55E6 PSI
- STRUCTURAL STEEL WIDE-FLANGE BEAMS SHALL CONFORM TO ASTM A992. Fy = 50 KSI
- REBAR SHALL BE DEFORMED STEEL CONFORMING TO ASTM A615, GRADE 60.
- POURED CONCRETE COMPRESSIVE STRENGTH TO BE A MINIMUM 3,000 PSI AT 28 DAYS. MATERIALS USED TO PRODUCE CONCRETE SHALL COMPLY WITH THE APPLICABLE STANDARDS LISTED IN AMERICAN CONCRETE INSTITUTE STANDARD ACI 318 OR ASTM C1157.
- CONCRETE SUBJECT TO MODERATE OR SEVERE WEATHERING PROBABILITY PER TABLE R301.2(1) SHALL BE AIR-ENTRAINED WHEN REQUIRED BY TABLE R402.2.
- CONCRETE MASONRY UNITS (CMU) SHALL CONFORM TO AMERICAN CONCRETE INSTITUTE PUBLICATION 530: BUILDING CODE REQUIREMENTS AND SPECIFICATIONS FOR MASONRY STRUCTURES AND COMPANION COMMENTARIES AND THE MASONRY SOCIETY PUBLICATION TMS 402/602: BUILDING CODE REQUIREMENTS AND SPECIFICATIONS FOR MASONRY STRUCTURES.
- MORTAR SHALL COMPLY WITH ASTM INTERNATIONAL STANDARD C270.
- INDICATED MODEL NUMBERS FOR ALL METAL HANGERS, STRAPS, FRAMING CONNECTORS, AND HOLD-DOWNS ARE SIMPSON STRONG-TIE BRAND. EQUIVALENT USP BRAND PRODUCTS ARE ACCEPTABLE.
- REFER TO I-JOIST EQUIVALENCE CHART ON I-JOIST DETAIL SHEET FOR SUBSTITUTION OF MANUFACTURER SERIES.

**FOUNDATION**

- MINIMUM ALLOWABLE SOIL BEARING CAPACITY IS ASSUMED TO BE 2,000 PSF. IT IS THE CONTRACTOR'S RESPONSIBILITY TO VERIFY SOIL BEARING CAPACITY IF UNSATISFACTORY CONDITIONS EXIST.
- CONCRETE FOUNDATION WALLS TO BE SELECTED AND CONSTRUCTED PER SECTION R404 OR AMERICAN CONCRETE INSTITUTE STANDARD ACI 318.
- MASONRY FOUNDATION WALLS TO BE SELECTED AND CONSTRUCTED PER SECTION R404 AND/OR AMERICAN CONCRETE INSTITUTE PUBLICATION 530: BUILDING CODE REQUIREMENTS AND SPECIFICATIONS FOR MASONRY STRUCTURES AND COMPANION COMMENTARIES AND/OR THE MASONRY SOCIETY PUBLICATION TMS 402/602: BUILDING CODE REQUIREMENTS AND SPECIFICATIONS FOR MASONRY STRUCTURES.
- CONCRETE WALL HORIZONTAL REINFORCEMENT TO BE PER TABLE R404.1.2(1) OR AS NOTED OR DETAILED. CONCRETE WALL VERTICAL REINFORCEMENT TO BE PER TABLES R404.1.2(3 AND 4) OR AS NOTED OR DETAILED. ALL CONCRETE WALLS SHALL COMPLY WITH APPLICABLE PROVISIONS OF CHAPTER 6.
  - TABLES ASSUME THAT WALLS HAVE PERMANENT LATERAL SUPPORT AT THE TOP AND BOTTOM.
  - FOUNDATION DRAINS ARE ASSUMED AT ALL WALLS PER SECTION R405.
- PLAIN-MASONRY WALL DESIGN TO BE PER TABLE R404.1.1(1) OR AS NOTED OR DETAILED. MASONRY WALLS WITH VERTICAL REINFORCEMENT TO BE PER TABLES R404.1.1 (2 THROUGH 4) OR AS NOTED OR DETAILED. ALL MASONRY WALLS SHALL COMPLY WITH APPLICABLE PROVISIONS OF CHAPTER 6.
  - TABLES ASSUME THAT WALLS HAVE PERMANENT LATERAL SUPPORT AT THE TOP AND BOTTOM.
  - WALL REINFORCING SHALL BE PLACED ACCORDING TO FOOTNOTE (c) OF THE TABLES (REINFORCING IS NOT CENTERED IN WALL).
  - FOUNDATION DRAINS ARE ASSUMED AT ALL WALLS PER SECTION R405.
- WOOD SILL PLATES TO BE ANCHORED TO THE FOUNDATION WITH 1/2" DIAMETER ANCHOR BOLTS WITH MINIMUM 7" EMBEDMENT, SPACED A MAXIMUM OF 6'-0" OC AND WITHIN 12" FROM THE ENDS OF EACH PLATE SECTION. INSTALL MINIMUM (2) ANCHOR BOLTS PER SECTION. SEE SECTION R403.1.6 FOR SPECIFIC CONDITIONS.
- THE UNSUPPORTED HEIGHT OF SOLID MASONRY PIERS SHALL NOT EXCEED TEN TIMES THEIR LEAST DIMENSION. UNFILLED, HOLLOW PIERS MAY BE USED IF THE UNSUPPORTED HEIGHT IS NOT MORE THAN FOUR TIMES THEIR LEAST DIMENSION.
- CENTERS OF PIERS TO BEAR IN THE MIDDLE THIRD OF THE FOOTINGS, AND GIRDSERS SHALL CENTER IN THE MIDDLE THIRD OF THE PIERS.
- ALL FOOTINGS TO HAVE MINIMUM 2" PROJECTION ON EACH SIDE OF FOUNDATION WALLS (SEE DETAILS).
- ALL REBAR NOTED IN CONCRETE TO HAVE AT LEAST 2" COVER FROM EDGE OF CONCRETE TO EDGE OF REBAR.
- FRAMING TO BE FLUSH WITH FOUNDATION WALLS.
- WITH CLASS 1 SOILS, VAPOR BARRIER AND CRUSHED STONE MAY BE OMITTED.

**FRAMING**

- ALL BEARING HEADERS TO BE (2) 2x6 SUPPORTED W/ MIN (1) JACK STUD AND (1) KING STUD EACH END, UNO.
- ALL NON-BEARING HEADERS TO BE (2) 2x4, UNO.
- NON-BEARING INTERIOR WALLS NOT MORE THAN 10' NOMINAL HEIGHT AND NOT SHOWN AS BRACED WALLS MAY BE FRAMED WITH 2x4 STUDS @ 24" OC.
- SOLID BLOCKING TO BE PROVIDED AT ALL POINT LOADS DURING FLOOR LEVELS TO THE FOUNDATION OR TO OTHER STRUCTURAL COMPONENTS.
- ALL BEAMS SPECIFIED ARE MINIMUM SIZES ONLY. LARGER MEMBERS MAY BE SUBSTITUTED AS NEEDED FOR EASE OF CONSTRUCTION.
- ALL EXTERIOR WALLS TO BE FULLY SHEATHED WITH 7/16" OSB.
- PORCH / PATIO COLUMNS TO BE 4x4 MINIMUM PRESSURE-TREATED LUMBER.
  - ATTACH PORCH COLUMNS TO SLAB / FDN WALL USING ABU, ABW, OR CPT SIMPSON POST BASES TO FIT COLUMN SIZES NOTED ON PLAN -OR- ANY OTHER COLUMN CONNECTION WITH 500# UPLIFT CAPACITY.
  - ATTACH PORCH COLUMNS TO PORCH BEAMS USING AC OR BC SIMPSON POST CAPS TO FIT COLUMN SIZES NOTED ON PLAN -OR- ANY OTHER COLUMN CONNECTION WITH 500# UPLIFT CAPACITY.
  - TRIM OUT COLUMN(S) AND BEAM(S) PER BUILDER AND DETAILS.
- ALL ENGINEERED WOOD PRODUCTS (LVL, PSL, LSL, ETC.) SHALL BE INSTALLED WITH CONNECTIONS PER MANUFACTURER SPECIFICATIONS.
- ENGINEERED WOOD FLOOR SYSTEMS AND ROOF TRUSS SYSTEMS:
  - SHOP DRAWINGS FOR THE SYSTEMS SHALL BE PROVIDED TO THE ENGINEER FOR RECORD FOR REVIEW AND COORDINATION BEFORE CONSTRUCTION.
  - TRUSS PROFILES SHALL BE SEALED BY THE TRUSS MANUFACTURER.
  - INSTALLATION OF THE SYSTEMS SHALL BE PER MANUFACTURER'S INSTRUCTIONS.
  - TRUSS LAYOUT AND PLACEMENT BY MANUFACTURER TO COINCIDE WITH THE SUPPORT LOCATIONS SHOWN IN THESE DRAWINGS.
- ALL BEAMS TO BE CONTINUOUSLY SUPPORTED LATERALLY AND SHALL BEAR FULL WIDTH ON THE SUPPORTING WALLS OR COLUMNS INDICATED, WITH A MINIMUM OF THREE STUDS, UNO.
- ALL STEEL BEAMS TO BE SUPPORTED AT EACH END WITH A MIN BEARING LENGTH OF 3 1/2" AND FULL FLANGE WIDTH. BEAMS MUST BE ATTACHED AT EACH END WITH A MINIMUM OF FOUR 16d NAILS OR TWO 1/2" x 4" LAG SCREWS, UNO.
- STEEL FLITCH BEAMS TO BE BOLTED TOGETHER USING (2) ROWS OF 1/2" DIAMETER BOLTS (ASTM 307) WITH WASHERS PLACED UNDER THE THREADED END OF THE BOLT. BOLTS TO BE SPACED AT 24" OC (MAX) AND STAGGERED TOP AND BOTTOM OF BEAM (2" EDGE DISTANCE), WITH TWO BOLTS TO BE LOCATED AT 6" FROM EACH END OF FLITCH BEAM.
- WHEN A 4-PLY LVL BEAM IS USED, ATTACH WITH (1) 1/2" DIAMETER BOLT, 12" OC, STAGGERED TOP AND BOTTOM, 1 1/2" MIN FROM ENDS. ALTERNATE EQUIVALENT ATTACHMENT METHOD MAY BE USED, SUCH AS SDS, SDW, OR TRUSSLOK SCREWS (SEE MANUFACTURER SPECIFICATIONS).
- FOR STUD COLUMNS OF 4-OR-MORE STUDS, INSTALL SIMPSON STRONG-TIE CS16 STRAPS ACROSS STUDS @ 30" OC, 6" MAX FROM (PLATES, ON INSIDE FACE OF COLUMN (EXTERIOR WALL), ON BOTH FACES OF COLUMN (INTERIOR WALL)).
- FLOOR JOISTS ADJACENT AND PARALLEL TO THE EXTERIOR FOUNDATION WALL SHALL BE PROVIDED WITH FULL-DEPTH SOLID BLOCKING, NOT LESS THAN TWO (2) INCHES NOMINAL IN THICKNESS, PLACED PERPENDICULAR TO THE JOIST AT SPACING NOT MORE THAN FOUR (4) FEET. THE BLOCKING SHALL BE NAILED TO THE FLOOR SHEATHING, THE SILL PLATE, THE JOIST, AND THE EXTERIOR RIM JOIST / BOARD.



P-0961

**JDS Consulting**  
 JDS Consulting PLLC, 8600 D JERSEY CT, RALEIGH, NC 27617 919-480-1075  
 INFO@JDSCONSULTING.NET, WWW.JDSCONSULTING.NET

JDS Consulting PLLC IS NOT LIABLE FOR CHANGES MADE TO THIS FILE. THE DESIGNER OR ARCHITECTOR IS RESPONSIBLE FOR VERIFYING THE ACCURACY OF ALL DIMENSIONS AND CONDITIONS. DRAWINGS ARE PROVIDED TO CLIENT FOR THEIR USE ONLY. ANY CHANGES TO PLANS MADE IN THE FIELD BY CONTRACTOR OR BY OTHERS, DRAWINGS ARE PROVIDED TO CLIENT FOR THEIR USE ONLY. ANY CHANGES TO PLANS MADE IN THE FIELD BY CONTRACTOR OR BY OTHERS, DRAWINGS ARE PROVIDED TO CLIENT FOR THEIR USE ONLY. ANY CHANGES TO PLANS MADE IN THE FIELD BY CONTRACTOR OR BY OTHERS, DRAWINGS ARE PROVIDED TO CLIENT FOR THEIR USE ONLY. ANY CHANGES TO PLANS MADE IN THE FIELD BY CONTRACTOR OR BY OTHERS, DRAWINGS ARE PROVIDED TO CLIENT FOR THEIR USE ONLY.

**MATTAMY HOMES**  
 PROJECT: SEQUOIA - RH  
 LOCATION: NORTH CAROLINA

SCALE: 1/8" = 1'-0" FOR 11x17 PAPER, 1/4" = 1'-0" FOR 24x36 PAPER, OR AS NOTED.



PROJECT NO: 21901607

DATE: 11/09/2021 DRAWN BY: NWS

GENERAL NOTES  
**GN1.0**

FASTENER SCHEDULE		
CONNECTION	3" x 0.131" NAIL	3" x 0.120" NAIL
JOIST TO SILL PLATE	(4) TOE NAILS	(4) TOE NAILS
SOLE PLATE TO JOIST / BLOCKING	NAILS @ 8" OC (typical) (4) PER 16" SPACE (at braced panels)	NAILS @ 8" OC (typical) (4) PER 16" SPACE (at braced panels)
STUD TO SOLE PLATE	(4) TOE NAILS	(4) TOE NAILS
TOP OR SOLE PLATE TO STUD	(3) FACE NAILS	(4) FACE NAILS
RIM JOIST OR BAND JOIST TO TOP PLATE OR SILL PLATE	TOE NAILS @ 6" OC	TOE NAILS @ 4" OC
BLOCKING BETWEEN JOISTS TO TOP PLATE OR SILL PLATE	(4) TOE NAILS	(4) TOE NAILS
DOUBLE STUD	NAILS @ 8" OC	NAILS @ 8" OC
DOUBLE TOP PLATES	NAILS @ 12" OC	NAILS @ 12" OC
DOUBLE TOP PLATES LAP (24" MIN LAP LENGTH)	(12) NAILS IN LAPPED AREA, EA SIDE OF JOINT	(12) NAILS IN LAPPED AREA, EA SIDE OF JOINT
TOP PLATE LAP AT CORNERS AND INTERSECTING WALLS	(3) FACE NAILS	(3) FACE NAILS
OPEN-WEB TRUSS BOTTOM CHORD TO TOP PLATES OR SILL PLATE (PARALLEL TO WALL)	NAILS @ 6" OC	NAILS @ 4" OC
BOTTOM CHORD OF TRUSS TO TOP PLATES OR SILL PLATE (PERPENDICULAR TO WALL)	(3) TOE NAILS	(3) TOE NAILS

SEE TABLE R602.3(1) FOR ADDITIONAL STRUCTURAL-MEMBER FASTENING REQUIREMENTS.

DETAILS AND NOTES ON DRAWINGS GOVERN.

**BALLOON WALL FRAMING SCHEDULE**

FRAMING MEMBER SIZE	MAX HEIGHT (PLATE TO PLATE) 115 MPH ULTIMATE DESIGN WIND SPEED
2x4 @ 16" OC	10'-0"
2x4 @ 12" OC	12'-0"
2x6 @ 16" OC	15'-0"
2x6 @ 12" OC	17'-9"
2x8 @ 16" OC	19'-0"
2x8 @ 12" OC	22'-0"
(2) 2x4 @ 16" OC	14'-6"
(2) 2x4 @ 12" OC	17'-0"
(2) 2x6 @ 16" OC	21'-6"
(2) 2x6 @ 12" OC	25'-0"
(2) 2x8 @ 16" OC	27'-0"
(2) 2x8 @ 12" OC	31'-0"

- ALL HEIGHTS ARE MEASURED SUBFLOOR TO TOP OF WALL PLATE.
- WHEN SPLIT-FRAMED WALLS ARE USED FOR HEIGHTS OVER 12', THE CONTRACTOR SHALL ADD 6" MINIMUM OF CS16 COIL STRAPPING (FULLY NAILED), CENTERED OVER THE WALL BREAK.
- FINGER-JOINTED MEMBERS MAY BE USED FOR CONTINUOUS HEIGHTS WHERE TRADITIONALLY MILLED LUMBER LENGTHS ARE LIMITED.
- FOR GREATER WIND SPEED, SEE ENGINEERED SOLUTION FOR CONDITION IN DRAWINGS.

**ROOF SYSTEMS**

**TRUSSED ROOF - STRUCTURAL NOTES**

- PROVIDE CONTINUOUS BLOCKING THROUGH STRUCTURE FOR ALL POINT LOADS.
-  DENOTES OVER-FRAMED AREA
- MINIMUM 7/16" OSB ROOF SHEATHING
- TRUSS LAYOUT AND PLACEMENT BY MANUFACTURER TO COINCIDE WITH THE SUPPORT LOCATIONS SHOWN. TRUSS PROFILES SHALL BE SEALED BY THE TRUSS MANUFACTURER. TRUSS PLANS TO BE COORDINATED WITH THE SEALED STRUCTURAL DRAWINGS. INSTALLATION SHALL BE IN ACCORDANCE WITH THE MANUFACTURER'S INSTRUCTIONS.
- MANUFACTURER TO PROVIDE REQUIRED UPLIFT CONNECTION.
- PROVIDE H2.5A (MINIMUM) OR EQUIVALENT AT EACH TRUSS-TO-TOP PLATE CONNECTION AT OVER-FRAMED AREAS, UNLESS NOTED OTHERWISE.
- UPLIFT CONNECTION TO BE CARRIED THROUGH TO FLOOR SYSTEM.

**STICK-FRAMED ROOF - STRUCTURAL NOTES**

- PROVIDE 2x4 COLLAR TIES AT 48" OC AT UPPER THIRD OF RAFTERS, UNLESS NOTED OTHERWISE.
- FUR RIDGES FOR FULL RAFTER CONTACT.
- PROVIDE CONTINUOUS BLOCKING THROUGH STRUCTURE FOR ALL POINT LOADS.
-  DENOTES OVER-FRAMED AREA
- MINIMUM 7/16" OSB ROOF SHEATHING
- PROVIDE 2x4 RAFTER TIES AT 16" OC AT 45° BETWEEN RAFTERS AND CEILING JOISTS. USE (4) 16d NAILS AT EACH CONNECTION. RAFTER TIES MAY BE SPACED AT 48" OC AT LOCATIONS WHERE NO KNEE WALLS ARE INSTALLED.
- PROVIDE H2.5A (MINIMUM) OR EQUIVALENT AT EACH RAFTER-TO-TOP PLATE CONNECTION AT OVER-FRAMED AREAS, UNLESS NOTED OTHERWISE.
- UPLIFT CONNECTION TO BE CARRIED THROUGH TO FLOOR SYSTEM.

**BRICK VENEER LINTEL SCHEDULE**

SPAN	STEEL ANGLE SIZE	END BEARING LENGTH
UP TO 42"	L3-1/2"x3-1/2"x1/4"	8" (MIN. @ EACH END)
UP TO 72"	L6"x4"x5/16" (LLV)	8" (MIN. @ EACH END)
OVER 72"	L6"x4"x5/16" (LLV) ATTACH LINTEL w/ 1/2" THRU BOLT @ 12" OC, 3" FROM EACH END	

\* FOR QUEEN BRICK: LINTELS AT THIS CONDITION MAY BE 5"x3-1/2"x5/16"

NOTE: BRICK LINTELS AT SLOPED AREAS TO BE 4"x3-1/2"x1/4" STEEL ANGLE WITH 16d NAILS IN 3/16" HOLES IN 4" ANGLE LEG AT 12" OC TO TRIPLE RAFTER. WHEN THE SLOPE EXCEEDS 4:12 A MINIMUM OF 3"x3"x1/4" PLATES SHALL BE WELDED AT 24" OC ALONG THE STEEL ANGLE.



P-0961



JDS Consulting, LLC IS NOT LIABLE FOR CHANGES MADE TO PLANS OR FOR CONSTRUCTION METHODS OR ANY CHANGES TO PLANS MADE IN THE FIELD BY CONTRACTOR OR BY OTHERS. DRAWINGS ARE PROVIDED TO CLIENT FOR THEIR USE ONLY. CONTRACTOR SHALL GOVERN OVER SCALE AND CODE SHALL GOVERN OVER DIMENSIONS ON DRAWINGS.



CUSTOMER: **MATTAMY HOMES**

PROJECT: **SEQUOIA - RH**

LOCATION: **NORTH CAROLINA**

SCALE: 1/8" = 1'-0" FOR LAYOUT PAPER, 1/4" = 1'-0" FOR 22x34 PAPER, OR AS NOTED



PROJECT NO.: **21901607**

DATE: **11/09/2021** DRAWN BY: **NWS**

GENERAL NOTES

**GN1.1**

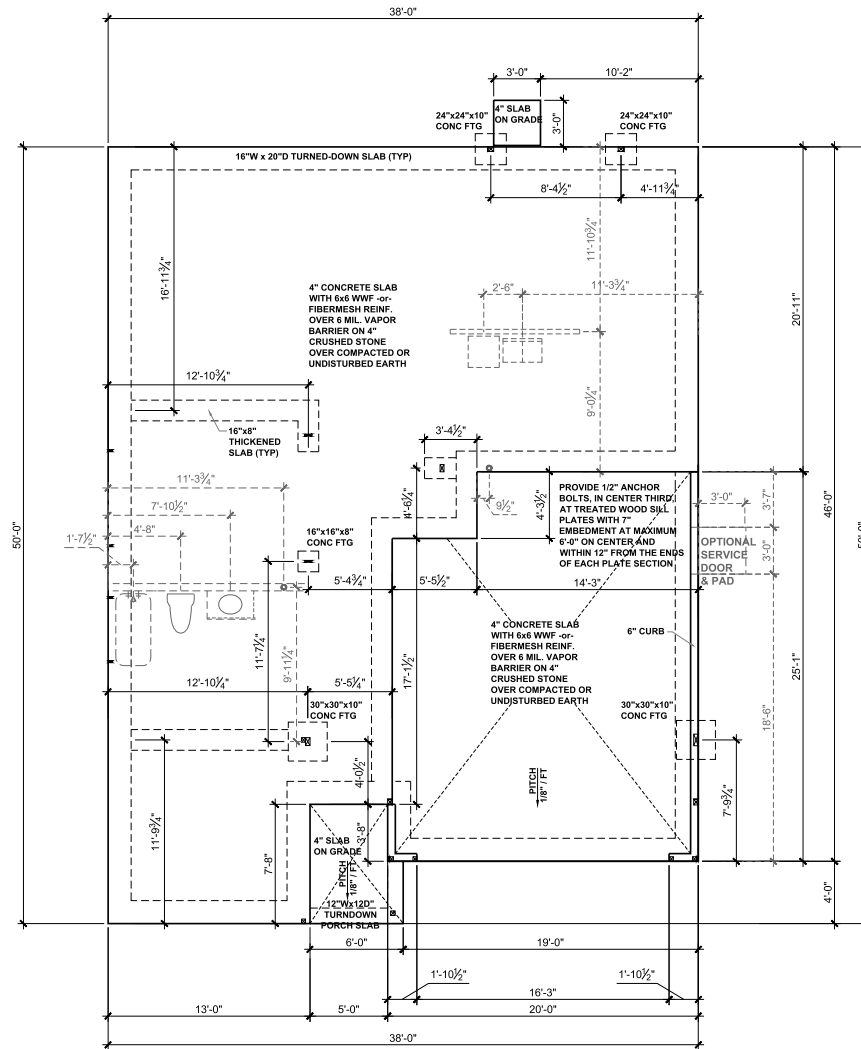

### SLAB FOUNDATION PLAN - FARMHOUSE

SCALE: 1/8" = 1'-0"

**BEAM & POINT LOAD LEGEND:**

	LOAD BEARING WALL
	ROOF RAFTER/TRUSS SUPPORT
	DOUBLE RAFTER / DOUBLE JOIST
	STRUCTURAL BEAM / GIRDER
	WINDOW / DOOR HEADER
	POINT LOAD TRANSFER
	POINT LOAD FROM ABOVE BEARING ON BEAM / GIRDER

MAT CLT ONLY. ALL FOOTINGS TO HAVE CONTINUOUS (2) #4 REBAR.

**CONCRETE SLAB REINFORCING SUBSTITUTION OF SYNTHETIC FIBER MIX IN LIEU OF W/F IN NON STRUCTURAL SLABS:**

- NO SUBSTITUTION ALLOWED IN SLABS INSTALLED ON RAISED METAL DECKING
- NO SUBSTITUTION ALLOWED IN SLABS WITH GRADE BEAMS UNLESS A REBAR MAT IS INSTALLED
- NO SUBSTITUTION ALLOWED IF ANY SOILS HAVE BEEN FOUND TO BE EXPANSIVE SOILS ON-SITE
- NO SUBSTITUTION ALLOWED FOR SLAB POURS DIRECTLY ON GRADE. A 4" BASE MATERIAL OF CRUSHED STONE OR WELL DRAINING CLEAN SAND IS REQUIRED FOR SUBSTITUTION
- NO SUBSTITUTION ALLOWED FOR ANY SITES WITH A DCP BLOW COUNT OF 10 OR LESS.
- FIBER MIX VOLUMES MUST BE FOLLOWED PER THE MANUFACTURER'S SPECIFICATIONS



P-0961

**JDS Consulting**  
 DESIGN • ENGINEERING • ARCHITECTURE • SURVEYING

JDS Consulting PLLC, 8600 D JERSEY, CT. RALEIGH, NC 27617 919.480.1075  
 INFO@JDSCONSULTING.NET WWW.JDSCONSULTING.NET

JDS Consulting, PLLC IS NOT LIABLE FOR CHANGES MADE TO BEANS BLUE PRINTS BY CONTRACTOR OR BY OTHERS. DRAWINGS ARE PROVIDED TO CLIENT FOR THEIR USE ONLY. ANY CHANGES TO BE MADE TO ANY DRAWING MUST BE MADE ON A SEPARATE SHEET. DIMENSIONS SHALL GOVERN OVER SCALE, AND CODE SHALL GOVERN OVER DIMENSIONS ON DRAWINGS.

**MATTAMY HOMES**

PROJECT: **SEQUOIA - RH**

LOCATION: **NORTH CAROLINA**

SCALE: 1/8" = 1'-0" FOR 11x17 PAPER, 1/4" = 1'-0" FOR 22x34 PAPER, OR AS NOTED

**mattamyHOMES**

PROJECT NO.: **21901607**

DATE: **11/09/2021** DRAWN BY: **NWS**

SLAB FOUNDATION PLAN

**S.10**

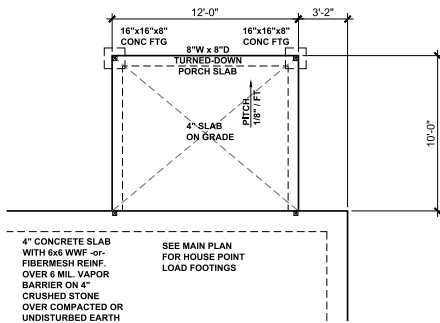

### SCREENED PORCH - MAT RALEIGH

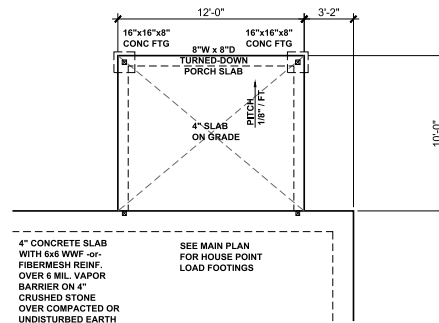

### COVERED VERANDA - BOTH LOCATIONS SCREENED PORCH - MAT CHARLOTTE

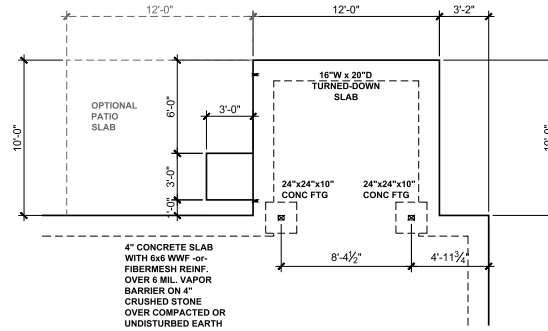

### SUNROOM FOUNDATION

### SLAB FOUNDATION PLAN OPTIONS - FARMHOUSE

SCALE: 1/8" = 1'-0"

BEAM & POINT LOAD LEGEND:	
	LOAD BEARING WALL
	ROOF RAFTER/TRUSS SUPPORT
	DOUBLE RAFTER / DOUBLE JOIST
	STRUCTURAL BEAM / GIRDER
	WINDOW / DOOR HEADER
	POINT LOAD TRANSFER
	POINT LOAD FROM ABOVE BEARING ON BEAM / GIRDER

MAT CLT ONLY: ALL FOOTINGS TO HAVE CONTINUOUS (2) #4 REBAR.

SEE FULL PLAN FOR ADDITIONAL INFORMATION

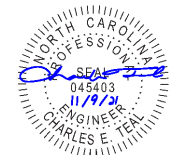

P-0961

**JDS Consulting**  
 DESIGN • ENGINEERING • ARCHITECTURE • ENERGY

JDS Consulting PLLC, 8600 D JERSEY CT, RALEIGH, NC 27617 919.480.1075  
 INFO@JDSCONSULTING.NET WWW.JDSCONSULTING.NET

JDS Consulting, PLLC IS NOT LIABLE FOR CHANGES MADE TO BEANS BLUE PRINTS BY CONTRACTOR OR BY OTHERS. DRAWINGS ARE PROVIDED TO CLIENT FOR THEIR USE ONLY. ANY CHANGES TO PLANS MADE IN THE FIELD SHALL BE THE RESPONSIBILITY OF THE CONTRACTOR. DIMENSIONS SHALL GOVERN OVER DIMENSIONS ON DRAWINGS.

**MATTAMY HOMES**

PROJECT: SEQUOIA - RH

LOCATION: NORTH CAROLINA

SCALE: 1/8" = 1'-0" FOR 11x17 PAPER, 1/4" = 1'-0" FOR 22x34 PAPER, OR AS NOTED

**mattamyHOMES**

PROJECT NO.: 21901607

DATE: 11/09/2021 DRAWN BY: NWS

PLAN OPTIONS  
SLAB FOUNDATION PLANS

**S.11**

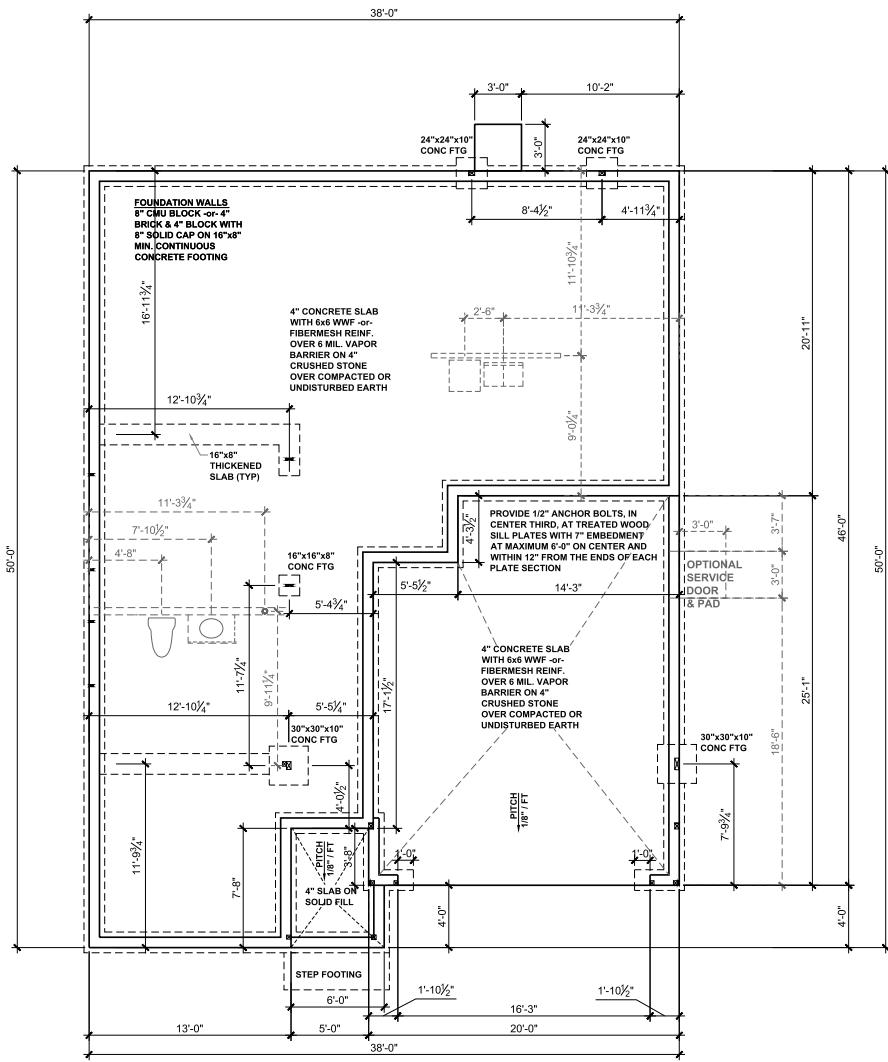

**STEM WALL FOUNDATION PLAN - FARMHOUSE**  
 SCALE: 1/8" = 1'-0"

**BEAM & POINT LOAD LEGEND:**

---	LOAD BEARING WALL
---	ROOF RAFTER/TRUSS SUPPORT
---	DOUBLE RAFTER / DOUBLE JOIST
---	STRUCTURAL BEAM / GIRDER
---	WINDOW / DOOR HEADER
■	POINT LOAD TRANSFER
■	POINT LOAD FROM ABOVE BEARING ON BEAM / GIRDER

MAT CLT ONLY. ALL FOOTINGS TO HAVE CONTINUOUS (2) #4 REBAR.

CONCRETE SLAB REINFORCING SUBSTITUTION OF SYNTHETIC FIBER MIX IN LIEU OF WWF IN NON-STRUCTURAL SLABS.

- NO SUBSTITUTION ALLOWED IN SLABS INSTALLED ON RAISED METAL DECKING
- NO SUBSTITUTION ALLOWED IN SLABS WITH GRADE BEAMS UNLESS A REBAR MAT IS INSTALLED
- NO SUBSTITUTION ALLOWED IF ANY SOILS HAVE BEEN FOUND TO BE EXPANSIVE SOILS ON SITE
- NO SUBSTITUTION ALLOWED FOR SLAB POURS DIRECTLY ON GRADE. A 4" BASE MATERIAL OF CRUSHED STONE OR WELL DRAINING CLEAN SAND IS REQUIRED FOR SUBSTITUTION
- NO SUBSTITUTION ALLOWED FOR ANY SITES WITH A DCP BLOW COUNT OF 10 OR LESS.
- FIBER MIX VOLUMES MUST BE FOLLOWED PER THE MANUFACTURER'S SPECIFICATIONS



P-0961

**JDS Consulting**  
 GEOTECHNICAL ENGINEERING • FOUNDATION • EROSION CONTROL

JDS Consulting PLLC, 8600 D JERSEY, CT. RALEIGH, NC 27617 919.480.1075  
 INFO@JDSCONSULTING.NET, WWW.JDSCONSULTING.NET

JDS Consulting, PLLC IS NOT LIABLE FOR CHANGES MADE TO BEANS BLUE PRINTS BY CONTRACTOR OR BY OTHERS. DRAWINGS ARE PROVIDED TO CLIENT FOR THEIR USE ONLY. DIMENSIONS SHALL GOVERN OVER SCALE, AND CODE SHALL GOVERN OVER DIMENSIONS ON DRAWINGS.

CLIENT: **MATTAMY HOMES**

PROJECT: **SEQUOIA - RH**

LOCATION: **NORTH CAROLINA**

SCALE: 1/8" = 1'-0" FOR 11x17 PAPER, 1/4" = 1'-0" FOR 22x34 PAPER, OR AS NOTED

**mattamy HOMES**

PROJECT NO.: **21901607**

DATE: **11/09/2021** DRAWN BY: **NWS**

STEM WALL FOUNDATION PLAN

**S.20**

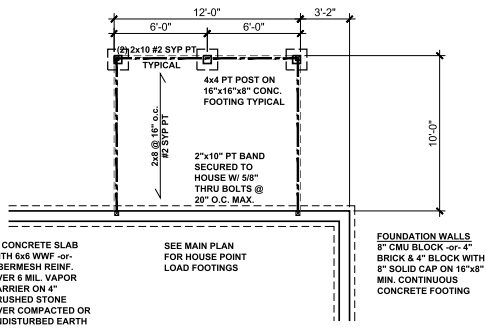

**SCREENED PORCH - MAT RALEIGH**

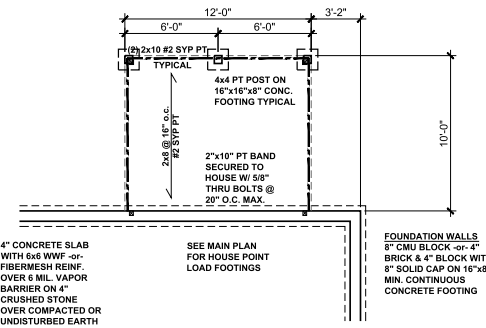

**COVERED VERANDA - BOTH LOCATIONS  
SCREENED PORCH - MAT CHARLOTTE**

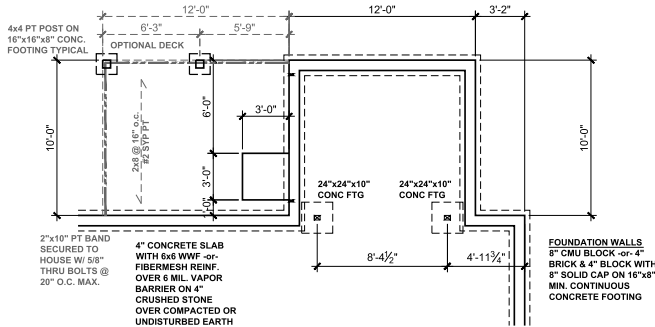

**SUNROOM FOUNDATION**

**STEM WALL FOUNDATION PLAN OPTIONS - FARMHOUSE**

SCALE: 1/8" = 1'-0"

**BEAM & POINT LOAD LEGEND:**

- LOAD BEARING WALL
- - - ROOF RAFTER/TRUSS SUPPORT
- · - · - DOUBLE RAFTER / DOUBLE JOIST
- STRUCTURAL BEAM / GIRDER
- WINDOW / DOOR HEADER
- POINT LOAD TRANSFER
- POINT LOAD FROM ABOVE BEARING ON BEAM / GIRDER

MAT CLT ONLY. ALL FOOTINGS TO HAVE CONTINUOUS (2) #4 REBAR.

SEE FULL PLAN FOR ADDITIONAL INFORMATION



P-0961

**JDS Consulting**  
 DESIGN • ENGINEERING • ARCHITECTURE • ENERGY

JDS Consulting PLLC, 8600 D JERSEY CT, RALEIGH, NC 27617 919.480.1075  
 INFO@JDSCONSULTING.NET WWW.JDSCONSULTING.NET

JDS Consulting, PLLC IS NOT LIABLE FOR CHANGES MADE TO THESE PLANS OR FOR CONSTRUCTION METHODS OR ANY CHANGES TO PLANS MADE IN THE FIELD BY CONTRACTOR OR BY OTHERS. DRAWINGS ARE PROVIDED TO CLIENT FOR THEIR USE ONLY. ALL DIMENSIONS SHALL GOVERN OVER SCALE. AND CODE SHALL GOVERN OVER DIMENSIONS ON DRAWINGS.

**MATTAMY HOMES**

PROJECT: **SEQUOIA - RH**

LOCATION: **NORTH CAROLINA**

SCALE: 1/8" = 1'-0" FOR 11x17 PAPER, 1/4" = 1'-0" FOR 22x34 PAPER, OR AS NOTED

**mattamyHOMES**

PROJECT NO.: **21901607**

DATE: **11/09/2021** DRAWN BY: **NWS**

PLAN OPTIONS  
STEM WALL FDN PLANS

**S.21**

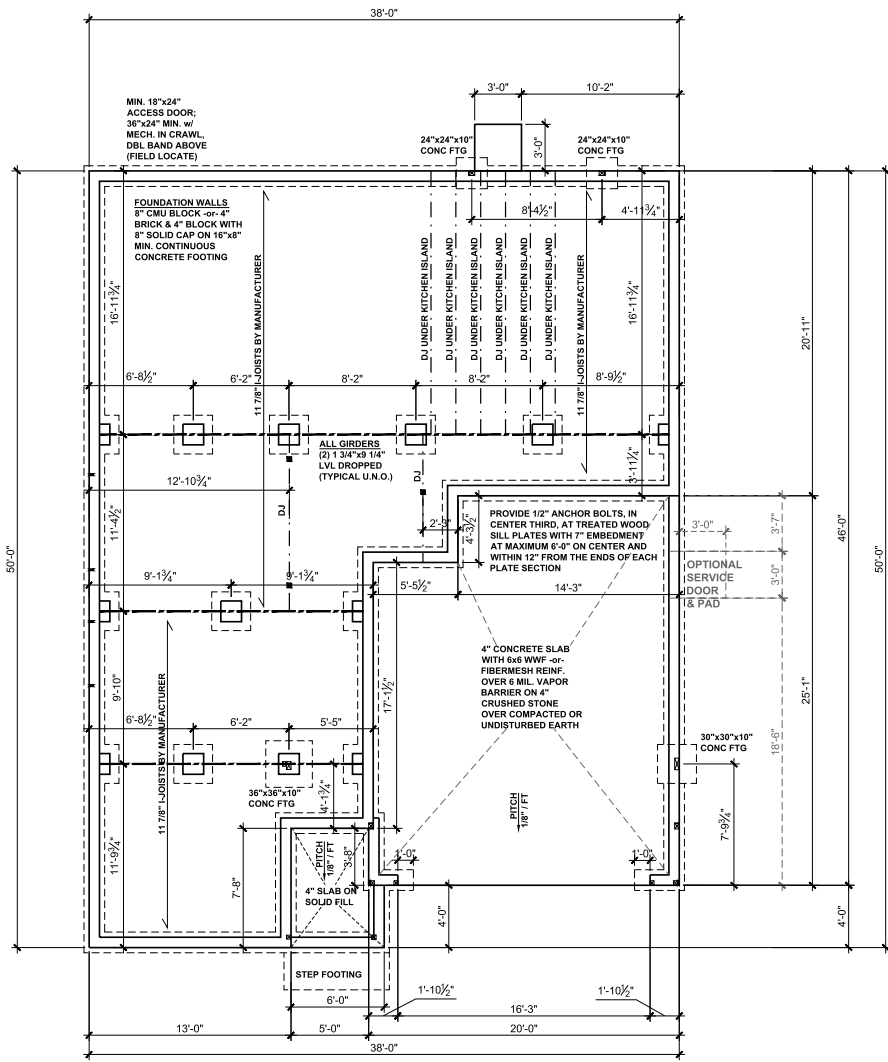

## CRAWLSPACE FOUNDATION PLAN - FARMHOUSE

SCALE: 1/8" = 1'-0"

**BEAM & POINT LOAD LEGEND:**

---	LOAD BEARING WALL
---	ROOF RAFTER/TRUSS SUPPORT
---	DOUBLE RAFTER / DOUBLE JOIST
---	STRUCTURAL BEAM / GIRDER
---	WINDOW / DOOR HEADER
■	POINT LOAD TRANSFER
■	POINT LOAD FROM ABOVE BEARING ON BEAM / GIRDER

MAT CUT ONLY. ALL FOOTINGS TO HAVE CONTINUOUS (2) #4 REBAR.

**CRAWL SPACE VENTILATION**

THE MINIMUM NET AREA OF VENTILATION OPENINGS SHALL NOT BE LESS THAN 1 SQUARE FOOT FOR EACH 150 SQUARE FEET OF UNDERFLOOR SPACE AREA, AND ONE SUCH OPENING SHALL BE WITHIN 3 FEET OF EACH CORNER OF THE BUILDING.

EXCEPTION: THE TOTAL AREA OF VENTILATION MAY BE REDUCED TO 1/1500 OF THE UNDERFLOOR AREA WHERE THE GROUND SURFACE IS TREATED WITH AN APPROVED VAPOR RETARDER MATERIAL AND THE REQUIRED OPENINGS ARE PLACED SO AS TO PROVIDE CROSS-VENTILATION.

1308	SQUARE FEET OF TOTAL CRAWL SPACE / 150 =
872	SQUARE FEET OF NET-FREE VENTILATION REQUIRED

FLOOR FRAMING TO BE 11 7/8" DEEP TJI 210 SERIES OR EQUAL, 19.2" OC MAXIMUM SPACING

"REFER TO I-JOIST EQUIVALENCE CHART ON I-JOIST DETAIL SHEET FOR SUBSTITUTION OF MANUFACTURER SERIES

**FOUNDATION STRUCTURAL NOTES:**

- CONCRETE BLOCK PIER SIZE SHALL BE:

SIZE	HOLLOW MASONRY	SOLID MASONRY
8x16	UP TO 32" HIGH	UP TO 5'-0" HIGH
12x16	UP TO 48" HIGH	UP TO 9'-0" HIGH
16x16	UP TO 64" HIGH	UP TO 12'-0" HIGH
24x24	UP TO 96" HIGH	

WITH 30" x 30" x 16" CONCRETE FOOTING, UNO.

EXTRA JOISTS UNDER ALL NON LOAD BEARING WALLS THAT RUN AT LEAST 30% OF THE JOIST SPAN.

8"x16" PIERS AT FOUNDATION WALL SUPPORTING DROPPED GIRDER TO HAVE A 30"x10"x8" FOOTING PROJECTION FROM THE MAIN WALL FOOTING.

**CONCRETE SLAB REINFORCING SUBSTITUTION OF SYNTHETIC FIBER MIX IN LIEU OF W/F IN NON STRUCTURAL SLABS:**

- NO SUBSTITUTION ALLOWED IN SLABS INSTALLED ON RAISED METAL DECKING
- NO SUBSTITUTION ALLOWED IN SLABS WITH GRADE BEAMS UNLESS A REBAR MAT IS INSTALLED
- NO SUBSTITUTION ALLOWED IF ANY SOILS HAVE BEEN FOUND TO BE EXPANSIVE SOILS ON SITE
- NO SUBSTITUTION ALLOWED FOR SLAB POURS DIRECTLY ON GRADE; A 4" BASE MATERIAL OF CRUSHED STONE OR WELL DRAINING CLEAN SAND IS REQUIRED FOR SUBSTITUTION
- NO SUBSTITUTION ALLOWED FOR ANY SITES WITH A DCP BLOW COUNT OF 10 OR LESS.
- FIBER MIX VOLUMES MUST BE FOLLOWED PER THE MANUFACTURER'S SPECIFICATIONS

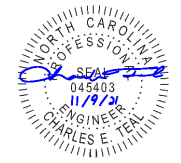

P-0961

**JDS Consulting**  
 DESIGN • ENGINEERING • ARCHITECTURE • ENERGY

JDS Consulting PLLC, 8600 D JERSEY, CT. RALEIGH, NC 27617 919.480.1075  
 INFO@JDSCONSULTING.NET, WWW.JDSCONSULTING.NET

JDS Consulting, PLLC IS NOT LIABLE FOR CHANGES MADE TO PLANS OR FIELD CONSTRUCTION METHODS OR ANY CHANGES TO PLANS MADE IN THE FIELD BY CONTRACTOR OR BY OTHERS. DRAWINGS ARE PROVIDED TO CLIENT FOR THEIR USE ONLY. ALL DIMENSIONS SHALL GOVERN OVER SCALE, AND CODE SHALL GOVERN OVER DIMENSIONS ON DRAWINGS.

**MATTAMY HOMES**

PROJECT: **SEQUOIA - RH**

LOCATION: **NORTH CAROLINA**

SCALE: 1/8" = 1'-0" FOR 11x17 PAPER, 1/4" = 1'-0" FOR 22x34 PAPER, OR AS NOTED.

**mattamyHOMES**

PROJECT NO.: **21901607**

DATE: **11/09/2021** DRAWN BY: **NWS**

CRAWL SPACE FOUNDATION PLAN

**S.30**



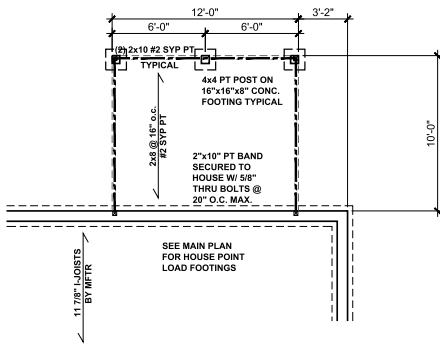

**SCREENED PORCH - MAT RALEIGH**

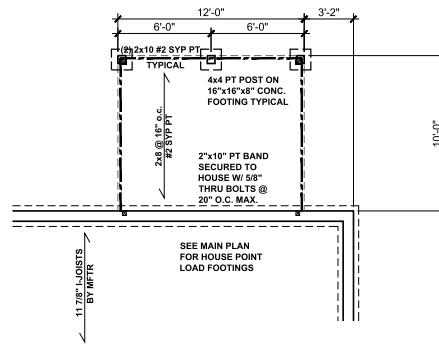

**COVERED VERANDA - BOTH LOCATIONS  
SCREENED PORCH - MAT CHARLOTTE**

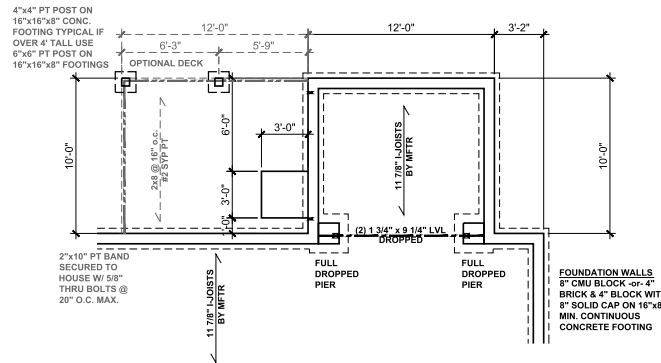

**SUNROOM FOUNDATION**

**CRAWLSPACE FOUNDATION PLAN OPTIONS - FARMHOUSE**

SCALE: 1/8" = 1'-0"

**BEAM & POINT LOAD LEGEND:**

- LOAD BEARING WALL
- - - ROOF RAFTER/TRUSS SUPPORT
- - - DOUBLE RAFTER / DOUBLE JOIST
- STRUCTURAL BEAM / GIRDER
- WINDOW / DOOR HEADER
- POINT LOAD TRANSFER
- POINT LOAD FROM ABOVE BEARING ON BEAM / GIRDER

MAT CLT ONLY. ALL FOOTINGS TO HAVE CONTINUOUS (2) #4 REBAR.

SEE FULL PLAN FOR ADDITIONAL INFORMATION



P-0961

**JDS Consulting**  
 DESIGN • ENGINEERING • ARCHITECTURE • ENERGY

JDS Consulting, PLLC, 8600 D JERSEY CT, RALEIGH, NC 27617 919.480.1075  
 INFO@JDSCONSULTING.NET WWW.JDSCONSULTING.NET

JDS Consulting, PLLC IS NOT LIABLE FOR CHANGES MADE TO THESE PLANS OR FOR CONSTRUCTION METHODS OR ANY CHANGES TO PLANS MADE IN THE FIELD BY CONTRACTOR OR BY OTHERS. DRAWINGS ARE PROVIDED TO CLIENT FOR THEIR USE ONLY. CONTRACTOR SHALL VERIFY ALL DIMENSIONS AND CONDITIONS ON SHEET. DIMENSIONS SHALL GOVERN OVER SCALE. AND CODE SHALL GOVERN OVER DIMENSIONS ON DRAWINGS.

**MATTAMY HOMES**

PROJECT: **SEQUOIA - RH**

LOCATION: **NORTH CAROLINA**

CLIENT: **MATTAMY HOMES**

PROJECT: **SEQUOIA - RH**

LOCATION: **NORTH CAROLINA**

SCALE: 1/8" = 1'-0" FOR 11x17 PAPER, 1/4" = 1'-0" FOR 22x34 PAPER, OR AS NOTED

**mattamyHOMES**

PROJECT NO.: **21901607**

DATE: **11/09/2021** DRAWN BY: **NWS**

PLAN OPTIONS  
CRAWL SPACE FDN PLANS

**S.31**

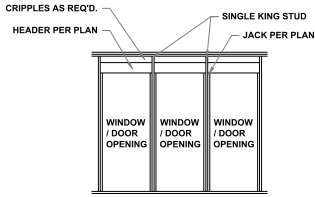

**MULTI HEADER DETAIL**  
SINGLE COMMON KING STUD NTS

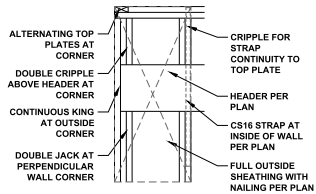

**PORTAL FRAMED OR ENGINEERED OPENING OUTSIDE CORNER DETAIL**  
NTS

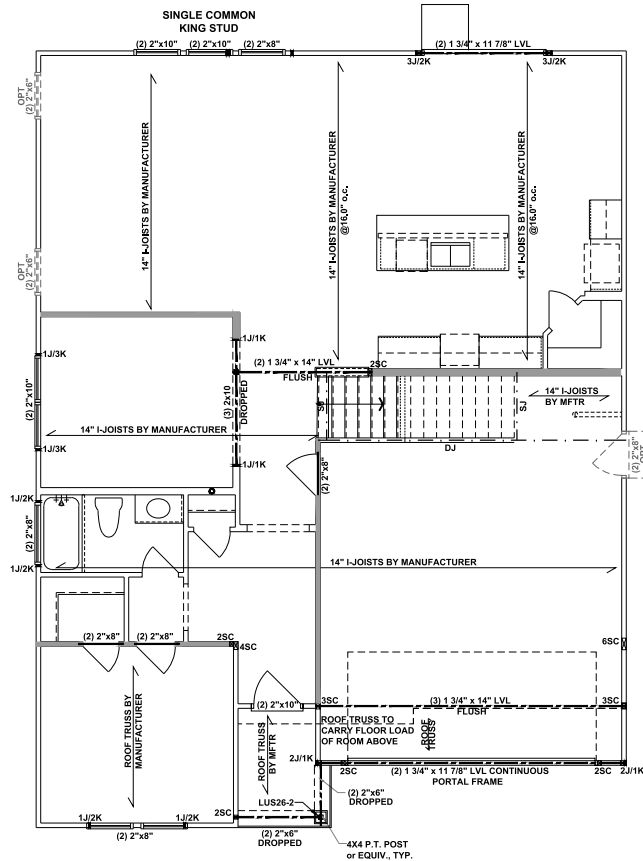

**BEAM & POINT LOAD LEGEND:**

- LOAD BEARING WALL
- - - ROOF RAFTER/TRUSS SUPPORT
- - - DOUBLE RAFTER / DOUBLE JOIST
- - - STRUCTURAL BEAM / GIRDER
- - - WINDOW / DOOR HEADER
- POINT LOAD TRANSFER
- POINT LOAD FROM ABOVE BEARING ON BEAM / GIRDER

- STRUCTURAL FRAMING NOTES - (SEE GENERAL NOTES SHEET FOR ADDITIONAL REQUIREMENTS.)**
- ALL FRAMING TO BE #2 SPF MINIMUM.
  - ALL BEARING HEADERS TO BE (2) 2x6 SUPPORTED w/ MIN (1) JACK AND (1) KING EACH END, UNO.
  - EXTERIOR WALL OPENINGS OVER 3' TO HAVE MULTIPLE KING STUDS AS NOTED ON PLAN.
  - ALL NON-BEARING HEADERS TO BE (2) 2x4 (1) J / (1) K, UNO.
  - PROVIDE CONTINUOUS BLOCKING THROUGH STRUCTURE FOR ALL POINT LOADS.
  - ALL HANGERS AND CONNECTORS SPECIFIED ARE TO BE SIMPSON STRONG-TIE OR EQUIVALENT.
  - ALL BEAMS SPECIFIED ARE MINIMUM SIZES ONLY. LARGER MEMBERS MAY BE SUBSTITUTED AS NEEDED FOR EASE OF CONSTRUCTION. MINIMUM BEAM SUPPORT IS (1) 2x4 STUD.
  - ALL EXTERIOR WALLS TO BE FULLY SHEATHED WITH 7/16" OSB.
  - FRONT PORCH COLUMNS TO BE MIN 4x4 PT ATTACHED AT TOP AND BOTTOM USING SIMPSON (OR EQUIV) COLUMN BASE OR SST A24 BRACKETS. TRIM OUT PER BUILDER.
  - PORCH COLUMNS TO BE MIN 4x4 PT ATTACHED AT BOTTOM USING SIMPSON (OR EQUIV) ABA44 AND AT TOP USING CS 16 STRAPPING (1/2" MIN) TO PORCH HEADER / BAND.
  - WHEN 4-PLY LVL IS USED, ATTACH WITH (1) 1/2" Ø BOLT 12" OC STAGGERED, TOP AND BOTTOM, 1-1/2" MIN FROM ENDS. ALTERNATE ATTACHMENT EQUIVALENT METHOD MAY BE USED, SUCH AS SDW OR TRUSSLOK SCREWS (SEE MANUFACTURER'S SPECIFICATIONS).
  - FOR STUD COLUMNS OF 4 OR MORE, INSTALL SST CS16 STRAPS @ 30" OC, 6" MAX FROM PLATES, ON INSIDE FACE OF COLUMN (EXTERIOR WALL), ON BOTH FACES OF COLUMN (INTERIOR WALL).

"REFER TO I-JOIST EQUIVALENCE CHART ON I-JOIST DETAIL SHEET FOR SUBSTITUTION OF MANUFACTURER SERIES"

FLOOR FRAMING TO BE 14" DEEP TJI 210 SERIES OR EQUAL, 19.2" OC MAXIMUM SPACING UNLESS OTHERWISE NOTED ON THE PLAN

ALL FLUSH BEAMS TO BE DIRECTLY SUPPORTED BY (2) 2X STUDS UNLESS OTHERWISE NOTED. STUD COLUMNS TO BE SUPPORTED BY SOLID BLOCKING TO FOUNDATION OR TO BEARING COMPONENT BELOW.

EXTRA JOISTS UNDER ALL NON LOAD BEARING WALLS THAT RUN AT LEAST 30% OF THE JOIST SPAN.



P-0961

**JDS Consulting**  
DESIGN • ENGINEERING • ARCHITECTURE • ENERGY

JDS Consulting, PLLC, 8600 D JERSEY CT, RALEIGH, NC 27617 919-480-1075  
INFO@JDSCONSULTING.NET WWW.JDSCONSULTING.NET

JDS Consulting, PLLC IS NOT LIABLE FOR CHANGES MADE TO BEANS BLUE PRINTS BY CONTRACTOR OR BY OTHERS. DRAWINGS ARE PROVIDED TO CLIENT FOR THEIR USE ONLY. ANY CHANGES TO BE MADE TO ANY DRAWING MUST BE MADE ON A SEPARATE SHEET. DIMENSIONS SHALL COVER OVER SCALE, AND CODE SHALL GOVERN OVER DIMENSIONS ON DRAWINGS.

**MATTAMY HOMES**

PROJECT: **SEQUIOIA - RH**

LOCATION: **NORTH CAROLINA**

CLIENT: **MATTAMY HOMES**

PROJECT: **SEQUIOIA - RH**

LOCATION: **NORTH CAROLINA**

SCALE: 1/8" = 1'-0" FOR 11x17 PAPER, 1/4" = 1'-0" FOR 22x34 PAPER, OR AS NOTED

**mattamyHOMES**

PROJECT NO.: **21901607**

DATE: **11/09/2021** DRAWN BY: **NWS**

FIRST FLOOR I-JOIST CEILING FRAMING PLAN

**S1.0**

**FIRST FLOOR CEILING FRAMING PLAN - FARMHOUSE**  
SCALE: 1/8" = 1'-0"

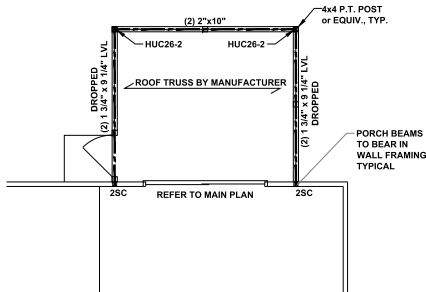

**SCREENED PORCH - MAT RALEIGH**

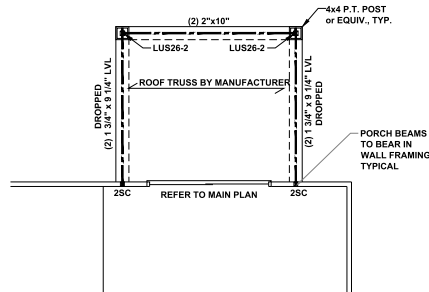

**COVERED PORCH - BOTH LOCATIONS  
SCREENED PORCH - MAT CHARLOTTE**

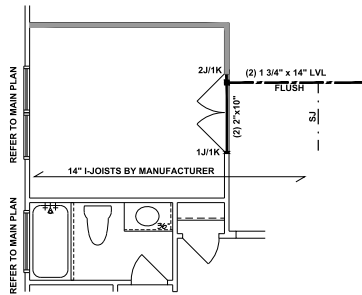

**STUDY FRAMING**

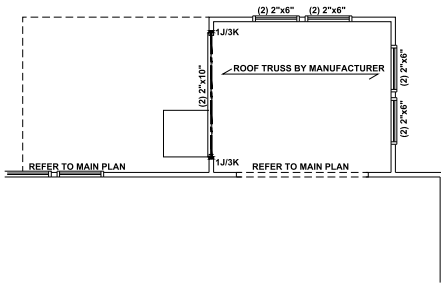

**SUNROOM FRAMING**

**FIRST FLOOR CEILING FRAMING PLAN - FARMHOUSE**

SCALE: 1/8" = 1'-0"

**BEAM & POINT LOAD LEGEND:**

- LOAD BEARING WALL
- - - ROOF RAFTER/TRUSS SUPPORT
- - - DOUBLE RAFTER / DOUBLE JOIST
- STRUCTURAL BEAM / GIRDER
- WINDOW / DOOR HEADER
- POINT LOAD TRANSFER
- POINT LOAD FROM ABOVE BEARING ON BEAM / GIRDER

**STRUCTURAL FRAMING NOTES - (SEE GENERAL NOTES SHEET FOR ADDITIONAL REQUIREMENTS.)**

- ALL FRAMING TO BE #2 SPF MINIMUM.
- ALL BEARING HEADERS TO BE (2) 2x6 SUPPORTED w/ MIN (1) JACK AND (1) KING EACH END, UNO.
- EXTERIOR WALL OPENINGS OVER 3' TO HAVE MULTIPLE KING STUDS AS NOTED ON PLAN.
- ALL NON-BEARING HEADERS TO BE (2) 2x4 (1) J / (1) K, UNO.
- PROVIDE CONTINUOUS BLOCKING THROUGH STRUCTURE FOR ALL POINT LOADS.
- ALL HANGERS AND CONNECTORS SPECIFIED ARE TO BE SIMPSON STRONG-TIE OR EQUIVALENT.
- ALL BEAMS SPECIFIED ARE MINIMUM SIZES ONLY. LARGER MEMBERS MAY SUBSTITUTED AS NEEDED FOR EASE OF CONSTRUCTION. MINIMUM BEAM SUPPORT IS (1) 2x4 STUD.
- ALL EXTERIOR WALLS TO BE FULLY SHEATHED WITH 7/16" OSB.
- FRONT PORCH COLUMNS TO BE MIN 4x4 PT ATTACHED AT TOP AND BOTTOM USING SIMPSON (OR EQUIV) COLUMN BASE OR SST A24 BRACKETS. TRIM OUT PER BUILDER.
- PORCH COLUMNS TO BE MIN 4x4 PT ATTACHED AT BOTTOM USING SIMPSON (OR EQUIV) AB444 AND AT TOP USING CS 16 STRAPPING (12" MIN) TO PORCH HEADER / BAND.
- WHEN A 4-PLY LVL IS USED, ATTACH WITH (1) 1/2" Ø BOLT 12" OC STAGGERED, TOP AND BOTTOM, 1-1/2" MIN FROM ENDS. ALTERNATE ATTACHMENT EQUIVALENT METHOD MAY BE USED, SUCH AS SDW OR TRUSSLOK SCREWS (SEE MANUFACTURER'S SPECIFICATIONS).
- FOR STUD COLUMNS OF 4 OR MORE, INSTALL SST CS16 STRAPS @ 30" OC, 6" MAX FROM PLATES, ON INSIDE FACE OF COLUMN (EXTERIOR WALL), ON BOTH FACES OF COLUMN (INTERIOR WALL).

**TRUSSED FLOOR - STRUCTURAL NOTES**

- PROVIDE CONTINUOUS BLOCKING THROUGH STRUCTURE FOR ALL POINT LOADS.
- TRUSS LAYOUT AND PLACEMENT BY MANUFACTURER TO COINCIDE WITH THE SUPPORT LOCATIONS SHOWN. TRUSS PROFILES SHALL BE SEALED BY THE TRUSS MANUFACTURER. TRUSS PLANS TO BE COORDINATED WITH THE SEALED STRUCTURAL DRAWINGS. INSTALLATION SHALL BE IN ACCORDANCE WITH THE MANUFACTURER'S INSTRUCTIONS.
- ALL TRUSS-TO-TRUSS CONNECTIONS SHALL BE SPECIFIED BY THE TRUSS MANUFACTURER AND INCLUDED IN THE TRUSS PROFILES.

SEE FULL PLAN FOR ADDITIONAL INFORMATION



P-0961

**JDS Consulting**  
 DESIGN • ENGINEERING • ARCHITECTURE • ENERGY  
 JDS Consulting PLLC, 8600 D JERSEY CT, RALEIGH, NC 27617 919.480.1075  
 INFO@JDSCONSULTING.NET WWW.JDSCONSULTING.NET

JDS Consulting PLLC IS NOT LIABLE FOR CHANGES MADE TO BEANS BLUE PRINTS BY CONTRACTOR OR BY OTHERS. DRAWINGS ARE PROVIDED TO CLIENT FOR THEIR USE ONLY. ALL DIMENSIONS SHALL GOVERN OVER DIMENSIONS ON DRAWINGS.

**MATTAMY HOMES**  
 PROJECT: SEQUOIA - RH  
 LOCATION: NORTH CAROLINA

SCALE: 1/8" = 1'-0" FOR 11x17 PAPER, 1/4" = 1'-0" FOR 22x34 PAPER, OR AS NOTED

**mattamyHOMES**

PROJECT NO.: 21901607

DATE: 11/09/2021 DRAWN BY: NWS

FIRST FLOOR TRUSS CEILING FRAMING PLANS

**S1.1**

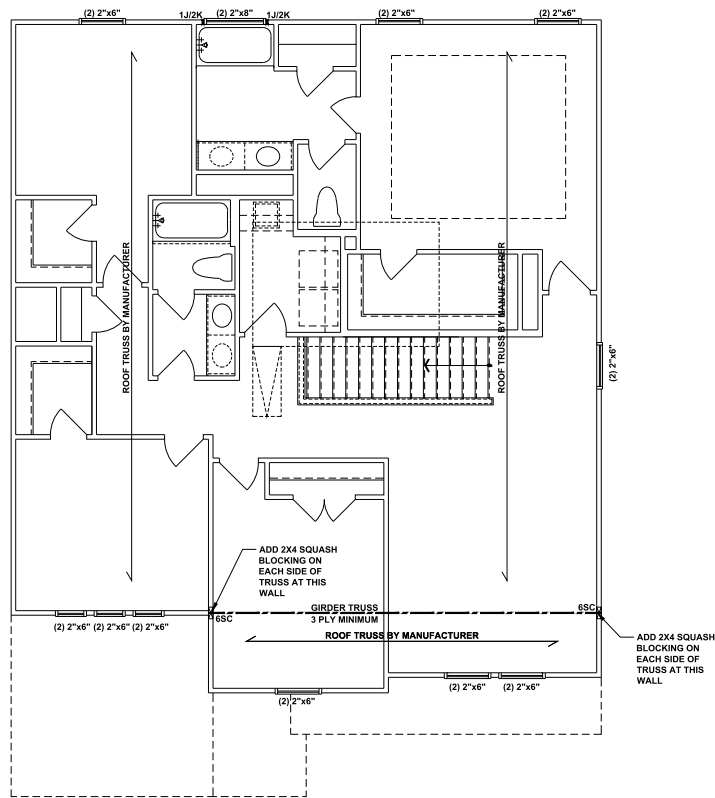

## SECOND FLOOR CEILING FRAMING PLAN - FARMHOUSE

SCALE: 1/8" = 1'-0"

**BEAM & POINT LOAD LEGEND:**

—	LOAD BEARING WALL
- - -	ROOF RAFTER/TRUSS SUPPORT
- · - · -	DOUBLE RAFTER / DOUBLE JOIST
— · — · —	STRUCTURAL BEAM / GIRDER
— · —	WINDOW / DOOR HEADER
■	POINT LOAD TRANSFER
■	POINT LOAD FROM ABOVE BEARING ON BEAM / GIRDER

**STRUCTURAL FRAMING NOTES - (SEE GENERAL NOTES SHEET FOR ADDITIONAL REQUIREMENTS.)**

- ALL FRAMING TO BE #2 SPF MINIMUM.
- ALL BEARING HEADERS TO BE (2) 2x6 SUPPORTED W/ MIN (1) JACK AND (1) KING EACH END, UNO.
- EXTERIOR WALL OPENINGS OVER 3' TO HAVE MULTIPLE KING STUDS AS NOTED ON PLAN.
- ALL NON-BEARING HEADERS TO BE (2) 2x4 (1) J / (1) K, UNO.
- PROVIDE CONTINUOUS BLOCKING THROUGH STRUCTURE FOR ALL POINT LOADS.
- ALL HANGERS AND CONNECTORS SPECIFIED ARE TO BE SIMPSON STRONG-TIE OR EQUIVALENT.
- ALL BEAMS SPECIFIED ARE MINIMUM SIZES ONLY. LARGER MEMBERS MAY SUBSTITUTED AS NEEDED FOR EASE OF CONSTRUCTION. MINIMUM BEAM SUPPORT IS (1) 2x4 STUD.
- ALL EXTERIOR WALLS TO BE FULLY SHEATHED WITH 7/16" OSB.
- FRONT PORCH COLUMNS TO BE MIN 4x4 PT ATTACHED AT TOP AND BOTTOM USING SIMPSON (OR EQUIV) COLUMN BASE OR SST A24 BRACKETS. TRIM OUT PER BUILDER.
- PORCH COLUMNS TO BE MIN 4x4 PT ATTACHED AT BOTTOM USING SIMPSON (OR EQUIV) ABA44 AND AT TOP USING CS 16 STRAPPING (12" MIN) TO PORCH HEADER / BAND.
- WHEN A 4-PLY LVL IS USED, ATTACH WITH (1) 1/2" Ø BOLT 12" OC STAGGERED, TOP AND BOTTOM, 1-1/2" MIN FROM ENDS. ALTERNATE ATTACHMENT EQUIVALENT METHOD MAY BE USED, SUCH AS SDW OR TRUSSLOK SCREWS (SEE MANUFACTURER'S SPECIFICATIONS).
- FOR STUD COLUMNS OF 4 OR MORE, INSTALL SST CS16 STRAPS @ 30" OC, 6" MAX FROM PLATES, ON INSIDE FACE OF COLUMN (EXTERIOR WALL), ON BOTH FACES OF COLUMN (INTERIOR WALL).

ALL FLUSH BEAMS TO BE DIRECTLY SUPPORTED BY (2) 2X STUDS UNLESS OTHERWISE NOTED. STUD COLUMNS TO BE SUPPORTED BY SOLID BLOCKING TO FOUNDATION OR TO BEARING COMPONENT BELOW.

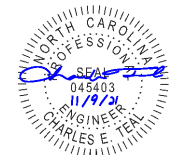

P-0961



JDS Consulting, Inc. is not liable for changes made to these plans by contractor or by others. Drawings are provided to client for their use only. Dimensions shall govern over scale, and code shall govern over dimensions on drawings.



CLIENT: **MATTAMY HOMES**

PROJECT: **SEQUOIA - RH**

LOCATION: **NORTH CAROLINA**

SCALE: 1/8" = 1'-0" FOR 11x17 PAPER, 1/4" = 1'-0" FOR 22x34 PAPER, OR AS NOTED



PROJECT NO.: **21901607**

DATE: **11/09/2021** DRAWN BY: **NWS**

SECOND FLOOR CEILING FRAMING PLAN

**S2.0**

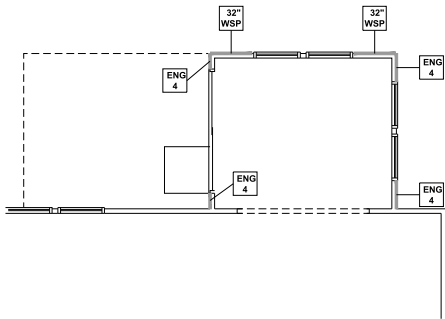

## SUNROOM WALL BRACING

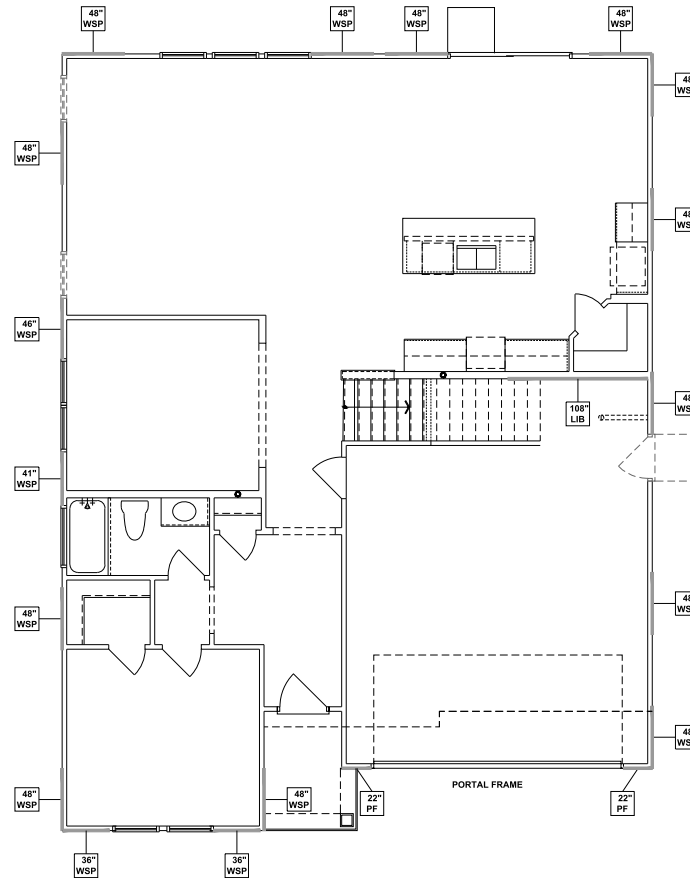

## FIRST FLOOR WALL BRACING PLAN - FARMHOUSE

SCALE: 1/8" = 1'-0"

### WALL BRACING REQUIREMENTS

- MINIMUM PANEL WIDTH IS 24"
- FIGURES BASED ON THE CONTINUOUS SHEATHING METHOD USING THE RECTANGLE CIRCUMSCRIBED AROUND THE FLOOR PLAN OR PORTION OF THE FLOOR PLAN. IF NO RECTANGLE IS NOTED, THE STRUCTURE HAS BEEN FIGURED ALL WITHIN ONE RECTANGLE.
- PANELS MAY SHIFT UP TO 36" EITHER DIRECTION FOR EASE OF CONSTRUCTION (NAILING & BLOCK REQUIREMENTS STILL APPLY).
- FOR ADDITIONAL WALL BRACING INFORMATION, REFER TO WALL BRACING DETAIL SHEET(S).
- SCHEMATIC BELOW INDICATES HOW SIDES OF RECTANGLE ARE TO BE INTERPRETED IN BRACING CHART WHEN APPLIED TO STRUCTURE.



- ◆ CS16 STRAP FROM STUD, CROSS HEADER, TO WALL TOP PLATE, 36" LONG MINIMUM
- ▶ SIMPSON MSTA15 HOLD DOWN CAPACITY OF 970 POUNDS PER ANCHOR WITH (12) 10d NAILS. STRAP TO BE LOCATED AT EDGE OF BRACED WALL PANEL. (CS16 STRAPPING MAY BE SUBSTITUTED w/ SIMILAR LENGTH AND NAILING PATTERN.) USE HT14 FOR ATTACHMENT TO CONCRETE.

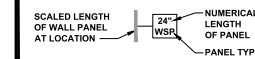

### WALL BRACING NOTE:

WALLS WITH REQUIRED LENGTH LISTED AS "N/A" DO NOT MEET THE REQUIREMENTS OF PRESCRIPTIVE WALL BRACING FOUND IN THE NCR. THESE WALLS HAVE BEEN ENGINEERED BASED ON DESIGN GUIDELINES ESTABLISHED IN ASCE-07 AND THE NDS: WIND & SEISMIC PROVISIONS SUPPLEMENT.

### WALL BRACING: RECTANGLE 1

SIDE	REQUIRED LENGTH	PROVIDED LENGTH
FRONT	14.5 FT.	16.25 FT.
RIGHT	12.0 FT.	20.0 FT.
REAR	14.5 FT.	16.0 FT.
LEFT	12.0 FT.	19.25 FT.

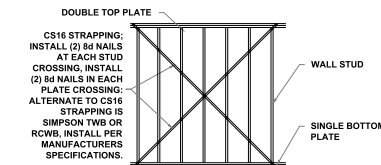

DOUBLE TOP PLATE  
CS16 STRAPPING:  
INSTALL (2) 8d NAILS  
AT EACH STUD  
CROSSING, INSTALL  
(2) 8d NAILS IN EACH  
PLATE CROSSING.  
ALTERNATE TO CS16  
STRAPPING IS  
SIMPSON TWB OR  
RCWB, INSTALL PER  
MANUFACTURERS  
SPECIFICATIONS.

### CROSS BRACED LIB CS16 STRAPPING METHOD

SCALE: 1/4" = 1'-0" STRAP ANGLES TO BE NO MORE THAN 60° AND NO LESS THAN 45°



P-0961

**JDS Consulting**  
 DESIGN • ENGINEERING • ARCHITECTURE • ENERGY  
 JDS Consulting PLLC, 8600 D JERSEY CT, RALEIGH, NC 27617 919.480.1075  
 INFO@JDSCONSULTING.NET WWW.JDSCONSULTING.NET  
 JDS Consulting PLLC IS NOT LIABLE FOR CHANGES MADE TO BEANS BLUE PRINTS OR FOR CONSTRUCTION METHODS OR ANY CHANGES TO PLANS MADE IN THE FIELD BY CONTRACTOR OR BY OTHERS. DRAWINGS ARE PROVIDED TO CLIENT FOR THEIR USE ONLY. ALL DIMENSIONS SHALL GOVERN OVER SCALE, AND CODE SHALL GOVERN OVER DIMENSIONS ON DRAWINGS.

**MATTAMY HOMES**  
 PROJECT: SEQUOIA - RH  
 LOCATION: NORTH CAROLINA  
 CLIENT: MATTAMY HOMES  
 PROJECT: SEQUOIA - RH  
 LOCATION: NORTH CAROLINA  
 SCALE: 1/8" = 1'-0" FOR 11x17 PAPER, 1/4" = 1'-0" FOR 22x34 PAPER, OR AS NOTED

**mattamyHOMES**  
 PROJECT NO.: 21901607  
 DATE: 11/09/2021 DRAWN BY: NWS  
 FIRST FLOOR  
 WALL BRACING PLAN  
**S4.0**

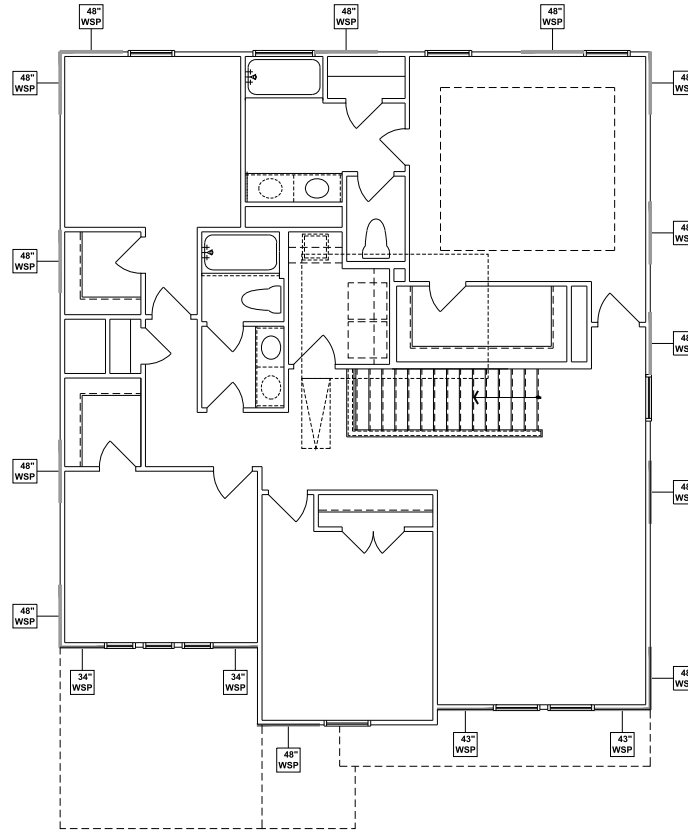

## SECOND FLOOR WALL BRACING PLAN - FARMHOUSE

SCALE: 1/8" = 1'-0"

### WALL BRACING REQUIREMENTS

- MINIMUM PANEL WIDTH IS 24"
- FIGURES BASED ON THE CONTINUOUS SHEATHING METHOD USING THE RECTANGLE CIRCUMSCRIBED AROUND THE FLOOR PLAN OR PORTION OF THE FLOOR PLAN. IF NO RECTANGLE IS NOTED, THE STRUCTURE HAS BEEN FIGURED ALL WITHIN ONE RECTANGLE.
- PANELS MAY SHIFT UP TO 36" EITHER DIRECTION FOR EASE OF CONSTRUCTION (NAILING & BLOCK REQUIREMENTS STILL APPLY).
- FOR ADDITIONAL WALL BRACING INFORMATION, REFER TO WALL BRACING DETAIL SHEET(S).
- SCHEMATIC BELOW INDICATES HOW SIDES OF RECTANGLE ARE TO BE INTERPRETED IN BRACING CHART WHEN APPLIED TO STRUCTURE:



- CS16 STRAP FROM STUD, CROSS HEADER, TO WALL TOP PLATE, 36" LONG MINIMUM
- SIMPSON MSTA15 HOLD DOWN CAPACITY OF 970 POUNDS PER ANCHOR WITH (12) 10d NAILS. STRAP TO BE LOCATED AT EDGE OF BRACED WALL PANEL. (CS16 STRAPPING MAY BE SUBSTITUTED w/ SIMILAR LENGTH AND NAILING PATTERN.) USE HTT4 FOR ATTACHMENT TO CONCRETE.

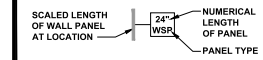

### WALL BRACING NOTE:

WALLS WITH REQUIRED LENGTH LISTED AS "N/A" DO NOT MEET THE REQUIREMENTS OF PRESCRIPTIVE WALL BRACING FOUND IN THE N.C. THESE WALLS HAVE BEEN ENGINEERED BASED ON DESIGN GUIDELINES ESTABLISHED IN ASCE-07 AND THE NDS; WIND & SEISMIC PROVISIONS SUPPLEMENT.

### WALL BRACING: RECTANGLE 1

SIDE	REQUIRED LENGTH	PROVIDED LENGTH
FRONT	7.0 FT.	16.8 FT.
RIGHT	6.0 FT.	20.0 FT.
REAR	7.0 FT.	12.0 FT.
LEFT	6.0 FT.	20.0 FT.



P-0961



JDS Consulting, Inc. 8600 D JERSEY CT. RALEIGH, NC 27617 919.480.1075  
 INFO@JDSCONSULTING.NET WWW.JDSCONSULTING.NET

JDS CONSULTING, INC. IS NOT LIABLE FOR DAMAGES MADE TO BEANS RULE. THE CONSTRUCTION METHODS OR ANY CHANGES TO PLANS MADE IN THE FIELD BY CONTRACTOR OR BY OTHERS. DRAWINGS ARE PROVIDED TO CLIENT FOR THEIR USE ONLY. THESE DRAWINGS SHALL GOVERN OVER SCALE AND CODE SHALL GOVERN OVER DIMENSIONS ON DRAWINGS.



CLIENT: **MATTAMY HOMES**

PROJECT: **SEQUOIA - RH**

LOCATION: **NORTH CAROLINA**

SCALE: 1/8" = 1'-0" FOR 11x17 PAPER, 1/4" = 1'-0" FOR 22x34 PAPER, OR AS NOTED



PROJECT NO.: **21901607**

DATE: **11/09/2021**

DRAWN BY: **NWS**

SECOND FLOOR  
 WALL BRACING PLAN

**S5.0**

# SUNROOM AND COVERED & SCREENED PORCH

SCALE: 1/8" = 1'-0"

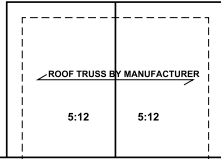

**ATTIC VENTILATION COVERED OPTION**

THE TOTAL NET-FREE VENTILATION AREA SHALL NOT BE LESS THAN 1/150 OF THE AREA OF THE ATTIC SPACE TO BE VENTILATED. THE TOTAL VENTILATION MAY BE REDUCED TO 1/300 PROVIDED AT LEAST 50% BUT NOT MORE THAN 80% OF THE REQUIRED VENTILATION BE LOCATED IN THE UPPER PORTION OF THE AREA TO BE VENTILATED, OR AT LEAST 3' ABOVE THE SOFFIT VENTILATION INTAKE.

120 SQUARE FEET OF TOTAL ATTIC / 150 =  
0.80 SQUARE FEET OF NET-FREE VENTILATION REQUIRED

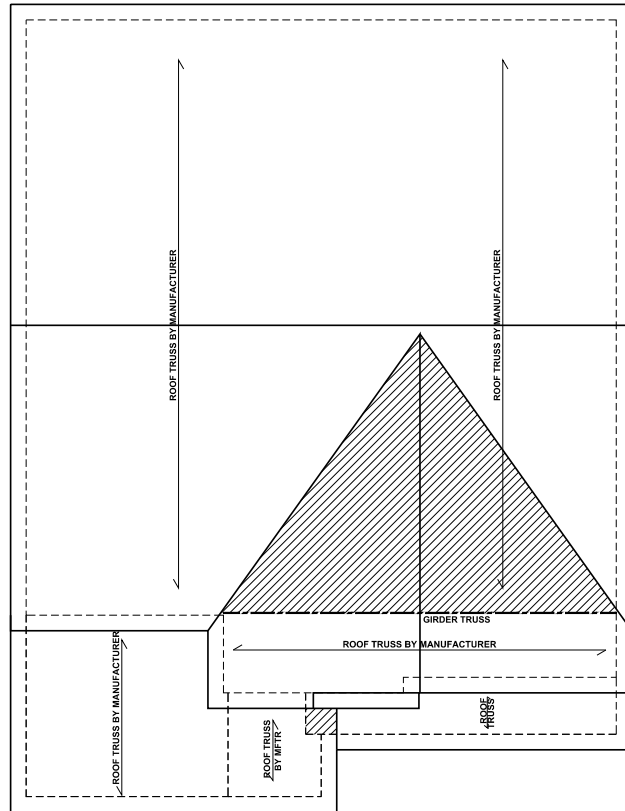

# ROOF FRAMING PLAN - FARMHOUSE

SCALE: 1/8" = 1'-0"

**BEAM & POINT LOAD LEGEND:**

- LOAD BEARING WALL
- - - ROOF RAFTER/TRUSS SUPPORT
- - - DOUBLE RAFTER / DOUBLE JOIST
- STRUCTURAL BEAM / GIRDER
- WINDOW / DOOR HEADER
- POINT LOAD TRANSFER
- POINT LOAD FROM ABOVE BEARING ON BEAM / GIRDER

- TRUSSED ROOF - STRUCTURAL NOTES**
- PROVIDE CONTINUOUS BLOCKING THROUGH STRUCTURE FOR ALL POINT LOADS.
  - DENOTES OVER-FRAMED AREA
  - MINIMUM 7/16" OSB ROOF SHEATHING
  - TRUSS LAYOUT AND PLACEMENT BY THE SUPPORT LOCATIONS SHOWN. TRUSS PROFILES SHALL BE SEALED BY THE TRUSS MANUFACTURER. TRUSS PLANS TO BE COORDINATED WITH THE SEALED STRUCTURAL DRAWINGS. INSTALLATION SHALL BE IN ACCORDANCE WITH THE MANUFACTURER'S INSTRUCTIONS.
  - MANUFACTURER TO PROVIDE REQUIRED UPLIFT CONNECTION.
  - PROVIDE H2.5A (MINIMUM) OR EQUIVALENT AT EACH TRUSS-TO-TOP PLATE CONNECTION AT OVER-FRAMED AREAS, UNLESS NOTED OTHERWISE.
  - UPLIFT CONNECTION TO BE CARRIED THROUGH TO FLOOR SYSTEM.

**TRUSS UPLIFT CONNECTORS: EXPOSURE B, 115 MPH, ANY PITCH, 24" O.C. MAX ROOF TRUSS SPACING.**

TRUSSES SHALL BE ATTACHED TO SUPPORT WALL FOR UPLIFT RESISTANCE. CONTINUOUS OSB WALL SHEATHING BELOW PROVIDES CONTINUOUS UPLIFT RESISTANCE TO FOUNDATION. ALL TRUSSES SUPPORTED BY INTERMEDIATE SUPPORT WALLS, KNEEWALLS, OR BEAMS SHALL BE ATTACHED TO SUPPORTING MEMBER PER SCHEDULE.

ROOF SPAN IS MEASURED HORIZONTALLY BETWEEN FURTHEST SUPPORT POINTS.

<b>ROOF PLAN UP TO 28'</b>	CONNECTOR NAILING PER TABLE 602.3(1) NCRBC 2018 EDITION
<b>OVER 28'</b>	(1) SIMPSON H2.5A HURRICANE CLIP TO DBL TOP PLATE OR BEAM OR (1) SIMPSON H3 CLIP TO SINGLE 2x4 PLATE

**ATTIC VENTILATION**

THE TOTAL NET-FREE VENTILATION AREA SHALL NOT BE LESS THAN 1/150 OF THE AREA OF THE ATTIC SPACE TO BE VENTILATED. THE TOTAL VENTILATION MAY BE REDUCED TO 1/300 PROVIDED AT LEAST 50% BUT NOT MORE THAN 80% OF THE REQUIRED VENTILATION BE LOCATED IN THE UPPER PORTION OF THE AREA TO BE VENTILATED, OR AT LEAST 3' ABOVE THE SOFFIT VENTILATION INTAKE.

1824 SQUARE FEET OF TOTAL ATTIC / 150 =  
12.16 SQUARE FEET OF NET-FREE VENTILATION REQUIRED



P-0961

**JDS Consulting**  
 DESIGN • ENGINEERING • ARCHITECTURE • ENERGY

JDS Consulting PLLC, 8600 D JERSEY CT, RALEIGH, NC 27617 919.480.1075  
 INFO@JDSCONSULTING.NET, WWW.JDSCONSULTING.NET

JDS Consulting, PLLC IS NOT LIABLE FOR CHANGES MADE TO THESE PLANS BY THE FIELD CONTRACTOR OR BY OTHERS. DRAWINGS ARE PROVIDED TO CLIENT FOR THEIR USE ONLY. ALL DIMENSIONS SHALL GOVERN OVER SCALE, AND CODE SHALL GOVERN OVER DIMENSIONS ON DRAWINGS.

**MATTAMY HOMES**

CLIENT: **MATTAMY HOMES**

PROJECT: **SEQUIOIA - RH**

LOCATION: **NORTH CAROLINA**

SCALE: 1/8" = 1'-0" FOR 11x17 PAPER, 1/4" = 1'-0" FOR 22x34 PAPER, OR AS NOTED

**mattamyHOMES**

PROJECT NO.: **21901607**

DATE: **11/09/2021** DRAWN BY: **NWS**

ROOF FRAMING PLAN

**S7.0**