

**ENERGY COMPLIANCE**  
 ZONE 3A = MAX. GLAZING U-FACTOR .35  
 R-VALUE = CEILING: R38, WALLS: R5,  
 FLOORS: R19  
 ZONE 4A = MAX. GLAZING U-FACTOR .35  
 R-VALUE = CEILING: R38, WALLS: R5,  
 FLOORS: R19

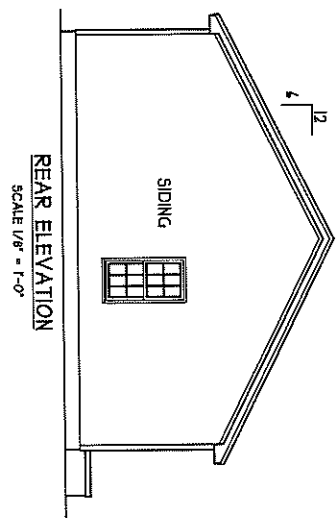

**ATTIC VENTILATION:**

THE NET FREE VENTILATING AREA SHALL BE NOT LESS EXCEPT THAT THE AREA MAY BE 1 TO 300, PROVIDED AT LEAST 50 PERCENT OF THE REQUIRED VENTILATING AREA IS PROVIDED BY VENTILATORS LOCATED IN THE UPPER PORTION OF THE SPACE TO BE VENTILATED, AT LEAST 3 FEET ABOVE THE SPACE TO BE VENTILATED WITH THE BALANCE AVE OR CORNICE VENTS.  
 GROSS ATTIC AREA TO BE VENTILATED 1228 SQ.FT.  
 1228/150 = 818 SQ.FT. NET FREE AREA

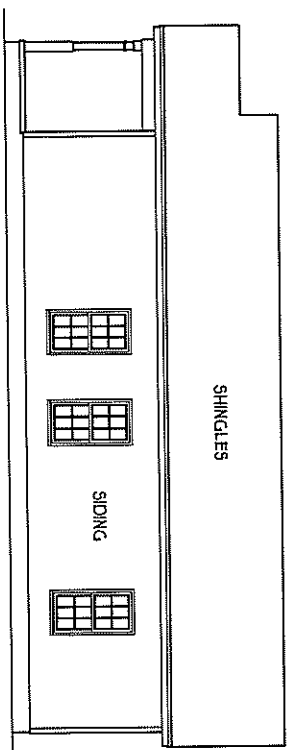
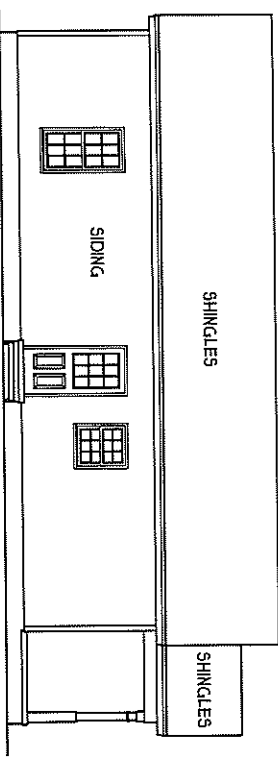

DATE: 12/01/2021 BY: JH	PROJECT: THE BENTLEY 1 STORY	<b>H SQUARED HOME DESIGN, INC.</b>	HEATHER HALL 185 HEATHERSTONE CT BENSON NC 27504 1919 207-403	SQUARE FOOTAGE: FIRST FLOOR = 120 FRONT PORCH = 108	HEATED FOOTAGE: <b>#1120</b>	<b>THE BENTLEY</b> <b>JRT MANG. PROP.</b>
			070821			

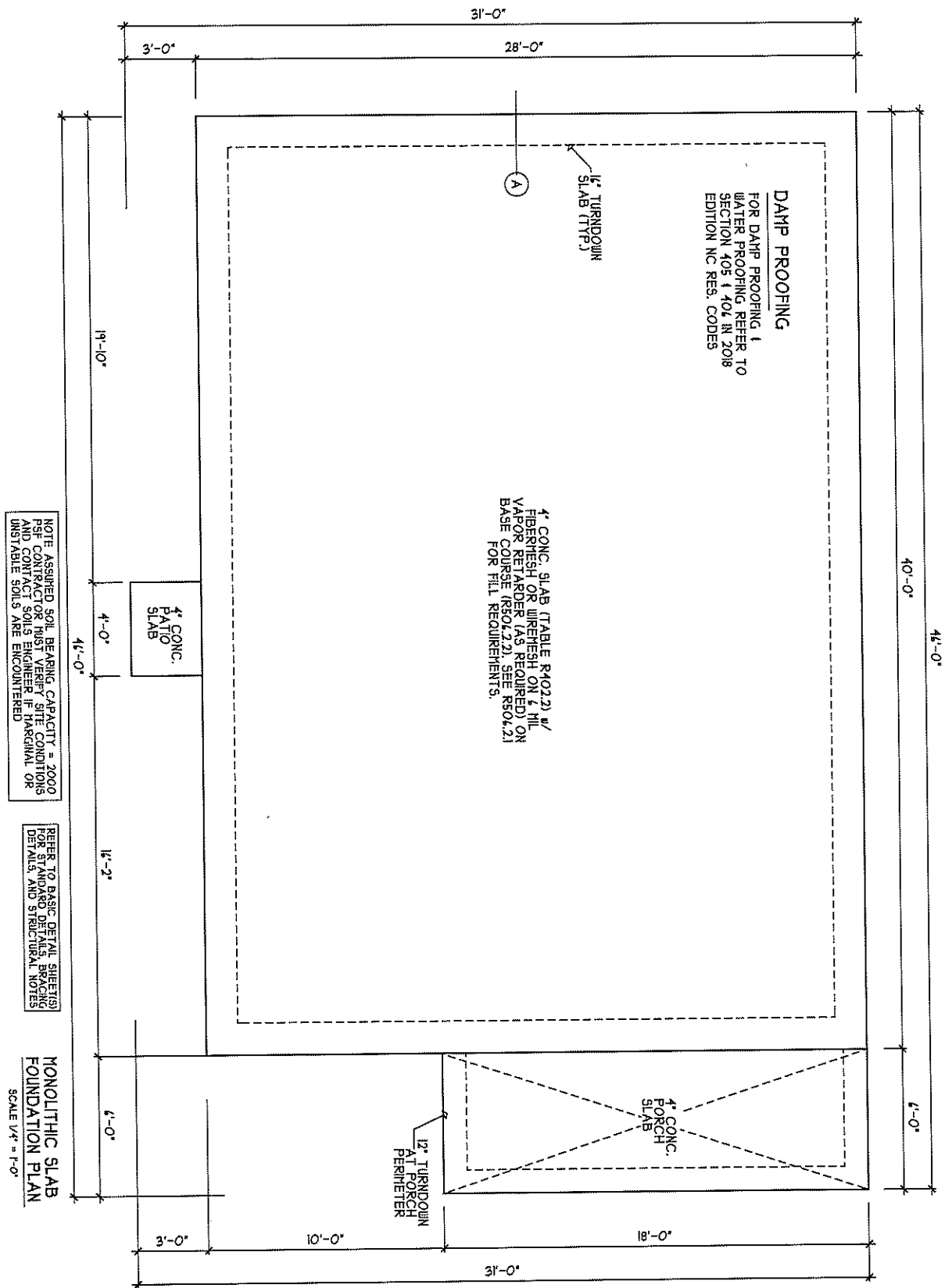

NOTE ASSUMED SOIL BEARING CAPACITY = 2000 PSF. CONTRACTOR MUST VERIFY SITE CONDITIONS AND CONTACT SOILS ENGINEER IF HAZARDOUS OR UNSTABLE SOILS ARE ENCOUNTERED.

REFER TO BASIC DETAIL SHEETS FOR STANDARD DETAILS, BRACING DETAILS, AND STRUCTURAL NOTES.

MONOLITHIC SLAB FOUNDATION PLAN  
SCALE 1/4" = 1'-0"

DATE	12/01/2011
DESCRIPTION OF THE WORK	FOUNDATION PLAN
PROJECT	1 STORY
NO.	070821

**H<sup>2</sup>** H SQUARED HOME DESIGN, INC.

HEATHER HALL  
185 HEATHERSTONE CT  
BENSON NC 27504  
(919) 207-1403

SQUARE FOOTAGE	HEATED FOOTAGE
FIRST FLOOR = 120	#1120
FRONT PORCH = 108	

THE BENTLEY  
RIGHT HAND  
JRT MANG. PROP.



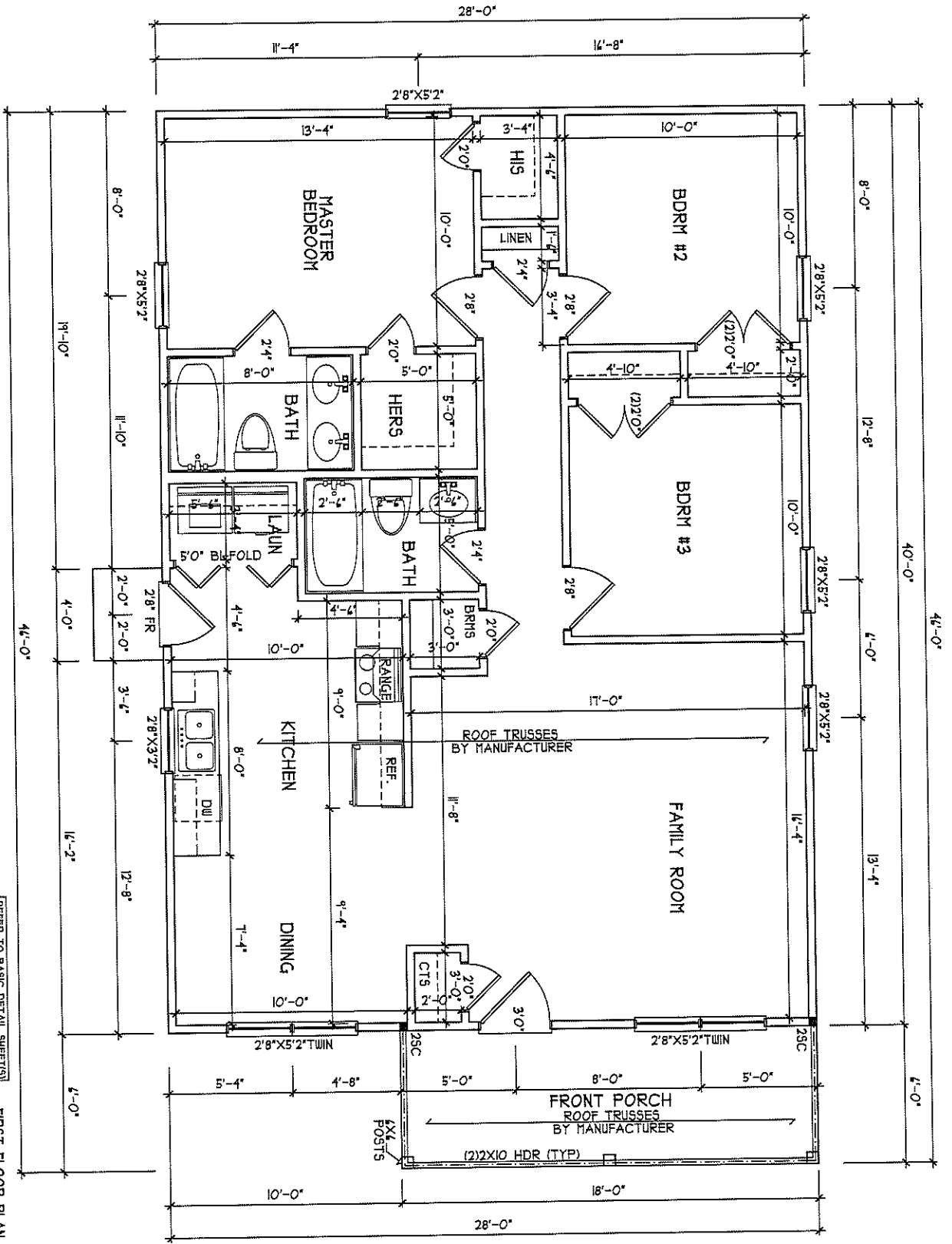

REFER TO BASIC DETAIL SHEETS FOR STANDARD STRUCTURAL NOTES

FIRST FLOOR PLAN  
SCALE 1/4" = 1'-0"

NO.	010821
STORY	1 STORY
DATE	12/07/2021
DESIGNED BY	HEATHER HALL
CHECKED BY	HEATHER HALL
DATE	12/07/2021
PROJECT	THE BENTLEY RIGHT HAND
OWNER	JRT MANG. PROP.

**H SQUARED HOME DESIGN, INC.**

HEATHER HALL  
185 HEATHERSTONE CT  
BENSON NC 27504  
(919) 207-1403

AREA	FOOTAGE
FIRST FLOOR	= 1120
FRONT PORCH	= 108

HEATED FOOTAGE	#1120
----------------	-------

THE BENTLEY  
RIGHT HAND  
JRT MANG. PROP.



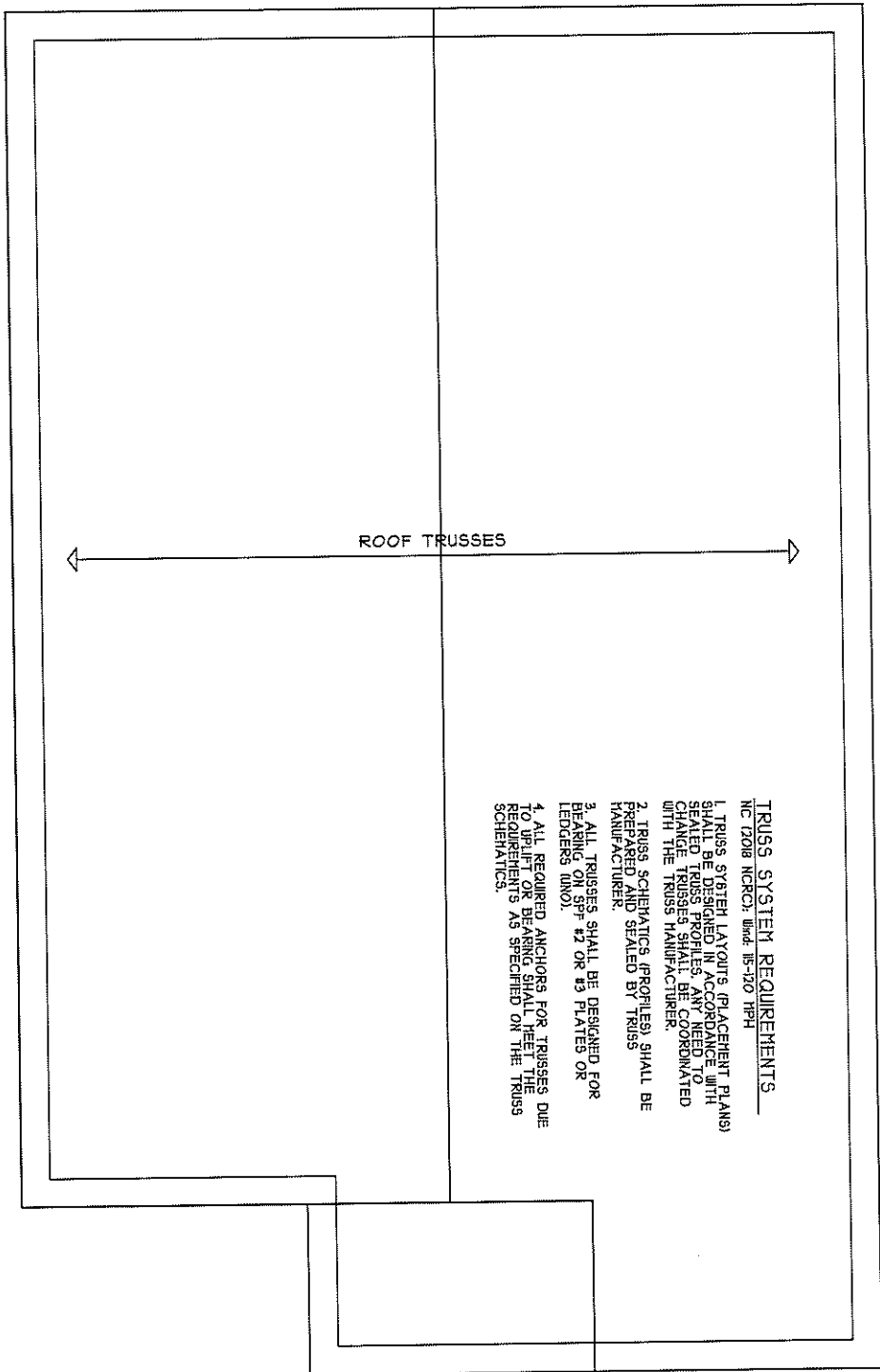

- TRUSS SYSTEM REQUIREMENTS**  
 NC (2018 NCR): Wind: 15-120 mph
1. TRUSS SYSTEM LAYOUTS (PLACEMENT PLANS) SHALL BE DESIGNED IN ACCORDANCE WITH SEALED TRUSS PROFILES. ANY NEED TO CHANGE TRUSSES SHALL BE COORDINATED WITH THE TRUSS MANUFACTURER.
  2. TRUSS SCHEMATICS (PROFILES) SHALL BE PREPARED AND SEALED BY TRUSS MANUFACTURER.
  3. ALL TRUSSES SHALL BE DESIGNED FOR BEARING ON SPF #2 OR #3 PLATES OR LEDGERS (UNO).
  4. ALL REQUIRED ANCHORS FOR TRUSSES DUE TO UP LIFT OR BEARING SHALL MEET THE REQUIREMENTS AS SPECIFIED ON THE TRUSS SCHEMATICS.

REFER TO BASIC DETAIL SHEET(S) FOR STANDARD DETAILS, BRACING DETAILS, AND STRUCTURAL NOTES

**ROOF PLAN**  
 SCALE 1/4" = 1'-0"

 <b>H SQUARED HOME DESIGN, INC.</b>	HEATHER HALL 185 HEATHERSTONE CT BENSON NC 27504 (919) 207-1403	<b>SQUARE FOOTAGE</b> FIRST FLOOR = 1220 FRONT PORCH = 108	<b>HEATED FOOTAGE</b> <b>#1120</b>	<b>THE BENTLEY</b> RIGHT HAND <b>JRT MANG. PROP.</b>
		DATE: 12/01/2021 TIME: 11:00 AM DRAWN BY: JRT CHECKED BY: JRT PROJECT NO: 0710821	THIS PLAN HAS BEEN PREPARED BY AN ARCHITECT OR ARCHITECTURAL FIRM REGISTERED IN THE STATE OF NORTH CAROLINA. STATE REGISTRATION NO. 0710821.	





THIS LAYOUT IS INTENDED FOR THE PURPOSE OF TRUSS LOCATION AND PLACEMENT ONLY. REFER TO THE BUILDING PLANS FOR ACTUAL BUILDING CONSTRUCTION.

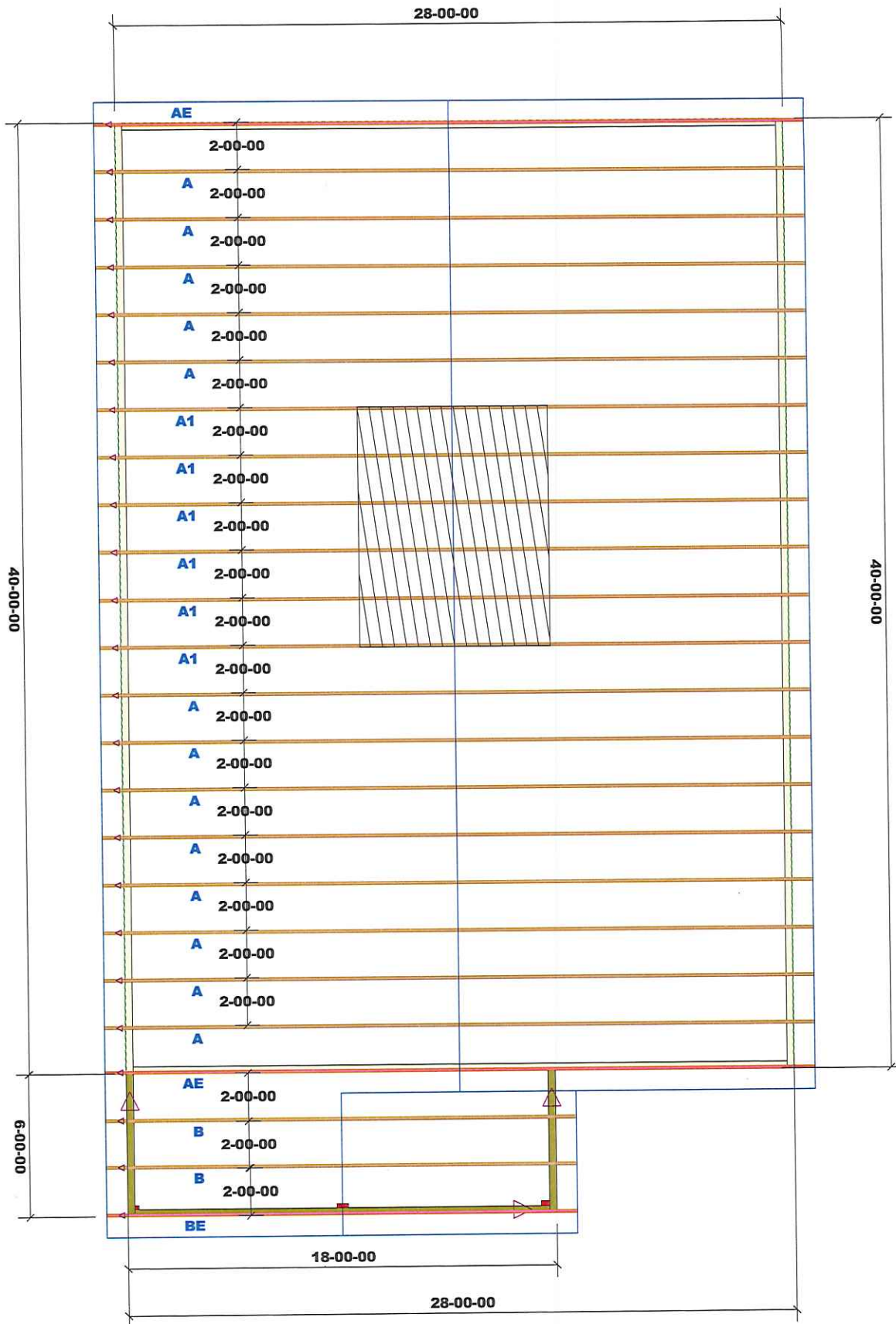

1st Level Roof Area  
0  
2nd Level Roof Area  
0

**GENERAL NOTES:**

- DO NOT CUT OR MODIFY TRUSSES
- TRUSSES ARE SPACED 24" ON CENTER UNLESS OTHERWISE NOTED
- REFER TO THE INDIVIDUAL TRUSS DESIGN DRAWINGS FOR THE LOCATION OF LATERAL BRACING AND MULTI-PLY CONNECTION REQUIREMENTS.
- PER ANSI TPI 1-2002 THE TRUSS ENGINEER IS RESPONSIBLE FOR TRUSS TO TRUSS CONNECTIONS AND TRUSS PLY TO PLY CONNECTIONS. THIS TRUSS LAYOUT PLAN RECOMMENDS TRUSS TO BEARING CONNECTIONS AND TRUSS TO BEAM CONNECTIONS WHICH SHALL BE REVIEWED BY THE BUILDING DESIGNER. IT IS THE RESPONSIBILITY OF THE BUILDING DESIGNER TO RESOLVE ALL ROOF FORCES ADEQUATELY TO THE FOUNDATION.

WIND SPEED: 130 mph  
BOTTOM DEAD LOAD: 10.0 psf  
TOP DEAD LOAD: 10.0 psf  
TOP LIVE LOAD: 20.0 psf

<b>PROJECT:</b> BENTLEY PLAN - JRT			
<b>CUSTOMER:</b> 2307-84 Fayetteville			
<b>MODEL:</b> THE BENTLEY			
<b>QUOTE #:</b> 28292	<b>PRINT DATE:</b> 9/2/2021	<b>DRAWN BY:</b>	<b>SCALE:</b> N.T.S

DEDICATED TO QUALITY AND EXCELLENCE  
DUNN, NORTH CAROLINA 28334  
PHONE: 910-892-8400



**Trenco**  
818 Soundside Rd  
Edenton, NC 27932

Re: 28292-28292A  
BENTLEY PLAN - JRT

The truss drawing(s) referenced below have been prepared by Truss Engineering Co. under my direct supervision based on the parameters provided by 84 Components - #2383.  
Pages or sheets covered by this seal: I47750752 thru I47750756

My license renewal date for the state of North Carolina is December 31, 2021.

North Carolina COA: C-0844



September 3, 2021

Sevier, Scott

**IMPORTANT NOTE:** The seal on these truss component designs is a certification that the engineer named is licensed in the jurisdiction(s) identified and that the designs comply with ANSI/TPI 1. These designs are based upon parameters shown (e.g., loads, supports, dimensions, shapes and design codes), which were given to MITTEK or TRENCO. Any project specific information included is for MITTEK's or TRENCO's customers file reference purpose only, and was not taken into account in the preparation of these designs. MITTEK or TRENCO has not independently verified the applicability of the design parameters or the designs for any particular building. Before use, the building designer should verify applicability of design parameters and properly incorporate these designs into the overall building design per ANSI/TPI 1, Chapter 2.



September 3, 2021



**NOTES-**  
 (1) Unbalanced roof live loads have been considered for this design.  
 (2) Wind: ASCE 7-10; Vult=130mph Vasd=103mph; TC DL=6.0psf; BC DL=6.0psf; h=30ft; Cat II; Exp B; Enclosed; MWFRS (envelope)  
 gable end zone and C-C Exterior(2) zone; C-C for members and forces & MWFRS for reactions shown; Lumber DOL=1.60 plate grp DOL=1.60  
 (3) This truss has been designed for a 10.0 psf bottom chord live load nonconcurrent with any other live loads.  
 (4) \* This truss has been designed for a live load of 20.0psf on the bottom chord in all areas where a rectangle 3-6-0 tall by 2-0-0 wide will fit between the bottom chord and any other members, with BCDL = 10.0psf.  
 (5) Provide mechanical connection (by others) of truss to bearing plate capable of withstanding 150 lb uplift at joint 2 and 150 lb uplift at joint 8.

**FORCES.** (lb) - Max. Comp./Max. Ten. - All forces 250 (lb) or less except when shown.  
 TOP CHORD 2-3=-1915/487, 3-5=-1690/496, 5-7=-1690/496, 7-8=-1915/487  
 BOT CHORD 2-12=-314/1633, 10-12=-94/1090, 8-10=-314/1633  
 WEBS 5-10=-138/642, 7-10=-412/271, 5-12=-138/640, 3-12=-412/271

**REACTIONS.** (size) 2=0-3-8, 8=0-3-8  
 Max Horiz 2=124(LC 10)  
 Max Uplift 2=-150(LC 10), 8=-150(LC 11)  
 Max Grav 2=1173(LC 1), 8=1173(LC 1)

**LUMBER-**  
 TOP CHORD 2x4 SP No.2 or 2x4 SPF No.2  
 BOT CHORD 2x4 SP No.3  
 WEBS 2x4 SP No.3  
 WEDGE Left: 2x4 SP No.3, Right: 2x4 SP No.3

**BRACING-**  
 TOP CHORD Structural wood sheathing directly applied or 3-4-9 cc purlins.  
 BOT CHORD Rigid ceiling directly applied or 1-0-0-0 cc bracing.

LOADING (psf)	SPACING- Plate Grp DOL Lumber DOL Rep Stress Incr Code IRC2015/TP12014	CSI. TC 0.65 BC 0.88 WB 0.27 Matrx-MS	DEFLL. in (loc) Vert(LL) -0.33 10-12 >999 Vert(CT) -0.49 10-12 >687 Horz(CT) 0.06 8	L/D L/den 240 180 n/a	PLATES MT20 197/144	Weight: 130 lb FT = 20%
---------------	--	---	---	-----------------------------------	---------------------------	----------------------------

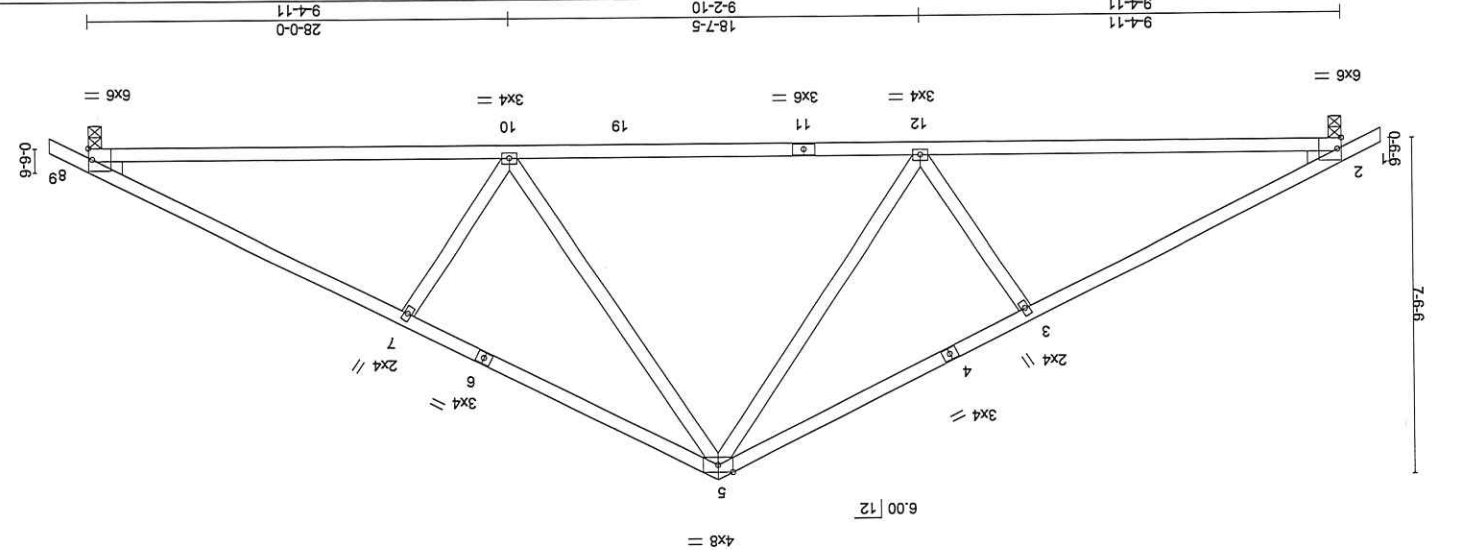

Job	Truss	Truss Type	Qty	Ply	Job Reference (optional)
28292-28292A	A	Common	13	1	8520 s Aug 27 2021 Mittek Industries, Inc. Thu Sep 2 13:15:25 2021 Page 1 ID:19gFtrusslsmoRczD1QEH4syE227-Cgq5hmGD1Yr?wNmu2b_Uqm8ID:Ciba_Rsnzkxyhmo

84 Components (Dunn), Dunn, NC - 28334,  
 0-10-8 7-1-0 7-1-0 14-0-0 6-11-0 20-11-0 28-0-0 7-1-0 0-10-8  
 Scale = 1:49.6



Job	28292-28292A	Truss	A1	ROOF TRUSS	6	Qty	Ply	BENTLEY PLAN - JRT	147750753
84 Components (Dunn), Dunn, NC - 28334, ID:19gFrtuslsmoRozD1QEH4syE227-g0T17nu_LgsWVLA4XJVjNzhUx6Z0Kakal5RjhHzynfb? 8.520 s Aug 27 2021 MITTEK Industries, Inc. Thu Sep 2 13:15:26 2021 Page 1 Job Reference (optional)									

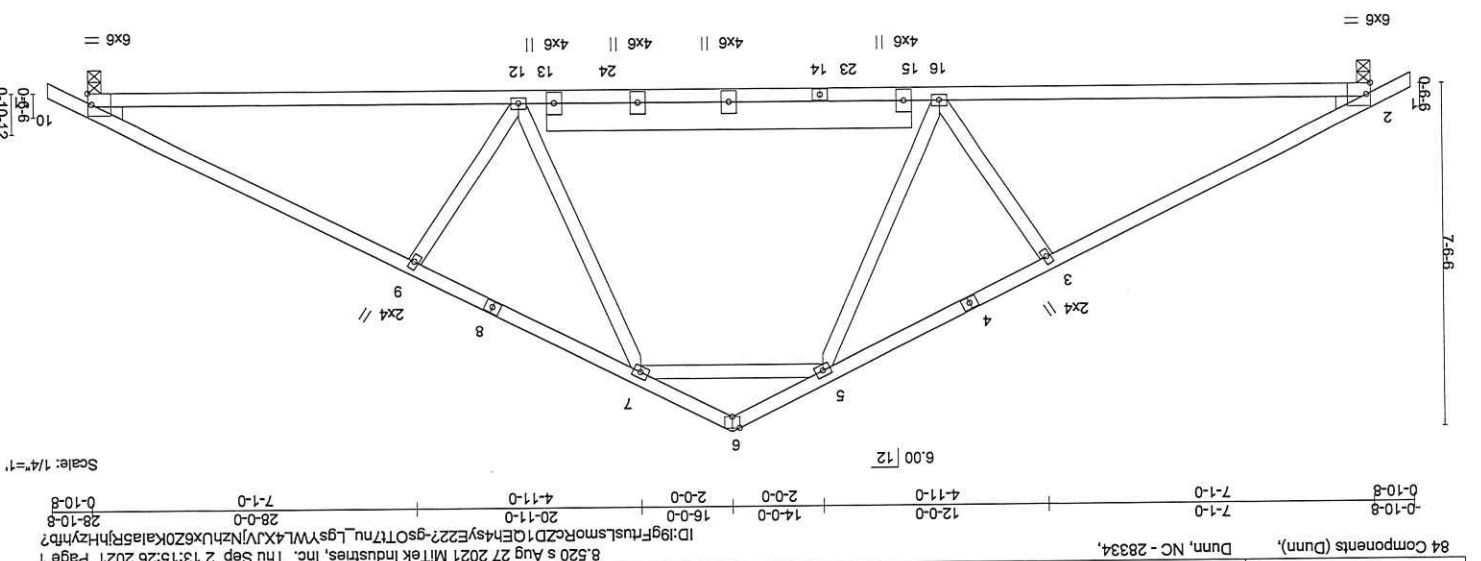

LOADING (psf)	SPACING	CSI	DEFLL	in (loc)	L/delt	L/d	PLATES	GRIP	Weight 155 lb	FT = 20%
TCLL 20.0	2-0-0	TC 0.59	Vert(LL) -0.23	16-19	>999	240	MT20	197/144		
TCDL 10.0	Lumber DOL	BC 0.81	Vert(CT) -0.38	16-19	>896	180				
BCDL 10.0	Rep Stress Incr YES	WB 0.45	Horz(CT) 0.05	10	n/a	n/a				

**LUMBER-** TOP CHORD 2x4 SP No.2 or 2x4 SPF No.2  
 BOT CHORD 2x4 SP No.2 or 2x4 SPF No.2 \*Except\*  
 WEBS 2x4 SP No.3  
 WEDGE Left: 2x4 SP No.3, Right: 2x4 SP No.3

**REACTIONS.** (size) 2=0-3-8, 10=0-3-8  
 Max Horiz 2=124(LC 10)  
 Max Uplift 2=150(LC 10), 10=150(LC 11)  
 Max Grav 2=1173(LC 1), 10=1173(LC 1)

**FORCES.** (lb) - Max. Comp./Max. Ten. - All forces 250 (lb) or less except when shown.  
 TOP CHORD 2-3=-1895/478, 3-5=-1676/480, 7-9=-1676/480, 9-10=-1895/478  
 BOT CHORD 2-16=-302/1612, 12-16=-144/1232, 10-12=-302/1612  
 WEBS 7-12=-91/570, 9-12=411/241, 5-16=-91/570, 3-16=411/240, 5-7=-1168/436

**NOTES-**  
 (1) Unbraced roof live loads have been considered for this design.  
 (2) Wind: ASCE 7-10; Vult=130mph Vasd=103mph; TCDL=6.0psf; BCDL=6.0psf; h=30ft; Cat. II; Exp B; Enclosed; MWFRS (envelope) gable end zone and C-C Exterior(2) zone; C-C for members and forces & MWFRS for reactions shown; Lumber DOL=1.60 plate grip DOL=1.60  
 (3) All plates are 3x4 MT20 unless otherwise indicated.  
 (4) This truss has been designed for a 10.0 psf bottom chord live load nonconcurrent with any other live loads.  
 (5) \* This truss has been designed for a live load of 20.0psf on the bottom chord in all areas where a rectangle 3-6-0 tall by 2-0-0 wide will fit between the bottom chord and any other members, with BCDL = 10.0psf.  
 (6) Provide mechanical connection (by others) of truss to bearing plate capable of withstanding 150 lb uplift at joint 2 and 150 lb uplift at joint 10.  
 (7) ATTIC SPACE SHOWN IS DESIGNED AS UNINHABITABLE.

**DESIGN VALIDATION:** Design valid for use only with MITTEK connectors. This design is based only upon parameters shown, and is for an individual building component, not a truss system. Before use, the building designer must verify the applicability of design parameters and properly incorporate this design into the overall building design. Bracing indicated is to prevent buckling of individual truss web and/or chord members and properly incorporate this design into the overall fabrication, storage, delivery, erection and bracing of trusses and truss systems, see ANSITR11 Quality Criteria, DSB-89 and BCSI Building Component Safety Information available from Truss Plate Institute, 2670 Crain Highway, Suite 203 Waldorf, MD 20601

September 3, 2021













## Symbols

### PLATE LOCATION AND ORIENTATION

Center plate on joint unless x, y offsets are indicated. Dimensions are in ft-in-sixteenths. Apply plates to both sides of truss and fully embed teeth.

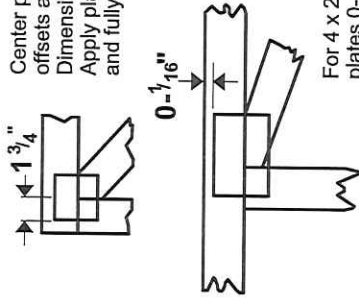

This symbol indicates the required direction of slots in connector plates.

\* Plate location details available in MiTek 20/20 software or upon request.

### PLATE SIZE

4 X 4

The first dimension is the plate width measured perpendicular to slots. Second dimension is the length parallel to slots.

### LATERAL BRACING LOCATION



Indicated by symbol shown and/or by text in the bracing section of the output. Use T or I bracing if indicated.

### BEARING

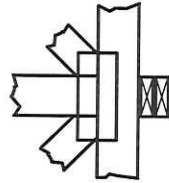

Indicates location where bearings (supports) occur. Icons vary but reaction section indicates joint number where bearings occur. Min size shown is for crushing only.

### Industry Standards:

ANSI/TPI1: National Design Specification for Metal Plate Connected Wood Truss Construction.  
 DSB-89: Design Standard for Bracing.  
 BCSI: Building Component Safety Information, Guide to Good Practice for Handling, Installing & Bracing of Metal Plate Connected Wood Trusses.

## Numbering System

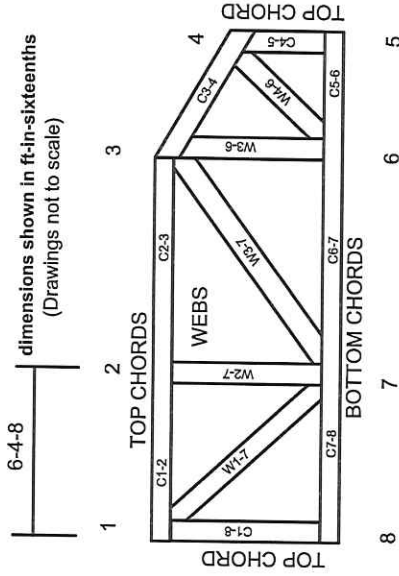

JOINTS ARE GENERALLY NUMBERED/LETTERED CLOCKWISE AROUND THE TRUSS STARTING AT THE JOINT FARTHEST TO THE LEFT.

CHORDS AND WEBS ARE IDENTIFIED BY END JOINT NUMBERS/LETTERS.

### PRODUCT CODE APPROVALS

ICC-ES Reports:

ESR-1311, ESR-1352, ESR1988  
 ER-3907, ESR-2362, ESR-1397, ESR-3282

Trusses are designed for wind loads in the plane of the truss unless otherwise shown.

Lumber design values are in accordance with ANSI/TPI 1 section 6.3 These truss designs rely on lumber values established by others.

© 2012 MiTek® All Rights Reserved



MiTek Engineering Reference Sheet. MII-7473 rev. 5/19/2020

## General Safety Notes

### Failure to Follow Could Cause Property Damage or Personal Injury

- Additional stability bracing for truss system, e.g. diagonal or X-bracing, is always required. See BCSI.
- Truss bracing must be designed by an engineer. For wide truss spacing, individual lateral braces themselves may require bracing, or alternative Tor 1 bracing should be considered.
- Never exceed the design loading shown and never stack materials on inadequately braced trusses.
- Provide copies of this truss design to the building designer, erection supervisor, property owner and all other interested parties.
- Cut members to bear tightly against each other.
- Place plates on each face of truss at each joint and embed fully. Knots and wane at joint locations are regulated by ANSI/TPI 1.
- Design assumes trusses will be suitably protected from the environment in accord with ANSI/TPI 1.
- Unless otherwise noted, moisture content of lumber shall not exceed 19% at time of fabrication.
- Unless expressly noted, this design is not applicable for use with fire retardant, preservative treated, or green lumber.
- Camber is a non-structural consideration and is the responsibility of truss fabricator. General practice is to camber for dead load deflection.
- Plate type, size, orientation and location dimensions indicated are minimum plating requirements.
- Lumber used shall be of the species and size, and in all respects, equal to or better than that specified.
- Top chords must be sheathed or purlins provided at spacing indicated on design.
- Bottom chords require lateral bracing at 10 ft. spacing, or less, if no ceiling is installed, unless otherwise noted.
- Connections not shown are the responsibility of others.
- Do not cut or alter truss member or plate without prior approval of an engineer.
- Install and load vertically unless indicated otherwise.
- Use of green or treated lumber may pose unacceptable environmental, health or performance risks. Consult with project engineer before use.
- Review all portions of this design (front, back, words and pictures) before use. Reviewing pictures alone is not sufficient.
- Design assumes manufacture in accordance with ANSI/TPI 1 Quality Criteria.
- The design does not take into account any dynamic or other loads other than those expressly stated.