

# KENZIE H&H HOMES - GARAGE RIGHT

## PLAN REVISIONS

01-10-13	COMPLETED CONSTRUCTION DOCUMENTS INCLUDING CLIENT REVIEW COMMENTS
01-15-13	CLIENT BACK END COMMENTS
01-24-13	MIRROR PLAN TO CREATE LEFT HAND VERSION
03-26-20	UPDATED ROOM NAMING PER IAH STANDARDS ADDED 2x6 WALL FLOOR PLANS + ELECTRICAL PLANS CHANGED ELEVATION 'A' + 'C' TO 'A-1' + 'C-1' ADDED ELEVATIONS 'A-2' + 'C-2' CHANGED ELEVATION 'B' TO ELEV. 'B-2' AND ADDED NEW ELEV. 'B-1' BROKE OUT OPTIONS FROM THE FLOOR PLANS AND MADE A SEPARATE PAGE FOR OPTIONS

ELEVATION "A"	
MAIN FLOOR	804 SF.
UPPER FLOOR	1154 SF.
TOTAL LIVING	1958 SF.
GARAGE	480 SF.
FRONT PORCH	82 SF.
PATIO	120 SF.
TOTAL SQ. FT.	2640 SF.
OPT. COV. PORCH	120 SF.
OPT. EXT. PORCH	160 SF.
OPT. 1 CAR GARAGE	240 SF.

ELEVATION "B"	
MAIN FLOOR	804 SF.
UPPER FLOOR	1170 SF.
TOTAL LIVING	1974 SF.
GARAGE	480 SF.
FRONT PORCH	83 SF.
PATIO	120 SF.
TOTAL SQ. FT.	2657 SF.
OPT. COV. PORCH	120 SF.
OPT. EXT. PORCH	160 SF.
OPT. 1 CAR GARAGE	240 SF.

ELEVATION "C"	
MAIN FLOOR	804 SF.
UPPER FLOOR	1170 SF.
TOTAL LIVING	1974 SF.
GARAGE	480 SF.
FRONT PORCH	81 SF.
PATIO	120 SF.
TOTAL SQ. FT.	2655 SF.
OPT. COV. PORCH	120 SF.
OPT. EXT. PORCH	160 SF.
OPT. 1 CAR GARAGE	240 SF.

ISSUANCE OF PLANS FROM THIS DRAFTER'S OFFICE SHALL NOT RELIEVE THE BUILDER OF RESPONSIBILITY TO REVIEW AND VERIFY ALL NOTES, DIMENSIONS, AND ADHERENCE TO APPLICABLE BUILDING CODES PRIOR TO COMMENCEMENT OF ANY CONSTRUCTION.  
ANY DISCREPANCY OF ERROR IN NOTES, DIMENSIONS, OR ADHERENCE TO APPLICABLE BUILDING CODES SHALL BE BROUGHT TO THE ATTENTION OF THE DRAFTER'S OFFICE FOR CORRECTION BEFORE COMMENCEMENT OF ANY CONSTRUCTION.  
ANY REVISIONS OR CHANGES, NOT RELATED TO THE CORRECTION OF ERRORS THAT ARE MADE AFTER THE FINAL PLANS HAVE BEEN COMPLETED SHALL BE SUBJECT TO ADDITIONAL FEES.  
IF ANY MODIFICATIONS ARE MADE TO THESE PLANS BY ANY OTHER PARTY OTHER THAN THE DRAFTER'S OFFICE, THE DRAFTER SHALL NOT BE HELD RESPONSIBLE.

Inventory Marked



JOB NUMBER	B-1818871
DWG FILE	KENZIE-A
ISSUED	07-10-19
REVISED	07-15-19
	07-24-19
	03-26-20

**DAVIS BEWS  
DESIGN GROUP**

80 SEASTR KELLEY BLVD  
CLEARWATER, FLORIDA 34677  
888-925-1300 TEL  
888-925-1800 FAX  
WWW.DAVISBEWS.COM

TAMPA • DENVER  
EST. 1994

DRAWINGS ON 11"x17"  
SHEET ARE ONE HALF  
THE SCALE NOTED

ACX000212

**KENZIE  
H&H HOMES**

1958

TITLE  
REVISION LOG

SHEET  
**CS**

ISSUANCE OF PLANS FROM THIS DRAFTER'S OFFICE SHALL NOT RELIEVE THE BUILDER OF RESPONSIBILITY TO REVIEW AND VERIFY ALL NOTES, DIMENSIONS, AND ADHERENCE TO APPLICABLE BUILDING CODES PRIOR TO COMMENCEMENT OF ANY CONSTRUCTION.  
 ANY DISCREPANCY OF ERROR IN NOTES, DIMENSIONS, OR ADHERENCE TO APPLICABLE BUILDING CODES SHALL BE BROUGHT TO THE ATTENTION OF THE DRAFTER'S OFFICE FOR CORRECTION BEFORE COMMENCEMENT OF ANY CONSTRUCTION.  
 ANY REVISIONS OR CHANGES, NOT RELATED TO THE CORRECTION OF ERRORS THAT ARE MADE AFTER THE FINAL PLANS HAVE BEEN COMPLETED SHALL BE SUBJECT TO ADDITIONAL FEES.  
 IF ANY MODIFICATIONS ARE MADE TO THESE PLANS BY ANY OTHER PARTY OTHER THAN THE DRAFTER'S OFFICE, THE DRAFTER SHALL NOT BE HELD RESPONSIBLE.

ROOF VENT CALCULATIONS					
	MAIN ROOF	UPPER ROOF	OPT. GARAGE ROOF	OPT. COVERED PORCH	OPT. EXT. COVERED PORCH
ATTIC AREA	54 SQ. FT.	120 SQ. FT.	740 SQ. FT.	020 SQ. FT.	160 SQ. FT.
NET FREE VENT AREA REQ'D (AREA/100)	74 SQ. IN.	587 SQ. IN.	15 SQ. IN.	58 SQ. IN.	77 SQ. IN.
NET FREE VENT. AREA REQUIRED	NEAR RIDGE 37 SQ. IN.	791 SQ. IN.	58 SQ. IN.	79 SQ. IN.	38 SQ. IN.
	NEAR SOFFIT 37 SQ. IN.	791 SQ. IN.	58 SQ. IN.	79 SQ. IN.	38 SQ. IN.

VERIFY TOTAL ROOF VENTS REQUIRED WITH MANUFACTURER'S SPECIFICATIONS OF NET FREE AREA PER VENT

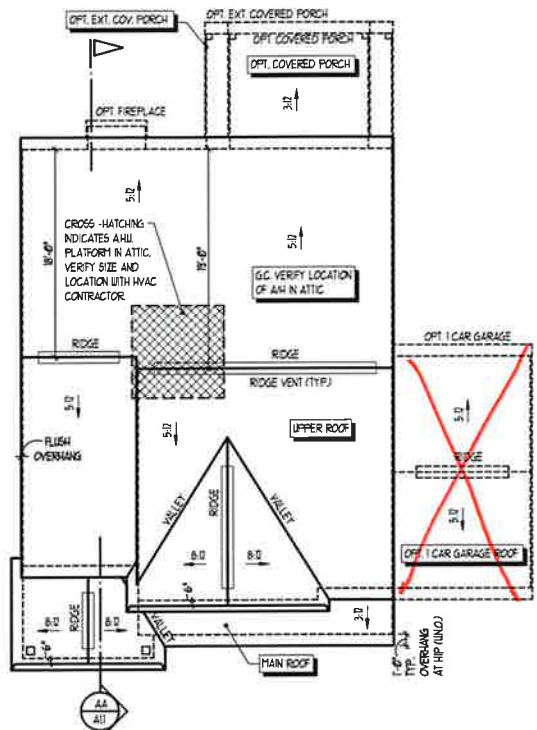

**ROOF PLAN**  
SCALE: 1/8" = 1'-0"

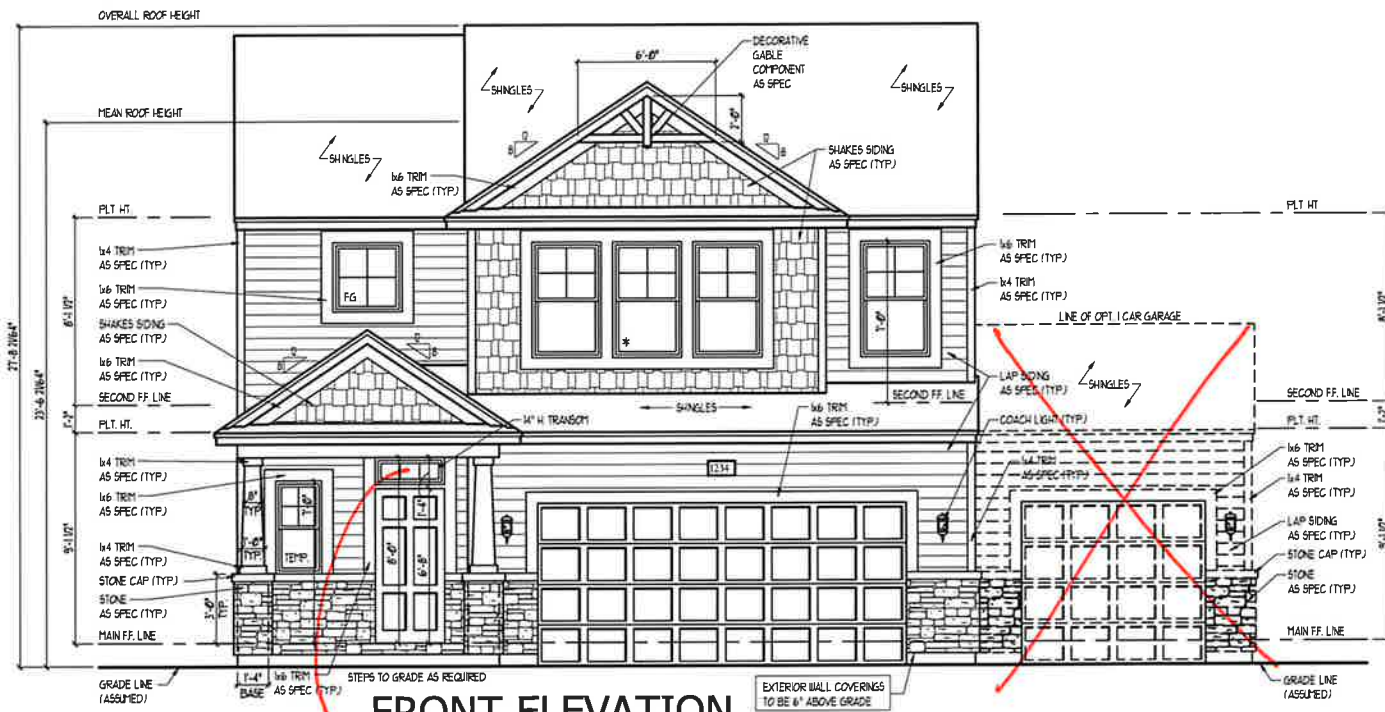

**FRONT ELEVATION**  
SCALE: 1/4" = 1'-0"

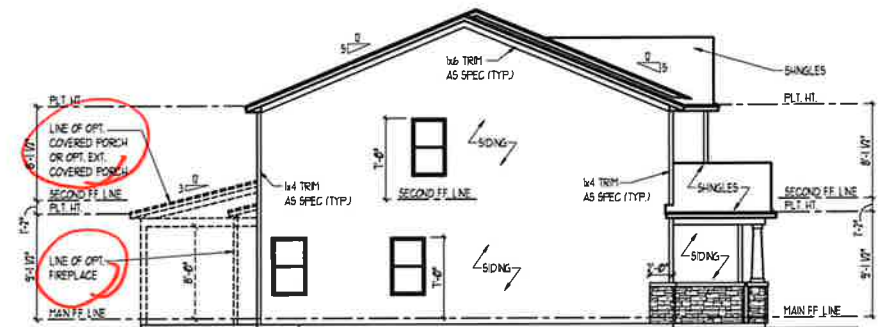

**LEFT ELEVATION**  
SCALE: 1/8" = 1'-0"

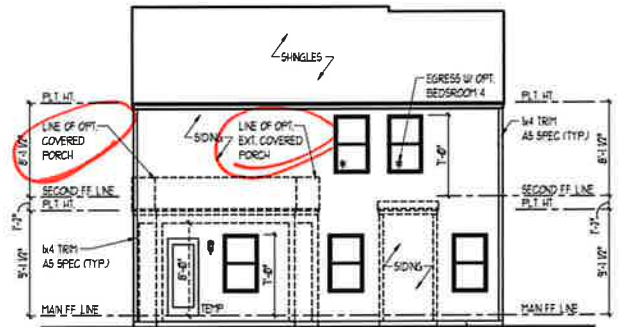

**REAR ELEVATION**  
SCALE: 1/8" = 1'-0"

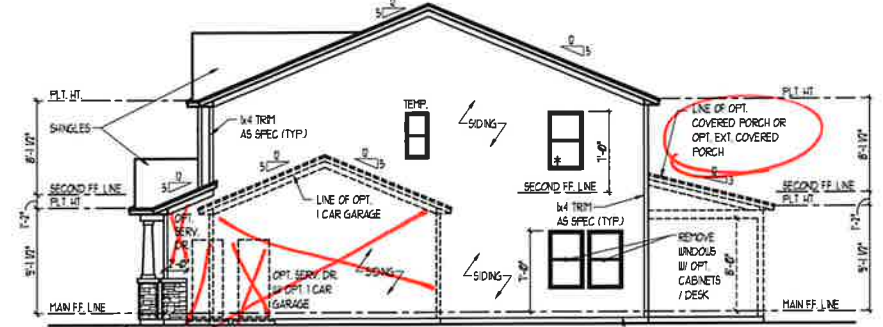

**RIGHT ELEVATION**  
SCALE: 1/8" = 1'-0"

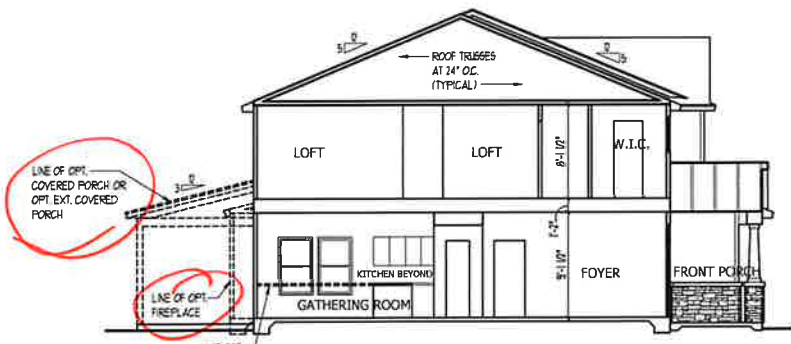

**SECTION AA**  
SCALE: 1/8" = 1'-0"

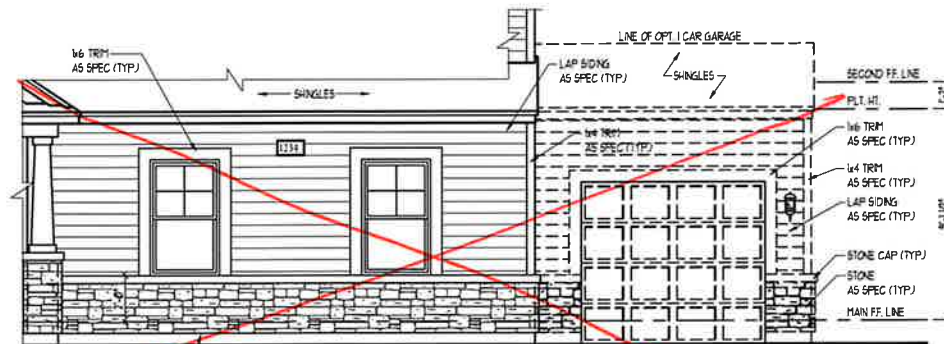

**FRONT ELEVATION AT OPT. SIDE LOAD GARAGE**  
SCALE: 1/4" = 1'-0"

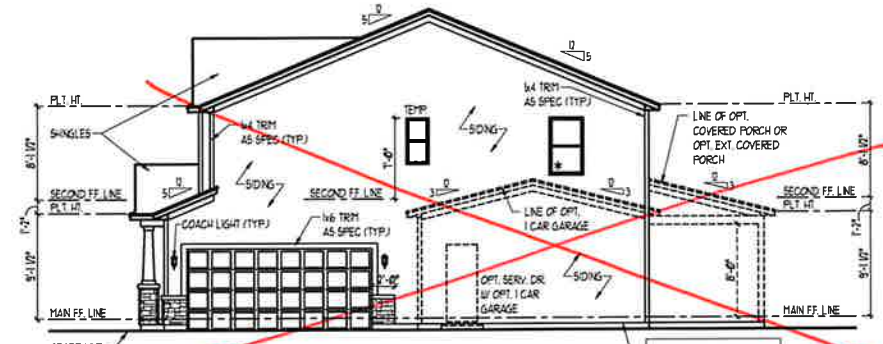

**RIGHT ELEVATION AT OPT. SIDE LOAD GARAGE**  
SCALE: 1/8" = 1'-0"

**ELEVATION "B-2"**



JOB NUMBER: B-1818871  
 CAD FILE: KENZIE-R  
 ISSUED: 07-10-19  
 REVISED: 07-15-19  
 07-24-19  
 03-26-20

DAVIS BEWS DESIGN GROUP  
 850 SEVENTH STREET EAST  
 CLEMATON, FLORIDA 34407  
 803-925-1800 TEL  
 803-925-1800 FAX  
 WWW.DAVISBEWSDESIGN.COM  
 TAMPA - DESIGN EST. 1994

DRAWINGS ON 11"x17" SHEET ARE ONE HALF THE SCALE NOTED

KENZIE  
 H&H HOMES

1958

TITLE  
 ELEVATIONS  
 ROOF PLAN  
 BUILDING SECTION  
 DETAILS

SHEET  
**A1.1**





JOB NUMBER	8-1818871
DWG FILE	KENZIE-H
ISSUED	07-10-18
REVISED	07-15-19
	07-24-19
	03-26-20

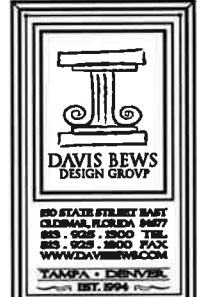

80 STATE STREET EAST  
 CLEARWATER, FLORIDA 34677  
 888-928-1800 TEL  
 888-928-1800 FAX  
 WWW.DAVISBEWS.COM  
 TAMPA - DENVER  
 EST. 1994

DRAWINGS ON 11"x17" SHEET ARE ONE HALF THE SCALE NOTED

**KENZIE  
 H&H HOMES**

1958

TITLE  
 SLAB INTERFACE PLAN

SHEET  
**A2.0**

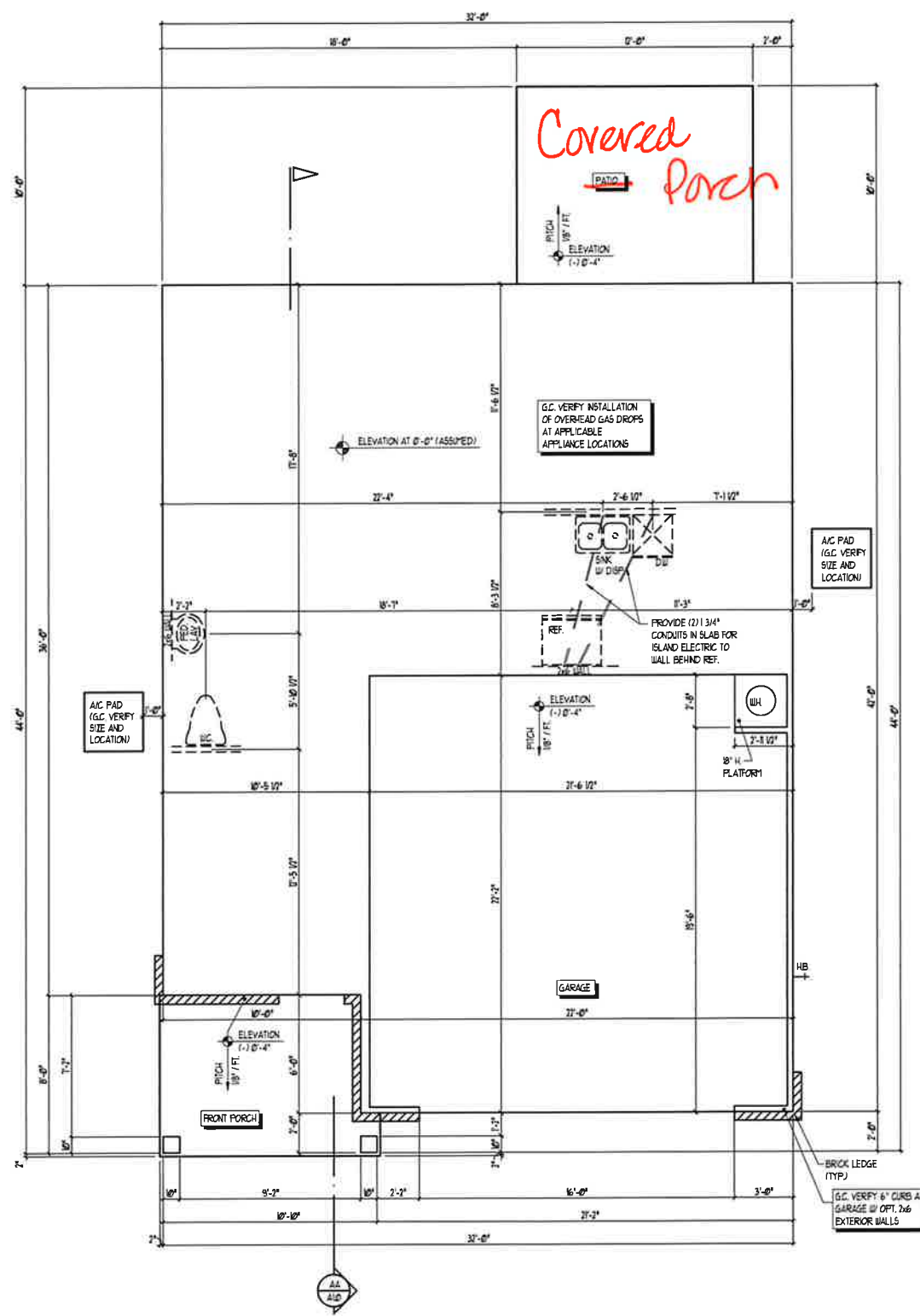
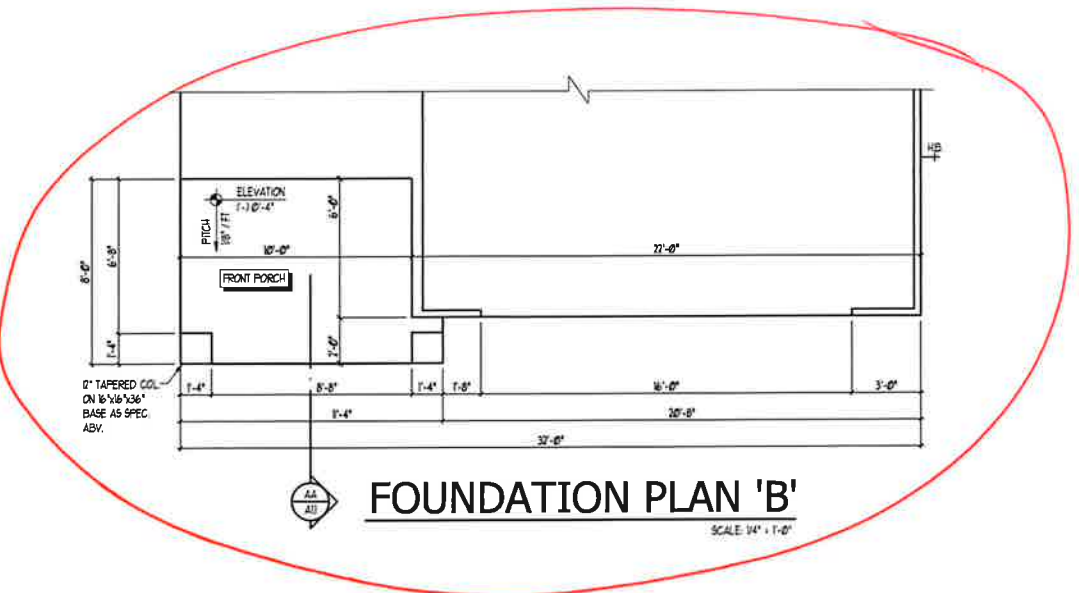
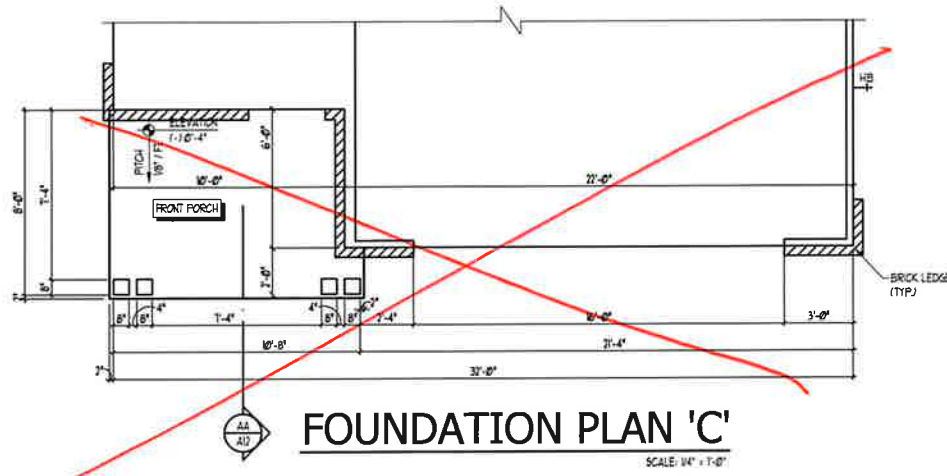

**SLAB INTERFACE PLAN**  
 SCALE: 1/4" = 1'-0"

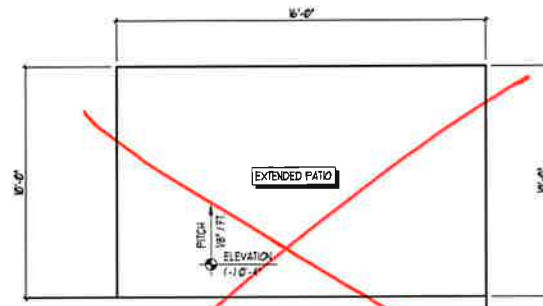

**OPT. EXTENDED PATIO**

SCALE: 1/4" = 1'-0"

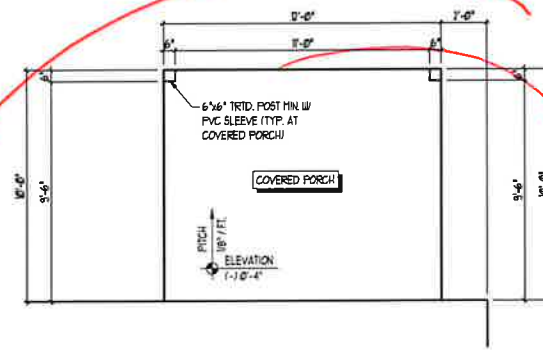

**OPT. COVERED PORCH**

SCALE: 1/4" = 1'-0"

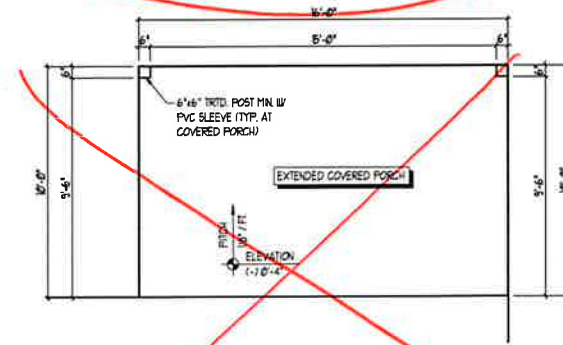

**OPT. EXT. COVERED PORCH**

SCALE: 1/4" = 1'-0"

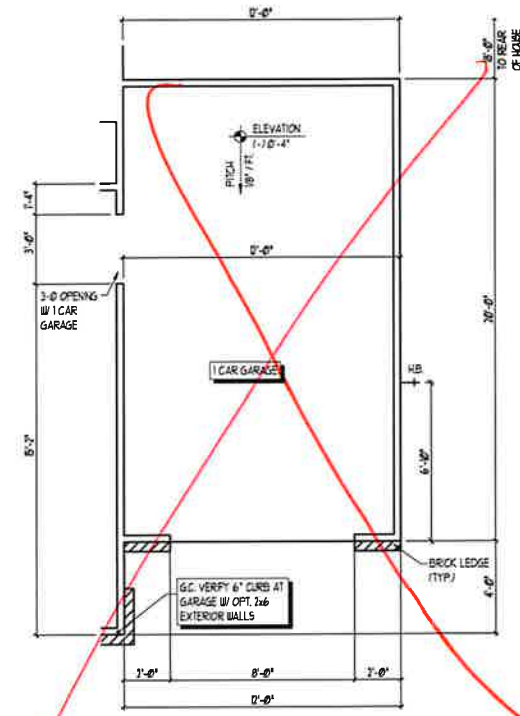

**OPT. 1 CAR GARAGE (FWD)**

SCALE: 1/4" = 1'-0"

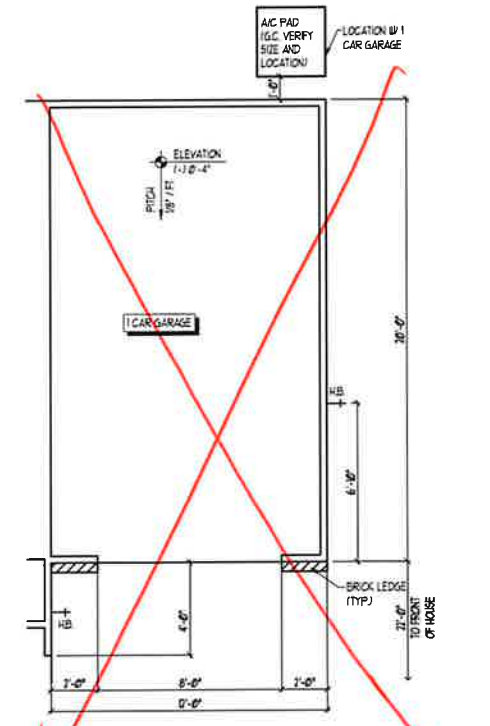

**OPT. 1 CAR GARAGE (REAR)**

SCALE: 1/4" = 1'-0"

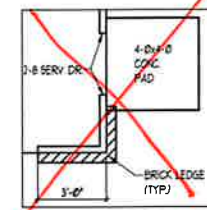

**OPT. SERVICE DOOR**

SCALE: 1/4" = 1'-0"

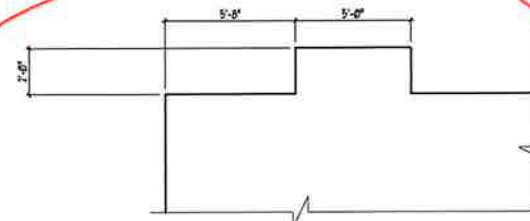

**OPT. FIREPLACE**

SCALE: 1/4" = 1'-0"

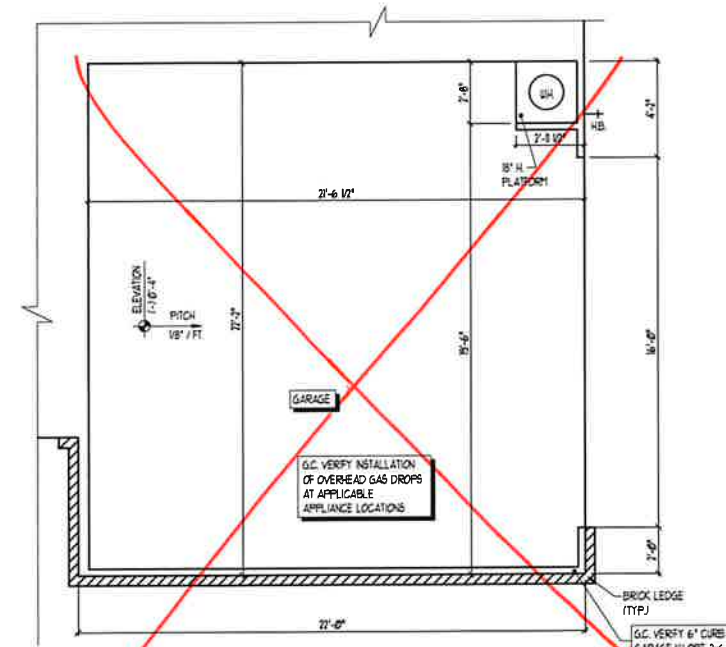

**OPT. SIDE LOAD GARAGE**

SCALE: 1/4" = 1'-0"

REFER TO STANDARD PLAN FOR INFORMATION NOT SHOWN

**SLAB INTERFACE PLAN OPTIONS**

SCALE: 1/4" = 1'-0"



JOB NUMBER	B-1818871
CAD FILE	KENZIE-R
ISSUED	07-10-19
REVISED	07-15-19
	07-24-19
	03-26-20

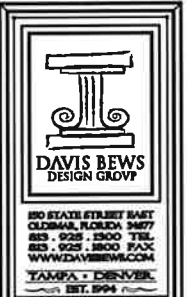

DRAWINGS ON 11"x17" SHEET ARE ONE HALF THE SCALE NOTED

**KENZIE  
H&H HOMES**

**1958**

TITLE  
SLAB INTERFACE PLAN

SHEET  
**A2.0**



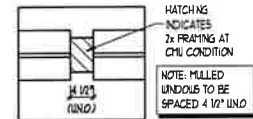

**TYP. MULL DETAIL**  
SCALE: NTS

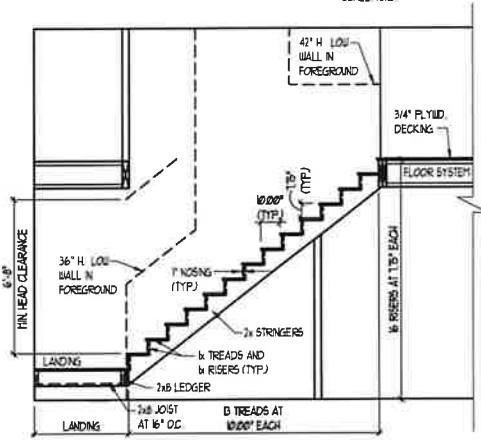

**STAIR SECTION**  
SCALE: 1/4" = 1'-0"

**\* \* \* \* \***  
**STAIR NOTES:**  
**RAILING**  
 BALUSTERS SHALL BE SPACED SO THAT A 4" SPHERE CANNOT PASS THROUGH.  
 THE TRIANGULAR OPENINGS FORMED BY THE RISER, TREAD AND BOTTOM RAIL OF A GUARD AT THE OPEN SIDE OF A STAIRWAY ARE PERMITTED TO BE AS SUCH A SIZE THAT A SPHERE OF 6 INCHES CANNOT PASS THROUGH.  
 OPENINGS FOR REQUIRED GUARDS ON THE SIDES OF STAIR TREADS SHALL NOT ALLOW A SPHERE 4 3/8 INCHES TO PASS THROUGH.  
 HANDRAILS HANDRAILS FOR STAIRWAYS SHALL BE CONTINUOUS FOR THE FULL LENGTH OF THE FLIGHT, FROM A POINT DIRECTLY ABOVE THE TOP RISER OF THE FLIGHT TO A POINT DIRECTLY ABOVE THE LOWEST RISER. HANDRAIL ENDS SHALL BE RETURNED OR SHALL TERMINATE IN NEWEL POSTS OR SAFETY TERMINALS. HANDRAILS ADJACENT TO A WALL SHALL HAVE A SPACE OF NOT LESS THAN 1-1/2 INCH BETWEEN THE WALL AND HANDRAILS.  
 CONTINUOUS GRASPABLE HANDRAIL MUST MEET TYPE ONE OR TYPE TWO CRITERIA  
**\* \* \* \* \***

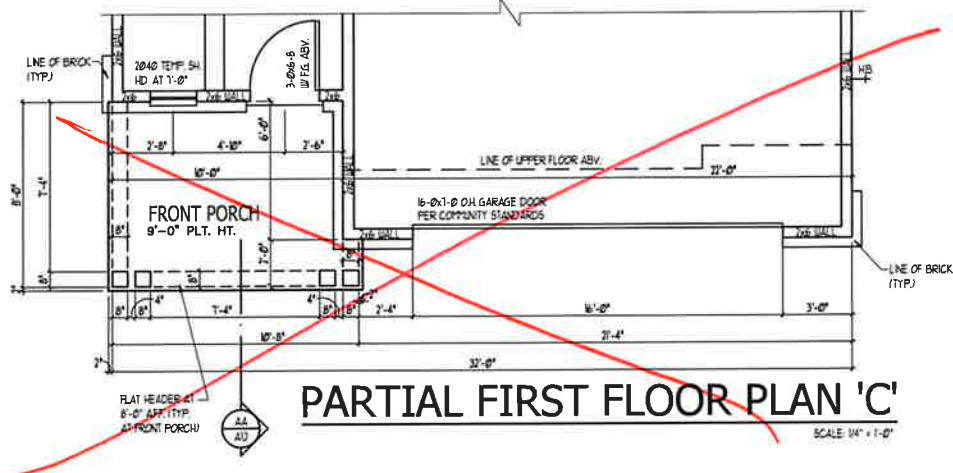

**PARTIAL FIRST FLOOR PLAN 'C'**  
SCALE: 1/4" = 1'-0"

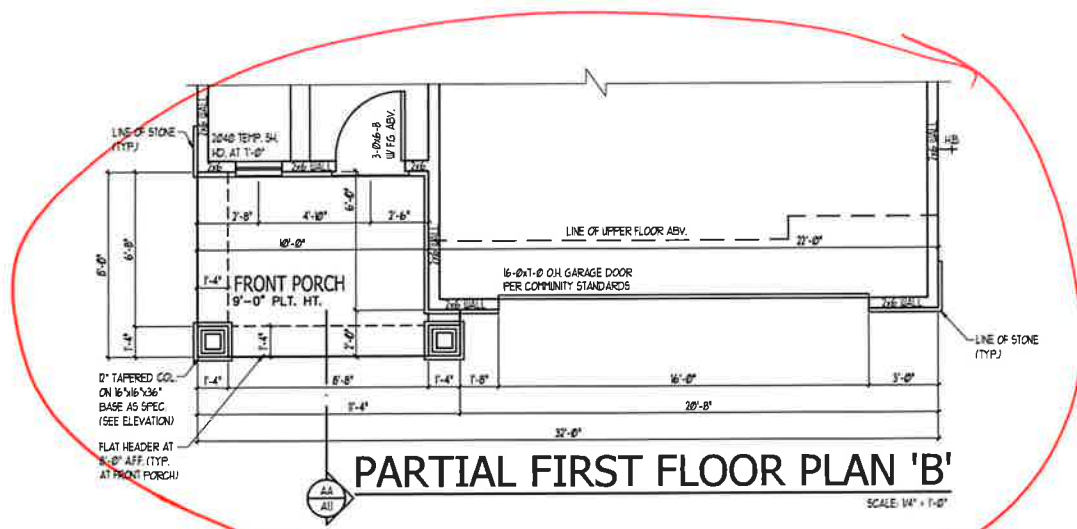

**PARTIAL FIRST FLOOR PLAN 'B'**  
SCALE: 1/4" = 1'-0"

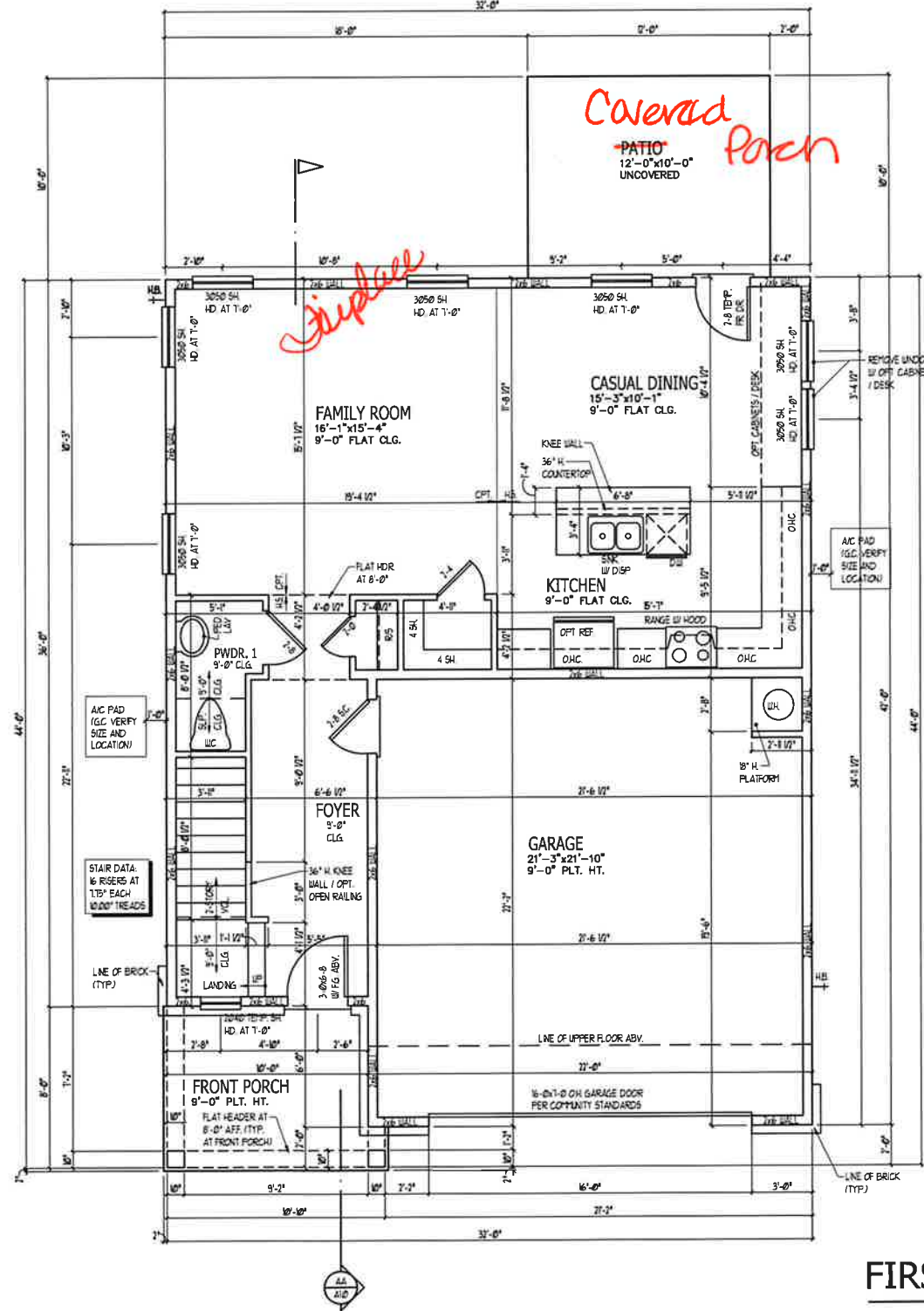

**FIRST FLOOR PLAN (2x6 WALL)**  
SCALE: 1/4" = 1'-0"



JOB NUMBER	B-1818871
CAD FILE	KENZIE-R
ISSUED	07-18-19
REVISED	07-15-19
	07-24-19
	03-26-20

**DAVIS BEWS DESIGN GROUP**  
 850 STATE STREET EAST  
 CLEARWATER, FLORIDA 34627  
 813-928-1800 TEL  
 813-928-1800 FAX  
 WWW.DAVISBEWS.COM  
 TAMPA - CLEARWATER  
 EST. 1994  
 DRAWINGS ON 11"x11" SHEET ARE ONE HALF THE SCALE NOTED

**KENZIE H&H HOMES**

1958

TITLE  
FIRST FLOOR PLAN

SHEET  
**A3.0**

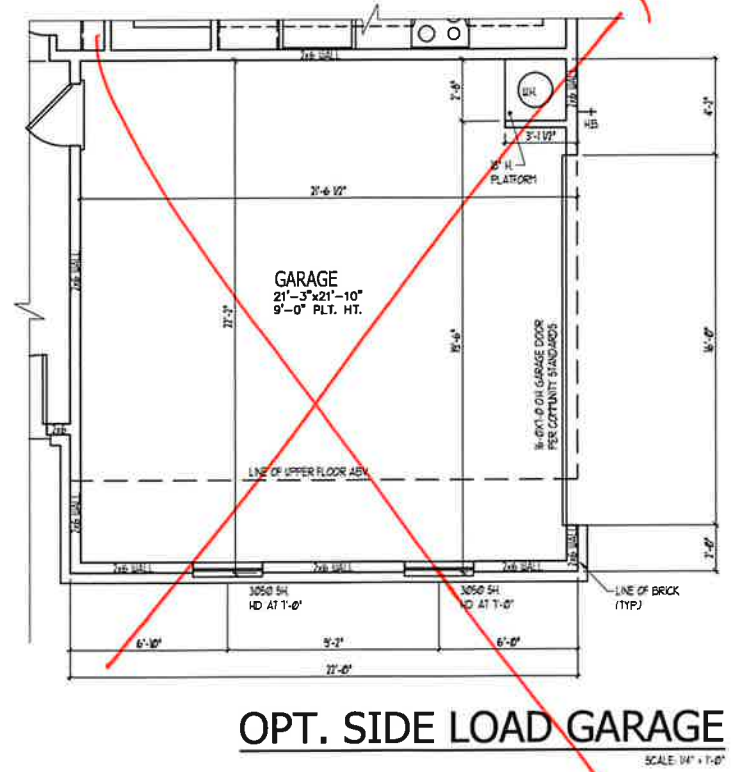
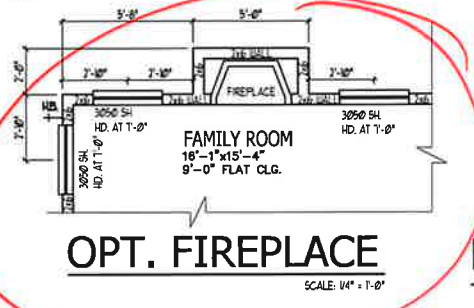
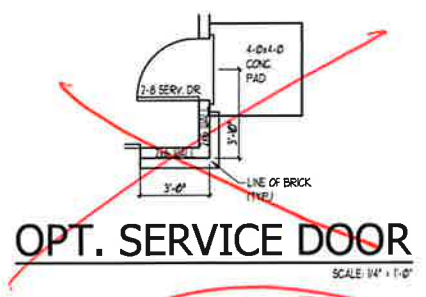
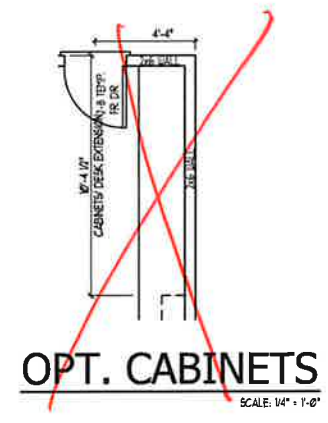
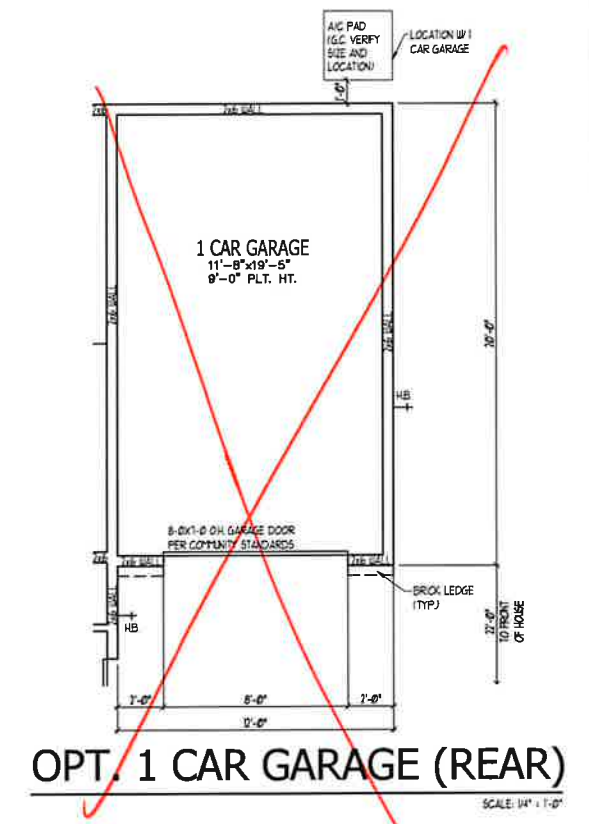
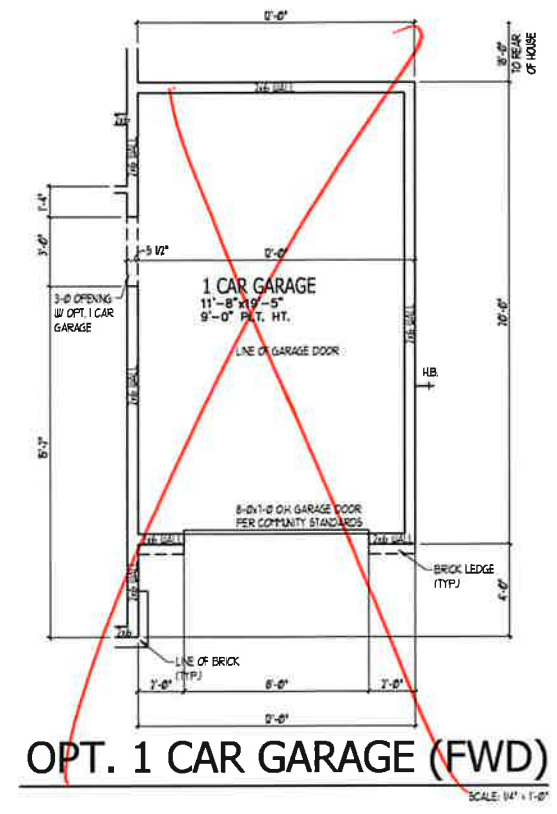
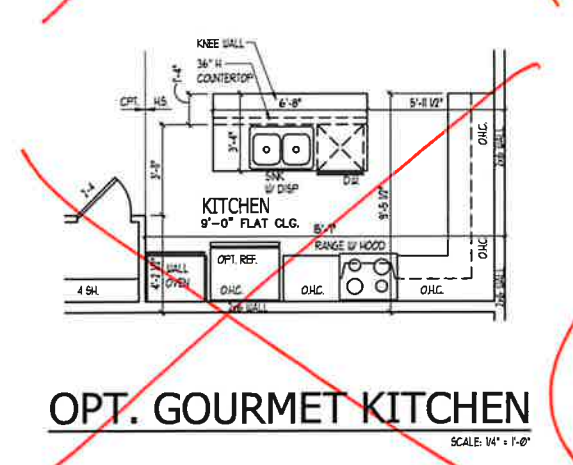
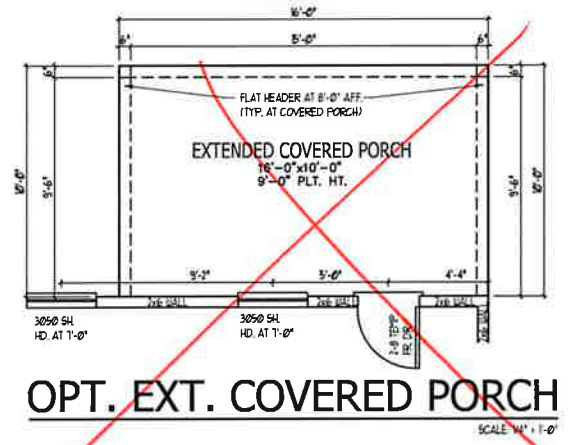
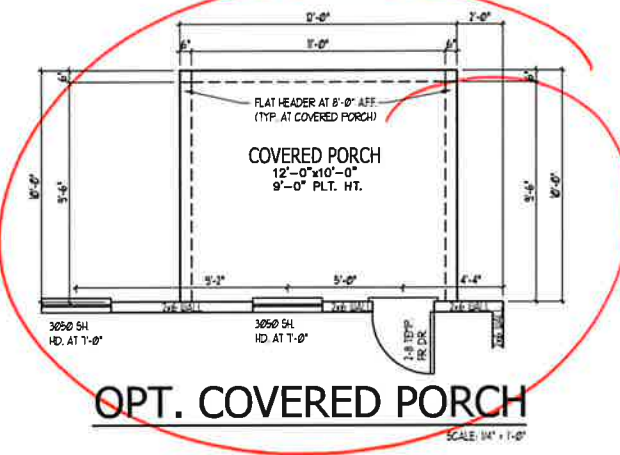
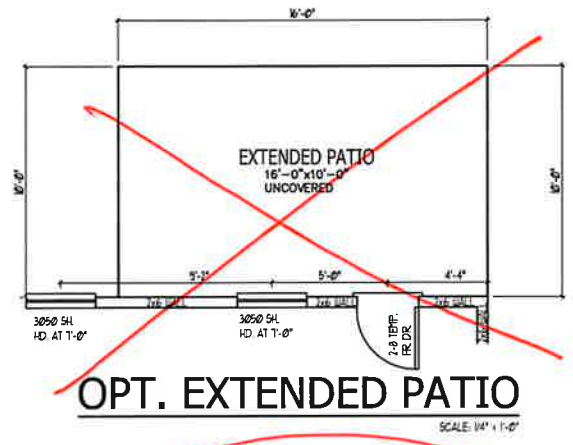

**FIRST FLOOR PLAN OPTIONS (2x6 WALL)**  
 SCALE: 1/4" = 1'-0"



JOB NUMBER	B-1818871
CAD FILE	KENZIE-R
ISSUED	07-10-19
REVISION	07-15-19
	07-24-19
	03-26-20

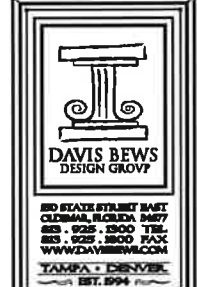

DRAWINGS ON 11"x17" SHEET ARE ONE HALF THE SCALE NOTED

**KENZIE  
 H&H HOMES**

**1958**

TITLE  
 FIRST FLOOR PLAN OPTS

SHEET  
**A3.1**





JOB NUMBER	B-1818871
DWG FILE	KENZIE-R
ISSUED	07-10-19
REVISED	07-15-19
	07-24-19
	03-26-20

**DAVIS BEWS DESIGN GROUP**

80 STATE STREET EAST  
CLEARWATER, FLORIDA 34617  
813-925-1800 TEL  
813-925-1800 FAX  
WWW.DAVISBEWS.COM

TAMPA • DENVER  
EST. 1994

DRAWINGS ON 11"x17" SHEETS ARE ONE HALF THE SCALE NOTED

**KENZIE H&H HOMES**

1958

TITLE  
SECOND FLOOR PLAN

SHEET  
**A3.2**

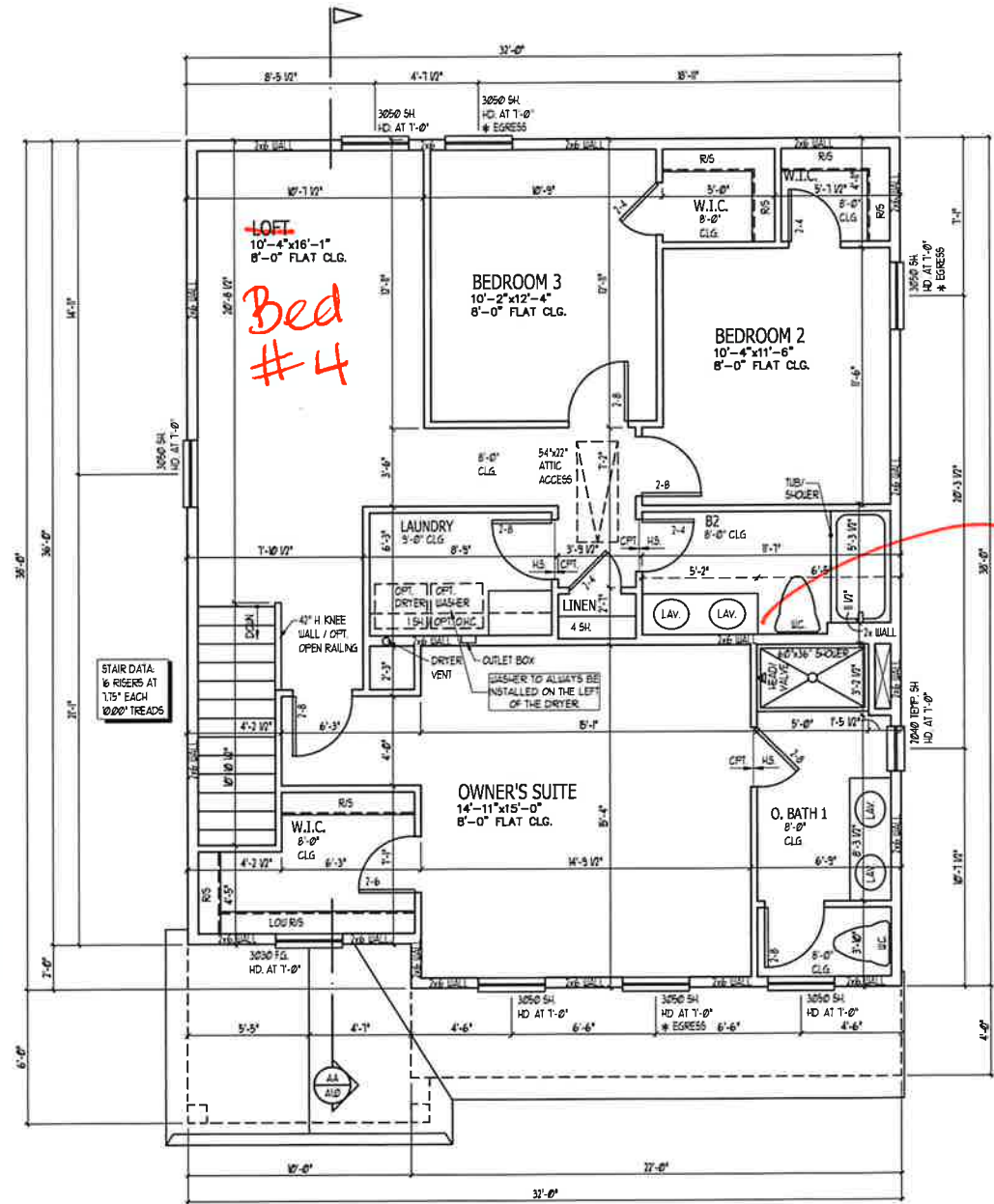
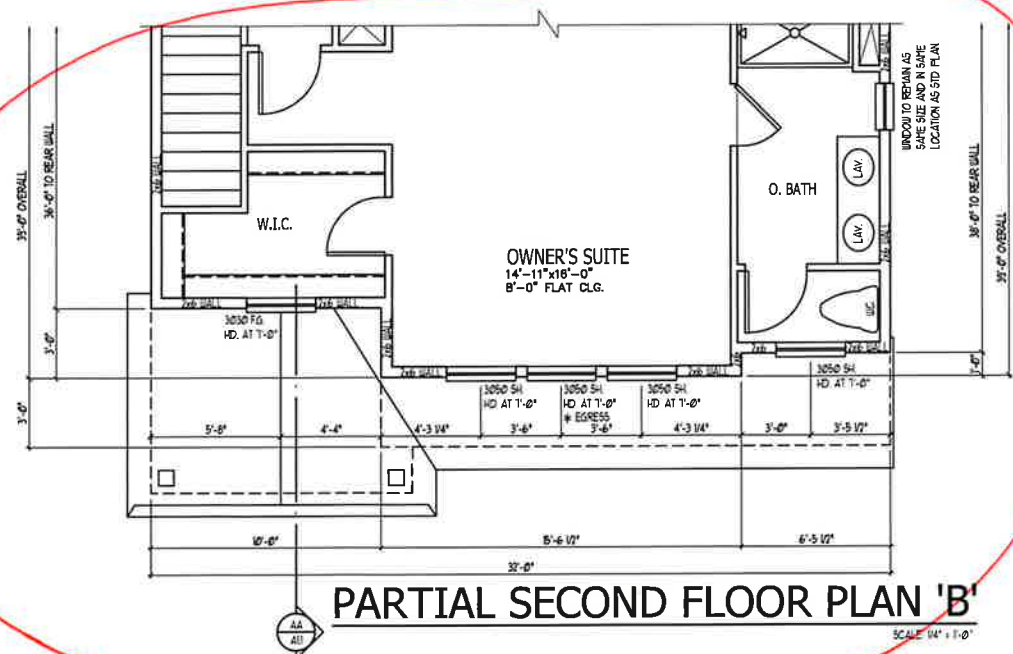
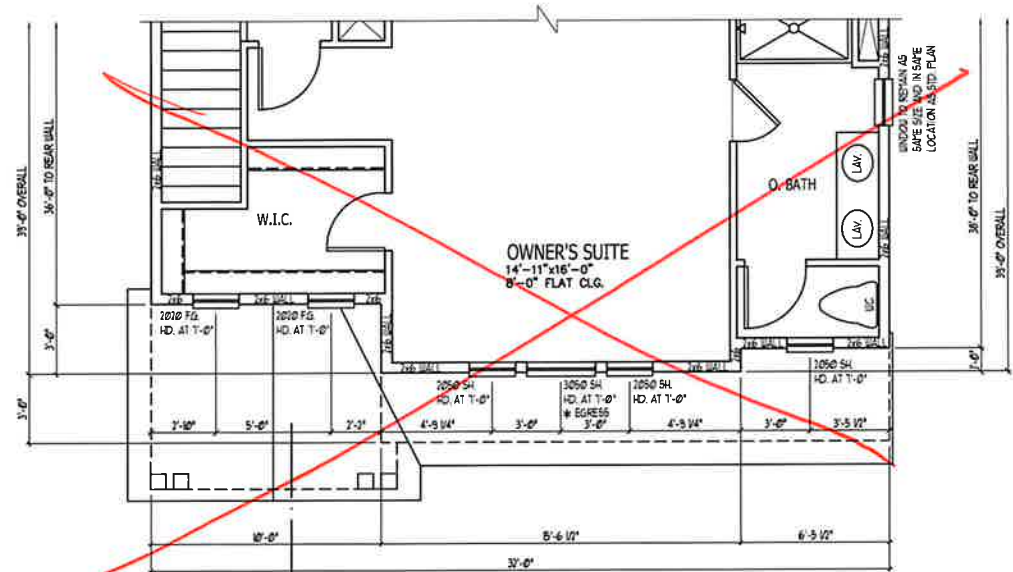

**SECOND FLOOR PLAN (2x6 WALL)**  
SCALE: 1/4" = 1'-0"

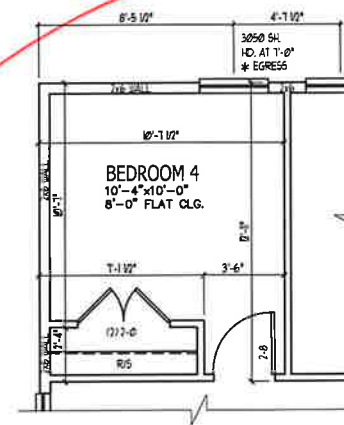

**OPT. BEDROOM 4 I.L.O. LOFT**  
SCALE: 1/4" = 1'-0"

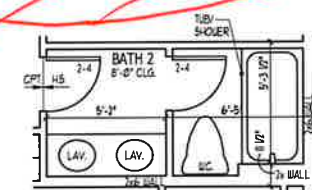

**OPT. WALL IN BATH 2**  
SCALE: 1/4" = 1'-0"



**OPT. LAUNDRY TUB**  
SCALE: 1/4" = 1'-0"



JOB NUMBER	B-1818871
CAD FILE	KENZIE-R
ISSUED	07-10-19
REVISED	07-15-19
	07-24-19
	03-26-20



80 STATE STREET EAST  
CLEARWATER, FLORIDA 34617  
888-925-3300 TEL  
888-925-3300 FAX  
WWW.DAVISBEWS.COM  
TAMPA • DENVER  
EST. 1994

DRAWINGS ON 11"x17" SHEET ARE ONE HALF THE SCALE NOTED

**KENZIE  
H&H HOMES**

1958

TITLE  
SECOND FLOOR PLAN OPTS

SHEET  
**A3.3**



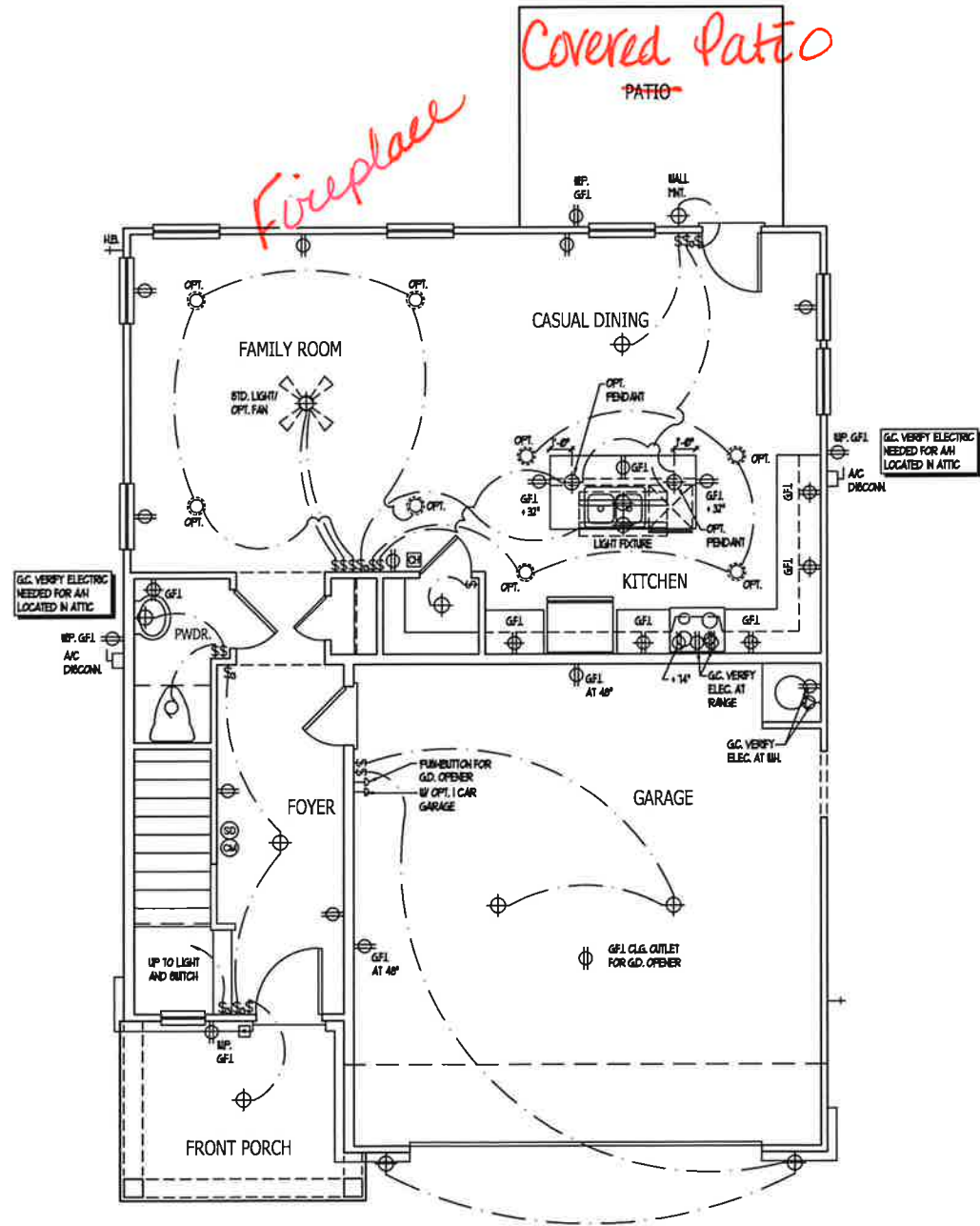
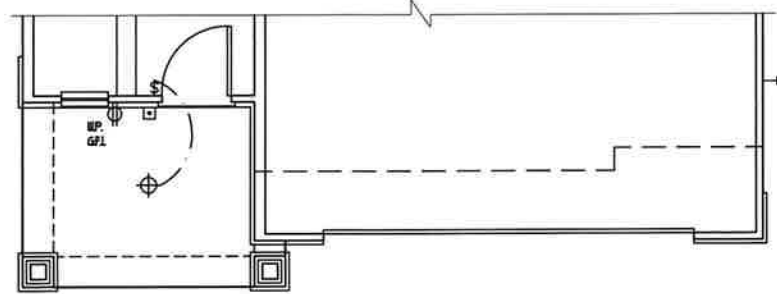
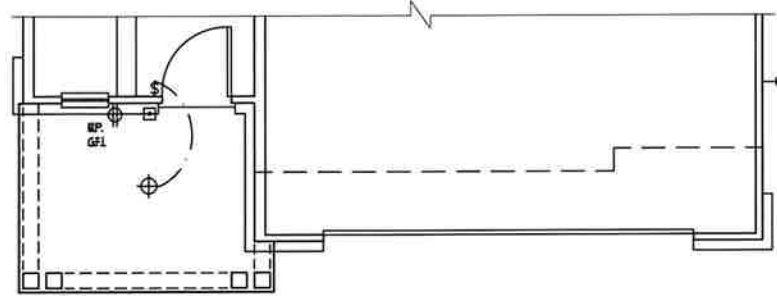

**ELECTRICAL KEY**

- ⊕ DUPLEX CONNEMENCE OUTLET
- ⊕ DUPLEX OUTLET ABOVE COUNTER
- ⊕ WEATHERPROOF DUPLEX OUTLET
- ⊕ GROUND FAULT INTERRUPTER DUPLEX OUTLET
- ⊕ HALF-SWITCHED DUPLEX OUTLET
- ⊕ SPECIAL PURPOSE OUTLET
- ⊕ DUPLEX OUTLET IN FLOOR
- ⊕ 200 VOLT OUTLET
- ⊕ WALL SWITCH
- ⊕ THREE-WAY SWITCH
- ⊕ FOUR-WAY SWITCH
- ⊕ DIMMER SWITCH
- ⊕ CEILING MOUNTED INCANDESCENT LIGHT FIXTURE
- ⊕ WALL MOUNTED INCANDESCENT LIGHT FIXTURE
- ⊕ RECESSED INCANDESCENT LIGHT FIXTURE
- ⊕ LIGHT FIXTURE WITH PULL CHAIN
- ⊕ TRACK LIGHT
- ⊕ FLUORESCENT LIGHT FIXTURE
- ⊕ EXHAUST FAN
- ⊕ EXHAUST FAN/LIGHT COMBINATION
- ⊕ ELECTRIC DOOR OPERATOR (OPTIONAL)
- ⊕ CHAIRS (OPTIONAL)
- ⊕ PUSHBUTTON SWITCH (OPTIONAL)
- ⊕ CARBON MONOXIDE DETECTOR
- ⊕ SMOKE DETECTOR
- ⊕ SMOKE / CARBON MONOXIDE COMBO DETECTOR
- ⊕ TELEPHONE (OPTIONAL)
- ⊕ TELEVISION (OPTIONAL)
- ⊕ THERMOSTAT
- ⊕ ELECTRIC METER
- ⊕ ELECTRIC PANEL
- ⊕ DISCONNECT SWITCH
- ⊕ SPEAKER (OPTIONAL)
- ⊕ ROUGH-IN FOR OPT. CEILING FAN
- ⊕ CEILING MOUNTED INCANDESCENT LIGHT FIXTURE W/ ROUGH-IN FOR OPT. CEILING FAN

**NOTES:**

1. PROVIDE AND INITIAL GROUND FAULT CIRCUIT INTERRUPTERS (GFCI) AS INDICATED ON PLANS OR AS ITEM NO. 4 AND 5 BELOW INDICATED.
2. UNLESS OTHERWISE INDICATED, INSTALL SWITCHES AND RECEPTACLES AT THE FOLLOWING HEIGHTS ABOVE FINISHED FLOOR:  
 SWITCHES... 4'-0"  
 OUTLETS... 1'-0"  
 TELEPHONE... 1'-0" (UNLESS ABOVE COUNTERTOP)  
 TELEVISION... 1'-0"
3. ALL SMOKE DETECTORS SHALL BE HARDWIRED INTO AN ELECTRICAL POWER SOURCE AND SHALL BE EQUIPPED WITH A MONITORED BATTERY BACKUP. PROVIDE AND INSTALL LOCALLY CERTIFIED BEZEL DETECTORS.
4. ALL 15A AND 20A RECEPTACLES IN SLEEPING ROOMS, FAMILY ROOMS, DINING ROOMS, LIVING ROOMS, PARLORS, LIBRARIES, DEN, BATHROOMS, RECREATION ROOMS, CLOSETS, HALLWAYS, AND SIMILAR AREAS WILL REQUIRE A COMBINATION TYPE AFCI DEVICE AND TAMPER-PROOF RECEPTACLES PER NEC 201.46(A)(2) AND 406(B).
5. ALL 15A AND 20A 120V RECEPTACLES LOCATED IN THE GARAGE AND UTILITY ROOMS SHALL BE GFCI PROTECTED (GFI).
6. IT IS THE RESPONSIBILITY OF THE LICENSED ELECTRICIAN TO ENSURE THAT ALL ELECTRICAL WORK IS IN FULL COMPLIANCE WITH NFPA 70, NEC 201, AND ALL APPLICABLE LOCAL STANDARDS, CODES, AND ORDINANCES.
7. EVERY BUILDING HAVING A FOSSIL-FUEL-BURNING HEATER OR APPLIANCE, FIREPLACE, OR AN ATTACHED GARAGE SHALL HAVE AN OPERATIONAL CARBON MONOXIDE DETECTOR INSTALLED WITHIN 10 FEET OF EACH ROOM USED FOR SLEEPING PURPOSES.
8. ALARMS SHALL RECEIVE THEIR PRIMARY POWER FROM THE BUILDING WIRING WHEN SUCH WIRING IS SERVED FROM THE LOCAL POWER UTILITY. SUCH ALARMS SHALL HAVE BATTERY BACKUP. COMBINATION SMOKE/CARBON MONOXIDE ALARMS SHALL BE LISTED OR LABELED BY A NATIONALLY RECOGNIZED TESTING LABORATORY.



JOB NUMBER	B-1818871
CAD FILE	KENZIE-R
ISSUED	07-10-19
REVISED	07-15-19
	07-24-19
	03-26-20



810 STATE STREET SUITE 200  
 CLEARWATER, FLORIDA 34617  
 813-928-1300 TEL  
 813-928-1800 FAX  
 WWW.DAVISBEWS.COM  
 TAMPA • CLEARWATER  
 EST. 1994

DRAWINGS ON 11"x17" SHEET ARE ONE HALF THE SCALE NOTED

**KENZIE  
 H&H HOMES**

1958

TITLE  
 FIRST FL. ELECT. PLAN

SHEET  
**E1**

**FIRST FLOOR ELECTRICAL PLAN**

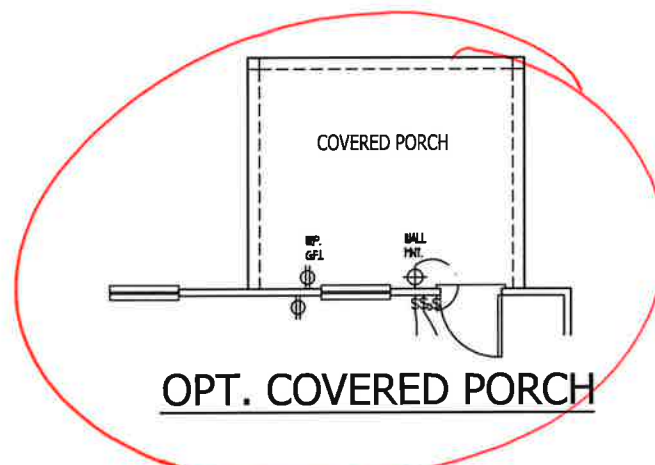
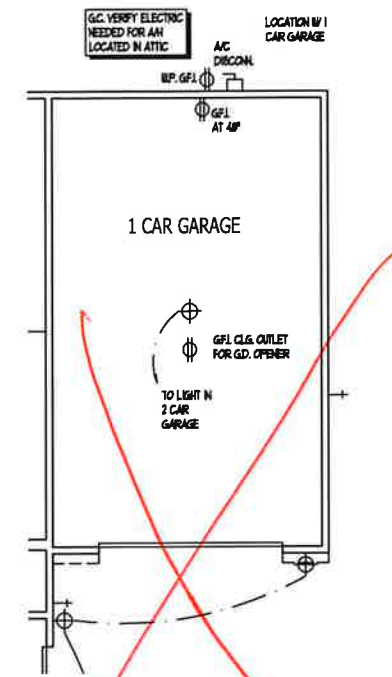
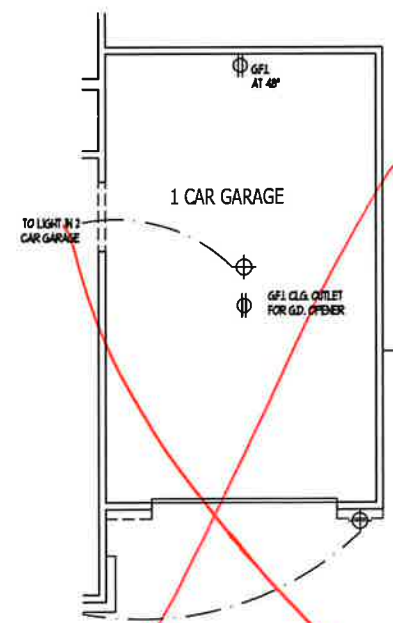
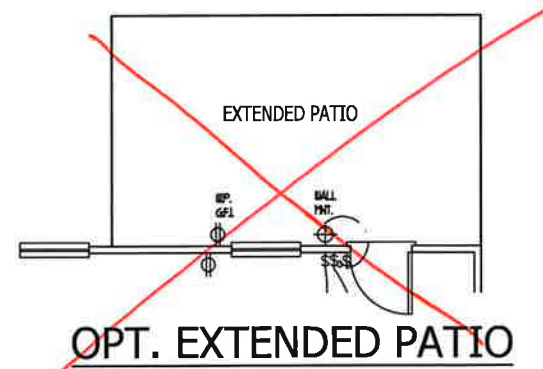

OPT. 1 CAR GARAGE (FWD)

OPT. 1 CAR GARAGE (REAR)

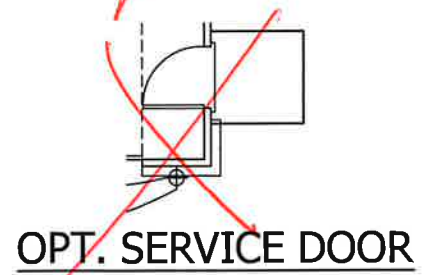
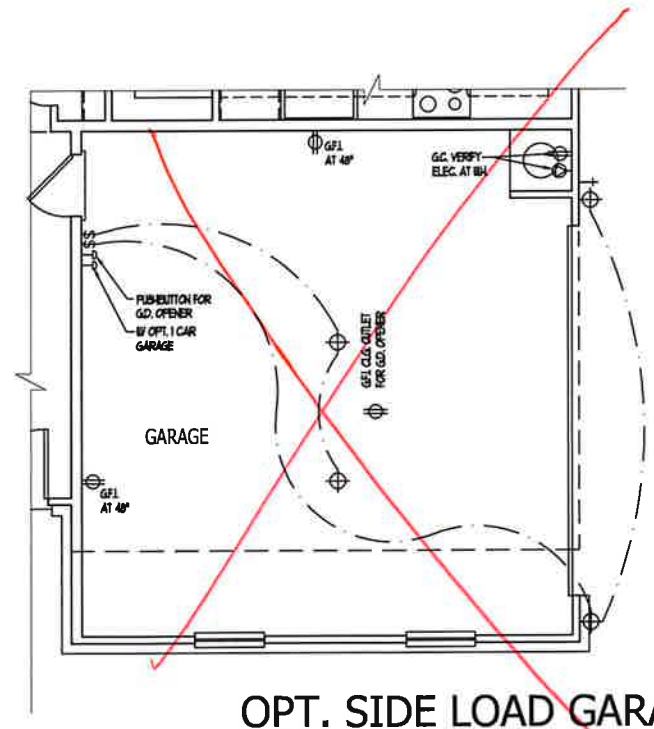
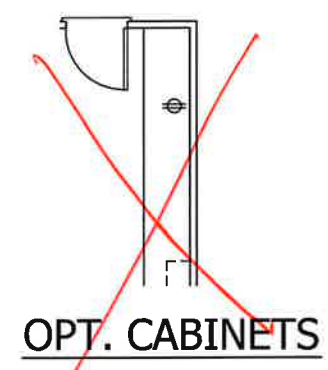
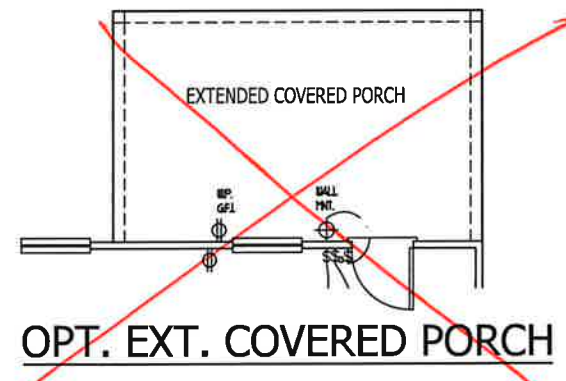

OPT. SIDE LOAD GARAGE

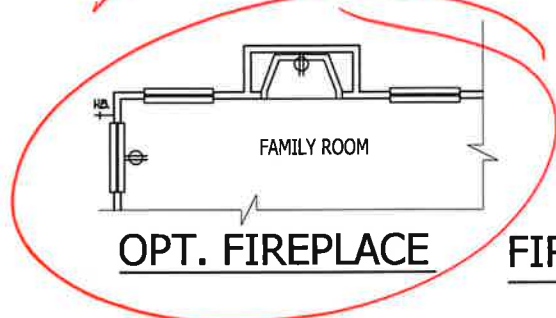
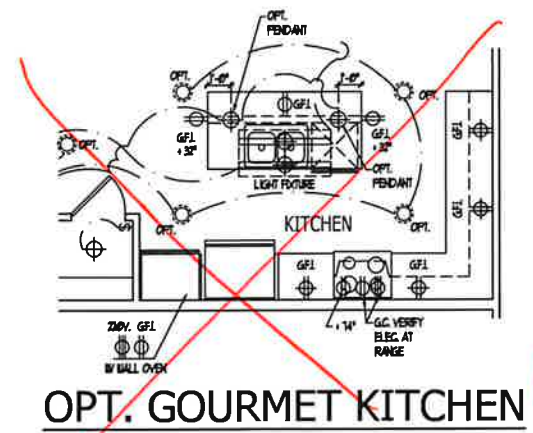

OPT. FIREPLACE

FIRST FLOOR ELECTRICAL PLAN OPTIONS



JOB NUMBER	B-1818871
CAD FILE	KENZIE-R
ISSUED	07-19-19
REVISED	07-15-19
	07-24-19
	03-26-20

**DAVIS BEWS DESIGN GROUP**

880 STATE STREET EAST  
 OLVINGDA, FLORIDA 34677  
 813-928-1800 TEL.  
 813-928-1800 FAX  
 WWW.DAVISBEWS.COM

TAMPA • DENVER  
 EST. 1994

DRAWINGS ON 11"x17"  
 SHEET ARE ONE HALF  
 THE SCALE NOTED

**KENZIE  
 H&H HOMES**

1958

TITLE  
 FIRST FL. ELECT. PLAN OPTS

SHEET  
**E1.1**



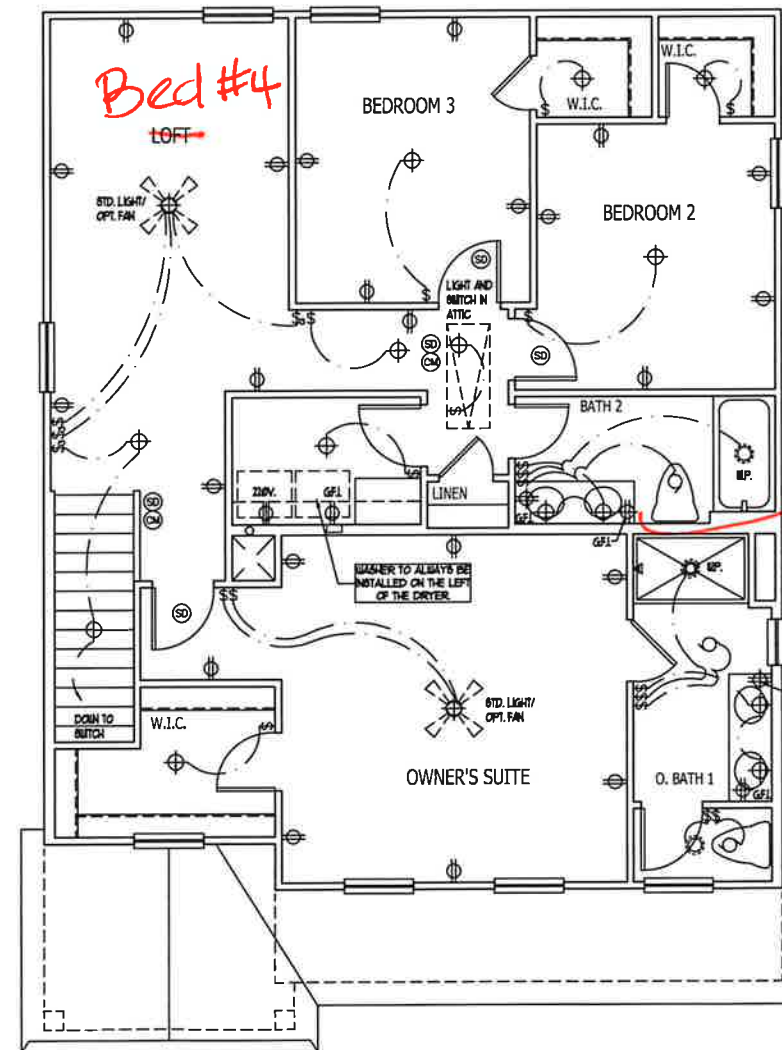
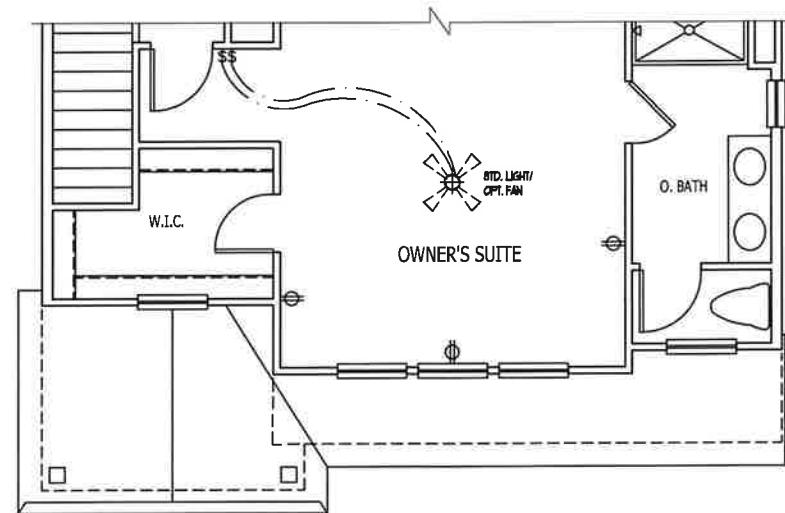
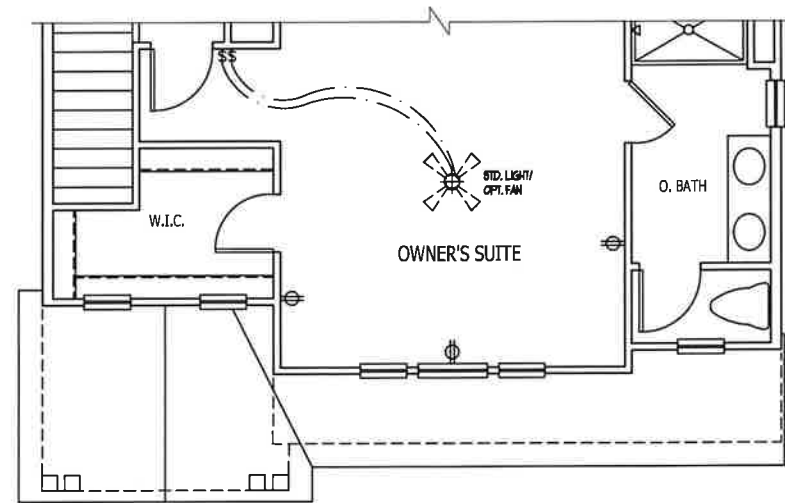

**ELECTRICAL KEY**

- ⊕ DUPLEX COMMENCEMENT OUTLET
- ⊕ DUPLEX OUTLET ABOVE COUNTER
- ⊕ WEATHERPROOF DUPLEX OUTLET
- ⊕ GROUND FAULT INTERRUPTER DUPLEX OUTLET
- ⊕ HALF-SWITCHED DUPLEX OUTLET
- ⊕ SPECIAL PURPOSE OUTLET
- ⊕ DUPLEX OUTLET IN FLOOR
- ⊕ 220 VOLT OUTLET
- ⊕ WALL SWITCH
- ⊕ THREE-WAY SWITCH
- ⊕ FOUR-WAY SWITCH
- ⊕ DIMMER SWITCH
- ⊕ CEILING MOUNTED INCANDESCENT LIGHT FIXTURE
- ⊕ WALL MOUNTED INCANDESCENT LIGHT FIXTURE
- ⊕ RECESSED INCANDESCENT LIGHT FIXTURE
- ⊕ LIGHT FIXTURE WITH FULL CHAIN
- ⊕ TRACK LIGHT
- ⊕ FLUORESCENT LIGHT FIXTURE
- ⊕ EXHAUST FAN
- ⊕ EXHAUST FAN/LIGHT COMBINATION
- ⊕ ELECTRIC DOOR OPERATOR (OPTIONAL)
- ⊕ GFI'S (OPTIONAL)
- ⊕ FUMIGATION SWITCH (OPTIONAL)
- ⊕ CARBON MONOXIDE DETECTOR
- ⊕ SMOKE DETECTOR
- ⊕ SMOKE / CARBON MON. COMBO DETECTOR
- ⊕ TELEPHONE (OPTIONAL)
- ⊕ TELEVISION (OPTIONAL)
- ⊕ THERMOSTAT
- ⊕ ELECTRIC METER
- ⊕ ELECTRIC PANEL
- ⊕ DISCONNECT SWITCH
- ⊕ SPEAKER (OPTIONAL)
- ⊕ ROUGH-IN FOR OPT. CEILING FAN
- ⊕ CEILING MOUNTED INCANDESCENT LIGHT FIXTURE W/ ROUGH-IN FOR OPT. CEILING FAN

**NOTES:**

1. PROVIDE AND INSTALL GROUND FAULT CIRCUIT INTERRUPTER (GFCI) AS INDICATED ON PLANS OR AS ITEM NO. 4 AND 5 BELOW INDICATES.
2. UNLESS OTHERWISE INDICATED, INSTALL SWITCHES AND RECEPTACLES AT THE FOLLOWING HEIGHTS ABOVE FINISHED FLOOR:  
 SWITCHES... 4'  
 OUTLETS... 18"  
 TELEPHONE... 18" (UNLESS ABOVE COUNTERTOP)  
 TELEVISION... 18"
3. ALL SMOKE DETECTORS SHALL BE HARDCWIRED INTO AN ELECTRICAL POWER SOURCE AND SHALL BE EQUIPPED WITH A MONITORED BATTERY BACKUP. PROVIDE AND INSTALL LOCALLY CERTIFIED BESE DETECTORS.
4. ALL 15A AND 20A RECEPTACLES IN SLEEPING ROOMS, FAMILY ROOMS, DINING ROOMS, LIVING ROOMS, PARLORS, LIBRARIES, DEN, SUNROOMS, RECREATION ROOMS, CLOSETS, HALLWAYS, AND SIMILAR AREAS WILL REQUIRE A COMBINATION TYPE AFCI DEVICE AND TAMPER-PROOF RECEPTACLES PER NEC 201.406.2 AND 406.3.
5. ALL 15A AND 20A 20A 20A RECEPTACLES LOCATED IN THE GARAGE AND UTILITY ROOMS SHALL BE GFCI PROTECTED (GFI).
6. IT IS THE RESPONSIBILITY OF THE LICENSED ELECTRICIAN TO ENSURE THAT ALL ELECTRICAL WORK IS IN FULL COMPLIANCE WITH NFPA 70, NEC 200, AND ALL APPLICABLE LOCAL STANDARDS, CODES, AND ORDINANCES.
7. EVERY BUILDING HAVING A FOSSIL-FUEL-BURNING HEATER OR APPLIANCE, FIREPLACE OR AN ATTACHED GARAGE SHALL HAVE AN OPERATIONAL CARBON MONOXIDE DETECTOR INSTALLED WITHIN 10 FEET OF EACH ROOM USED FOR SLEEPING PURPOSES.
8. ALARMS SHALL RECEIVE THEIR PRIMARY POWER FROM THE BUILDING WIRING WHEN SUCH WIRING IS SERVED FROM THE LOCAL POWER UTILITY. SUCH ALARMS SHALL HAVE BATTERY BACKUP. COMBINATION SMOKE/CARBON MONOXIDE ALARMS SHALL BE LISTED OR LABELED BY A NATIONALLY RECOGNIZED TESTING LABORATORY.

**SECOND FLOOR ELECTRICAL PLAN**



JOB NUMBER	B-1818871
CAD FILE	KENZIE-R
ISSUED	07-10-19
REVISED	07-15-19
	07-24-19
	03-26-20

**DAVIS BEWS DESIGN GROUP**

880 STATE STREET EAST  
 CLEARWATER, FLORIDA 34617  
 888 - 928 - 1800 TEL  
 888 - 928 - 1800 FAX  
 WWW.DAVISBEWS.COM

TAMPA • DENVER  
 EST. 1994

DRAWINGS ON 11"x17"  
 SHEET ARE ONE HALF  
 THE SCALE NOTED

**KENZIE  
 H&H HOMES**

1958

TITLE  
 SECOND FLOOR ELECTRICAL PLAN

SHEET  
**E2**

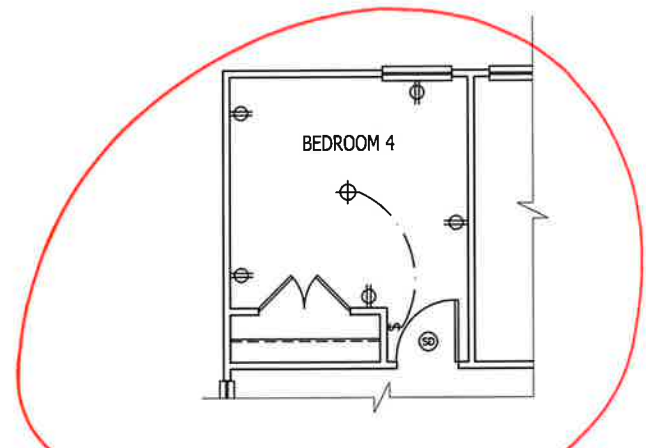

OPT. BEDROOM 4 I.L.O. LOFT

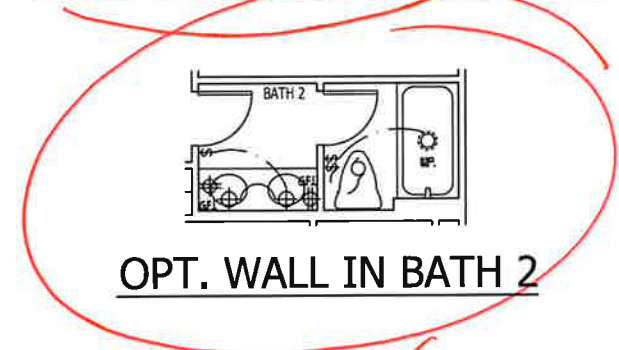

OPT. WALL IN BATH 2

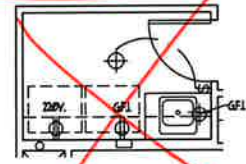

OPT. LAUNDRY TUB



JOB NUMBER	B-1818871
CAD FILE	KENZIE-R
ISSUED	07-16-19
REVISED	07-15-19
	07-24-19
	03-26-20



380 STATE STREET EAST  
 CLEARWATER, FLORIDA 34627  
 888 . 928 . 1800 TEL  
 888 . 928 . 1800 FAX  
 WWW.DAVISBEWS.COM  
 TAMPA • DENVER  
 EST. 2004

DRAWINGS ON 11"x17"  
 SHEET ARE ONE HALF  
 THE SCALE NOTED

**KENZIE  
 H&H HOMES**

1958

TITLE  
 SECOND FLOOR ELECTRICAL PLAN OPT

SHEET  
**E2.1**

SECOND FLOOR ELECTRICAL PLAN OPTIONS



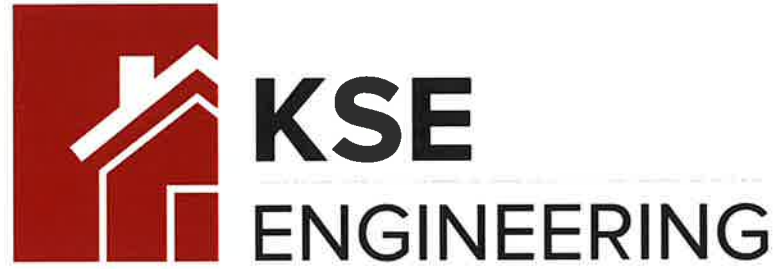

1900 AM DRIVE, SUITE 201, QUAKERTOWN, PA 18951  
 www.kse-eng.com (215) 804-4449

# KENZIE

## NORTH CAROLINA

THESE DRAWINGS ARE TO BE USED IN CONJUNCTION WITH AND COORDINATED WITH THE ARCHITECTURAL, CIVIL, MECHANICAL, ELECTRICAL, AND PLUMBING DRAWINGS. THIS COORDINATION IS NOT THE RESPONSIBILITY OF THE STRUCTURAL ENGINEER OF RECORD (SER). SHOULD ANY DISCREPANCIES BECOME APPARENT, THE CONTRACTOR SHALL NOTIFY KSE ENGINEERING, P.C. BEFORE CONSTRUCTION BEGINS. IT IS THE INTENT OF THE ENGINEER LISTED ON THESE DOCUMENTS THAT THESE DOCUMENTS BE ACCURATE, PROVIDING LICENSED PROFESSIONALS CLEAR INFORMATION. EVERY ATTEMPT HAS BEEN MADE TO PREVENT ERROR. THE BUILDER AND ALL SUBCONTRACTORS ARE REQUIRED TO REVIEW ALL OF THE INFORMATION CONTAINED IN THESE DOCUMENTS PRIOR TO THE COMMENCEMENT OF ANY WORK. THE ENGINEER IS NOT RESPONSIBLE FOR ANY PLAN ERRORS, OMISSIONS, OR MISINTERPRETATIONS UNDETECTED AND NOT REPORTED TO THE ENGINEER PRIOR TO CONSTRUCTION. ALL CONSTRUCTION MUST BE IN ACCORDANCE TO THE INFORMATION FOUND IN THESE DOCUMENTS.

### DESIGN SPECIFICATIONS:

DESIGN BUILDING CODE (REFERRED TO HEREIN AS 'THE BUILDING CODE'):  
 • 2018 NORTH CAROLINA RESIDENTIAL CODE. WALL BRACING PER INTERNATIONAL RESIDENTIAL CODE 2015 EDITION.

DESIGN LIVE LOADS:  
 • ROOF = 20 PSF (LOAD DURATION FACTOR=1.25)  
 • UNINHABITABLE ATTICS WITH LIMITED STORAGE = 20 PSF (WHERE SPECIFIED ON PLANS)  
 • HABITABLE ATTICS AND ATTICS SERVED WITH FIXED STAIRS = 30 PSF  
 • FLOOR = 40 PSF  
 • FLOOR (SLEEPING AREAS) = 30 PSF  
 • DECK = 40 PSF  
 • BALCONY = 40 PSF  
 • STAIRS = 40 PSF

DESIGN DEAD LOADS:  
 • ROOF TRUSS = 17 PSF (TC=7, BC=10)  
 • FLOOR TRUSS = 15 PSF (TC=10, BC=5)  
 • FLOOR JOIST = 10 PSF  
 • QUEEN ANNE BRICK = 25 PSF

\*NOTE: STRUCTURAL FRAMING HAS NOT BEEN DESIGNED FOR TILE, GRANITE, MARBLE OR OTHER MATERIALS HEAVIER THAN THE ABOVE LOADING UNLESS SPECIFICALLY NOTED ON PLANS.\*

DESIGN WIND LOADS:  
 • ULTIMATE WIND SPEED = Up to 130 MPH  
 • EXPOSURE CATEGORY = B

ASSUMED SOIL BEARING CAPACITY = 2000 PSF

ASSUMED LATERAL SOIL PRESSURE = 45 PCF

FROST DEPTH = 12"

SEISMIC DESIGN CATEGORY = B

ENGINEERED LUMBER SHALL HAVE THE FOLLOWING MINIMUM DESIGN VALUES:

- TJI 210 SERIES (SERIES AND SPACING PER PLANS)
- LSL: E=1,550,000 PSI, F<sub>b</sub>=2,325 PSI, F<sub>v</sub>=310 PSI, F<sub>c</sub>=900 PSI
- LVL: E=2,000,000 PSI, F<sub>b</sub>=2,600 PSI, F<sub>v</sub>=285 PSI, F<sub>c</sub>=750 PSI
- PSL: E=2,100,000 PSI, F<sub>b</sub>=2,900 PSI, F<sub>v</sub>=290 PSI, F<sub>c</sub>=625 PSI

THIS PLAN HAS BEEN DESIGNED PER THE 2018 EDITION OF THE NC RESIDENTIAL CODE. WHERE FRAMING, FOUNDATION, OR OTHER STRUCTURAL ITEMS DO NOT COMPLY WITH THE PRESCRIPTIVE METHODS OF THE CODE, THOSE ITEMS HAVE BEEN DESIGNED IN ACCORDANCE WITH ACCEPTED ENGINEERING PRACTICE PER NCRC R301.1.3.



Cover Sheet  
 Kenzie Model - RH  
 Up to 130 M.P.H.

Project #:	105-19004
Designed By:	KRK
Checked By:	
Issue Date:	8/29/19
Re-Issue:	4/30/20
Scale:	1/8"=1'-0" @ 11x17 1/4"=1'-0" @ 22x34

S-0

## GENERAL STRUCTURAL NOTES:

- THE DESIGN PROFESSIONAL WHOSE SEAL APPEARS ON THESE DRAWINGS IS THE STRUCTURAL ENGINEER OF RECORD (SER) FOR THIS PROJECT. THE SER BEARS THE RESPONSIBILITY OF THE PRIMARY STRUCTURAL ELEMENTS AND THE PERFORMANCE OF THIS STRUCTURE. NO OTHER PARTY MAY REVISE, ALTER, OR DELETE ANY STRUCTURAL ASPECTS OF THESE CONSTRUCTION DOCUMENTS WITHOUT WRITTEN CONSENT OF KSE ENGINEERING, P.C. OR THE SER. FOR THE PURPOSES OF THESE CONSTRUCTION DOCUMENTS, THE SER AND KSE ENGINEERING SHALL BE CONSIDERED THE SAME ENTITY.
- THE STRUCTURE IS ONLY STABLE IN ITS COMPLETED FORM. THE CONTRACTOR SHALL PROVIDE ALL REQUIRED TEMPORARY BRACING DURING CONSTRUCTION TO STABILIZE THE STRUCTURE.
- THE SER IS NOT RESPONSIBLE FOR CONSTRUCTION SEQUENCES, METHODS, OR TECHNIQUES IN CONNECTION WITH THE CONSTRUCTION OF THIS STRUCTURE. THE SER WILL NOT BE HELD RESPONSIBLE FOR THE CONTRACTOR'S FAILURE TO CONFORM TO THE CONTRACT DOCUMENTS, SHOULD ANY NON-COMPLIANCE OCCUR.
- THE SER DOES NOT CERTIFY DIMENSIONAL ACCURACY OR ARCHITECTURAL LAYOUT INCLUDING ROOF GEOMETRY. THE SER ASSUMES NO LIABILITY FOR CHANGES MADE TO THESE PLANS BY OTHERS, OR FOR CONSTRUCTION METHODS, OR FOR ANY DEVIATION FROM THE PLANS. THE SER SHALL BE NOTIFIED PRIOR TO CONSTRUCTION IF ANY DISCREPANCIES ARE NOTED ON THE PLANS. ANY STRUCTURAL ELEMENTS OR DETAILS NOT FULLY DEVELOPED ON THE CONSTRUCTION DRAWINGS SHALL BE COMPLETED UNDER THE DIRECTION OF A LICENSED PROFESSIONAL ENGINEER. THESE SHOP DRAWINGS SHALL BE SUBMITTED TO KSE ENGINEERING FOR REVIEW BEFORE ANY CONSTRUCTION BEGINS. THE SHOP DRAWINGS WILL BE REVIEWED FOR OVERALL COMPLIANCE AS IT RELATES TO THE STRUCTURAL DESIGN OF THIS PROJECT. VERIFICATION OF THE SHOP DRAWINGS FOR DIMENSIONS, OR FOR ACTUAL FIELD CONDITIONS, IS NOT THE RESPONSIBILITY OF THE SER OR KSE ENGINEERING, P.C.
- VERIFICATION OF ASSUMED FIELD CONDITIONS IS NOT THE RESPONSIBILITY OF THE SER. THE CONTRACTOR SHALL VERIFY THE FIELD CONDITIONS FOR ACCURACY AND REPORT ANY DISCREPANCIES TO KSE ENGINEERING, P.C. BEFORE CONSTRUCTION BEGINS.
- THE SER IS NOT RESPONSIBLE FOR ANY SECONDARY STRUCTURAL ELEMENTS OR NON-STRUCTURAL ELEMENTS, EXCEPT FOR THE ELEMENTS SPECIFICALLY NOTED ON THE STRUCTURAL DRAWINGS.
- THIS STRUCTURE AND ALL CONSTRUCTION SHALL CONFORM TO ALL APPLICABLE SECTIONS OF THE BUILDING CODE AND ANY LOCAL CODES OR RESTRICTIONS.
- DO NOT SCALE DRAWINGS. WRITTEN DIMENSIONS TAKE PRECEDENCE OVER SCALED DIMENSIONS. ALL DIMENSIONS ARE TO FACE OF STUD OR TO FACE OF FRAMING UNLESS OTHERWISE NOTED.
- PROVIDE MOISTURE PROTECTION AND FLASHING PER ARCHITECTURAL DETAILS.

## FOUNDATIONS:

- FOUNDATIONS SHALL BE CONSTRUCTED IN ACCORDANCE WITH CHAPTER 4 OF THE BUILDING CODE.
- CONTRACTOR IS SOLELY RESPONSIBLE FOR VERIFYING THE SUITABILITY OF THE SITE SOIL CONDITIONS AT THE TIME OF CONSTRUCTION. THE BUILDER SHALL FURNISH ANY AND ALL REPORTS RECEIVED FROM THE GEOTECHNICAL ENGINEER ON THE STUDY OF THE PROPOSED SITE TO THE DESIGNER, STRUCTURAL ENGINEER, AND GENERAL CONTRACTOR.
- MAXIMUM DEPTH OF UNBALANCED FILL AGAINST MASONRY WALLS TO BE AS SPECIFIED IN THE BUILDING CODE.
- THE SER HAS NOT PERFORMED A SUBSURFACE INVESTIGATION. VERIFICATION OF THE ASSUMED VALUE IS THE RESPONSIBILITY OF THE OWNER OR THE CONTRACTOR. SHOULD ANY ADVERSE SOIL CONDITION BE ENCOUNTERED, THE SER MUST BE CONTACTED BEFORE PROCEEDING.
- THE BOTTOM OF ALL FOOTINGS SHALL EXTEND BELOW THE FROST LINE FOR THE REGION IN WHICH THE STRUCTURE IS TO BE CONSTRUCTED, BUT NOT LESS THAN A MINIMUM OF 12" BELOW GRADE. ALL FOOTINGS TO HAVE A MINIMUM PROJECTION OF 2" ON EACH SIDE OF FOUNDATION WALLS. MAXIMUM FOOTING PROJECTION SHALL NOT EXCEED THE THICKNESS OF THE FOOTING.
- WOOD SILL PLATES SHALL BE ANCHORED TO THE FOUNDATION WITH 1/2" ANCHOR BOLTS WITH MINIMUM 7" EMBEDMENT, SPACED A MAXIMUM OF 6'-0" O.C. INSTALL MINIMUM 2 ANCHOR BOLTS PER SECTION, 12" MAXIMUM FROM CORNERS, 1/2" DIAMETER x 8" LONG SIMPSON TITEN HD OR USP SCREW-BOLT+ SCREWS MAY BE SUBSTITUTED ON A 1 FOR 1 BASIS.
- ANY FILL SHALL BE PLACED UNDER THE DIRECTION OR RECOMMENDATION OF A LICENSED PROFESSIONAL ENGINEER. THE RESULTING SOIL SHALL BE COMPACTED TO A MINIMUM OF 95% MAXIMUM DRY DENSITY.
- EXCAVATIONS OF FOOTINGS SHALL BE LINED TEMPORARILY WITH A 6 MIL POLYETHYLENE MEMBRANE IF PLACEMENT OF CONCRETE DOES NOT OCCUR WITHIN 24 HOURS OF EXCAVATION.
- NO CONCRETE SHALL BE PLACED AGAINST ANY SUBGRADE CONTAINING WATER, ICE, FROST, OR LOOSE MATERIAL.
- PROVIDE FOUNDATION WATERPROOFING AND DRAIN WITH POSITIVE SLOPE TO OUTLET AS REQUIRED BY SITE CONDITIONS (SEE ARCHITECTURAL PLANS AND DETAILS).
- NONE OF THE FOUNDATION DESIGNS IN THESE DOCUMENTS ARE SUITABLE FOR INSTALLATION IN SHRINK/SWELL CONDITIONS. REFER TO GEOTECHNICAL ENGINEER FOR APPROPRIATE DESIGN.
- LOTS SHALL BE GRADED TO DRAIN SURFACE WATER AWAY FROM FOUNDATION WALLS. THE GRADE SHALL FALL A MINIMUM OF 6 INCHES WITHIN THE FIRST TEN FEET.
- CRAWL SPACE TO BE GRADED LEVEL AND CLEAR OF ALL DEBRIS.
- PROVIDE MINIMUM 6 MIL APPROVED VAPOR BARRIER. ALL JOINTS TO BE LAPPED MINIMUM 12" AND SEALED.

## CONCRETE & REINFORCING

- CONCRETE DESIGN BASED ON ACI 318 AND ACI 318.1 OR ACI 332. CONCRETE SHALL HAVE A NORMAL WEIGHT AGGREGATE AND A MINIMUM COMPRESSIVE STRENGTH ( $f'_c$ ) = 3,000 PSI MINIMUM AT 28 DAYS PER CODE (VARIES W/ WEATHER), UNLESS OTHERWISE NOTED ON THE PLAN.
- CONCRETE SHALL BE PROPORTIONED, MIXED, AND PLACED IN ACCORDANCE WITH THE LATEST EDITIONS OF ACI 318: "BUILDING CODE REQUIREMENTS FOR REINFORCED CONCRETE" AND ACI 301: "SPECIFICATIONS FOR STRUCTURAL CONCRETE FOR BUILDINGS".
- AIR ENTRAINMENT CONCRETE MUST BE USED FOR ALL STRUCTURAL ELEMENTS EXPOSED TO FREEZE/THAW CYCLES AND DEICING CHEMICALS. AIR ENTRAINMENT AMOUNTS (IN PERCENT) SHALL BE WITHIN -1% TO +2% OF 5% FOR FOOTINGS AND EXTERIOR SLABS.
- NO ADMIXTURES SHALL BE ADDED TO ANY STRUCTURAL CONCRETE WITHOUT WRITTEN PERMISSION OF THE SER. WATER ADDED TO CONCRETE ON SITE SHALL NOT EXCEED THAT ALLOWED BY THE MIX DESIGN.
- CONCRETE SLABS-ON-GRADE SHALL BE CONSTRUCTED IN ACCORDANCE WITH ACI 302.1R: "GUIDE FOR CONCRETE SLAB AND SLAB CONSTRUCTION".
- CONTROL OR SAW CUT JOINTS (CUT OR TOOLED) SHALL BE SPACED IN INTERIOR SLABS-ON-GRADE AT A MAXIMUM OF 15'-0" O.C. AND IN EXTERIOR SLABS-ON-GRADE AT A MAXIMUM OF 10'-0" UNLESS OTHERWISE NOTED. CARE SHALL BE TAKEN TO AVOID RE-ENTRANT CORNERS.
- CONTROL OR SAW CUT JOINTS SHALL BE PRODUCED USING CONVENTIONAL CUT OR TOOLED PROCESSES WITHIN 4 TO 12 HOURS AFTER THE SLAB HAS BEEN FINISHED.
- ALL WELDED WIRE FABRIC (W.W.F.) FOR CONCRETE SLABS-ON-GRADE SHALL BE PLACED AT MID-DEPTH OF SLAB. THE W.W.F. SHALL BE SECURELY SUPPORTED DURING THE CONCRETE POUR. FIBROUS CONCRETE REINFORCEMENT, OR POLYPROPYLENE FIBERS MAY BE USED IN LIEU OF W.W.F. APPLICATION OF POLYPROPYLENE FIBERS PER CUBIC YARD OF CONCRETE SHALL BE PER MANUFACTURER AND COMPLY WITH ASTM C1116, ANY LOCAL BUILDING CODE REQUIREMENTS AND SHALL MEET OR EXCEED CURRENT INDUSTRY STANDARD.
- POLYPROPYLENE REINFORCING TO BE 100% VIRGIN, CONTAINING NO REPROCESSED OLEFIN MATERIALS AND SPECIFICALLY MANUFACTURED FOR USE AS CONCRETE SECONDARY REINFORCEMENT.
- STEEL REINFORCING BARS SHALL BE NEW BILLET STEEL CONFORMING TO ASTM A615, GRADE 60.
- DETAILING, FABRICATION, AND PLACEMENT OF REINFORCING STEEL SHALL BE IN ACCORDANCE WITH THE LATEST EDITION OF ACI 315: "MANUAL OF STANDARD PRACTICE FOR DETAILING CONCRETE STRUCTURES".
- HORIZONTAL FOOTING AND WALL REINFORCEMENT SHALL BE CONTINUOUS AND SHALL HAVE 90° BENDS, OR CORNER BARS WITH THE SAME SIZE/SPACING AS THE HORIZONTAL REINFORCEMENT.
- PROVIDE REINFORCEMENT LAP AS NOTED BELOW, UNLESS NOTED OTHERWISE:  
#4 BARS - 30" LENGTH  
#5 BARS - 38" LENGTH  
#6 BARS - 45" LENGTH
- WHERE REINFORCING DOWELS ARE REQUIRED, THEY SHALL BE EQUIVALENT IN SIZE AND SPACING TO THE VERTICAL REINFORCEMENT. THE DOWEL SHALL EXTEND 48 BAR DIAMETERS VERTICALLY AND 20 BAR DIAMETERS INTO THE FOOTING. SEE KSE FOUNDATION DETAILS.
- WHERE FOOTING BOTTOMS ARE TO BE STEPPED AT SLOPING GRADE CONDITIONS, PROVIDE CONTINUOUS REINFORCING WITH Z BARS (TO MATCH FOOTING REINFORCING) AS REQUIRED.
- BAR SUPPORT ACCESSORIES SHALL BE PROVIDED IN ACCORDANCE WITH THE LATEST ACI MANUAL OF STANDARD PRACTICE FOR DETAILING REINFORCED CONCRETE STRUCTURES, EXCEPT THAT REINFORCING SHALL BE CHAIRED ON THE BOTTOM AND/OR THE SIDES ON BOLSTERS SPACED NOT MORE THAN 4 FEET ON CENTER. NO ROCKS, CMU, CLAY TILE, OR BRICK SHALL BE USED TO SUPPORT REINFORCING.
- FOR GRADE SUPPORTED SLABS, SLAB REINFORCING SHALL BE HELD IN PLACE BY BAR SUPPORTS AND ACCESSORIES AS DESCRIBED IN THE CRSI MANUAL OF STANDARD PRACTICE. BAR SUPPORTS SHALL BE SPACED A MAXIMUM OF 4'-0" O.C. BOTH WAYS IN STRAIGHT LINES ON THE MESH GRID.

## MASONRY

- ALL MASONRY SHALL CONFORM TO ASTM C-90,  $F'_m=1500$  PSI. ALL BRICK SHALL CONFORM TO ASTM C-216,  $F'_m=1500$  PSI. ALL MORTAR SHALL BE TYPE 'S' (TYPE 'M' BELOW GRADE) AND CONFORM TO ASTM C-270. COARSE GROUT SHALL CONFORM TO ASTM C-476 WITH A MAXIMUM AGGREGATE SIZE OF 3/8" AND A MINIMUM COMPRESSIVE STRENGTH OF 2,000 PSI.
- ALL MASONRY WORK SHALL BE IN ACCORDANCE WITH "BUILDING CODE REQUIREMENTS FOR MASONRY STRUCTURES" ACI 530/ASCE 5/TMS 402 AND "SPECIFICATIONS FOR MASONRY STRUCTURES" ACI 530.1/ ASCE 6/TMS 602. THE UNSUPPORTED HEIGHT OF SOLID MASONRY PIERS SHALL NOT EXCEED TEN TIMES THEIR LEAST DIMENSION. UNFILLED HOLLOW PIERS MAY BE USED IF THE UNSUPPORTED HEIGHT IS NOT MORE THAN FOUR TIMES THEIR LEAST DIMENSION.
- EACH CRAWL SPACE PIER SHALL BEAR IN THE MIDDLE THIRD OF ITS RESPECTIVE FOOTING AND EACH GIRDER SHALL BEAR IN THE MIDDLE THIRD OF THE PIERS. PLASTERERS TO BE BONDED TO PERIMETER FOUNDATION WALL.
- TOP COURSE OF MASONRY SHALL BE GROUTED SOLID.
- HORIZONTAL WALL JOINT REINFORCEMENT SHALL BE STANDARD 9 GAGE GALVANIZED LADDER OR TRUSS TYPE SPACED AT 16" O.C., UNLESS SHOWN OTHERWISE ON THE DRAWINGS.
- SPliced WIRE REINFORCEMENT SHALL BE LAPPED AT LEAST 6" AND CONTAIN AT LEAST ONE CROSS WIRE OF EACH PIECE OF REINFORCEMENT WITHIN THE 6". LAP WITH STANDARD 'T' AND 'L' SHAPED PIECES AT INTERSECTIONS AND CORNERS.

## WOOD FRAMING:

- SOLID SAWN WOOD FRAMING MEMBERS SHALL CONFORM TO THE SPECIFICATIONS LISTED IN THE LATEST EDITION OF THE "NATIONAL DESIGN SPECIFICATION FOR WOOD CONSTRUCTION": (NDS), UNLESS OTHERWISE NOTED, ALL WOOD FRAMING MEMBERS ARE DESIGNED TO BE:  
SPRUCE-PINE-FIR (SPF) WITH THE FOLLOWING MINIMUM DESIGN VALUES:  
E=1,400,000 PSI,  $F_b=875$  PSI,  $F_v=135$  PSI  
1.1. FRAMING: SPF #2.  
1.2. PLATES: SPF #2.  
1.3. STUDS: SPF STUD GRADE.
- WALL STUD SPACING, (MAXIMUM 10' NOMINAL PLATE HEIGHT):  
1 & 2 STORY EXTERIOR AND INTERIOR BEARING:  
2x4 @ 16" O.C. OR 2x6 @ 24" O.C., U.N.O.  
BOTTOM OF 3 STORIES EXTERIOR AND INTERIOR BEARING:  
2x6 @ 16" O.C., U.N.O.  
INTERIOR NON-BEARING:  
2x @ 24" O.C., U.N.O.
- ALL LUMBER EXPOSED TO WEATHER OR IN CONTACT WITH CONCRETE SHALL BE PRESERVATIVE TREATED SOUTHERN YELLOW PINE #2 OR BETTER.
- ANCHOR SILL PLATES IN ACCORDANCE W/ GENERAL STRUCTURAL NOTES.
- ALL BEAMS SPECIFIED ARE MINIMUM SIZES ONLY. LARGER MEMBERS MAY BE SUBSTITUTED AS NEEDED FOR EASE OF CONSTRUCTION.
- NAILS SHALL BE COMMON WIRE NAILS UNLESS OTHERWISE NOTED.
- BOLT HOLES AND LEAD HOLES FOR LAG SCREWS SHALL BE IN ACCORDANCE WITH NDS SPECIFICATIONS.
- INDIVIDUAL STUDS FORMING A COLUMN SHALL BE ATTACHED WITH (2) ROWS 10d NAILS @ 6" O.C. STAGGERED. THE STUD COLUMN SHALL BE FULLY BLOCKED AT ALL FLOOR LEVELS TO ENSURE PROPER LOAD TRANSFER. WALL SHEATHING SHALL BE NAILED TO EDGE OF EACH STUD.
- FACE NAIL ALL MULTI-PLY BEAMS AND HEADERS WITH (2) ROWS 16d COMMON NAILS @ 16" O.C., STAGGERED, OR PER MANUFACTURER'S SPECIFICATIONS FOR ENGINEERED LUMBER. APPLY NAILING FROM BOTH FACES FOR (3) OR MORE PLYS.
- FASTEN 4-PLY BEAMS WITH (1) 1/2" DIAMETER THROUGH BOLT W/ NUTS AND WASHERS AT 12" O.C. STAGGERED TOP AND BOTTOM, 1/2" MINIMUM EDGE DISTANCE. (UNLESS OTHERWISE NOTED)
- ALL BEAMS AND HEADERS SHALL HAVE (1)2x JACK STUD & (1)2x KING STUD UNLESS OTHERWISE NOTED. THE NUMBER OF STUDS INDICATED ON PLANS ARE THE TOTAL NUMBER OF JACK STUDS REQUIRED, UNLESS OTHERWISE NOTED.
- PROVIDE KING STUDS AT EACH END OF HEADERS AS NOTED BELOW.  
(1) STUD UP TO 6' OPENING  
(2) STUDS UP TO 6' OPENING  
(3) STUDS UP TO 9' OPENING
- ALL BEAMS TO BE CONTINUOUSLY SUPPORTED Laterally AND SHALL BEAR FULL WIDTH ON THE SUPPORTING WALLS OR COLUMNS INDICATED WITH A MINIMUM OF TWO STUDS, UNLESS OTHERWISE NOTED. ALL BEAM SPLICES SHALL OCCUR OVER SUPPORTS.
- SOLID BLOCKING TO BE PROVIDED AT ALL POINT LOADS THROUGH FLOOR LEVELS TO THE FOUNDATION OR TO OTHER STRUCTURAL COMPONENTS.
- ALL LUMBER SPECIFIED ON DRAWINGS IS INTENDED FOR DRY USE ONLY (MOISTURE CONTENT <19%) UNLESS OTHERWISE NOTED.
- ALL WATERPROOFING AND FIRE SAFETY SYSTEMS ARE THE RESPONSIBILITY OF THE CONTRACTOR AND ARE TO BE DESIGNED AND DETAILED BY OTHERS.
- ANY WOOD FRAME INTERIOR BEARING WALL STUDS THAT HAVE HOLES IN THE CENTER OF THE STUD UP TO 1" DIAMETER SHALL HAVE STUD PROTECTION SHIELDS. ALL HOLES OVER 1" IN DIAMETER FOR PLUMBING LINES, ETC. SHALL BE REPAIRED WITH SIMPSON HSS2 OR USP ST1 STUD SHOES, TYPICAL, UNLESS OTHERWISE NOTED.
- BEARING WALLS SHALL BE SHEATHED ON NOT LESS THAN ONE SIDE WITH OSB OR GYPSUM BOARD. BRIDGING SHALL BE INSTALLED NOT GREATER THAN 4 FEET APART MEASURED VERTICALLY FROM EITHER END OF THE STUD IN LIEU OF SHEATHING.
- DIAGONAL BRACING SHALL BE INSTALLED AT EACH END OF BASEMENT BEARING WALLS AND NOT MORE THAN 20' ON CENTER.

## EXTERIOR WOOD FRAMED DECKS:

- DECKS ARE TO BE FRAMED IN ACCORDANCE WITH APPLICABLE BUILDING CODES AND AS REFERENCED ON THE STRUCTURAL PLANS, EITHER THROUGH CODE REFERENCES OR CONSTRUCTION DETAILS.
- PRESERVATIVE TREATED WOOD FRAMING TO BE SOUTHERN YELLOW PINE #2 OR BETTER.
- GUARD RAILS REQUIRED AT DECKS. DESIGN BY OTHERS TO MEET MINIMUM CODE REQUIREMENTS.
- PROVIDE DECK LATERAL LOAD AND BRACING CONNECTIONS PER BUILDING CODE.

## RAFTER FRAMED ROOF CONSTRUCTION:

- PROVIDE 2x4x4'-0" RAFTER TIES AT 48" O.C.
- RAFTERS SHALL BE SUPPORTED BY PURLINS AND PURLIN BRACES AS SHOWN ON THE PLAN. PURLIN BRACES SHALL NOT BEAR ON ANY CEILING JOIST, STRONGBACK OR HEADER UNLESS SPECIFICALLY SHOWN ON PLAN. RAFTERS MAY BE SPliced AT PURLIN LOCATIONS.
- CEILING JOISTS SHALL HAVE LATERAL SUPPORT W/ 1x4 FLAT BRACING ON TOP EDGE OF JOIST AT LOOSE JOIST ENDS (WHERE JOISTS NOT FASTENED TO RAFTERS) OR FULL DEPTH BLOCKING. FASTEN END OF BRACING TO RAFTER OR GABLE END FRAMING.
- FASTEN RAFTER AND CEILING JOIST WITH (6) 12d NAILS UNLESS OTHERWISE NOTED.
- PROVIDE VERTICAL 2x6 STRONGBACKS AT CEILING JOISTS @ 8'-0" O.C. THE STRONGBACK ENDS TO GABLE STUDS OR RAFTERS WHERE POSSIBLE. PROVIDE BLOCKING BETWEEN TOP PLATES AND STRONGBACKS. PROVIDE 2x4 FLAT FASTENED TO EACH JOIST WITH (2) 12d NAILS. FASTEN STRONGBACK TO 2x4 FLAT WITH 12d NAILS @ 12" O.C. AND FASTENED TO EACH JOIST WITH (1) 12d TOENAIL.

## WOOD TRUSSES (FLOOR & ROOF):

- THE WOOD TRUSS MANUFACTURER/FABRICATOR IS RESPONSIBLE FOR THE DESIGN OF THE WOOD TRUSSES. SUBMIT SEALED SHOP DRAWINGS AND SUPPORTING CALCULATIONS TO THE SER FOR REVIEW PRIOR TO FABRICATION. THE SER SHALL HAVE A MINIMUM OF (5) DAYS FOR REVIEW. THE REVIEW BY THE SER SHALL BE FOR OVERALL COMPLIANCE OF THE DESIGN DOCUMENTS. THE SER SHALL ASSUME NO RESPONSIBILITY FOR THE CORRECTNESS OF THE STRUCTURAL DESIGN FOR THE WOOD TRUSSES.
- THE WOOD TRUSSES SHALL BE DESIGNED FOR ALL REQUIRED LOADINGS AS SPECIFIED IN THE LOCAL BUILDING CODE, THE ASCE STANDARD "MINIMUM DESIGN LOADS FOR BUILDINGS AND OTHER STRUCTURES." (ASCE 7), AND THE LOADING REQUIREMENTS SHOWN ON THESE SPECIFICATIONS. THE TRUSS DRAWINGS SHALL BE COORDINATED WITH ALL OTHER CONSTRUCTION DOCUMENTS AND PROVISIONS PROVIDED FOR LOADS SHOWN ON THESE DRAWINGS INCLUDING BUT NOT LIMITED TO HVAC EQUIPMENT, PIPING, AND ARCHITECTURAL FIXTURES ATTACHED TO THE TRUSSES.
- THE TRUSSES SHALL BE DESIGNED, FABRICATED, AND ERECTED IN ACCORDANCE WITH THE LATEST EDITION OF THE ANSI/IFI 1: "NATIONAL DESIGN STANDARD FOR METAL PLATE CONNECTED WOOD TRUSS CONSTRUCTION".
- THE TRUSS MANUFACTURER SHALL PROVIDE ADEQUATE BRACING INFORMATION IN ACCORDANCE WITH "BUILDING COMPONENT SAFETY INFORMATION GUIDE TO GOOD PRACTICE FOR HANDLING, INSTALLING, RESTRAINING & BRACING OF METAL PLATE CONNECTED WOOD TRUSSES" (BCSI). THIS BRACING, BOTH TEMPORARY AND PERMANENT, SHALL BE SHOWN ON THE SHOP DRAWINGS. ALSO, THE SHOP DRAWINGS SHALL SHOW THE REQUIRED ATTACHMENTS FOR THE TRUSSES.
- THE CONTRACTOR IS RESPONSIBLE FOR INSTALLING TEMPORARY BRACING AND SHORING FOR THE FLOOR AND ROOF TRUSSES AS REQUIRED DURING CONSTRUCTION. AT A MINIMUM, CONTRACTOR SHALL FOLLOW THE REQUIREMENTS OF THE LATEST BCSI. THE CONTRACTOR SHALL KEEP A COPY OF THE BCSI SUMMARY SHEETS ON SITE.
- THE CONTRACTOR IS RESPONSIBLE FOR INSTALLING ALL PERMANENT TRUSS BRACING SHOWN IN THE STRUCTURAL DRAWINGS AND IN THE TRUSS DESIGNS. ALL CONTINUOUS LATERAL BRACING OF WEBS REQUIRES BRACES. REFER TO BCSI SUMMARY SHEET B3 FOR TYPES OF DIAGONAL BRACES TO PROVIDE AT EACH CONTINUOUS LATERAL BRACE LINE. SUCH DIAGONAL BRACES SHALL NOT BE SPACED MORE THAN 20 FEET O.C. DIAGONAL BRACES SHALL BE FASTENED TO EACH TRUSS WEB WITH A MINIMUM OF TWO 10d FACE NAILS, WHERE CONTINUOUS LATERAL BRACING CANNOT BE INSTALLED, DUE TO A MINIMUM OF THREE ADJACENT TRUSSES NOT BEING IDENTICAL, THE CONTRACTOR SHALL COORDINATE WITH THE TRUSS SPECIALTY ENGINEER/MANUFACTURER TO DETERMINE WHAT TYPE OF ALTERNATE BRACE (I.E., T OR L BRACE, ETC.) IS REQUIRED.
- ANY CHORDS OR TRUSS WEBS SHOWN ON THESE DRAWINGS HAVE BEEN SHOWN AS A REFERENCE ONLY. THE FINAL DESIGN OF THE TRUSSES SHALL BE PER THE MANUFACTURER.
- TRUSS LAYOUT AND PLACEMENT BY MANUFACTURER TO COINCIDE WITH THE SUPPORT LOCATIONS SHOWN ON THE SEALED STRUCTURAL DRAWINGS. TRUSS PROFILES TO BE SEALED BY THE TRUSS MANUFACTURER. TRUSS PLANS TO BE COORDINATED WITH THE SEALED STRUCTURAL DRAWINGS.
- TRUSS MANUFACTURER TO PROVIDE REQUIRED UPLIFT CONNECTORS FOR ALL TRUSSES.
- PROVIDE SIMPSON H2.5A, USP RT7 OR EQUIVALENT AT EACH TRUSS TO TOP PLATE CONNECTION, UNLESS OTHERWISE NOTED.

## WOOD STRUCTURAL PANELS:

- FABRICATION AND PLACEMENT OF STRUCTURAL WOOD SHEATHING SHALL BE IN ACCORDANCE WITH THE APA DESIGN/CONSTRUCTION GUIDE "RESIDENTIAL AND COMMERCIAL," AND ALL OTHER APPLICABLE APA STANDARDS.
- ALL REQUIRED WOOD SHEATHING SHALL BEAR THE MARK OF THE APA.
- WOOD WALL SHEATHING SHALL COMPLY WITH THE REQUIREMENTS OF LOCAL BUILDING CODES FOR THE APPROPRIATE STATE AS INDICATED ON THESE DRAWINGS. REFER TO WALL BRACING NOTES IN PLAN SET FOR MORE INFORMATION. EXTERIOR WALLS TO BE FULLY SHEATHED USING 5/8" OSB OR PLYWOOD MINIMUM. AT BRACED WALL PANELS, PROVIDE BLOCKING AT ALL SHEET EDGES NOT FALLING ON STUDS OR PLATES.
- ROOF SHEATHING SHALL BE APA RATED SHEATHING EXPOSURE 1 OR 2. ROOF SHEATHING SHALL BE CONTINUOUS OVER TWO SUPPORTS MINIMUM AND ATTACHED TO ITS SUPPORTING ROOF FRAMING WITH 8d NAILS AT 6" O.C. AT PANEL EDGES AND AT 12" O.C. IN PANEL FIELD UNLESS OTHERWISE NOTED ON THE PLANS. SHEATHING SHALL BE APPLIED WITH THE LONG DIRECTION PERPENDICULAR TO FRAMING. SHEATHING SHALL HAVE A SPAN RATING CONSISTENT WITH THE FRAMING SPACING. PROVIDE SUITABLE EDGE SUPPORT BY USE OF PLYWOOD CLIPS OR LUMBER BLOCKING UNLESS OTHERWISE NOTED. PANEL END JOINTS SHALL OCCUR OVER FRAMING. ROOF SHEATHING TO BE 5/8" OSB MINIMUM.
- WOOD FLOOR SHEATHING SHALL BE APA RATED SHEATHING EXPOSURE 1 OR 2. ATTACH SHEATHING TO ITS SUPPORTING FRAMING WITH (1) 10d NAIL AT 6" O.C. AT PANEL EDGES AND AT 12" O.C. IN PANEL FIELD UNLESS OTHERWISE NOTED ON THE PLANS. SHEATHING SHALL BE APPLIED PERPENDICULAR TO FRAMING. SHEATHING SHALL HAVE A SPAN RATING CONSISTENT WITH THE FRAMING SPACING. PROVIDE SUITABLE EDGE SUPPORT BY USE OF T&G PLYWOOD OR LUMBER BLOCKING UNLESS OTHERWISE NOTED. PANEL END JOINTS SHALL OCCUR OVER FRAMING.
- SHEATHING SHALL HAVE A 1/8" GAP AT PANEL ENDS AND EDGES AS RECOMMENDED IN ACCORDANCE WITH THE APA.

## STRUCTURAL FIBERBOARD PANELS:

- STRUCTURAL FIBERBOARD SHEATHING SHALL ONLY BE USED WHERE SPECIFICALLY NOTED ON THE STRUCTURAL PLANS.
- FABRICATION AND PLACEMENT OF STRUCTURAL FIBERBOARD SHEATHING SHALL BE IN ACCORDANCE WITH THE APPLICABLE AFA STANDARDS.
- FIBERBOARD WALL SHEATHING SHALL COMPLY WITH THE REQUIREMENTS OF LOCAL BUILDING CODES FOR THE APPROPRIATE STATE AS INDICATED ON THESE DRAWINGS. REFER TO WALL BRACING NOTES IN PLAN SET FOR MORE INFORMATION.
- SHEATHING SHALL HAVE A 1/8" GAP AT PANEL ENDS AND EDGES AS RECOMMENDED IN ACCORDANCE WITH THE AFA.

## STRUCTURAL STEEL:

- STRUCTURAL STEEL SHALL BE FABRICATED AND ERECTED IN ACCORDANCE WITH THE AMERICAN INSTITUTE OF STEEL CONSTRUCTION "CODE OF STANDARD PRACTICE FOR STEEL BUILDINGS AND BRIDGES" AND OF THE MANUAL OF STEEL CONSTRUCTION "LOAD RESISTANCE FACTOR DESIGN" LATEST EDITIONS.
- ALL STEEL SHALL HAVE A MINIMUM YIELD STRESS ( $F_y$ ) OF 50 KSI UNLESS OTHERWISE NOTED.
- WELDING SHALL CONFORM TO THE LATEST EDITION OF THE AMERICAN WELDING SOCIETY'S STRUCTURAL WELDING CODE AWA D1.1. ELECTRODES FOR SHOP AND FIELDING WELDING SHALL BE CLASS E70XX. ALL WELDING SHALL BE PERFORMED BY A CERTIFIED WELDER PER THE ABOVE STANDARDS.
- ALL STEEL BEAMS TO BE SUPPORTED AT EACH END WITH A MINIMUM BEARING LENGTH OF 3/4" AND FULL FLANGE WIDTH UNLESS OTHERWISE NOTED. BEAMS MUST BE ATTACHED AT EACH END WITH A MINIMUM OF FOUR 16d NAILS OR (2) 1/2" x 4" LAG SCREWS UNLESS OTHERWISE NOTED.
- INSTALL 2x WOOD PLATE ON TOP OF STEEL BEAMS, RIPPED TO MATCH BEAM WIDTH. FASTEN PLATE TO BEAM W/ HILTI X-DNI 52 P8 PINS AT 12" O.C. STAGGERED OR 1/2" DIAMETER BOLTS AT 24" O.C.

## MECHANICAL FASTENERS:

- ALL METAL HARDWARE AND FASTENERS TO BE SIMPSON STRONG-TIE OR APPROVED EQUIVALENT.
- ALL HARDWARE AND FASTENERS IN CONTACT WITH PRESERVATIVE PRESSURE TREATED LUMBER SHALL BE HOT DIPPED GALVANIZED IN ACCORDANCE WITH ASTM A 153, G-185.
- MANY OF THE NEW PRESURE TREATED WOODS USE CHEMICALS THAT ARE CORROSIVE TO STEEL. IT IS THE CONTRACTOR'S RESPONSIBILITY TO VERIFY THE TYPE OF WOOD TREATMENT AND SELECT APPROPRIATE CONNECTORS THAT WILL RESIST THE APPLICABLE CORROSIVE CHEMICALS.

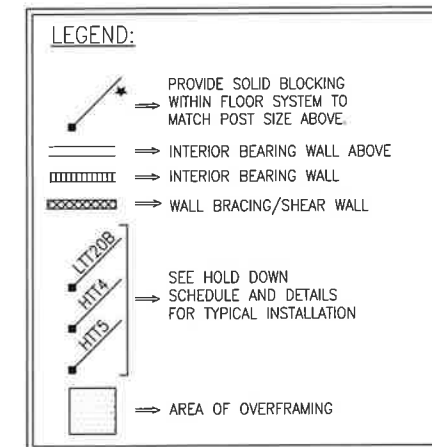

BRICK VENEER LINTEL SCHEDULE		
SPAN	LINTEL SIZE	END BEARING
UP TO 3'-0"	3 1/2" x 3 1/2" x 1/4"	4"
UP TO 6'-3"	5" x 3 1/2" x 1/4" L.L.V.	8"
UP TO 9'-6"	6" x 3 1/2" x 1/4" L.L.V.	12"

LINTELS ARE NOT DESIGNED TO BE BOLTED TO HEADERS UNLESS SPECIFIED ON UNIT PLANS.  
SPANS OVER 4'-0" SHALL BE SHORED UP UNTIL CURED.

General Structural Notes

Up to 130 M.P.H.  
North Carolina

Project #: 105-19000  
Designed By: KRK  
Checked By:  
Issue Date: 1/1/19  
Re-Issue:  
Scale: 1/8"=1'-0" @ 11x17  
1/4"=1'-0" @ 22x34



S-0.1





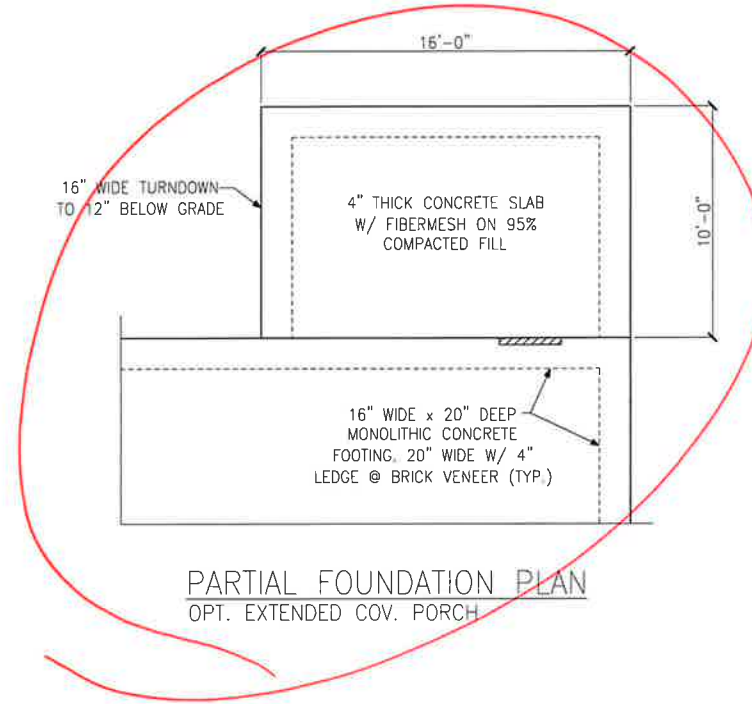
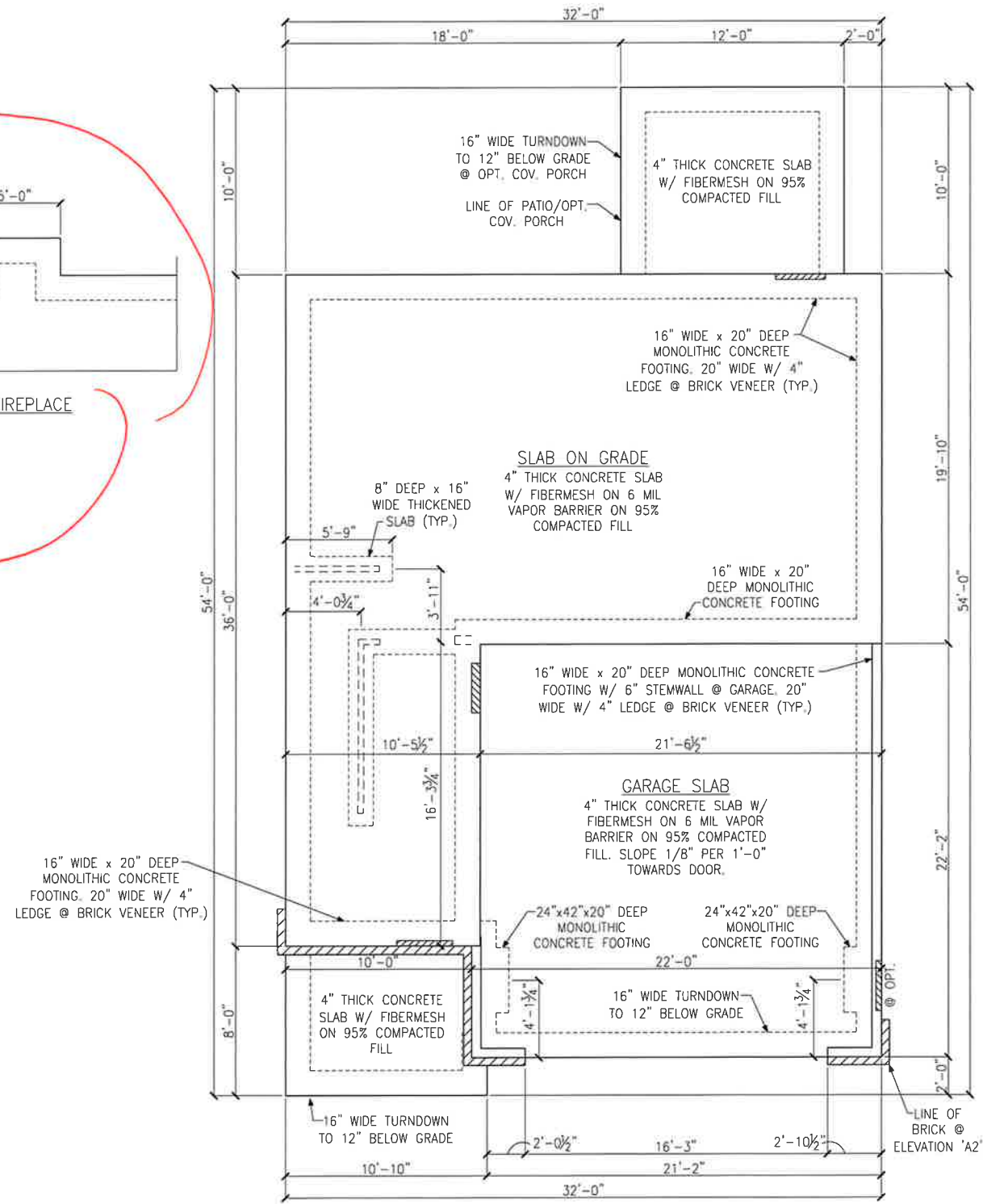
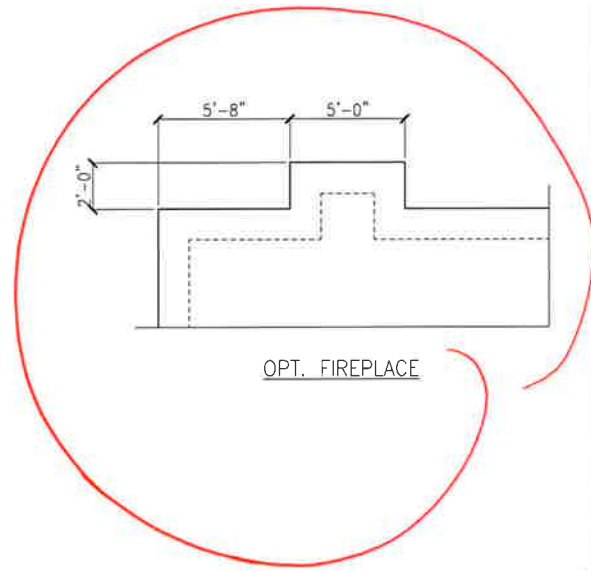

LEGEND	
	PROVIDE SOLID BLOCKING WITHIN FLOOR SYSTEM TO MATCH POST SIZE ABOVE.
	BEARING WALL ABOVE
	INTERIOR BEARING WALL
	BRACED WALL PANEL (SEE KSE STRUCTURAL DETAILS SET FOR BRACED WALL PANEL SHEATHING FASTENING & BLOCKING DETAILS)
	LOCATION OF DOOR ABOVE
REFER TO KSE STRUCTURAL DETAILS SET FOR GENERAL STRUCTURAL NOTES AND TYPICAL DETAILS	

Monolithic Slab Foundation Plans  
Elevations 'A1', 'A2' & Option  
Kenzie Model - RH  
Up to 130 M.P.H.  
Carolina Division



Project #: 105-19004  
Designed By: KRK  
Checked By:  
Issue Date: 8/29/19  
Re-Issue: 4/30/20  
Scale: 1/8"=1'-0" @ 11x17  
1/4"=1'-0" @ 22x34

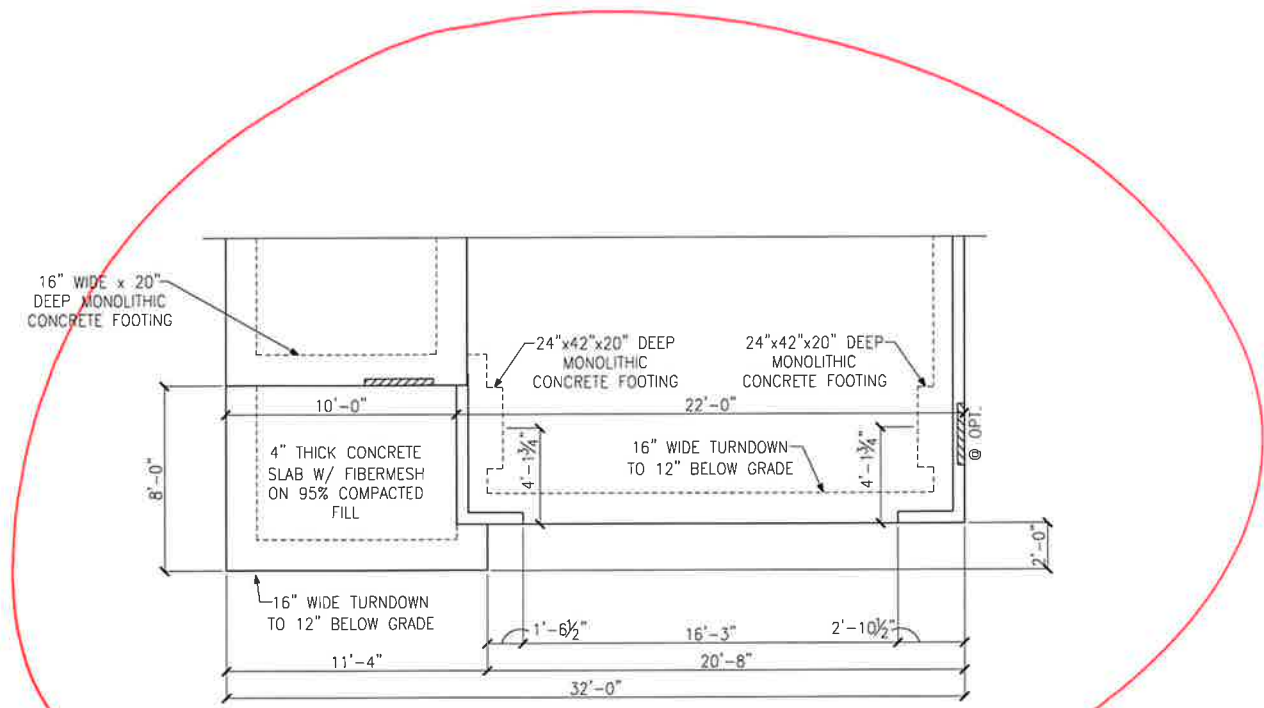

MONOLITHIC SLAB FOUNDATION PLAN  
ELEVATIONS 'B1' & 'B2'

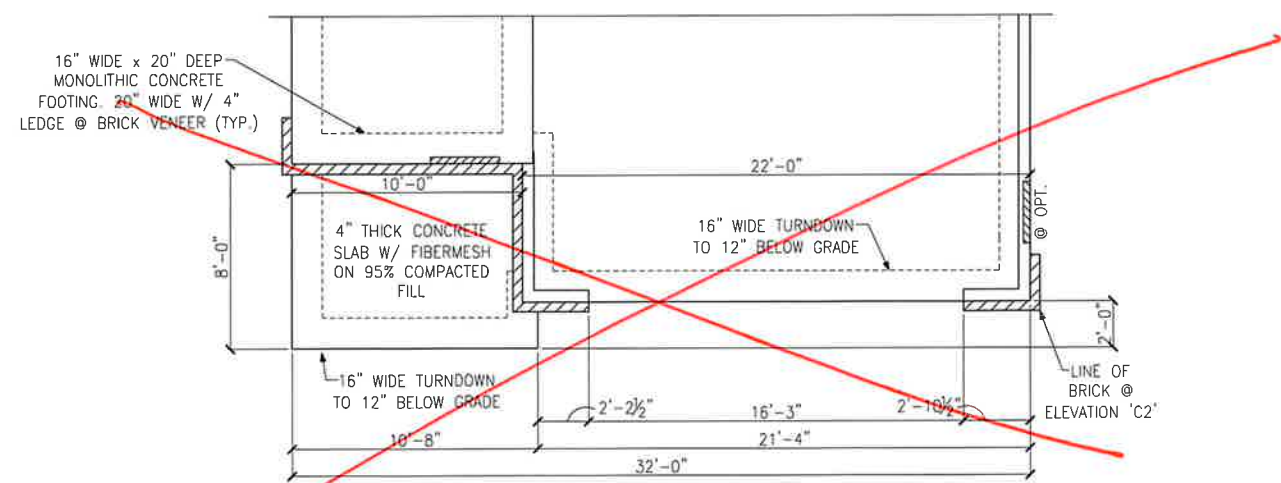

MONOLITHIC SLAB FOUNDATION PLAN  
ELEVATIONS 'C1' & 'C2'

LEGEND	
	PROVIDE SOLID BLOCKING WITHIN FLOOR SYSTEM TO MATCH POST SIZE ABOVE.
	BEARING WALL ABOVE
	INTERIOR BEARING WALL
	BRACED WALL PANEL (SEE KSE STRUCTURAL DETAILS SET FOR BRACED WALL PANEL SHEATHING FASTENING & BLOCKING DETAILS)
	LOCATION OF DOOR ABOVE
REFER TO KSE STRUCTURAL DETAILS SET FOR GENERAL STRUCTURAL NOTES AND TYPICAL DETAILS	

Monolithic Slab Foundation Plans  
Elevations 'B1', 'B2', 'C1' & 'C2'  
Kenzie Model - RH  
Up to 130 M.P.H.  
Carolina Division

Project #: 105-19004  
Designed By: KRK  
Checked By:  
Issue Date: 8/29/19  
Re-Issue: 4/30/20  
Scale: 1/8"=1'-0" @ 11x17  
1/4"=1'-0" @ 22x34











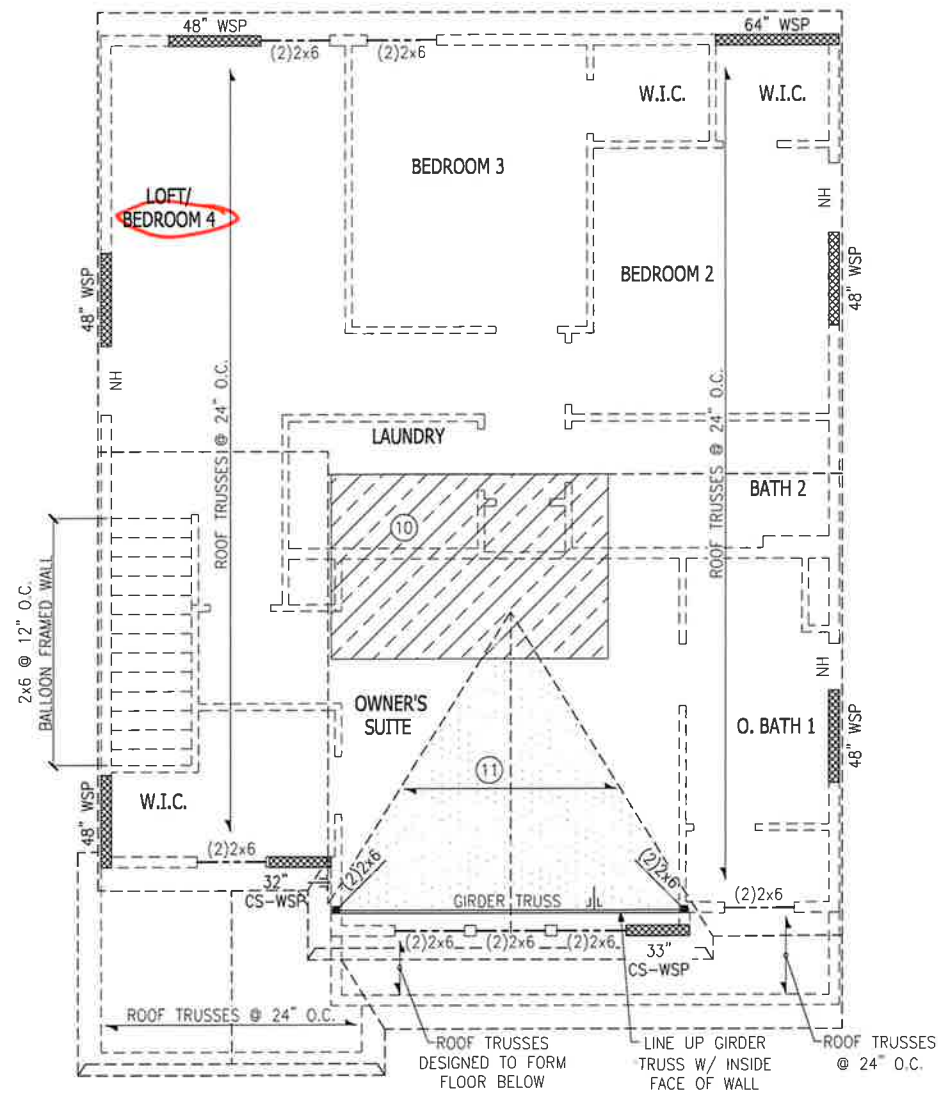

ROOF FRAMING PLAN  
ELEVATIONS 'B1' & 'B2'

LEGEND	
	PROVIDE SOLID BLOCKING WITHIN FLOOR SYSTEM TO MATCH POST SIZE ABOVE.
	BEARING WALL ABOVE
	INTERIOR BEARING WALL
	BRACED WALL PANEL (SEE KSE STRUCTURAL DETAILS SET FOR BRACED WALL PANEL SHEATHING FASTENING & BLOCKING DETAILS)
	48" WSP
	NH NO HEADER REQUIRED
REFER TO KSE STRUCTURAL DETAILS SET FOR GENERAL STRUCTURAL NOTES AND TYPICAL DETAILS	
PLAN DESIGNED WITH 8' WALL PLATES	
KEYNOTES:	
⑩	8'x12' HVAC PLATFORM TRUSSES DESIGNED TO SUPPORT HVAC UNITS.
⑪	2x6 OVERFRAMING W/ 2x8 RIDGE AND VALLEY PLATES OR VALLEY SET TRUSSES @ 24" O.C. (TYP.)



Roof Framing Plan  
Elevations 'B1' & 'B2'  
Kenzie Model - RH  
Up to 130 M.P.H.  
Carolina Division

Project #: 105-19004  
Designed By: KRK  
Checked By:  
Issue Date: 8/29/19  
Re-Issue: 4/30/20  
Scale: 1/8"=1'-0" @ 11x17  
1/4"=1'-0" @ 22x34

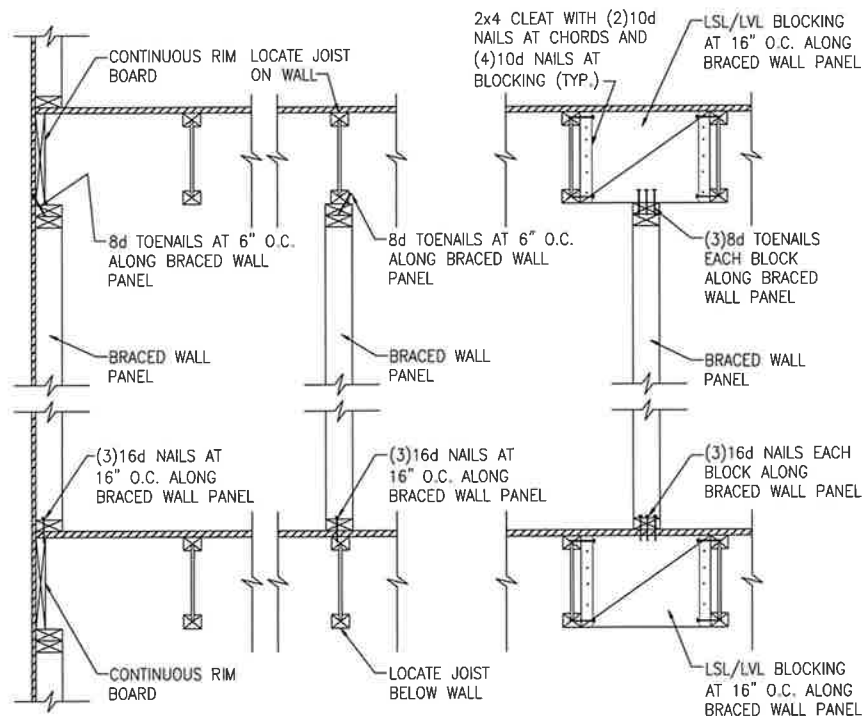

**A** TYPICAL BRACED WALL PANEL TO FLOOR/CEILING CONNECTION  
BRACED WALL PANELS PARALLEL TO I-JOISTS

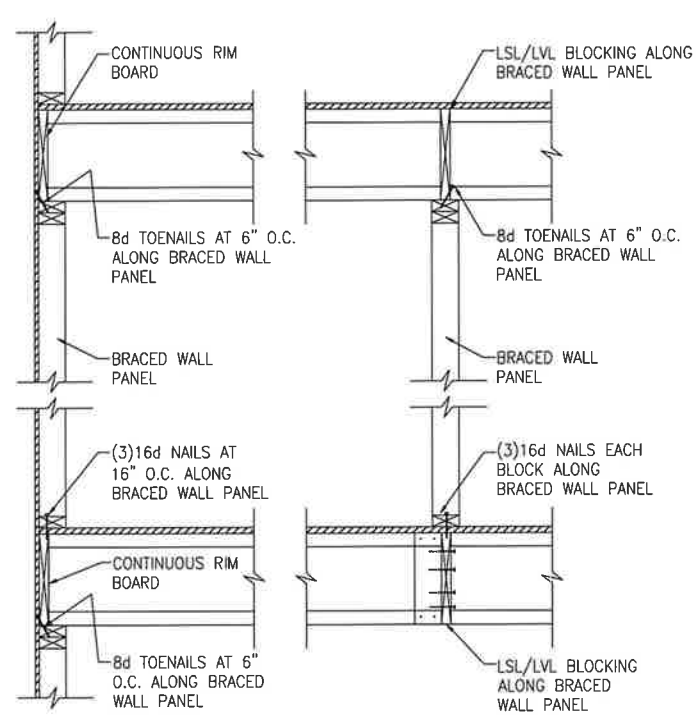

**B** TYPICAL BRACED WALL PANEL TO FLOOR/CEILING CONNECTION  
BRACED WALL PANELS PERPENDICULAR TO I-JOISTS

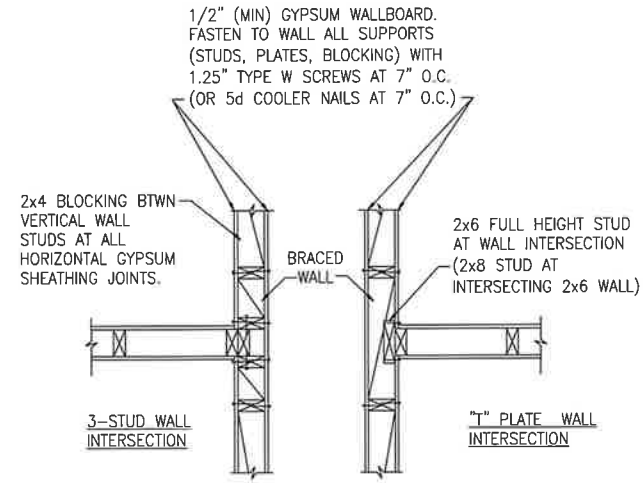

BRACED WALL INTERSECTIONS MAY BE FRAMED USING EITHER THE 3-STUD OR THE T-PLATE METHOD.

**C** METHOD GB(1) AND GB(2) INTERSECTION DETAILS

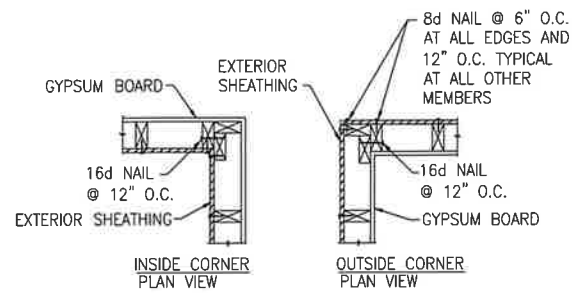

**D** TYPICAL EXTERIOR CORNER WALL FRAMING

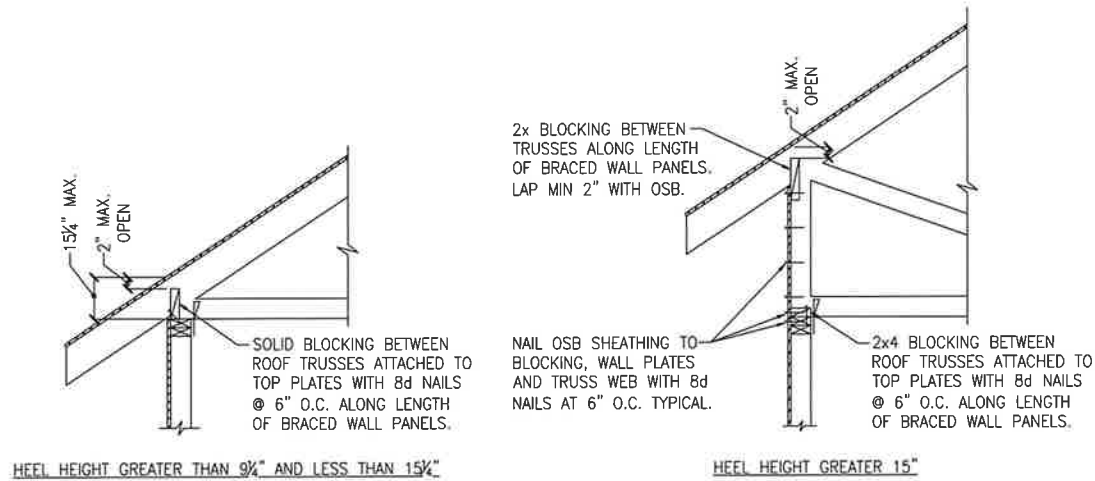

**E** ROOF TRUSS BEARING/BLOCKING AT BRACED WALL PANELS  
ONLY REQUIRED AT BRACED WALL PANELS



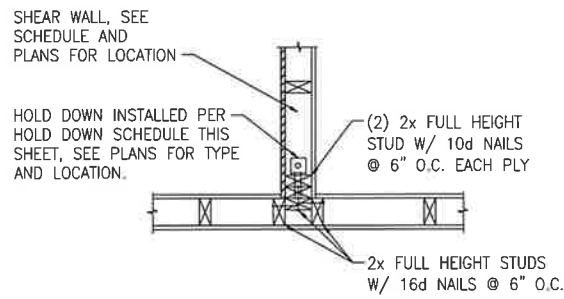

**A** TYPICAL HOLD DOWN DETAIL

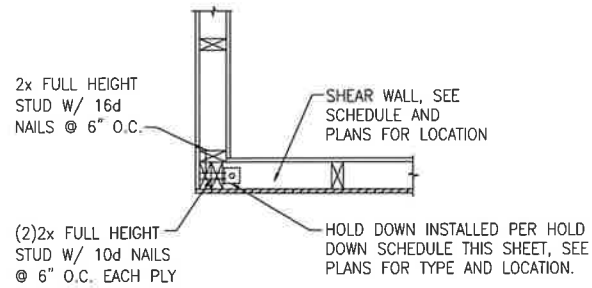

**B** TYPICAL HOLD DOWN DETAIL

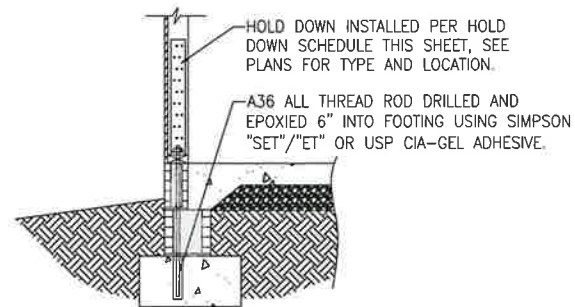

**C** HOLD DOWN AT STEMWALL SLAB FOUNDATION

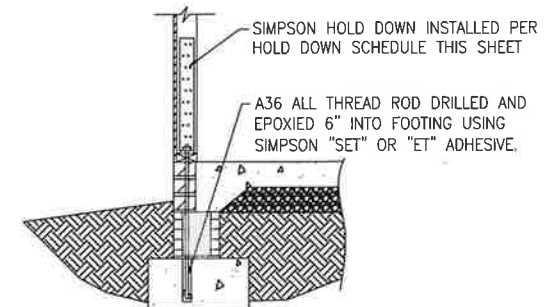

**C** HOLD DOWN AT STEMWALL SLAB

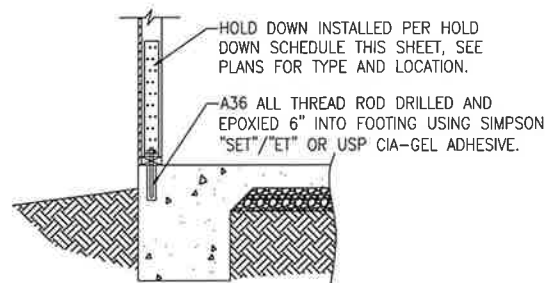

**D** HOLD DOWN AT MONOLITHIC SLAB FOUNDATION

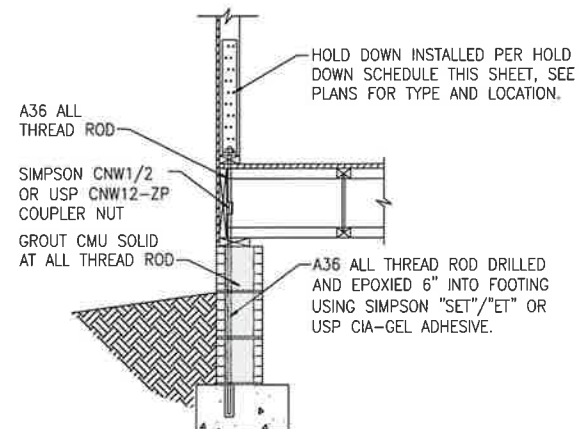

**E** HOLD DOWN AT CRAWL SPACE FOUNDATION

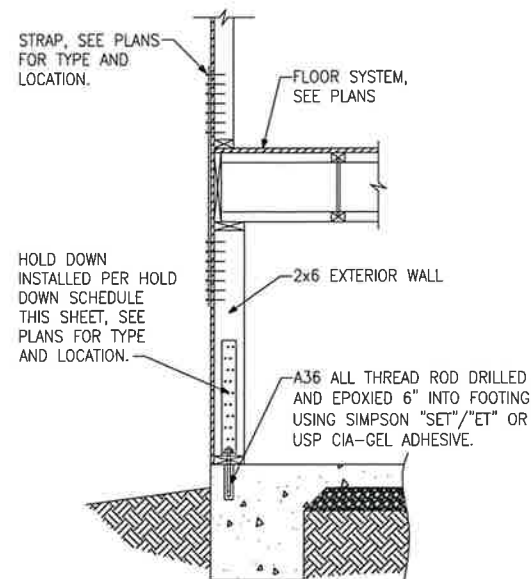

**F** HOLD DOWN AT BASEMENT FOUNDATION MONOLITHIC TURN-DOWN

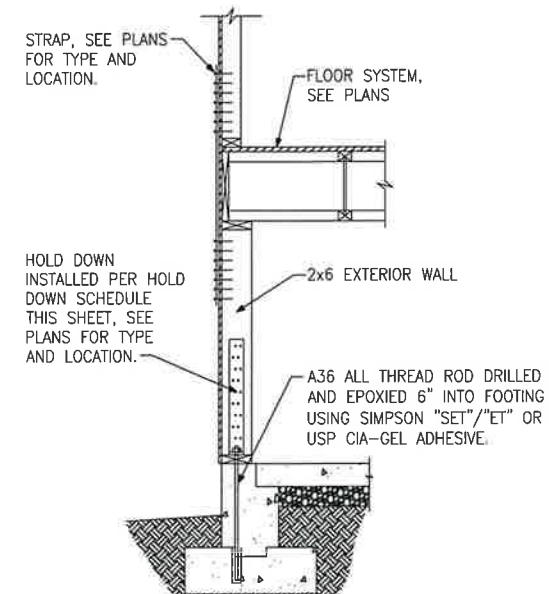

**G** HOLD DOWN AT BASEMENT FOUNDATION STEM WALL

HOLD DOWN SCHEDULE			
HOLD DOWN		ALL THREAD ROD	FASTENERS
SIMPSON	USP		
LTT20B	LTS20B	½" DIA.	(10)10d NAILS
HTT4	HTT16	⅝" DIA.	(18)16dx2½" LONG NAILS
HTT5	HTT45	⅝" DIA.	(26)16dx2½" LONG NAILS

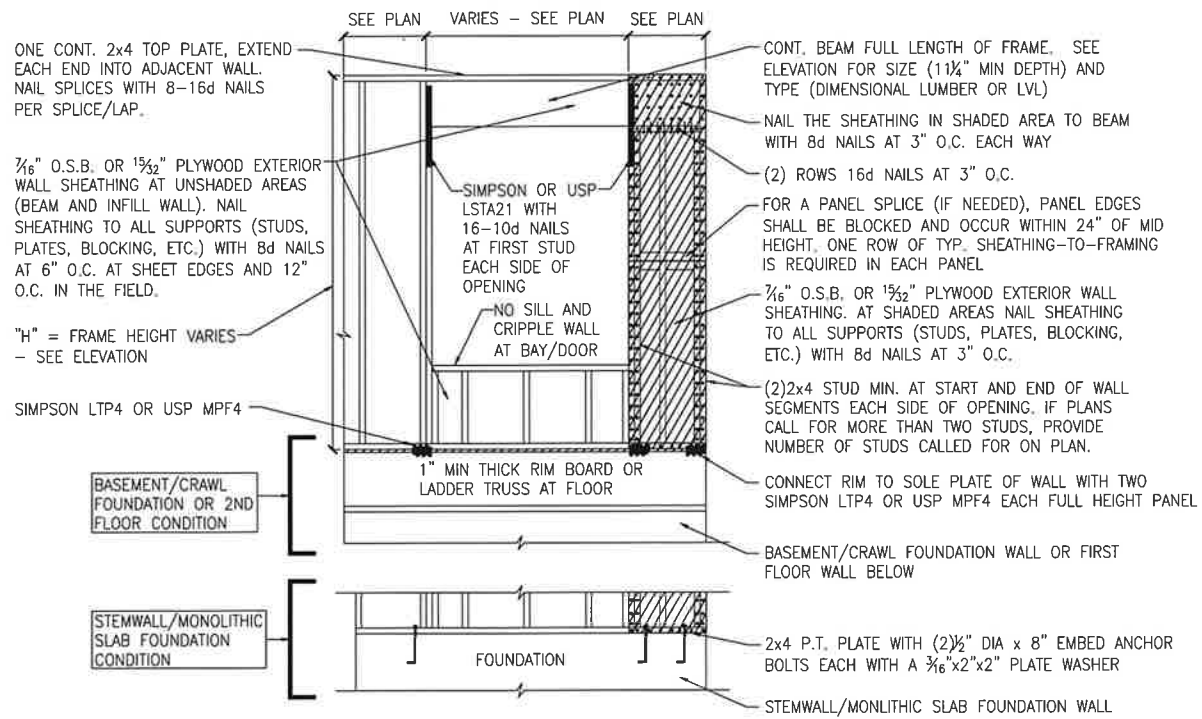

**A** METHOD CS-PF: CONTINUOUS PORTAL FRAME PANEL CONSTRUCTION  
ONE BRACED WALL SEGMENT

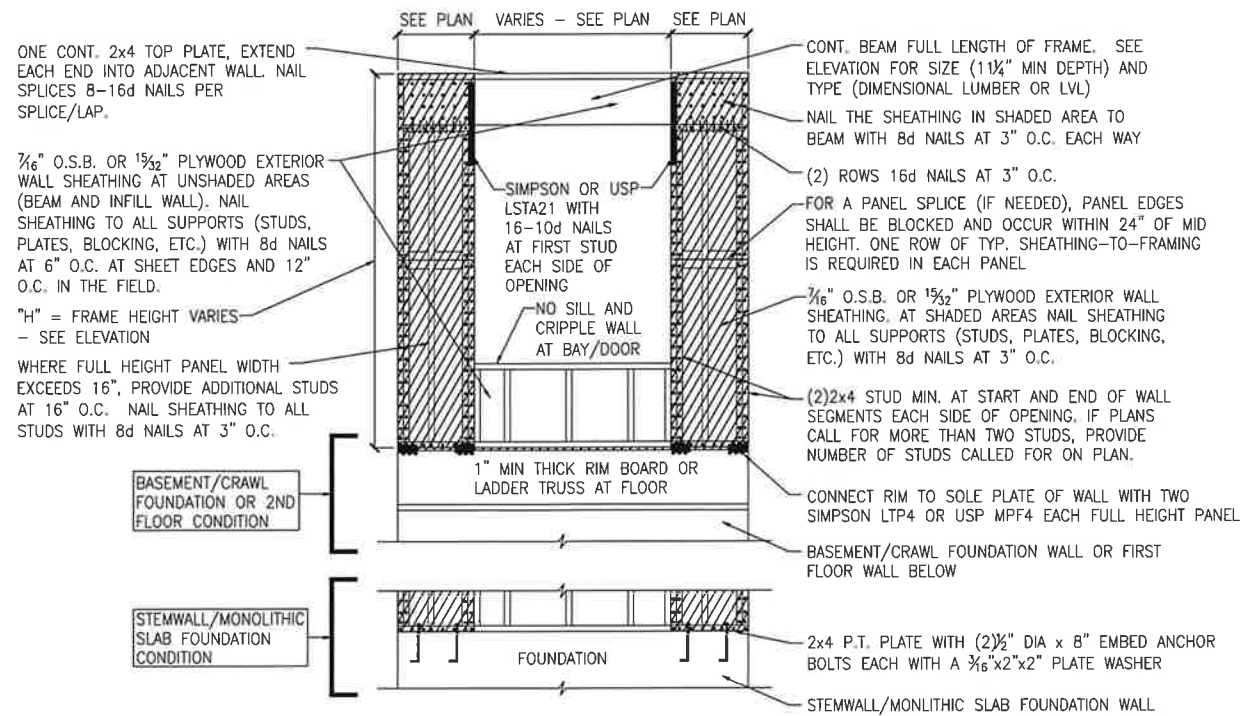

**B** METHOD CS-PF: CONTINUOUS PORTAL FRAME PANEL CONSTRUCTION  
TWO BRACED WALL SEGMENTS

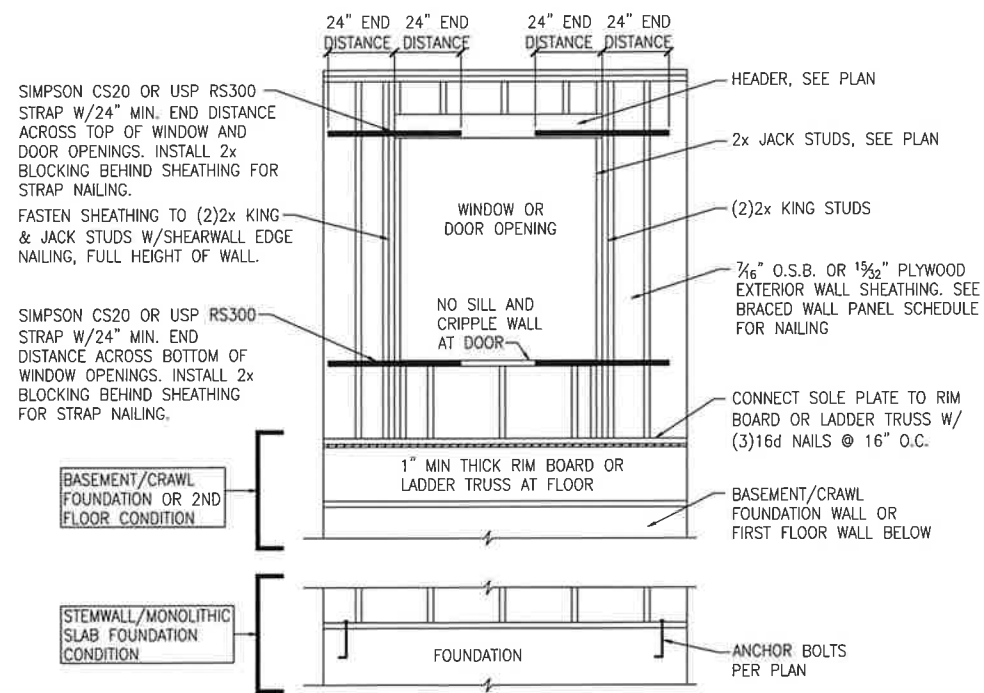

**C** WINDOW OR DOOR REINFORCEMENT IN ENGINEERED SHEAR WALL  
ONLY REQUIRED WHERE SPECIFIED ON PLANS

BRACED WALL PANEL AND ENGINEERED SHEAR WALL SCHEDULE			
PANEL TYPES	PANEL TYPE	MATERIAL	FASTENERS
WSP	INTERMITTENT WOOD STRUCTURAL PANEL	7/16" OSB	6D OR 8D COMMON NAILS AT 6" O.C. AT SHEET EDGES AND 12" O.C. AT INTERMEDIATE SUPPORTS. <u>ENGINEERED ALTERNATIVE: 16 GAGE BY 1.75" LONG STAPLES AT 3" O.C. AT SHEET EDGES AND 6" O.C. AT INTERMEDIATE SUPPORTS</u>
GB(1)	INTERMITTENT GYPSUM BOARD (SHEATHING ONE FACE OF WALL)	1/2" GYPSUM	1.5" LONG GALV. ROOFING NAILS, 6d COMMON NAILS, OR 1.25" LONG TYPE W DRYWALL SCREWS AT 7" O.C. AT SHEET EDGES AND INTERMEDIATE SUPPORTS.
GB(1)-4	INTERMITTENT GYPSUM BOARD (SHEATHING ONE FACE OF WALL)	1/2" GYPSUM	1.5" LONG GALV. ROOFING NAILS, 6d COMMON NAILS, OR 1.25" LONG TYPE W DRYWALL SCREWS AT 4" O.C. AT SHEET EDGES AND INTERMEDIATE SUPPORTS.
GB(2)	INTERMITTENT GYPSUM BOARD (SHEATHING BOTH FACES OF WALL)	1/2" GYPSUM	1.5" LONG GALV. ROOFING NAILS, 6d COMMON NAILS, OR 1.25" LONG TYPE W DRYWALL SCREWS AT 7" O.C. AT SHEET EDGES AND INTERMEDIATE SUPPORTS.
CS-WSP	CONTINUOUS SHEATHED WOOD STRUCTURAL PANEL	7/16" OSB	6D OR 8D COMMON NAILS AT 6" O.C. AT SHEET EDGES AND 12" O.C. AT INTERMEDIATE SUPPORTS. <u>ENGINEERED ALTERNATIVE: 16 GAGE BY 1.75" LONG STAPLES AT 3" O.C. AT SHEET EDGES AND 6" O.C. AT INTERMEDIATE SUPPORTS</u>
CS-PF	CONTINUOUS SHEATHED PORTAL FRAME	7/16" OSB	NAILING PER DETAIL
PFH	PORTAL FRAME WITH HOLD DOWNS	7/16" OSB	NAILING PER DETAIL
CS-ESW(1)	ENGINEERED SHEAR WALL, TYPE 1	7/16" OSB	8D COMMON NAILS AT 6" O.C. AT SHEET EDGES AND 12" O.C. AT INTERMEDIATE SUPPORTS. CONTINUOUS OSB AROUND DOOR/WINDOW OPENINGS
CS-ESW(2)	ENGINEERED SHEAR WALL, TYPE 2	7/16" OSB	8D COMMON NAILS AT 4" O.C. AT SHEET EDGES AND 12" O.C. AT INTERMEDIATE SUPPORTS. CONTINUOUS OSB AROUND DOOR/WINDOW OPENINGS
CS-ESW(3)	ENGINEERED SHEAR WALL, TYPE 3	7/16" OSB	8D COMMON NAILS AT 3" O.C. AT SHEET EDGES AND 12" O.C. AT INTERMEDIATE SUPPORTS. CONTINUOUS OSB AROUND DOOR/WINDOW OPENINGS

**BRACED WALL PANEL NOTES:**

- ALL BRACED WALL PANELS, EXCEPT GB(1) & GB(2), SHALL HAVE 2x BLOCKING BETWEEN WALL STUDS AT ALL HORIZONTAL SHEET EDGES.
- PROVIDE NAILING/BLOCKING ABOVE AND BELOW ALL BRACED WALL PANELS PER KSE BRACED WALL DETAILS.
- SHEATH ALL EXTERIOR WALLS OF THE HOUSE WITH 7/16" O.S.B., OR 1 1/2" PLYWOOD, FASTENED PER IRC, AT EXTERIOR CORNERS, SHEATHING SHALL BE FASTENED PER KSE BRACED WALL DETAILS. AT INTERIOR WALL INTERSECTIONS, FASTEN STUDS & WALL BRACING PER KSE BRACED WALL DETAILS.
- BRACED WALL PANELS AND ENGINEERED SHEAR WALLS ARE PROVIDED PER IRC. PANEL LENGTHS SHOWN ON PLANS ARE THE MINIMUM LENGTH REQUIRED.





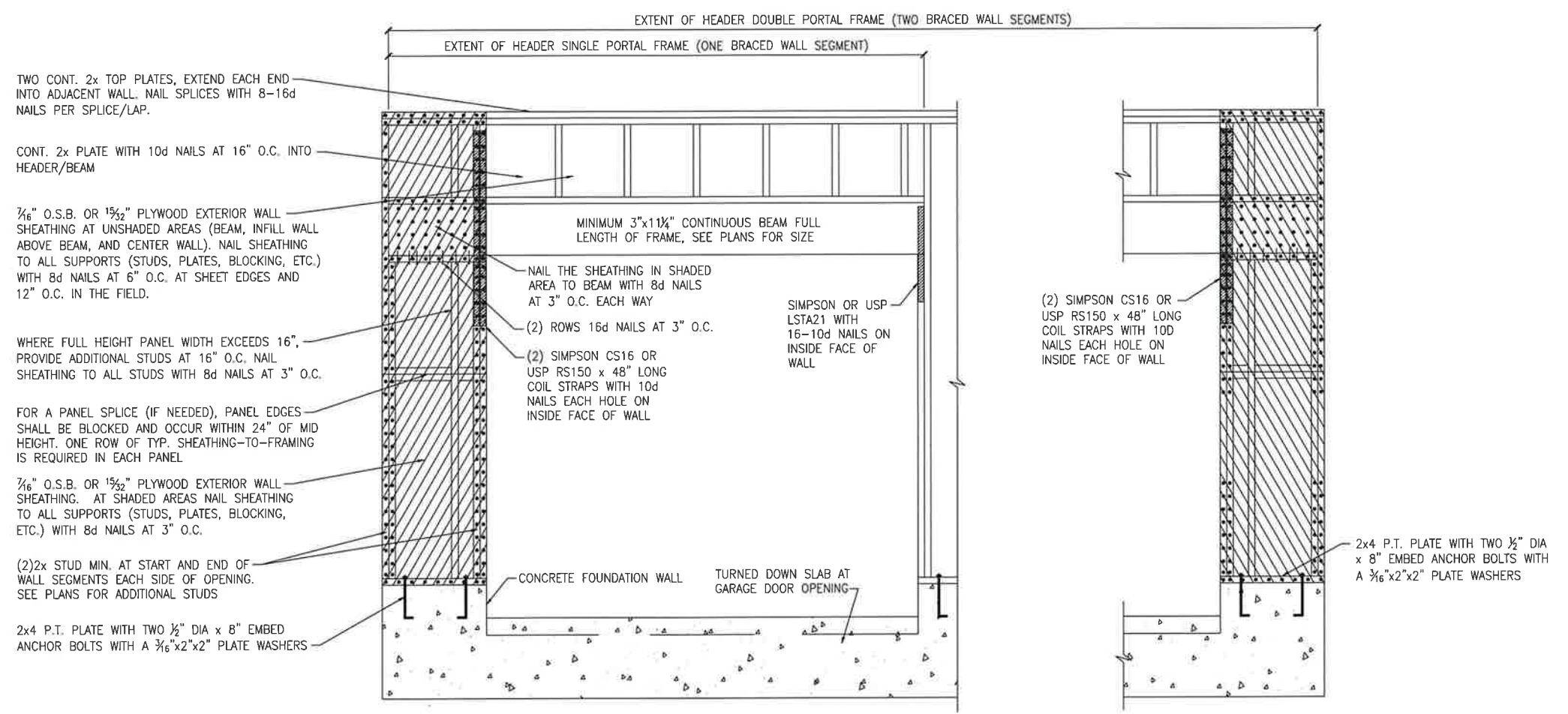

TWO CONT. 2x TOP PLATES, EXTEND EACH END INTO ADJACENT WALL. NAIL SPLICES WITH 8-16d NAILS PER SPLICE/LAP.

CONT. 2x PLATE WITH 10d NAILS AT 16" O.C. INTO HEADER/BREAM

7/16" O.S.B. OR 1 5/32" PLYWOOD EXTERIOR WALL SHEATHING AT UNSHADED AREAS (BEAM, INFILL WALL ABOVE BEAM, AND CENTER WALL). NAIL SHEATHING TO ALL SUPPORTS (STUDS, PLATES, BLOCKING, ETC.) WITH 8d NAILS AT 6" O.C. AT SHEET EDGES AND 12" O.C. IN THE FIELD.

WHERE FULL HEIGHT PANEL WIDTH EXCEEDS 16", PROVIDE ADDITIONAL STUDS AT 16" O.C. NAIL SHEATHING TO ALL STUDS WITH 8d NAILS AT 3" O.C.

FOR A PANEL SPLICE (IF NEEDED), PANEL EDGES SHALL BE BLOCKED AND OCCUR WITHIN 24" OF MID HEIGHT. ONE ROW OF TYP. SHEATHING-TO-FRAMING IS REQUIRED IN EACH PANEL.

7/16" O.S.B. OR 1 5/32" PLYWOOD EXTERIOR WALL SHEATHING. AT SHADED AREAS NAIL SHEATHING TO ALL SUPPORTS (STUDS, PLATES, BLOCKING, ETC.) WITH 8d NAILS AT 3" O.C.

(2)2x STUD MIN. AT START AND END OF WALL SEGMENTS EACH SIDE OF OPENING. SEE PLANS FOR ADDITIONAL STUDS

2x4 P.T. PLATE WITH TWO 1/2" DIA x 8" EMBED ANCHOR BOLTS WITH A 3/16" x 2" x 2" PLATE WASHERS

**A** METHOD CS-PF: CONTINUOUS PORTAL FRAME PANEL CONSTRUCTION  
MONOLITHIC SLAB OR BASEMENT FOUNDATION

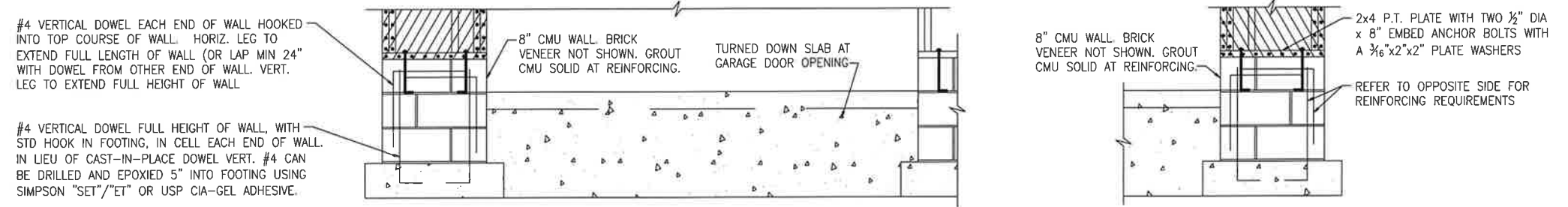

#4 VERTICAL DOWEL EACH END OF WALL HOOKED INTO TOP COURSE OF WALL. HORIZ. LEG TO EXTEND FULL LENGTH OF WALL (OR LAP MIN 24" WITH DOWEL FROM OTHER END OF WALL. VERT. LEG TO EXTEND FULL HEIGHT OF WALL.

#4 VERTICAL DOWEL FULL HEIGHT OF WALL, WITH STD HOOK IN FOOTING, IN CELL EACH END OF WALL. IN LIEU OF CAST-IN-PLACE DOWEL VERT. #4 CAN BE DRILLED AND EPOXIED 5" INTO FOOTING USING SIMPSON "SET"/"ET" OR USP CIA-GEL ADHESIVE.

**B** METHOD CS-PF: CONTINUOUS PORTAL FRAME PANEL CONSTRUCTION  
STEMWALL SLAB OR CRAWL SPACE FOUNDATION

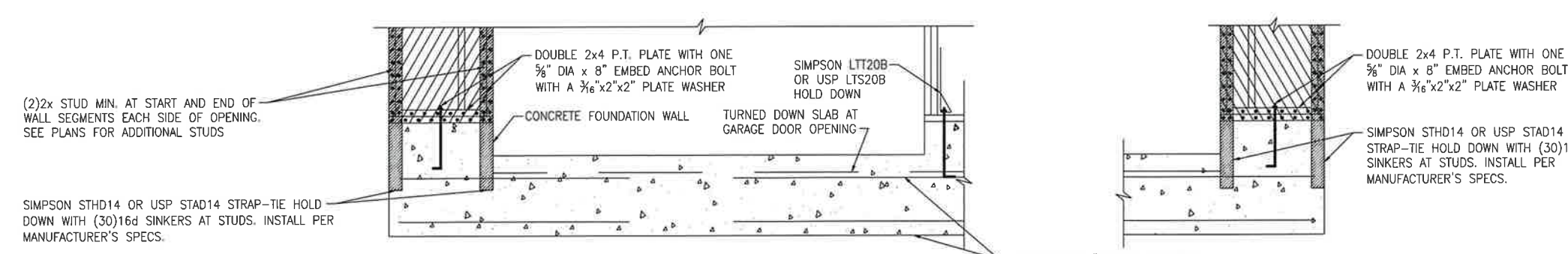

(2)2x STUD MIN. AT START AND END OF WALL SEGMENTS EACH SIDE OF OPENING. SEE PLANS FOR ADDITIONAL STUDS

SIMPSON STD14 OR USP STAD14 STRAP-TIE HOLD DOWN WITH (30)16d SINKERS AT STUDS. INSTALL PER MANUFACTURER'S SPECS.

**C** METHOD PFH: PORTAL FRAME WITH HOLD-DOWNS  
MONOLITHIC SLAB OR BASEMENT FOUNDATION



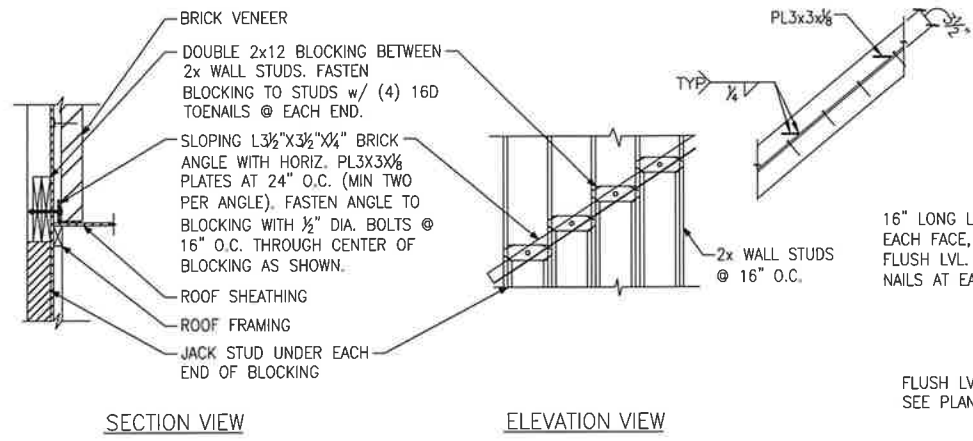

SECTION VIEW

ELEVATION VIEW

**(A)** BRICK LEDGER CONNECTION DETAIL

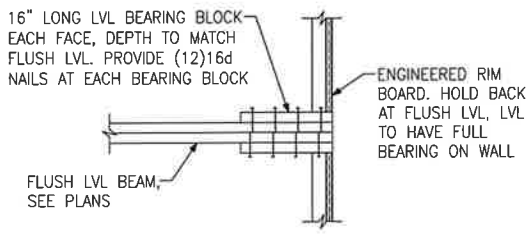

**(B)** BEARING ENHANCER FLUSH LVL

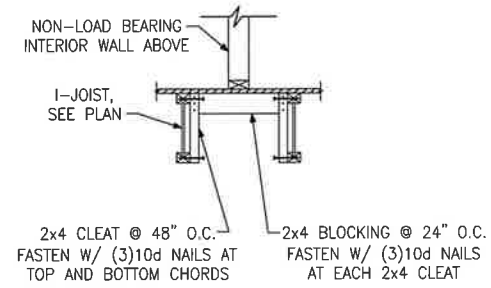

**(C)** I-JOIST LADDER BLOCKING AS REQUIRED @ PARALLEL WALLS

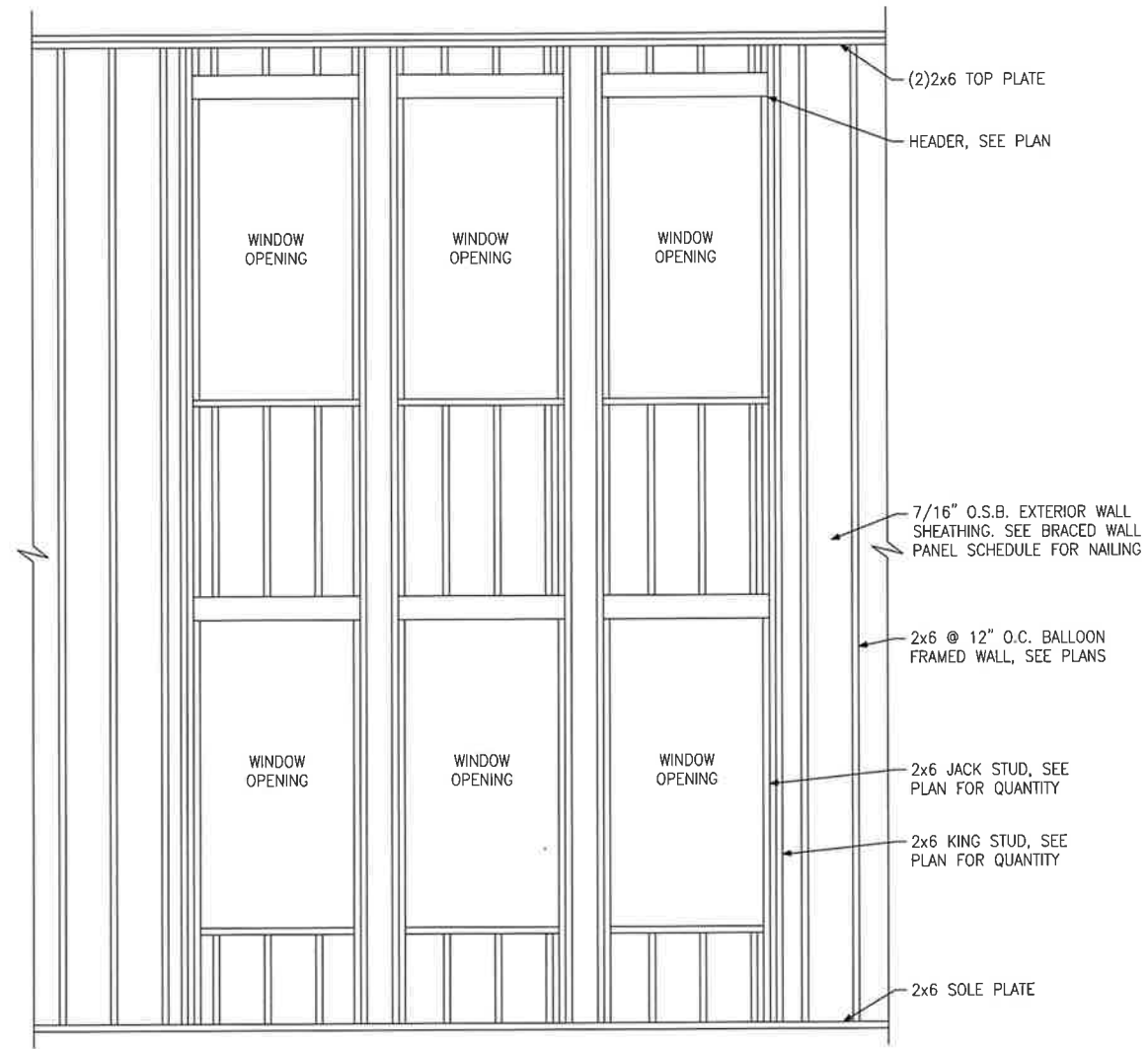

**(D)** BALLOON FRAMED WALL DETAIL N.T.S.



Miscellaneous Framing Details

Up to 130 M.P.H.  
North Carolina

Project #:	105-19000
Designed By:	KRK
Checked By:	
Issue Date:	1/1/19
Re-Issue:	
Scale:	1/8"=1'-0" @ 11x17 1/4"=1'-0" @ 22x34





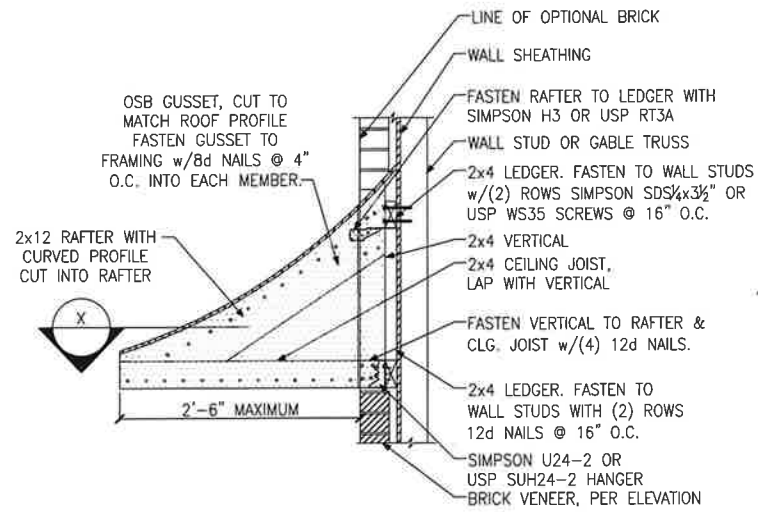

**A** PENT ROOF DETAIL  
CURVED ROOF

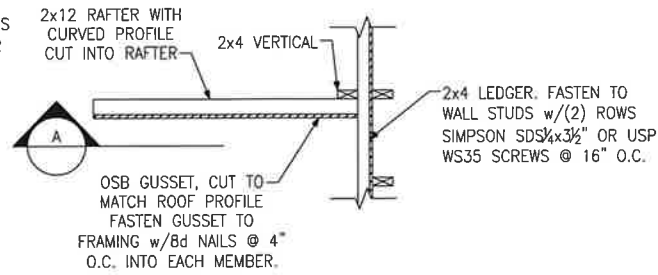

**X** SECTION  
CURVED ROOF

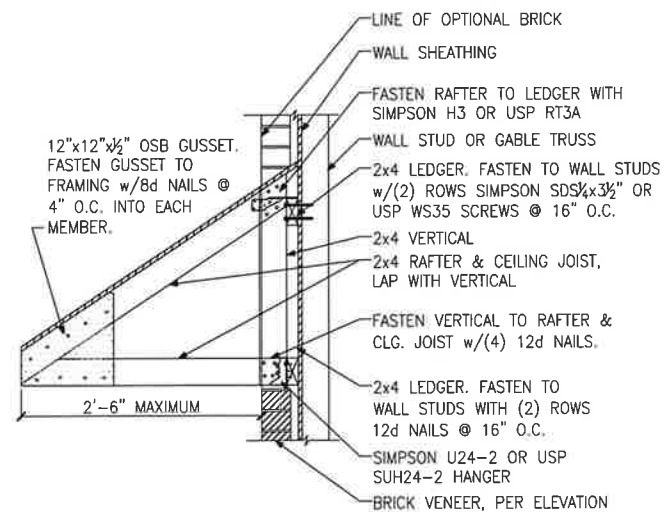

**B** PENT ROOF DETAIL  
STRAIGHT ROOF

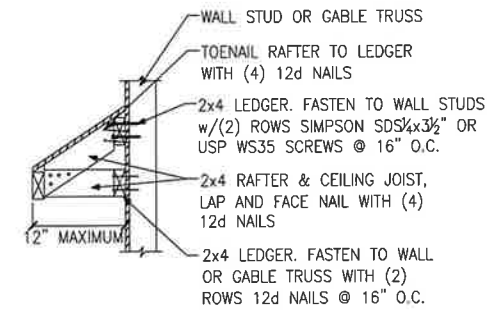

**C** EYEBROW ROOF DETAIL  
STRAIGHT ROOF

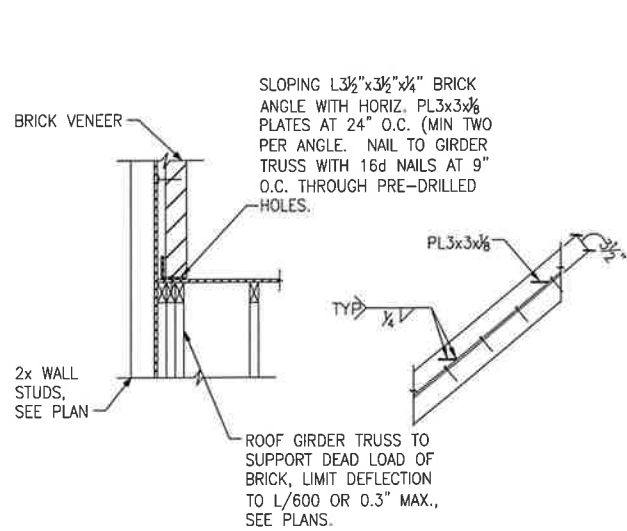

**D** TRUSS DETAIL

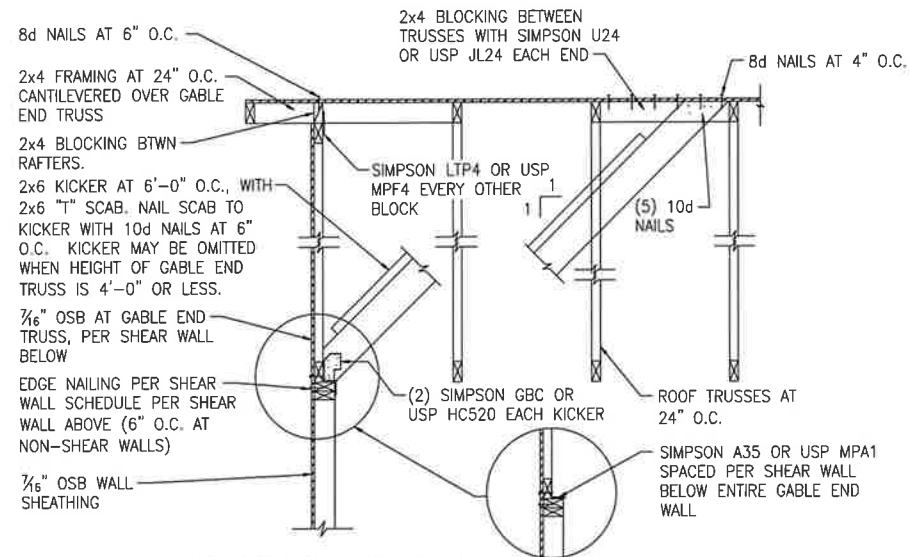

**E** GABLE END WALL DETAIL



Miscellaneous Framing Details

Up to 130 M.P.H.  
North Carolina

Project #: 105-19000  
Designed By: KRK  
Checked By:  
Issue Date: 1/1/19  
Re-Issue:  
Scale: 1/8"=1'-0" @ 11x17  
1/4"=1'-0" @ 22x34



SD-6

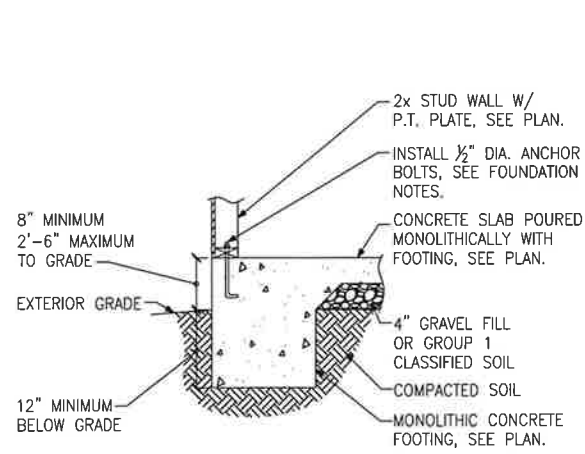

**A** FOUNDATION SECTION  
EXTERIOR WALL

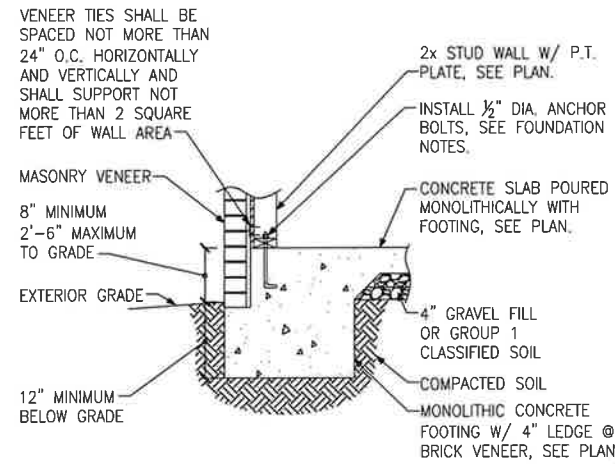

**B** FOUNDATION SECTION  
EXTERIOR WALL @ MASONRY  
VENEER

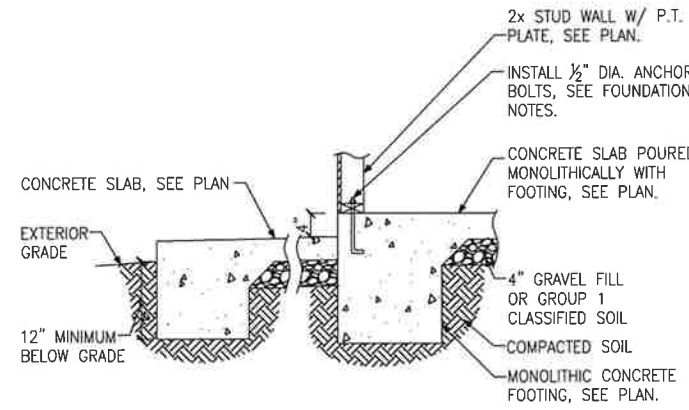

**C** FOUNDATION SECTION  
EXTERIOR WALL AT PORCH

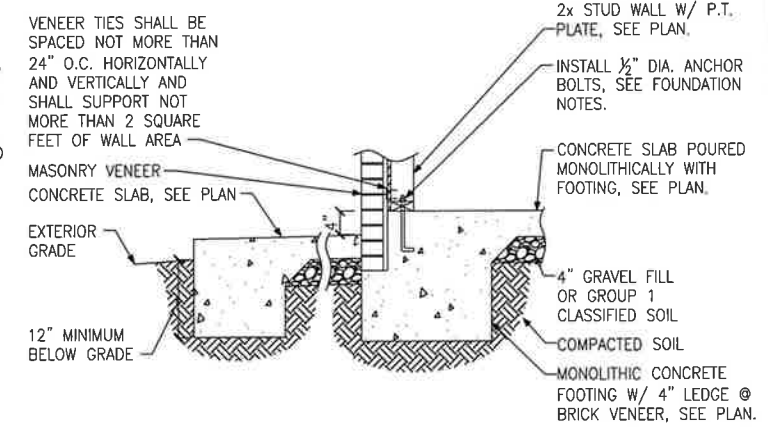

**D** FOUNDATION SECTION  
EXTERIOR WALL AT PORCH W/ MASONRY  
VENEER

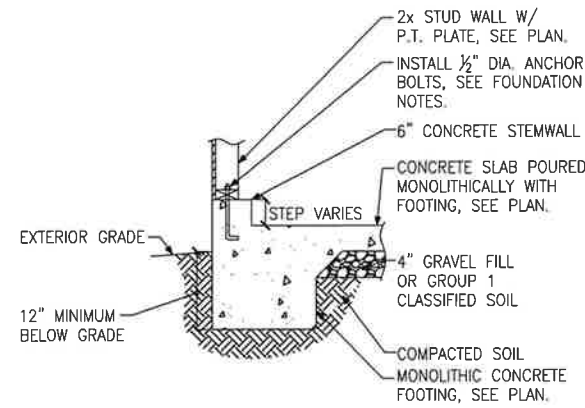

**E** FOUNDATION SECTION  
EXTERIOR GARAGE WALL

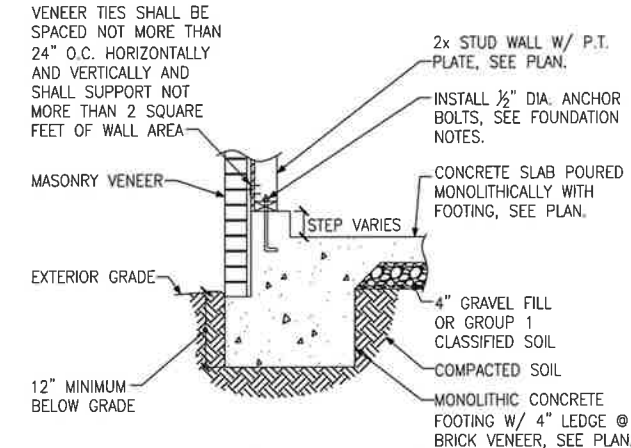

**F** FOUNDATION SECTION  
EXTERIOR GARAGE WALL @ MASONRY  
VENEER

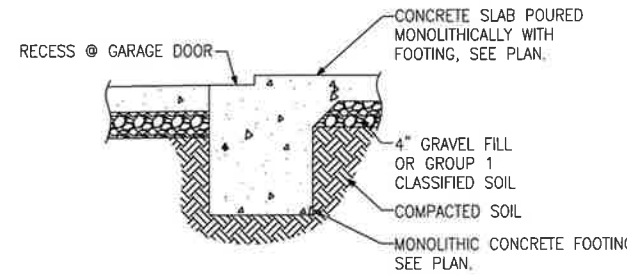

**G** FOUNDATION SECTION  
GARAGE DOOR

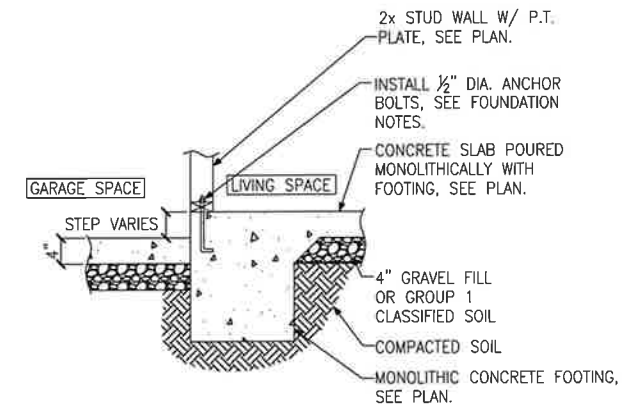

**H** FOUNDATION SECTION  
INTERIOR GARAGE WALL

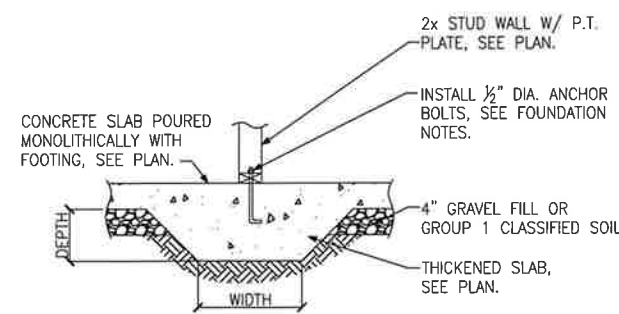

**J** FOUNDATION SECTION  
THICKENED SLAB

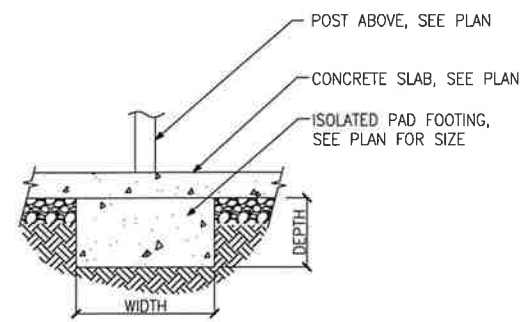

**K** FOUNDATION SECTION  
ISOLATED PAD FOOTING