

Mark Morris, P.E.

#126, 1317-M, Summerville, SC 29483

843 209-5784, Fax (866)-213-4614

The truss drawing(s) listed below have been prepared by **Atlantic Building Components** under my direct supervision based on the parameters provided by the truss designers.

AST #: 28542

JOB: 21-5631-R01

JOB NAME: 49786-0227 WOODGROVE

Wind Code: 37

Wind Speed: Vult= 115mph

Exposure Category: B

Mean Roof Height (feet): 20

These truss designs comply with IRC 2015 as well as IRC 2018.

18 Truss Design(s)

Trusses:

M01, M02, M03, R01, R02, R02B, R03, R03B, R04, R05, R06, R07, VT01, VT02, VT03, VT04,



9/20/2021

Mark Morris

Warning !—Verify design parameters and read notes before use.

This design is based only upon parameters shown, and is for an individual building component to be installed and loaded vertically. Applicability of design parameters and proper incorporation of component is responsibility of building designer – not truss designer or truss engineer. Bracing shown is for lateral support of individual web members only. Additional temporary bracing to ensure stability during construction is the responsibility of the erector. Additional permanent bracing of the overall structure is the responsibility of the building designer. For general guidance regarding fabrication, quality control, storage, delivery, erection and bracing, consult ANSI/TPI 1 *National Design Standard for Metal Plate Connected Wood Truss Construction* and BCSI 1-03 Guide to *Good Practice for Handling, Installing & Bracing of Metal Plate Connected Wood Trusses* from Truss Plate Institute, 583 D'Onofrio Drive, Madison, WI

Job 21-5631-R01	Truss M01	Truss Type GABLE	Qty 1	Ply 1	49786-0227 WOODGROVE FUQUAY VARINA, NC
					# 28542

8.430 s Feb 12 2021 MiTek Industries, Inc. Tue Sep 21 15:53:46 2021 Page 1
 ID:9CcuJl7eSaUnzH5X3uf?lgz6QyZ-DmiVR2f8Q8xzefnp?8KIYA8ZkN3WMLnA8wm9fNybNMP

-0-4-8 | 5-10-0 | 5-11-8
 0-4-8 | 5-10-0 | 0-1-8

Scale = 1:14.9

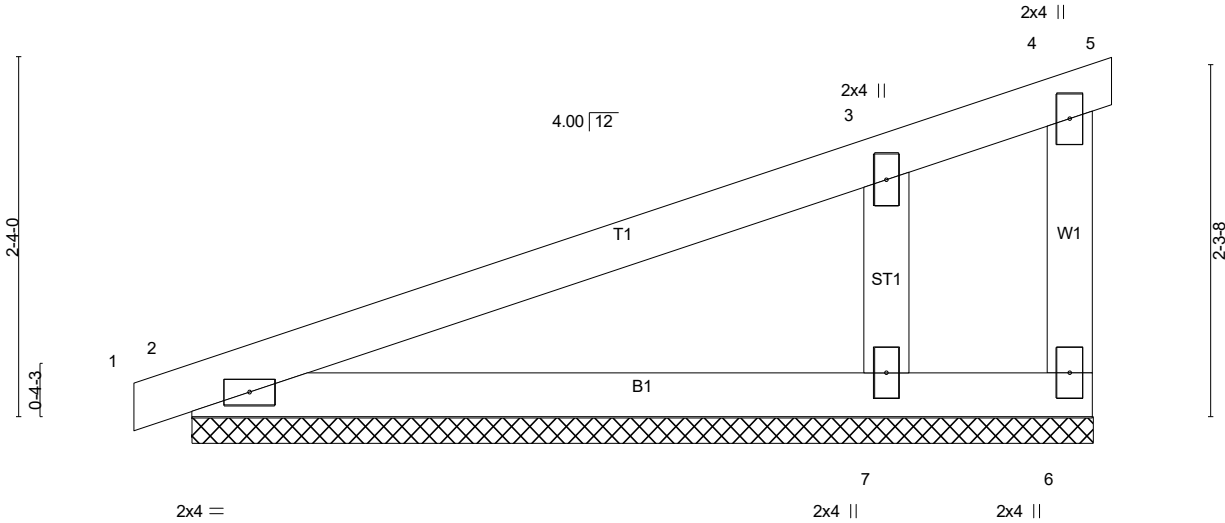

LOADING (psf)	SPACING-	CSI.	DEFL.	PLATES	GRIP
TCLL (roof) 20.0	2-0-0	TC 0.39	in (loc) l/defl L/d	MT20	244/190
Snow (Pf) 20.0	Plate Grip DOL 1.15	BC 0.28	Vert(LL) 0.00 4 n/r 180		
TCDL 10.0	Lumber DOL 1.15	WB 0.09	Vert(CT) -0.00 4 n/r 80		
BCLL 0.0 *	Rep Stress Incr YES	Matrix-P	Horz(CT) 0.00 n/a n/a		
BCDL 10.0	Code IRC2018/TPI2014			Weight: 23 lb	FT = 20%

LUMBER-	BRACING-
TOP CHORD 2x4 SP No.2	TOP CHORD Structural wood sheathing directly applied or 5-10-0 oc purlins, except end verticals.
BOT CHORD 2x4 SP No.3	BOT CHORD Rigid ceiling directly applied or 10-0-0 oc bracing.
WEBS 2x4 SP No.3	
OTHERS 2x4 SP No.3	MiTek recommends that Stabilizers and required cross bracing be installed during truss erection, in accordance with Stabilizer Installation guide.

REACTIONS. (lb/size) 6=68/5-10-0 (min. 0-1-8), 2=168/5-10-0 (min. 0-1-8), 7=394/5-10-0 (min. 0-1-8)
 Max Horz 2=53(LC 10)
 Max Uplift 6=89(LC 21), 2=-6(LC 10), 7=-37(LC 14)
 Max Grav 6=4(LC 14), 2=228(LC 21), 7=528(LC 21)

FORCES. (lb) - Max. Comp./Max. Ten. - All forces 250 (lb) or less except when shown.
 WEBS 3-7=-427/288

- NOTES-** (12-15)
- 1) Wind: ASCE 7-16; Vult=115mph (3-second gust) Vasd=91mph; TCCL=5.0psf; BCDL=5.0psf; h=10ft; Cat. II; Exp B; Enclosed; MWFRS (envelope) gable end zone and C-C Corner(3E) zone; C-C for members and forces & MWFRS for reactions shown; Lumber DOL=1.60 plate grip DOL=1.60
 - 2) Truss designed for wind loads in the plane of the truss only. For studs exposed to wind (normal to the face), see Standard Industry Gable End Details as applicable, or consult qualified building designer as per ANSI/TPI 1.
 - 3) TCCL: ASCE 7-16; Pr=20.0 psf (roof LL: Lum DOL=1.15 Plate DOL=1.15); Pf=20.0 psf (Lum DOL=1.15 Plate DOL=1.15); Is=1.0; Rough Cat B; Partially Exp.; Ce=1.0; Cs=1.00; Ct=1.10
 - 4) Unbalanced snow loads have been considered for this design.
 - 5) This truss has been designed for greater of min roof live load of 12.0 psf or 2.00 times flat roof load of 20.0 psf on overhangs non-concurrent with other live loads.
 - 6) Gable requires continuous bottom chord bearing.
 - 7) Gable studs spaced at 1-4-0 oc.
 - 8) This truss has been designed for a 10.0 psf bottom chord live load nonconcurrent with any other live loads.
 - 9) * This truss has been designed for a live load of 30.0psf on the bottom chord in all areas where a rectangle 3-6-0 tall by 1-0-0 wide will fit between the bottom chord and any other members.
 - 10) Provide mechanical connection (by others) of truss to bearing plate capable of withstanding 100 lb uplift at joint(s) 6, 2, 7.
 - 11) This truss is designed in accordance with the 2018 International Residential Code sections R502.11.1 and R802.10.2 and referenced standard ANSI/TPI 1.
 - 12) Graphical bracing representation does not depict the size, type or the orientation of the brace on the member. Symbol only indicates that the member must be braced.
 - 13) Bearing symbols are only graphical representations of a possible bearing condition. Bearing symbols are not considered in the structural design of the truss to support the loads indicated.
 - 14) Web bracing shown is for lateral support of individual web members only. Refer to BCSI - Guide to Good Practice for Handling, Installing, Restraining & Bracing of Metal Plate Connected Wood Trusses for additional bracing guidelines, including diagonal bracing.
 - 15) SEE BCSI-B3 SUMMARY SHEET- PERMANENT RESTRAINING/BRACING OF CHORDS & WEB MEMBERS FOR RECOMMENDED MINIMUM BRACING REQUIREMENTS OF TOP CHORD, BOTTOM CHORD, AND WEB PLANES. IN ADDITION TO THESE MINIMUM GUIDELINES, ALWAYS CONSULT THE PROJECT ARCHITECT OR ENGINEER FOR ADDITIONAL BRACING

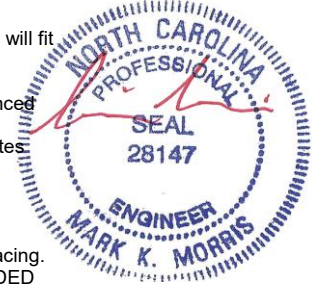

CONSIDERATIONS parameters and read notes before use. This design is based only upon parameters shown, and is for an individual building component to be installed and loaded vertically. Applicability of design parameters and proper incorporation of component is responsibility of building designer – not truss designer or truss engineer. Bracing shown is for lateral support of individual web members only. Additional temporary bracing to ensure stability during construction is the responsibility of the erector. Additional permanent bracing of the overall structure is the responsibility of the building designer. For general guidance regarding fabrication, quality control, storage, delivery, erection and bracing, consult ANSI/TPI 1 National Design Standard for Metal Plate Connected Wood Truss Construction and BCSI 1-03 Guide to Good Practice for Handling, Installing & Bracing of Metal Plate Connected Wood Trusses from Truss Plate Institute, 583 D'Onofrio Drive, Madison, WI 53719.

Job	Truss	Truss Type	Qty	Ply	49786-0227 WOODGROVE FUQUAY VARINA, NC
21-5631-R01	M01	GABLE	1	1	Job Reference (optional) # 28542

LOAD CASE(S) Standard



9/20/2021

Warning!—Verify design parameters and read notes before use. This design is based only upon parameters shown, and is for an individual building component to be installed and loaded vertically. Applicability of design parameters and proper incorporation of component is responsibility of building designer – not truss designer or truss engineer. Bracing shown is for lateral support of individual web members only. Additional temporary bracing to ensure stability during construction is the responsibility of the erector. Additional permanent bracing of the overall structure is the responsibility of the building designer. For general guidance regarding fabrication, quality control, storage, delivery, erection and bracing, consult ANSI/TPI 1 *National Design Standard for Metal Plate Connected Wood Truss Construction* and BCSI 1-03 *Guide to Good Practice for Handling, Installing & Bracing of Metal Plate Connected Wood Trusses* from Truss Plate Institute, 583 D'Onofrio Drive, Madison, WI 53719.

Job	Truss	Truss Type	Qty	Ply	49786-0227 WOODGROVE FUQUAY VARINA, NC
21-5631-R01	M02	Monopitch	9	1	Job Reference (optional) # 28542

8.430 s Feb 12 2021 MiTek Industries, Inc. Tue Sep 21 15:53:48 2021 Page 1

ID:9CcuJI7eSaUnzH5X3uf?lgz6QyZ-98qGskhPymBhuzxB7ZMDdbEogAjHqGdTbEFGkFybNM

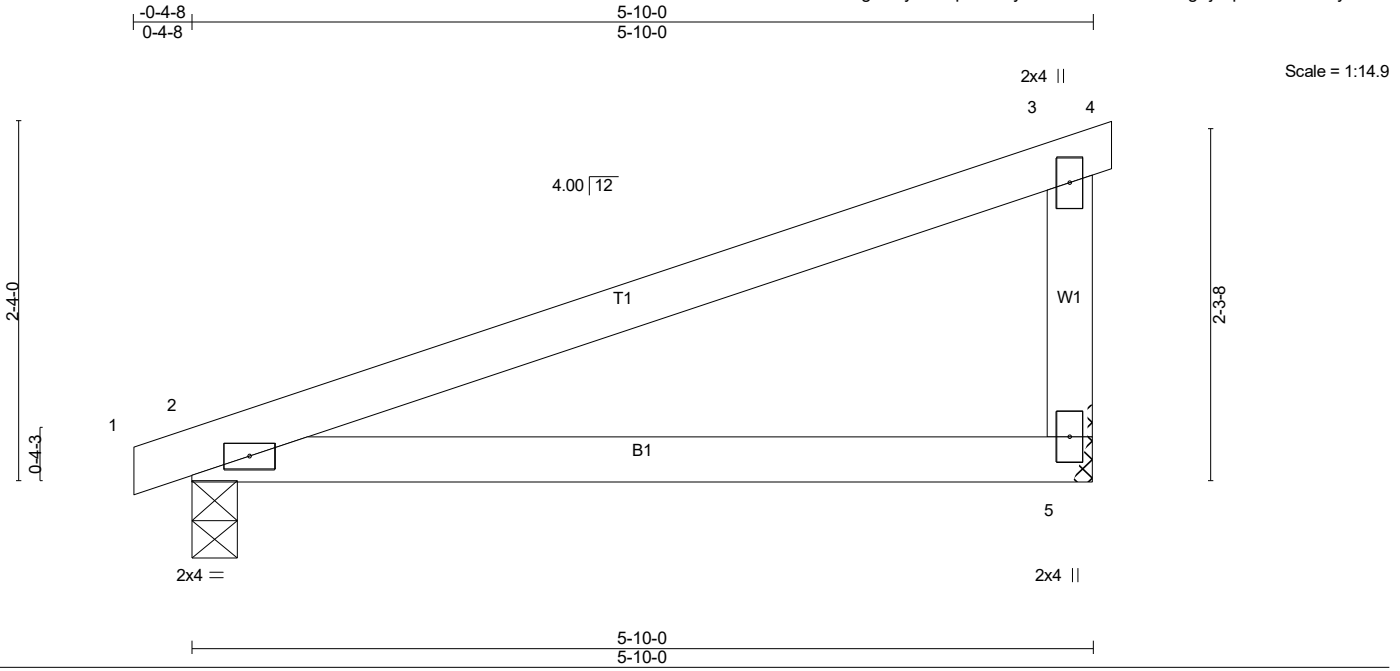

LOADING (psf)	SPACING-	CSI.	DEFL.	PLATES	GRIP
TCLL (roof) 20.0	2-0-0	TC 0.87	in (loc) l/defl L/d	MT20	244/190
Snow (Pf) 20.0	Plate Grip DOL 1.15	BC 0.39	Vert(LL) -0.06 2-5 >999 240		
TCDL 10.0	Lumber DOL 1.15	WB 0.00	Vert(CT) -0.11 2-5 >588 180		
BCLL 0.0 *	Rep Stress Incr YES	Matrix-P	Horz(CT) 0.00 n/a n/a		
BCDL 10.0	Code IRC2018/TPI2014			Weight: 21 lb	FT = 20%

LUMBER-	BRACING-
TOP CHORD 2x4 SP No.2	TOP CHORD Structural wood sheathing directly applied or 2-2-0 oc purlins, except end verticals.
BOT CHORD 2x4 SP No.2	BOT CHORD Rigid ceiling directly applied or 10-0-0 oc bracing.
WEBS 2x4 SP No.3	MiTek recommends that Stabilizers and required cross bracing be installed during truss erection, in accordance with Stabilizer Installation guide.

REACTIONS. (lb/size) 5=237/Mechanical, 2=254/0-3-8 (min. 0-1-8)
 Max Horz 2=53(LC 10)
 Max Uplift 5=-25(LC 14), 2=-17(LC 10)
 Max Grav 5=319(LC 21), 2=344(LC 21)

FORCES. (lb) - Max. Comp./Max. Ten. - All forces 250 (lb) or less except when shown.
 TOP CHORD 3-5=-264/103

- NOTES-** (10-13)
- 1) Wind: ASCE 7-16; Vult=115mph (3-second gust) Vasd=91mph; TC DL=5.0psf; BCDL=5.0psf; h=10ft; Cat. II; Exp B; Enclosed; MWFRS (envelope) gable end zone and C-C Exterior(2E) zone; C-C for members and forces & MWFRS for reactions shown; Lumber DOL=1.60 plate grip DOL=1.60
 - 2) TCLL: ASCE 7-16; Pr=20.0 psf (roof LL: Lum DOL=1.15 Plate DOL=1.15); Pf=20.0 psf (Lum DOL=1.15 Plate DOL=1.15); Is=1.0; Rough Cat B; Partially Exp.; Ce=1.0; Cs=1.00; Ct=1.10
 - 3) Unbalanced snow loads have been considered for this design.
 - 4) This truss has been designed for greater of min roof live load of 12.0 psf or 2.00 times flat roof load of 20.0 psf on overhangs non-concurrent with other live loads.
 - 5) This truss has been designed for a 10.0 psf bottom chord live load nonconcurrent with any other live loads.
 - 6) * This truss has been designed for a live load of 30.0psf on the bottom chord in all areas where a rectangle 3-6-0 tall by 1-0-0 wide will fit between the bottom chord and any other members.
 - 7) Refer to girder(s) for truss to truss connections.
 - 8) Provide mechanical connection (by others) of truss to bearing plate capable of withstanding 100 lb uplift at joint(s) 5, 2.
 - 9) This truss is designed in accordance with the 2018 International Residential Code sections R502.11.1 and R802.10.2 and referenced standard ANSI/TPI 1.
 - 10) Graphical bracing representation does not depict the size, type or the orientation of the brace on the member. Symbol only indicates that the member must be braced.
 - 11) Bearing symbols are only graphical representations of a possible bearing condition. Bearing symbols are not considered in the structural design of the truss to support the loads indicated.
 - 12) Web bracing shown is for lateral support of individual web members only. Refer to BCSI - Guide to Good Practice for Handling, Installing, Restraining & Bracing of Metal Plate Connected Wood Trusses for additional bracing guidelines, including diagonal bracing.
 - 13) SEE BCSI-B3 SUMMARY SHEET- PERMANENT RESTRAINING/BRACING OF CHORDS & WEB MEMBERS FOR RECOMMENDED MINIMUM BRACING REQUIREMENTS OF TOP CHORD, BOTTOM CHORD, AND WEB PLANES. IN ADDITION TO THESE MINIMUM GUIDELINES, ALWAYS CONSULT THE PROJECT ARCHITECT OR ENGINEER FOR ADDITIONAL BRACING CONSIDERATIONS.

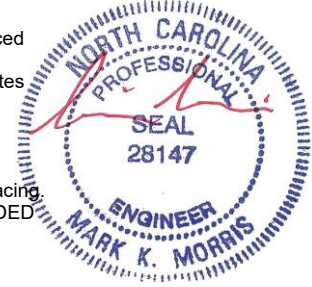

9/20/2021

LOAD CASE(S) Standard
Warning!—Verify design parameters and read notes before use. This design is based only upon parameters shown, and is for an individual building component to be installed and loaded vertically. Applicability of design parameters and proper incorporation of component is responsibility of building designer – not truss designer or truss engineer. Bracing shown is for lateral support of individual web members only. Additional temporary bracing to ensure stability during construction is the responsibility of the erector. Additional permanent bracing of the overall structure is the responsibility of the building designer. For general guidance regarding fabrication, quality control, storage, delivery, erection and bracing, consult ANSI/TPI 1 *National Design Standard for Metal Plate Connected Wood Truss Construction* and BCSI 1-03 *Guide to Good Practice for Handling, Installing & Bracing of Metal Plate Connected Wood Trusses* from Truss Plate Institute, 583 D'Onofrio Drive, Madison, WI 53719.

Job 21-5631-R01	Truss M03	Truss Type Monopitch Structural Gable	Qty 1	Ply 1	49786-0227 WOODGROVE FUQUAY VARINA, NC
					Job Reference (optional) # 28542

8.430 s Feb 12 2021 MiTek Industries, Inc. Tue Sep 21 15:53:49 2021 Page 1

ID:9CcuJl7eSaUnzH5X3uf?lgz6QyZ-dLNe44i1i3JYV7WOhHuSAom9za9eZjtcqu?pGhybNMm

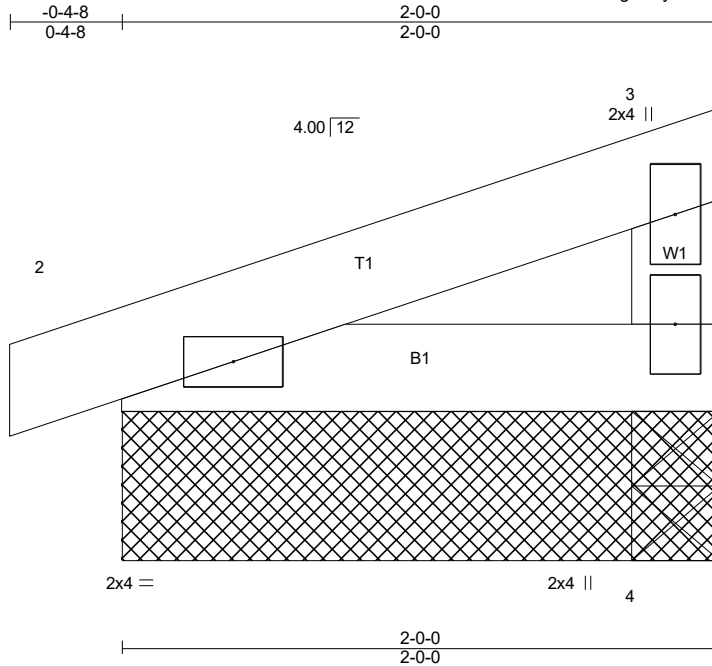

Scale = 1:7.7

LOADING (psf)		SPACING-	2-0-0	CSI.		DEFL.	in (loc)	l/defl	L/d	PLATES	GRIP
TCLL (roof)	20.0	Plate Grip DOL	1.15	TC	0.07	Vert(LL)	-0.00	2	>999	MT20	244/190
Snow (Pf)	20.0	Lumber DOL	1.15	BC	0.06	Vert(CT)	-0.00	2-4	>999		
TCDL	10.0	Rep Stress Incr	YES	WB	0.00	Horz(CT)	0.00	n/a	n/a		
BCLL	0.0 *	Code IRC2018/TPI2014		Matrix-P						Weight: 7 lb	FT = 20%
BCDL	10.0										

LUMBER-
TOP CHORD 2x4 SP No.2
BOT CHORD 2x4 SP No.3
WEBS 2x4 SP No.3

BRACING-
TOP CHORD Structural wood sheathing directly applied or 2-0-0 oc purlins, except end verticals.
BOT CHORD Rigid ceiling directly applied or 10-0-0 oc bracing.

MiTek recommends that Stabilizers and required cross bracing be installed during truss erection, in accordance with Stabilizer Installation guide.

REACTIONS. (lb/size) 4=72/2-0-0 (min. 0-1-8), 4=72/2-0-0 (min. 0-1-8), 2=99/2-0-0 (min. 0-1-8)
Max Horz 2=19(LC 10)
Max Uplift 4=-7(LC 14), 2=-11(LC 10)
Max Grav 4=88(LC 21), 4=72(LC 1), 2=123(LC 21)

FORCES. (lb) - Max. Comp./Max. Ten. - All forces 250 (lb) or less except when shown.

NOTES- (11-14)

- 1) Wind: ASCE 7-16; Vult=115mph (3-second gust) Vasd=91mph; TCDL=5.0psf; BCDL=5.0psf; h=10ft; Cat. II; Exp B; Enclosed; MWFRS (envelope) gable end zone and C-C Corner(3E) zone; C-C for members and forces & MWFRS for reactions shown; Lumber DOL=1.60 plate grip DOL=1.60
- 2) Truss designed for wind loads in the plane of the truss only. For studs exposed to wind (normal to the face), see Standard Industry Gable End Details as applicable, or consult qualified building designer as per ANSI/TPI 1.
- 3) TCLL: ASCE 7-16; Pr=20.0 psf (roof LL: Lum DOL=1.15 Plate DOL=1.15); Pf=20.0 psf (Lum DOL=1.15 Plate DOL=1.15); Is=1.0; Rough Cat B; Partially Exp.; Ce=1.0; Cs=1.00; Ct=1.10
- 4) Unbalanced snow loads have been considered for this design.
- 5) This truss has been designed for greater of min roof live load of 12.0 psf or 2.00 times flat roof load of 20.0 psf on overhangs non-concurrent with other live loads.
- 6) Gable studs spaced at 2-0-0 oc.
- 7) This truss has been designed for a 10.0 psf bottom chord live load nonconcurrent with any other live loads.
- 8) * This truss has been designed for a live load of 30.0psf on the bottom chord in all areas where a rectangle 3-6-0 tall by 1-0-0 wide will fit between the bottom chord and any other members.
- 9) Provide mechanical connection (by others) of truss to bearing plate capable of withstanding 100 lb uplift at joint(s) 4, 2.
- 10) This truss is designed in accordance with the 2018 International Residential Code sections R502.11.1 and R802.10.2 and referenced standard ANSI/TPI 1.
- 11) Graphical bracing representation does not depict the size, type or the orientation of the brace on the member. Symbol only indicates that the member must be braced.
- 12) Bearing symbols are only graphical representations of a possible bearing condition. Bearing symbols are not considered in the structural design of the truss to support the loads indicated.
- 13) Web bracing shown is for lateral support of individual web members only. Refer to BCSI - Guide to Good Practice for Handling, Installing, Restraining & Bracing of Metal Plate Connected Wood Trusses for additional bracing guidelines, including diagonal bracing.
- 14) SEE BCSI-B3 SUMMARY SHEET- PERMANENT RESTRAINING/BRACING OF CHORDS & WEB MEMBERS FOR RECOMMENDED MINIMUM BRACING REQUIREMENTS OF TOP CHORD, BOTTOM CHORD, AND WEB PLANES. IN ADDITION TO THESE MINIMUM GUIDELINES, ALWAYS CONSULT THE PROJECT ARCHITECT OR ENGINEER FOR ADDITIONAL BRACING CONSIDERATIONS.

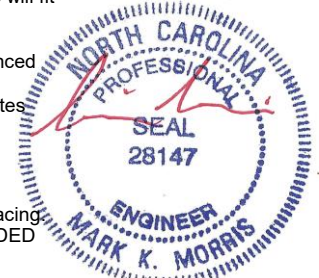

9/20/2021

LOAD CASE(S) Standard parameters and read notes before use. This design is based only upon parameters shown, and is for an individual building component to be installed and loaded vertically. Applicability of design parameters and proper incorporation of component is responsibility of building designer – not truss designer or truss engineer. Bracing shown is for lateral support of individual web members only. Additional temporary bracing to ensure stability during construction is the responsibility of the erector. Additional permanent bracing of the overall structure is the responsibility of the building designer. For general guidance regarding fabrication, quality control, storage, delivery, erection and bracing, consult ANSI/TPI 1 National Design Standard for Metal Plate Connected Wood Truss Construction and BCSI 1-03 Guide to Good Practice for Handling, Installing & Bracing of Metal Plate Connected Wood Trusses from Truss Plate Institute, 583 D'Onofrio Drive, Madison, WI 53719.

Job 21-5631-R01	Truss R01	Truss Type GABLE	Qty 1	Ply 1	49786-0227 WOODGROVE FUQUAY VARINA, NC
					Job Reference (optional) # 28542

8.430 s Feb 12 2021 MiTek Industries, Inc. Tue Sep 21 15:53:53 2021 Page 1
ID:9CcuJI7eSaUnzH5X3uf?lgz6QyZ-W6d9vRIXmpz_kp9w7yOKexqRBV7VvJCIWz1PTyNBMI



Scale = 1:62.1

Plate Offsets (X,Y)-- [7:0-3-0,0-3-0], [23:0-3-0,0-3-0], [39:0-3-8,0-0-4]

LOADING (psf)	SPACING-	2-0-0	CSI.	DEFL.	in (loc)	l/defl	L/d	PLATES	GRIP
TCLL (roof) 20.0	Plate Grip DOL 1.15		TC 0.10	Vert(LL) 0.00	1	n/r	180	MT20	244/190
Snow (Pf) 20.0	Lumber DOL 1.15		BC 0.09	Vert(CT) 0.00	1	n/r	80		
TCDL 10.0	Rep Stress Incr YES		WB 0.14	Horz(CT) 0.01	29	n/a	n/a		
BCLL 0.0 *	Code IRC2018/TPI2014		Matrix-SH						
BCDL 10.0								Weight: 307 lb	FT = 20%

LUMBER-
TOP CHORD 2x4 SP No.2
BOT CHORD 2x4 SP No.3
WEBS 2x4 SP No.3
OTHERS 2x4 SP No.3

BRACING-
TOP CHORD Structural wood sheathing directly applied or 6-0-0 oc purlins, except end verticals.
BOT CHORD Rigid ceiling directly applied or 10-0-0 oc bracing.
WEBS 1 Row at midpt 15-43, 14-44, 13-45, 16-42, 17-41

MiTek recommends that Stabilizers and required cross bracing be installed during truss erection, in accordance with Stabilizer Installation guide.

REACTIONS. All bearings 35-8-8.
(lb) - Max Horz 57=118(LC 14)
Max Uplift All uplift 100 lb or less at joint(s) 57, 29, 44, 45, 46, 47, 49, 50, 51, 52, 53, 54, 55, 56, 42, 41, 40, 39, 37, 36, 35, 34, 33, 32, 31, 30
Max Grav All reactions 250 lb or less at joint(s) 57, 29, 43, 44, 45, 46, 47, 49, 50, 51, 52, 53, 54, 55, 56, 42, 41, 40, 39, 37, 36, 35, 34, 33, 32, 31, 30

FORCES. (lb) - Max. Comp./Max. Ten. - All forces 250 (lb) or less except when shown.

- NOTES-** (15-18)
- 1) Unbalanced roof live loads have been considered for this design.
 - 2) Wind: ASCE 7-16; Vult=115mph (3-second gust) Vasd=91mph; TCCL=5.0psf; BCDL=5.0psf; h=24ft; Cat. II; Exp B; Enclosed; MWFRS (envelope) gable end zone and C-C Corner(3E) -0-4-8 to 3-4-0, Exterior(2N) 3-4-0 to 14-0-0, Corner(3R) 14-0-0 to 22-0-0, Exterior(2N) 22-0-0 to 31-4-0, Corner(3E) 31-4-0 to 35-6-12 zone; C-C for members and forces & MWFRS for reactions shown; Lumber DOL=1.60 plate grip DOL=1.60
 - 3) Truss designed for wind loads in the plane of the truss only. For studs exposed to wind (normal to the face), see Standard Industry Gable End Details as applicable, or consult qualified building designer as per ANSI/TPI 1.
 - 4) TCLL: ASCE 7-16; Pr=20.0 psf (roof LL: Lum DOL=1.15 Plate DOL=1.15); Pf=20.0 psf (Lum DOL=1.15 Plate DOL=1.15); Is=1.0; Rough Cat B; Partially Exp.; Ce=1.0; Cs=1.00; Ct=1.10
 - 5) Unbalanced snow loads have been considered for this design.
 - 6) This truss has been designed for greater of min roof live load of 12.0 psf or 2.00 times flat roof load of 20.0 psf on overhangs non-concurrent with other live loads.
 - 7) All plates are 2x4 MT20 unless otherwise indicated.
 - 8) Gable requires continuous bottom chord bearing.
 - 9) Truss to be fully sheathed from one face or securely braced against lateral movement (i.e. diagonal web).
 - 10) Gable studs spaced at 1-4-0 oc.
 - 11) This truss has been designed for a 10.0 psf bottom chord live load nonconcurrent with any other live loads.
 - 12) * This truss has been designed for a live load of 30.0psf on the bottom chord in all areas where a rectangle 3-6-0 tall by 1-0-0 wide will fit between the bottom chord and any other members, with BCDL = 10.0psf.
 - 13) Provide mechanical connection (by others) of truss to bearing plate capable of withstanding 100 lb uplift at joint(s) 57, 29, 44, 45, 46, 47, 49, 50, 51, 52, 53, 54, 55, 56, 42, 41, 40, 39, 37, 36, 35, 34, 33, 32, 31, 30.
 - 14) This truss is designed in accordance with the 2018 International Residential Code sections R502.11.1 and R802.10.2 and referenced standard ANSI/TPI 1.

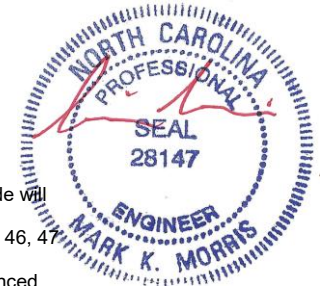

9/20/2021

Warning!—Verify design parameters and read notes before use. This design is based only upon parameters shown, and is for an individual building component to be installed and loaded vertically. Applicability of design parameters and proper incorporation of component is responsibility of building designer – not truss designer or truss engineer. Bracing shown is for lateral support of individual web members only. Additional temporary bracing to ensure stability during construction is the responsibility of the erector. Additional permanent bracing of the overall structure is the responsibility of the building designer. For general guidance regarding fabrication, quality control, storage, delivery, erection and bracing, consult ANSI/TPI 1 *National Design Standard for Metal Plate Connected Wood Truss Construction* and BCSI 1-03 *Guide to Good Practice for Handling, Installing & Bracing of Metal Plate Connected Wood Trusses* from Truss Plate Institute, 583 D'Onofrio Drive, Madison, WI 53719.

Job	Truss	Truss Type	Qty	Ply	49786-0227 WOODGROVE FUQUAY VARINA, NC
21-5631-R01	R01	GABLE	1	1	Job Reference (optional) # 28542

8.430 s Feb 12 2021 MiTek Industries, Inc. Tue Sep 21 15:53:55 2021 Page 2
 ID:9CcuJl7eSaUnzH5X3uf?lgz6QyZ-SVlvK7molv3hD2zX1X_sQ30Ax?BbzPDVCqS7ULybNMg

- 15) Graphical bracing representation does not depict the size, type or the orientation of the brace on the member. Symbol only indicates that the member must be braced.
- 16) Bearing symbols are only graphical representations of a possible bearing condition. Bearing symbols are not considered in the structural design of the truss to support the loads indicated.
- 17) Web bracing shown is for lateral support of individual web members only. Refer to BCSI - Guide to Good Practice for Handling, Installing, Restraining & Bracing of Metal Plate Connected Wood Trusses for additional bracing guidelines, including diagonal bracing.
- 18) SEE BCSI-B3 SUMMARY SHEET- PERMANENT RESTRAING/BRACING OF CHORDS & WEB MEMBERS FOR RECOMMENDED MINIMUM BRACING REQUIREMENTS OF TOP CHORD, BOTTOM CHORD, AND WEB PLANES. IN ADDITION TO THESE MINIMUM GUIDELINES, ALWAYS CONSULT THE PROJECT ARCHITECT OR ENGINEER FOR ADDITIONAL BRACING CONSIDERATIONS.

LOAD CASE(S) Standard



9/20/2021

Warning !—Verify design parameters and read notes before use. This design is based only upon parameters shown, and is for an individual building component to be installed and loaded vertically. Applicability of design parameters and proper incorporation of component is responsibility of building designer – not truss designer or truss engineer. Bracing shown is for lateral support of individual web members only. Additional temporary bracing to ensure stability during construction is the responsibility of the erector. Additional permanent bracing of the overall structure is the responsibility of the building designer. For general guidance regarding fabrication, quality control, storage, delivery, erection and bracing, consult ANSI/TPI 1 *National Design Standard for Metal Plate Connected Wood Truss Construction* and BCSI 1-03 *Guide to Good Practice for Handling, Installing & Bracing of Metal Plate Connected Wood Trusses* from Truss Plate Institute, 583 D'Onofrio Drive, Madison, WI 53719.

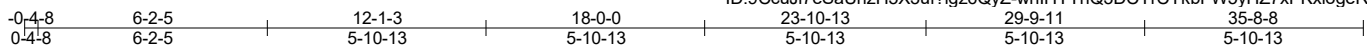

Scale = 1:62.1

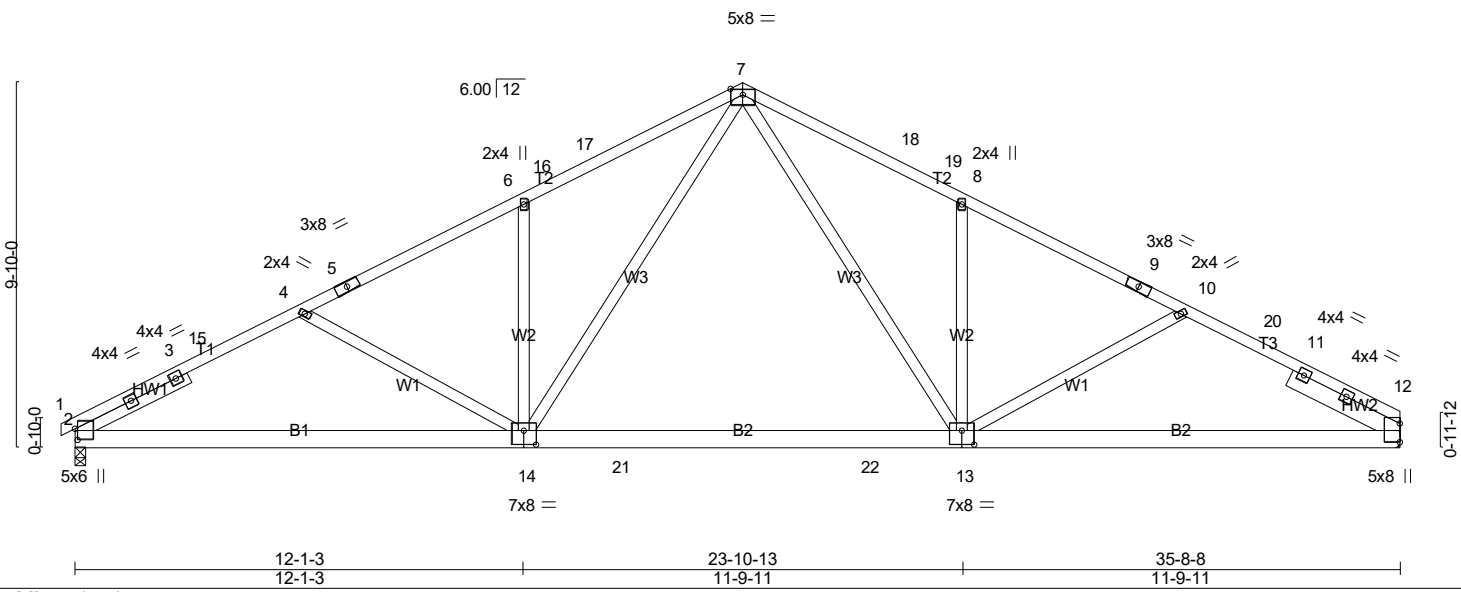

Plate Offsets (X,Y)-- [2:0-3-9,0-0-13], [13:0-4-0,0-4-8], [14:0-4-0,0-4-8]

LOADING (psf)	SPACING-	CSI.	DEFL.	in (loc)		l/defl	L/d	PLATES	GRIP
TCLL (roof) 20.0	Plate Grip DOL 1.15	TC 0.98	Vert(LL) -0.43	13-14	>999	240		MT20	244/190
Snow (Pf) 20.0	Lumber DOL 1.15	BC 0.92	Vert(CT) -0.60	13-14	>713	180			
TCDL 10.0	Rep Stress Incr YES	WB 0.44	Horz(CT) 0.07	12	n/a	n/a			
BCLL 0.0 *	Code IRC2018/TPI2014	Matrix-SH							
BCDL 10.0								Weight: 227 lb	FT = 20%

LUMBER- TOP CHORD 2x4 SP No.2 BOT CHORD 2x6 SP No.2 WEBS 2x4 SP No.3 SLIDER Left 2x4 SP No.3 - 3-4-12, Right 2x6 SP No.2 - 3-3-9	BRACING- TOP CHORD Structural wood sheathing directly applied. BOT CHORD Rigid ceiling directly applied or 2-2-0 oc bracing. <div style="border: 1px solid black; padding: 5px; margin-top: 10px;"> MiTek recommends that Stabilizers and required cross bracing be installed during truss erection, in accordance with Stabilizer Installation guide. </div>
---	---

REACTIONS. (lb/size) 2=1451/0-3-8 (min. 0-1-11), 12=1428/Mechanical
 Max Horz 2=-118(LC 15)
 Max Uplift 2=-85(LC 14), 12=-78(LC 15)

FORCES. (lb) - Max. Comp./Max. Ten. - All forces 250 (lb) or less except when shown.
TOP CHORD 2-3=-2444/178, 3-15=-2366/194, 4-15=-2352/204, 4-5=-2202/159, 5-6=-2145/180,
 6-16=-2219/242, 16-17=-2202/248, 7-17=-2145/266, 7-18=-2119/267, 18-19=-2176/249,
 8-19=-2193/243, 8-9=-2119/181, 9-10=-2159/159, 10-20=-2271/202, 11-20=-2297/189,
 11-12=-2374/177
BOT CHORD 2-14=-197/2067, 14-21=0/1392, 21-22=0/1392, 13-22=0/1392, 12-13=-106/1987
WEBS 4-14=-285/143, 6-14=-497/168, 7-14=-139/1074, 7-13=-139/1031, 8-13=-506/169

- NOTES-** (11-14)
- 1) Unbalanced roof live loads have been considered for this design.
 - 2) Wind: ASCE 7-16; Vult=115mph (3-second gust) Vasd=91mph; TCCL=5.0psf; BCDL=5.0psf; h=24ft; Cat. II; Exp B; Enclosed; MWFRS (envelope) gable end zone and C-C Exterior(2E) 0-4-8 to 3-7-2, Interior(1) 3-7-2 to 14-0-6, Exterior(2R) 14-0-6 to 21-11-10, Interior(1) 21-11-10 to 31-8-14, Exterior(2E) 31-8-14 to 35-8-8 zone; C-C for members and forces & MWFRS for reactions shown; Lumber DOL=1.60 plate grip DOL=1.60
 - 3) TCLL: ASCE 7-16; Pr=20.0 psf (roof LL: Lum DOL=1.15 Plate DOL=1.15); Pf=20.0 psf (Lum DOL=1.15 Plate DOL=1.15); Is=1.0; Rough Cat B; Partially Exp.; Ce=1.0; Cs=1.00; Ct=1.10
 - 4) Unbalanced snow loads have been considered for this design.
 - 5) This truss has been designed for greater of min roof live load of 12.0 psf or 2.00 times flat roof load of 20.0 psf on overhangs non-concurrent with other live loads.
 - 6) This truss has been designed for a 10.0 psf bottom chord live load nonconcurrent with any other live loads.
 - 7) * This truss has been designed for a live load of 30.0psf on the bottom chord in all areas where a rectangle 3-6-0 tall by 1-0-0 wide will fit between the bottom chord and any other members, with BCDL = 10.0psf.
 - 8) Refer to girder(s) for truss to truss connections.
 - 9) Provide mechanical connection (by others) of truss to bearing plate capable of withstanding 100 lb uplift at joint(s) 2, 12.
 - 10) This truss is designed in accordance with the 2018 International Residential Code sections R502.11.1 and R802.10.2 and referenced standard ANSI/TPI 1.

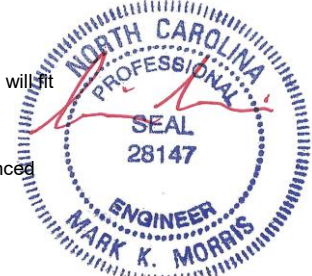

9/20/2021

Warning!—Verify design parameters and read notes before use. This design is based only upon parameters shown, and is for an individual building component to be installed and loaded vertically. Applicability of design parameters and proper incorporation of component is responsibility of building designer – not truss designer or truss engineer. Bracing shown is for lateral support of individual web members only. Additional temporary bracing to ensure stability during construction is the responsibility of the erector. Additional permanent bracing of the overall structure is the responsibility of the building designer. For general guidance regarding fabrication, quality control, storage, delivery, erection and bracing, consult ANSI/TPI 1 *National Design Standard for Metal Plate Connected Wood Truss Construction* and BCSI 1-03 *Guide to Good Practice for Handling, Installing & Bracing of Metal Plate Connected Wood Trusses* from Truss Plate Institute, 583 D'Onofrio Drive, Madison, WI 53719.

Job	Truss	Truss Type	Qty	Ply	49786-0227 WOODGROVE FUQUAY VARINA, NC
21-5631-R01	R02	Common	9	1	Job Reference (optional) # 28542

8.430 s Feb 12 2021 MiTek Industries, Inc. Tue Sep 21 15:53:57 2021 Page 2
 ID:9CcuJI7eSaUnzH5X3uf?lgz6QyZ-Otsflpo2qXKPTM7w9y1KVU6lhogARFwnf8xEYEybNMe

- 11) Graphical bracing representation does not depict the size, type or the orientation of the brace on the member. Symbol only indicates that the member must be braced.
- 12) Bearing symbols are only graphical representations of a possible bearing condition. Bearing symbols are not considered in the structural design of the truss to support the loads indicated.
- 13) Web bracing shown is for lateral support of individual web members only. Refer to BCSI - Guide to Good Practice for Handling, Installing, Restraining & Bracing of Metal Plate Connected Wood Trusses for additional bracing guidelines, including diagonal bracing.
- 14) SEE BCSI-B3 SUMMARY SHEET- PERMANENT RESTRAING/BRACING OF CHORDS & WEB MEMBERS FOR RECOMMENDED MINIMUM BRACING REQUIREMENTS OF TOP CHORD, BOTTOM CHORD, AND WEB PLANES. IN ADDITION TO THESE MINIMUM GUIDELINES, ALWAYS CONSULT THE PROJECT ARCHITECT OR ENGINEER FOR ADDITIONAL BRACING CONSIDERATIONS.

LOAD CASE(S) Standard



9/20/2021

Warning !—Verify design parameters and read notes before use. This design is based only upon parameters shown, and is for an individual building component to be installed and loaded vertically. Applicability of design parameters and proper incorporation of component is responsibility of building designer – not truss designer or truss engineer. Bracing shown is for lateral support of individual web members only. Additional temporary bracing to ensure stability during construction is the responsibility of the erector. Additional permanent bracing of the overall structure is the responsibility of the building designer. For general guidance regarding fabrication, quality control, storage, delivery, erection and bracing, consult ANSI/TPI 1 *National Design Standard for Metal Plate Connected Wood Truss Construction* and BCSI 1-03 *Guide to Good Practice for Handling, Installing & Bracing of Metal Plate Connected Wood Trusses* from Truss Plate Institute, 583 D'Onofrio Drive, Madison, WI 53719.

Job 21-5631-R01	Truss R02B	Truss Type Common	Qty 1	Ply 1	49786-0227 WOODGROVE FUQUAY VARINA, NC	# 28542
--------------------	---------------	----------------------	----------	----------	--	---------

8.430 s Feb 12 2021 MiTek Industries, Inc. Tue Sep 21 15:53:59 2021 Page 1
 ID:9CcuJl7eSaUnzH5X3uf?lgz6QyZ-KG_QAVqIM8a7ifHJGN3oavBhbcOTv6u47SQLd6ybNMf



Scale = 1:63.1

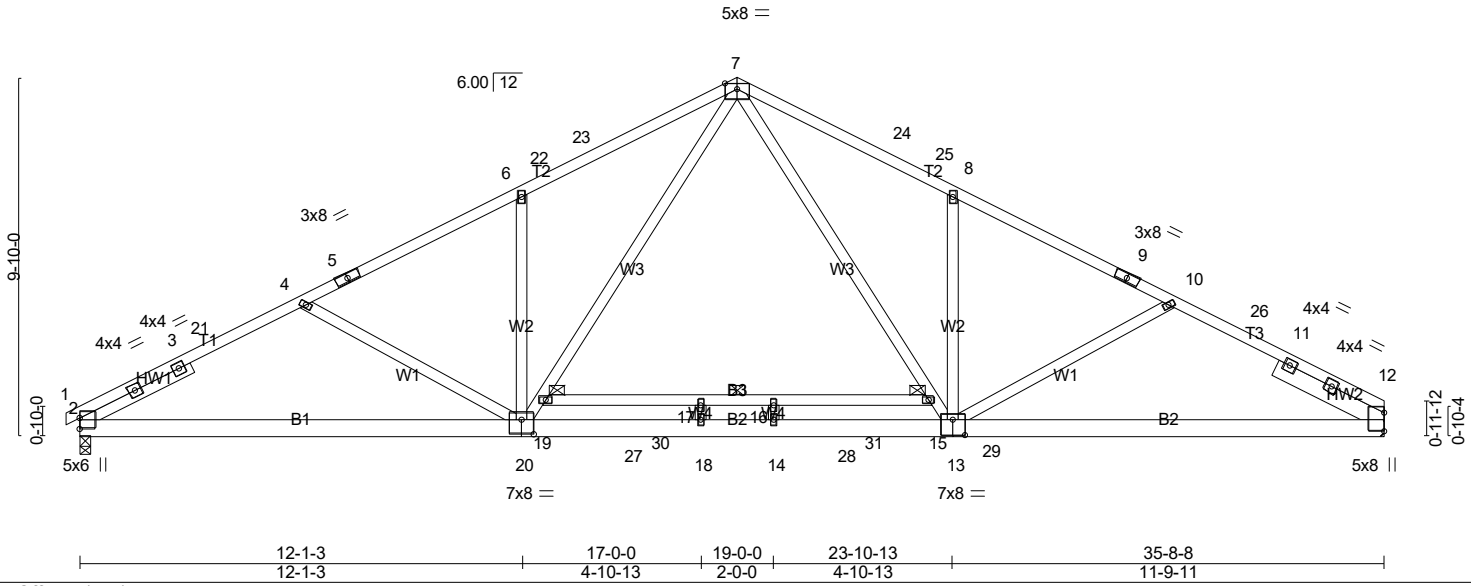

Plate Offsets (X,Y)-- [13:0-4-0,0-5-0], [20:0-4-0,0-4-12]

LOADING (psf)	SPACING-	CSI.	DEFL.	PLATES	GRIP
TCLL (roof) 20.0	2-0-0	TC 0.83	in (loc) l/defl L/d	MT20	244/190
Snow (Pf) 20.0	Plate Grip DOL 1.15	BC 0.73	Vert(LL) -0.54 14-18 >795 240		
TCDL 10.0	Lumber DOL 1.15	WB 0.61	Vert(CT) -0.81 14-18 >530 180		
BCLL 0.0 *	Rep Stress Incr YES	Matrix-SH	Horz(CT) 0.06 12 n/a n/a		
BCDL 10.0	Code IRC2018/TPI2014			Weight: 244 lb	FT = 20%

LUMBER-
 TOP CHORD 2x4 SP No.2 *Except*
 T1: 2x4 SP No.1, T3: 2x4 SP SS
 BOT CHORD 2x6 SP DSS *Except*
 B1: 2x6 SP No.1, B3: 2x4 SP No.2
 WEBS 2x4 SP No.3
 SLIDER Left 2x4 SP No.3 - 3-4-12, Right 2x6 SP No.2 - 3-3-9

BRACING-
 TOP CHORD Structural wood sheathing directly applied or 2-2-0 oc purlins.
 BOT CHORD Rigid ceiling directly applied or 9-6-15 oc bracing. Except:
 6-0-0 oc bracing: 15-19
 MiTek recommends that Stabilizers and required cross bracing be installed during truss erection, in accordance with Stabilizer Installation guide.

REACTIONS. (lb/size) 2=1558/0-3-8 (min. 0-1-15), 12=1537/Mechanical
 Max Horz 2=-118(LC 15)
 Max Uplift 2=-31(LC 14), 12=-23(LC 15)
 Max Grav 2=1637(LC 3), 12=1624(LC 3)

FORCES. (lb) - Max. Comp./Max. Ten. - All forces 250 (lb) or less except when shown.
 TOP CHORD 2-3=-2903/66, 3-21=-2824/80, 4-21=-2810/92, 4-5=-2672/36, 5-6=-2631/61,
 6-22=-2705/122, 22-23=-2688/128, 7-23=-2631/145, 7-24=-2611/146, 24-25=-2668/128,
 8-25=-2685/122, 8-9=-2611/61, 9-10=-2649/37, 10-26=-2728/92, 11-26=-2753/81,
 11-12=-2832/66
 BOT CHORD 2-20=-101/2462, 20-27=0/1723, 18-27=0/1723, 14-18=0/1723, 14-28=0/1723, 28-29=0/1723,
 13-29=0/1723, 12-13=-13/2375
 WEBS 4-20=-263/157, 6-20=-500/165, 19-20=-103/1233, 7-19=-75/1326, 7-15=-74/1293,
 13-15=-102/1200, 8-13=-507/165

- NOTES-** (12-15)
- Unbalanced roof live loads have been considered for this design.
 - Wind: ASCE 7-16; Vult=115mph (3-second gust) Vasd=91mph; TCCL=5.0psf; BCDL=5.0psf; h=24ft; Cat. II; Exp B; Enclosed; MWFRS (envelope) gable end zone and C-C Exterior(2E) -0-4-8 to 3-7-2, Interior(1) 3-7-2 to 14-0-6, Exterior(2R) 14-0-6 to 21-11-10, Interior(1) 21-11-10 to 31-8-14, Exterior(2E) 31-8-14 to 35-8-8 zone; C-C for members and forces & MWFRS for reactions shown; Lumber DOL=1.60 plate grip DOL=1.60
 - TCCL: ASCE 7-16; Pr=20.0 psf (roof LL: Lum DOL=1.15 Plate DOL=1.15); Pf=20.0 psf (Lum DOL=1.15 Plate DOL=1.15); Is=1.0; Rough Cat B; Partially Exp.; Ce=1.0; Cs=1.00; Ct=1.10
 - Unbalanced snow loads have been considered for this design.
 - This truss has been designed for greater of min roof live load of 12.0 psf or 2.00 times flat roof load of 20.0 psf on overhangs non-concurrent with other live loads.
 - All plates are 2x4 MT20 unless otherwise indicated.
 - This truss has been designed for a 10.0 psf bottom chord live load nonconcurrent with any other live loads.
 - * This truss has been designed for a live load of 30.0psf on the bottom chord in all areas where a rectangle 3-6-0 tall by 1-0-0 wide will fit between the bottom chord and any other members, with BCDL = 10.0psf.
 - Refer to girder(s) for truss to truss connections.
 - Provide mechanical connection (by others) of truss to bearing plate capable of withstanding 100 lb uplift at joint(s) 2, 12.
 - This truss is designed in accordance with the 2018 International Residential Code sections R502.11.1 and R802.10.2 and referenced standard ANSI/TPI 1.

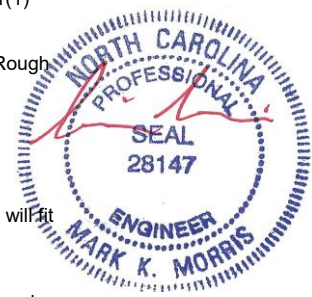

9/20/2021

Warning!—Verify design parameters and read notes before use. This design is based only upon parameters shown, and is for an individual building component to be installed and loaded vertically. Applicability of design parameters and proper incorporation of component is responsibility of building designer – not truss designer or truss engineer. Bracing shown is for lateral support of individual web members only. Additional temporary bracing to ensure stability during construction is the responsibility of the erector. Additional permanent bracing of the overall structure is the responsibility of the building designer. For general guidance regarding fabrication, quality control, storage, delivery, erection and bracing, consult ANSI/TPI 1 National Design Standard for Metal Plate Connected Wood Truss Construction and BCSI 1-03 Guide to Good Practice for Handling, Installing & Bracing of Metal Plate Connected Wood Trusses from Truss Plate Institute, 583 D'Onofrio Drive, Madison, WI 53719.

Job	Truss	Truss Type	Qty	Ply	49786-0227 WOODGROVE FUQUAY VARINA, NC
21-5631-R01	R02B	Common	1	1	Job Reference (optional) # 28542

8.430 s Feb 12 2021 MiTek Industries, Inc. Tue Sep 21 15:53:59 2021 Page 2
 ID:9CcuJl7eSaUnzH5X3uf?lgz6QyZ-KG_QAVqIM8a7fHJGN3oavBhbcOTv6u47SQLd6ybNMc

- 12) Graphical bracing representation does not depict the size, type or the orientation of the brace on the member. Symbol only indicates that the member must be braced.
- 13) Bearing symbols are only graphical representations of a possible bearing condition. Bearing symbols are not considered in the structural design of the truss to support the loads indicated.
- 14) Web bracing shown is for lateral support of individual web members only. Refer to BCSI - Guide to Good Practice for Handling, Installing, Restraining & Bracing of Metal Plate Connected Wood Trusses for additional bracing guidelines, including diagonal bracing.
- 15) SEE BCSI-B3 SUMMARY SHEET- PERMANENT RESTRAING/BRACING OF CHORDS & WEB MEMBERS FOR RECOMMENDED MINIMUM BRACING REQUIREMENTS OF TOP CHORD, BOTTOM CHORD, AND WEB PLANES. IN ADDITION TO THESE MINIMUM GUIDELINES, ALWAYS CONSULT THE PROJECT ARCHITECT OR ENGINEER FOR ADDITIONAL BRACING CONSIDERATIONS.

LOAD CASE(S) Standard



9/20/2021

Warning !—Verify design parameters and read notes before use. This design is based only upon parameters shown, and is for an individual building component to be installed and loaded vertically. Applicability of design parameters and proper incorporation of component is responsibility of building designer – not truss designer or truss engineer. Bracing shown is for lateral support of individual web members only. Additional temporary bracing to ensure stability during construction is the responsibility of the erector. Additional permanent bracing of the overall structure is the responsibility of the building designer. For general guidance regarding fabrication, quality control, storage, delivery, erection and bracing, consult ANSI/TPI 1 *National Design Standard for Metal Plate Connected Wood Truss Construction* and BCSI 1-03 *Guide to Good Practice for Handling, Installing & Bracing of Metal Plate Connected Wood Trusses* from Truss Plate Institute, 583 D'Onofrio Drive, Madison, WI 53719.

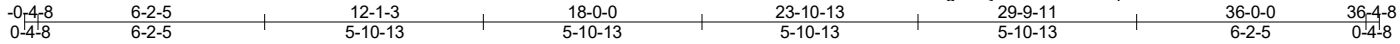

Scale = 1:62.5

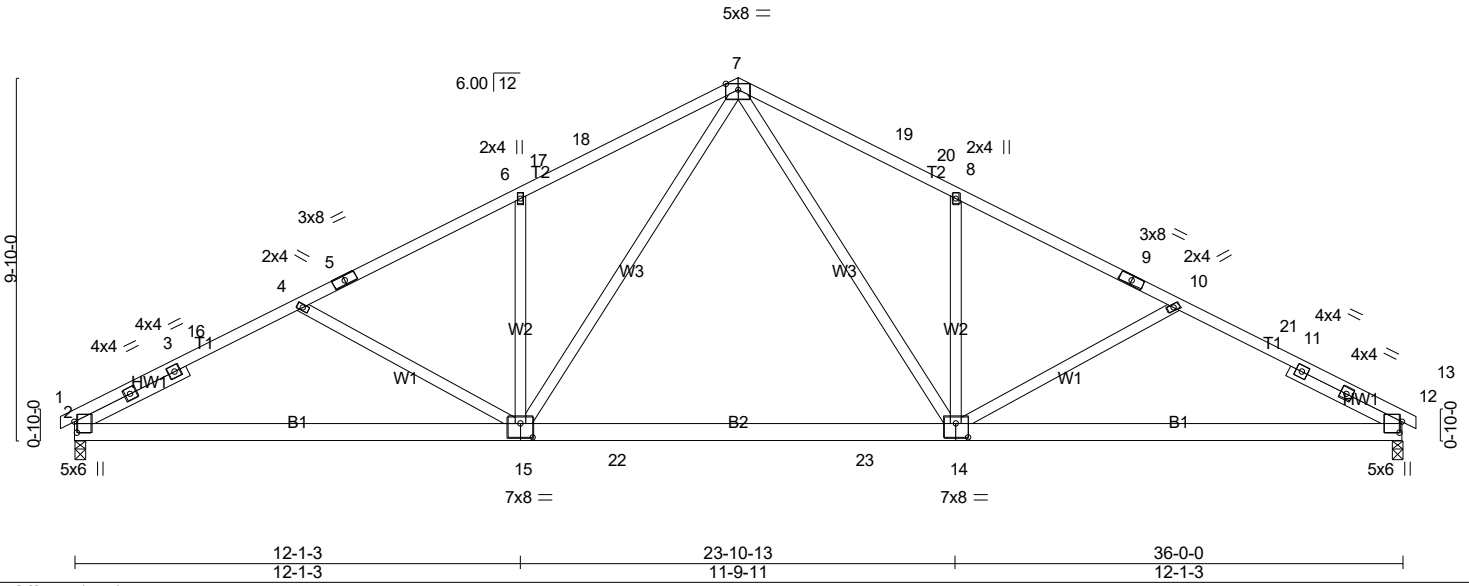

Plate Offsets (X,Y)-- [2:0-3-9,0-0-13], [12:0-3-9,0-0-13], [14:0-4-0,0-4-8], [15:0-4-0,0-4-8]						
LOADING (psf)	SPACING-	CSI.	DEFL.		PLATES	GRIP
TCLL (roof) 20.0	2-0-0	TC 0.78	in (loc) l/defl L/d		MT20	244/190
Snow (Pf) 20.0	Plate Grip DOL 1.15	BC 0.91	Vert(LL) -0.43 14-15 >999 240			
TCDL 10.0	Lumber DOL 1.15	WB 0.44	Vert(CT) -0.60 14-15 >722 180			
BCLL 0.0 *	Rep Stress Incr YES	Matrix-SH	Horz(CT) 0.07 12 n/a n/a			
BCDL 10.0	Code IRC2018/TPI2014					Weight: 226 lb FT = 20%

LUMBER-
 TOP CHORD 2x4 SP No.2
 BOT CHORD 2x6 SP No.2
 WEBS 2x4 SP No.3
 SLIDER Left 2x4 SP No.3 - 3-4-12, Right 2x4 SP No.3 - 3-4-12

BRACING-
 TOP CHORD Structural wood sheathing directly applied or 2-2-0 oc purlins.
 BOT CHORD Rigid ceiling directly applied or 10-0-0 oc bracing.
 MiTek recommends that Stabilizers and required cross bracing be installed during truss erection, in accordance with Stabilizer Installation guide.

REACTIONS. (lb/size) 2=1463/0-3-8 (min. 0-1-12), 12=1463/0-3-8 (min. 0-1-12)
 Max Horz 2=-112(LC 19)
 Max Uplift 2=-84(LC 14), 12=-84(LC 15)

FORCES. (lb) - Max. Comp./Max. Ten. - All forces 250 (lb) or less except when shown.
 TOP CHORD 2-3=-2466/178, 3-16=-2388/193, 4-16=-2374/204, 4-5=-2225/159, 5-6=-2168/180,
 6-17=-2241/242, 17-18=-2224/248, 7-18=-2168/266, 7-19=-2168/266, 19-20=-2224/248,
 8-20=-2241/242, 8-9=-2168/180, 9-10=-2225/159, 10-21=-2374/204, 11-21=-2388/193,
 11-12=-2466/178
 BOT CHORD 2-15=-199/2086, 15-22=-7/1414, 22-23=-7/1414, 14-23=-7/1414, 12-14=-123/2086
 WEBS 7-14=-139/1070, 8-14=-497/167, 10-14=-284/143, 7-15=-139/1070, 6-15=-497/167,
 4-15=-284/143

- NOTES-** (10-13)
- 1) Unbalanced roof live loads have been considered for this design.
 - 2) Wind: ASCE 7-16; Vult=115mph (3-second gust) Vasd=91mph; TCCL=5.0psf; BCDL=5.0psf; h=24ft; Cat. II; Exp B; Enclosed; MWFRS (envelope) gable end zone and C-C Exterior(2E) -0-4-8 to 3-7-2, Interior(1) 3-7-2 to 14-0-6, Exterior(2R) 14-0-6 to 21-11-10, Interior(1) 21-11-10 to 32-4-14, Exterior(2E) 32-4-14 to 36-4-8 zone; C-C for members and forces & MWFRS for reactions shown; Lumber DOL=1.60 plate grip DOL=1.60
 - 3) TCLL: ASCE 7-16; Pr=20.0 psf (roof LL: Lum DOL=1.15 Plate DOL=1.15); Pf=20.0 psf (Lum DOL=1.15 Plate DOL=1.15); Is=1.0; Rough Cat B; Partially Exp.; Ce=1.0; Cs=1.00; Ct=1.10
 - 4) Unbalanced snow loads have been considered for this design.
 - 5) This truss has been designed for greater of min roof live load of 12.0 psf or 2.00 times flat roof load of 20.0 psf on overhangs non-concurrent with other live loads.
 - 6) This truss has been designed for a 10.0 psf bottom chord live load nonconcurrent with any other live loads.
 - 7) * This truss has been designed for a live load of 30.0psf on the bottom chord in all areas where a rectangle 3-6-0 tall by 1-0-0 wide will fit between the bottom chord and any other members, with BCDL = 10.0psf.
 - 8) Provide mechanical connection (by others) of truss to bearing plate capable of withstanding 100 lb uplift at joint(s) 2, 12.
 - 9) This truss is designed in accordance with the 2018 International Residential Code sections R502.11.1 and R802.10.2 and referenced standard ANSI/TPI 1.

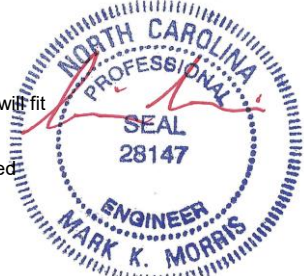

9/20/2021

Warning!—Verify design parameters and read notes before use. This design is based only upon parameters shown, and is for an individual building component to be installed and loaded vertically. Applicability of design parameters and proper incorporation of component is responsibility of building designer – not truss designer or truss engineer. Bracing shown is for lateral support of individual web members only. Additional temporary bracing to ensure stability during construction is the responsibility of the erector. Additional permanent bracing of the overall structure is the responsibility of the building designer. For general guidance regarding fabrication, quality control, storage, delivery, erection and bracing, consult ANSI/TPI 1 *National Design Standard for Metal Plate Connected Wood Truss Construction* and BCSI 1-03 *Guide to Good Practice for Handling, Installing & Bracing of Metal Plate Connected Wood Trusses* from Truss Plate Institute, 583 D'Onofrio Drive, Madison, WI 53719.

Job	Truss	Truss Type	Qty	Ply	49786-0227 WOODGROVE FUQUAY VARINA, NC
21-5631-R01	R03	Common	5	1	Job Reference (optional) # 28542

8.430 s Feb 12 2021 MiTek Industries, Inc. Tue Sep 21 15:54:02 2021 Page 2
 ID:9CcuJI7eSaUnzH5X3uf?lgz6QyZ-lrgYoWsBf3yiZ7?bWdVCYpCepNR6WAWpQe?ERybNMZ

- 10) Graphical bracing representation does not depict the size, type or the orientation of the brace on the member. Symbol only indicates that the member must be braced.
- 11) Bearing symbols are only graphical representations of a possible bearing condition. Bearing symbols are not considered in the structural design of the truss to support the loads indicated.
- 12) Web bracing shown is for lateral support of individual web members only. Refer to BCSI - Guide to Good Practice for Handling, Installing, Restraining & Bracing of Metal Plate Connected Wood Trusses for additional bracing guidelines, including diagonal bracing.
- 13) SEE BCSI-B3 SUMMARY SHEET- PERMANENT RESTRAING/BRACING OF CHORDS & WEB MEMBERS FOR RECOMMENDED MINIMUM BRACING REQUIREMENTS OF TOP CHORD, BOTTOM CHORD, AND WEB PLANES. IN ADDITION TO THESE MINIMUM GUIDELINES, ALWAYS CONSULT THE PROJECT ARCHITECT OR ENGINEER FOR ADDITIONAL BRACING CONSIDERATIONS.

LOAD CASE(S) Standard



9/20/2021

Warning !—Verify design parameters and read notes before use. This design is based only upon parameters shown, and is for an individual building component to be installed and loaded vertically. Applicability of design parameters and proper incorporation of component is responsibility of building designer – not truss designer or truss engineer. Bracing shown is for lateral support of individual web members only. Additional temporary bracing to ensure stability during construction is the responsibility of the erector. Additional permanent bracing of the overall structure is the responsibility of the building designer. For general guidance regarding fabrication, quality control, storage, delivery, erection and bracing, consult ANSI/TPI 1 *National Design Standard for Metal Plate Connected Wood Truss Construction* and BCSI 1-03 *Guide to Good Practice for Handling, Installing & Bracing of Metal Plate Connected Wood Trusses* from Truss Plate Institute, 583 D'Onofrio Drive, Madison, WI 53719.

Job 21-5631-R01	Truss R03B	Truss Type COMMON	Qty 4	Ply 1	49786-0227 WOODGROVE FUQUAY VARINA, NC	# 28542
--------------------	---------------	----------------------	----------	----------	--	---------

8.430 s Feb 12 2021 MiTek Industries, Inc. Tue Sep 21 15:54:03 2021 Page 1
 ID:9CcuJl7eSaUnzH5X3uf?lgz6QyZ-D1Ex0stpPN4ZBHa4VD8kklMVDmJrvpg24OYmybNYM

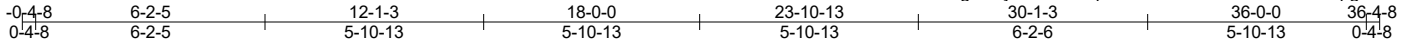

Scale = 1:62.4

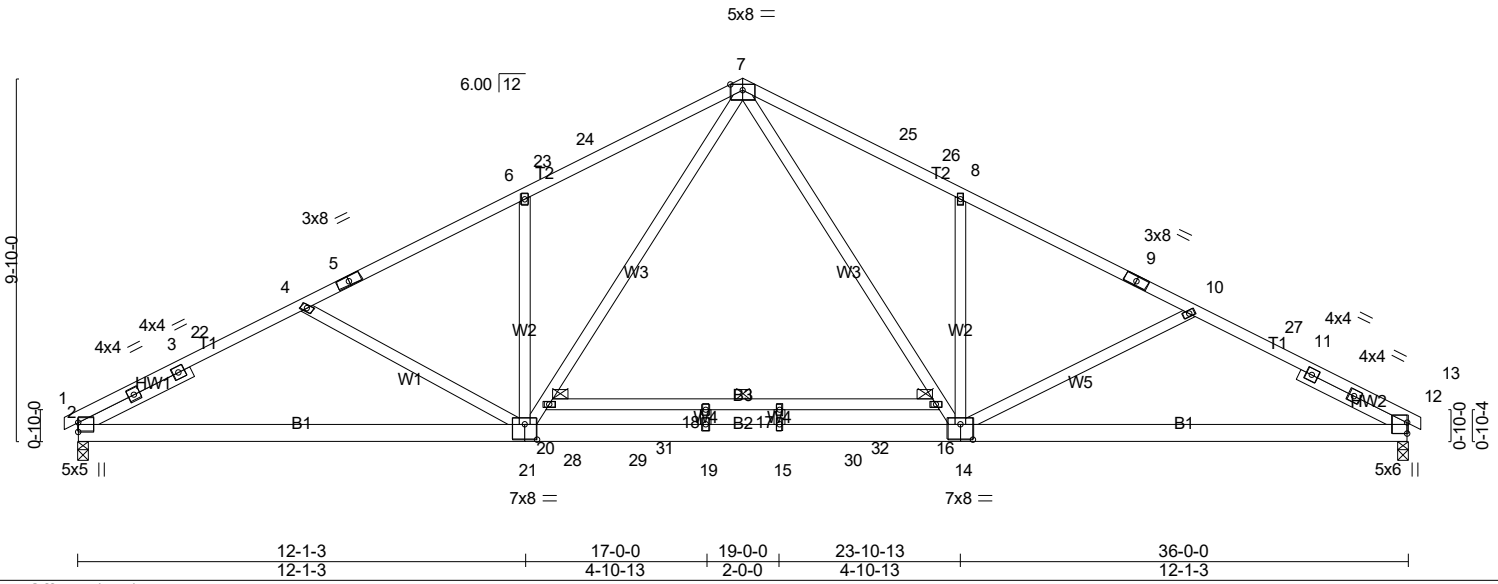

Plate Offsets (X,Y)-- [14:0-4-0,0-5-0], [21:0-4-0,0-5-0]					
LOADING (psf)	SPACING	CSI.	DEFL.	PLATES	GRIP
TCLL (roof) 20.0	2-0-0	TC 0.83	in (loc) l/defl L/d	MT20	244/190
Snow (Pf) 20.0	Plate Grip DOL 1.15	BC 0.74	Vert(LL) -0.55 15-19 >779 240		
TCDL 10.0	Lumber DOL 1.15	WB 0.61	Vert(CT) -0.83 15-19 >522 180		
BCLL 0.0 *	Rep Stress Incr YES	Matrix-SH	Horz(CT) 0.07 12 n/a n/a		
BCDL 10.0	Code IRC2018/TPI2014			Weight: 243 lb	FT = 20%

LUMBER-
 TOP CHORD 2x4 SP No.2 *Except*
 T1: 2x4 SP No.1
 BOT CHORD 2x6 SP No.1 *Except*
 B2: 2x6 SP DSS, B3: 2x4 SP No.2
 WEBS 2x4 SP No.3
 SLIDER Left 2x4 SP No.3 - 3-4-12, Right 2x4 SP No.3 - 3-2-12

BRACING-
 TOP CHORD Structural wood sheathing directly applied or 2-2-0 oc purlins.
 BOT CHORD Rigid ceiling directly applied or 9-5-9 oc bracing. Except: 6-0-0 oc bracing: 16-20
 MiTek recommends that Stabilizers and required cross bracing be installed during truss erection, in accordance with Stabilizer Installation guide.

REACTIONS. (lb/size) 2=1571/0-3-8 (min. 0-1-15), 12=1571/0-3-8 (min. 0-1-15)
 Max Horz 2=-112(LC 19)
 Max Uplift 2=-30(LC 14), 12=-30(LC 15)
 Max Grav 2=1650(LC 3), 12=1650(LC 3)

FORCES. (lb) - Max. Comp./Max. Ten. - All forces 250 (lb) or less except when shown.
 TOP CHORD 2-3=-2930/65, 3-22=-2851/79, 4-22=-2836/91, 4-5=-2700/35, 5-6=-2660/60,
 6-23=-2734/120, 23-24=-2716/127, 7-24=-2660/144, 7-25=-2660/145, 25-26=-2718/127,
 8-26=-2735/121, 8-9=-2660/59, 9-10=-2704/33, 10-27=-2838/94, 11-27=-2856/83,
 11-12=-2930/69
 BOT CHORD 2-21=-102/2485, 21-28=0/1746, 28-29=0/1746, 19-29=0/1746, 15-19=0/1746, 15-30=0/1746,
 14-30=0/1746, 12-14=-31/2487
 WEBS 4-21=-262/156, 6-21=-500/165, 20-21=-103/1237, 7-20=-75/1329, 7-16=-76/1331,
 14-16=-103/1238, 8-14=-510/170, 10-14=-268/162

- NOTES-** (11-14)
- Unbalanced roof live loads have been considered for this design.
 - Wind: ASCE 7-16; Vult=115mph (3-second gust) Vasd=91mph; TC DL=5.0psf; BCDL=5.0psf; h=24ft; Cat. II; Exp B; Enclosed; MWF RS (envelope) gable end zone and C-C Exterior(2E) -0-4-8 to 3-7-2, Interior(1) 3-7-2 to 14-0-6, Exterior(2R) 14-0-6 to 21-11-10, Interior(1) 21-11-10 to 32-4-14, Exterior(2E) 32-4-14 to 36-4-8 zone; C-C for members and forces & MWF RS for reactions shown; Lumber DOL=1.60 plate grip DOL=1.60
 - TCLL: ASCE 7-16; Pr=20.0 psf (roof LL: Lum DOL=1.15 Plate DOL=1.15); Pf=20.0 psf (Lum DOL=1.15 Plate DOL=1.15); Is=1.0; Rough Cat B; Partially Exp.; Ce=1.0; Cs=1.00; Ct=1.10
 - Unbalanced snow loads have been considered for this design.
 - This truss has been designed for greater of min roof live load of 12.0 psf or 2.00 times flat roof load of 20.0 psf on overhangs non-concurrent with other live loads.
 - All plates are 2x4 MT20 unless otherwise indicated.
 - This truss has been designed for a 10.0 psf bottom chord live load nonconcurrent with any other live loads.
 - * This truss has been designed for a live load of 30.0psf on the bottom chord in all areas where a rectangle 3-6-0 tall by 1-0-0 wide will fit between the bottom chord and any other members, with BCDL = 10.0psf.
 - Provide mechanical connection (by others) of truss to bearing plate capable of withstanding 100 lb uplift at joint(s) 2, 12.
 - This truss is designed in accordance with the 2018 International Residential Code sections R502.11.1 and R802.10.2 and referenced standard ANSI/TPI 1.

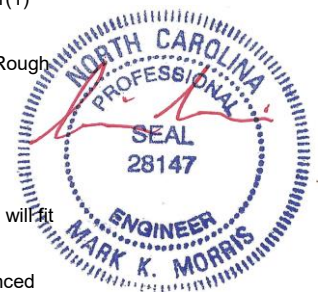

9/20/2021

Warning!—Verify design parameters and read notes before use. This design is based only upon parameters shown, and is for an individual building component to be installed and loaded vertically. Applicability of design parameters and proper incorporation of component is responsibility of building designer – not truss designer or truss engineer. Bracing shown is for lateral support of individual web members only. Additional temporary bracing to ensure stability during construction is the responsibility of the erector. Additional permanent bracing of the overall structure is the responsibility of the building designer. For general guidance regarding fabrication, quality control, storage, delivery, erection and bracing, consult ANSI/TPI 1 National Design Standard for Metal Plate Connected Wood Truss Construction and BCSI 1-03 Guide to Good Practice for Handling, Installing & Bracing of Metal Plate Connected Wood Trusses from Truss Plate Institute, 583 D'Onofrio Drive, Madison, WI 53719.

Job	Truss	Truss Type	Qty	Ply	49786-0227 WOODGROVE FUQUAY VARINA, NC
21-5631-R01	R03B	COMMON	4	1	Job Reference (optional) # 28542

8.430 s Feb 12 2021 MiTek Industries, Inc. Tue Sep 21 15:54:04 2021 Page 2
 ID:9CcuJI7eSaUnzH5X3uf?lgz6QyZ-hDnJDCiRAgCQoQ9G3wfzHzuXFd6YaM3pGk76IKybNMX

- 11) Graphical bracing representation does not depict the size, type or the orientation of the brace on the member. Symbol only indicates that the member must be braced.
- 12) Bearing symbols are only graphical representations of a possible bearing condition. Bearing symbols are not considered in the structural design of the truss to support the loads indicated.
- 13) Web bracing shown is for lateral support of individual web members only. Refer to BCSI - Guide to Good Practice for Handling, Installing, Restraining & Bracing of Metal Plate Connected Wood Trusses for additional bracing guidelines, including diagonal bracing.
- 14) SEE BCSI-B3 SUMMARY SHEET- PERMANENT RESTRAING/BRACING OF CHORDS & WEB MEMBERS FOR RECOMMENDED MINIMUM BRACING REQUIREMENTS OF TOP CHORD, BOTTOM CHORD, AND WEB PLANES. IN ADDITION TO THESE MINIMUM GUIDELINES, ALWAYS CONSULT THE PROJECT ARCHITECT OR ENGINEER FOR ADDITIONAL BRACING CONSIDERATIONS.

LOAD CASE(S) Standard



9/20/2021

Warning !—Verify design parameters and read notes before use. This design is based only upon parameters shown, and is for an individual building component to be installed and loaded vertically. Applicability of design parameters and proper incorporation of component is responsibility of building designer – not truss designer or truss engineer. Bracing shown is for lateral support of individual web members only. Additional temporary bracing to ensure stability during construction is the responsibility of the erector. Additional permanent bracing of the overall structure is the responsibility of the building designer. For general guidance regarding fabrication, quality control, storage, delivery, erection and bracing, consult ANSI/TPI 1 *National Design Standard for Metal Plate Connected Wood Truss Construction* and BCSI 1-03 *Guide to Good Practice for Handling, Installing & Bracing of Metal Plate Connected Wood Trusses* from Truss Plate Institute, 583 D'Onofrio Drive, Madison, WI 53719.

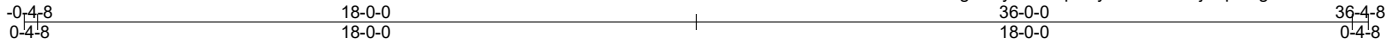

Scale = 1:63.0

LOADING (psf)	TCLL (roof) 20.0 Snow (Pf) 20.0 TCDL 10.0 BCLL 0.0 * BCDL 10.0	SPACING-	2-0-0 Plate Grip DOL 1.15 Lumber DOL 1.15 Rep Stress Incr YES Code IRC2018/TPI2014	CSI.	TC 0.10 BC 0.09 WB 0.14 Matrix-SH	DEFL.	in (loc) l/defl L/d Vert(LL) 0.00 30 n/r 180 Vert(CT) 0.00 30 n/r 80 Horz(CT) 0.01 32 n/a n/a	PLATES	GRIP
								MT20	244/190
								Weight: 309 lb	FT = 20%

LUMBER-
 TOP CHORD 2x4 SP No.2
 BOT CHORD 2x4 SP No.3
 WEBS 2x4 SP No.3
 OTHERS 2x4 SP No.3

BRACING-
 TOP CHORD Structural wood sheathing directly applied or 6-0-0 oc purlins, except end verticals.
 BOT CHORD Rigid ceiling directly applied or 10-0-0 oc bracing, Except: 6-0-0 oc bracing: 33-34,32-33.
 WEBS 1 Row at midpt 16-46, 15-47, 14-49, 17-45, 18-43

MiTek recommends that Stabilizers and required cross bracing be installed during truss erection, in accordance with Stabilizer Installation guide.

REACTIONS. All bearings 36-0-0.
 (lb) - Max Horz 60=112(LC 18)
 Max Uplift All uplift 100 lb or less at joint(s) 60, 32, 47, 49, 50, 51, 52, 53, 54, 55, 56, 57, 58, 59, 45, 43, 42, 41, 40, 39, 38, 37, 36, 35 except 34=106(LC 15)
 Max Grav All reactions 250 lb or less at joint(s) 60, 32, 46, 47, 49, 50, 51, 52, 53, 54, 55, 56, 57, 58, 59, 45, 43, 42, 41, 40, 39, 38, 37, 36, 35, 34, 33

FORCES. (lb) - Max. Comp./Max. Ten. - All forces 250 (lb) or less except when shown.

- NOTES-** (15-18)
- 1) Unbalanced roof live loads have been considered for this design.
 - 2) Wind: ASCE 7-16; Vult=115mph (3-second gust) Vasd=91mph; TCDL=5.0psf; BCDL=5.0psf; h=24ft; Cat. II; Exp B; Enclosed; MWFRS (envelope) gable end zone and C-C Corner(3E) -0-4-8 to 3-4-0, Exterior(2N) 3-4-0 to 14-0-0, Corner(3R) 14-0-0 to 22-0-0, Exterior(2N) 22-0-0 to 32-4-14, Corner(3E) 32-4-14 to 36-4-8 zone;C-C for members and forces & MWFRS for reactions shown; Lumber DOL=1.60 plate grip DOL=1.60
 - 3) Truss designed for wind loads in the plane of the truss only. For studs exposed to wind (normal to the face), see Standard Industry Gable End Details as applicable, or consult qualified building designer as per ANSI/TPI 1.
 - 4) TCLL: ASCE 7-16; Pr=20.0 psf (roof LL: Lum DOL=1.15 Plate DOL=1.15); Pf=20.0 psf (Lum DOL=1.15 Plate DOL=1.15); Is=1.0; Rough Cat B; Partially Exp.; Ce=1.0; Cs=1.00; Ct=1.10
 - 5) Unbalanced snow loads have been considered for this design.
 - 6) This truss has been designed for greater of min roof live load of 12.0 psf or 2.00 times flat roof load of 20.0 psf on overhangs non-concurrent with other live loads.
 - 7) All plates are 2x4 MT20 unless otherwise indicated.
 - 8) Gable requires continuous bottom chord bearing.
 - 9) Truss to be fully sheathed from one face or securely braced against lateral movement (i.e. diagonal web).
 - 10) Gable studs spaced at 1-4-0 oc.
 - 11) This truss has been designed for a 10.0 psf bottom chord live load nonconcurrent with any other live loads.
 - 12) * This truss has been designed for a live load of 30.0psf on the bottom chord in all areas where a rectangle 3-6-0 tall by 1-0-0 wide will fit between the bottom chord and any other members, with BCDL = 10.0psf.
 - 13) Provide mechanical connection (by others) of truss to bearing plate capable of withstanding 100 lb uplift at joint(s) 60, 32, 47, 49, 50, 51, 52, 53, 54, 55, 56, 57, 58, 59, 45, 43, 42, 41, 40, 39, 38, 37, 36, 35 except (jt=lb) 34=106.
 - 14) This truss is designed in accordance with the 2018 International Residential Code sections R502.11.1 and R802.10.2 and referenced standard ANSI/TPI 1.



9/20/2021

Warning!—Verify design parameters and read notes before use. This design is based only upon parameters shown, and is for an individual building component to be installed and loaded vertically. Applicability of design parameters and proper incorporation of component is responsibility of building designer – not truss designer or truss engineer. Bracing shown is for lateral support of individual web members only. Additional temporary bracing to ensure stability during construction is the responsibility of the erector. Additional permanent bracing of the overall structure is the responsibility of the building designer. For general guidance regarding fabrication, quality control, storage, delivery, erection and bracing, consult ANSI/TPI 1 *National Design Standard for Metal Plate Connected Wood Truss Construction* and BCSI 1-03 *Guide to Good Practice for Handling, Installing & Bracing of Metal Plate Connected Wood Trusses* from Truss Plate Institute, 583 D'Onofrio Drive, Madison, WI 53719.

Job	Truss	Truss Type	Qty	Ply	49786-0227 WOODGROVE FUQUAY VARINA, NC
21-5631-R01	R04	GABLE	1	1	Job Reference (optional) # 28542

8.430 s Feb 12 2021 MiTek Industries, Inc. Tue Sep 21 15:54:09 2021 Page 2
 ID:9CcuJl7eSaUnzH5X3uf?lgz6QyZ-2BbCGvxa?DqivC2EsUF8_0bZQeztFkhYQ?rtzXybNMS

- 15) Graphical bracing representation does not depict the size, type or the orientation of the brace on the member. Symbol only indicates that the member must be braced.
- 16) Bearing symbols are only graphical representations of a possible bearing condition. Bearing symbols are not considered in the structural design of the truss to support the loads indicated.
- 17) Web bracing shown is for lateral support of individual web members only. Refer to BCSI - Guide to Good Practice for Handling, Installing, Restraining & Bracing of Metal Plate Connected Wood Trusses for additional bracing guidelines, including diagonal bracing.
- 18) SEE BCSI-B3 SUMMARY SHEET- PERMANENT RESTRAING/BRACING OF CHORDS & WEB MEMBERS FOR RECOMMENDED MINIMUM BRACING REQUIREMENTS OF TOP CHORD, BOTTOM CHORD, AND WEB PLANES. IN ADDITION TO THESE MINIMUM GUIDELINES, ALWAYS CONSULT THE PROJECT ARCHITECT OR ENGINEER FOR ADDITIONAL BRACING CONSIDERATIONS.

LOAD CASE(S) Standard



9/20/2021

Warning !—Verify design parameters and read notes before use. This design is based only upon parameters shown, and is for an individual building component to be installed and loaded vertically. Applicability of design parameters and proper incorporation of component is responsibility of building designer – not truss designer or truss engineer. Bracing shown is for lateral support of individual web members only. Additional temporary bracing to ensure stability during construction is the responsibility of the erector. Additional permanent bracing of the overall structure is the responsibility of the building designer. For general guidance regarding fabrication, quality control, storage, delivery, erection and bracing, consult ANSI/TPI 1 *National Design Standard for Metal Plate Connected Wood Truss Construction* and BCSI 1-03 *Guide to Good Practice for Handling, Installing & Bracing of Metal Plate Connected Wood Trusses* from Truss Plate Institute, 583 D'Onofrio Drive, Madison, WI 53719.

Job 21-5631-R01	Truss R05	Truss Type GABLE	Qty 1	Ply 2	49786-0227 WOODGROVE FUQUAY VARINA, NC	# 28542
--------------------	--------------	---------------------	----------	----------	--	---------

8.430 s Feb 12 2021 MiTek Industries, Inc. Tue Sep 21 15:54:14 2021 Page 1
 ID:9CcuJl7eSaUnzhH5X3uf?lgz6QyZ-O8O5Jd?lqIT??zwBe1qJh4JGQfUxwqjlaHYeflybNMN

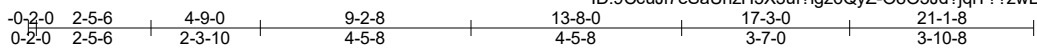

Scale = 1:48.7

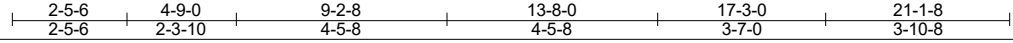
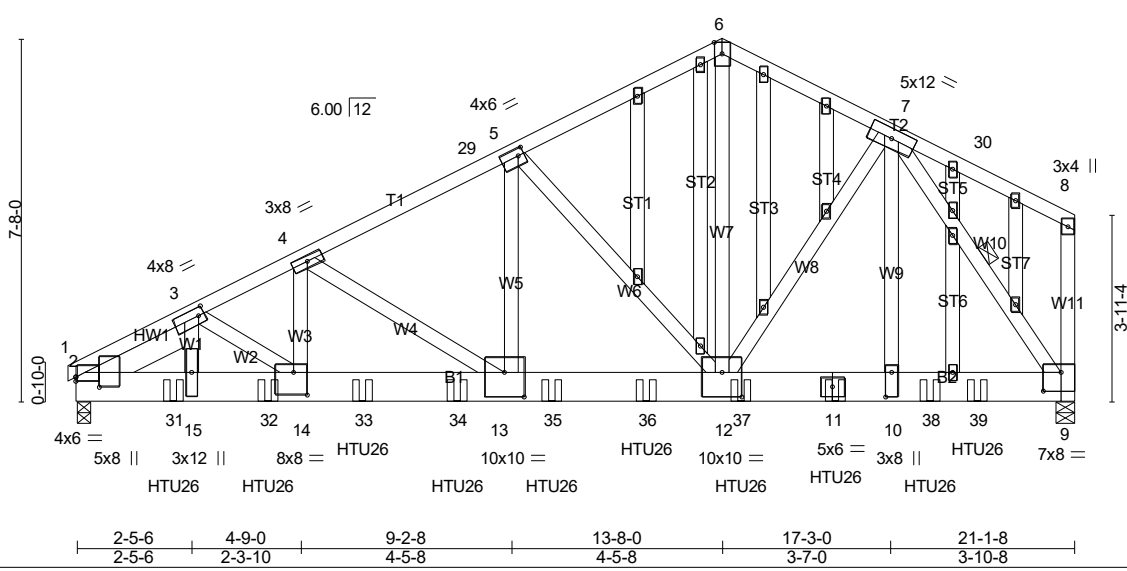

Plate Offsets (X,Y)-- [2:0-0-0,0-1-1], [2:0-2-9,0-6-0], [3:0-1-8,0-2-0], [5:0-1-8,0-1-12], [9:0-4-8,0-4-12], [10:0-6-4,0-1-8], [12:0-5-0,0-6-4], [13:0-5-0,0-6-4], [14:0-3-8,0-5-12]

LOADING (psf)	SPACING-	CSI.	DEFL.	PLATES	GRIP
TCLL (roof) 20.0	2-0-0	TC 0.72	in (loc) l/defl L/d	MT20	244/190
Snow (Pf) 20.0	Plate Grip DOL 1.15	BC 0.86	Vert(LL) -0.11 13-14 >999 240		
TCDL 10.0	Lumber DOL 1.15	WB 0.85	Vert(CT) -0.22 13-14 >999 180		
BCLL 0.0 *	Rep Stress Incr NO	Matrix-SH	Horz(CT) 0.05 9 n/a n/a		
BCDL 10.0	Code IRC2018/TPI2014			Weight: 430 lb	FT = 20%

LUMBER-	BRACING-
TOP CHORD 2x4 SP No.1 *Except* T2: 2x4 SP No.2	TOP CHORD Structural wood sheathing directly applied or 3-0-12 oc purlins, except end verticals.
BOT CHORD 2x8 SP DSS *Except* B2: 2x8 SP No.1	BOT CHORD Rigid ceiling directly applied or 10-0-0 oc bracing.
WEBS 2x4 SP No.3 *Except* W5,W7,W11,W10: 2x4 SP No.2	WEBS 1 Row at midpt 7-9
OTHERS 2x4 SP No.3	
SLIDER Left 2x6 SP No.2 - 2-4-5	

REACTIONS. (lb/size) 2=7642/0-3-14 (min. 0-3-14), 9=8234/0-5-0 (min. 0-2-6)
 Max Horz 2=145(LC 12)
 Max Uplift 2=-463(LC 12), 9=-436(LC 12)
 Max Grav 2=7688(LC 19), 9=8243(LC 20)

FORCES. (lb) - Max. Comp./Max. Ten. - All forces 250 (lb) or less except when shown.
 TOP CHORD 2-3=-12109/732, 3-4=-12130/749, 4-29=-10053/617, 5-29=-9954/627, 5-6=-6532/427, 6-7=-6438/440
 BOT CHORD 2-31=-718/9933, 15-31=-718/9933, 15-32=-718/9933, 14-32=-718/9933, 14-33=-754/10849, 33-34=-754/10849, 13-34=-754/10849, 13-35=-575/8702, 35-36=-575/8702, 12-36=-575/8702, 12-37=-278/4929, 11-37=-278/4929, 10-11=-278/4929, 10-38=-278/4929, 38-39=-278/4929, 9-39=-278/4929
 WEBS 4-14=-98/1974, 4-13=-2292/197, 5-13=-258/4523, 5-12=-4409/348, 6-12=-332/5454, 7-12=-118/1558, 7-10=-101/2856, 7-9=-8530/482, 3-14=-53/1114, 3-15=-40/763

- NOTES-** (17-20)
- 2-ply truss to be connected together with 10d (0.131"x3") nails as follows:
 Top chords connected as follows: 2x4 - 1 row at 0-7-0 oc.
 Bottom chords connected as follows: 2x8 - 2 rows staggered at 0-4-0 oc.
 Webs connected as follows: 2x4 - 1 row at 0-9-0 oc, Except member 3-15 2x4 - 1 row at 0-2-0 oc.
 - All loads are considered equally applied to all plies, except if noted as front (F) or back (B) face in the LOAD CASE(S) section. Ply to ply connections have been provided to distribute only loads noted as (F) or (B), unless otherwise indicated.
 - Unbalanced roof live loads have been considered for this design.
 - Wind: ASCE 7-16; Vult=115mph (3-second gust) Vasd=91mph; TCCL=5.0psf; BCCL=5.0psf; h=23ft; Cat. II; Exp B; Enclosed; MWFRS (envelope) gable end zone; Lumber DOL=1.60 plate grip DOL=1.60
 - Truss designed for wind loads in the plane of the truss only. For studs exposed to wind (normal to the face), see Standard Industry Gable End Details as applicable, or consult qualified building designer as per ANSI/TPI 1.
 - TCCL: ASCE 7-16; Pr=20.0 psf (roof LL: Lum DOL=1.15 Plate DOL=1.15); Pf=20.0 psf (Lum DOL=1.15 Plate DOL=1.15); Is=1.0; Rough Cat B; Partially Exp.; Ce=1.00; Cs=1.00; Ct=1.10
 - Unbalanced snow loads have been considered for this design.
 - All plates are 2x4 MT20 unless otherwise indicated.
 - Gable studs spaced at 1-4-0 oc.



9/20/2021

10 This truss was designed for and fabricated to resist the loads shown only with any other loads for an individual building component to be installed and loaded vertically. Applicability of design parameters and proper incorporation of component is responsibility of building designer - not truss designer or truss engineer. Bracing shown is for lateral support of individual web members only. Additional temporary bracing to ensure stability during construction is the responsibility of the erector. Additional permanent bracing of the overall structure is the responsibility of the building designer. For general guidance regarding fabrication, quality control, storage, delivery, erection and bracing, consult ANSI/TPI 1 National Design Standard for Metal Plate Connected Wood Truss Construction and BCSI 1-03 Guide to Good Practice for Handling, Installing & Bracing of Metal Plate Connected Wood Trusses from Truss Plate Institute, 583 D'Onofrio Drive, Madison, WI 53719.

Job	Truss	Truss Type	Qty	Ply	49786-0227 WOODGROVE FUQUAY VARINA, NC
21-5631-R01	R05	GABLE	1	2	Job Reference (optional) # 28542

8.430 s Feb 12 2021 MiTek Industries, Inc. Tue Sep 21 15:54:15 2021 Page 2
ID:9CcuJl7eSaUnzH5X3uf?lgz6QyZ-sLyTXz0Lb3bsd7VNCKLYDhrRA3qAfHzRoxlBBBybNMM

NOTES- (17-20)

- 11) * This truss has been designed for a live load of 30.0psf on the bottom chord in all areas where a rectangle 3-6-0 tall by 1-0-0 wide will fit between the bottom chord and any other members.
- 12) Bearing at joint(s) 9 considers parallel to grain value using ANSI/TPI 1 angle to grain formula. Building designer should verify capacity of bearing surface.
- 13) Provide mechanical connection (by others) of truss to bearing plate capable of withstanding 100 lb uplift at joint(s) except (jt=lb) 2=463, 9=436.
- 14) This truss is designed in accordance with the 2018 International Residential Code sections R502.11.1 and R802.10.2 and referenced standard ANSI/TPI 1.
- 15) Use Simpson Strong-Tie HTU26 (20-10d Girder, 11-10dx1 1/2 Truss, Single Ply Girder) or equivalent spaced at 2-0-0 oc max. starting at 2-0-12 from the left end to 19-0-12 to connect truss(es) R02 (1 ply 2x6 SP), R02B (1 ply 2x6 SP) to back face of bottom chord.
- 16) Fill all nail holes where hanger is in contact with lumber.
- 17) Graphical bracing representation does not depict the size, type or the orientation of the brace on the member. Symbol only indicates that the member must be braced.
- 18) Bearing symbols are only graphical representations of a possible bearing condition. Bearing symbols are not considered in the structural design of the truss to support the loads indicated.
- 19) Web bracing shown is for lateral support of individual web members only. Refer to BCSI - Guide to Good Practice for Handling, Installing, Restraining & Bracing of Metal Plate Connected Wood Trusses for additional bracing guidelines, including diagonal bracing.
- 20) SEE BCSI-B3 SUMMARY SHEET- PERMANENT RESTRAINING/BRACING OF CHORDS & WEB MEMBERS FOR RECOMMENDED MINIMUM BRACING REQUIREMENTS OF TOP CHORD, BOTTOM CHORD, AND WEB PLANES. IN ADDITION TO THESE MINIMUM GUIDELINES, ALWAYS CONSULT THE PROJECT ARCHITECT OR ENGINEER FOR ADDITIONAL BRACING CONSIDERATIONS.

LOAD CASE(S) Standard

- 1) Dead + Snow (balanced): Lumber Increase=1.15, Plate Increase=1.15
 - Uniform Loads (plf)
 - Vert: 1-6=-60, 6-8=-60, 2-9=-20
 - Concentrated Loads (lb)
 - Vert: 11=-1408(B) 31=-1408(B) 32=-1408(B) 33=-1408(B) 34=-1408(B) 35=-1408(B) 36=-1408(B) 37=-1408(B) 38=-1408(B) 39=-1517(B)



9/20/2021

Warning !—Verify design parameters and read notes before use. This design is based only upon parameters shown, and is for an individual building component to be installed and loaded vertically. Applicability of design parameters and proper incorporation of component is responsibility of building designer – not truss designer or truss engineer. Bracing shown is for lateral support of individual web members only. Additional temporary bracing to ensure stability during construction is the responsibility of the erector. Additional permanent bracing of the overall structure is the responsibility of the building designer. For general guidance regarding fabrication, quality control, storage, delivery, erection and bracing, consult ANSI/TPI 1 *National Design Standard for Metal Plate Connected Wood Truss Construction* and BCSI 1-03 *Guide to Good Practice for Handling, Installing & Bracing of Metal Plate Connected Wood Trusses* from Truss Plate Institute, 583 D'Onofrio Drive, Madison, WI 53719.

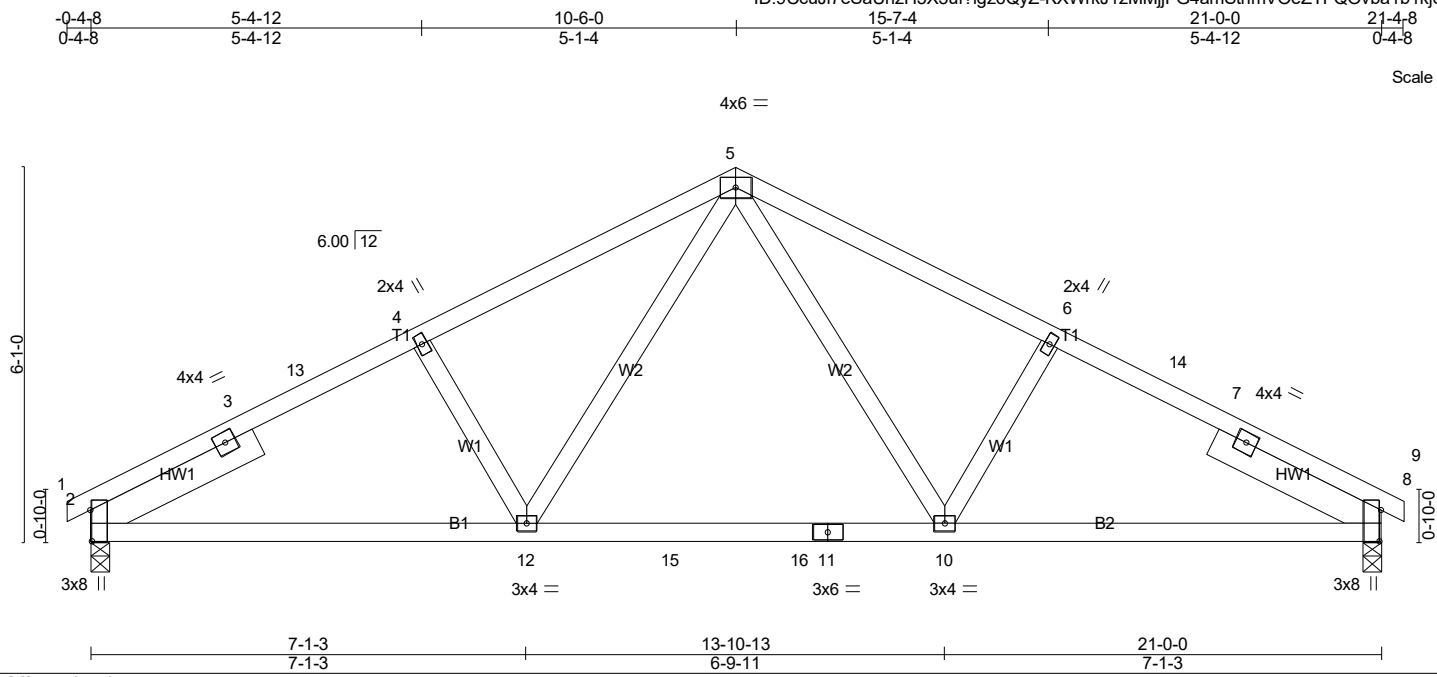

Scale = 1:37.5

LOADING (psf)		SPACING-		CSI.		DEFL.		PLATES		GRIP	
TCLL (roof)	20.0	2-0-0	Plate Grip DOL	1.15	TC	0.62	in (loc)	l/defl	L/d	MT20	244/190
Snow (Pf)	20.0	Lumber DOL	1.15	BC	0.54	Vert(LL)	-0.12 10-12	>999	240		
TCDL	10.0	Rep Stress Incr	YES	WB	0.19	Vert(CT)	-0.18 10-12	>999	180		
BCLL	0.0 *	Code IRC2018/TPI2014		Matrix-SH		Horz(CT)	0.03 8	n/a	n/a		
BCDL	10.0										Weight: 111 lb FT = 20%

<p>LUMBER-</p> <p>TOP CHORD 2x4 SP No.2</p> <p>BOT CHORD 2x4 SP No.2</p> <p>WEBS 2x4 SP No.3</p> <p>SLIDER Left 2x6 SP No.2 - 3-0-8, Right 2x6 SP No.2 - 3-0-8</p>	<p>BRACING-</p> <p>TOP CHORD Structural wood sheathing directly applied or 3-10-7 oc purlins.</p> <p>BOT CHORD Rigid ceiling directly applied or 10-0-0 oc bracing.</p> <div style="border: 1px solid black; padding: 5px; margin-top: 10px;"> <p>MiTek recommends that Stabilizers and required cross bracing be installed during truss erection, in accordance with Stabilizer Installation guide.</p> </div>
---	--

REACTIONS. (lb/size) 2=863/0-3-8 (min. 0-1-8), 8=863/0-3-8 (min. 0-1-8)

Max Horz 2=-65(LC 15)

Max Uplift 2=-44(LC 14), 8=-44(LC 15)

Max Grav 2=897(LC 21), 8=897(LC 22)

FORCES. (lb) - Max. Comp./Max. Ten. - All forces 250 (lb) or less except when shown.

TOP CHORD 2-3=-1390/225, 3-13=-1307/230, 4-13=-1248/241, 4-5=-1219/258, 5-6=-1219/258, 6-14=-1248/241, 7-14=-1307/230, 7-8=-1390/225

BOT CHORD 2-12=-139/1140, 12-15=-29/771, 15-16=-29/771, 11-16=-29/771, 10-11=-29/771, 8-10=-139/1140

WEBS 5-10=-73/461, 6-10=-305/149, 5-12=-73/461, 4-12=-305/149

- NOTES-** (10-13)
- 1) Unbalanced roof live loads have been considered for this design.
 - 2) Wind: ASCE 7-16; Vult=115mph (3-second gust) Vasd=91mph; TCCL=5.0psf; BCDL=5.0psf; h=22ft; Cat. II; Exp B; Enclosed; MWFRS (envelope) gable end zone and C-C Corner(3E) 0-4-8 to 3-7-2, Exterior(2N) 3-7-2 to 6-6-6, Corner(3R) 6-6-6 to 14-5-10, Exterior(2N) 14-5-10 to 17-4-14, Corner(3E) 17-4-14 to 21-4-8 zone; C-C for members and forces & MWFRS for reactions shown; Lumber DOL=1.60 plate grip DOL=1.60
 - 3) TCCL: ASCE 7-16; Pr=20.0 psf (roof LL: Lum DOL=1.15 Plate DOL=1.15); Pf=20.0 psf (Lum DOL=1.15 Plate DOL=1.15); Is=1.0; Rough Cat B; Partially Exp.; Ce=1.0; Cs=1.00; Ct=1.10
 - 4) Unbalanced snow loads have been considered for this design.
 - 5) This truss has been designed for greater of min roof live load of 12.0 psf or 2.00 times flat roof load of 20.0 psf on overhangs non-concurrent with other live loads.
 - 6) This truss has been designed for a 10.0 psf bottom chord live load nonconcurrent with any other live loads.
 - 7) * This truss has been designed for a live load of 30.0psf on the bottom chord in all areas where a rectangle 3-6-0 tall by 1-0-0 wide will fit between the bottom chord and any other members, with BCDL = 10.0psf.
 - 8) Provide mechanical connection (by others) of truss to bearing plate capable of withstanding 100 lb uplift at joint(s) 2, 8.
 - 9) This truss is designed in accordance with the 2018 International Residential Code sections R502.11.1 and R802.10.2 and referenced standard ANSI/TPI 1.



9/20/2021

Warning!—Verify design parameters and read notes before use. This design is based only upon parameters shown, and is for an individual building component to be installed and loaded vertically. Applicability of design parameters and proper incorporation of component is responsibility of building designer – not truss designer or truss engineer. Bracing shown is for lateral support of individual web members only. Additional temporary bracing to ensure stability during construction is the responsibility of the erector. Additional permanent bracing of the overall structure is the responsibility of the building designer. For general guidance regarding fabrication, quality control, storage, delivery, erection and bracing, consult ANSI/TPI 1 *National Design Standard for Metal Plate Connected Wood Truss Construction* and BCSI 1-03 *Guide to Good Practice for Handling, Installing & Bracing of Metal Plate Connected Wood Trusses* from Truss Plate Institute, 583 D'Onofrio Drive, Madison, WI 53719.

Job	Truss	Truss Type	Qty	Ply	49786-0227 WOODGROVE FUQUAY VARINA, NC
21-5631-R01	R06	Common	1	1	Job Reference (optional) # 28542

8.430 s Feb 12 2021 MiTek Industries, Inc. Tue Sep 21 15:54:16 2021 Page 2
 ID:9CcuJl7eSaUnzH5X3uf?lgz6QyZ-KXWrkJ1zMMjJFG4amStnmVOeZTFQOvba1b1kjdybNML

- 10) Graphical bracing representation does not depict the size, type or the orientation of the brace on the member. Symbol only indicates that the member must be braced.
- 11) Bearing symbols are only graphical representations of a possible bearing condition. Bearing symbols are not considered in the structural design of the truss to support the loads indicated.
- 12) Web bracing shown is for lateral support of individual web members only. Refer to BCSI - Guide to Good Practice for Handling, Installing, Restraining & Bracing of Metal Plate Connected Wood Trusses for additional bracing guidelines, including diagonal bracing.
- 13) SEE BCSI-B3 SUMMARY SHEET- PERMANENT RESTRAING/BRACING OF CHORDS & WEB MEMBERS FOR RECOMMENDED MINIMUM BRACING REQUIREMENTS OF TOP CHORD, BOTTOM CHORD, AND WEB PLANES. IN ADDITION TO THESE MINIMUM GUIDELINES, ALWAYS CONSULT THE PROJECT ARCHITECT OR ENGINEER FOR ADDITIONAL BRACING CONSIDERATIONS.

LOAD CASE(S) Standard



9/20/2021

Warning !—Verify design parameters and read notes before use. This design is based only upon parameters shown, and is for an individual building component to be installed and loaded vertically. Applicability of design parameters and proper incorporation of component is responsibility of building designer – not truss designer or truss engineer. Bracing shown is for lateral support of individual web members only. Additional temporary bracing to ensure stability during construction is the responsibility of the erector. Additional permanent bracing of the overall structure is the responsibility of the building designer. For general guidance regarding fabrication, quality control, storage, delivery, erection and bracing, consult ANSI/TPI 1 *National Design Standard for Metal Plate Connected Wood Truss Construction* and BCSI 1-03 *Guide to Good Practice for Handling, Installing & Bracing of Metal Plate Connected Wood Trusses* from Truss Plate Institute, 583 D'Onofrio Drive, Madison, WI 53719.

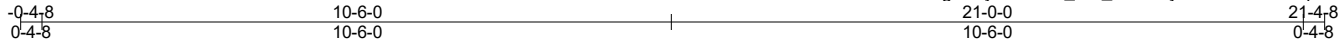

Scale = 1:38.4

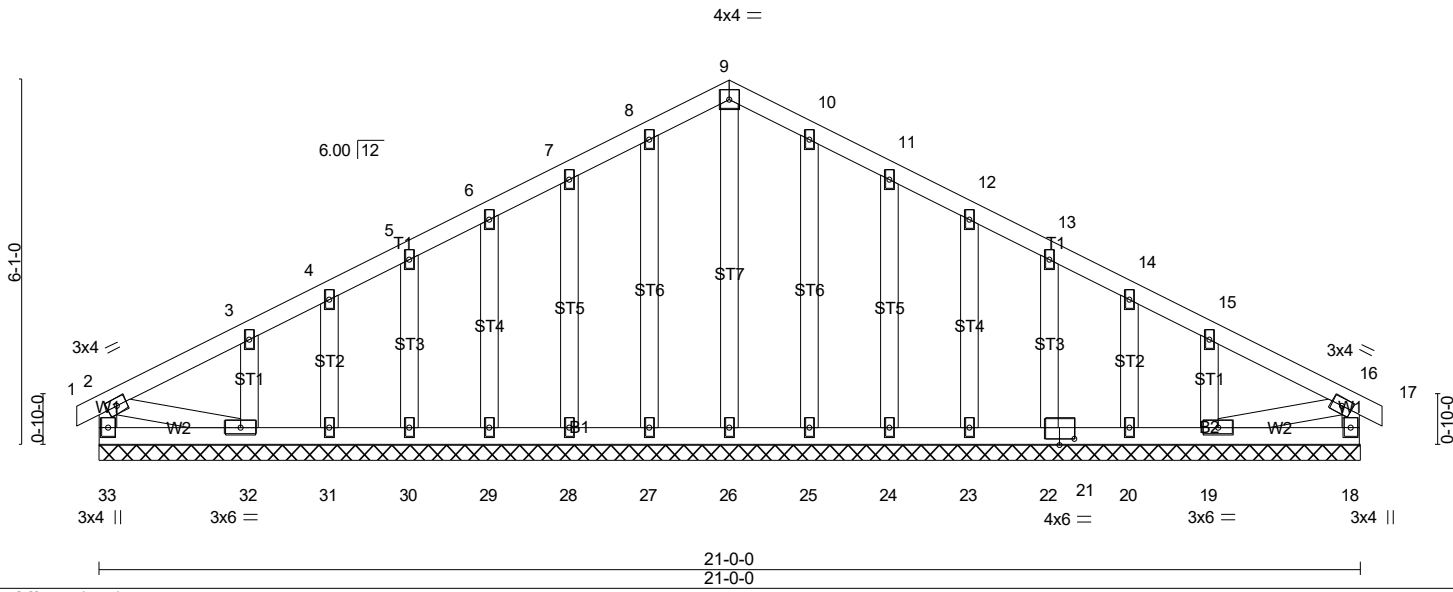

Plate Offsets (X,Y)-- [21:0-3-0,0-1-4]

LOADING (psf)	SPACING-	2-0-0	CSI.	DEFL.	in (loc)	l/defl	L/d	PLATES	GRIP
TCLL (roof) 20.0	Plate Grip DOL 1.15		TC 0.06	Vert(LL) 0.00	16	n/r	180	MT20	244/190
Snow (Pf) 20.0	Lumber DOL 1.15		BC 0.07	Vert(CT) 0.00	16	n/r	80		
TCDL 10.0	Rep Stress Incr YES		WB 0.07	Horz(CT) 0.00	19	n/a	n/a		
BCLL 0.0 *	Code IRC2018/TPI2014		Matrix-SH						
BCDL 10.0									
								Weight: 140 lb	FT = 20%

LUMBER-
 TOP CHORD 2x4 SP No.2
 BOT CHORD 2x4 SP No.3
 WEBS 2x4 SP No.3
 OTHERS 2x4 SP No.3

BRACING-
 TOP CHORD Structural wood sheathing directly applied or 6-0-0 oc purlins, except end verticals.
 BOT CHORD Rigid ceiling directly applied or 10-0-0 oc bracing.
 MiTek recommends that Stabilizers and required cross bracing be installed during truss erection, in accordance with Stabilizer Installation guide.

REACTIONS. All bearings 21-0-0.
 (lb) - Max Horz 33=-65(LC 15)
 Max Uplift All uplift 100 lb or less at joint(s) 33, 27, 28, 29, 30, 31, 32, 25, 24, 23, 22, 20, 19
 Max Grav All reactions 250 lb or less at joint(s) 33, 18, 26, 27, 28, 29, 30, 31, 32, 25, 24, 23, 22, 20, 19

FORCES. (lb) - Max. Comp./Max. Ten. - All forces 250 (lb) or less except when shown.

- NOTES-** (15-18)
- 1) Unbalanced roof live loads have been considered for this design.
 - 2) Wind: ASCE 7-16; Vult=115mph (3-second gust) Vasd=91mph; TC DL=5.0psf; BCDL=5.0psf; h=22ft; Cat. II; Exp B; Enclosed; MWFRS (envelope) gable end zone and C-C Corner(3E) 0-4-8 to 3-10-0, Exterior(2N) 3-10-0 to 6-6-0, Corner(3R) 6-6-0 to 14-6-0, Exterior(2N) 14-6-0 to 17-2-0, Corner(3E) 17-2-0 to 21-4-8 zone; C-C for members and forces & MWFRS for reactions shown; Lumber DOL=1.60 plate grip DOL=1.60
 - 3) Truss designed for wind loads in the plane of the truss only. For studs exposed to wind (normal to the face), see Standard Industry Gable End Details as applicable, or consult qualified building designer as per ANSI/TPI 1.
 - 4) TCLL: ASCE 7-16; Pr=20.0 psf (roof LL: Lum DOL=1.15 Plate DOL=1.15); Pf=20.0 psf (Lum DOL=1.15 Plate DOL=1.15); Is=1.0; Rough Cat B; Partially Exp.; Ce=1.0; Cs=1.00; Ct=1.10
 - 5) Unbalanced snow loads have been considered for this design.
 - 6) This truss has been designed for greater of min roof live load of 12.0 psf or 2.00 times flat roof load of 20.0 psf on overhangs non-concurrent with other live loads.
 - 7) All plates are 2x4 MT20 unless otherwise indicated.
 - 8) Gable requires continuous bottom chord bearing.
 - 9) Truss to be fully sheathed from one face or securely braced against lateral movement (i.e. diagonal web).
 - 10) Gable studs spaced at 1-4-0 oc.
 - 11) This truss has been designed for a 10.0 psf bottom chord live load nonconcurrent with any other live loads.
 - 12) * This truss has been designed for a live load of 30.0psf on the bottom chord in all areas where a rectangle 3-6-0 tall by 1-0-0 wide will fit between the bottom chord and any other members, with BCDL = 10.0psf.
 - 13) Provide mechanical connection (by others) of truss to bearing plate capable of withstanding 100 lb uplift at joint(s) 33, 27, 28, 29, 30, 31, 32, 25, 24, 23, 22, 20, 19.
 - 14) This truss is designed in accordance with the 2018 International Residential Code sections R502.11.1 and R802.10.2 and referenced standard ANSI/TPI 1.

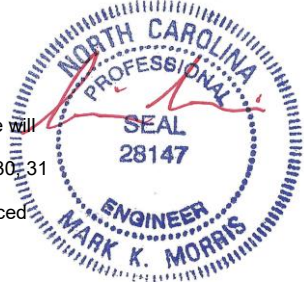

9/20/2021

Warning!—Verify design parameters and read notes before use. This design is based only upon parameters shown, and is for an individual building component to be installed and loaded vertically. Applicability of design parameters and proper incorporation of component is responsibility of building designer – not truss designer or truss engineer. Bracing shown is for lateral support of individual web members only. Additional temporary bracing to ensure stability during construction is the responsibility of the erector. Additional permanent bracing of the overall structure is the responsibility of the building designer. For general guidance regarding fabrication, quality control, storage, delivery, erection and bracing, consult ANSI/TPI 1 *National Design Standard for Metal Plate Connected Wood Truss Construction* and BCSI 1-03 *Guide to Good Practice for Handling, Installing & Bracing of Metal Plate Connected Wood Trusses* from Truss Plate Institute, 583 D'Onofrio Drive, Madison, WI 53719.

Job	Truss	Truss Type	Qty	Ply	49786-0227 WOODGROVE FUQUAY VARINA, NC
21-5631-R01	R07	GABLE	1	1	Job Reference (optional) # 28542

8.430 s Feb 12 2021 MiTek Industries, Inc. Tue Sep 21 15:54:19 2021 Page 2
 ID:9CcuJl7eSaUnzH5X3uf?lgz6QyZ-l6B_MK3reH5H6kp9RaQUO70lbgNZbHF1jZGPKyvbNMI

- 15) Graphical bracing representation does not depict the size, type or the orientation of the brace on the member. Symbol only indicates that the member must be braced.
- 16) Bearing symbols are only graphical representations of a possible bearing condition. Bearing symbols are not considered in the structural design of the truss to support the loads indicated.
- 17) Web bracing shown is for lateral support of individual web members only. Refer to BCSI - Guide to Good Practice for Handling, Installing, Restraining & Bracing of Metal Plate Connected Wood Trusses for additional bracing guidelines, including diagonal bracing.
- 18) SEE BCSI-B3 SUMMARY SHEET- PERMANENT RESTRAING/BRACING OF CHORDS & WEB MEMBERS FOR RECOMMENDED MINIMUM BRACING REQUIREMENTS OF TOP CHORD, BOTTOM CHORD, AND WEB PLANES. IN ADDITION TO THESE MINIMUM GUIDELINES, ALWAYS CONSULT THE PROJECT ARCHITECT OR ENGINEER FOR ADDITIONAL BRACING CONSIDERATIONS.

LOAD CASE(S) Standard



9/20/2021

Warning !—Verify design parameters and read notes before use. This design is based only upon parameters shown, and is for an individual building component to be installed and loaded vertically. Applicability of design parameters and proper incorporation of component is responsibility of building designer – not truss designer or truss engineer. Bracing shown is for lateral support of individual web members only. Additional temporary bracing to ensure stability during construction is the responsibility of the erector. Additional permanent bracing of the overall structure is the responsibility of the building designer. For general guidance regarding fabrication, quality control, storage, delivery, erection and bracing, consult ANSI/TPI 1 *National Design Standard for Metal Plate Connected Wood Truss Construction* and BCSI 1-03 *Guide to Good Practice for Handling, Installing & Bracing of Metal Plate Connected Wood Trusses* from Truss Plate Institute, 583 D'Onofrio Drive, Madison, WI 53719.

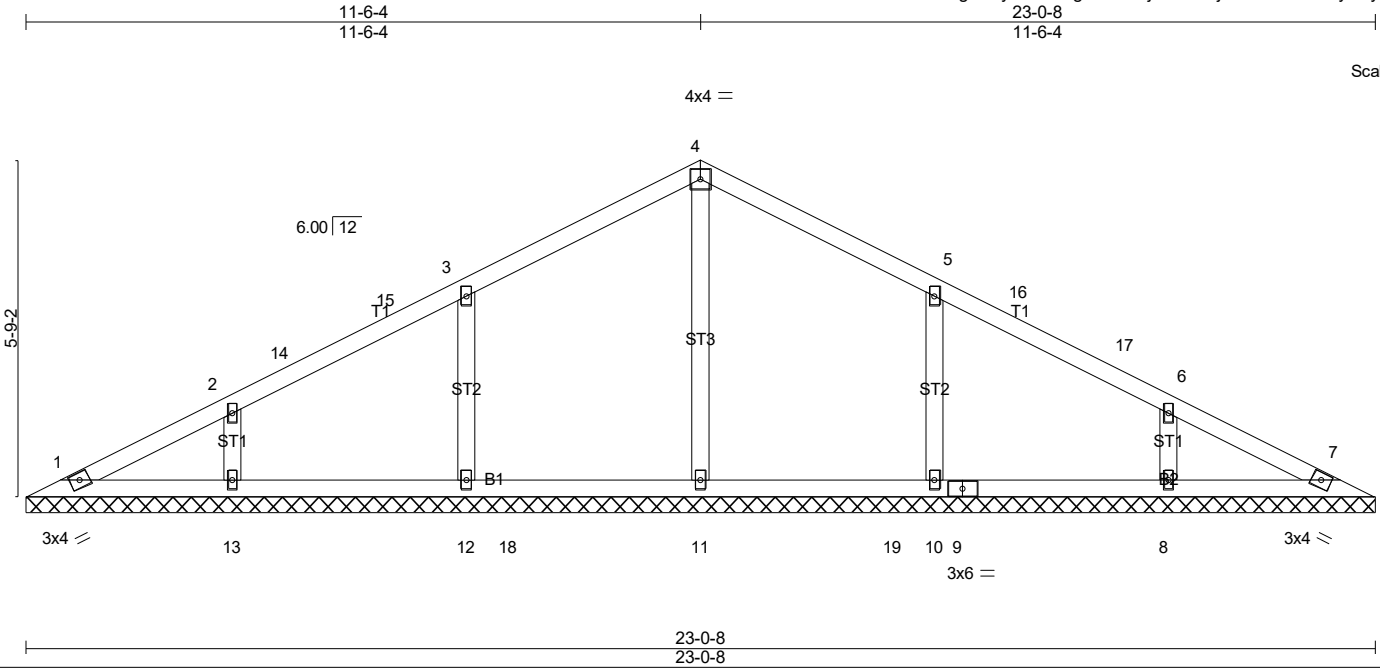

Scale = 1:39.4

LOADING (psf)	TCLL (roof) 20.0 Snow (Pf) 20.0 TCDL 10.0 BCLL 0.0 * BCDL 10.0	SPACING-	2-0-0 Plate Grip DOL 1.15 Lumber DOL 1.15 Rep Stress Incr YES Code IRC2018/TPI2014	CSI.	TC 0.29 BC 0.42 WB 0.12 Matrix-SH	DEFL.	in (loc) l/defl L/d Vert(LL) n/a - n/a 999 Vert(CT) n/a - n/a 999 Horz(CT) 0.00 7 n/a n/a	PLATES	GRIP
								MT20	244/190
								Weight: 91 lb	FT = 20%

LUMBER-
 TOP CHORD 2x4 SP No.2
 BOT CHORD 2x4 SP No.3
 OTHERS 2x4 SP No.3

BRACING-
 TOP CHORD Structural wood sheathing directly applied or 6'-0-0 oc purlins.
 BOT CHORD Rigid ceiling directly applied or 10'-0-0 oc bracing.

MiTek recommends that Stabilizers and required cross bracing be installed during truss erection, in accordance with Stabilizer Installation guide.

REACTIONS. All bearings 23-0-8.
 (lb) - Max Horz 1=66(LC 14)
 Max Uplift All uplift 100 lb or less at joint(s) 1, 12, 13, 10, 8
 Max Grav All reactions 250 lb or less at joint(s) 1, 7 except 11=449(LC 6), 12=459(LC 20), 13=302(LC 1), 10=459(LC 21), 8=302(LC 1)

FORCES. (lb) - Max. Comp./Max. Ten. - All forces 250 (lb) or less except when shown.
WEBS 3-12=-379/124, 5-10=-379/124

- NOTES-** (11-14)
- 1) Unbalanced roof live loads have been considered for this design.
 - 2) Wind: ASCE 7-16; Vult=115mph (3-second gust) Vasd=91mph; TCCL=5.0psf; BCCL=5.0psf; h=23ft; Cat. II; Exp B; Enclosed; MWFRS (envelope) gable end zone and C-C Corner(3E) 0-7-7 to 4-7-0, Exterior(2N) 4-7-0 to 7-6-4, Corner(3R) 7-6-4 to 15-6-4, Exterior(2N) 15-6-4 to 18-5-8, Corner(3E) 18-5-8 to 22-5-1 zone; C-C for members and forces & MWFRS for reactions shown; Lumber DOL=1.60 plate grip DOL=1.60
 - 3) TCLL: ASCE 7-16; Pr=20.0 psf (roof LL: Lum DOL=1.15 Plate DOL=1.15); Pf=20.0 psf (Lum DOL=1.15 Plate DOL=1.15); Is=1.0; Rough Cat B; Partially Exp.; Ce=1.0; Cs=1.00; Ct=1.10
 - 4) Unbalanced snow loads have been considered for this design.
 - 5) All plates are 2x4 MT20 unless otherwise indicated.
 - 6) Gable requires continuous bottom chord bearing.
 - 7) This truss has been designed for a 10.0 psf bottom chord live load nonconcurrent with any other live loads.
 - 8) * This truss has been designed for a live load of 30.0psf on the bottom chord in all areas where a rectangle 3'-6-0 tall by 1'-0-0 wide will fit between the bottom chord and any other members, with BCCL = 10.0psf.
 - 9) Provide mechanical connection (by others) of truss to bearing plate capable of withstanding 100 lb uplift at joint(s) 1, 12, 13, 10, 8.
 - 10) This truss is designed in accordance with the 2018 International Residential Code sections R502.11.1 and R802.10.2 and referenced standard ANSI/TPI 1.
 - 11) Graphical bracing representation does not depict the size, type or the orientation of the brace on the member. Symbol only indicates that the member must be braced.
 - 12) Bearing symbols are only graphical representations of a possible bearing condition. Bearing symbols are not considered in the structural design of the truss to support the loads indicated.
 - 13) Web bracing shown is for lateral support of individual web members only. Refer to BCSI - Guide to Good Practice for Handling, Installing, Restraining & Bracing of Metal Plate Connected Wood Trusses for additional bracing guidelines, including diagonal bracing.
 - 14) SEE BCSI-B3 SUMMARY SHEET- PERMANENT RESTRAINING/BRACING OF CHORDS & WEB MEMBERS FOR RECOMMENDED MINIMUM BRACING REQUIREMENTS OF TOP CHORD, BOTTOM CHORD, AND WEB PLANES. IN ADDITION TO THESE MINIMUM GUIDELINES, ALWAYS CONSULT THE PROJECT ARCHITECT OR ENGINEER FOR ADDITIONAL BRACING CONSIDERATIONS.



9/20/2021

LOAD CASE(S) Standard parameters and read notes before use. This design is based only upon parameters shown, and is for an individual building component to be installed and loaded vertically. Applicability of design parameters and proper incorporation of component is responsibility of building designer – not truss designer or truss engineer. Bracing shown is for lateral support of individual web members only. Additional temporary bracing to ensure stability during construction is the responsibility of the erector. Additional permanent bracing of the overall structure is the responsibility of the building designer. For general guidance regarding fabrication, quality control, storage, delivery, erection and bracing, consult ANSI/TPI 1 *National Design Standard for Metal Plate Connected Wood Truss Construction* and BCSI I-03 *Guide to Good Practice for Handling, Installing & Bracing of Metal Plate Connected Wood Trusses* from Truss Plate Institute, 583 D'Onofrio Drive, Madison, WI 53719.

Job 21-5631-R01	Truss VT02	Truss Type Valley	Qty 1	Ply 1	49786-0227 WOODGROVE FUQUAY VARINA, NC
Job Reference (optional)					# 28542

8.430 s Feb 12 2021 MiTek Industries, Inc. Tue Sep 21 15:54:22 2021 Page 1
ID:9CcuJI7eSaUnzH5X3uf?lgz6QyZ-9ht6?M5kxCTszBXj6izB0mekttMXodZTPXU3xHybNMF

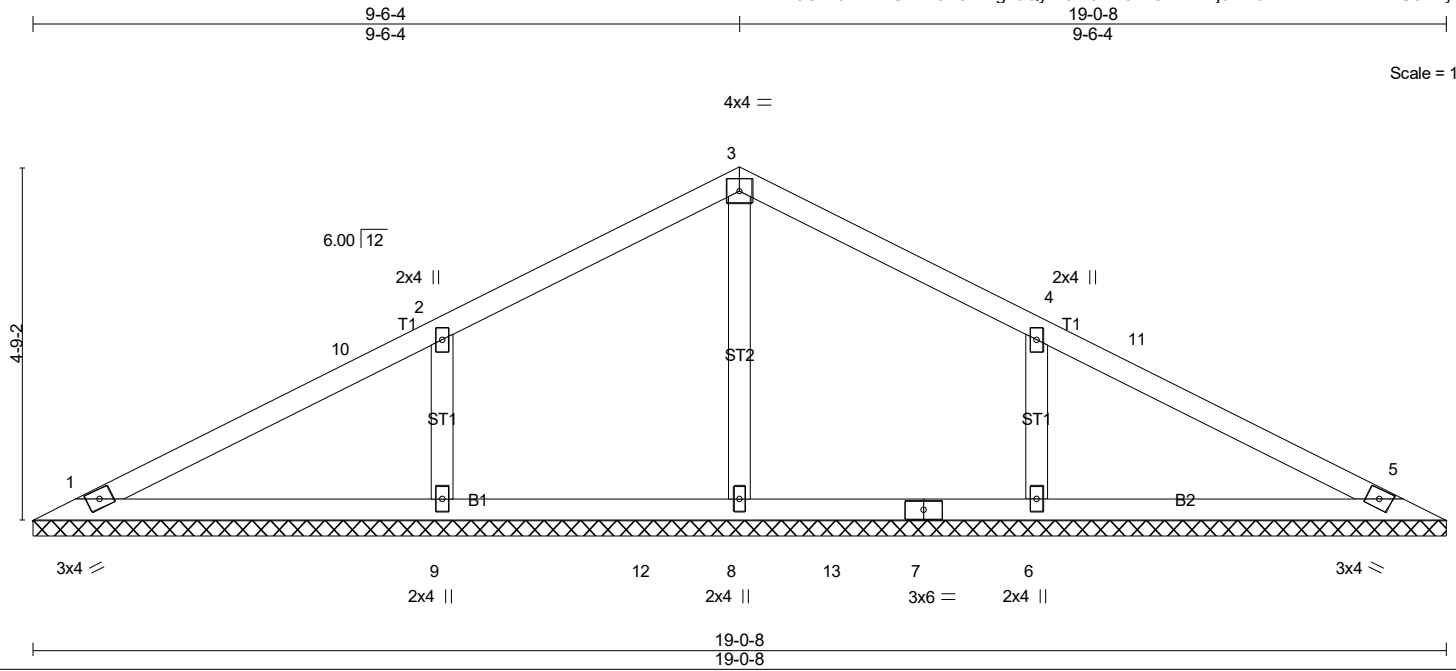

Scale = 1:31.0

LOADING (psf)	SPACING-	CSI.	DEFL.	PLATES	GRIP
TCLL (roof) 20.0	2-0-0	TC 0.37	in (loc) l/defl L/d	MT20	244/190
Snow (Pf) 20.0	Plate Grip DOL 1.15	BC 0.31	Vert(LL) n/a - n/a 999		
TCDL 10.0	Lumber DOL 1.15	WB 0.10	Vert(CT) n/a - n/a 999		
BCLL 0.0 *	Rep Stress Incr YES	Matrix-SH	Horz(CT) 0.00 5 n/a n/a		
BCDL 10.0	Code IRC2018/TPI2014			Weight: 71 lb	FT = 20%

LUMBER-
TOP CHORD 2x4 SP No.2
BOT CHORD 2x4 SP No.3
OTHERS 2x4 SP No.3

BRACING-
TOP CHORD
BOT CHORD

Structural wood sheathing directly applied or 6-0-0 oc purlins.
Rigid ceiling directly applied or 10-0-0 oc bracing.

MiTek recommends that Stabilizers and required cross bracing be installed during truss erection, in accordance with Stabilizer Installation guide.

REACTIONS. All bearings 19-0-8.

(lb) - Max Horz 1=-54(LC 15)

Max Uplift All uplift 100 lb or less at joint(s) 1, 5, 9, 6

Max Grav All reactions 250 lb or less at joint(s) 1, 5 except 8=323(LC 6), 9=549(LC 20), 6=549(LC 21)

FORCES. (lb) - Max. Comp./Max. Ten. - All forces 250 (lb) or less except when shown.

WEBS 2-9=-428/143, 4-6=-428/143

NOTES- (10-13)

- Unbalanced roof live loads have been considered for this design.
- Wind: ASCE 7-16; Vult=115mph (3-second gust) Vasd=91mph; TC DL=5.0psf; BCDL=5.0psf; h=24ft; Cat. II; Exp B; Enclosed; MWFRS (envelope) gable end zone and C-C Exterior(2E) 0-7-7 to 4-7-0, Interior(1) 4-7-0 to 5-6-4, Exterior(2R) 5-6-4 to 13-6-4, Interior(1) 13-6-4 to 14-5-8, Exterior(2E) 14-5-8 to 18-5-1 zone; C-C for members and forces & MWFRS for reactions shown; Lumber DOL=1.60 plate grip DOL=1.60
- TCLL: ASCE 7-16; Pr=20.0 psf (roof LL: Lum DOL=1.15 Plate DOL=1.15); Pf=20.0 psf (Lum DOL=1.15 Plate DOL=1.15); Is=1.0; Rough Cat B; Partially Exp.; Ce=1.0; Cs=1.00; Ct=1.10
- Unbalanced snow loads have been considered for this design.
- Gable requires continuous bottom chord bearing.
- This truss has been designed for a 10.0 psf bottom chord live load nonconcurrent with any other live loads.
- * This truss has been designed for a live load of 30.0psf on the bottom chord in all areas where a rectangle 3-6-0 tall by 1-0-0 wide will fit between the bottom chord and any other members, with BCDL = 10.0psf.
- Provide mechanical connection (by others) of truss to bearing plate capable of withstanding 100 lb uplift at joint(s) 1, 5, 9, 6.
- This truss is designed in accordance with the 2018 International Residential Code sections R502.11.1 and R802.10.2 and referenced standard ANSI/TPI 1.
- Graphical bracing representation does not depict the size, type or the orientation of the brace on the member. Symbol only indicates that the member must be braced.
- Bearing symbols are only graphical representations of a possible bearing condition. Bearing symbols are not considered in the structural design of the truss to support the loads indicated.
- Web bracing shown is for lateral support of individual web members only. Refer to BCSI - Guide to Good Practice for Handling, Installing, Restraining & Bracing of Metal Plate Connected Wood Trusses for additional bracing guidelines, including diagonal bracing.
- SEE BCSI-B3 SUMMARY SHEET- PERMANENT RESTRAINING/BRACING OF CHORDS & WEB MEMBERS FOR RECOMMENDED MINIMUM BRACING REQUIREMENTS OF TOP CHORD, BOTTOM CHORD, AND WEB PLANES. IN ADDITION TO THESE MINIMUM GUIDELINES, ALWAYS CONSULT THE PROJECT ARCHITECT OR ENGINEER FOR ADDITIONAL BRACING CONSIDERATIONS.

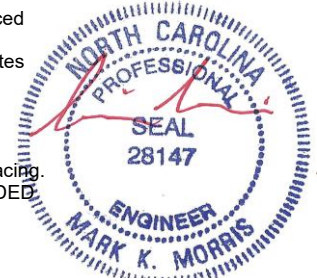

LOAD CASE(S) Standard

9/20/2021

Warning!—Verify design parameters and read notes before use. This design is based only upon parameters shown, and is for an individual building component to be installed and loaded vertically. Applicability of design parameters and proper incorporation of component is responsibility of building designer – not truss designer or truss engineer. Bracing shown is for lateral support of individual web members only. Additional temporary bracing to ensure stability during construction is the responsibility of the erector. Additional permanent bracing of the overall structure is the responsibility of the building designer. For general guidance regarding fabrication, quality control, storage, delivery, erection and bracing, consult ANSI/TPI 1 *National Design Standard for Metal Plate Connected Wood Truss Construction* and BCSI 1-03 *Guide to Good Practice for Handling, Installing & Bracing of Metal Plate Connected Wood Trusses* from Truss Plate Institute, 583 D'Onofrio Drive, Madison, WI 53719.

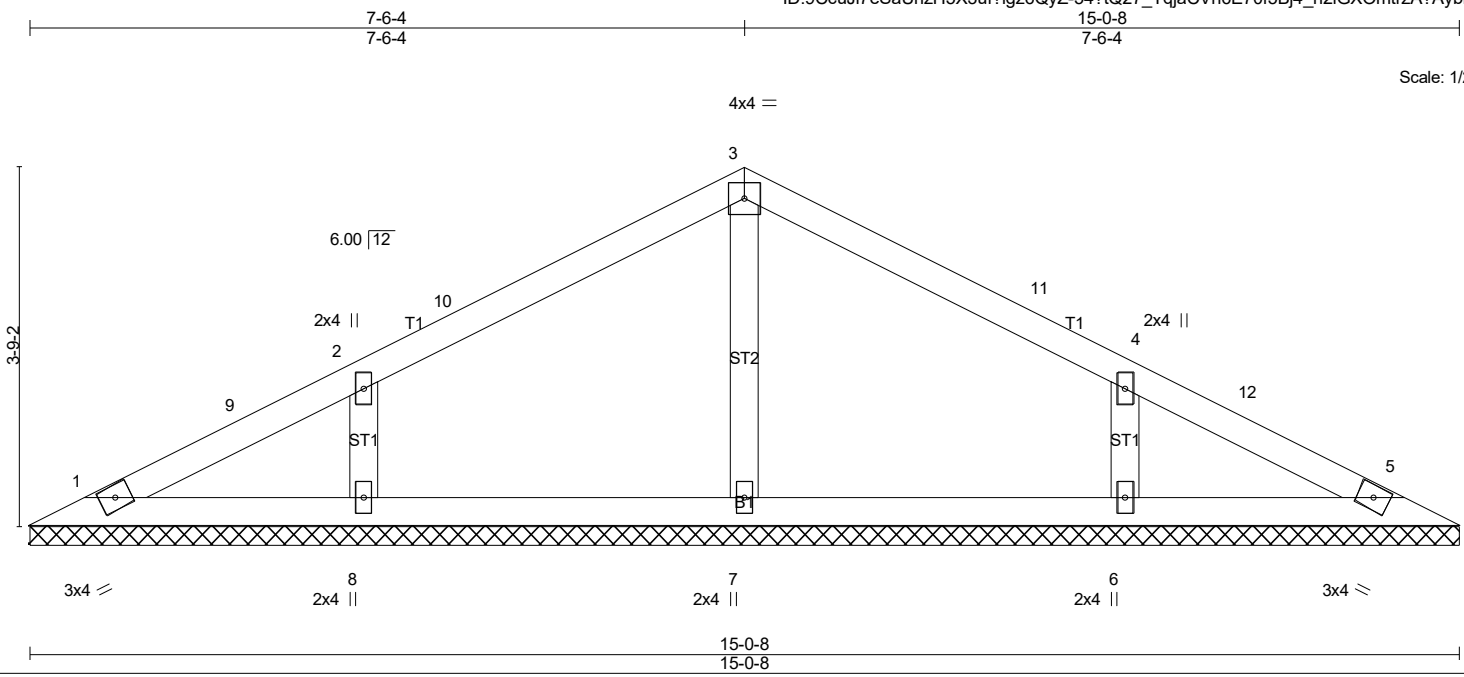

LOADING (psf)	TCLL (roof) 20.0 Snow (Pf) 20.0 TCDL 10.0 BCLL 0.0 * BCDL 10.0	SPACING- 2-0-0 Plate Grip DOL 1.15 Lumber DOL 1.15 Rep Stress Incr YES Code IRC2018/TPI2014	CSI. TC 0.27 BC 0.19 WB 0.07 Matrix-SH	DEFL. in (loc) l/defl L/d Vert(LL) n/a - n/a 999 Vert(CT) n/a - n/a 999 Horz(CT) 0.00 5 n/a n/a	PLATES MT20 GRIP 244/190 Weight: 54 lb FT = 20%
----------------------	--	---	---	--	---

LUMBER-
 TOP CHORD 2x4 SP No.2
 BOT CHORD 2x4 SP No.3
 OTHERS 2x4 SP No.3

BRACING-
 TOP CHORD Structural wood sheathing directly applied or 6-0-0 oc purlins.
 BOT CHORD Rigid ceiling directly applied or 10-0-0 oc bracing.

MiTek recommends that Stabilizers and required cross bracing be installed during truss erection, in accordance with Stabilizer Installation guide.

REACTIONS. All bearings 15-0-8.
 (lb) - Max Horz 1=-42(LC 15)
 Max Uplift All uplift 100 lb or less at joint(s) 1, 8, 6
 Max Grav All reactions 250 lb or less at joint(s) 1, 5 except 7=291(LC 21), 8=443(LC 20), 6=443(LC 21)

FORCES. (lb) - Max. Comp./Max. Ten. - All forces 250 (lb) or less except when shown.
 WEBS 2-8=-366/137, 4-6=-366/137

- NOTES-** (10-13)
- 1) Unbalanced roof live loads have been considered for this design.
 - 2) Wind: ASCE 7-16; Vult=115mph (3-second gust) Vasd=91mph; TCDL=5.0psf; BCDL=5.0psf; h=24ft; Cat. II; Exp B; Enclosed; MWFRS (envelope) gable end zone and C-C Exterior(2E) 0-7-7 to 4-7-0, Exterior(2R) 4-7-0 to 10-5-8, Exterior(2E) 10-5-8 to 14-5-1 zone; C-C for members and forces & MWFRS for reactions shown; Lumber DOL=1.60 plate grip DOL=1.60
 - 3) TCLL: ASCE 7-16; Pr=20.0 psf (roof LL: Lum DOL=1.15 Plate DOL=1.15); Pf=20.0 psf (Lum DOL=1.15 Plate DOL=1.15); Is=1.0; Rough Cat B; Partially Exp.; Ce=1.0; Cs=1.00; Ct=1.10
 - 4) Unbalanced snow loads have been considered for this design.
 - 5) Gable requires continuous bottom chord bearing.
 - 6) This truss has been designed for a 10.0 psf bottom chord live load nonconcurrent with any other live loads.
 - 7) * This truss has been designed for a live load of 30.0psf on the bottom chord in all areas where a rectangle 3-6-0 tall by 1-0-0 wide will fit between the bottom chord and any other members.
 - 8) Provide mechanical connection (by others) of truss to bearing plate capable of withstanding 100 lb uplift at joint(s) 1, 8, 6.
 - 9) This truss is designed in accordance with the 2018 International Residential Code sections R502.11.1 and R802.10.2 and referenced standard ANSI/TPI 1.
 - 10) Graphical bracing representation does not depict the size, type or the orientation of the brace on the member. Symbol only indicates that the member must be braced.
 - 11) Bearing symbols are only graphical representations of a possible bearing condition. Bearing symbols are not considered in the structural design of the truss to support the loads indicated.
 - 12) Web bracing shown is for lateral support of individual web members only. Refer to BCSI - Guide to Good Practice for Handling, Installing, Restraining & Bracing of Metal Plate Connected Wood Trusses for additional bracing guidelines, including diagonal bracing.
 - 13) SEE BCSI-B3 SUMMARY SHEET- PERMANENT RESTRAINING/BRACING OF CHORDS & WEB MEMBERS FOR RECOMMENDED MINIMUM BRACING REQUIREMENTS OF TOP CHORD, BOTTOM CHORD, AND WEB PLANES. IN ADDITION TO THESE MINIMUM GUIDELINES, ALWAYS CONSULT THE PROJECT ARCHITECT OR ENGINEER FOR ADDITIONAL BRACING CONSIDERATIONS.

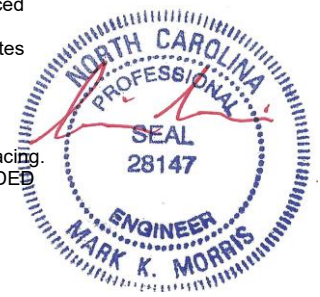

LOAD CASE(S) Standard

9/20/2021

Warning!—Verify design parameters and read notes before use. This design is based only upon parameters shown, and is for an individual building component to be installed and loaded vertically. Applicability of design parameters and proper incorporation of component is responsibility of building designer – not truss designer or truss engineer. Bracing shown is for lateral support of individual web members only. Additional temporary bracing to ensure stability during construction is the responsibility of the erector. Additional permanent bracing of the overall structure is the responsibility of the building designer. For general guidance regarding fabrication, quality control, storage, delivery, erection and bracing, consult ANSI/TPI 1 *National Design Standard for Metal Plate Connected Wood Truss Construction* and BCSI 1-03 *Guide to Good Practice for Handling, Installing & Bracing of Metal Plate Connected Wood Trusses* from Truss Plate Institute, 583 D'Onofrio Drive, Madison, WI 53719.

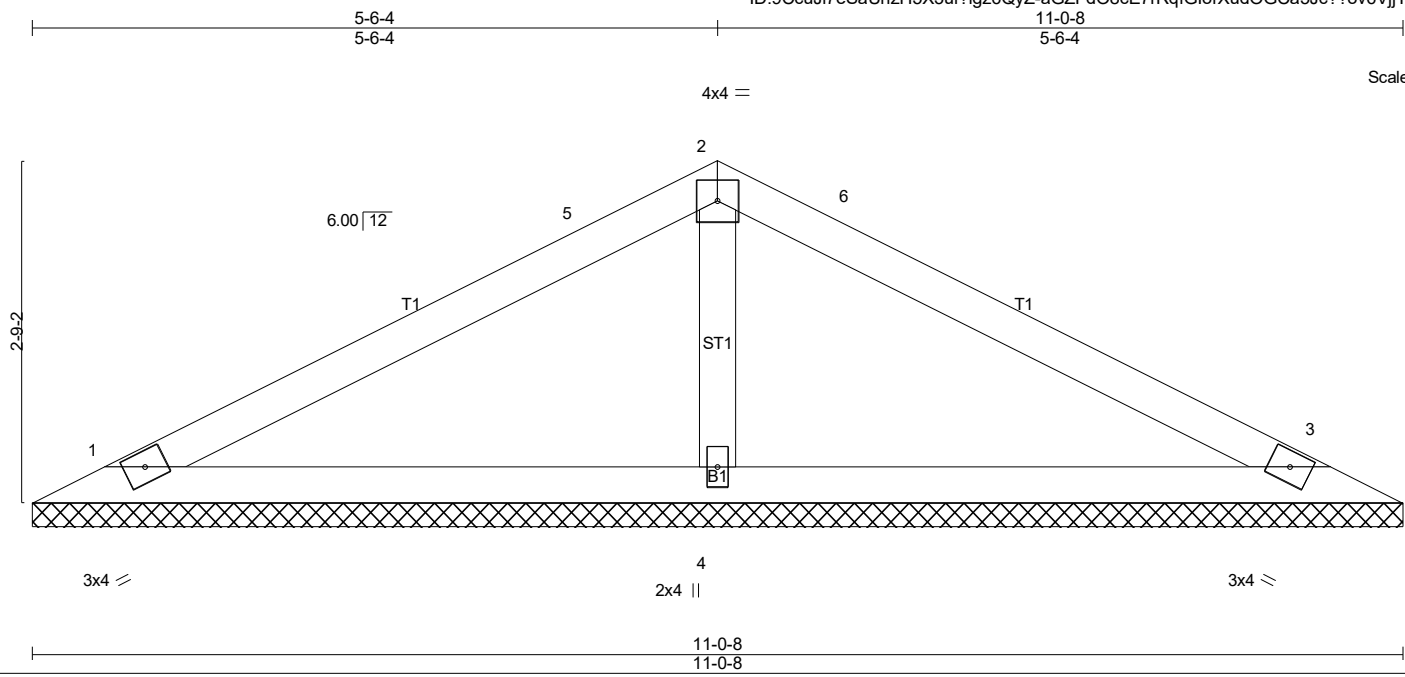

Scale = 1:18.6

LOADING (psf)	SPACING-	CSI.	DEFL.	PLATES	GRIP
TCLL (roof) 20.0	2-0-0	TC 0.47	in (loc) l/defl L/d	MT20	244/190
Snow (Pf) 20.0	Plate Grip DOL 1.15	BC 0.54	Vert(LL) n/a - n/a 999		
TCDL 10.0	Lumber DOL 1.15	WB 0.06	Vert(CT) n/a - n/a 999		
BCLL 0.0 *	Rep Stress Incr YES	Matrix-SH	Horz(CT) 0.00 3 n/a n/a		
BCDL 10.0	Code IRC2018/TPI2014			Weight: 36 lb	FT = 20%

LUMBER-	BRACING-
TOP CHORD 2x4 SP No.2	TOP CHORD Structural wood sheathing directly applied or 6-0-0 oc purlins.
BOT CHORD 2x4 SP No.3	BOT CHORD Rigid ceiling directly applied or 10-0-0 oc bracing.
OTHERS 2x4 SP No.3	

MiTek recommends that Stabilizers and required cross bracing be installed during truss erection, in accordance with Stabilizer Installation guide.

REACTIONS. (lb/size) 1=175/11-0-8 (min. 0-1-8), 3=175/11-0-8 (min. 0-1-8), 4=434/11-0-8 (min. 0-1-8)
 Max Horz 1=30(LC 18)
 Max Uplift 1=-21(LC 14), 3=-27(LC 15), 4=-5(LC 14)
 Max Grav 1=257(LC 20), 3=257(LC 21), 4=447(LC 21)

FORCES. (lb) - Max. Comp./Max. Ten. - All forces 250 (lb) or less except when shown.
WEBS 2-4=-284/116

- NOTES-** (10-13)
- 1) Unbalanced roof live loads have been considered for this design.
 - 2) Wind: ASCE 7-16; Vult=115mph (3-second gust) Vasd=91mph; TCDL=5.0psf; BCDL=5.0psf; h=25ft; Cat. II; Exp B; Enclosed; MWFRS (envelope) gable end zone and C-C Exterior(2E) 0-7-7 to 4-7-0, Exterior(2R) 4-7-0 to 6-5-8, Exterior(2E) 6-5-8 to 10-5-1 zone; C-C for members and forces & MWFRS for reactions shown; Lumber DOL=1.60 plate grip DOL=1.60
 - 3) TCLL: ASCE 7-16; Pr=20.0 psf (roof LL: Lum DOL=1.15 Plate DOL=1.15); Pf=20.0 psf (Lum DOL=1.15 Plate DOL=1.15); Is=1.0; Rough Cat B; Partially Exp.; Ce=1.0; Cs=1.00; Ct=1.10
 - 4) Unbalanced snow loads have been considered for this design.
 - 5) Gable requires continuous bottom chord bearing.
 - 6) This truss has been designed for a 10.0 psf bottom chord live load nonconcurrent with any other live loads.
 - 7) * This truss has been designed for a live load of 30.0psf on the bottom chord in all areas where a rectangle 3-6-0 tall by 1-0-0 wide will fit between the bottom chord and any other members.
 - 8) Provide mechanical connection (by others) of truss to bearing plate capable of withstanding 100 lb uplift at joint(s) 1, 3, 4.
 - 9) This truss is designed in accordance with the 2018 International Residential Code sections R502.11.1 and R802.10.2 and referenced standard ANSI/TPI 1.
 - 10) Graphical bracing representation does not depict the size, type or the orientation of the brace on the member. Symbol only indicates that the member must be braced.
 - 11) Bearing symbols are only graphical representations of a possible bearing condition. Bearing symbols are not considered in the structural design of the truss to support the loads indicated.
 - 12) Web bracing shown is for lateral support of individual web members only. Refer to BCSI - Guide to Good Practice for Handling, Installing, Restraining & Bracing of Metal Plate Connected Wood Trusses for additional bracing guidelines, including diagonal bracing.
 - 13) SEE BCSI-B3 SUMMARY SHEET- PERMANENT RESTRAINING/BRACING OF CHORDS & WEB MEMBERS FOR RECOMMENDED MINIMUM BRACING REQUIREMENTS OF TOP CHORD, BOTTOM CHORD, AND WEB PLANES. IN ADDITION TO THESE MINIMUM GUIDELINES, ALWAYS CONSULT THE PROJECT ARCHITECT OR ENGINEER FOR ADDITIONAL BRACING CONSIDERATIONS.

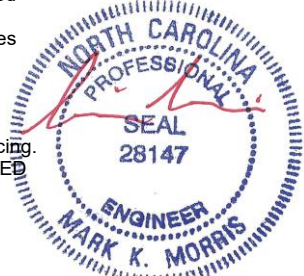

9/20/2021

Warning!—Verify design parameters and read notes before use. This design is based only upon parameters shown, and is for an individual building component to be installed and loaded vertically. Applicability of design parameters and proper incorporation of component is responsibility of building designer – not truss designer or truss engineer. Bracing shown is for lateral support of individual web members only. Additional temporary bracing to ensure stability during construction is the responsibility of the erector. Additional permanent bracing of the overall structure is the responsibility of the building designer. For general guidance regarding fabrication, quality control, storage, delivery, erection and bracing, consult ANSI/TPI 1 *National Design Standard for Metal Plate Connected Wood Truss Construction* and BCSI I-03 *Guide to Good Practice for Handling, Installing & Bracing of Metal Plate Connected Wood Trusses* from Truss Plate Institute, 583 D'Onofrio Drive, Madison, WI 53719.

Job	Truss	Truss Type	Qty	Ply	49786-0227 WOODGROVE FUQUAY VARINA, NC
21-5631-R01	VT05	Valley	1	1	Job Reference (optional) # 28542

8.430 s Feb 12 2021 MiTek Industries, Inc. Tue Sep 21 15:54:26 2021 Page 1
 ID:9CcuJl7eSaUnzH5X3uf?lgz6QyZ-2S6drk8E?RzIRprVLY27AcoRIV?kSY3K9SG42ybNMB

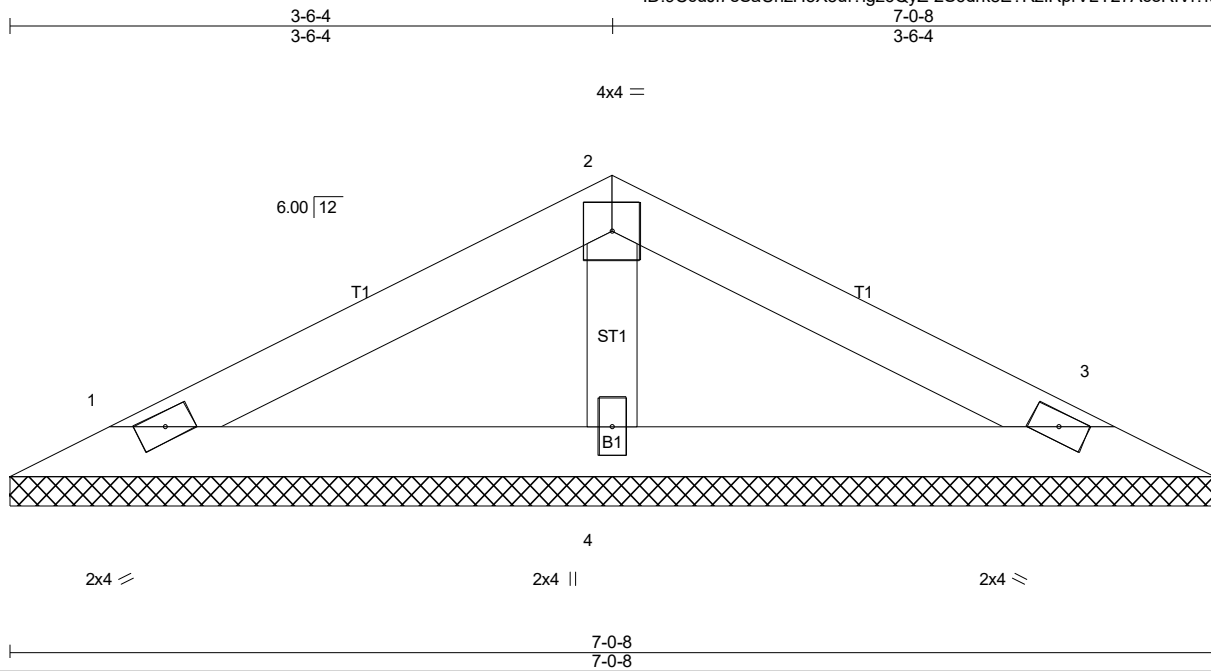

Scale = 1:13.5

LOADING (psf)	SPACING-	CSI.	DEFL.	PLATES	GRIP
TCLL (roof) 20.0	Plate Grip DOL 1.15	TC 0.22	Vert(LL) n/a	MT20	244/190
Snow (Pf) 20.0	Lumber DOL 1.15	BC 0.14	Vert(CT) n/a		
TCDL 10.0	Rep Stress Incr YES	WB 0.03	Horz(CT) 0.00		
BCLL 0.0 *	Code IRC2018/TPI2014	Matrix-P			
BCDL 10.0				Weight: 22 lb	FT = 20%

LUMBER-
 TOP CHORD 2x4 SP No.2
 BOT CHORD 2x4 SP No.3
 OTHERS 2x4 SP No.3

BRACING-
 TOP CHORD
 BOT CHORD

Structural wood sheathing directly applied or 6'-0-0 oc purlins.
 Rigid ceiling directly applied or 10'-0-0 oc bracing.

MiTek recommends that Stabilizers and required cross bracing be installed during truss erection, in accordance with Stabilizer Installation guide.

REACTIONS. (lb/size) 1=117/7-0-8 (min. 0-1-8), 3=117/7-0-8 (min. 0-1-8), 4=230/7-0-8 (min. 0-1-8)
 Max Horz 1=18(LC 18)
 Max Uplift 1=-17(LC 14), 3=-21(LC 15)
 Max Grav 1=154(LC 20), 3=154(LC 21), 4=230(LC 1)

FORCES. (lb) - Max. Comp./Max. Ten. - All forces 250 (lb) or less except when shown.

NOTES- (10-13)

- Unbalanced roof live loads have been considered for this design.
- Wind: ASCE 7-16; Vult=115mph (3-second gust) Vasd=91mph; TCDL=5.0psf; BCDL=5.0psf; h=25ft; Cat. II; Exp B; Enclosed; MWFRS (envelope) gable end zone and C-C Exterior(2E) zone; C-C for members and forces & MWFRS for reactions shown; Lumber DOL=1.60 plate grip DOL=1.60
- TCLL: ASCE 7-16; Pr=20.0 psf (roof LL: Lum DOL=1.15 Plate DOL=1.15); Pf=20.0 psf (Lum DOL=1.15 Plate DOL=1.15); Is=1.0; Rough Cat B; Partially Exp.; Ce=1.0; Cs=1.00; Ct=1.10
- Unbalanced snow loads have been considered for this design.
- Gable requires continuous bottom chord bearing.
- This truss has been designed for a 10.0 psf bottom chord live load nonconcurrent with any other live loads.
- * This truss has been designed for a live load of 30.0psf on the bottom chord in all areas where a rectangle 3'-6-0 tall by 1'-0-0 wide will fit between the bottom chord and any other members.
- Provide mechanical connection (by others) of truss to bearing plate capable of withstanding 100 lb uplift at joint(s) 1, 3.
- This truss is designed in accordance with the 2018 International Residential Code sections R502.11.1 and R802.10.2 and referenced standard ANSI/TPI 1.
- Graphical bracing representation does not depict the size, type or the orientation of the brace on the member. Symbol only indicates that the member must be braced.
- Bearing symbols are only graphical representations of a possible bearing condition. Bearing symbols are not considered in the structural design of the truss to support the loads indicated.
- Web bracing shown is for lateral support of individual web members only. Refer to BCSI - Guide to Good Practice for Handling, Installing, Restraining & Bracing of Metal Plate Connected Wood Trusses for additional bracing guidelines, including diagonal bracing.
- SEE BCSI-B3 SUMMARY SHEET- PERMANENT RESTRAINING/BRACING OF CHORDS & WEB MEMBERS FOR RECOMMENDED MINIMUM BRACING REQUIREMENTS OF TOP CHORD, BOTTOM CHORD, AND WEB PLANES. IN ADDITION TO THESE MINIMUM GUIDELINES, ALWAYS CONSULT THE PROJECT ARCHITECT OR ENGINEER FOR ADDITIONAL BRACING CONSIDERATIONS.

LOAD CASE(S) Standard

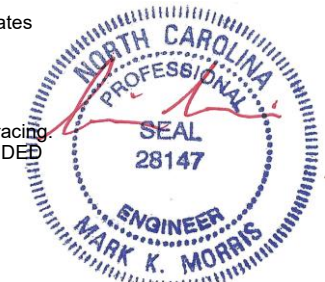

9/20/2021

Warning!—Verify design parameters and read notes before use. This design is based only upon parameters shown, and is for an individual building component to be installed and loaded vertically. Applicability of design parameters and proper incorporation of component is responsibility of building designer – not truss designer or truss engineer. Bracing shown is for lateral support of individual web members only. Additional temporary bracing to ensure stability during construction is the responsibility of the erector. Additional permanent bracing of the overall structure is the responsibility of the building designer. For general guidance regarding fabrication, quality control, storage, delivery, erection and bracing, consult ANSI/TPI 1 *National Design Standard for Metal Plate Connected Wood Truss Construction* and BCSI 1-03 *Guide to Good Practice for Handling, Installing & Bracing of Metal Plate Connected Wood Trusses* from Truss Plate Institute, 583 D'Onofrio Drive, Madison, WI 53719.

Job 21-5631-R01	Truss VT06	Truss Type GABLE	Qty 1	Ply 1	49786-0227 WOODGROVE FUQUAY VARINA, NC
					Job Reference (optional) # 28542

ID:9CcuJl7eSaUnzH5X3uf?lgz6QyZ-Wfg?239sml593zQhvGZMjpLdwu6xTvSCZpCqcUybNMA 8.430 s Feb 12 2021 MiTek Industries, Inc. Tue Sep 21 15:54:27 2021 Page 1

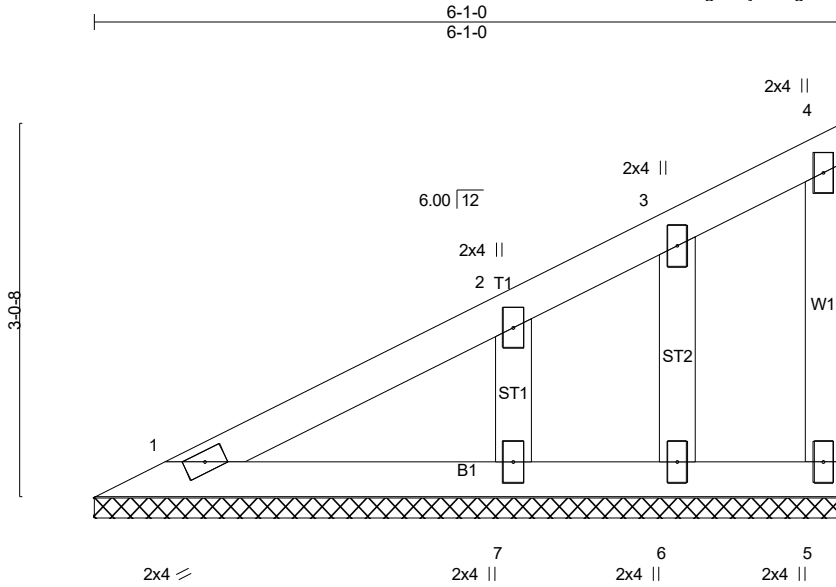

LOADING (psf)	SPACING-	CSI.	DEFL.	PLATES	GRIP
TCLL (roof) 20.0	2-0-0	TC 0.16	in (loc) l/defl L/d	MT20	244/190
Snow (Pf) 20.0	Plate Grip DOL 1.15	BC 0.10	Vert(LL) n/a - n/a 999		
TCDL 10.0	Lumber DOL 1.15	WB 0.05	Vert(CT) n/a - n/a 999		
BCLL 0.0 *	Rep Stress Incr YES	Matrix-P	Horz(CT) 0.00 n/a n/a		
BCDL 10.0	Code IRC2018/TPI2014			Weight: 26 lb	FT = 20%

LUMBER-
TOP CHORD 2x4 SP No.2
BOT CHORD 2x4 SP No.3
WEBS 2x4 SP No.3
OTHERS 2x4 SP No.3

BRACING-
TOP CHORD Structural wood sheathing directly applied or 6-0-0 oc purlins, except end verticals.
BOT CHORD Rigid ceiling directly applied or 10-0-0 oc bracing.
MiTek recommends that Stabilizers and required cross bracing be installed during truss erection, in accordance with Stabilizer Installation guide.

REACTIONS. All bearings 6-1-0.
(lb) - Max Horz 1=73(LC 14)
Max Uplift All uplift 100 lb or less at joint(s) 5, 6, 7
Max Grav All reactions 250 lb or less at joint(s) 1, 5, 6 except 7=322(LC 20)

FORCES. (lb) - Max. Comp./Max. Ten. - All forces 250 (lb) or less except when shown.
WEBS 2-7=-265/135

- NOTES-** (9-12)
- 1) Wind: ASCE 7-16; Vult=115mph (3-second gust) Vasd=91mph; TCCL=5.0psf; BCDL=5.0psf; h=21ft; Cat. II; Exp B; Enclosed; MWFRS (envelope) gable end zone and C-C Corner(3) 0-7-7 to 4-9-0, Exterior(2R) 4-9-0 to 5-11-4 zone; C-C for members and forces & MWFRS for reactions shown; Lumber DOL=1.60 plate grip DOL=1.60
 - 2) TCLL: ASCE 7-16; Pr=20.0 psf (roof LL: Lum DOL=1.15 Plate DOL=1.15); Pf=20.0 psf (Lum DOL=1.15 Plate DOL=1.15); Is=1.0; Rough Cat B; Partially Exp.; Ce=1.0; Cs=1.00; Ct=1.10
 - 3) Unbalanced snow loads have been considered for this design.
 - 4) Gable requires continuous bottom chord bearing.
 - 5) This truss has been designed for a 10.0 psf bottom chord live load nonconcurrent with any other live loads.
 - 6) * This truss has been designed for a live load of 30.0psf on the bottom chord in all areas where a rectangle 3-6-0 tall by 1-0-0 wide will fit between the bottom chord and any other members.
 - 7) Provide mechanical connection (by others) of truss to bearing plate capable of withstanding 100 lb uplift at joint(s) 5, 6, 7.
 - 8) This truss is designed in accordance with the 2018 International Residential Code sections R502.11.1 and R802.10.2 and referenced standard ANSI/TPI 1.
 - 9) Graphical bracing representation does not depict the size, type or the orientation of the brace on the member. Symbol only indicates that the member must be braced.
 - 10) Bearing symbols are only graphical representations of a possible bearing condition. Bearing symbols are not considered in the structural design of the truss to support the loads indicated.
 - 11) Web bracing shown is for lateral support of individual web members only. Refer to BCSI - Guide to Good Practice for Handling, Installing, Restraining & Bracing of Metal Plate Connected Wood Trusses for additional bracing guidelines, including diagonal bracing.
 - 12) SEE BCSI-B3 SUMMARY SHEET- PERMANENT RESTRAINING/BRACING OF CHORDS & WEB MEMBERS FOR RECOMMENDED MINIMUM BRACING REQUIREMENTS OF TOP CHORD, BOTTOM CHORD, AND WEB PLANES. IN ADDITION TO THESE MINIMUM GUIDELINES, ALWAYS CONSULT THE PROJECT ARCHITECT OR ENGINEER FOR ADDITIONAL BRACING CONSIDERATIONS.

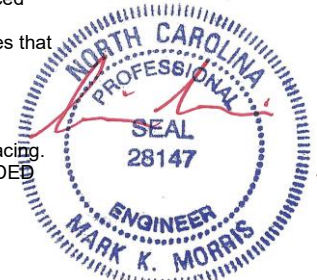

LOAD CASE(S) Standard

9/20/2021

Warning!—Verify design parameters and read notes before use. This design is based only upon parameters shown, and is for an individual building component to be installed and loaded vertically. Applicability of design parameters and proper incorporation of component is responsibility of building designer – not truss designer or truss engineer. Bracing shown is for lateral support of individual web members only. Additional temporary bracing to ensure stability during construction is the responsibility of the erector. Additional permanent bracing of the overall structure is the responsibility of the building designer. For general guidance regarding fabrication, quality control, storage, delivery, erection and bracing, consult ANSI/TPI 1 *National Design Standard for Metal Plate Connected Wood Truss Construction* and BCSI 1-03 *Guide to Good Practice for Handling, Installing & Bracing of Metal Plate Connected Wood Trusses* from Truss Plate Institute, 583 D'Onofrio Drive, Madison, WI 53719.