



ELEVATION NOTES:
 GRADE ELEVATIONS SHOWN DO NOT NECESSARILY REFER TO THIS OR ANY OTHER LOT. THEY ARE FOR DIAGRAMMATIC PURPOSES ONLY AND MAY VARY. BUILDER IS RESPONSIBLE FOR ADAPTING THIS PLAN TO SUIT THE EXISTING TOPOGRAPHY OF THE SITE.

ROOF VENTILATION TO BE DETERMINED BY BUILDER AS PER CODE.

ALL EGRESS OR RESCUE WINDOWS FROM SLEEPING ROOMS MUST HAVE A MIN. NET CLEAR OPENING OF 4.0 SQ. FT. THE MIN NET CLEAR OPENING HEIGHT DIMENSION SHALL BE 20". THE MIN NET CLEAR OPENING WIDTH SHALL BE 20".

EACH EGRESS WINDOW FROM SLEEPING ROOMS MUST HAVE A SILL HIGHT OF NO MORE THAN 44" FROM THE FLOOR. ALL WINDOW SIZES ARE NOMINAL AND ARE TO BE VERIFIED WITH MANUFACTURER FOR AVAILABILITY AND CONFORMITY TO STATE AND LOCAL CODE REQUIREMENTS.

PORCHES, BALCONIES, OR RAISED FLOOR SURFACES LOCATED MORE THAN 30" ABOVE THE FLOOR OR GRADE BELOW SHALL HAVE GUARDRAILS NOT LESS THAN 32" IN HEIGHT.

I ASSUME NO RESPONSIBILITY FOR ANY DISTANCES AFTER START OF CONSTRUCTION. CONTRACTOR/BUILDER SHALL CONSULT WITH HOME OWNER ON ALL INTERIOR AND EXTERIOR HOLDINGS, TRIMS, COLORS, FINISHES, CABINET LAYOUTS, AND MANUFACTURERS BEFORE CONSTRUCTION BEGINS. ALL BEAMS AND FRAMING MEMBERS ARE SIZED BY OTHERS.

1.1 This plan has been drawn to comply with the 2018 NC Building Code

- 1.2 Minimum Design Loads for Building and Other Structures ASCE 7-95
- 2 Roof Dead Load 15 P&F
 - 3 Roof Live Load 20 P&F
 - 4 Typical Floor Dead Load 10 P&F
 - 5 Floor Live Loads
 - 5.1 Rooms other than sleeping rooms 40 P&F
 - 5.2 Sleeping Rooms 30 P&F
 - 5.3 Stairs 40 P&F
 - 5.4 Decks 40 P&F
 - 5.5 Exterior Balconies 60 P&F
 - 6 Wind Loads
 - 6.1 Ultimate Design Wind Speeds 15 MPH
 - 6.2 Wind Importance Factor, I_w 1.00
 - 6.3 Exposure B
 - 6.4 Walls (Component and Cladding) 25 P&F
 - 6.5 Roofs (Component and Cladding)
 - 6.5.1 Roof Slopes 2.25/12 to 7/12 34.8 P&F
 - 6.5.2 Roof Slopes 7/12 to 12/12 21 P&F

It is the sole responsibility of the Contractor and/or Builder to conform to all standards, provisions, requirements, methods of construction and uses of materials provided in buildings and/or structures as required by NC Uniform Building Code, Local Agencies and in accordance with good engineering practices. Verify all dimensions prior to construction.

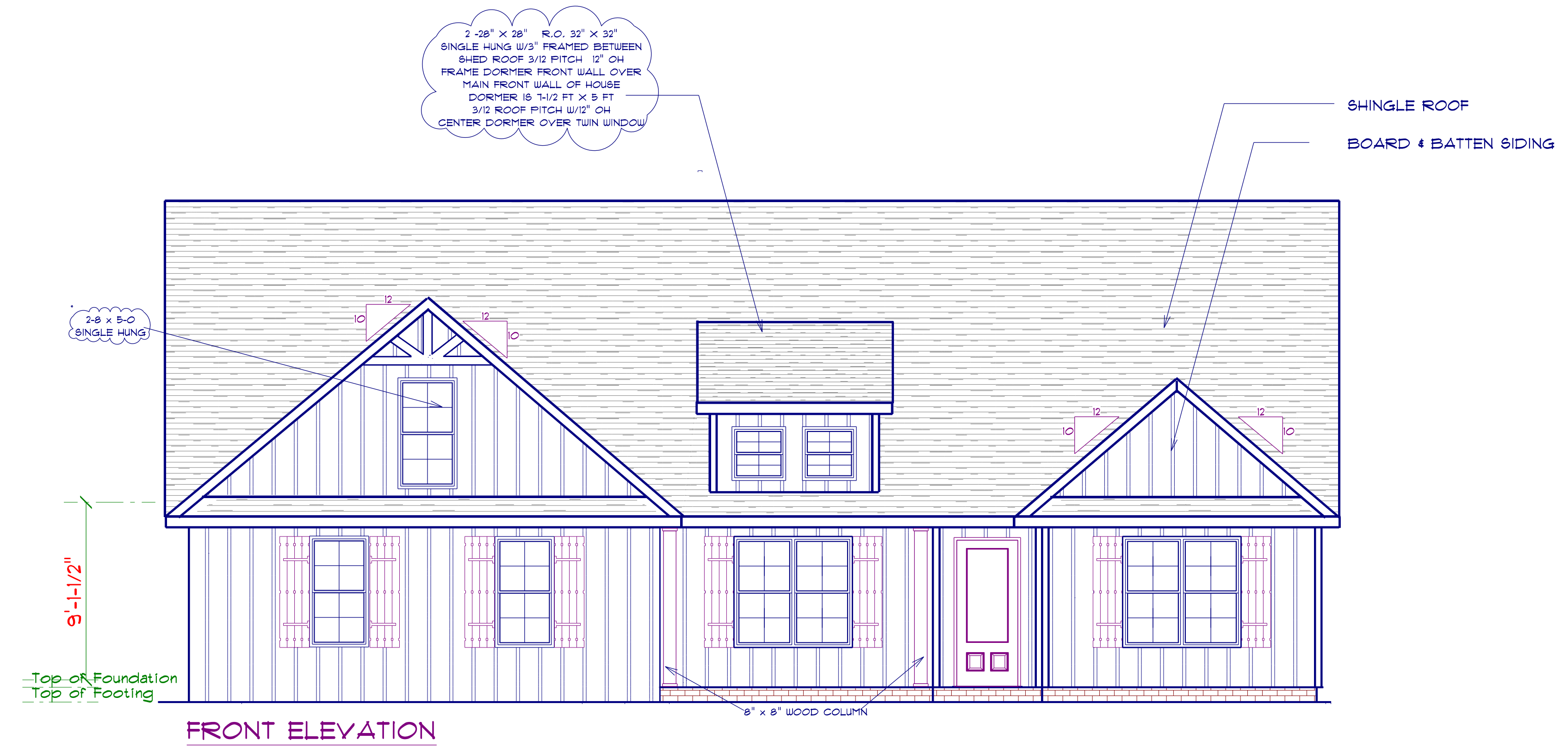

FRONT ELEVATION

AREA SCHEDULE	
NAME	AREA
Heated Floor Area	1717.1 sq. ft.
Garage	489 sq. ft.
Covered Porch	199.2 sq. ft.
Rear Covered Porch	276.3 sq. ft.
Bonus Room	200 sq. ft.

Total Fenestration	Total Exterior Walls	Percentage of wall openings
246 sq. ft.	1752	15%

Above Grade Walls Surrounding Heated Space

FENESTRATION CALCULATIONS			
Floor	Height Of Ext. Wall	Area Of Ext. Wall	Ext. Wall
1st			
2nd			
other	9'	1752	1752
1752		Total Sq. Ft. of Exterior Walls	

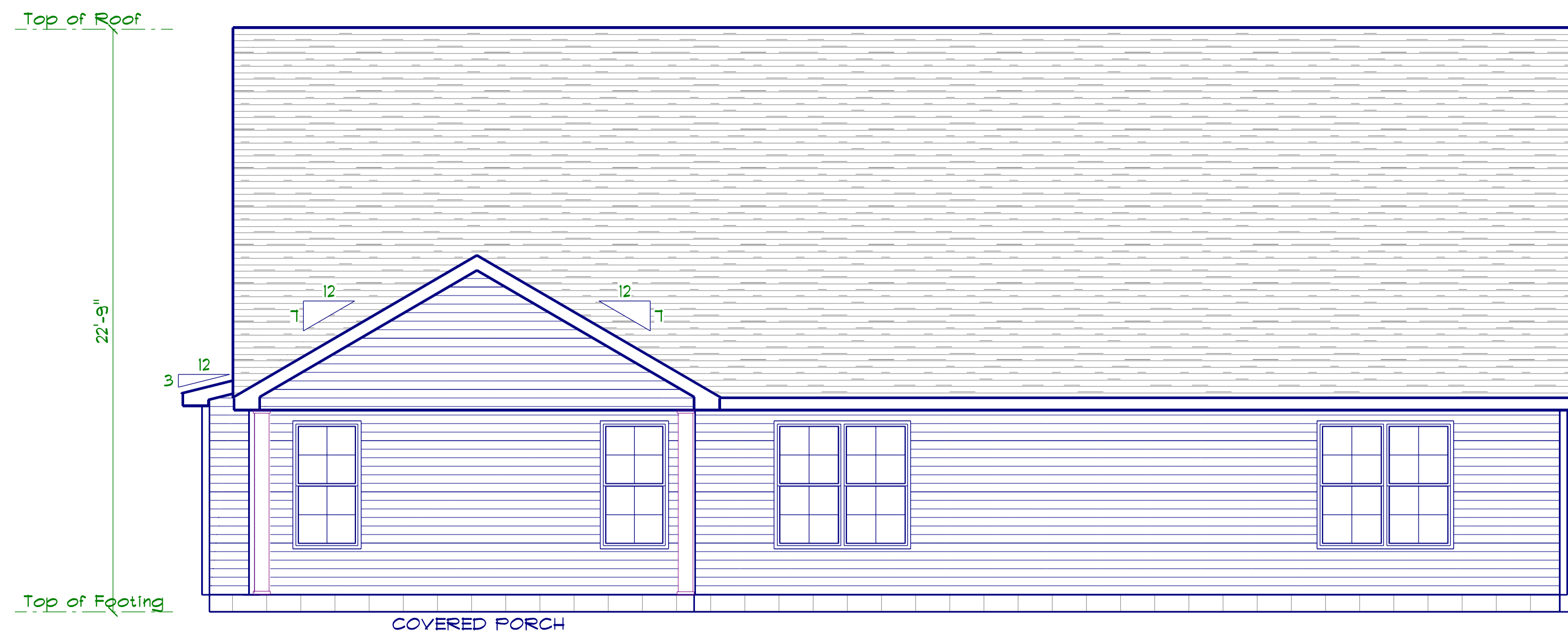

REAR ELEVATION
SCALE: 1" = 1/4"



RIGHT ELEVATION
SCALE: 1" = 1/4"

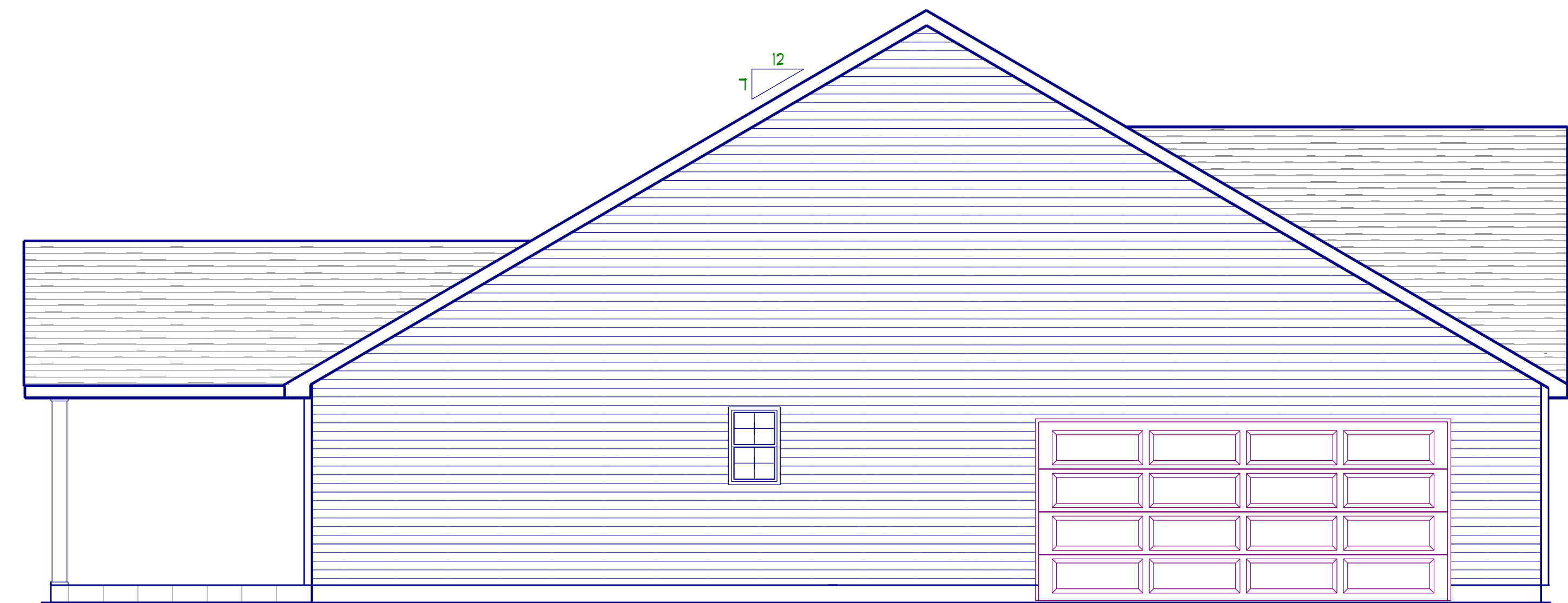

LEFT ELEVATION
SCALE: 1" = 1/4"

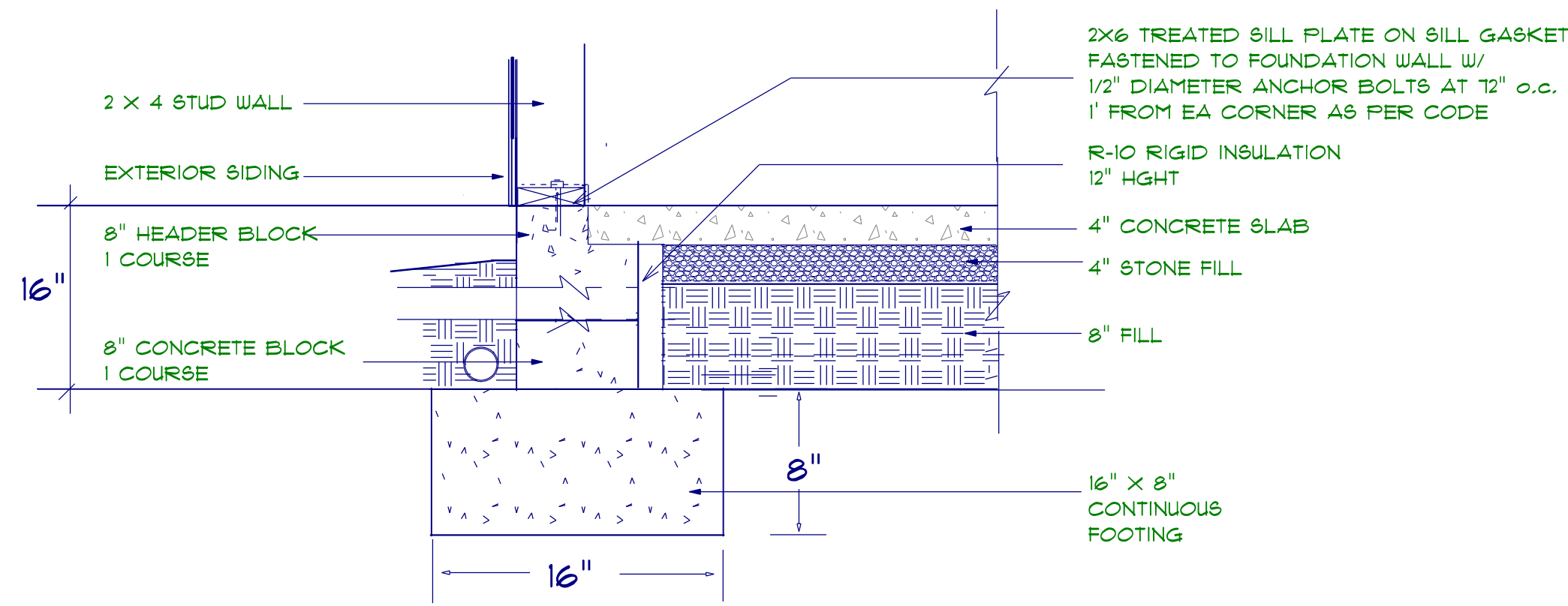

STEM WALL FOUNDATION Detail
not to scale

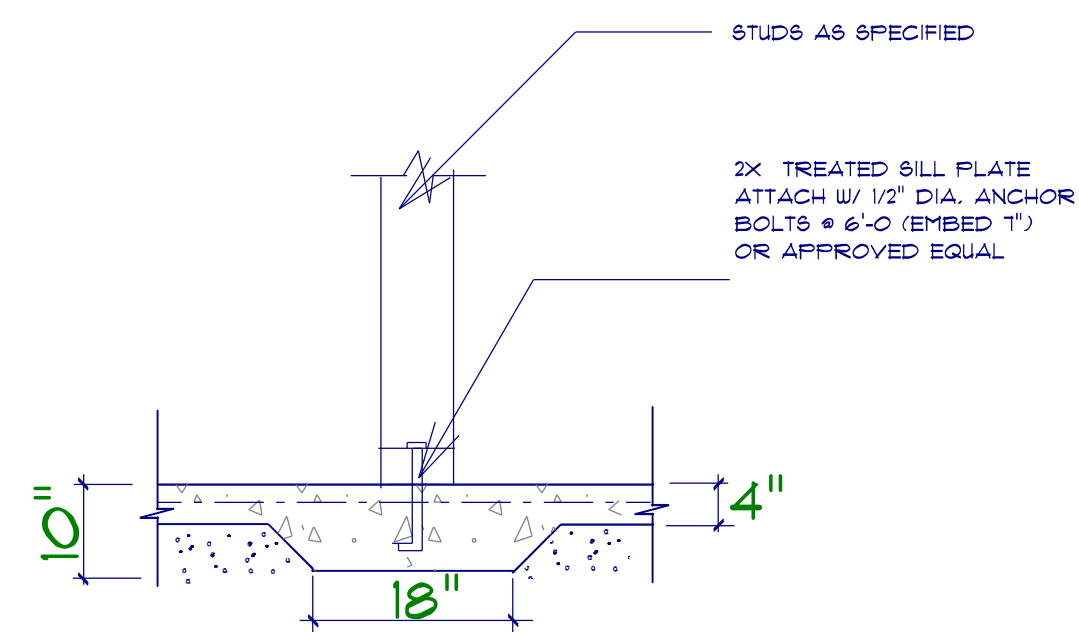

TYPICAL THICKENED SLAB
not to scale

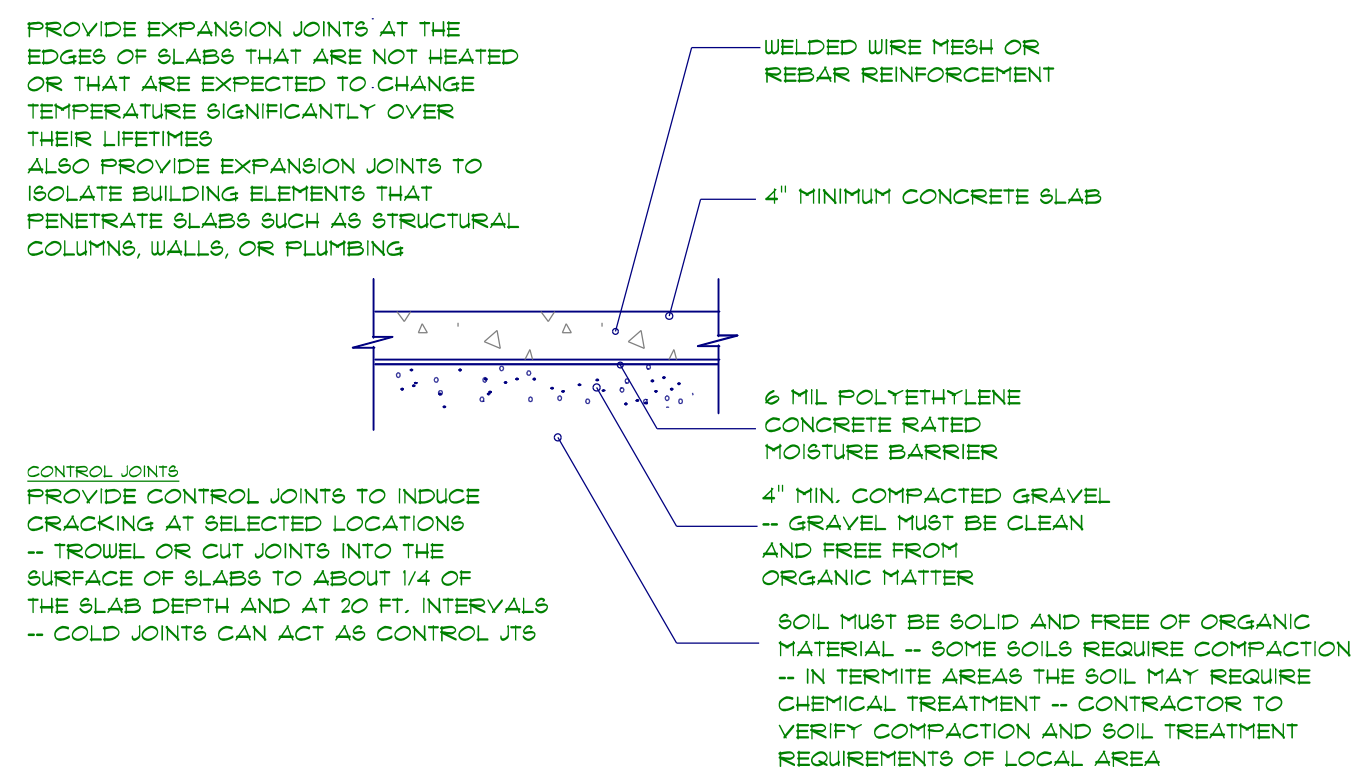

CONCRETE SLAB DETAILS / NOTES
not to scale

FOUNDATION NOTES:
 ALL FOOTINGS SHALL BEAR ON ORIGINAL UNDISTURBED SOIL.
 THE 28 DAY COMPRESSIVE STRENGTH OF ALL FOOTINGS IS 3000 PSI
 PROVIDE WATER PROOFING AND PERIMETER DRAINS AS REQUIRED.
 FOUNDATION CONCRETE MIX TO HAVE 1-1/2" MAX AGGREGATE SIZE. CONCRETE FILL MIX TO HAVE 1/2" MAX AGGREGATE SIZE.
 FOOTING WIDTHS ARE BASED ON A LOAD-BEARING SOIL CAPACITY OF 2000 PSI.
 PROVIDE 6 MIL POLY VAPOR BARRIER TO COVER GROUND SURFACE IN CRAWL SPACE
 ALL ANCHOR BOLTS TO BE 12" LONG, 1/2" DIA. A36 UNO ANCHOR BOLTS SHALL BE SPACE AT A MAX OF 6' OC AND NO MORE THAN 1' FROM EA CORNER.

Termite Soil Treatment: Treat entire slab area soil or crawl space surface before vapor barrier is installed and slab is poured with a state approved termiticide. Termiticide should be applied by a licensed and certified pest control professional by the state of North Carolina.

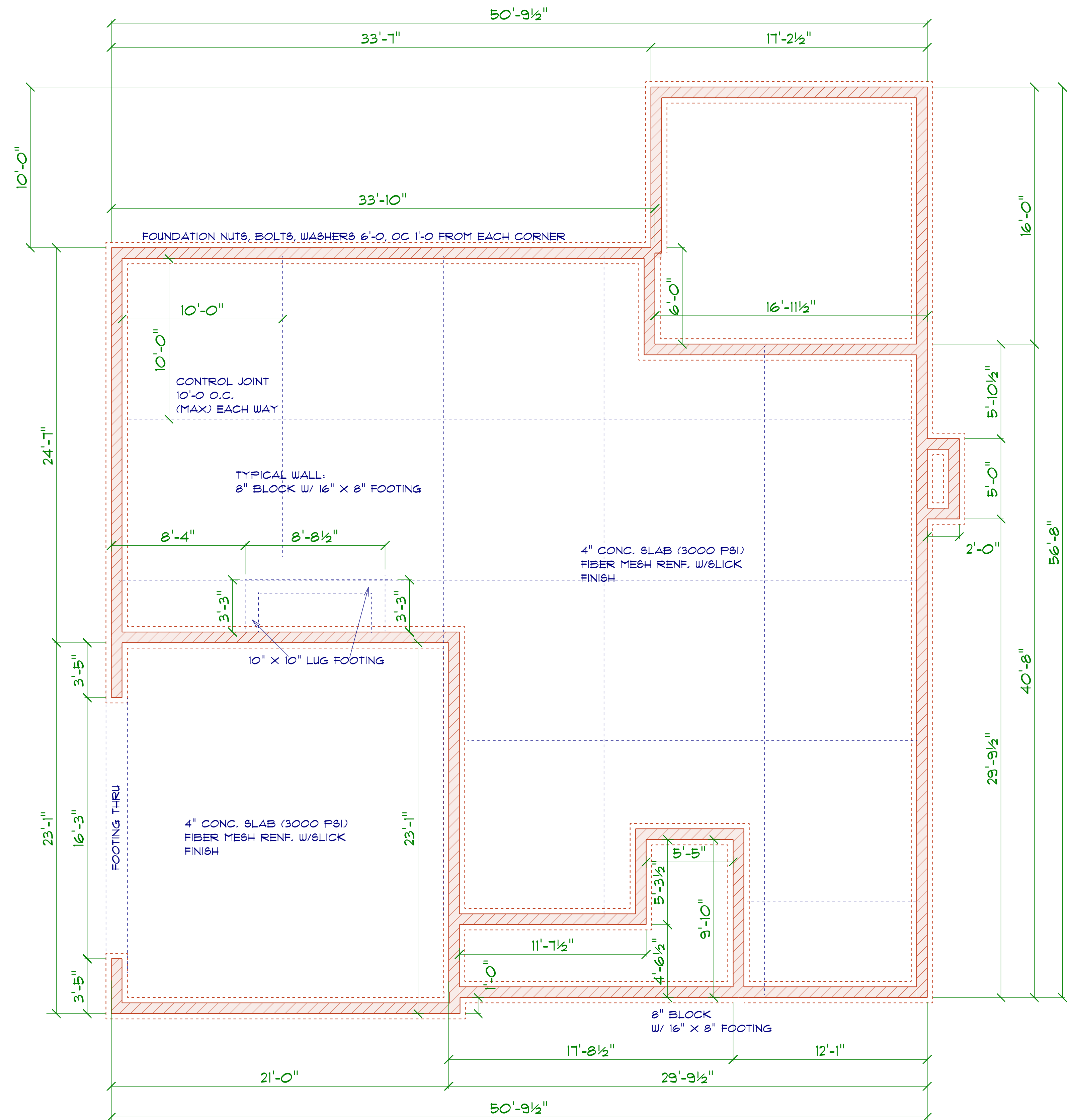

FOUNDATION PLAN
SCALE: 1" = 1/4"

OPENING SCHEDULE				
SIZE	COUNT	LIBRARY NAME	R.O. WIDTH	R.O. HEIGHT
2'-8" x 5'-0"	5	Window/Single Hung	32"	60"
2'-8" x 5'-0" Dbl	5	Window/Single Hung	64-1/2"	60"
2'-0" x 3'-0"	2	Window/Single Hung	24"	36"
2'-4" x 3'-0"	1	Window/Single Hung	28"	36"

GENERAL FRAMING NOTES:

ALL LUMBER IN CONTACT WITH CONCRETE OR MASONRY SHALL BE PRESSURE TREATED

FRAMING LUMBER SHALL BE SYP #2 GRADE AND/OR SPRUCE PINE FIR #1 AND/OR #2, KILN DRIED.

WHERE PRE-ENGINEERED JOISTS ARE USED, JOIST MANUFACTURER SHALL PROVIDE SHOP DRAWINGS, WHICH BEAR SEAL OF A N.C. ENGINEER.

STUDS AND JOISTS SHALL NOT BE CUT TO INSTALL PLUMBING OR WIRING WITHOUT ADDING METAL OR WOOD SIDE PANELS TO STRENGTHEN THE MEMBER TO ITS ORIGINAL CAPACITY.

NAIL MULTIPLE MEMBERS WITH 2 ROWS OF 16d NAILS STAGGERED 32" OC AN USE 3-16d NAILS 2" IN AT EACH END. DOUBLE ALL STUDS UNDER ROOF FOOT DOWS UNO.

NAIL FLOOR JOISTS TO BILL PLATE WITH 8d TOE NAILS.

ALL EXPOSED FRAMING ON PORCHES AND DECKS SHALL BE PRESSURE TREATED.

PROVIDE WATERPROOFING AND DRAINS AS REQUIRED.

ALL FRAMING TO BE 16" OC UNO. WALL FRAMING DIMENSIONS ARE BASED ON 2 X 4 STUDS UNO. DOUBLE STUDS UNDER ALL HEADERS.

LVL'S AND TJS TO BE SIZED BY OTHERS

EXTERIOR WALLS IN LIVING AREAS ARE 2 X 4

It is the sole responsibility of the Contractor and/or Builder to conform to all standards, provisions, requirements, methods of construction and uses of materials provided in buildings and/or structures as required by NC Uniform Building Code, Local Agencies and in accordance with good engineering practices. Verify all dimensions prior to construction.

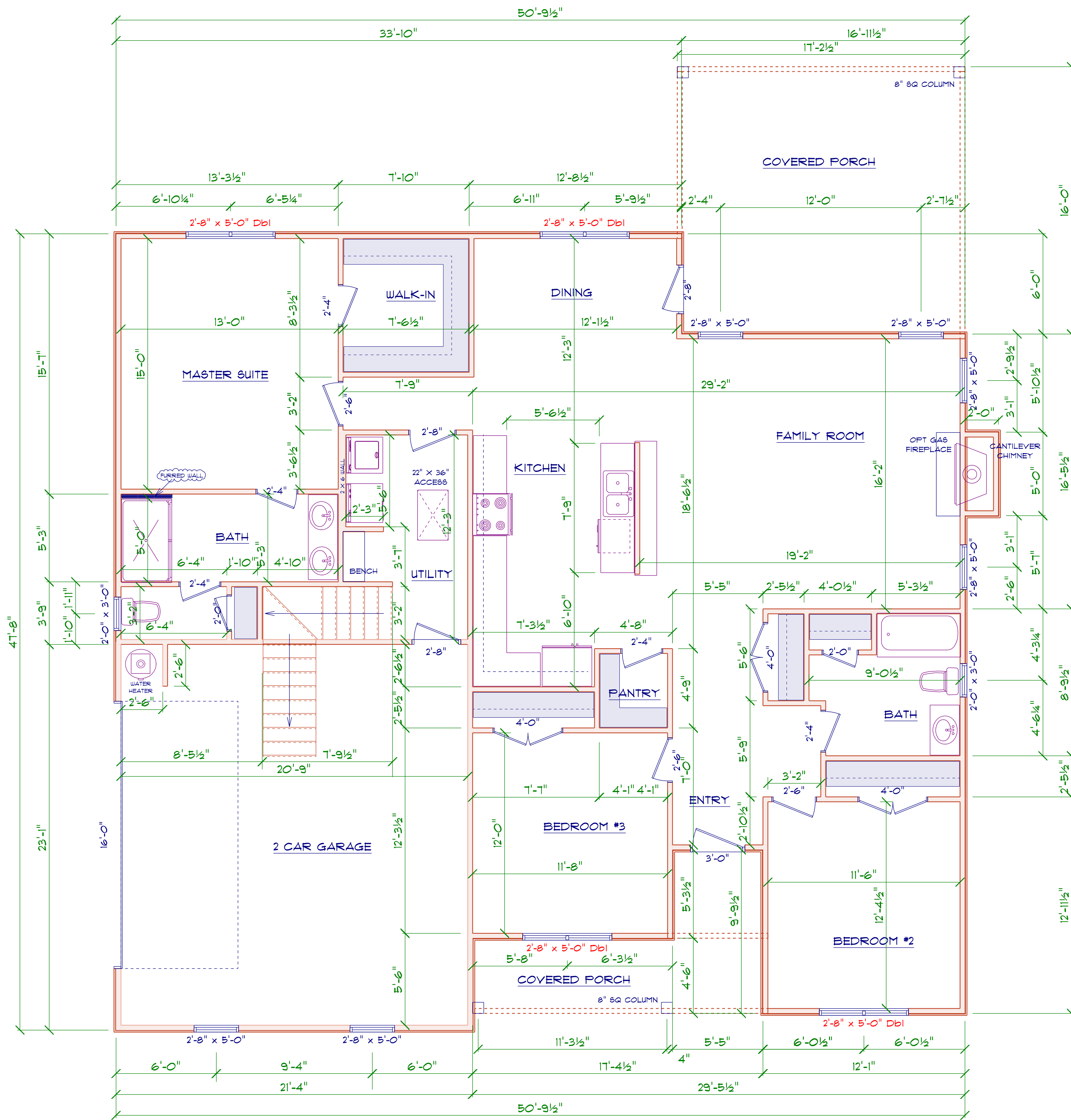

FLOOR PLAN
SCALE: 1" = 1/4"

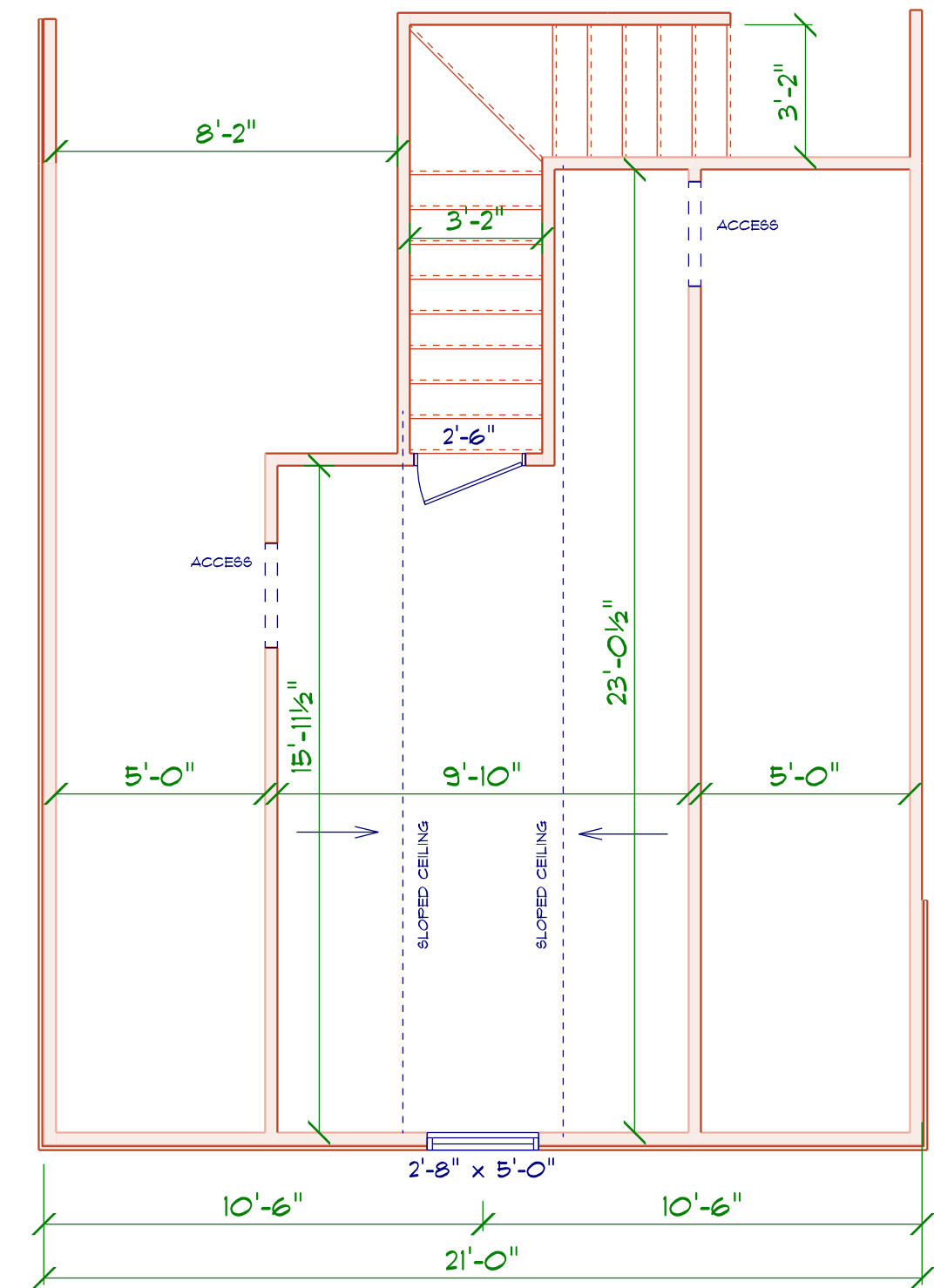

BONUS ROOM FLOOR PLAN
SCALE: 1" = 1/4"

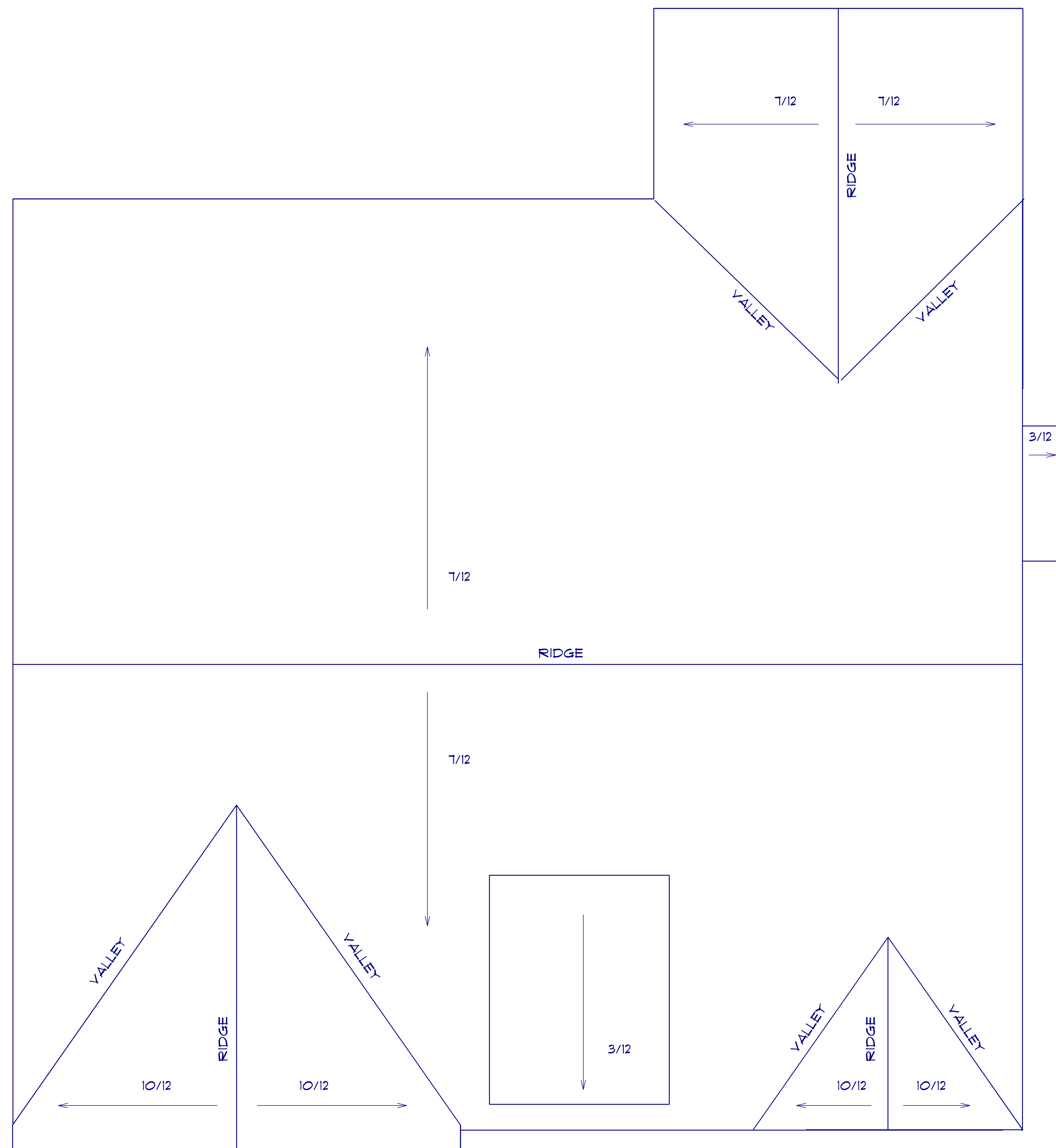

ROOF PLAN
SCALE: 1" = 3/16"
12" OH ALL

ROOF NOTES:

TRUSSES, BRACINGS, BRIDGING AND CONNECTORS ARE TO BE DESIGNED BY THE TRUSS MANUFACTURER.

IDENTIFY LUMBER BY OFFICIAL GRADE MARKINGS.





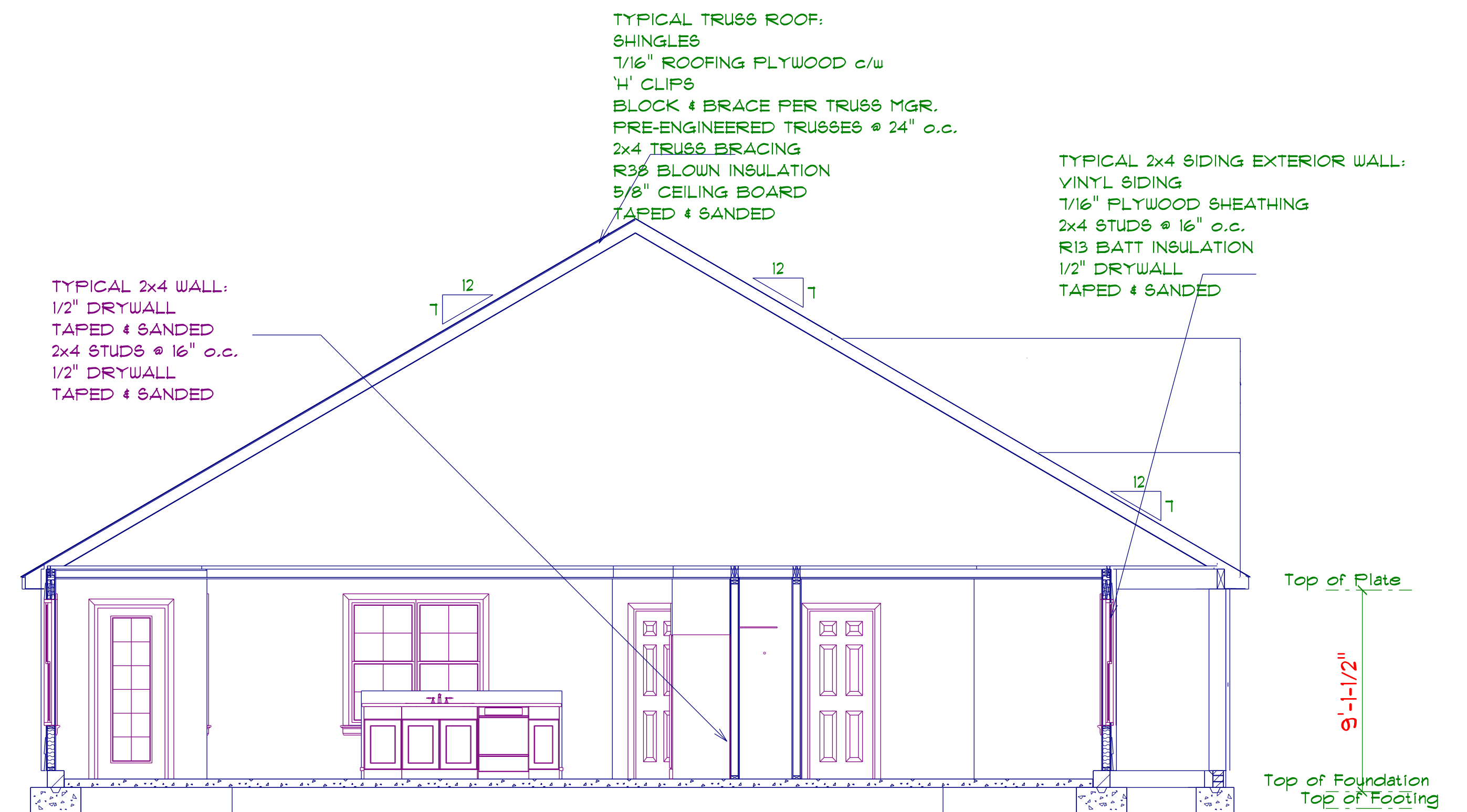

DO NOT CUT OR REMOVE CHORDS OR OTHER TRUSS MEMBERS. DO NOT NOTCH OR DRILL TRUSS MEMBERS.

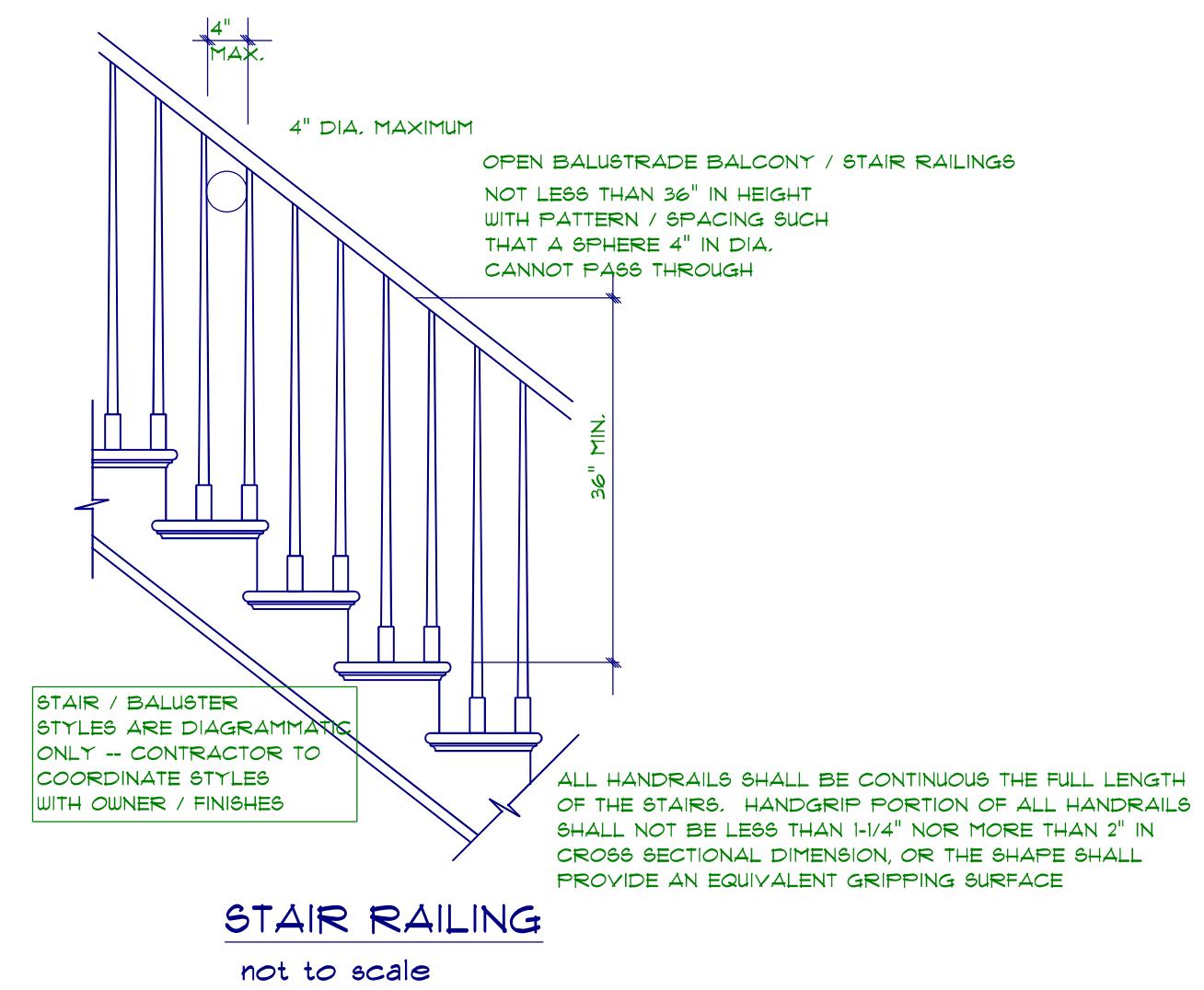
WHERE PRE-ENGINEERED ROOF TRUSSES ARE USED, TRUSS MANUFACTURER SHALL PROVIDE SHOP DRAWINGS, WHICH BEAR SEAL OF A N. C. REGISTERED ENGINEER.

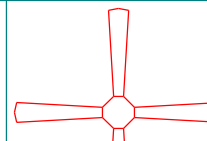

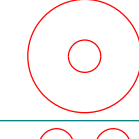
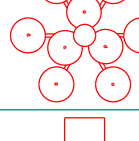
SECTION
SCALE: 1" = 1/4"



ELECTRICAL LEGEND		
ELECTRICAL	COUNT	SYMBOL
ceiling fan	2	
10" led	6	
7" led	12	
foyer light	1	
dinning room light	1	
coach light	2	
exterior over head light	2	
flood light	2	
vanity bar light	3	

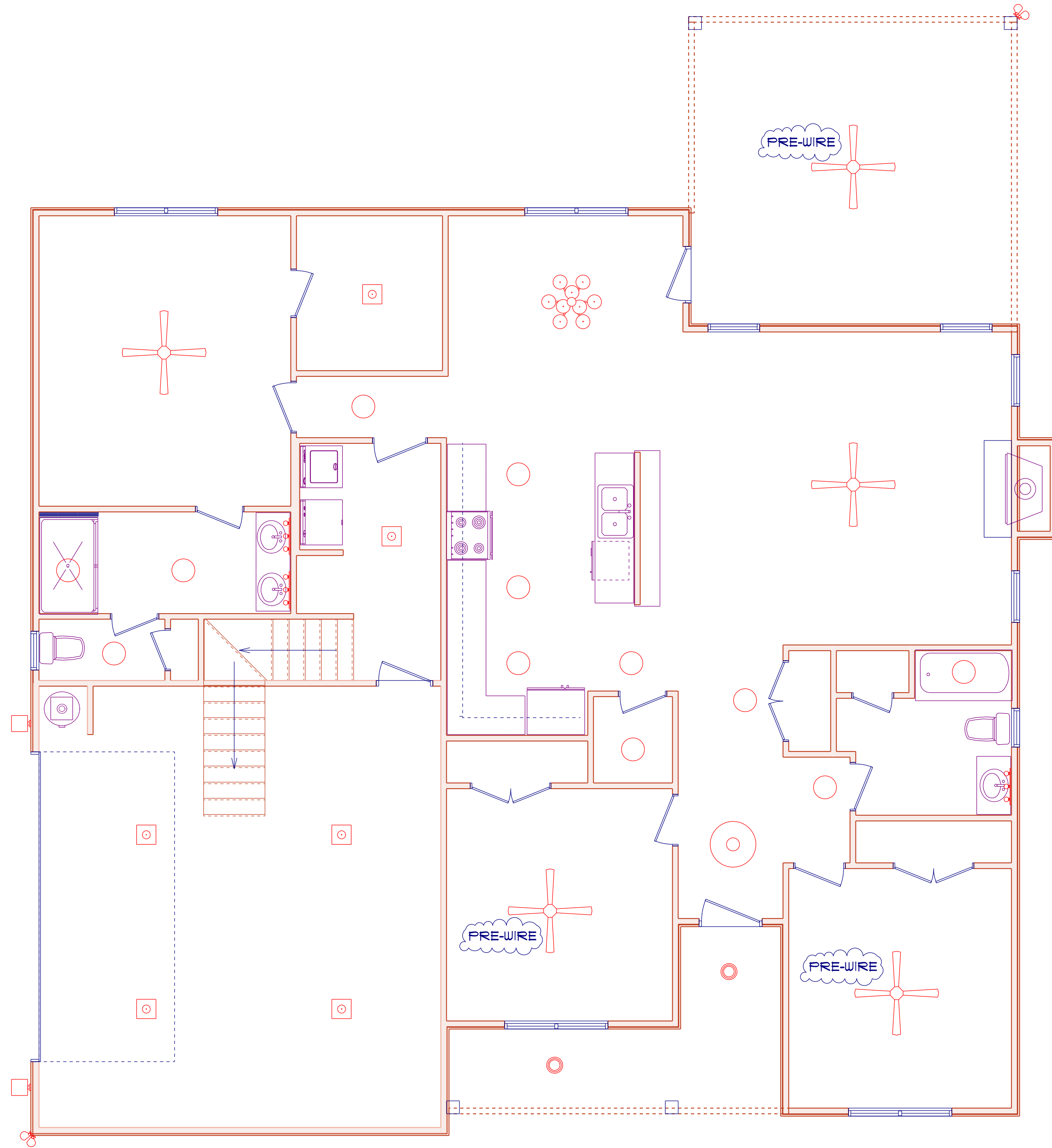

FLOOR PLAN

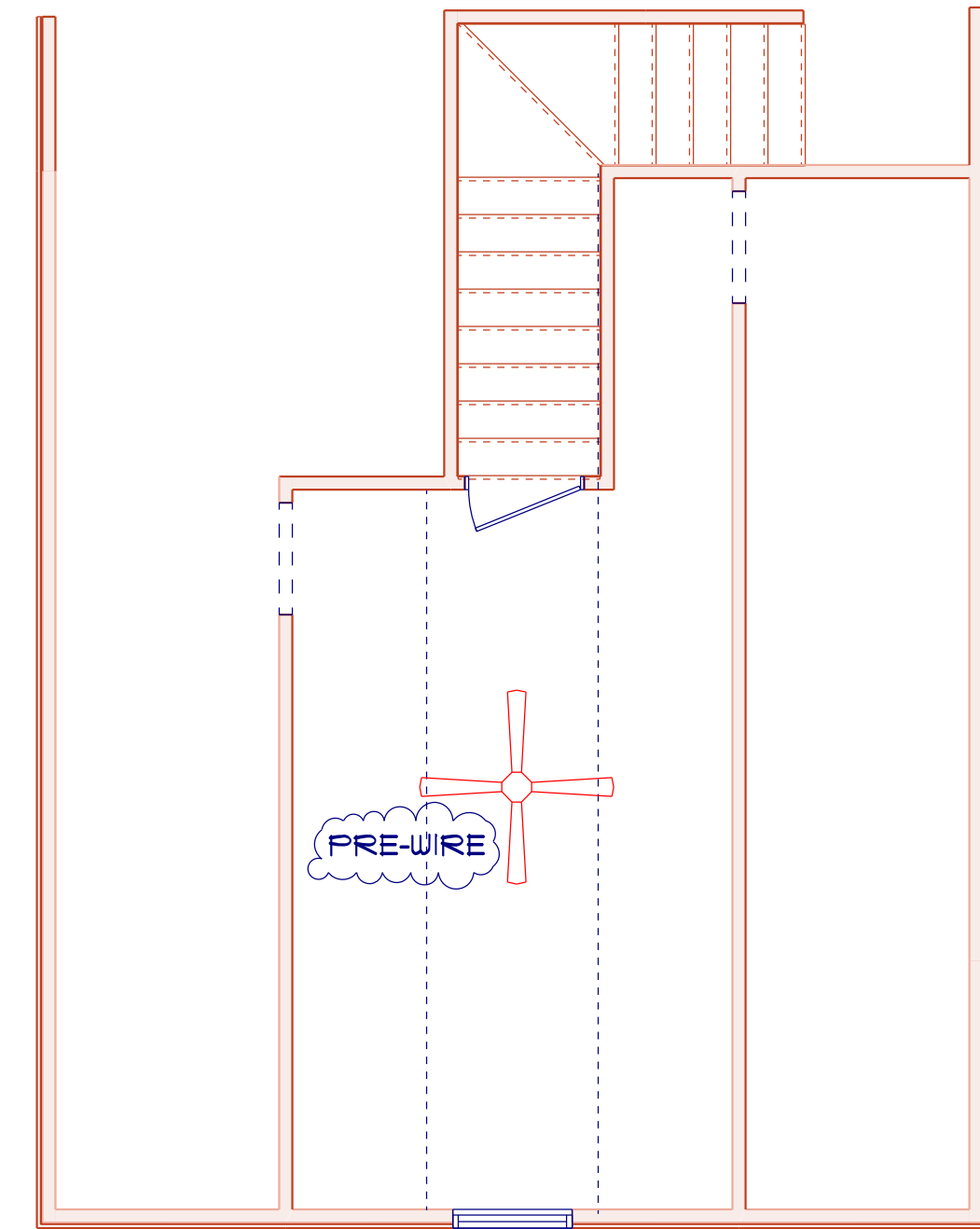

BONUS ROOM FLOOR PLAN

<u>KITCHEN</u>	SINK	15'-7" BACK
		20'-0" SIDE
<u>MAIN</u>	17'-8" SIDE	
	14'-11" FRONT	
<u>HALL BATH</u>	VANITY	0'-3" SIDE
		16'-8" FRONT
	TOILET	1'-4" SIDE
		19'-11" FRONT
	TUB	4'-8" SIDE
		22'-8" FRONT
<u>LAUNDRY</u>	13'-7" SIDE	
		15'-10" BACK
<u>MASTER BATH</u>	VANITY	13'-7" SIDE
		18'-3" BACK
	TOILET	1'-4" SIDE
	SHOWER	2'-0" OR 1'-9" SIDE
		18'-4" BACK

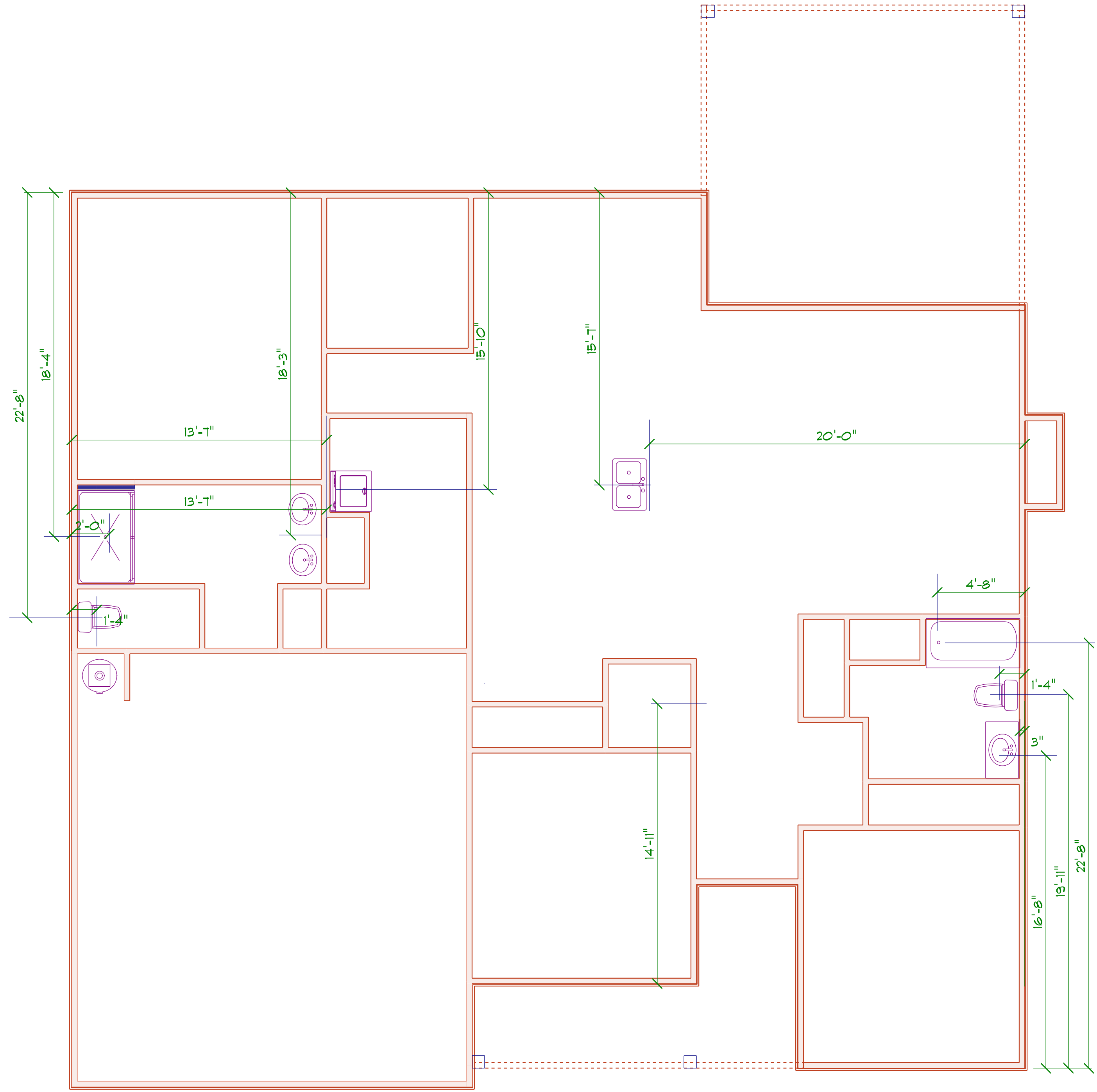

FLOOR PLAN
SCALE: 1" = 1/4"