



1731 Round Rock Drive, Raleigh, NC 27615 • (919) 872-3250 • fax (919) 877-5775 • www.flssamerica.com

OAKHAVEN LOT 7

FIRE SPRINKLER PRODUCT DATA

8/25/2021

Steel Pipe Submittal Data for Fire Sprinkler System

See Chart For Inside Diameters and Wall Thickness

All piping to be one or more of the following: (Refer to checked for submittal items).

- Schedule 40 Steel pipe conforming to ASTM A-135 or A-795 using Cast Iron, Malleable Iron or Ductile Iron screw fittings in accordance with standard ANSI B16.3 or ANSI B16.4. Pipe may also be joined by grooved fittings approved for fire protection use.
- Schedule 7 or 10 Steel Pipe conforming to ASTM A-135 or A-795 using grooved fittings listed for fire protection use.
- All welding will comply with the applicable requirements of AWS B2.1, Specification for Welding Procedure and Performance Qualification. This will be limited to pipe outlets and flanged end treatments.

All materials to be used in the installation of sprinkler system are to conform to NFPA 13, Local Authorities Having Jurisdiction and any applicable referenced codes and standards.

Steel Pipe Dimensions per NFPA 13:

Pipe		Sch 40		Sch 10		Sch 07	
Nom. Dia.	O.D (in)	I.D. (in)	Wall (in)	I.D. (in)	Wall (in)	I.D. (in)	Wall (in)
1"	1.315	1.049	0.133	1.097	0.109	n/a	n/a
1¼"	1.660	1.380	0.140	1.442	0.109	1.536	0.062
1½"	1.900	1.610	0.145	1.682	0.109	1.728	0.086
2"	2.375	2.067	0.154	2.157	0.109	2.203	0.086
2½"	2.875	2.469	0.203	2.635	0.120	2.703	0.086
3"	3.500	3.068	0.216	3.260	0.120	3.314	0.093
4"	4.500	4.026	0.237	4.260	0.120	4.310	0.095
6"	6.625	6.065	0.280	6.357	0.134	n/a	n/a
8"	8.625	7.981	0.322	8.249	0.188	n/a	n/a
10"	10.750	10.020	0.365	n/a	n/a	n/a	n/a
12"	12.750	11.938	0.406	n/a	n/a	n/a	n/a

This submittal shall include the following checked items.

	<i>Domestic</i>	<i>Foreign</i>
Origin of Manufacture	<input checked="" type="checkbox"/>	<input type="checkbox"/>

	<i>Black</i>	<i>Galvanized</i>
Exterior Finish	<input checked="" type="checkbox"/>	<input type="checkbox"/>

	<i>Sch. 40</i>	<i>Sch. 10</i>	<i>Sch. 7</i>
Schedule	<input checked="" type="checkbox"/>	<input type="checkbox"/>	<input type="checkbox"/>

	<i>A-135</i>	<i>A-795</i>	<i>A-53</i>
ASTM	<input checked="" type="checkbox"/>	<input type="checkbox"/>	<input type="checkbox"/>



Submittal Data CPVC Pipe and Fittings

Listings:

- Light hazard occupancies as defined in the standard for “Installation of Sprinkler Systems”, NFPA 13.
- Residential occupancies as defined in the standard for “Installation of Sprinkler Systems in Residential Occupancies up to and Including Four Stories in Height”, NFPA 13R.
- Residential occupancies as defined in the standard for “Installation of Sprinkler Systems in One and Two Family Dwellings and Manufactured Homes”, NFPA 13D. - Underground fire service systems as described in the “Installation of Sprinkler
- Systems”, NFPA 13 2007 Edition, and where appropriate the “Standard for Installation of Private Service Mains & Their Appurtenances”, NFPA 24
- Local Authorities having jurisdiction and any applicable referenced
- codes and standards.

Approvals:

UL, FM, CUL, NSF, Dade County, LPCB, MEA, and the City of Los Angeles.

Material Specifications:

Pipe: ASTM F442, SDR 13.5

Fittings: ASTM F438, (Sch. 40) and ASTM F439 (Sch. 80)

Maximum Working Pressure of 175 PSI



Straight Elbow



Reducing Elbow



Straight Tee



Reducing Tee



Cross



Reducing Cross



45 Elbow



Coupling



Sprinkler Adapter
w/ Brass Insert



Slip-Thread Adapter



Sprinkler Head Adapter 90° Ell



Sprinkler Head Adapter Tee



Back-to-Back Tee



Grooved Coupling Adapter



Reducer Bushing



Cap

CPVC Pipe Submittal Data for Fire Sprinkler Systems

All material used in the installation of the sprinkler system conforms to:

NFPA 13

NFPA 13R

NFPA 13D



- All CPVC piping should be pressure tested at 200 PSI for 2 hours.
- Chemical compatibility should be checked per manufacturer.
- Glycerin antifreeze solutions are acceptable and installation of antifreeze systems should comply with NFPA Section 7.6.2 of NFPA 13 (2007 Edition).

BlazeMaster® Pipe Dimensions and Weights SDR 13.5 (ASTM F 442)									
Nominal Size		Average OD		Average ID		Pounds Per Foot	Kilograms Per Meter	Pounds Per Foot	Kilograms Per Meter
Inches	mm	Inches	mm	Inches	mm	Empty	Empty	H ₂ O Filled	H ₂ O Filled
3/4	20.0	1.050	26.7	.874	22.2	0.168	0.250	0.428	0.637
1	25.0	1.315	33.4	1.101	28.0	0.262	0.390	0.675	1.005
1 1/4	32.0	1.660	42.2	1.394	35.4	0.418	0.622	1.079	1.606
1 1/2	40.0	1.900	48.3	1.598	40.6	0.548	0.816	1.417	2.109
2	50.0	2.375	60.3	2.003	50.9	0.859	1.278	2.224	3.310
2 1/2	65.0	2.875	73.0	2.423	61.5	1.257	1.871	3.255	4.844
3	80.0	3.500	88.9	2.950	75.0	1.867	2.778	4.829	7.186

Note: The above average OD and average ID information is per ASTM F442. Check with individual manufacturers for actual OD and ID information.

Allowance for Friction Loss in Fittings (Equivalent Feet of Pipe)								
Fitting Size (In.)	3/4"	1"	1 1/4"	1 1/2"	2"	2 1/2"	3"	
Tee Branch	3	5	6	8	10	12	15	
Elbow 90° *	4	5	6	7	9	12	13	
Elbow 45°	1	1	2	2	2	3	4	
Coupling	1	1	1	1	1	2	2	
Tee Run	1	1	1	1	1	2	2	

Submittal Data for CPVC Strap Hangers

All materials to be used in the installation of sprinkler system are to conform to NFPA 13, 13R and 13D, Local Authorities having Jurisdiction and any applicable referenced codes and standards.

UL Listed in the USA and Canada to support fire sprinkler piping.

- A “one-hole strap” can function as a hanger and restraining device. It supports CPVC pipe horizontally from top or side of beam. As a restraining device, the hanger will be inverted so the fastener is downward. This installation will prevent upward movement of the sprinkler during activation.
- A “two-hole strap” can function as a hanger and restraining device. It supports CPVC pipe horizontally from top, bottom, or side of beam. A hex-head self-threading screw (furnished with most CPVC hangers) is easily installed using an electric drill. No pre-drilling pilot hole is required.
- A “side-mount strap” supports the CPVC pipe horizontally from top or bottom of beam
- A “stand-off 2-hole strap” supports the CPVC pipe off of the vertical face of the structural or composite wood joists.

Hangers must be clean, free of burrs, and all surface oils. Any contaminants must be removed from the hanger.

The pipe size of the hanger shall be the same size as the supported pipe.

Pipe hangers must have a load bearing surface at least ½” inch wide.

Examples of CPVC Hangers

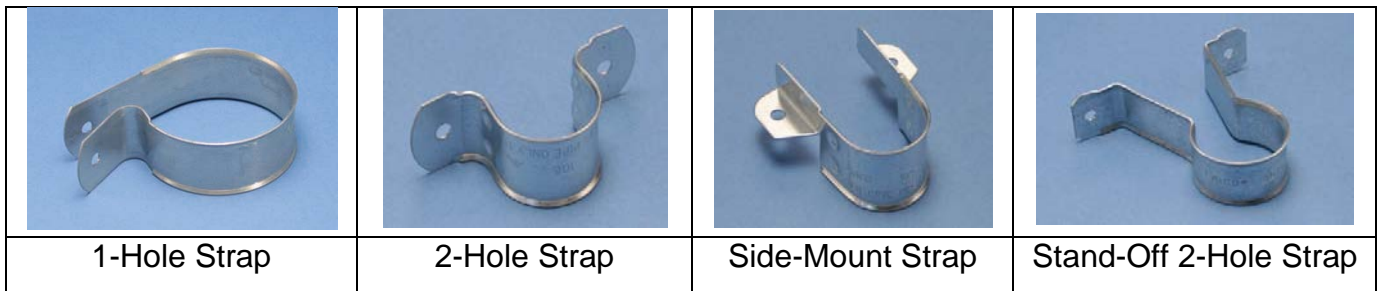

This submittal shall include the following checked items:

Product	
<input type="checkbox"/>	¾” Hangers
<input checked="" type="checkbox"/>	1” Hangers
<input type="checkbox"/>	1-1/4” Hangers
<input type="checkbox"/>	1-1/2” Hangers
<input type="checkbox"/>	2” Hangers

Origin of Manufacture	
Domestic	Foreign
<input checked="" type="checkbox"/>	<input type="checkbox"/>



TECHNICAL DATA

FREEDOM® RESIDENTIAL CONCEALED PENDENT SPRINKLER VK494 (K4.9)

The Viking Corporation, 210 N Industrial Park Drive, Hastings MI 49058

Telephone: 269-945-9501 Technical Services: 877-384-5464 Fax: 269-818-1680 Email: techsvcs@vikingcorp.com

Visit the Viking website for the latest edition of this technical data page www.vikinggroupinc.com

1. DESCRIPTION

Viking Freedom® Residential Concealed Pendent Sprinkler VK494 is a small thermosensitive, glass-bulb residential sprinkler designed for installation on concealed pipe systems where the appearance of a smooth ceiling is desired. The orifice design, with a K-factor of 4.9 (70.6 metric*), allows the sprinkler's efficient use of available water supplies for the hydraulically designed fire-protection system. The fast response glass bulb operating element and special deflector characteristics meet the challenges of residential sprinkler standards.

The sprinkler is pre-assembled with a threaded adapter for installation with a low-profile small-diameter cover assembly installed flush to the ceiling. The two-piece design allows installation and testing of the sprinkler prior to installation of the cover plate. The "push-on" and "thread-on" designs of the concealed cover plate assemblies allow easy installation of the cover plate after the system has been tested and the ceiling finish has been applied, while also providing up to 1/2" (13 mm) of vertical adjustment. The cover assembly can be removed and reinstalled, allowing temporary removal of ceiling panels without taking the sprinkler system out of service or removing the sprinkler. The Electroless Nickel PTFE (ENT) coating has been investigated for installation in corrosive atmospheres and is C-UL-US-EU Listed as indicated in the Approval Charts. The ENT finish is only available for the sprinkler assembly, the cover plate is not plated.

2. LISTINGS AND APPROVALS



cULusEU Listed: Category VKKW

Refer to the Approval Charts and Design Criteria for C-UL-US-EU Listing requirements that must be followed.

3. TECHNICAL DATA

Specifications:

Minimum Operating Pressure: Refer to the Approval Chart.

Maximum Working Pressure: 175 psi (12 bar). Factory tested hydrostatically to 500 psi (34.5 bar).

Thread size: 1/2" (15 mm) NPT

Nominal K-factor: 4.9 U.S. (70.6 metric*)

Glass-bulb fluid temperature rating: to -65 °F (-55 °C)

* Metric K-factor measurement shown is in Bar. When pressure is measured in kPa, divide the metric K-factor shown by 10.0.

Material Standards:

Sprinkler Body: Brass UNS-C84400 or QM Brass

Deflector: Phosphor Bronze UNS-C51000

Deflector Pins: Stainless Steel UNS-S30200

Button: Brass UNS-C36000

Pip Cap and Insert Assembly: Copper UNS-C11000 and Stainless Steel UNS-S30400

Compression Screw: 18-8 Stainless Steel

Yoke: Phosphor Bronze UNS-C51000

Belleville Spring Sealing Assembly: Beryllium Nickel Alloy, coated on both sides with PTFE Tape

Cover Adapter: Cold Rolled Steel UNS-G10080, Finish: Clear Chromate over Zinc Plating

Shipping Cap: High Density Polyethylene

Cover Plate Materials:

Cover Plate Assembly: Copper UNS-C11000 and Brass UNS-C26800 or Stainless Steel UNS-S30400

Spring: Beryllium Nickel

Solder: Eutectic

Ordering Information: The sprinkler and cover plate must be ordered separately. Refer to Tables 1 and 2.

4. INSTALLATION

Refer to appropriate NFPA Installation Standards.

5. OPERATION

During fire conditions, when the temperature around the sprinkler approaches the cover plate's nominal temperature rating, the cover plate detaches and releases the deflector. Continued heating of the exposed sprinkler causes the heat-sensitive liquid in the glass bulb to expand. When the temperature reaches the sprinkler's nominal temperature rating, the glass bulb shatters releasing the yoke, pip cap assembly and sealing spring. Water begins flowing through the sprinkler orifice and strikes the deflector forming a uniform spray pattern over a specific area of coverage, which is determined by the water supply pressure at the sprinkler, in order to extinguish or control the fire.

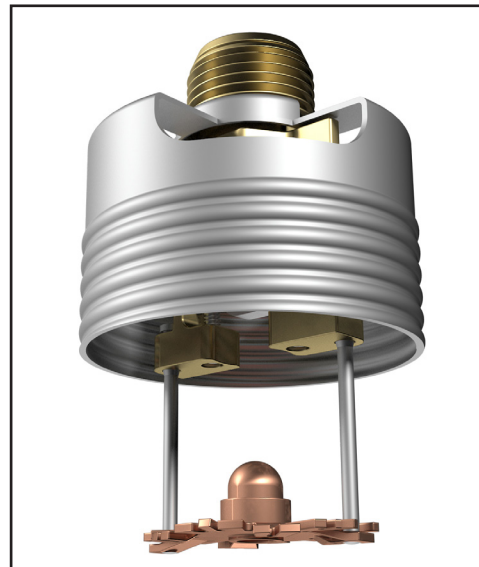

WARNING: Cancer and Reproductive Harm-
www.P65Warnings.ca.gov



TECHNICAL DATA

FREEDOM® RESIDENTIAL CONCEALED PENDENT SPRINKLER VK494 (K4.9)

The Viking Corporation, 210 N Industrial Park Drive, Hastings MI 49058
 Telephone: 269-945-9501 Technical Services: 877-384-5464 Fax: 269-818-1680 Email: techsvcs@vikingcorp.com
 Visit the Viking website for the latest edition of this technical data page www.vikinggroupinc.com

6. INSPECTIONS, TESTS AND MAINTENANCE

Refer to NFPA 25 for Inspection, Testing and Maintenance requirements.

7. AVAILABILITY

Viking Sprinkler Model VK494 is available through a network of domestic and international distributors. See The Viking Corporation web site for the closest distributor or contact The Viking Corporation.

8. GUARANTEE

For details of warranty, refer to Viking's current list price schedule or contact Viking directly.

TABLE 1: SPRINKLER ORDERING INFORMATION

Instructions:

- (1) Select a Sprinkler Base Part Number
- (2) Add the suffix for the desired Finish
- (3) Add the suffix for the desired Sprinkler Temperature Rating
- (4) Order a cover plate (refer to Table 2)

Example:

20759AE = 200 °F (93 °C) Temperature Rated Sprinkler with a standard Brass finish.

Sprinkler Base Part Number ¹	Size	1: Finishes		2: Temperature Ratings ⁷			
	NPT Inch	Description	Suffix	Nominal Rating	Bulb Color	Max. Ambient Ceiling Temperature ²	Suffix
20759	1/2	Brass	A	155 °F (68 °C)	Red	100 °F (38 °C)	B
		ENT ^{5,6}	JN	200 °F (93 °C)	Green	150 °F (65 °C)	E
		Corrosion Resistant Sprinkler Finish: ENT					

Accessories

Sprinkler Wrenches and tools:

- A. Heavy Duty Part Number: 14047W/B³ (available since 2006)
- B. Head Cabinet Wrench Part Number: 14031^{3,4} (available since 2006)
- C. Optional Concealed Cover Plate Installer Tool Part Number: 14412⁸ (available since 2007)
- D. Optional Large Concealed Cover Plate Installer Tool Part No. 14867⁸ (available since 2007)

Sprinkler Cabinet:

Holds up to 6 sprinklers: Part number 01731A (available since 1971).

Footnotes

1. Part number shown is the base part number. For complete part number, refer to the current Viking price list schedule.
2. Based on NFPA 13, NFPA 13R, and NFPA 13D. Other limits may apply, depending on fire loading, sprinkler location, and other requirements of the Authority Having Jurisdiction. Refer to specific installation standards.
3. Requires a 1/2" ratchet (not available from Viking).
4. Also optional for removal of the protective cap. Ideal for sprinkler cabinets.
5. cULus Listed as corrosion resistant.
6. The corrosion resistant coatings have passed the standard corrosion test required by the approving agencies indicated in the Approval Charts. These tests cannot and do not represent all possible corrosive environments. Prior to installation, verify through the end-user that the coatings are compatible with or suitable for the proposed environment. For automatic sprinklers, the ENT coating is applied to all exposed exterior surfaces, including the waterway. For ENT coated sprinklers, the Belleville spring is exposed.
7. The sprinkler temperature rating is stamped on the deflector.
8. The installer tool is for push-on style cover plates only.



TECHNICAL DATA

FREEDOM® RESIDENTIAL CONCEALED PENDENT SPRINKLER VK494 (K4.9)

The Viking Corporation, 210 N Industrial Park Drive, Hastings MI 49058
 Telephone: 269-945-9501 Technical Services: 877-384-5464 Fax: 269-818-1680 Email: techsvcs@vikingcorp.com
 Visit the Viking website for the latest edition of this technical data page www.vikinggroupinc.com

TABLE 2: COVER PLATE ORDERING INFORMATION

Instructions:

- (1) Select a Cover Plate Base Part Number
- (2) Add the suffix for the desired Finish
- (3) Add the suffix for the required Cover Plate Nominal Rating.

Example:

23190MC/W = 165 °F (74 °C) Temperature Rated, 2-3/4" (70 mm) diameter, Thread-On style, Round Cover Plate with a Painted White finish.

1: Select a Cover Plate Base Part Number ³						2: Select a Finish	
Thread-On Style			Push-On Style			Description	Suffix ⁵
Base Part Number ¹	Size Inch (mm)	Type	Base Part Number	Size Inch (mm)	Type		
23190	2-3/4 (70)	Round	23447	2-3/4 (70)	Round	Polished Chrome	F
23174	3-5/16 (84)	Round	23463	3-5/16 (84)	Round	Brushed Chrome	F-/B
23179	3-5/16 (84)	Square	23482	3-5/16 (84)	Square	Bright Brass	B
23193 ⁵	2-3/4 (70)	Stainless Steel Round	23455 ⁵	2-3/4 (70)	Stainless Steel Round	Antique Brass	B-/A
						Brushed Brass	B-/B
23183 ⁵	3-5/16 (84)	Stainless Steel Round	23473 ⁵	3-5/16 (84)	Stainless Steel Round	Brushed Copper	E-/B
						Painted White	M-/W
						Painted Ivory	M-/I
						Painted Black	M-/B

3: Temperature Rating Matrix ^{1,2}				
Cover Plate Nominal Rating (Required)	Temperature Classification	Sprinkler Nominal Rating	Sprinkler Maximum Ambient Ceiling Temperature ²	Suffix
135 °F (57 °C)	Ordinary	155 °F (68 °C)	100 °F (38 °C)	A
165 °F (74 °C)	Intermediate	200 °F (93 °C)	150 °F (65 °C)	C

Footnotes

1. Part number shown is the base part number. For complete part number, refer to the current Viking price list schedule.
2. The sprinkler temperature rating is stamped on the deflector.
3. Based on NFPA-13, NFPA 13R, and NFPA 13D. Other limits may apply, depending on fire loading, sprinkler location, and other requirements of the Authority Having Jurisdiction. Refer to specific installation standards.
4. Where a dash (-) is shown in the Finish suffix designation, insert the desired Temperature Rating suffix. See example above.
5. Stainless Steel versions are not available with any finishes or paint.



TECHNICAL DATA

FREEDOM® RESIDENTIAL CONCEALED PENDENT SPRINKLER VK494 (K4.9)

The Viking Corporation, 210 N Industrial Park Drive, Hastings MI 49058
 Telephone: 269-945-9501 Technical Services: 877-384-5464 Fax: 269-818-1680 Email: techsvcs@vikingcorp.com
 Visit the Viking website for the latest edition of this technical data page www.vikinggroupinc.com

Approval Chart Viking VK494, 4.9 K-factor Residential Concealed Pendent Sprinkler

For systems designed to NFPA 13D or NFPA 13R. For systems designed to NFPA 13, refer to the Design Criteria. For Ceiling types refer to current editions of NFPA 13, 13R or 13D

Sprinkler Base Part Number ¹	SIN	NPT Thread Size		Nominal K-factor		Maximum Water Working Pressure
		Inches	mm	U.S.	metric ²	
20759	VK494	1/2	15	4.9	70.6	175 psi (12 bar)
Max. Coverage Area ⁶ W X L Ft. X Ft. (m X m)	Flow GPM (LPM)	Pressure PSI (bar)	Deflector to Ceiling	Installation Type	Listings and Approvals ^{3,5}	Minimum Spacing Ft. (m)
155 °F (68 °C), 200 °F (93 °C) Temperature Rated Sprinklers		Refer to Figure 2			 See Footnotes 8, & 9	
12 X 12 (3.7 X 3.7)	13 (49.2)			7.0 (0.48)		Concealed with Cover Plate Assembly. See Footnote 7.
14 X 14 (4.3 X 4.3)	13 (49.2)	7.0 (0.48)				
16 X 16 (4.9 X 4.9)	13 (49.2)	7.0 (0.48)				
18 X 18 (5.5 X 5.5)	17 (64.4)	12.0 (0.83)				
20 X 20 (6.1 X 6.1)	20 (75.7)	16.7 (1.15)				

Footnotes

- Part number shown is the base part number. For complete part number, refer to the current Viking price schedule.
- Metric K-factor measurement shown is when pressure is measured in Bar. When pressure is measured in kPa, divide the metric K-factor shown by 10.0.
- This chart shows the listings and approvals available at the time of printing. Other approvals may be in process. Check with the manufacturer for any additional approvals. Refer also to Design Criteria.
- Listed by Underwriter's Laboratories, Inc. for use in the U.S., Canada, and European Union.
- Meets New York City requirements, effective July 1, 2008.
- For areas of coverage smaller than shown, use the "Flow" and "Pressure" for the next larger area listed. Flows and pressures listed are per sprinkler. The distance from sprinklers to walls shall not exceed one-half the sprinkler spacing indicated for the minimum "Flow" and "Pressure" used.
- Other paint colors are available on request with the same listings as the standard finish colors. Stainless Steel cover plates are not available with any finishes or paint. Listings and approvals apply for any paint manufacturer. Contact Viking for additional information. Custom colors are indicated on a label inside the cover assembly. Refer to Figure 3.
- Accepted Cover Plate Finishes are: Polished Chrome, Brushed Chrome, Bright Brass, Antique Brass, Brushed Brass, Brushed Copper, Painted White, Painted Ivory, or Painted Black.
- C-UL-US-EU Listed as corrosion resistant - Electroless Nickel PTFE (ENT)



TECHNICAL DATA

FREEDOM® RESIDENTIAL CONCEALED PENDENT SPRINKLER VK494 (K4.9)

The Viking Corporation, 210 N Industrial Park Drive, Hastings MI 49058
 Telephone: 269-945-9501 Technical Services: 877-384-5464 Fax: 269-818-1680 Email: techsvcs@vikingcorp.com
 Visit the Viking website for the latest edition of this technical data page www.vikinggroupinc.com

DESIGN CRITERIA

(Also refer to the Approval Chart.)

UL Listing Requirements (C-UL-US-EU):

When using Viking Residential Concealed Pendent Sprinkler VK494 for systems designed to NFPA 13D or NFPA 13R, apply the listed areas of coverage and minimum water supply requirements shown in the Approval Chart.

For systems designed to NFPA 13: The number of design sprinklers is to be the four contiguous most hydraulically demanding sprinklers. The minimum required discharge from each of the four sprinklers is to be the greater of the following:

- The flow rates given in the Approval Chart for NFPA 13D and NFPA 13R applications for each listed area of coverage, or
- Calculated based on a minimum discharge of 0.1 gpm/sq. ft. over the “design area” in accordance with sections 9.5.2.1 or 10.2.4.1.2 of the current edition of NFPA 13.
- Minimum distance between residential sprinklers: 8 ft. (2.4 m).

NOTE: Concealed sprinklers must be installed in neutral or negative pressure plenums only.

IMPORTANT: Always refer to Bulletin Form No. F_080415 - Best Practices for Residential Sprinkler Handling and Installation. Also refer to Form No. F_080614 for general care, installation, and maintenance information. Viking sprinklers are to be installed in accordance with the latest edition of Viking technical data, the appropriate standards of NFPA and any other similar Authorities Having Jurisdiction, and also with the provisions of governmental codes, ordinances, and standards, whenever applicable. Final approval and acceptance of all residential sprinkler installations must be obtained from the Authorities Having Jurisdiction.

Sprinkler and Adapter Assembly

- Protective cap removed
- Use wrench 14047W/B**

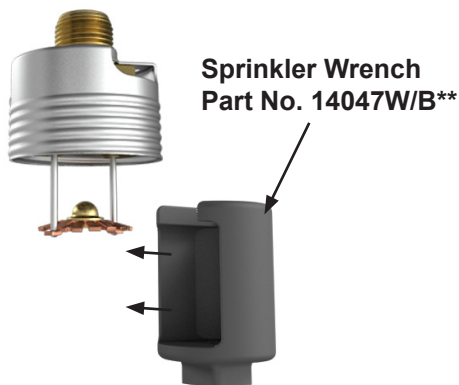

Step 1:
Carefully slide the wrench sideways around the deflector and pins

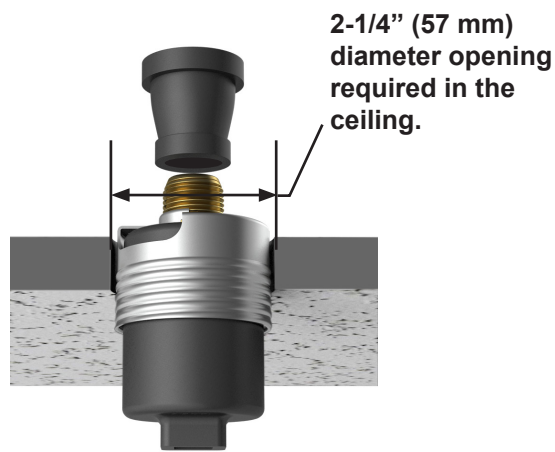

Step 2:
Carefully press the wrench upward and turn slightly to ensure engagement with the sprinkler wrench flats.

NEVER install the sprinkler by applying the installation wrench across the frame arms. **DO NOT** overtighten. Use only the designated sprinkler wrenches, Viking Part Numbers 14047W/B** or 14031**. A leak tight seal should be achieved by turning the sprinkler clockwise 1 to 1-1/2 turns beyond finger tight.

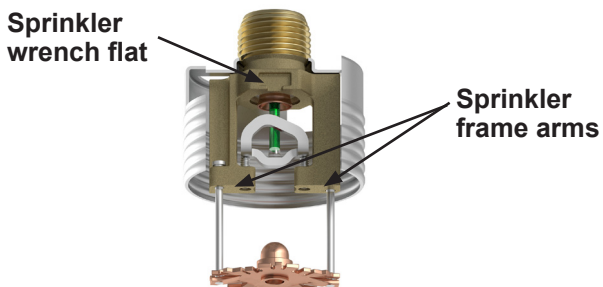

Figure 1: Sprinkler Installation and Proper Wrench Usage
 ** A 1/2" ratchet is required (Not available from Viking)



TECHNICAL DATA

FREEDOM® RESIDENTIAL CONCEALED PENDENT SPRINKLER VK494 (K4.9)

The Viking Corporation, 210 N Industrial Park Drive, Hastings MI 49058
 Telephone: 269-945-9501 Technical Services: 877-384-5464 Fax: 269-818-1680 Email: techsvcs@vikingcorp.com
 Visit the Viking website for the latest edition of this technical data page www.vikinggroupinc.com

