

FRONT ELEVATION WITH SIDE LOAD GARAGE

SCALE 1/8" = 1'-0"

PLANS DESIGNED TO THE 2018 NORTH CAROLINA STATE RESIDENTIAL BUILDING CODE

MEAN ROOF HEIGHT 25'-8"	HEIGHT TO RIDGE 30'-0"		
CLIMATE ZONE	ZONE 3A	ZONE 4A	ZONE 5A
CEILING R-VALUE	38 or 30c1	38 or 30c1	38 or 30c1
WALL R-VALUE	15	15	19
FLOOR R-VALUE	19	19	30
* BASEMENT WALL R-VALUE	5/13	10/15	10/15
** SLAB R-VALUE	0	10	10
** CRAWL SPACE WALL R-VALUE	5/13	10/15	10/19

** 10'12" MEANS R-10 SHEATHING INSULATION OR R-43 CAVITY INSULATION
 ** INSULATION DEPTH WITH MONOLITHIC SLAB 4" OR FROM INSPECTION OPP TO BOTTOM OF FOOTING; INSULATION DEPTH WITH STEM WALL SLAB 24" OR TO BOTTOM OF FOUNDATION WALL

DESIGNED FOR WIND SPEED OF 120 MPH, 3 SECOND GUST (83 FASTEST MILE) EXPOSURE "B"

COMPONENT & CLADDING DESIGNED FOR THE FOLLOWING LOADS	
MEAN ROOF	UP TO 30' 30'-0" TO 35' 35'-0" TO 40' 40'-0" TO 45'
ZONE 1	14.2 -15.0 14.9 -15.8 15.1 -16.4 15.9 -16.8
ZONE 2	14.2 -18.0 14.9 -18.9 15.5 -19.6 15.9 -20.2
ZONE 3	14.2 -18.0 14.9 -18.9 15.5 -19.6 15.9 -20.2
ZONE 4	15.5 -16.0 16.3 -16.8 16.9 -17.4 17.4 -17.9
ZONE 5	15.5 -20.0 16.3 -21.0 16.9 -21.8 17.4 -22.4

DESIGNED FOR WIND SPEED OF 130 MPH, 3 SECOND GUST (81 FASTEST MILE) EXPOSURE "B"

COMPONENT & CLADDING DESIGNED FOR THE FOLLOWING LOADS	
MEAN ROOF	UP TO 30' 30'-0" TO 35' 35'-0" TO 40' 40'-0" TO 45'
ZONE 1	16.7 -18.0 17.5 -18.9 18.2 -19.6 18.7 -20.2
ZONE 2	16.7 -21.0 17.5 -22.1 18.2 -22.9 18.7 -23.5
ZONE 3	16.7 -21.0 17.5 -22.1 18.2 -22.9 18.7 -23.5
ZONE 4	18.2 -19.0 19.1 -20.0 19.8 -20.7 20.4 -21.3
ZONE 5	18.2 -24.0 19.1 -25.2 19.8 -26.2 20.4 -26.9

AIR LEAKAGE

Section N1102.4

N1102.4.1 Building thermal envelope. The building thermal envelope shall be durably sealed with an air barrier system to limit infiltration. The sealing methods between dissimilar materials shall allow for differential expansion and contraction. For all homes, where present, the following shall be caulked, gasketed, weather stripped or otherwise sealed with an air barrier material or solid material consistent with Appendix E-2.4 of this code:
 1. Blocking and sealing floor/ceiling systems and under knee walls open to unconditioned or exterior space.
 2. Capping and sealing shafts or chases, including flue shafts.
 3. Capping and sealing soffit or dropped ceiling areas.

ROOF VENTILATION

SECTION R806

R806.1 Ventilation required. Enclosed attics and enclosed rafter spaces formed where ceilings are applied directly to the underside of roof rafters shall have cross ventilation for each separate space by ventilating openings protected against the entrance of rain or snow. Ventilating openings shall have a least dimension of 1/16 inch (1.6 mm) minimum and 1/4 inch (6.4 mm) maximum. Ventilating openings having a least dimension larger than 1/4 inch (6.4 mm) shall be provided with corrosion-resistant wire cloth screening, hardware cloth, or similar material with openings having a least dimension of 1/16 inch (1.6 mm) minimum and 1/4 inch (6.4 mm) maximum. Openings in roof framing members shall conform to the requirements of Section R802.7.
R806.2 Minimum area. The total net free ventilating area shall not be less than 1/150 of the area of the space ventilated except that reduction of the total area to 1/300 is permitted provided that at least 50 percent and not more than 80 percent of the required ventilating area is provided by ventilators located in the upper portion of the space to be ventilated at least 3 feet (914 mm) above the eave or cornice vents with the balance of the required ventilation provided by eave or cornice vents. As an alternative, the net free cross-ventilation area may be reduced to 1/300 when a Class I or II vapor retarder is installed on the warm-in-winter side of the ceiling.

Exceptions:

1. Enclosed attic/rafter spaces requiring less than 1 square foot (0.0929 m²) of ventilation may be vented with continuous soffit ventilation only.
 2. Enclosed attic/rafter spaces over unconditioned space may be vented with continuous soffit vent only.
- SQUARE FOOTAGE OF ROOF TO BE VENTED = 1558 SQ.FT.
 NET FREE CROSS VENTILATION NEEDED:
 WITHOUT 50% TO 80% OF VENTING 3'-0" ABOVE EAVE = 10.39 SQ.FT.
 WITH 50% TO 80% OF VENTING 3'-0" ABOVE EAVE, OR WITH CLASS I OR II VAPOR RETARDER ON WARM-IN-WINTER SIDE OF CEILING = 5.16 SQ.FT.

GUARD RAIL NOTES

SECTION R312

R312.1 Where required. Guards shall be located along open-sided walking surfaces, including stairs, ramps and landings, that are located more than 30 inches (762 mm) measured vertically to the floor or grade below at any point within 36 inches (914 mm) horizontally to the edge of the open side. Insect screening shall not be considered as a guard.
R312.2 Height. Required guards at open-sided walking surfaces, including stairs, porches, balconies or landings, shall be not less than 36 inches (914 mm) high measured vertically above the adjacent walking surface, adjacent fixed seating or the line connecting the leading edges of the treads.

Exceptions:

1. Guards on the open sides of stairs shall have a height not less than 34 inches (864 mm) measured vertically from a line connecting the leading edges of the treads.
 2. Where the top of the guard also serves as a handrail on the open sides of stairs, the top of the guard shall not be less than 34 inches (864 mm) and not more than 38 inches (965 mm) measured vertically from a line connecting the leading edges of the treads.
- R312.3 Opening limitations.** Required guards shall not have openings from the walking surface to the required guard height which allow passage of a sphere 4 inches (102 mm) in diameter.
Exceptions:
 1. The triangular openings at the open side of a stair, formed by the riser, tread and bottom rail of a guard, shall not allow passage of a sphere 6 inches (153 mm) in diameter.
 2. Guards on the open sides of stairs shall not have openings which allow passage of a sphere 4 3/8 inches (111 mm) in diameter.

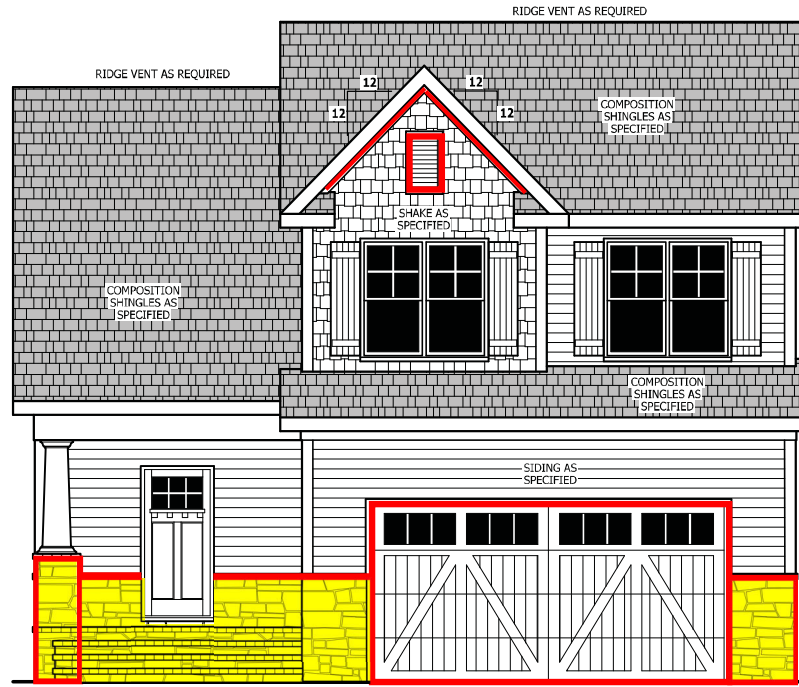

FRONT ELEVATION

SCALE 1/4" = 1'-0"

STONE FRONT FACING ONLY

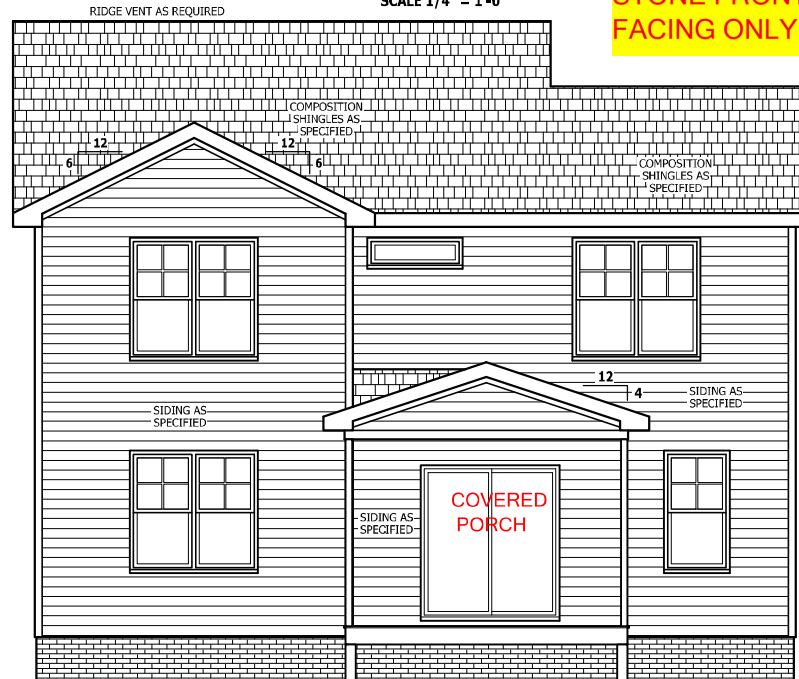

REAR ELEVATION

SCALE 1/4" = 1'-0"

**Lot #5 Cameron Road
3 CAR GARAGE**

COVERED PORCH

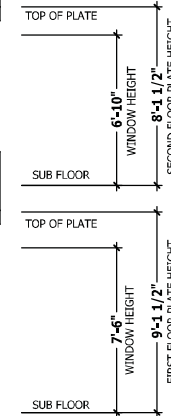

SQUARE FOOTAGE

HEATED	
FIRST FLOOR	776 SQ.FT.
SECOND FLOOR	764 SQ.FT.
PLAYROOM	280 SQ.FT.
TOTAL	1820 SQ.FT.
UNHEATED	
FRONT PORCH	101 SQ.FT.
GARAGE	466 SQ.FT.
REAR PORCH	152 SQ.FT.
TOTAL	719 SQ.FT.

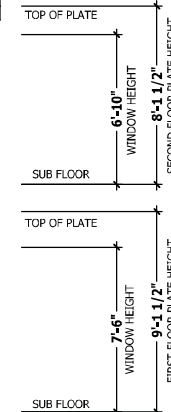

PURCHASER MUST VERIFY ALL DIMENSIONS AND CONDITIONS BEFORE CONSTRUCTION BEGINS. HAYNES HOME PLANS, INC. ASSUMES NO LIABILITY FOR CONTRACTORS' MISTAKES AND PROCEDURES. COPIES AND CONDITIONS MAY VARY WITH LOCATION. A LOCAL DESIGNER, ARCHITECT OR ENGINEER SHOULD BE CONSULTED BEFORE CONSTRUCTION. THESE DRAWINGS ARE INSTRUMENTS OF SERVICE AND AS SUCH SHALL REMAIN PROPERTY OF THE DESIGNER.

FRONT & REAR ELEVATIONS
THE GASTON II

WEAVER HOMES
910.630.2100 • 919.606.4696
301 Wagon Wheel, Fayetteville, NC 28403

HAYNES HOME PLANS, INC.
P.O. BOX 902 WAKE FOREST, NC 27788 919-439-6160 FAX 919-439-6355

SQUARE FOOTAGE	
HEATED	
FIRST FLOOR	776 SQ.FT.
SECOND FLOOR	764 SQ.FT.
PLAYROOM	280 SQ.FT.
TOTAL	1820 SQ.FT.
UNHEATED	
FRONT PORCH	101 SQ.FT.
GARAGE	466 SQ.FT.
REAR PORCH	152 SQ.FT.
TOTAL	719 SQ.FT.

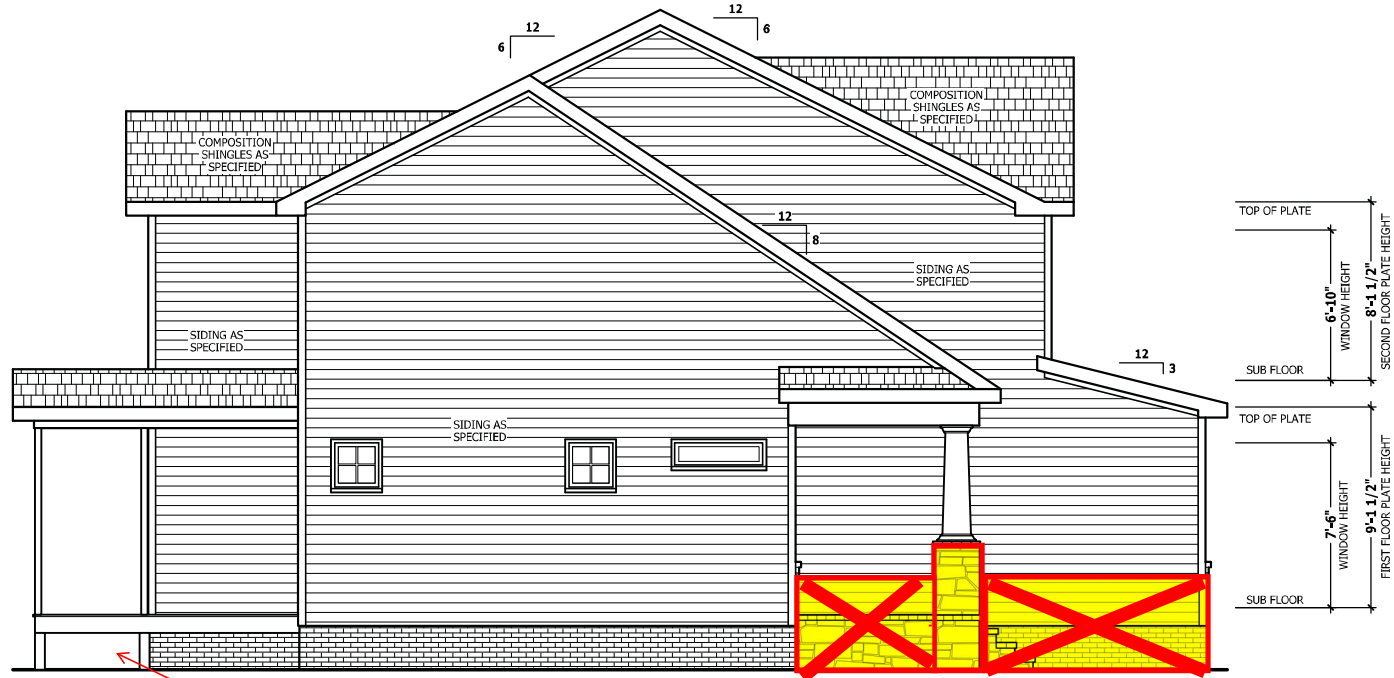

LEFT SIDE ELEVATION

SCALE 1/4" = 1'-0"

RAIL AS NEEDED PER CODE

COVERED PORCH

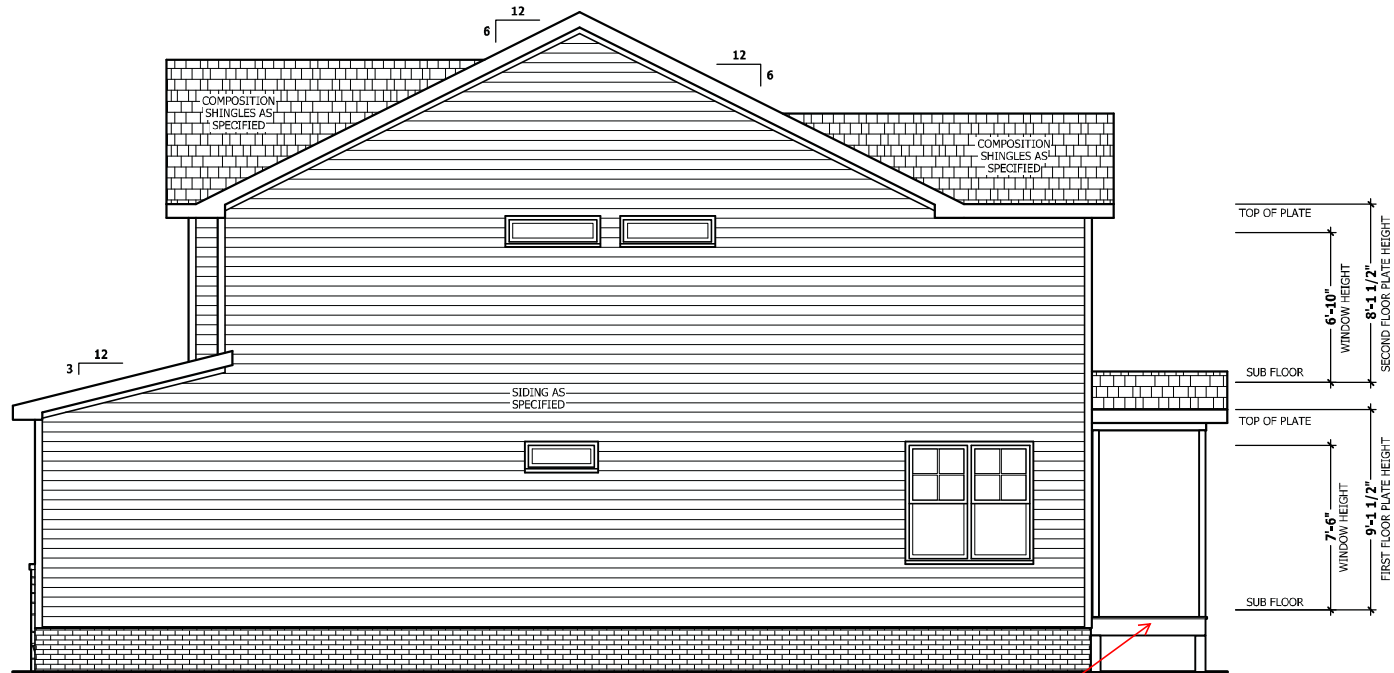

RIGHT SIDE ELEVATION

SCALE 1/4" = 1'-0"

COVERED PORCH

PURCHASER MUST VERIFY ALL DIMENSIONS AND CONDITIONS BEFORE CONSTRUCTION BEGINS. HAYNES HOME PLANS, INC. ASSUMES NO LIABILITY FOR CONTRACTORS' MISTAKES AND PROCEDURES. CODES AND CONDITIONS MAY VARY WITH LOCATION. A LOCAL DESIGNER, ARCHITECT OR ENGINEER SHOULD BE CONSULTED BEFORE CONSTRUCTION. THESE DRAWINGS ARE INSTRUMENTS OF SERVICE AND AS SUCH SHALL REMAIN PROPERTY OF THE DESIGNER.

LEFT & RIGHT ELEVATIONS
THE GASTON II

HAYNES WE AVER
HOME PLANS, INC.
910.630.2100 • 919.606.4696
370 Wagon Wheel, Fayetteville, NC 28403

SQUARE FOOTAGE	
HEATED	
FIRST FLOOR	776 SQ. FT.
SECOND FLOOR	264 SQ. FT.
PLAYROOM	286 SQ. FT.
TOTAL	1326 SQ. FT.
UNHEATED	
FRONT PORCH	151 SQ. FT.
SCREENED	466 SQ. FT.
REAR PORCH	132 SQ. FT.
TOTAL	749 SQ. FT.

© Copyright 2016
Haynes Home Plans, Inc.
5/19/2020
181035B
PAGE 2 OF 8

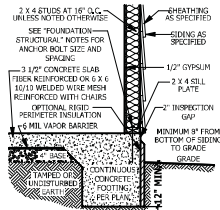

A MONOLITHIC SECTION
SCALE 1/2" = 1'-0"

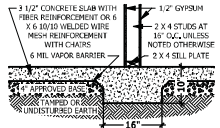

B LUG FOOTING SECTION
SCALE 1/2" = 1'-0"

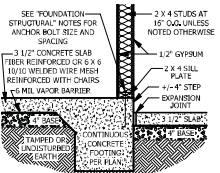

C MONOLITHIC AT STEP
SCALE 1/2" = 1'-0"

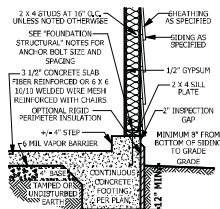

D MONOLITHIC AT GARAGE
SCALE 1/2" = 1'-0"

FOUNDATION STRUCTURAL

115 to 130 mph wind zone (1 1/2 to 2 1/2 story)
CONTINUOUS FOOTING: 16" wide and 8" thick minimum, 20" wide minimum at brick veneer. Must extend 2" to either side of supported wall.
GIRDERS: (3) 2 x 10 girder unless noted otherwise.
PIERS: 16" X 16" piers with 8" solid masonry cap on 30" X 30" X 10" concrete footing with maximum pier height of 64" with hollow masonry and 160" with solid masonry.
POINT LOADS: ■ designates significant point load and should have solid blocking to pier, girder or foundation wall.
115 and 120 MPH ANCHORS BOLTS: 1/2" diameter anchor bolts embedded minimum 7", maximum 6'-0" on center, within 12" of plate ends, and minimum two anchor bolts per plate.
130 MPH ANCHORS BOLTS: 1/2" diameter anchor bolts embedded minimum 15", maximum 4'-0" on center, within 12" of plate ends, and minimum two anchor bolts per plate.
CONCRETE: Concrete shall have a minimum 28 day strength of 3000 psi and a maximum 5" slump. Air entrained per table 402.2. All concrete shall be in accordance with ACI standards. All samples for pumping shall be taken from the exit end of the pump.
SOILS: Allowable soil bearing pressure assumed to be 2000 PSF. The contractor must contact a geotechnical engineer and a structural engineer if unsatisfactory subsurface conditions are encountered. The surface area adjacent to the foundation wall shall be provided with adequate drainage, and shall be graded so as to drain surface water away from foundation walls.

MONOLITHIC SLAB PLAN

SCALE 1/4" = 1'-0"

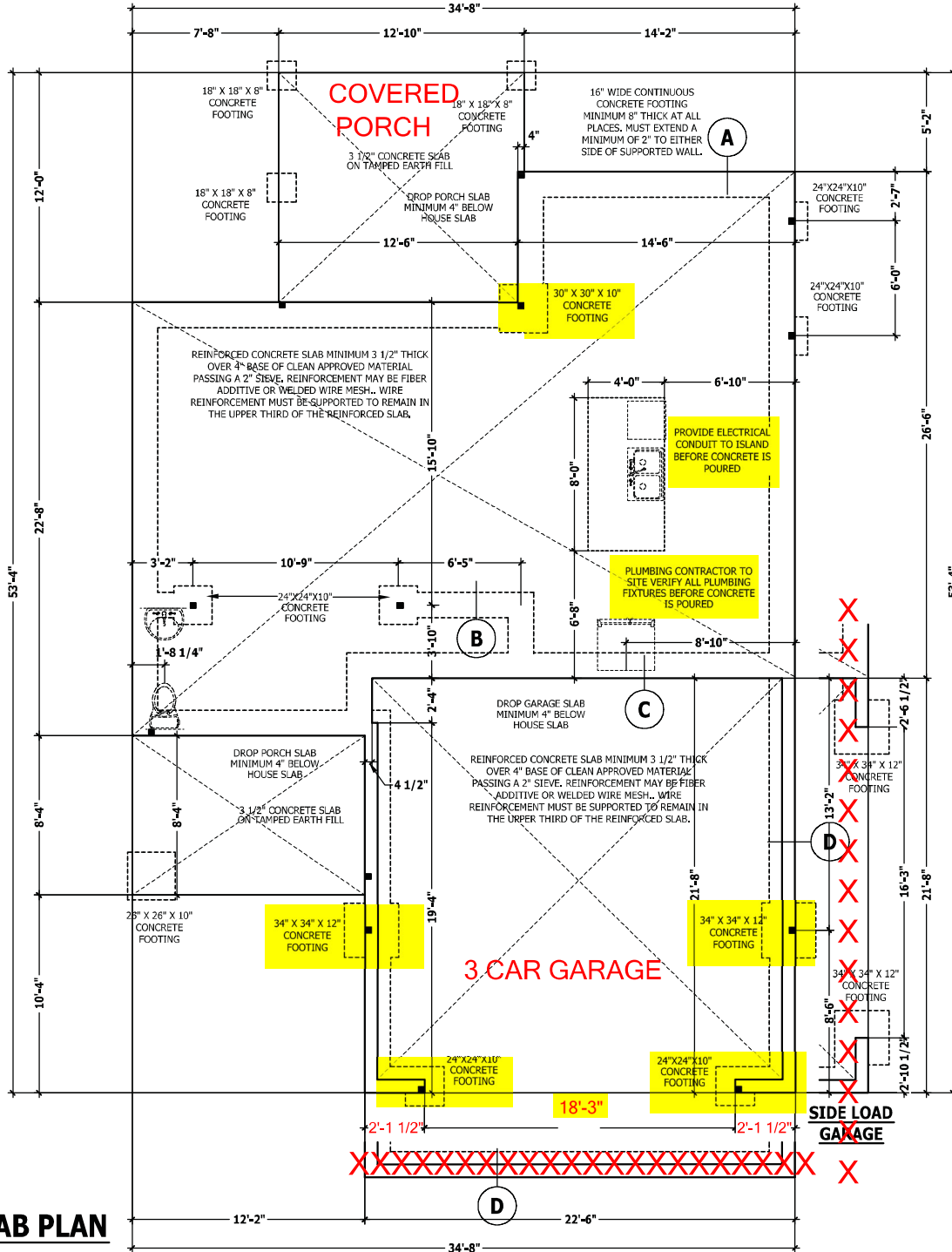

PURCHASER MUST VERIFY ALL DIMENSIONS AND CONDITIONS BEFORE CONSTRUCTION BEGINS. HAYNES HOME PLANS, INC. ASSUMES NO LIABILITY FOR CONTRACTORS' MISTAKES AND PROCEDURES. CODES AND CONDITIONS MAY VARY WITH LOCATION. A LOCAL DESIGNER, ARCHITECT OR ENGINEER SHOULD BE CONSULTED BEFORE CONSTRUCTION. THESE DRAWINGS ARE INSTRUMENTS OF SERVICE AND AS SUCH SHALL REMAIN PROPERTY OF THE DESIGNER.

MONOLITHIC SLAB PLAN
THE GASTON II

HAYNES WEAVER HOMES
HOME PLANS, INC.
910.630.2100 • 919.606.4696
3701 Wagon Wheel Way, Fayetteville, NC 28403

HAYNES WEAVER HOMES
HOME PLANS, INC.
P.O. BOX 402 WAKE FOREST, NC 27788 919-439-6160 FAX 919-439-1035

SQUARE FOOTAGE	
HEATED	
FIRST FLOOR	776 SQ.FT.
SECOND FLOOR	764 SQ.FT.
PLAYROOM	280 SQ.FT.
TOTAL	1820 SQ.FT.
UNHEATED	
FRONT PORCH	131 SQ.FT.
REAR PORCH	132 SQ.FT.
TOTAL	264 SQ.FT.

© Copyright 2016
Haynes Home Plans, Inc.
5/19/2020
181035B
PAGE 3 OF 8

PURCHASER MUST VERIFY ALL DIMENSIONS AND CONDITIONS BEFORE CONSTRUCTION BEGINS. HAYNES HOME PLANS, INC. ASSUMES NO LIABILITY FOR CONTRACTOR PRACTICES AND PROCEDURES. CODES AND CONDITIONS MAY VARY WITH LOCATION. A LOCAL DESIGNER, ARCHITECT OR ENGINEER SHOULD BE CONSULTED BEFORE CONSTRUCTION. THESE DRAWINGS ARE INSTRUMENTS OF SERVICE AND AS SUCH SHALL REMAIN PROPERTY OF THE DESIGNER.

FOUNDATION PLAN
THE GASTON II

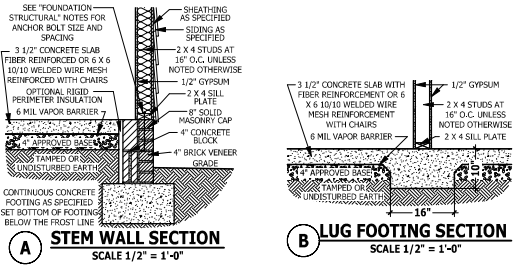

A STEM WALL SECTION
SCALE 1/2" = 1'-0"

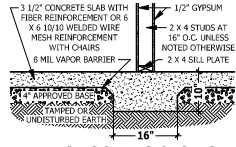

B LUG FOOTING SECTION
SCALE 1/2" = 1'-0"

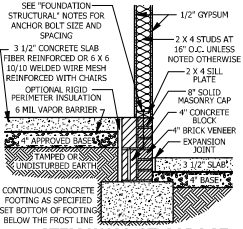

C STEM WALL AT GARAGE
SCALE 1/2" = 1'-0"

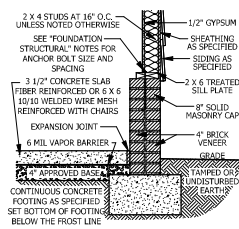

D GARAGE STEM WALL
SCALE 1/2" = 1'-0"

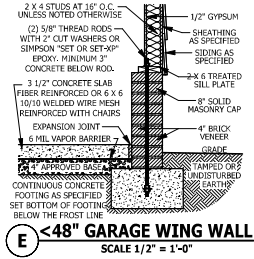

E <48\"/>
SCALE 1/2" = 1'-0"

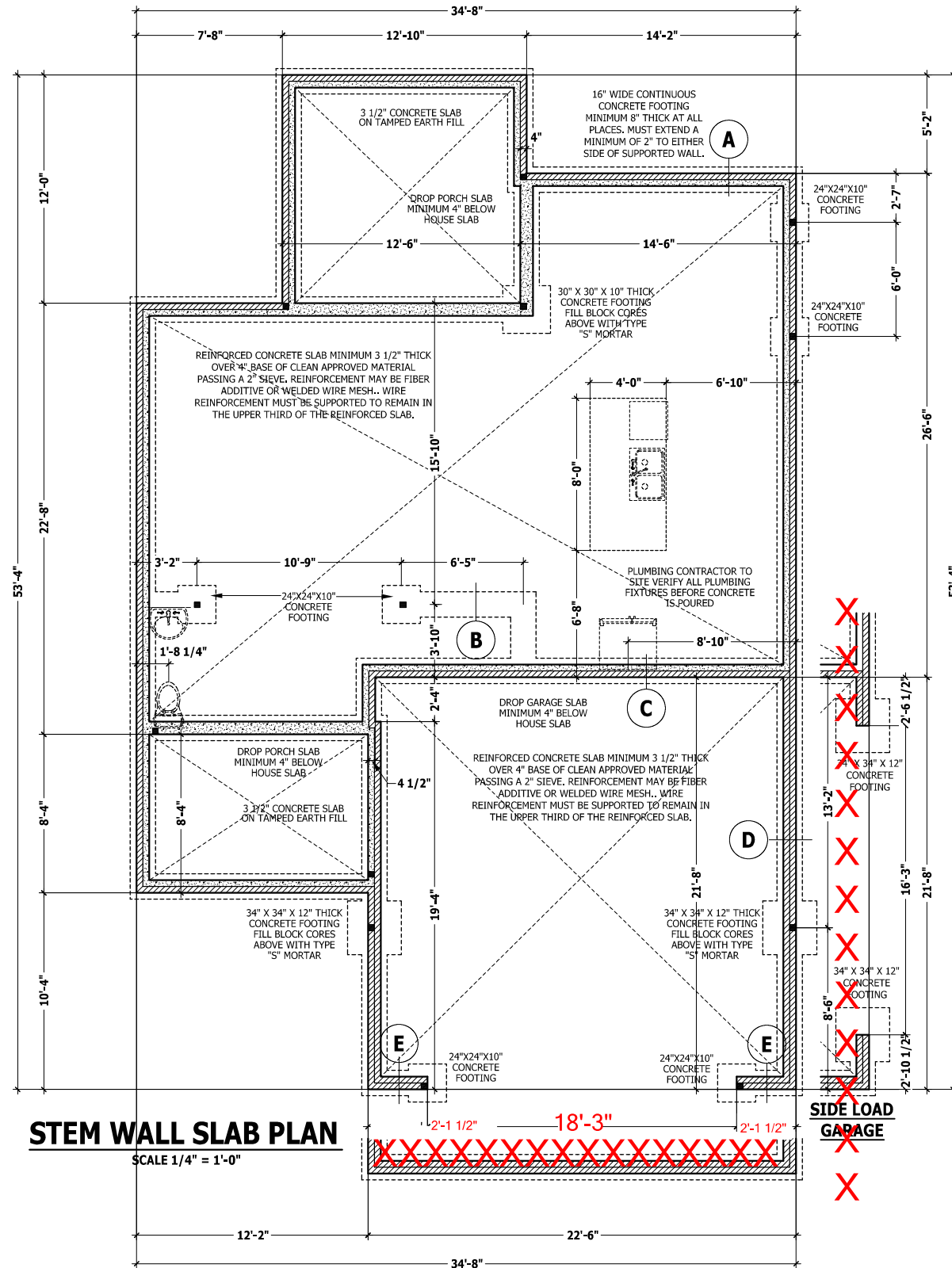

STEM WALL SLAB PLAN
SCALE 1/4" = 1'-0"

FOUNDATION STRUCTURAL

115 to 130 mph wind zone (1 1/2 to 2 1/2 story)
CONTINUOUS FOOTING: 16" wide and 8" thick minimum. 20" wide minimum at brick veneer. Must extend 2" to either side of supported wall.
GIRDERS: (3) 2 X 10 girder unless noted otherwise.
PIERS: 16" X 16" piers with 8" solid masonry cap on 30" X 30" X 10" concrete footing with maximum pier height of 64" with hollow masonry and 160" with solid masonry.
POINT LOADS: ■ designates significant point load and should have solid blocking to pier, girder or foundation wall.
115 and 120 MPH ANCHORS BOLTS: 1/2" diameter anchor bolts embedded minimum 7", maximum 6'-0" on center, within 12" of plate ends, and minimum two anchor bolts per plate.
130 MPH ANCHORS BOLTS: 1/2" diameter anchor bolts embedded minimum 15", maximum 4'-0" on center, within 12" of plate ends, and minimum two anchor bolts per plate.
CONCRETE: Concrete shall have a minimum 28 day strength of 3000 psi and a maximum 5" slump. Air entrained per table 402.2. All concrete shall be in accordance with ACI standards. All samples for pumping shall be taken from the exit end of the pump.
SOILS: Allowable soil bearing pressure assumed to be 2000 PSF. The contractor must contact a geotechnical engineer and a structural engineer if unsatisfactory subsurface conditions are encountered. The surface area adjacent to the foundation wall shall be provided with adequate drainage, and shall be graded so as to drain surface water away from foundation walls.

HAYNES HOME PLANS, INC.
P.O. Box 702, Wake Forest, NC 27758 919-485-6100 FAX 919-485-4914-0366

SQUARE FOOTAGE

HEATED	
FIRST FLOOR	776 SQ.FT.
SECOND FLOOR	764 SQ.FT.
PLATFLOOR	280 SQ.FT.
TOTAL	1820 SQ.FT.
UNHEATED	
FRONT PORCH	101 SQ.FT.
CHANG	466 SQ.FT.
REAR PORCH	133 SQ.FT.
TOTAL	719 SQ.FT.

Z:\Builder Weaver Development Company, Inc\2001288 Gaston II\2001288 Gaston II.aec

ATTIC ACCESS

SECTION R807

R807.1 Attic access. An attic access opening shall be provided to attic areas that exceed 400 square feet (37.16 m²) and have a vertical height of 60 inches (1524 mm) or greater. The net clear opening shall not be less than 20 inches by 30 inches (508 mm by 762 mm) and shall be located in a hallway or other readily accessible location. A 30-inch (762 mm) minimum unobstructed headroom in the attic space shall be provided at same point above the access opening. See Section M1305.1.3 for access requirements where mechanical equipment is located in attics.

Exceptions:

1. Concealed areas not located over the main structure including porches, areas behind knee walls, dormers, bay windows, etc. are not required to have access.
2. Pull down stair treads, stringers, handrails, and hardware may protrude into the net clear opening.

WALL THICKNESSES

Exterior walls and walls adjacent to a garage area are drawn as 4" or as noted 2 X 6 are drawn as 6" to include 1/2" sheathing or gypsum. Subtract 1/2" for stud face.

Interior walls are drawn as 3 1/2" or as noted 2 X 6 are drawn as 5 1/2", and do not include gypsum.

DWELLING / GARAGE SEPARATION

REFER TO SECTIONS R302.5, R302.6, AND R302.7

WALLS. A minimum 1/2" gypsum board must be installed on all walls supporting floor/ceiling assemblies used for separation required by this section.

STAIRS. A minimum of 1/2" gypsum board must be installed on the undersides and exposed sides of all stairways.

CEILINGS. A minimum of 1/2" gypsum must be installed on the garage ceiling if there are no habitable rooms above the garage. If there are habitable rooms above the garage a minimum of 5/8" type X gypsum board must be installed on the garage ceiling.

OPENING PENETRATIONS. Openings between the garage and residence shall be equipped with solid wood doors not less than 1 3/8 inches (35 mm) in thickness, solid or honeycomb core steel doors not less than 1 3/8 inches (35 mm) thick, or 20-minute fire-rated doors.

DUCT PENETRATIONS. Ducts in the garage and ducts penetrating the walls or ceilings separating the dwelling from the garage shall be constructed of a minimum No. 26 gage (0.48 mm) sheet steel or other approved material and shall have no openings into the garage.

OTHER PENETRATIONS. Penetrations through the separation required in Section R302.6 shall be protected as required by Section R302.11, Item 4.

EXTERIOR WINDOWS AND DOORS

SECTION R612

R612.1 General. This section prescribes performance and construction requirements for exterior windows and doors installed in walls. Windows and doors shall be installed and finished in accordance with the fenestration manufacturer's written installation instructions. Window and door openings shall be finished in accordance with Section R703.8. Written installation instructions shall be provided by the fenestration manufacturer for each window or door.

R612.2 Window sills. In dwelling units, where the opening of an operable window is located more than 72 inches (1829 mm) above the finished grade or surface below, the lowest part of the clear opening of the window shall be a minimum of 24 inches (610 mm) above the finished floor of the room in which the window is located. Operable sections of windows shall not permit openings that allow passage of a 4-inch (102 mm) diameter sphere where such openings are located within 24 inches (610 mm) of the finished floor.

Exceptions:

1. Windows whose openings will not allow a 4-inch diameter (102 mm) sphere to pass through the opening when the opening is in its largest opened position.
2. Openings that are provided with window fall prevention devices that comply with Section R612.3.
3. Openings that are provided with fall prevention devices that comply with ASTM F 2090.

4. Windows that are provided with opening limiting devices that comply with Section R612.4.

R612.3 Window fall prevention devices. Window fall prevention devices and window guards, where provided, shall comply with the requirements of ASTM F 2090.

SQUARE FOOTAGE

HEATED	
FIRST FLOOR	776 SQ.FT.
SECOND FLOOR	764 SQ.FT.
PLAYROOM	280 SQ.FT.
TOTAL	1820 SQ.FT.
UNHEATED	
FRONT PORCH	101 SQ.FT.
GARAGE	456 SQ.FT.
REAR PORCH	152 SQ.FT.
TOTAL	719 SQ.FT.

FIRST FLOOR PLAN

SCALE 1/4" = 1'-0"

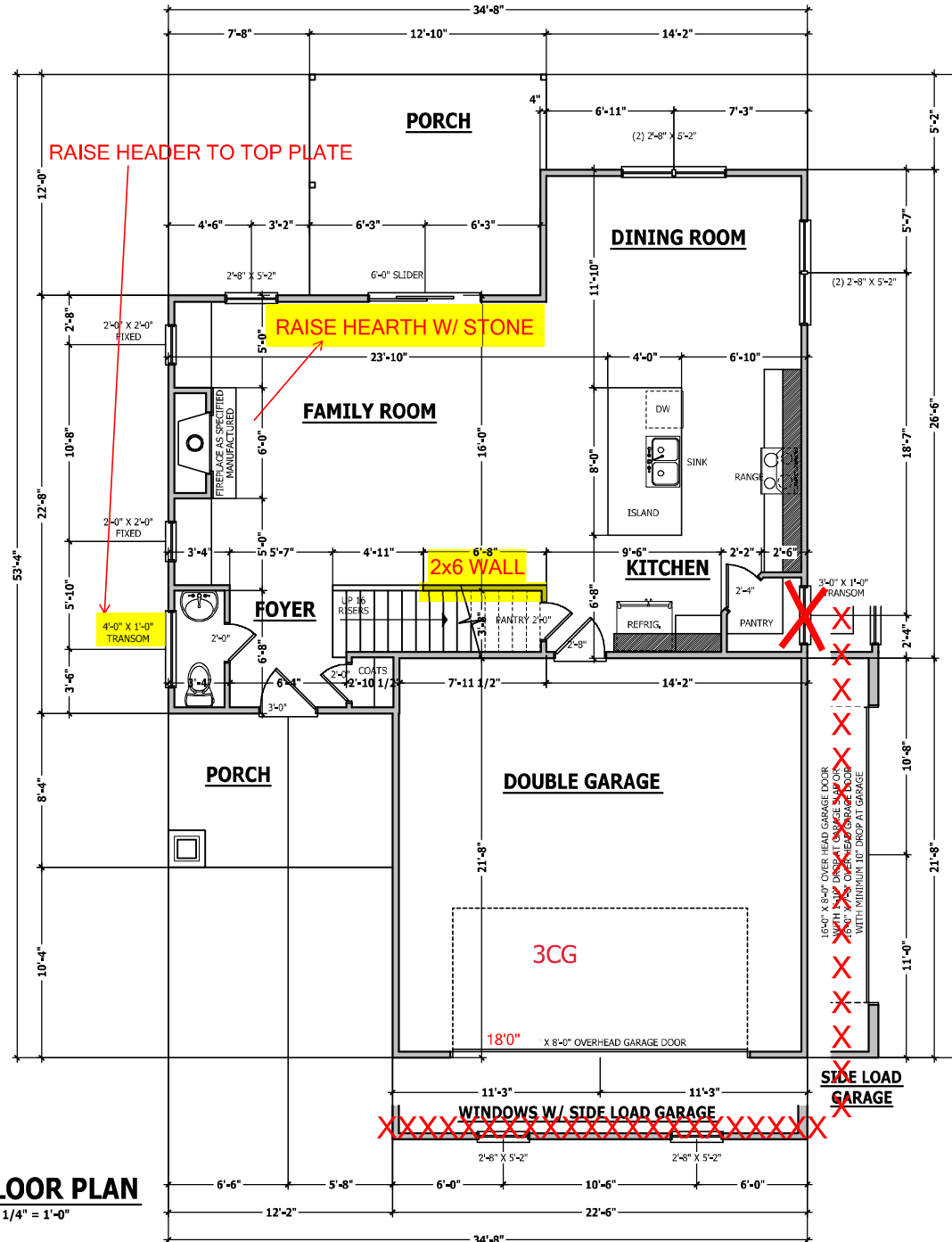

PURCHASER MUST VERIFY ALL DIMENSIONS AND CONDITIONS BEFORE CONSTRUCTION BEGINS. HAYNES HOME PLANS, INC. ASSUMES NO LIABILITY FOR CONTRACTOR PRACTICES AND PROCEDURES. CONDITIONS MAY VARY WITH LOCATION. A LOCAL DESIGN ARCHITECT OR ENGINEER SHOULD BE CONSULTED BEFORE CONSTRUCTION. THESE DRAWINGS ARE INSTRUMENTS OF SERVICE AND AS SUCH SHALL REMAIN PROPERTY OF THE DESIGNER.

FIRST FLOOR PLAN
THE GASTON II

HAYNES WEAVER HOMES
HOMB PLANS, INC.
910.630.2100 • 919.606.4696
307 Weaver Home, Matthews, NC 28105
P.O. Box 702, Pine Forest, NC 27888 919.439.6180 Fax 989.481-0366

SQUARE FOOTAGE	
HEATED	
FIRST FLOOR	776 SQ.FT.
SECOND FLOOR	764 SQ.FT.
PLAYROOM	280 SQ.FT.
TOTAL	1820 SQ.FT.
UNHEATED	
FRONT PORCH	101 SQ.FT.
GARAGE	456 SQ.FT.
REAR PORCH	152 SQ.FT.
TOTAL	719 SQ.FT.

© Copyright 2016
Haynes Home Plans, Inc.
5/19/2020
181035B
PAGE 4 OF 8

STRUCTURAL NOTES

All construction shall conform to the latest requirements of the 2018 North Carolina Residential Building Code, plus all local codes and regulations. This document in no way shall be construed to supersede the code.

JOB SITE PRACTICES AND SAFETY: Haynes Home Plans, Inc. assumes no liability for contractor practices and procedures or safety program. Haynes Home Plans, Inc. takes no responsibility for the contractor's failure to carry out the construction work in accordance with the contract documents. All members shall be framed, anchored, and braced in accordance with good construction practice and the building code.

DESIGN LOADS	LIVE LOAD (PSF)	DEAD LOAD (PSF)	DEFLECTION (LL)
Attics without storage	10	10	L/240
Attics with limited storage	20	10	L/360
Attics with fixed stairs	40	10	L/360
Balconies and decks	40	10	L/360
Fire escapes	40	10	L/360
Guardrails and handrails	200	—	—
Guardrail in-fill components	50	—	—
Passenger vehicles garages	50	10	L/360
Rooms other than sleeping	40	10	L/360
Sleeping rooms	30	10	L/360
Stairs	40	—	L/360
Snow	20	—	—

FRAMING LUMBER: All non treated framing lumber shall be SPF #2 (Fb = 875 PSI) or SYP #2 (Fb = 750 PSI) and all treated lumber shall be SYP #2 (Fb = 750 PSI) unless noted otherwise.

ENGINEERED WOOD BEAMS

Laminated veneer lumber (LVL) = Fb=2600 PSI, Fv=285 PSI, E=1,9x10⁶ PSI
Parallel strand lumber (PSL) = Fb=2900 PSI, Fv=290 PSI, E=2,0x10⁶ PSI
Laminated strand lumber (LSL) = Fb=2250 PSI, Fv=400 PSI, E=1,55x10⁶ PSI
Metal All connections per manufacturer's instructions.

TRUSS AND I-JOIST MEMBERS: All roof truss and I-joist layouts shall be prepared in accordance with this document. Trusses and I-joists shall be installed according to the manufacturer's specifications. Any change in truss or I-joist layout shall be coordinated with Haynes Home Plans, Inc.

LINTELS: Brick lintels shall be 3 1/2" x 3 1/2" x 1/4" steel angle for spans up to 6'-0" span, 6" x 4" x 5/16" steel angle with 6" leg vertical for spans up to 9'-0" span. Unless noted otherwise, 3 1/2" x 3 1/2" x 1/4" steel angle with 1/2" lugs at 24" on center for spans up to 18'-0" unless noted otherwise.

FLOOR SHEATHING: OSB or CDX floor sheathing minimum 1/2" thick for 16" on center joist spacing, minimum 5/8" thick for 19.2" on center joist spacing, and minimum 3/4" thick for 24" on center joist spacing.

ROOF SHEATHING: OSB or CDX roof sheathing minimum 3/8" thick.

CONCRETE AND SOILS: See foundation notes.

BRACE WALL PANEL NOTES

EXTERIOR WALLS: All exterior walls to be sheathed with CS-WSP or CS-SFB in accordance with section R602.10.3 unless noted otherwise.

GYPSUM: All interior sides of exterior walls and both sides interior walls to have 1/2" gypsum installed. When not using method GB gypsum to be fastened per table R702.3.5, Method GB to be fastened per table R602.10.1.

REQUIRED LENGTH OF BRACING: Required brace wall length for each side of the circumscribed rectangle are interpolated per table R602.10.3. Methods CS-WSP and CS-SFB contribute their actual length. Method GB contributes 0.5 its actual length. Method PF contributes 1.5 times its actual length.

HD: 800 lbs hold down hold down device fastened to the edge of the brace wall panel closest to the corner.

Methods Per Table R602.10.1.

CS-WSP: Shall be minimum 3/8" OSB or CDX nailed at 6" on center at edges and 12" on center at intermediate supports with 5d common nails or 8d(2 1/2" long x 0.113" diameter).

CS-SFB: Shall be minimum 1/2" structural fiber board nailed at 3" on center at edges and 3" on center at intermediate supports with 1 1/2" long x 0.12" diameter galvanized roofing nails.

GB: Interior walls show as GB are to have minimum 1/2" gypsum board on both sides of the wall fastened at 7" on center at edges and 7" on center at intermediate supports with minimum 5d cooler nails or #6 screws.

PF: Portal frame per figure R602.10.1.

ROOF TRUSS REQUIREMENTS

TRUSS DESIGN: Trusses to be designed and engineered in accordance with these drawings. Any variation with these drawings must be brought to Haynes Home Plans, Inc. attention before construction begins.

KNEE WALL AND CEILING HEIGHTS: All finished knee wall heights and ceiling heights are shown furled down 10" from roof decking for insulation. If for any reason the truss manufacturer fails to meet or exceed designated head heights, finished knee wall heights, or finished ceiling heights shown on these drawings the finished square footage may vary. Any discrepancy must be brought to Haynes Home Plans, Inc. attention, so a suitable solution can be reached before construction begins. Any variation due to these conditions not being met is the responsibility of the truss manufacturer.

ANCHORAGE: All required anchors for trusses due to uplift or bearing shall meet the requirements as specified on the truss schematics.

BEARING: All trusses shall be designed for bearing on SPF #2 plates or joists unless noted otherwise.

Plate Heights & Floor Systems: See elevation page(s) for plate heights and floor system thicknesses.

EXTERIOR HEADERS

(2) 2 X 6 WITH 1 JACK STUD EACH END UNLESS NOTED OTHERWISE

- KING STUDS EACH END PER TABLE BELOW

HEADER SPAN	< 3'	3'-4'	4'-8'	8'-12'	12'-16'
KING STUD(S)	1	2	3	5	6

INTERIOR HEADERS

- LOAD BEARING HEADERS (2) 2 X 6 WITH 1 JACK STUD AND 1 KING STUD EACH END UNLESS NOTED OTHERWISE

- NON LOAD BEARING HEADERS TO BE LADDER FRAMED

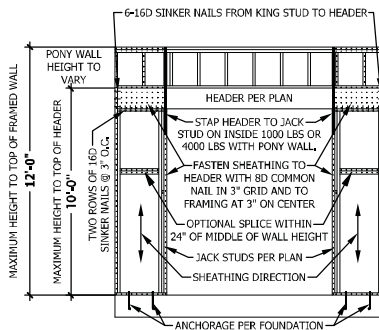

PF PORTAL FRAME AT OPENING
(METHOD PF PER FIGURE AND SECTION R602.10.1)
SCALE 1/4" = 1'-0"

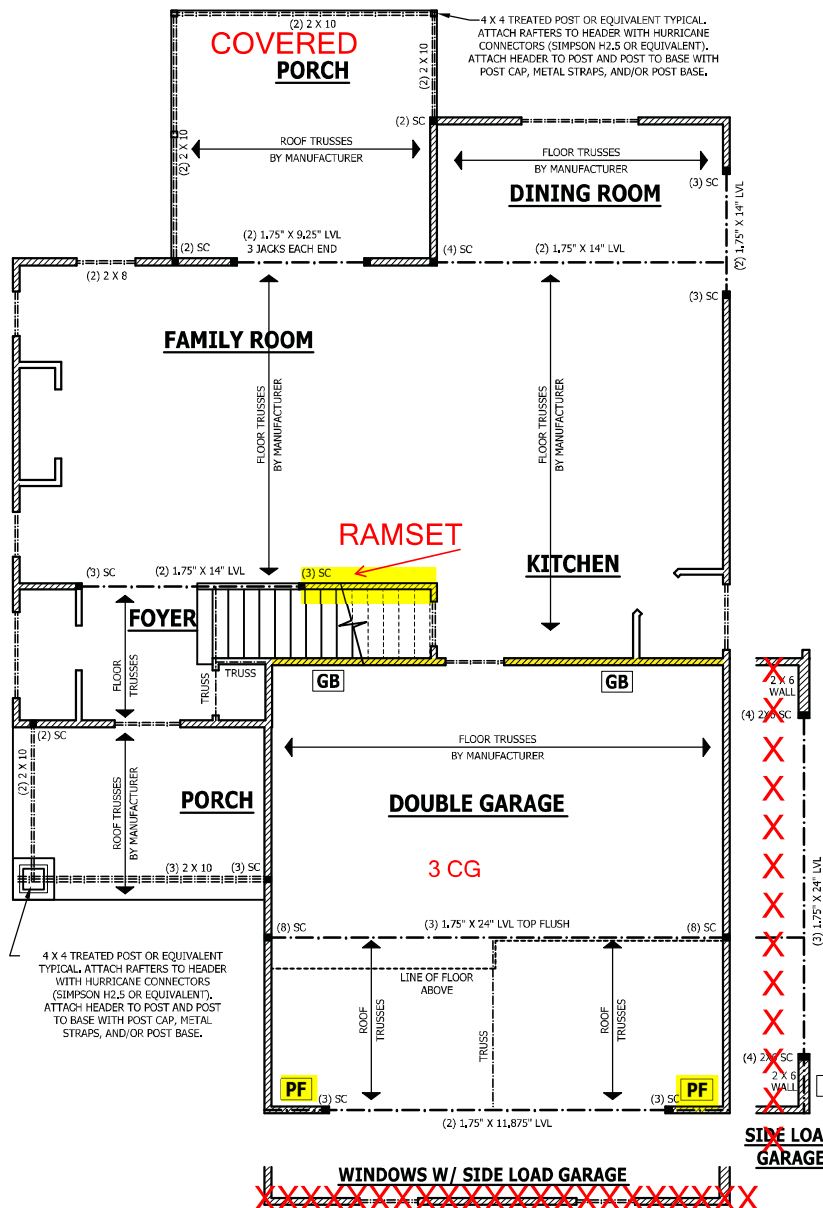

FIRST FLOOR STRUCTURAL

SCALE 1/4" = 1'-0"

PURCHASER MUST VERIFY ALL DIMENSIONS AND CONDITIONS BEFORE CONSTRUCTION BEGINS. HAYNES HOME PLANS, INC. ASSUMES NO LIABILITY FOR CONTRACTOR PRACTICES AND PROCEDURES. CONDITIONS AND CONDITIONS MAY VARY WITH LOCATION. A LOCAL DESIGN ARCHITECT OR ENGINEER SHOULD BE CONSULTED BEFORE CONSTRUCTION. THESE DRAWINGS ARE INSTRUMENTS OF SERVICE AND AS SUCH SHALL REMAIN PROPERTY OF THE DESIGNER.

FIRST FLOOR STRUCTURAL
THE GASTON II

HAYNES WEAVER HOMES
HOMB PLANS, INC.
910.630.2100 • 919.606.4696
3070 W. WILSON ROAD, WILSON, NC 27894
P.O. BOX 700, WILSON, NC 27898 919.439.6180 Fax 919.439.6186

SQUARE FOOTAGE	
HEATED	
FIRST FLOOR	274 SQ.FT.
SECOND FLOOR	264 SQ.FT.
SLIPPERY	264 SQ.FT.
TOTAL	802 SQ.FT.
UNHEATED	
FRONT PORCH	46 SQ.FT.
REAR PORCH	152 SQ.FT.
TOTAL	198 SQ.FT.

© Copyright 2016
Haynes Home Plans, Inc.
5/19/2020
181035B
PAGE 5 OF 8

STRUCTURAL NOTES

All construction shall conform to the latest requirements of the 2018 North Carolina Residential Building Code, plus all local codes and regulations. This document in no way shall be construed to supersede the code.

JOB SITE PRACTICES AND SAFETY: Haynes Home Plans, Inc. assumes no liability for contractor practices and procedures or safety program. Haynes Home Plans, Inc. takes no responsibility for the contractor's failure to carry out the construction work in accordance with the contract documents. All members shall be framed, anchored, and braced in accordance with good construction practices and the building code.

DESIGN LOADS	LIVE LOAD (PSF)	DEAD LOAD (PSF)	DEFLECTION (LL)
Attics without storage	10	10	L/240
Attics with limited storage	20	10	L/360
Attics with fixed stairs	40	10	L/360
Balconies and decks	40	10	L/360
Fire escapes	40	10	L/360
Guardrails and handrails	200	-	-
Guardrail in-fill components	50	-	-
Passenger vehicle garages	50	10	L/360
Rooms other than sleeping	40	10	L/360
Sloping floors	30	10	L/360
Stairs	40	-	L/360
Show	20	-	-

FRAMING LUMBER: All non treated framing lumber shall be SPF #2 (Fb = 875 PSI) or SYP #2 (Fb = 750 PSI) and all treated lumber shall be SYP #2 (Fb = 750 PSI) unless noted otherwise.

ENGINEERED WOOD BEAMS: Laminated veneer lumber (LVL) = Fb=2600 PSI, Fv=285 PSI, E=1.5x10⁶ PSI Parallel strand lumber (PSL) = Fb=2000 PSI, Fv=290 PSI, E=2.0x10⁶ PSI Laminated strand lumber (LSL) = Fb=2200 PSI, Fv=400 PSI, E=1.5x10⁶ PSI Install all connectors per manufacturer's instructions.

TRUSS AND I-JOIST MEMBERS: All roof truss and I-joist layouts shall be prepared in accordance with this document. Trusses and I-joists shall be installed according to the manufacturer's specifications. Any change in truss or I-joist layout shall be coordinated with Haynes Home Plans, Inc.

LINTELS: Brick lintels shall be 3 1/2" x 3 1/2" x 1/4" steel angle for up to 6'-0" span, 6" x 4" x 5/16" steel angle with 6" leg vertical for spans up to 9'-0" unless noted otherwise. 3 1/2" x 3 1/2" x 1/4" steel angle with 1/2" bolts at 2'-0" on center for spans up to 18'-0" unless noted otherwise.

FLOOR SHEATHING: OSB or CDX floor sheathing minimum 1/2" thick for 16" on center joist spacing, minimum 5/8" thick for 19.2" on center joist spacing, and minimum 3/4" thick for 24" on center joist spacing.

ROOF SHEATHING: OSB or CDX roof sheathing minimum 3/8" thick.

CONCRETE AND SOILS: See foundation notes.

ATTIC ACCESS

SECTION R807

R807.1 Attic access. An attic access opening shall be provided to attic areas that exceed 400 square feet (37.16 m²) and have a vertical height of 60 inches (1524 mm) or greater. The net clear opening shall not be less than 20 inches by 30 inches (508 mm by 762 mm) and shall be located in a hallway or other readily accessible location. A 30-inch (762 mm) minimum unobstructed headroom in the attic space shall be provided at some point above the access opening. See Section M1305.1.3 for access requirements where mechanical equipment is located in attics.

Exceptions:

1. Concealed areas not located over the main structure including porches, areas behind knee walls, dormers, bay windows, etc. are not required to have access.
2. Pull down stair treads, stringers, handrails, and hardware may protrude into the net clear opening.

EXTERIOR WINDOWS AND DOORS

SECTION R612

R612.1 General. This section prescribes performance and construction requirements for exterior windows and doors installed in walls. Windows and doors shall be installed and flashed in accordance with the fenestration manufacturer's written installation instructions. Window and door openings shall be flashed in accordance with Section R703.8. Written installation instructions shall be provided by the fenestration manufacturer for each window or door.

R612.2 Window sills. In dwelling units, where the opening of an operable window is located more than 72 inches (1829 mm) above the finished grade or surface below, the lowest part of the door opening of the window shall be a minimum of 24 inches (610 mm) above the finished floor of the room in which the window is located. Operable sections of windows shall not permit openings that allow passage of a 4 inch (102 mm) diameter sphere where such openings are located within 24 inches (610 mm) of the finished floor.

Exceptions:

1. Windows whose openings will not allow a 4-inch diameter (102 mm) sphere to pass through the opening when the opening is in its largest opened position.
 2. Openings that are provided with window fall prevention devices that comply with Section R612.3.
 3. Openings that are provided with fall prevention devices that comply with ASTM F 2090.
 4. Windows that are provided with opening limiting devices that comply with Section R612.4.
- R612.3 Window fall prevention devices.** Window fall prevention devices and window guards, where provided, shall comply with the requirements of ASTM F 2090.

EXTERIOR HEADERS

• (2) 2 X 6 WITH 1 JACK STUD EACH END

UNLESS NOTED OTHERWISE

• KING STUDS EACH END PER TABLE BELOW

HEADER SPAN	< 3'	3'-4'	4'-8'	8'-12'	12'-16'
KING STUD(S)	1	2	3	5	6

INTERIOR HEADERS

• LOAD BEARING HEADERS (2) 2 X 6 WITH 1 JACK STUD AND 1 KING STUD EACH END

UNLESS NOTED OTHERWISE

• NON LOAD BEARING HEADERS TO BE LADDER FRAMED

ROOF TRUSS REQUIREMENTS

TRUSS DESIGN. Trusses to be designed and engineered in accordance with these drawings. Any variation with these drawings must be brought to Haynes Home Plans, Inc. attention before construction begins.

KNEE WALL AND CEILING HEIGHTS. All finished knee wall heights and ceiling heights are shown furred down 10" from roof decking for insulation. If for any reason the truss manufacturer fails to meet or exceed designated heel heights, finished knee wall heights, or finished ceiling heights shown on these drawings the finished square footage may vary. Any discrepancy must be brought to Haynes Home Plans, Inc. attention, so a suitable solution can be reached before construction begins. Any variation due to these conditions not being met is the responsibility of the truss manufacturer.

ANCHORAGE. All required anchors for trusses due to uplift or bearing shall meet the requirements as specified on the truss schematics.

BEARING. All trusses shall be designed for bearing on SPF #2 plates or ledgers unless noted otherwise.

Plate Heights & Floor Systems. See elevation page(s) for plate heights and floor system thicknesses.

WALL THICKNESSES

Exterior walls and walls adjacent to a garage area are drawn as 4" or as noted 2 X 6 are drawn as 6" to include 1/2" sheathing or gypsum. Subtract 1/2" for stud face.

Interior walls are drawn as 3 1/2" or as noted 2 X 6 are drawn as 5 1/2", and do not include gypsum.

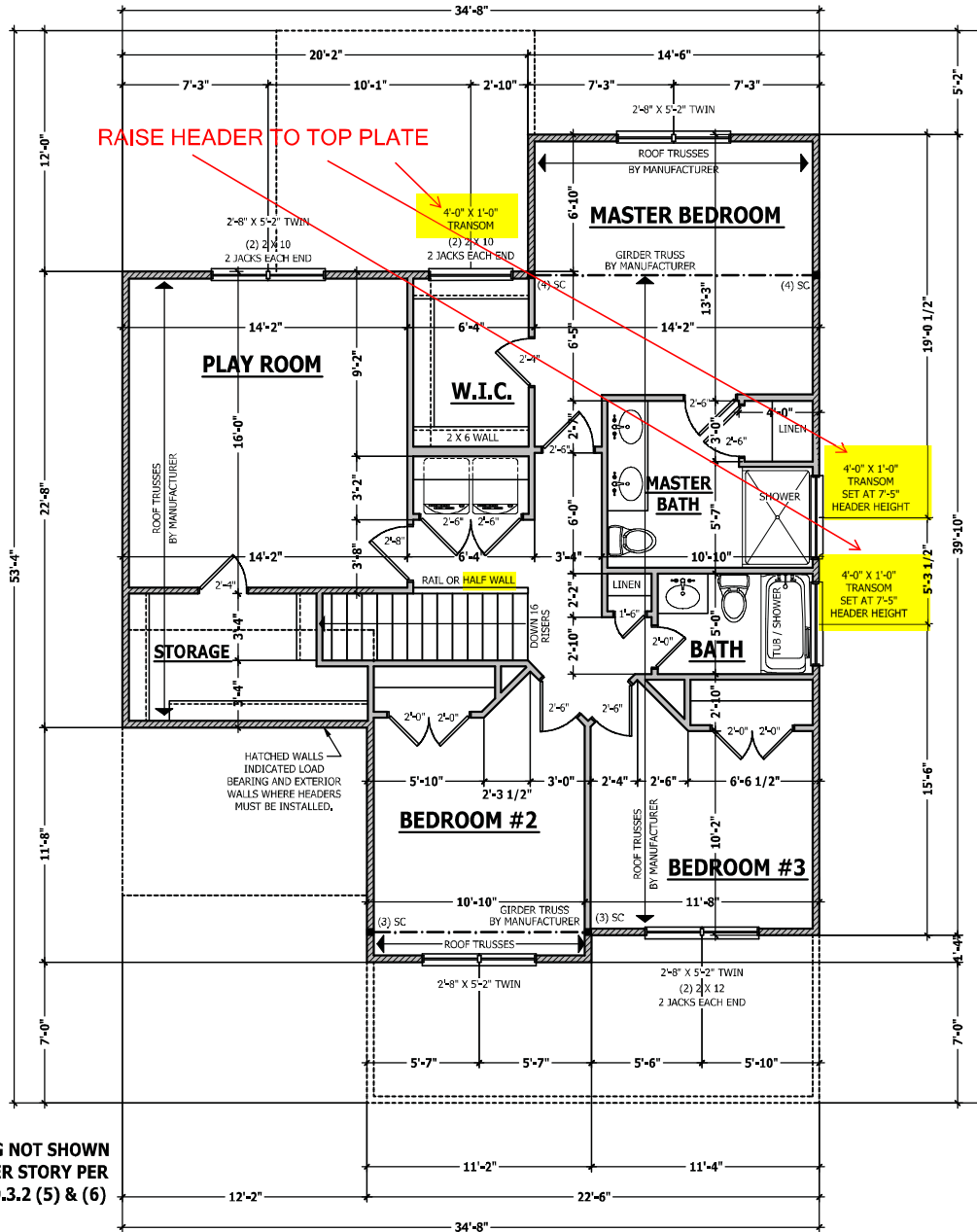

BRACING NOT SHOWN ON UPPER STORY PER R602.10.3.2 (5) & (6)

SECOND FLOOR PLAN

SCALE 1/4" = 1'-0"

PURCHASER MUST VERIFY ALL DIMENSIONS AND CONDITIONS BEFORE CONSTRUCTION BEGINS. HAYNES HOME PLANS, INC. ASSUMES NO LIABILITY FOR CONTRACTOR PRACTICES AND PROCEDURES. CONDITIONS MAY VARY WITH LOCATION. A LOCAL DESIGNER, ARCHITECT OR ENGINEER SHOULD BE CONSULTED BEFORE CONSTRUCTION. THESE DRAWINGS ARE INSTRUMENTS OF SERVICE AND AS SUCH SHALL REMAIN PROPERTY OF THE DESIGNER.

SECOND FLOOR PLAN
THE GASTON II

HAYNES WEAVER HOMES
HOMES PLANS, INC.
910.630.2100 • 919.606.4696
3010 W. HARRISVILLE RD., SUITE 100, HARRISVILLE, NC 27546
P.O. BOX 702, WAKE FOREST, NC 27788 919.435.6180 fax 919.435.4066

SQUARE FOOTAGE	
HEATED	
FIRST FLOOR	274 SQ.FT.
SECOND FLOOR	264 SQ.FT.
PLAYROOM	28 SQ.FT.
TOTAL	566 SQ.FT.
UNHEATED	
FRONT PORCH	151 SQ.FT.
SCREENED	446 SQ.FT.
REAR PORCH	152 SQ.FT.
TOTAL	749 SQ.FT.

© Copyright 2016
Haynes Home Plans, Inc.
5/19/2020
181035B
PAGE 6 OF 8

PURCHASER MUST VERIFY ALL DIMENSIONS AND CONDITIONS BEFORE CONSTRUCTION BEGINS. HAYNES HOME PLANS, INC. ASSUMES NO LIABILITY FOR CONTRACTORS PRACTICES AND PROCEDURES. CODES AND CONDITIONS MAY VARY WITH LOCATION. A LOCAL DESIGNER/ARCHITECT OR ENGINEER SHOULD BE CONSULTED BEFORE CONSTRUCTION. THESE DRAWINGS ARE INSTRUMENTS OF SERVICE AND AS SUCH SHALL REMAIN PROPERTY OF THE DESIGNER.

ROOF PLAN
THE GASTON II

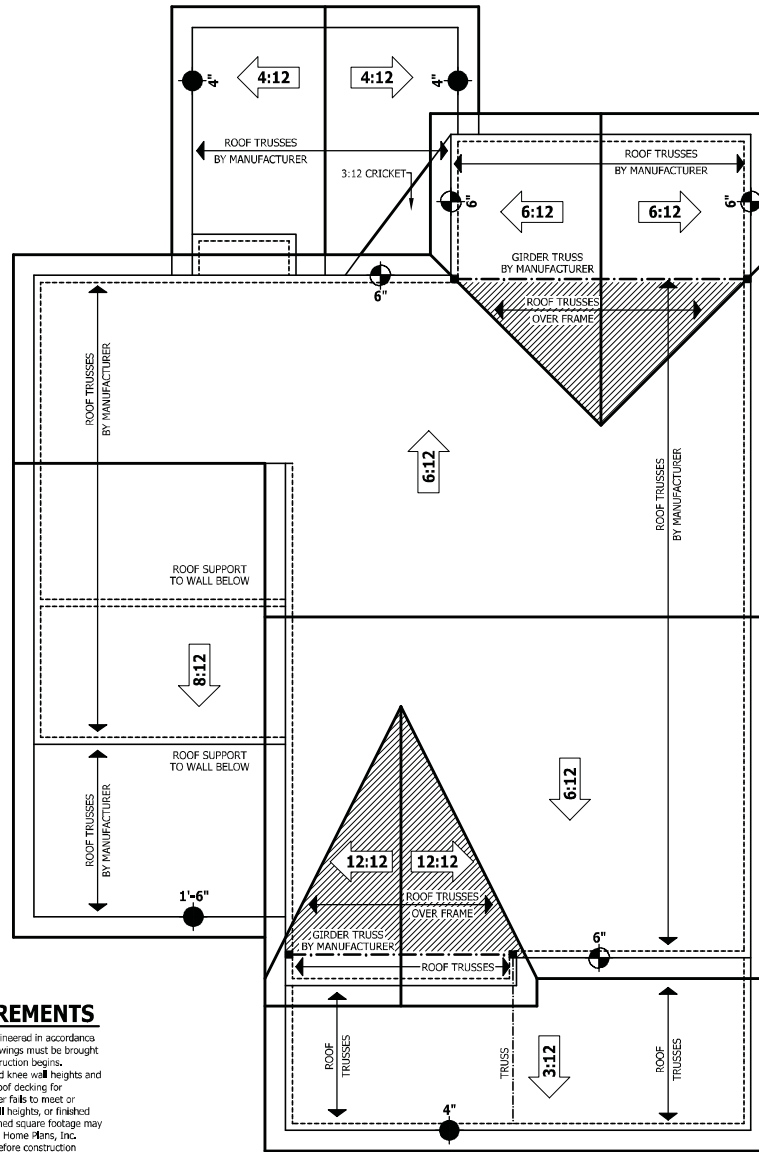

ROOF TRUSS REQUIREMENTS

TRUSS DESIGN. Trusses to be designed and engineered in accordance with these drawings. Any variation with these drawings must be brought to Haynes Home Plans, Inc. attention before construction begins.
KNEE WALL AND CEILING HEIGHTS. All finished knee wall heights and ceiling heights are shown furred down 10" from roof decking for insulation. If for any reason the truss manufacturer fails to meet or exceed designated heel heights, finished knee wall heights, or finished ceiling heights shown on these drawings the finished square footage may vary. Any discrepancy must be brought to Haynes Home Plans, Inc. attention, so a suitable solution can be reached before construction begins. Any variation due to these conditions not being met is the responsibility of the truss manufacturer.
ANCHORAGE. All required anchors for trusses due to uplift or bearing shall meet the requirements as specified on the truss schematics.
BEARING. All trusses shall be designed for bearing on SPF #2 planks or ledgers unless noted otherwise.
Plate Heights & Floor Systems. See elevation page(s) for plate heights and floor system thicknesses.

● HEEL HEIGHT ABOVE FIRST FLOOR PLATE ● HEEL HEIGHT ABOVE SECOND FLOOR PLATE

ROOF PLAN
SCALE 1/4" = 1'-0"

HAYNES
HOMB PLANS, INC.
P.O. Box 702, Pine Forest, NC 27568 919-439-6180 Fax 919-439-6106

SQUARE FOOTAGE	
HEATED	
FIRST FLOOR	274 SQ.FT.
SECOND FLOOR	264 SQ.FT.
PLAYROOM	38 SQ.FT.
TOTAL	576 SQ.FT.
UNHEATED	
FRONT PORCH	151 SQ.FT.
GARAGE	46 SQ.FT.
REAR PORCH	152 SQ.FT.
TOTAL	349 SQ.FT.

© Copyright 2016
Haynes Home Plans, Inc.
5/19/2020
181035B
PAGE 7 OF 8

Z:1 Builder Weaver Development Company, Inc 2001288 Gaston II 2001288 Gaston II

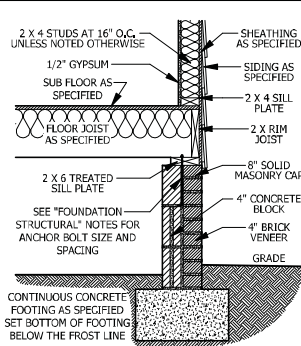

A CRAWL SPACE WALL
SCALE 3/4" = 1'-0"

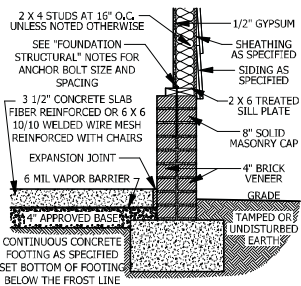

D GARAGE STEM WALL
SCALE 3/4" = 1'-0"

DECK STAIR NOTES

SECTION AM110
AM110.1 Stairs shall be constructed per Figure AM110. Stringer spans shall be no greater than 7 foot span between supports. Spacing between stringers shall be based upon decking material used per AM107.1. Each Stringer shall have minimum 3 1/2 inches between stay out and back of stringer. If used, suspended headers shall be attached with 3/8 inch galvanized bolts with nuts and washers to securely support stringers at the top.

DECK BRACING

SECTION AM109
AM109.1 Deck bracing. Decks shall be braced to provide lateral stability. The following are acceptable means to provide lateral stability.
AM109.1.1 When the deck floor height is less than 4'-0" above finished grade per Figure AM109 and the deck is attached to the structure in accordance with Section AM104, lateral bracing is not required.
AM109.1.2 4 x 4 wood knee braces may be provided on each column in both directions. The knee braces shall attach to each post at a point not less than 1/3 of the post length from the top of the post, and the braces shall be angled between 45 degrees and 60 degrees from the horizontal. Knee braces shall be bolted to the post and the girder/double band with one 5/8 inch hot dipped galvanized bolt with nut and washer at both ends of the brace per Figure AM109.1
AM109.1.3 For freestanding decks without knee braces or diagonal bracing, lateral stability may be provided by embedding the post in accordance with Figure AM109.2 and the following:

POST SIZE	MAX. POST TUBULAR HEIGHT	MAX. POST EMBEDMENT DEPTH	CONCRETE DIAMETER
4 x 4	48 SF	4'-0"	2'-6"
5 x 6	120 SF	6'-0"	3'-6"

AM109.1.4 2 x 6 diagonal vertical cross bracing may be provided in two perpendicular directions for freestanding decks or parallel to the structure at the exterior column line for attached decks. The 2 x 6's shall be attached to the posts with one 5/8 inch hot dipped galvanized bolt with nut and washer at each end of each bracing member per Figure AM109.3.
AM109.1.5 For embedment of piles in Coastal Regions, see Chapter 45.

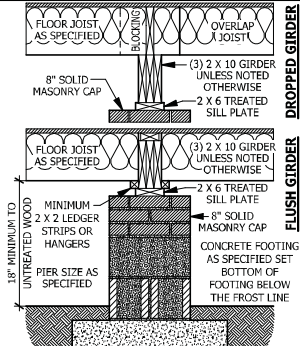

B DROPPED/ FLUSH PIER
SCALE 3/4" = 1'-0"

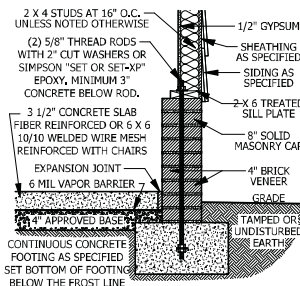

E <48\"/>

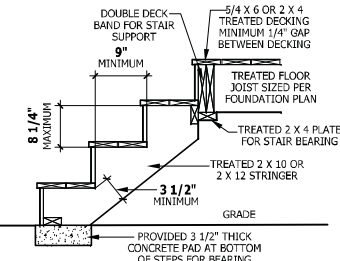
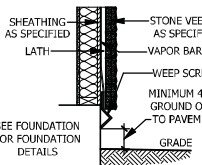

FIGURE AM110
TYPICAL DECK STAIR DETAIL
SCALE 3/4" = 1'-0"

WEEP SCREDS

All weep screeds and stone veneer to be installed per manufacturers instructions and per the 2012 North Carolina Residential Building code
R703.6.2.1 - A minimum 0.019-inch (0.5 mm) (No. 26 galvanized sheet gage), corrosion-resistant weep screed or plastic weep screed, with a minimum vertical attachment length of 3 1/2 inches (89 mm) shall be provided at or below the foundation plate line on exterior stud walls in accordance with ASTM C 926. The weep screed shall be placed a minimum of 4 inches (102 mm) above the earth or 2 inches (51 mm) above paved areas and shall be of a type that will allow trapped water to drain to the exterior of the building. The weather-resistant barrier shall lap the attachment flange. The exterior lath shall cover and terminate on the attachment flange of the weep screed.



WEEP SCREED
SCALE 3/4" = 1'-0"

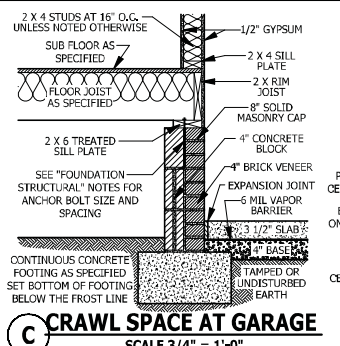

C CRAWL SPACE AT GARAGE
SCALE 3/4" = 1'-0"

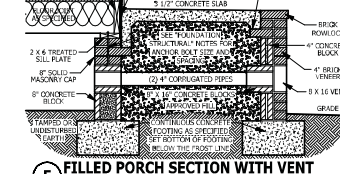

F FILLED PORCH SECTION WITH VENT
SCALE 1/2" = 1'-0"

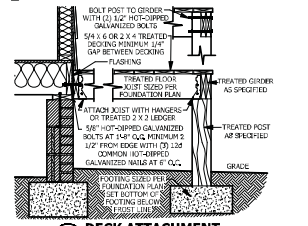

G DECK ATTACHMENT
SCALE 1/2" = 1'-0"

SMOKE ALARMS

SECTION R314
R314.1 Smoke detection and notification. All smoke alarms shall be listed in accordance with UL 217 and installed in accordance with the provisions of this code and this household fire warning equipment provisions of NFPA 72.
R314.2 Smoke detection systems. Household fire alarm systems installed in accordance with NFPA 72 that include smoke alarms, or a combination of smoke detector and audible notification device installed as required by this section for smoke alarms, shall be permitted. The household fire alarm system shall provide the same level of smoke detection and alarm as required by this section for smoke alarms. Where a household fire warning system is installed using a combination of smoke detector and audible notification devices, it shall become a permanent fixture of the occupancy and owned by the homeowner. The system shall be monitored by an approved supervising station and be maintained in accordance with NFPA 72.
Exception: Where smoke alarms are provided meeting the requirements of Section R314.4,
R314.3 Location. Smoke alarms shall be installed in the following locations:
1. In each sleeping room.
2. Outside each separate sleeping area in the immediate vicinity of the bedrooms.
3. On each additional story of the dwelling including basements and habitable attics (finished but not including crawl spaces, uninhabitable (unfinished) attics and uninhabitable (unfinished) stories. In dwellings or dwelling units with split levels and without an intervening door between the adjacent levels, a smoke alarm installed on the upper level shall suffice for the adjacent lower level provided that the lower level is less than one full story below the upper level.
When more than one smoke alarm is required to be installed within an individual dwelling unit the alarm devices shall be interconnected in such a manner that the actuation of one alarm will activate all of the alarms in the individual unit.
Exception: A secondary smoke alarm may be installed in the unit.
R314.4 Power source. Smoke alarms shall receive their primary power from the building wiring when such wiring is served from a commercial source, and when primary power is interrupted, shall receive power from a battery. Wiring shall be permanent and without a disconnecting switch other than those required for overcurrent protection. Smoke alarms shall be interconnected.

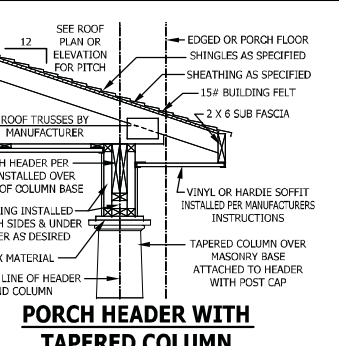

PORCH HEADER WITH TAPERED COLUMN
SCALE 3/4" = 1'-0"

CARBON MONOXIDE ALARMS

SECTION R315
R315.1 Carbon monoxide alarms. In new construction, dwelling units shall be provided with an approved carbon monoxide alarm installed outside of each separate sleeping area in the immediate vicinity of the bedroom(s) as directed by the alarm manufacturer.
R315.2 Where required in existing dwellings. In existing dwellings, where interior alterations, repairs, fuel-fired appliance replacements, or additions requiring a permit occur, or where one or more sleeping rooms are added or created, carbon monoxide alarms shall be provided in accordance with Section 315.1.
R315.3 Alarm requirements. The required carbon monoxide alarms shall be audible in all bedrooms over background noise levels with no intervening doors closed. Single station carbon monoxide alarms shall be listed as complying with UL 2034 and shall be installed in accordance with this code and the manufacturer's installation instructions.

STAIRWAY NOTES

R311.7
R311.7.2 Headroom. The minimum headroom in all parts of the stairway shall not be less than 6 feet 8 inches (2032 mm) measured vertically from the sloped line adjoining the tread nosing or from the floor surface of the landing or platform on that portion of the stairway.
R311.7.4 Stair treads and risers. Stair treads and risers shall meet the requirements of this section. For the purposes of this section all dimensions and dimensional surfaces shall be exclusive of carpets, rugs or runners.
R311.7.4.1 Riser height. The maximum riser height shall be 8 1/4 inches (210 mm). The riser shall be measured vertically between leading edges of the adjacent treads.
R311.7.4.2 Tread depth. The minimum tread depth shall be 9 inches (229 mm). The tread depth shall be measured horizontally between the vertical planes of the foremost projection of adjacent treads and at a right angle to the tread's leading edge. Winder treads shall have a minimum tread depth of 9 inches (229 mm) measured as above at a point 12 inches (305 mm) from the side where the treads are narrower. Winder treads shall have a minimum tread depth of 4 inches (102 mm) at any point.
R311.7.4.3 Profile. The radius of curvature at the nosing shall be no greater than 9/16 inch (14 mm), a nosing not less than 3/4 inch (19 mm) but not more than 1 1/4 inches (32 mm) shall be provided on stairways with solid risers.
R311.7.7 Handrails. Handrails shall be provided on at least one side of each continuous flight of stairs with four or more risers.
R311.7.7.1 Height. Handrails height, measured vertically from the sloped plane adjoining the tread nosing, or finish surface of ramp slope, shall not be less than 34 inches (864 mm) and not more than 38 inches (965 mm).
Exceptions:
1. The use of a volute, turnout or starting easing shall be allowed over the lowest tread.
2. When hand-rail fittings or bindings are used to provide continuous transition between flights, the transition from fittings to guardrail, or used at the start of a flight, the hand rail height at the fittings or bindings shall be permitted to exceed the maximum height.
R311.7.7.2 Continuity. Handrails for stairways shall be continuous for the full length of the flight, from a point directly above the top riser of the flight to a point directly above the lowest riser of the flight. Hand rail ends shall be returned or shall terminate in newel posts or safety terminals. Handrails adjacent to a wall shall have a space of not less than 1 1/2 inch (38 mm) between the wall and the handrails.
Exceptions:
1. Handrails shall be permitted to be interrupted by a newel post.
2. The use of a volute, turnout, starting easing or starting newel shall be allowed over the lowest tread.
3. Two or more separate handrails shall be considered continuous if the termination of the rails occurs within 6 inches (152 mm) of each other. If the transition between a wall-mounted handrail and a guardrail handrail, the wall-mounted rail must return into the wall.

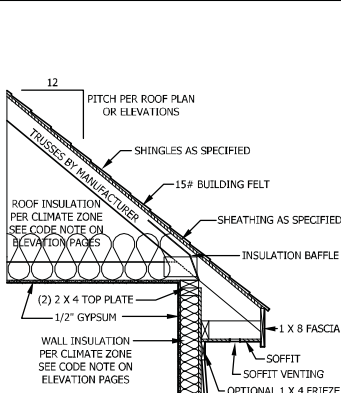

TYPICAL WALL DETAIL
SCALE 3/4" = 1'-0"

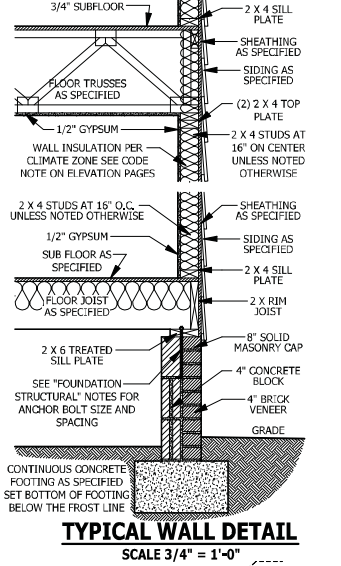

TYPICAL STAIR DETAIL
SCALE 1/4" = 1'-0"

PURCHASER MUST VERIFY ALL DIMENSIONS AND CONDITIONS BEFORE CONSTRUCTION BEGINS. HAYNES HOME PLANS, INC. ASSUMES NO LIABILITY FOR CONTRACTOR PRACTICES AND PROCEDURES. NOTES AND CONDITIONS MAY VARY WITH LOCATION. A LOCAL DESIGNER/ARCHITECT/ENGINEER SHOULD BE CONSULTED BEFORE CONSTRUCTION. THESE DRAWINGS ARE INSTRUMENTS OF SERVICE AND AS SUCH SHALL REMAIN PROPERTY OF THE DESIGNER.

TYPICAL DETAILS

HAYNES WEAVER HOMES

HOMB PLANS INC.

SQUARE FOOTAGE

HEATED FIRST FLOOR	776 SQ.FT.
HEATED SECOND FLOOR	264 SQ.FT.
UNHEATED PORCH	28 SQ.FT.
UNHEATED FRONT PORCH	182 SQ.FT.
UNHEATED GARAGE	151 SQ.FT.
UNHEATED REAR PORCH	170 SQ.FT.
TOTAL	1571 SQ.FT.

Z:\Builder\Weaver Development Company, Inc\2001288 Gaston II\2001288 Gaston II.aec

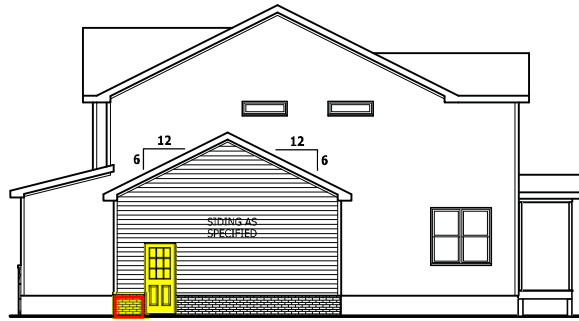

SIDE ELEVATION
SCALE 1/8" = 1'-0"



FRONT ELEVATION
SCALE 1/8" = 1'-0"

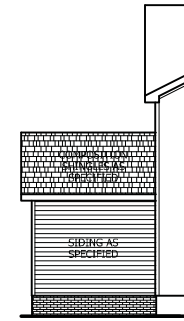

REAR ELEVATION
SCALE 1/8" = 1'-0"

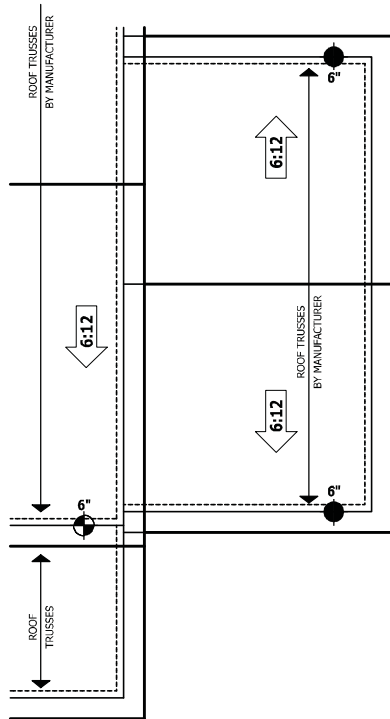

ROOF PLAN
SCALE 1/4" = 1'-0"

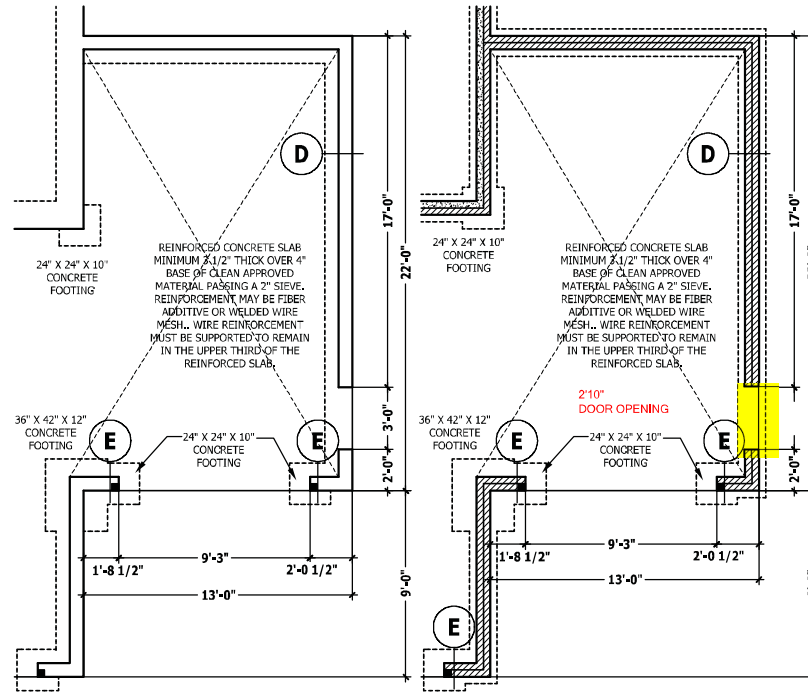

MONOLITHIC SLAB PLAN
SCALE 1/4" = 1'-0"

CRAWL SPACE / STEM WALL
SCALE 1/4" = 1'-0"

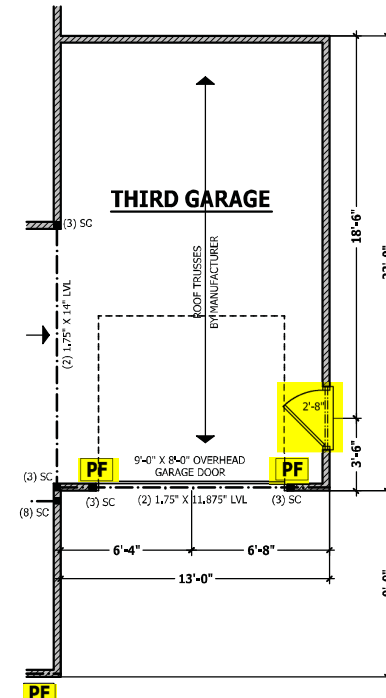

FIRST FLOOR PLAN
SCALE 1/4" = 1'-0"

PURCHASER MUST VERIFY ALL DIMENSIONS AND CONDITIONS BEFORE CONSTRUCTION BEGINS. HAYNES HOME PLANS, INC. ASSUMES NO LIABILITY FOR CONTRACTOR PRACTICES AND PROCEDURES. CONDITIONS MAY VARY WITH LOCATION. A LOCAL DESIGNER/ARCHITECT OR ENGINEER SHOULD BE CONSULTED BEFORE CONSTRUCTION. THESE DRAWINGS ARE INSTRUMENTS OF SERVICE AND AS SUCH SHALL REMAIN PROPERTY OF THE DESIGNER.

FRONT LOAD THIRD CAR
THE GASTON II

HAYNES WEAVER HOMES
HOMB PLANS, INC.
910.630.2100 • 919.606.4696
301 Weaver Home, Matthews, NC 28105
P.O. Box 709, Pine Forest, NC 27888 919.439.6180 Fax 919.439.4096

SQUARE FOOTAGE

HEATED	
FIRST FLOOR	776 SQ.FT.
SECOND FLOOR	264 SQ.FT.
REAR PORCH	28 SQ.FT.
TOTAL	1068 SQ.FT.
UNHEATED	
FRONT PORCH	151 SQ.FT.
GARAGE	468 SQ.FT.
REAR PORCH	152 SQ.FT.
TOTAL	771 SQ.FT.

© Copyright 2016
Haynes Home Plans, Inc.
5/19/2020
181035B
ADDENDUM