

WILMINGTON -A, B, C

PLAN ID: 2800 - LEFT HAND - NORTH CAROLINA

DATE:	REVISION:
09/18/2017	INITIAL RELEASE OF PLANS
10/20/2017	CLIENT REVISIONS
11/01/2017	REMOVED PORCH RAILING FROM ELEVATION 'C' FLATTENED BAR TOP AT KITCHEN REVISED SIZE OF WINDOW AT BASE OF STAIRS REVISED MASTER BEDROOM TO OWNER'S BEDROOM
02/07/2018	ELECTRICAL REVISIONS
06/11/2018	CLIENT REVISIONS
11/14/2018	CLIENT REVISIONS
01/09/2019	REVISED CODE REFERENCES
07/23/2019	CLIENT REVISIONS
12/13/2019	CLIENT REVISIONS
02/28/2020	CLIENT REVISIONS

SHEET INDEX:

CS	ARCHITECTURALS - COVERSHEET
0	ARCHITECTURALS - QUICK VIEW
1A	ARCHITECTURALS - ELEVATIONS A
1B	ARCHITECTURALS - ELEVATIONS B
1C	ARCHITECTURALS - ELEVATIONS C
3A	ARCHITECTURALS - FLOOR PLANS A
3B	ARCHITECTURALS - FLOOR PLANS B
3C	ARCHITECTURALS - FLOOR PLANS C
4	ELECTRICAL - FLOOR PLANS

REVIEWERS STAMP LOCATION

MODEL 'WILMINGTON' SQUARE FOOTAGES		
AREA		ELEV 'C'
1st FLOOR		1225 SF
2nd FLOOR		1595 SF
TOTAL LIVING		2820
GARAGE		411 SF
PORCH		72 SF

MORGAN NORTH LOT 44
118 YOUNG FARM DRIVE
LILLINGTON, NC 27546



COVERSHEET	'WILMINGTON'
------------	--------------

PLAN REV DATE	02.28.20
---------------	----------

SHEET NUMBER	CS
--------------	----

N.C ATTIC VENT CALCULATION FOR MODEL 'WILMINGTON': 1:150 RATIO.

THE NET FREE VENTILATING AREA SHALL NOT BE LESS THAN 1/150 OF THE AREA OF THE SPACE VENTILATED, PROVIDED THAT AT LEAST 50 PERCENT AND NOT MORE THAN 80 PERCENT OF THE REQUIRED VENTILATING AREA IS PROVIDED BY VENTILATORS LOCATED IN THE UPPER PORTION OF THE SPACE TO BE VENTILATED AT LEAST 3 FEET ABOVE THE EAVE OR CORNICE VENTS WITH THE BALANCE OF THE REQUIRED VENTILATING PROVIDED BY EAVE OR CORNICE VENTS.

(PER N.C.R.C. SECTION R302.2)
1 SQUARE INCH VENT FOR EVERY 150 SQUARE INCHES OF CEILING *144 SQ. IN. = 1 SQ. FT.
BLDG. CEILING (SF) X 144 = BLDG (SQ. IN.)
BLDG. (SQ. IN.) / 150 = 50. IN. OF VENT REQUIRED
50. IN. OF VENT REQUIRED / 2 = 50% AT HIGH & 50% AT LOW.

EXCEPTIONS:
1. ENCLOSED ATTIC/RAFTER SPACES REQUIRING LESS THAN 1 SQ. FT. OF VENTILATION MAY BE VENTED WITH CONTINUOUS SOFFIT VENTILATION ONLY.
2. ENCLOSED ATTIC/RAFTER SPACES OVER UNCONDITIONED SPACE MAY BE VENTED WITH CONTINUOUS SOFFIT VENT ONLY.

ROOF AREA 1 = 1781 SF
1636 SQ. FT. X 144 = 235584 SQ. IN.
235584 SQ. IN. / 150 = 157056 SQ. IN. OF VENT REQ'D
157056 SQ. IN. / 2 = 78528 SQ. IN. OF VENT AT LOW REQUIRED.

GENERAL CONTRACTOR SHALL VERIFY THE NET FREE VENTILATION OF THE VENT PRODUCT SELECTED BY OWNER. VERIFY WITH MANUFACTURER OF HIGH AND LOW VENTS TO BE USED FOR MINIMUM CALCULATED VENTS REQUIRED. THE REQUIRED VENTILATION SHALL BE MAINTAINED. PROVIDE INSULATION STOP SUCH THAT INSULATION DOES NOT OBSTRUCT FREE AIR MOVEMENT AS REQUIRED BY THE BUILDING OFFICIAL.

ROOF AREA 2 = 12 SF
12 SQ. FT. X 144 = 1728 SQ. IN.
1728 SQ. IN. / 150 = 11.52 SQ. IN. OF VENT REQ'D
11.52 SQ. IN. / 2 = 5.76 SQ. IN. OF VENT AT LOW REQUIRED.

ALL OVERLAP FRAMED ROOF AREAS SHALL HAVE OPENINGS BETWEEN THE ADJACENT ATTICS IN THE ROOF SHEATHING (AS ALLOWED BY THE STRUCTURAL ENGINEER) TO ALLOW PASSAGE AND ATTIC VENTILATION. BETWEEN THE TWO OR ISOLATED ATTIC SPACES SHALL BE VENTED INDEPENDENTLY TO CBC REQUIREMENTS.
PER DEVELOPER, AT ALL CANTILEVERED FLOORS, CANTILEVERED ARCHITECTURAL POP-OUTS, AND ANY DOUBLE TRAPPING PROJECTIONS THAT ARE SEPARATED FROM THE VENTING CALCULATIONS SHOWN ABOVE, PROVIDE A CONTINUOUS 2" CORROSION RESISTANT SOFFIT VENT AT UNDERSIDE OF FRAMED ELEMENT.

ALL OVERLAP FRAMED ROOF AREAS SHALL HAVE OPENINGS BETWEEN THE ADJACENT ATTICS IN THE ROOF SHEATHING (AS ALLOWED BY THE STRUCTURAL ENGINEER) TO ALLOW PASSAGE AND ATTIC VENTILATION. BETWEEN THE TWO OR ISOLATED ATTIC SPACES SHALL BE VENTED INDEPENDENTLY TO CBC REQUIREMENTS.
PER DEVELOPER, AT ALL CANTILEVERED FLOORS, CANTILEVERED ARCHITECTURAL POP-OUTS, AND ANY DOUBLE TRAPPING PROJECTIONS THAT ARE SEPARATED FROM THE VENTING CALCULATIONS SHOWN ABOVE, PROVIDE A CONTINUOUS 2" CORROSION RESISTANT SOFFIT VENT AT UNDERSIDE OF FRAMED ELEMENT.

NOTES:
- ALL ROOF DRAINAGE SHALL BE PIPED TO STREET OR APPROVED DRAINAGE FACILITY.
- DASHED LINES INDICATE WALL BELOW.
- LOCATE GUTTER AND DOWNSPOUTS PER BUILDER.
- PITCHED ROOFS AS NOTED.

- TRUSS MANUFACTURER SHALL SUBMIT STRUCTURAL CALC'S AND SHOP DRAWINGS TO THE BUILDER'S GENERAL CONTRACTOR AND BUILDING DEPARTMENT FOR REVIEW PRIOR TO FABRICATION.
- ALL PLUMBING VENTS SHALL BE COMBINED INTO A MINIMUM AMOUNT OF ROOF PENETRATIONS. ALL ROOF PENETRATIONS SHALL OCCUR TO THE REAR OF THE MAIN RIDGE.

N.C ATTIC VENT CALCULATION FOR MODEL 'WILMINGTON': 1:300 RATIO

AS AN ALTERNATE TO THE 1/150 RATIO LISTED ABOVE, THE NET FREE CROSS-VENTILATION AREA MAY BE REDUCED TO 1/300 WHEN A CLASS I OR II VAPOR RETARDER IS INSTALLED ON THE HANDED - IN - WINDERS SIDE OF THE CEILING.

(PER N.C.R.C. SECTION R302.2)
1 SQUARE INCH VENT FOR EVERY 300 SQUARE INCHES OF CEILING *144 SQ. IN. = 1 SQ. FT.
BLDG. CEILING (SF) X 144 = BLDG (SQ. IN.)
BLDG. (SQ. IN.) / 300 = 50. IN. OF VENT REQUIRED
50. IN. OF VENT REQUIRED / 2 = 50% AT HIGH & 50% AT LOW.

GENERAL CONTRACTOR SHALL VERIFY THE NET FREE VENTILATION OF THE VENT PRODUCT SELECTED BY OWNER. VERIFY WITH MANUFACTURER OF HIGH AND LOW VENTS TO BE USED FOR MINIMUM CALCULATED VENTS REQUIRED. THE REQUIRED VENTILATION SHALL BE MAINTAINED. PROVIDE INSULATION STOP SUCH THAT INSULATION DOES NOT OBSTRUCT FREE AIR MOVEMENT AS REQUIRED BY THE BUILDING OFFICIAL.

ROOF AREA 1 = 1636 SF
1636 SQ. FT. X 144 = 235584 SQ. IN.
235584 SQ. IN. / 300 = 78528 SQ. IN. OF VENT REQ'D
78528 SQ. IN. / 2 = 39264 SQ. IN. OF VENT AT LOW REQUIRED.

ALL OVERLAP FRAMED ROOF AREAS SHALL HAVE OPENINGS BETWEEN THE ADJACENT ATTICS IN THE ROOF SHEATHING (AS ALLOWED BY THE STRUCTURAL ENGINEER) TO ALLOW PASSAGE AND ATTIC VENTILATION. BETWEEN THE TWO OR ISOLATED ATTIC SPACES SHALL BE VENTED INDEPENDENTLY TO CBC REQUIREMENTS.
PER DEVELOPER, AT ALL CANTILEVERED FLOORS, CANTILEVERED ARCHITECTURAL POP-OUTS, AND ANY DOUBLE TRAPPING PROJECTIONS THAT ARE SEPARATED FROM THE VENTING CALCULATIONS SHOWN ABOVE, PROVIDE A CONTINUOUS 2" CORROSION RESISTANT SOFFIT VENT AT UNDERSIDE OF FRAMED ELEMENT.

ROOF AREA 2 = 12 SF
12 SQ. FT. X 144 = 1728 SQ. IN.
1728 SQ. IN. / 300 = 5.76 SQ. IN. OF VENT REQ'D
5.76 SQ. IN. / 2 = 2.88 SQ. IN. OF VENT AT LOW REQUIRED.

NOTES:
- GRADE CONDITIONS MAY VARY FOR INDIVIDUAL SITE FROM THAT SHOWN. BUILDER SHALL VERIFY AND COORDINATE PER ACTUAL SITE CONDITIONS.
- WINDOW HEAD HEIGHTS:
1ST FLOOR = 6'-8" UNO. ON ELEVATIONS.
2ND FLOOR = 7'-0" UNO. ON ELEVATIONS.
- ROOFING: PITCHED SHINGLES PER DEVELOPER.
- WINDOWS: MANUFACTURER PER DEVELOPER. DIVIDED LITES AS SHOWN ON THE EXTERIOR ELEVATIONS
- ENTRY DOOR: AS SELECTED BY DEVELOPER.
- GARAGE DOORS: AS SELECTED BY DEVELOPER, RAISED PANEL AS SHOWN.
- ALL EXTERIOR MATERIALS TO BE INSTALLED PER MANUFACTURER'S WRITTEN INSTRUCTIONS.
- PROTECTION AGAINST DECAY:
(ALL PORTIONS OF A PORCH, SCREEN PORCH OR DECK FROM THE BOTTOM OF THE HEADER DOWN, INCLUDING POST, RAILS, PICKETS, STEPS AND FLOOR STRUCTURE.)
- INSULATION PER TABLE N102.1.2.
EXTERIOR WALLS: R-15 BATTS MINIMUM. VERIFY
CEILING WITH ATTIC ABOVE: R-38 BATTS MINIMUM. VERIFY
FLOOR OVER GARAGE: R-19 BATTS MINIMUM. VERIFY
ATTIC KNEEWALL: R-19 BATTS MINIMUM. VERIFY
CRANK SPACE FLOORING: R-19 BATTS MINIMUM. VERIFY

TRUSS MANUFACTURE TO VERIFY HEELS PER COMMUNITY STANDARDS, BUILDER TO VERIFY PRIOR TO CONSTRUCTION

KEY NOTES:
MASONRY:
1) ADHERED STONE VENEER AS SELECTED BY DEVELOPER. HEIGHT AS NOTED.
2) MASONRY FULL BRICK AS SELECTED BY DEVELOPER. HEIGHT AS NOTED.
3) MASONRY FULL STONE AS SELECTED BY DEVELOPER. HEIGHT AS NOTED.
4) 8" SOLDIER COURSE.
5) ROWLOCK COURSE
6) N/A
TYPICALS:
7) CORROSION RESISTANT SCREEN LOUVERED VENTS, SIZE AS NOTED.
8) CODE APPROVED TERMINATION CHIMNEY CAP.
9) CORROSION RESISTANT ROOF TO WALL FLASHING. CODE COMPLIANT FLASHING PER N.C.R.C. R405.2.8.3

10) STANDING SEAM METAL ROOF, INSTALL PER MANUFACTURER'S WRITTEN INSTRUCTIONS.
11) DECORATIVE WROUGHT IRON. SEE DETAILS.
SIDING:
12) VINYL SHAKE SIDING PER DEVELOPER WITH VINYL CORNER TRIM PER DEVELOPER. (AT SPECIFIED LOCATIONS: FIBER CEMENT SHAKE SIDING PER DEVELOPER W/ 1X4 CORNER TRIM BOARD.)
13) VINYL LAP SIDING PER DEVELOPER WITH VINYL CORNER TRIM PER DEVELOPER. (AT SPECIFIED LOCATIONS: FIBER CEMENT LAP SIDING PER DEVELOPER W/ 1X4 CORNER TRIM BOARD.)
14) VINYL NAVY SIDING PER DEVELOPER WITH VINYL CORNER TRIM PER DEVELOPER. (AT SPECIFIED LOCATIONS: FIBER CEMENT NAVY SIDING PER DEVELOPER W/ 1X4 CORNER TRIM BOARD.)
15) VINYL BOARD AND BATT SIDING PER DEVELOPER WITH VINYL CORNER TRIM PER DEVELOPER. (AT SPECIFIED LOCATIONS: FIBER CEMENT PANEL SIDING W/ 1X3 BATTS AT 12" O.C. PER DEVELOPER W/ 1X4 CORNER TRIM BOARD.)
16) VINYL TRIM SIZE AS NOTED (AT SPECIFIC LOCATIONS: 1X FIBER CEMENT TRIM OR EQUAL, UNO. SIZE AS NOTED)
17) PYPON SHUTTERS, TYPE AS SHOWN. SIZE AS NOTED.
(AT SPECIFIC LOCATIONS: FALSE VINYL SHUTTERS, TYPE AS SHOWN. SIZE AS NOTED.)

ALL WINDOWS WHOSE OPENING IS LESS THAN 24" ABOVE THE FINISH FLOOR AND WHOSE OPENING IS GREATER THAN 12" ABOVE THE OUTSIDE WALKING SURFACE MUST HAVE WINDOW OPENING LIMITING DEVICES COMPLYING WITH THE N.C.R.C. SECTION R312.2.1 AND R312.2.2.

TRUSS MANUFACTURE TO VERIFY HEELS PER COMMUNITY STANDARDS, BUILDER TO VERIFY PRIOR TO CONSTRUCTION

TRUSS MANUFACTURE TO VERIFY HEELS PER COMMUNITY STANDARDS, BUILDER TO VERIFY PRIOR TO CONSTRUCTION

TRUSS MANUFACTURE TO VERIFY HEELS PER COMMUNITY STANDARDS, BUILDER TO VERIFY PRIOR TO CONSTRUCTION

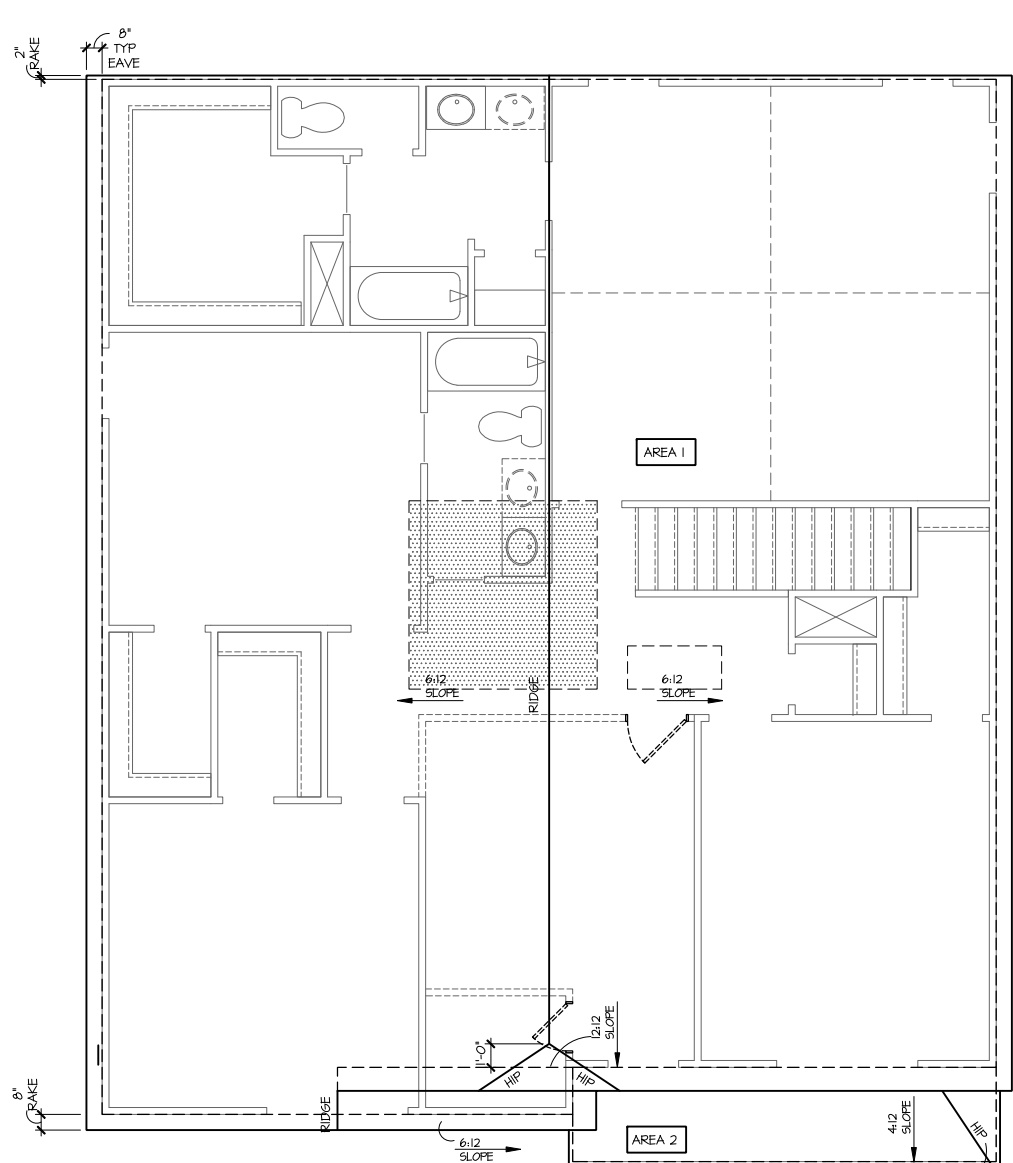

Roof Plan 'C'
SCALE: 1/4"=1'-0" AT 22"x34" LAYOUT 1/8"=1'-0" AT 11"x11" LAYOUT

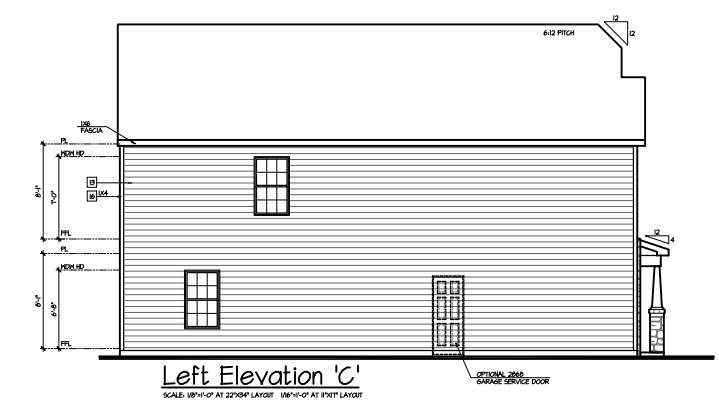

Left Elevation 'C'
SCALE: 1/8"=1'-0" AT 22"x34" LAYOUT 1/8"=1'-0" AT 11"x11" LAYOUT

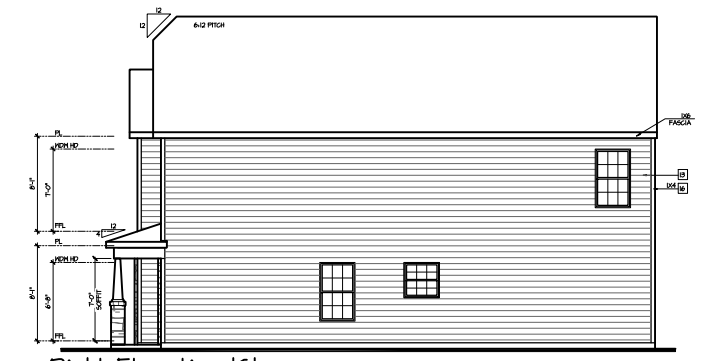

Right Elevation 'C'
SCALE: 1/8"=1'-0" AT 22"x34" LAYOUT 1/8"=1'-0" AT 11"x11" LAYOUT

AVAILABLE WITH OPTIONAL 9'-1" FIRST FLOOR PLATE
NOTES AT OPT 9'-1" PLT:
- WDW HT SET AT 7'-6"
- INTERIOR SOFFITS AT 8'-0"
- EXTERIOR SOFFITS AT 8'-0"

AT SINGLE FAMILY DETACHED PLANS: PREFINISHED VENTED SOFFIT AT EAVE PER MANUFACTURER. (VERIFY FIRE SEPARATION DISTANCE FOR SOFFIT PROTECTION PER N.C.R.C. SECTION R302.1.1 AND TABLE R302.1)

VENEER CALCULATIONS:
HARDBOARD = 351 SQ FT
MASONRY = 183 SQ FT
MASONRY % = 34%



Rear Elevation 'C'
SCALE: 1/8"=1'-0" AT 22"x34" LAYOUT 1/8"=1'-0" AT 11"x11" LAYOUT



Front Elevation 'C'
SCALE: 1/4"=1'-0" AT 22"x34" LAYOUT 1/8"=1'-0" AT 11"x11" LAYOUT

Express HOMES
America's Builder

ELEVATIONS
'WILMINGTON'

PLAN REV DATE
02.28.20

SHEET NUMBER
1C

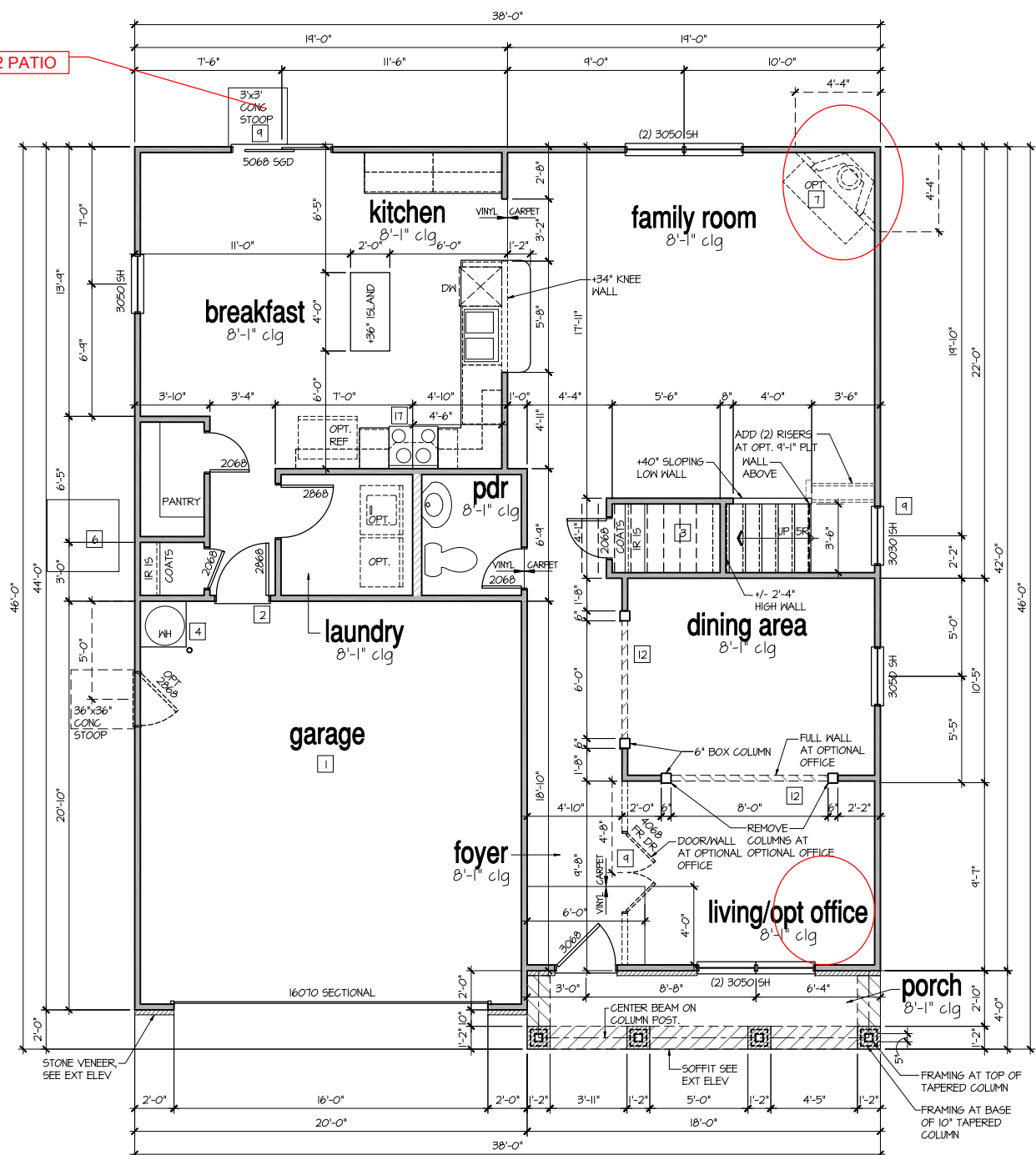
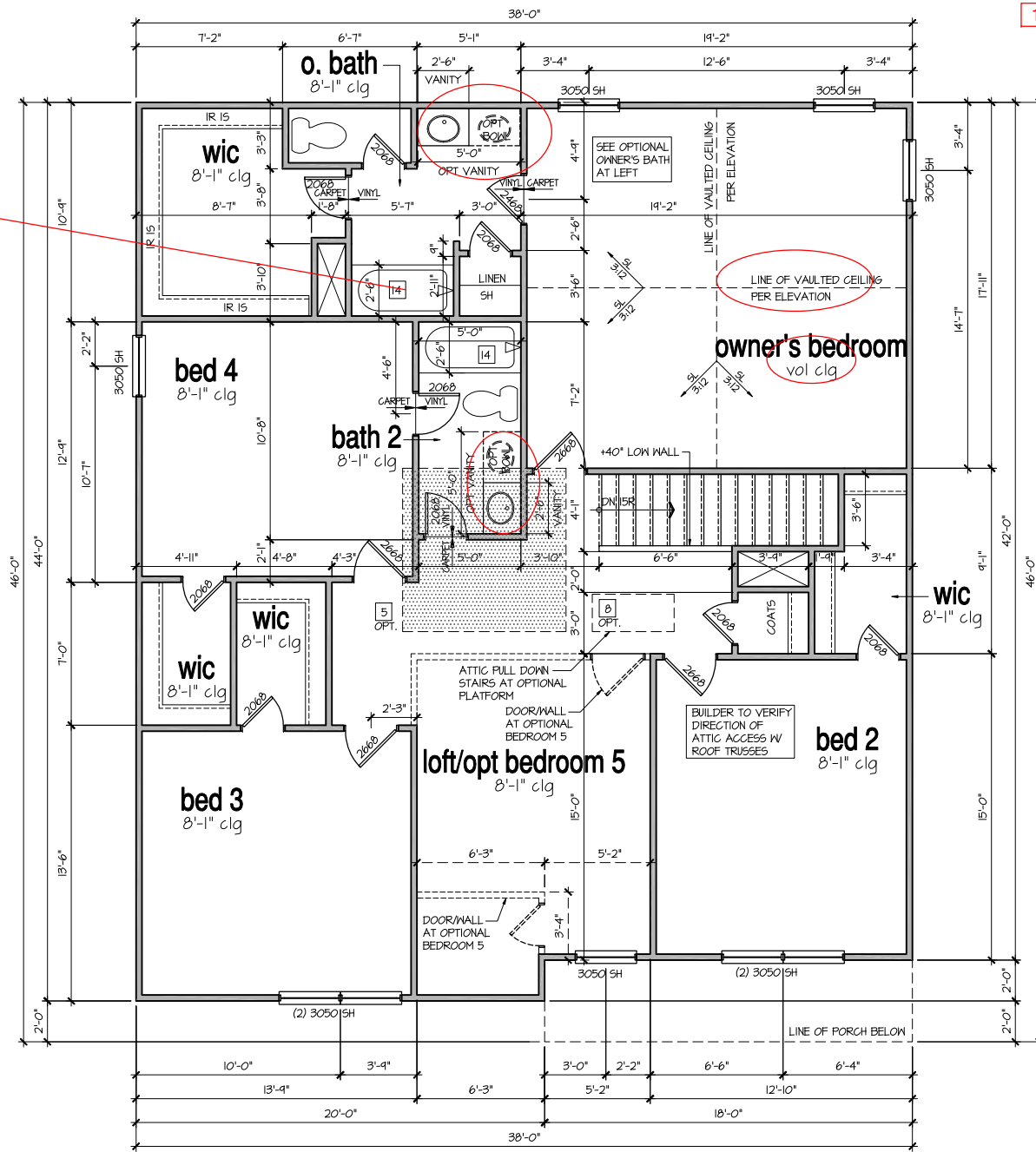

5' SHOWER ILO STD. TUB

9'-1" STAIR NOTE:
 (USE 14" TJI WITH 3/4" PLYWOOD SUBFLOOR)
 16 TREADS AT 10" EACH VERIFY
 17 RISERS AT +/- 7.27" = 123 3/4" TOTAL
 RISE VERIFY

8'-1" STAIR NOTE:
 (USE 14" TJI WITH 3/4" PLYWOOD SUBFLOOR)
 14 TREADS AT 10" EACH VERIFY
 15 RISERS AT +/- 7.45" = 111 3/4" TOTAL
 RISE VERIFY

AVAILABLE WITH OPTIONAL
 9'-1" FIRST FLOOR PLATE

NOTES AT OPT 9'-1" PLT:
 - WDW HT SET AT 7'-6"
 - INTERIOR SOFFITS AT 8'-0"
 - EXTERIOR SOFFITS AT 8'-0"

- FOR ADDITIONAL NOTES SEE GENERAL NOTES ON TITLE SHEET AND DETAILS.
 - WINDOW HEAD HEIGHTS:
 1ST FLOOR = 6'-8" U.N.O. ON ELEVATIONS.
 2ND FLOOR = 7'-0" U.N.O. ON ELEVATIONS.

ALL DIMENSIONS TO WINDOWS AND DOORS ARE TO CENTERLINE.

WALL LEGEND:

FULL HEIGHT 2X4 WOOD STUD PARTITION	FULL HEIGHT 2X6 WOOD STUD PARTITION
BRICK / STONE VENEER	STUD WALL BELOW HEIGHT AND STUD SIZE AS NOTED
LOW GYPSUM BOARD WALL HEIGHT AND STUD SIZE AS NOTED	DRYWALL OPENING HEIGHT AS NOTED ON PLAN

- KEY NOTES FOR NORTH CAROLINA:**
- HOUSE TO GARAGE FIRE SEPARATION. GARAGE/HOUSE SEPARATION AT VERTICAL SURFACES SHALL BE PROTECTED WITH ONE (1) LAYER 1/2" GYPSUM BOARD. (PER N.C.R.C. TABLE R302.6.) GARAGE/HOUSE SEPARATION AT HORIZONTAL SURFACES SHALL BE PROTECTED WITH ONE (1) LAYER 5/8" TYPE 'X' GYPSUM BOARD. (PER N.C.R.C. TABLE R302.6.)
 - HOUSE TO GARAGE DOOR SEPARATION. PROVIDE 1-3/8" SOLID CORE DOOR OR APPROVED 20 MINUTE RATED DOOR. (PER N.C.R.C. SECTION R302.5.1.)
 - BENEATH STAIRS AND LANDINGS, 1/2" GYPSUM BOARD ON WALLS AND CEILING OF ENCLOSED ACCESSIBLE AREAS. (PER N.C.R.C. SECTION R302.1.) IN CONCEALED SPACES BETWEEN STAIR STRINGERS PROVIDE FIREBLOCKING PER R302.11
 - M.E.P.'S
 - GAS WATER HEATER ON 18" HIGH PLATFORM. (PER CHAPTER 5, N.C.R.C. PLUMBING)
 - FAU 8'X8' PLATFORM. VERIFY WITH TRUSS MANUFACTURER. (6'-6" MIN. CLEAR HEIGHT TO HORIZONTAL MEMBERS, 2'X6" OVER 2'X4" BOTTOM CHORD. OF TRUSS, VERIFY W/ TRUSSES.)
 - A/C CONDENSER PAD. (VERIFY)
 - PRE-FABRICATED METAL FIREPLACE. INSTALL PER MANUFACTURER'S WRITTEN INSTRUCTIONS.
 - ATTIC ACCESS LARGE ENOUGH TO REMOVE LARGEST PIECE OF EQUIPMENT BUT NOT LESS THAN 30"X22". FIRE RATED ACCESS AS NOTED. (PER N.C.R.C. 801.1) ATTIC ACCESS LADDER. VERIFY LOCATION AND SIZE WITH TRUSSES. (25 1/2" X 54" SIZE) FOR GARAGE TO ATTIC SEPARATION PER N.C.R.C. 302.5.1 EXCEPTION.
 - TEMPERED SAFETY GLASS. (PER N.C.R.C. SECTION 308.4)
 - PLYWOOD SHELF ABOVE WITH DRYWALL FINISH OVER. HEIGHT AS NOTED.
 - HALF WALL, HEIGHT AS NOTED.
 - INTERIOR SOFFITS. FFL = 8'-1" U.N.O. SFL = 7'-6" U.N.O. BATHS:
 - SHOWER. TEMPERED GLASS ENCLOSURE.
 - TUB-SHOWER COMBO. TEMPERED GLASS ENCLOSURE.
 - CERAMIC TILE SHOWER AND FLOOR. TEMPERED GLASS ENCLOSURE.
 - ACRYLIC TUB W/ CERAMIC PLATFORM
 - 30" SLIDE-IN ELECTRICAL RANGE W/ HOOD AND MICRO ABV. VENT PER MANUFACTURER'S WRITTEN INSTRUCTIONS.
 - 30" GAS COOKTOP AND HOOD. VENT PER MANUFACTURER'S WRITTEN INSTRUCTIONS.
 - ELECTRIC OVEN WITH MICROWAVE OVEN.

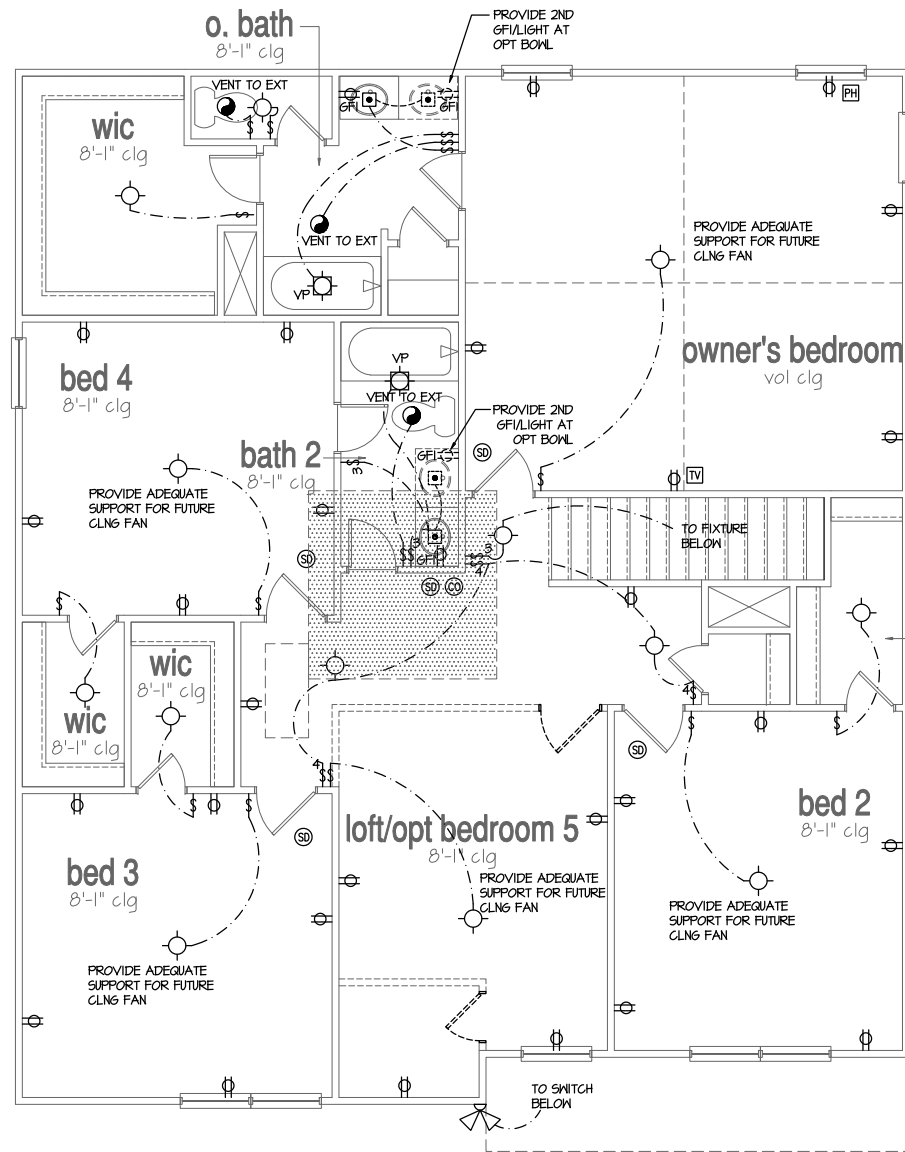

2nd Floor Plan 'A'
SCALE: 1/4"=1'-0" AT 22'X34" LAYOUT 1/8"=1'-0" AT 11'X11" LAYOUT

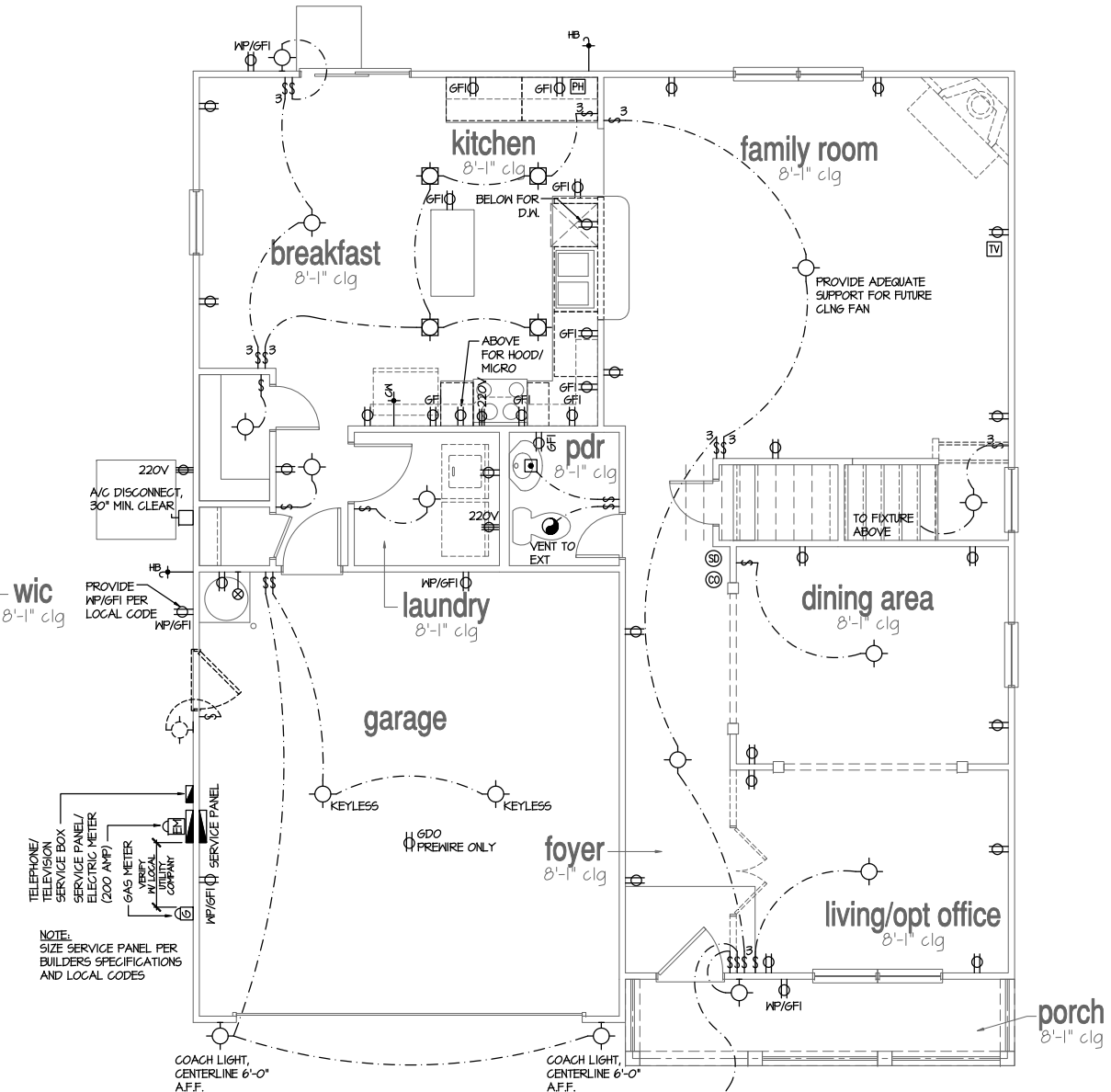

1st Floor Plan 'A'
SCALE: 1/4"=1'-0" AT 22'X34" LAYOUT 1/8"=1'-0" AT 11'X11" LAYOUT

ALL ELEVATIONS
ARE SIMILAR

- NOTES:**
- PROVIDE GROUNDING ELECTRICAL ROD PER LOCAL CODES.
 - PROVIDE AND INSTALL ARC FAULT CIRCUIT-INTERRUPTERS (AFCI) AS REQUIRED BY NATIONAL ELECTRICAL CODE (NEC) AND MEETING THE REQUIREMENTS OF ALL GOVERNING CODES.
 - ALL EXHAUST FANS SHALL HAVE BACKDRAFT DAMPERS.
 - FANLIGHTS IN WET/DAMP LOCATIONS SHALL BE LABELED "SUITABLE FOR WET OR DAMP LOCATIONS."
 - ELECTRICAL SYSTEMS ARE SHOWN FOR INTENT ONLY. THESE SYSTEMS SHALL BE ENGINEERED BY OTHERS. THE CONTRACTOR SHALL BE RESPONSIBLE FOR PROPER INSTALLATION AND PLACEMENT.
 - PROVIDE AND INSTALL LOCALLY CERTIFIED SMOKE DETECTORS AND CO2 DETECTORS AS REQUIRED BY NATIONAL FIRE PROTECTION ASSOCIATION (NFPA) AND MEETING THE REQUIREMENTS OF ALL GOVERNING CODES.
 - PROVIDE AND INSTALL GROUND FAULT CIRCUIT-INTERRUPTERS (GFI) AS REQUIRED BY NATIONAL ELECTRICAL CODE (NEC) AND MEETING THE REQUIREMENTS OF ALL GOVERNING CODES.
 - ELECTRICAL CONTRACTOR TO PROVIDE REQUIRED DIRECT HOOK-UPS/CUTOFFS.
 - HVAC CONTRACTOR TO VERIFY THERMOSTAT LOCATIONS.
 - ALL ELECTRICAL AND MECHANICAL EQUIPMENT (FURNACES, A/C UNITS, ELECTRICAL PANELS, SANITARY SUMP PITS, DRAIN TILE SUMP, AND WATER HEATERS) ARE SUBJECT TO RELOCATION DUE TO FIELD CONDITIONS.
 - PROVIDE POWER, LIGHT AND SWITCH AS REQUIRED FOR ATTIC FURNACE PER CODE AND MANUFACTURER'S WRITTEN INSTRUCTIONS.

LEGEND:

⊕	DUPLEX OUTLET	⊙	CEILING MOUNTED INCANDESCENT LIGHT FIXTURE
⊕W/GFI	WEATHERPROOF GFI DUPLEX OUTLET	⊙	HALL MOUNTED INCANDESCENT LIGHT FIXTURE
⊕GFI	GROUND-FAULT CIRCUIT-INTERRUPTER DUPLEX OUTLET	⊙	RECESSED INCANDESCENT LIGHT FIXTURE (VP) = VAPOR PROOF
⊕	HALF-SWITCHED DUPLEX OUTLET	⊙	CEILING MOUNTED LED LIGHT FIXTURE (VP) = VAPOR PROOF
⊕220V	220 VOLT OUTLET	⊙	EXHAUST FAN (VENT TO EXTERIOR)
⊙	REINFORCED JUNCTION BOX	⊙	EXHAUST FANLIGHT COMBINATION (VENT TO EXTERIOR)
⊕	WALL SWITCH	⊕	FLUORESCENT LIGHT FIXTURE
⊕3	THREE-WAY SWITCH	⊕	TECH. HUB SYSTEM
⊕4	FOUR-WAY SWITCH	⊕	CEILING FAN (PROVIDE ADEQUATE SUPPORT)
⊕	CHIMES	⊕	CEILING FAN WITH INCANDESCENT LIGHT FIXTURE (PROVIDE ADEQUATE SUPPORT)
⊕	PUSHBUTTON SWITCH	⊕	GAS SUPPLY WITH VALVE
⊕	110V SMOKE ALARM W/ BATTERY BACKUP	⊕	HOSE BIBB
⊕	110V SMOKE ALARM CO2 DETECTOR COMBO	⊕	1/4" WATER STUB OUT
⊕	THERMOSTAT	⊕	WALL SCONCE
⊕	TELEPHONE		
⊕	TELEVISION		
⊕	ELECTRIC METER		
⊕	ELECTRIC PANEL		
⊕	DISCONNECT SWITCH		

DESIGN SPECIFICATIONS:

Construction Type: Commercial Residential

Applicable Building Codes:

- 2018 North Carolina Residential Building Code with All Local Amendments
• ASCE 7-10: Minimum Design Loads for Buildings and Other Structures

Design Loads:

- 1. Roof Live Loads
11. Conventional 2x 20 PSF
12. Truss 20 PSF
12.1. Attic Truss 60 PSF
2. Roof Dead Loads
21. Conventional 2x 10 PSF
22. Truss 20 PSF
3. Snow 15 PSF
3.1. Importance Factor 1.0
4. Floor Live Loads
4.1. Typ. Dwelling 40 PSF
4.2. Sleeping Areas 30 PSF
4.3. Decks 40 PSF
4.4. Passenger Garage 50 PSF
5. Floor Dead Loads
5.1. Conventional 2x 10 PSF
5.2. I-Joist 15 PSF
5.3. Floor Truss 15 PSF
6. Ultimate Design Wind Speed (3 sec. gust) 130 MPH
6.1. Exposure B
6.2. Importance Factor 1.0
6.3. Wind Base Shear
6.3.1. Vx =
6.3.2. Vy =

7. Component and Cladding (in PSF)

Table with 5 columns: MEAN ROOF HT., ZONE 1-5, and 5 rows of wind speed data for different zones.

8. Seismic

- 8.1. Site Class D
8.2. Design Category C
8.3. Importance Factor 1.0
8.4. Seismic Use Group I
8.5. Spectral Response Acceleration
8.5.1. Sns = %g
8.5.2. Smi = %g
8.6. Seismic Base Shear
8.6.1. Vx =
8.6.2. Vy =
8.7. Basic Structural System (check one)
[] Bearing Wall
[] Building Frame
[] Moment Frame
[] Dual w/ Special Moment Frame
[] Dual w/ Intermediate R/C or Special Steel
[] Inverted Pendulum
8.8. Arch/Mech Components Anchored No
8.9. Lateral Design Control: Seismic Wind
9. Assumed Soil Bearing Capacity 1000psf

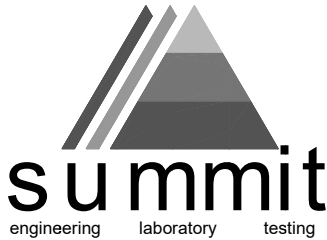

STRUCTURAL PLANS PREPARED FOR: WILMINGTON - LH

PROJECT ADDRESS: TBD OWNER: DR Horton, Inc. 8001 Aronridge Blvd. Charlotte, NC 28213

DESIGNER: GMD Design Group 102 Fountain Brook Circle Suite C Cary, NC 27511

These drawings are to be coordinated with the architectural, mechanical, plumbing, electrical, and civil drawings. This coordination is not the responsibility of the structural engineering of record (SER). Should any discrepancies become apparent, the contractor shall notify SUMMIT Engineering, Laboratory & Testing, P.C. before construction begins.

PLAN ABBREVIATIONS:

Table with 2 columns: Abbreviation and Description. Includes items like AB ANCHOR BOLT, AFF ABOVE FINISHED FLOOR, etc.

Roof truss and floor joist layouts, and their corresponding loading details, were not provided to SUMMIT Engineering, Laboratory & Testing, P.C. (SUMMIT) prior to the initial design. Therefore, truss and joist directions were assumed based on the information provided by DR Horton, Inc. Subsequent plan revisions based on roof truss and floor joist layouts shall be noted in the revision list, indicating the date the layouts were provided. Should any discrepancies become apparent, the contractor shall notify SUMMIT immediately.

SHEET LIST:

Table with 2 columns: Sheet No. and Description. Lists sheets from CSI to 95.0.

REVISION LIST:

Table with 4 columns: Revision No., Date, Project No., and Description. Lists revisions 1 through 7.

DR HORTON PROJECT SIGN-OFF:

Table with 2 columns: Manager and Signature. Includes Operations and Operations System/Development rows.

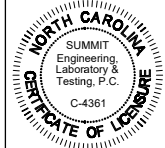

CLIENT: DR Horton, Inc. 8001 Aronridge Blvd. Charlotte, NC 28213

PROJECT: Wilmington - LH Coversheet

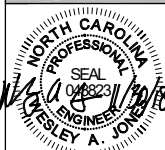

STRUCTURAL MEMBERS ONLY

DRAWING DATE: 10/09/2018 SCALE: 1/8"=1'-0" PROJECT: 1528-06A-1706284 DRAWN BY: OUP CHECKED BY: OUP ORIGINAL INFORMATION PROJECT # DATE 1528-06A-1706284 09/10/2018 REFER TO COVER SHEET FOR A COMPLETE LIST OF REVISIONS

SHEET CSI

GENERAL STRUCTURAL NOTES:

- 1. The design professional whose seal appears on these drawings is the structural engineer of record (SER) for this project. The SER bears the responsibility of the primary structural elements and the performance of this structure. No other party may revise, alter, or delete any structural aspects of these construction documents without written permission of SUMMIT Engineering, Laboratory & Testing, P.C. (SUMMIT) or the SER. For the purposes of these construction documents the SER and SUMMIT shall be considered the same entity.
2. The structure is only stable in its completed form. The contractor shall provide all required temporary bracing during construction to stabilize the structure.
3. The SER is not responsible for construction sequences, methods, or techniques in connection with the construction of this structure. The SER will not be held responsible for the contractor's failure to conform to the contract documents, should any non-conformities occur.
4. Any structural elements or details not fully developed on the construction drawings shall be completed under the direction of a licensed professional engineer. These shop drawings shall be submitted to SUMMIT for review before any construction begins. The shop drawings will be reviewed for overall compliance as it relates to the structural design of this project. Verification of the shop drawings for dimensions, or for actual field conditions, is not the responsibility of the SER or SUMMIT.
5. Verification of assumed field conditions is not the responsibility of the SER. The contractor shall verify the field conditions for accuracy and report any discrepancies to SUMMIT before construction begins.
6. The SER is not responsible for any secondary structural elements or non-structural elements, except for the elements specifically noted on the structural drawings.
7. This structure and all construction shall conform to all applicable sections of the International Residential Code.
8. This structure and all construction shall conform to all applicable sections of local building codes.
9. All structural assemblies are to meet or exceed to requirements of the current local building code.

FOUNDATIONS:

- 1. The structural engineer has not performed a subsurface investigation. Verification of this assumed value is the responsibility of the owner or the contractor. Should any adverse soil condition be encountered the SER must be contacted before proceeding.

- 2. The bottom of all footings shall extend below the frost line for the region in which the structure is to be constructed. However, the bottom of all footings shall be a minimum of 12" below grade.
3. Any fill shall be placed under the direction or recommendation of a licensed professional engineer.
4. The resulting soil shall be compacted to a minimum of 95% maximum dry density.
5. Excavations of footings shall be lined temporarily with a 6 mil polyethylene membrane if placement of concrete does not occur within 24 hours of excavation.
6. No concrete shall be placed against any subgrade containing water, ice, frost, or loose material.

STRUCTURAL STEEL:

- 1. Structural steel shall be fabricated and erected in accordance with the American Institute of Steel Construction "Code of Standard Practice for Steel Buildings and Bridges" and the manual of Steel Construction "Load Resistance Factor Design" latest editions.
2. Structural steel shall receive one coat of shop applied rust-inhibitive paint.
3. All steel shall have a minimum yield stress (Fy) of 36 ksi unless otherwise noted.
4. Welding shall conform to the latest edition of the American Welding Society's Structural Welding Code AWS D11. Electrodes for shop and field welding shall be class E10XX. All welding shall be performed by a certified welder per the above standards.

CONCRETE:

- 1. Concrete shall have a normal weight aggregate and a minimum compressive strength (f'c) at 28 days of 3000 psi, unless otherwise noted on the plan.
2. Concrete shall be proportioned, mixed, and placed in accordance with the latest editions of ACI 318: "Building Code Requirements for Reinforced Concrete" and ACI 301: "Specifications for Structural Concrete for Buildings".
3. Air entrained concrete must be used for all structural elements exposed to freeze/thaw cycles and deicing chemicals. Air entrainment amounts (in percent) shall be within -1% to +2% of target values as follows:
3.1. Footings: 5%
3.2. Exterior Slabs: 5%
4. No admixtures shall be added to any structural concrete without written permission of the SER.

- 5. Concrete slabs-on-grade shall be constructed in accordance with ACI 302.1R-96: "Guide for Concrete Slab and Slab Construction".
6. The concrete slab-on-grade has been designed using a subgrade modulus of k=250 pci and a design loading of 200 psf. The SER is not responsible for differential settlement, slab cracking or other future defects resulting from unreported conditions not in accordance with the above assumptions.
7. Control or saw cut joints shall be spaced in interior slabs-on-grade at a maximum of 15'-0" OC, and in exterior slabs-on-grade at a maximum of 10'-0" unless otherwise noted.
8. Control or saw cut joints shall be produced using conventional process within 4 to 12 hours after the slab has been finished.
9. Reinforcing steel may not extend through a control joint.
10. All welded wire fabric (WWF) for concrete slabs-on-grade shall be placed at mid-depth of slab. The WWF shall be securely supported during the concrete pour.

CONCRETE REINFORCEMENT:

- 1. Fibrous concrete reinforcement, or fibermesh specified in concrete slabs-on-grade may be used for control of cracking due to shrinkage and thermal expansion/contraction, lowered water migration, an increase in impact capacity, increased abrasion resistance, and residual strength.
2. Fibermesh reinforcing to be 100% virgin polypropylene fibers containing no reprocessed olefin materials and specifically manufactured for use as concrete secondary reinforcement.
3. Application of fibermesh per cubic yard of concrete shall equal a minimum of 0.1% by volume (15 pounds per cubic yard).
4. Fibermesh shall comply with ASTM C116, any local building code requirements, and shall meet or exceed the current industry standard.
5. Steel reinforcing bars shall be new billet steel conforming to ASTM A615, grade 60.
6. Detailing, fabrication, and placement of reinforcing steel shall be in accordance with the latest edition of ACI 318: "Manual of Standard Practice for Detailing Concrete Structures".
7. Horizontal footing and wall reinforcement shall be continuous and shall have 90° bends, or corner bars with the same size/spacing as the horizontal reinforcement with a class B tension splice.
8. Lap reinforcement as required, a minimum of 40 bar diameters for tension or compression unless otherwise noted. Splices in masonry shall be a minimum of 48 bar diameters.

- 9. Where reinforcing dowels are required, they shall be equivalent in size and spacing to the vertical reinforcement. The dowel shall extend 48 bar diameters vertically and 20 bar diameters into the footing.
10. Where reinforcing steel is required vertically, dowels shall be provided unless otherwise noted.

WOOD FRAMING:

- 1. Solid sawn wood framing members shall conform to the specifications listed in the latest edition of the "National Design Specification for Wood Construction" (NDS). Unless otherwise noted, all wood framing members are designed to be Southern-Yellow-Pine (SYP) #2.
2. LVL or PSL engineered wood shall have the following minimum design values:
2.1. E = 1300000 psi
2.2. Fb = 2600 psi
2.3. Fv = 285 psi
2.4. Fc = 100 psi
3. Wood in contact with concrete, masonry, or earth shall be pressure treated in accordance with AIAA standard C-15. All other moisture exposed wood shall be treated in accordance with AIAA standard C-2.
4. Nails shall be common wire nails unless otherwise noted.
5. Lag screws shall conform to ANSI/ASME standard B18.1-1991. Lead holes for lag screws shall be in accordance with NDS specifications.
6. All beams shall have full bearing on supporting framing members unless otherwise noted.
7. Exterior and load bearing stud walls are to be 2x4 SYP #2 @ 16" OC, unless otherwise noted. Studs shall be continuous from the sole plate to the double top plate. Studs shall only be discontinued at headers for window/door openings. A minimum of one king stud shall be placed at each end of the header. King studs shall be continuous.
8. Individual studs forming a column shall be attached with one 1/2" x 6" OC, staggered. The stud column shall be continuous to the foundation or beam. The column shall be properly blocked at all floor levels to ensure proper load transfer.
9. Multi-ply beams shall have each ply attached with (3) 10d nails @ 24" OC.
10. Four and five ply beams shall be bolted together with (2) rows of 1/2" diameter through bolts staggered @ 16" OC, unless noted otherwise.

WOOD TRUSSES:

- 1. The wood truss manufacturer/fabricator is responsible for the design of the wood trusses. Submit sealed shop drawings and supporting calculations to the SER for review prior to fabrication. The SER shall have a minimum of five (5) days for review. The review by the SER shall review for overall compliance with the design documents. The SER shall assume no responsibility for the correctness for the structural design for the wood trusses.
2. The wood trusses shall be designed for all required loadings as specified in the local building code, the ASCE Standard "Minimum Design Loads for Buildings and Other Structures." (ASCE 7-10), and the loading requirements shown on these specifications. The truss drawings shall be coordinated with all other construction documents and provisions provided for loads shown on these drawings including but not limited to HVAC equipment, piping, and architectural fixtures attached to the trusses.
3. The trusses shall be designed, fabricated, and erected in accordance with the latest edition of the "National Design Specification for Wood Construction" (NDS) and "Design Specification for Metal Plate Connected Wood Trusses."
4. The truss manufacturer shall provide adequate bracing information in accordance with "Commentary and Recommendations for Handling, Installing and Bracing Metal Plate Connected Wood Trusses" (HIB-91). This bracing, both temporary and permanent, shall be shown on the shop drawings. Also, the shop drawings shall show the required attachments for the trusses.
5. Any chords or truss webs shown on these drawings have been shown as a reference only. The final design of the trusses shall be per the manufacturer.

EXTERIOR WOOD FRAMED DECKS:

- 1. Decks are to be framed in accordance with local building codes and as referenced on the structural plans, either through code references or construction details.

WOOD STRUCTURAL PANELS:

- 1. Fabrication and placement of structural wood sheathing shall be in accordance with the APA Design/Construction Guide "Residential and Commercial," and all other applicable APA standards.
2. All structurally required wood sheathing shall bear the mark of the APA.

- 3. Wood wall sheathing shall comply with the requirements of local building codes for the appropriate state as indicated on these drawings. Refer to wall bracing notes in plan set for more information. Sheathing shall be applied with the long direction perpendicular to framing, unless noted otherwise.
4. Roof sheathing shall be APA rated sheathing exposure 1 or 2. Roof sheathing shall be continuous over two supports and attached to its supporting roof framing with (1)-8d CC nail at 6" o/c at panel edges and at 12" o/c in panel field unless otherwise noted on the plans. Sheathing shall be applied with the long direction perpendicular to framing. Sheathing shall have a span rating consistent with the framing spacing. Use suitable edge support by use of plywood clips or lumber blocking unless otherwise noted. Panel end joints shall occur over framing. Apply building paper over the sheathing as required by the state Building Code.
5. Wood floor sheathing shall be APA rated sheathing exposure 1 or 2. Attach sheathing to its supporting framing with (1)-8d CC ringshank nail at 6" o/c at panel edges and at 12" o/c in panel field unless otherwise noted on the plans. Sheathing shall be applied perpendicular to framing. Sheathing shall have a span rating consistent with the framing spacing. Use suitable edge support by use of T&G plywood or lumber blocking unless otherwise noted. Panel end joints shall occur over framing. Apply building paper over the sheathing as required by the state Building Code.
6. Sheathing shall have a 1/8" gap at panel ends and edges as recommended in accordance with the APA.

STRUCTURAL FIBERBOARD PANELS:

- 1. Fabrication and placement of structural fiberboard sheathing shall be in accordance with the applicable AFA standards.
2. All structurally required fiberboard sheathing shall bear the mark of the AFA.
3. Fiberboard wall sheathing shall comply with the requirements of local building codes for the appropriate state as indicated on these drawings. Refer to wall bracing notes in plan set for more information.
4. Sheathing shall have a 1/8" gap at panel ends and edges as recommended in accordance with the AFA.

FOUNDATION NOTES:

- FOUNDATIONS TO BE CONSTRUCTED IN ACCORDANCE WITH CHAPTER 4 OF THE 2018 NORTH CAROLINA RESIDENTIAL BUILDING CODE WITH ALL LOCAL AMENDMENTS.
- STRUCTURAL CONCRETE TO BE $F_c = 3000$ PSI, PREPARED AND PLACED IN ACCORDANCE WITH ACI STANDARD 318.
- FOOTINGS TO BE PLACED ON UNDISTURBED EARTH, BEARING A MINIMUM OF 12" BELOW ADJACENT FINISHED GRADE, OR AS OTHERWISE DIRECTED BY THE CODE ENFORCEMENT OFFICIAL.
- FOOTING SIZES BASED ON A PRESUMPTIVE SOIL BEARING CAPACITY OF 2000 PSF. CONTRACTOR IS SOLELY RESPONSIBLE FOR VERIFYING THE SUITABILITY OF THE SITE SOIL CONDITIONS AT THE TIME OF CONSTRUCTION.
- FOOTINGS AND PIERS SHALL BE CENTERED UNDER THEIR RESPECTIVE ELEMENTS. PROVIDE 2" MINIMUM FOOTING PROJECTION FROM THE FACE OF MASONRY.
- MAXIMUM DEPTH OF UNBALANCED FILL AGAINST MASONRY WALLS TO BE AS SPECIFIED IN SECTION R404.1 OF THE 2018 NORTH CAROLINA RESIDENTIAL BUILDING CODE.
- FILASTERS TO BE BONDED TO PERIMETER FOUNDATION WALL.
- PROVIDE FOUNDATION WATERPROOFING, AND DRAIN WITH POSITIVE SLOPE TO OUTLET AS REQUIRED BY SITE CONDITIONS.
- PROVIDED PERIMETER INSULATION FOR ALL FOUNDATIONS PER 2018 NORTH CAROLINA RESIDENTIAL BUILDING CODE.
- CORBEL FOUNDATION WALL AS REQUIRED TO ACCOMMODATE BRICK VENEERS.
- CRAWL SPACE TO BE GRADED LEVEL, AND CLEARED OF ALL DEBRIS.
- FOUNDATION ANCHORAGE SHALL BE CONSTRUCTED PER THE 2018 NORTH CAROLINA RESIDENTIAL CODE SECTION R403.16. MINIMUM 1/2" DIA. BOLTS SPACED AT 6'-0" ON CENTER, WITH A 1" MINIMUM EMBEDMENT INTO MASONRY OR CONCRETE. ANCHOR BOLTS SHALL BE 12" FROM THE END OF EACH PLATE SECTION. MINIMUM (2) ANCHOR BOLTS PER PLATE SECTION. ANCHOR BOLTS SHALL BE LOCATED IN THE CENTER THIRD OF THE PLATE.
- ABBREVIATIONS:

DJ = DOUBLE JOIST	SJ = SINGLE JOIST
GT = GIRDER TRUSS	FT = FLOOR TRUSS
SC = STUD COLUMN	DR = DOUBLE RAFTER
EE = EACH END	TR = TRIFLE RAFTER
TJ = TRIFLE JOIST	OC = ON CENTER
CL = CENTER LINE	PL = POINT LOAD
- ALL PIERS TO BE 16"x16" MASONRY AND ALL FILASTERS TO BE 8"x16" MASONRY, TYPICAL (UNO).
- WALL FOOTINGS TO BE CONTINUOUS CONCRETE, SIZES PER STRUCTURAL PLAN.
- A FOUNDATION EXCAVATION OBSERVATION SHOULD BE CONDUCTED BY A PROFESSIONAL GEOTECHNICAL ENGINEER, OR HIS QUALIFIED REPRESENTATIVE. IF ISOLATED AREAS OF YIELDING MATERIALS AND/OR POTENTIALLY EXPANSIVE SOILS ARE OBSERVED IN THE FOOTING EXCAVATIONS AT THE TIME OF CONSTRUCTION, SUMMIT ENGINEERING, LABORATORY & TESTING, P.C. MUST BE PROVIDED THE OPPORTUNITY TO REVIEW THE FOOTING DESIGN PRIOR TO CONCRETE PLACEMENT.
- ALL FOOTINGS & SLABS ARE TO BEAR ON UNDISTURBED SOIL OR 95% COMPACTED FILL, VERIFIED BY ENGINEER OR CODE OFFICIAL.

REFER TO BRACED WALL PLAN FOR PANEL LOCATIONS AND ANY REQUIRED HOLDINGS. ADDITIONAL INFORMATION PER SECTION R602.10.5 AND FIGURES R602.10.6.5, R602.10.7, R602.10.8(1) AND R602.10.8(2) OF THE 2015 IRC

NOTE: ALL EXTERIOR FOUNDATION DIMENSIONS ARE TO FRAMING AND NOT BRICK VENEER, UNO

NOTE: A 4" CRUSHED STONE BASE COURSE IS NOT REQUIRED WHEN SLAB IS INSTALLED ON WELL-DRAINED OR SAND-GRAVEL MIXTURE SOILS CLASSIFIED AS GROUP 1 PER TABLE R405.1

THESE PLANS ARE DESIGNED IN ACCORDANCE WITH ARCHITECTURAL PLANS PROVIDED BY DR. HORTON. COMPLETED/REVISED ON 6/12/2022. IT IS THE RESPONSIBILITY OF THE CLIENT TO NOTIFY SUMMIT ENGINEERING, LABORATORY & TESTING, P.C. IF ANY CHANGES ARE MADE TO THE ARCHITECTURAL PLANS PRIOR TO CONSTRUCTION. SUMMIT ENGINEERING, LABORATORY & TESTING, P.C. CANNOT GUARANTEE THE ADEQUACY OF THESE STRUCTURAL PLANS WHEN USED WITH ARCHITECTURAL PLANS DATED DIFFERENTLY THAN THE DATE LISTED ABOVE.

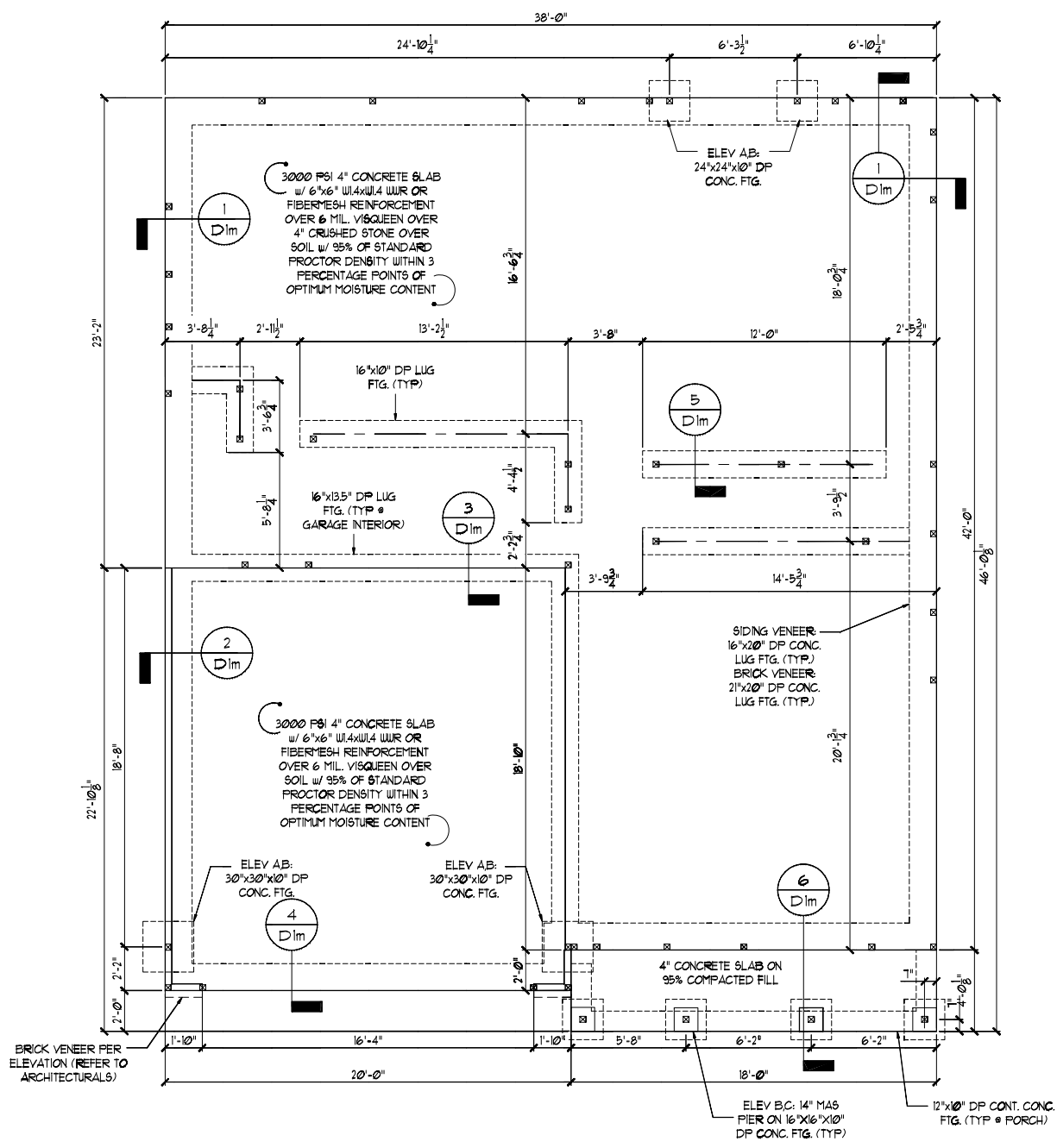

MONOLITHIC SLAB FOUNDATION - ALL ELEVATIONS

STRUCTURAL MEMBERS ONLY

ENGINEERING SEAL APPLIES ONLY TO STRUCTURAL COMPONENTS ON THIS DOCUMENT. SEAL DOES NOT INCLUDE CONSTRUCTION MEANS, METHODS, TECHNIQUES, SEQUENCES, PROCEDURES OR SAFETY PRECAUTIONS. ANY DEVIATIONS OR DISCREPANCIES ON PLANS ARE TO BE BROUGHT TO THE IMMEDIATE ATTENTION OF SUMMIT ENGINEERING, LABORATORY & TESTING, P.C. FAILURE TO DO SO WILL VOID SUMMIT LIABILITY.

STRUCTURAL ANALYSIS BASED ON 2018 NCR.

MONOLITHIC SLAB FOUNDATION PLAN

SCALE: 1/4"=1'-0" ON 22'x34" OR 1/8"=1'-0" ON 11"x17"

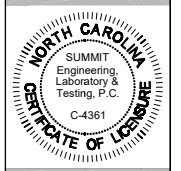

CLIENT:
 DE Horton, Inc.
 8001 Aronkirk Blvd.
 Charlotte, NC 28213

PROJECT:
 Wilmington - LH
Monolithic Slab Foundation



STRUCTURAL MEMBERS ONLY

DRAWING
 DATE: 10/09/08
 SCALE: 1/4"=1'-0" ON 14"x17'-0"
 1/8"=1'-0" ON 11"x17'-0"
 PROJECT #: 508-068-1706284
 DRAWN BY: OUP
 CHECKED BY: BAU

ORIGINAL INFORMATION
 PROJECT # DATE
 508-068-1706284 09/10/07

REFER TO COVER SHEET FOR A COMPLETE LIST OF REVISIONS

SHEET
Sl.0m

REQUIRED BRACED WALL PANEL CONNECTIONS				
METHOD	MATERIAL	MIN. THICKNESS	REQUIRED CONNECTION	
			* PANEL EDGES	* INTERMEDIATE SUPPORTS
CS-WSP	WOOD STRUCTURAL PANEL	3/8"	6d COMMON NAILS @ 6" O.C.	6d COMMON NAILS @ 12" O.C.
GB	GYPSUM BOARD	1/2"	5d COOLER NAILS** @ 1" O.C.	5d COOLER NAILS** @ 1" O.C.
WSP	WOOD STRUCTURAL PANEL	3/8"	6d COMMON NAILS @ 6" O.C.	6d COMMON NAILS @ 12" O.C.
FF	WOOD STRUCTURAL PANEL	1/16"	PER FIGURE R602.10.6.4	PER FIGURE R602.10.6.4

*OR EQUIVALENT PER TABLE R102.3.5

FIRST FLOOR BRACING (FT)		
	CONTINUOUS SHEATHING METHOD	
	REQUIRED	PROVIDED
BUIL 1-1	4.8	26.5
BUIL 1-2	4.8	13.5
BUIL 1-3	4.3	13.1
BUIL 1-A	1.5	41.0
BUIL 1-B	1.5	36.0

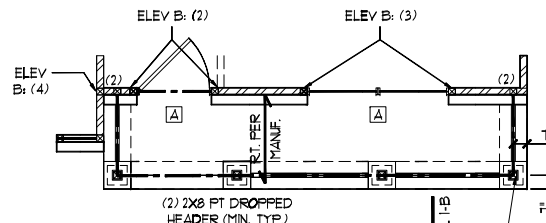

MIN. 4" PT. POSTS OR COL. RATED FOR 2000# (MIN. TYP.) ATTACH POSTS TO HEADER w/ 56T C516 STRAPS OR (4) 16d NAILS AND ATTACH POSTS TO FOUNDATION w/ 56T ABA44 POST BASE OR EQUIV. (TYP)

ELEVATION B.C

GENERAL STRUCTURAL NOTES:

- CONSTRUCTION SHALL CONFORM TO 2018 NORTH CAROLINA RESIDENTIAL BUILDING CODE WITH ALL LOCAL AMENDMENTS.
- CONTRACTOR SHALL VERIFY ALL DIMENSIONS. CONTRACTOR SHALL COMPLY WITH THE CONTENTS OF THE DRAWING FOR THIS SPECIFIC PROJECT. ENGINEER IS NOT RESPONSIBLE FOR ANY DEVIATIONS FROM THIS PLAN.
- CONTRACTOR IS RESPONSIBLE FOR PROVIDING TEMPORARY BRACING REQUIRED TO RESIST ALL FORCES ENCOUNTERED DURING ERECTION.
- PROPERTIES USED IN THE DESIGN ARE AS FOLLOWS:
MICRO-LAM (LVL): $F_b = 2600$ PSI, $F_v = 285$ PSI, $E = 1.9 \times 10^6$ PSI
PARALLAM (PSL): $F_b = 2300$ PSI, $F_v = 230$ PSI, $E = 1.25 \times 10^6$ PSI
- ALL WOOD MEMBERS SHALL BE #2 SYP UNLESS NOTED ON PLAN. ALL STUD COLUMNS AND JOISTS SHALL BE #2 SYP (UNO).
- ALL BEAMS SHALL BE SUPPORTED WITH A (2) 2x4 #2 SYP STUD COLUMN AT EACH END UNLESS NOTED OTHERWISE.
- ALL REINFORCING STEEL SHALL BE GRADE 60 BARS CONFORMING TO ASTM A615 AND SHALL HAVE A MINIMUM COVER OF 3".
- FOUNDATION ANCHORAGE SHALL BE CONSTRUCTED PER THE 2018 NORTH CAROLINA RESIDENTIAL CODE SECTION R403.16. MINIMUM 1/2" DIA. BOLTS SPACED AT 6'-0" ON CENTER WITH A 1" MINIMUM EMBEDMENT INTO MASONRY OR CONCRETE. ANCHOR BOLTS SHALL BE 12" FROM THE END OF EACH PLATE SECTION MINIMUM (2) ANCHOR BOLTS PER PLATE SECTION. ANCHOR BOLTS SHALL BE LOCATED IN THE CENTER THIRD OF THE PLATE.
- CONTRACTOR TO PROVIDE LOOKOUTS WHEN CEILING JOISTS SPAN PERPENDICULAR TO RAFTERS.
- FLITCH BEAMS, 4-PLY LVL'S AND 3-PLY SIDE LOADED LVL'S SHALL BE BOLTED TOGETHER WITH 1/2" DIA. THRU BOLTS SPACED AT 24" O.C. (MAX) STAGGERED OR EQUIVALENT CONNECTIONS PER DETAIL 1/D3. MIN. EDGE DISTANCE SHALL BE 2" AND (2) BOLTS SHALL BE LOCATED MINIMUM 6" FROM EACH END OF THE BEAM.
- ALL NON-LOAD BEARING HEADERS SHALL BE (1) FLAT 2x4 SYP #2, DROPPED, FOR NON-LOAD BEARING HEADERS EXCEEDING 8'-0" IN WIDTH AND/OR WITH MORE THAN 2'-0" OF CRIPPLE WALL ABOVE, SHALL BE (2) FLAT 2x4 SYP #2, DROPPED. (UNLESS NOTED OTHERWISE)
- ABBREVIATIONS:

- DJ = DOUBLE JOIST SJ = SINGLE JOIST
GT = GIRDER TRUSS FT = FLOOR TRUSS
SC = STUD COLUMN DR = DOUBLE RAFTER
EE = EACH END TR = TRIPLE RAFTER
TJ = TRIPLE JOIST OC = ON CENTER
CL = CENTER LINE PL = POINT LOAD

NOTE: DESIGNATES JOIST SUPPORTED LOAD BEARING WALL ABOVE. PROVIDE BLOCKING UNDER JOIST SUPPORTED LOAD BEARING WALL.

JOIST & BEAM SIZES SHOWN ARE MINIMUMS. BUILDER MAY INCREASE DEPTH FOR EASE OF CONSTRUCTION.

INSTALL ANY REQUIRED HOLDINGS PER SECTION R602.10.8 AND FIGURES R602.10.6.5, R602.10.7, R602.10.8(1) AND R602.10.8(2) OF THE 2018 IRC

THESE PLANS ARE DESIGNED IN ACCORDANCE WITH ARCHITECTURAL PLANS PROVIDED BY DR. HORTON COMPLETED/REVISED ON 6/12/2023. IT IS THE RESPONSIBILITY OF THE CLIENT TO NOTIFY SUMMIT ENGINEERING, LABORATORY & TESTING, P.C. IF ANY CHANGES ARE MADE TO THE ARCHITECTURAL PLANS PRIOR TO CONSTRUCTION. SUMMIT ENGINEERING, LABORATORY & TESTING, P.C. CANNOT GUARANTEE THE ADEQUACY OF THESE STRUCTURAL PLANS WHEN USED WITH ARCHITECTURAL PLANS DATED DIFFERENTLY THAN THE DATE LISTED ABOVE.

NOTE: MEMBER NOTED AS PRESSURE TREATED MAY BE FRAMED WITH NON-PRESSURE TREATED LUMBER PROVIDED THE ENTIRETY OF THE MEMBER IS WRAPPED TO PREVENT MOISTURE INTRUSION.

NOTE: REDUCE JOIST SPACING UNDER TILE FLOORS, GRANITE COUNTERTOPS AND/OR ISLANDS.

STRUCTURAL MEMBERS ONLY

ENGINEERING SEAL APPLIES ONLY TO STRUCTURAL COMPONENTS ON THIS DOCUMENT. SEAL DOES NOT INCLUDE CONSTRUCTION MEANS, METHODS, TECHNIQUES, SEQUENCES, PROCEDURES OR SAFETY PRECAUTIONS. ANY DEVIATIONS OR DISCREPANCIES ON PLANS ARE TO BE BROUGHT TO THE IMMEDIATE ATTENTION OF SUMMIT ENGINEERING, LABORATORY & TESTING, P.C. FAILURE TO DO SO WILL VOID SUMMIT LIABILITY.

STRUCTURAL ANALYSIS BASED ON 2018 NCR.

FIRST FLOOR FRAMING PLAN

SCALE: 1/4"=1'-0" ON 22"x34" OR 1/8"=1'-0" ON 11"x17"

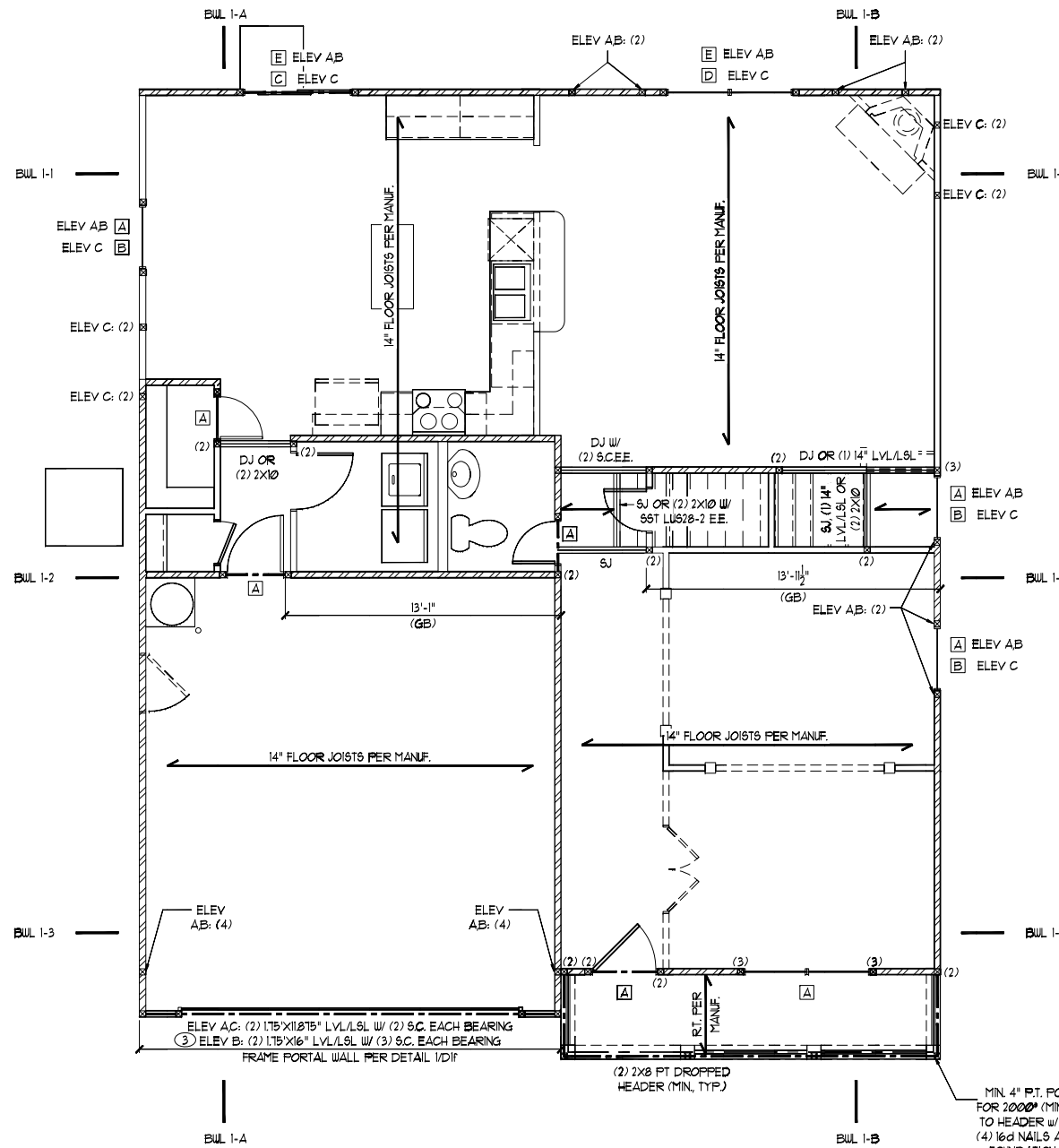

FIRST FLOOR FRAMING PLAN - ELEVATION A

HEADER SCHEDULE		
TAG	SIZE	JACKS (EACH END)
A	(2) 2x6	(1)
B	(2) 2x8	(2)
C	(2) 2x10	(2)
D	(2) 2x12	(2)
E	(2) 9-1/4" LVL/LVL	(3)
F	(3) 2x6	(1)
G	(3) 2x8	(2)
H	(3) 2x10	(2)
I	(3) 2x12	(2)

HEADER SIZES SHOWN ON PLANS ARE MINIMUMS. GREATER HEADER SIZES MAY BE USED FOR EASE OF CONSTRUCTION. ALL HEADERS TO BE DROPPED UNLESS NOTED OTHERWISE. SC NOTED ON PLAN OVERRIDE SC LISTED ABOVE.

LINTEL SCHEDULE		
TAG	SIZE	OPENING SIZE
①	L3x3x1/4"	LESS THAN 6'-0"
②	L5x3x1/4"	6'-0" TO 10'-0"
③	L5x3-1/2"x5/16"	GREATER THAN 10'-0"
④	L5x3-1/2"x5/16"	ALL ARCHED OPENINGS

SECURE LINTEL TO HEADER w/ (2) 1/2" DIAMETER LAG SCREWS STAGGERED @ 16" O.C. (TYP FOR ③)

ALL HEADERS WHERE BRICK IS USED, TO BE: ① (UNO)

WALL STUD SCHEDULE	
1ST & 2ND FLOOR LOAD BEARING STUDS:	2x4 STUDS @ 16" O.C. OR 2x6 STUDS @ 24" O.C.
1ST FLOOR LOAD BEARING STUDS w/ WALK-UP ATTIC:	2x4 STUDS @ 12" O.C. OR 2x6 STUDS @ 16" O.C.
BASEMENT LOAD BEARING STUDS:	2x4 STUDS @ 12" O.C. OR 2x6 STUDS @ 16" O.C.
NON-LOAD BEARING STUDS (ALL FLOORS):	2x4 STUDS @ 24" O.C.
TWO STORY WALLS:	2x4 STUDS @ 12" O.C. OR 2x6 STUDS @ 16" O.C. BALLOON FRAMED w/ CROSS BRACING @ 6'-0" O.C. VERTICALLY

KING STUD REQUIREMENTS	
OPENING WIDTH	KINGS (EACH END)
LESS THAN 3'-0"	(1)
3'-0" TO 4'-0"	(2)
4'-0" TO 8'-0"	(3)
8'-0" TO 12'-0"	(5)
12'-0" TO 16'-0"	(6)

KING STUD REQUIREMENTS ABOVE DO NOT APPLY TO PORTAL FRAMED OPENINGS

BRACED WALL NOTES:

- WALLS SHALL BE DESIGNED IN ACCORDANCE WITH SECTION R602.10 FROM THE 2018 INTERNATIONAL RESIDENTIAL CODE AS ALLOWED PER SECTION R602.10 OF THE 2018 NC RESIDENTIAL CODE.
- WALLS ARE DESIGNED FOR SEISMIC ZONES A-C AND ULTIMATE WIND SPEEDS UP TO 130 MPH.
- REFER TO ARCHITECTURAL PLAN FOR DOOR/WINDOW OPENING SIZES.
- BRACING MATERIALS, METHODS AND FASTENERS SHALL BE IN ACCORDANCE WITH IRC TABLE R602.10.4.
- ALL BRACED WALL PANELS SHALL BE FULL WALL HEIGHT AND SHALL NOT EXCEED 10 FEET FOR ISOLATED PANEL METHOD AND 12 FEET FOR CONTINUOUS SHEATHING METHOD WITHOUT ADDITIONAL ENGINEERING CALCULATIONS.
- MINIMUM PANEL LENGTH SHALL BE PER TABLE R602.10.5.
- THE INTERIOR SIDE OF EXTERIOR WALLS AND BOTH SIDES OF INTERIOR WALLS SHALL BE SHEATHED CONTINUOUSLY WITH MINIMUM 1/2" GYPSUM BOARD (UNO).
- FOR CONTINUOUS SHEATHING METHOD, EXTERIOR WALLS SHALL BE SHEATHED ON ALL SHEATHABLE SURFACES INCLUDING INFILL AREAS BETWEEN BRACED WALL PANELS, ABOVE AND BELOW WALL OPENINGS, AND ON GABLE END WALLS.
- FLOORS SHALL NOT BE CANTILEVERED MORE THAN 24" BEYOND THE FOUNDATION OR BEARING WALL BELOW WITHOUT ADDITIONAL ENGINEERING CALCULATIONS.
- A BRACED WALL PANEL SHALL BE LOCATED WITHIN 10 FEET OF EACH END OF A BRACED WALL LINE.
- THE MAXIMUM EDGE DISTANCE BETWEEN BRACED WALL PANELS SHALL NOT EXCEED 20 FEET.
- MASONRY OR CONCRETE STEM WALLS WITH A LENGTH OF 48" OR LESS SUPPORTING A BRACED WALL PANEL SHALL BE DESIGNED IN ACCORDANCE WITH FIGURE R602.10.9 OF THE 2018 IRC.
- BRACED WALL PANEL CONNECTIONS TO FLOOR/CEILING SHALL BE CONSTRUCTED IN ACCORDANCE WITH SECTION R602.10.8
- BRACED WALL PANEL CONNECTIONS TO ROOF SHALL BE CONSTRUCTED IN ACCORDANCE WITH SECTION R602.10.8.2 AND FIGURES R602.10.8(1) & (2).
- CRIPPLE WALLS AND WALK OUT BASEMENT WALLS SHALL BE DESIGNED IN ACCORDANCE WITH SECTION R602.10.11
- PORTAL WALLS SHALL BE DESIGNED IN ACCORDANCE WITH FIGURE R602.10.6.4 (UNO)
- ON SCHEMATIC, SHADED WALLS INDICATE BRACED WALL PANELS.
- ABBREVIATIONS:

GB = GYPSUM BOARD WSP = WOOD STRUCTURAL PANEL
CB-XXX = CONT. SHEATHED ENG = ENGINEERED SOLUTION
FF = PORTAL FRAME FF-ENG = ENG. PORTAL FRAME

HEADER SCHEDULE		
TAG	SIZE	JACKS (EACH END)
A	(2) 2x6	(1)
B	(2) 2x8	(2)
C	(2) 2x10	(2)
D	(2) 2x12	(2)
E	(2) 9-1/4" LSL/LVL	(3)
F	(3) 2x6	(1)
G	(3) 2x8	(2)
H	(3) 2x10	(2)
I	(3) 2x12	(2)

HEADER SIZES SHOWN ON PLANS ARE MINIMUMS. GREATER HEADER SIZES MAY BE USED FOR EASE OF CONSTRUCTION. ALL HEADERS TO BE DROPPED UNLESS NOTED OTHERWISE. SC NOTED ON PLAN OVERRIDE SC LISTED ABOVE.

LINTEL SCHEDULE		
TAG	SIZE	OPENING SIZE
①	L3x3x1/4"	LESS THAN 6'-0"
②	L5x3x1/4"	6'-0" TO 10'-0"
③	L5x3-1/2"x5/16"	GREATER THAN 10'-0"
④	L5x3-1/2"x5/16" ROLLED OR EQUIV.	ALL ARCHED OPENINGS

SECURE LINTEL TO HEADER w/ (2) 1/2" DIAMETER LAG SCREWS STAGGERED @ 16" O.C. (TYP FOR ③)

ALL HEADERS WHERE BRICK IS USED, TO BE: ① (UNO)

WALL STUD SCHEDULE

1ST & 2ND FLOOR LOAD BEARING STUDS:
 2x4 STUDS @ 16" O.C. OR 2x6 STUDS @ 24" O.C.

1ST FLOOR LOAD BEARING STUDS w/ WALK-UP ATTIC:
 2x4 STUDS @ 12" O.C. OR 2x6 STUDS @ 16" O.C.

BASEMENT LOAD BEARING STUDS:
 2x4 STUDS @ 12" O.C. OR 2x6 STUDS @ 16" O.C.

NON-LOAD BEARING STUDS (ALL FLOORS):
 2x4 STUDS @ 24" O.C.

TWO STORY WALLS:
 2x4 STUDS @ 12" O.C. OR 2x6 STUDS @ 16" O.C. BALLOON FRAMED w/ CROSS BRACING @ 6'-0" O.C. VERTICALLY

THESE PLANS ARE DESIGNED IN ACCORDANCE WITH ARCHITECTURAL PLANS PROVIDED BY DR. HORTON. COMPLETED/REVISED ON 6/12/2018. IT IS THE RESPONSIBILITY OF THE CLIENT TO NOTIFY SUMMIT ENGINEERING LABORATORY & TESTING, P.C. IF ANY CHANGES ARE MADE TO THE ARCHITECTURAL PLANS PRIOR TO CONSTRUCTION. SUMMIT ENGINEERING LABORATORY & TESTING, P.C. CANNOT GUARANTEE THE ADEQUACY OF THESE STRUCTURAL PLANS WHEN USED WITH ARCHITECTURAL PLANS DATED DIFFERENTLY THAN THE DATE LISTED ABOVE.

INSTALL ANY REQUIRED HOLD-DOWNS PER SECTION R602.10.8 AND FIGURES R602.10.6.5, R602.10.1, R602.10.2(1) AND R602.10.2(2) OF THE 2018 IRC.

NOTE:
 ----- DESIGNATES JOIST SUPPORTED LOAD BEARING WALL ABOVE. PROVIDE BLOCKING UNDER JOIST SUPPORTED LOAD BEARING WALL.

JOIST & BEAM SIZES SHOWN ARE MINIMUMS. BUILDER MAY INCREASE DEPTH FOR EASE OF CONSTRUCTION.

NOTE: MEMBER NOTED AS PRESSURE TREATED MAY BE FRAMED WITH NON-PRESSURE TREATED LUMBER PROVIDED THE ENTIRETY OF THE MEMBER IS WRAPPED TO PREVENT MOISTURE INTRUSION.

NOTE: REDUCE JOIST SPACING UNDER TILE FLOORS, GRANITE COUNTERTOPS AND/OR ISLANDS.

STRUCTURAL MEMBERS ONLY

ENGINEERING SEAL APPLIES ONLY TO STRUCTURAL COMPONENTS ON THIS DOCUMENT. SEAL DOES NOT INCLUDE CONSTRUCTION MEANS, METHODS, TECHNIQUES, SEQUENCES, PROCEDURES OR SAFETY PRECAUTIONS. ANY DEVIATIONS OR DISCREPANCIES ON PLANS ARE TO BE BROUGHT TO THE IMMEDIATE ATTENTION OF SUMMIT ENGINEERING, LABORATORY & TESTING, P.C. FAILURE TO DO SO WILL VOID SUMMIT LIABILITY.

STRUCTURAL ANALYSIS BASED ON 2018 NCR.

SECOND FLOOR FRAMING PLAN

SCALE: 1/4"=1'-0" ON 22"x34" OR 1/8"=1'-0" ON 11"x17"

KING STUD REQUIREMENTS	
OPENING WIDTH	KINGS (EACH END)
LESS THAN 3'-0"	(1)
3'-0" TO 4'-0"	(2)
4'-0" TO 8'-0"	(3)
8'-0" TO 12'-0"	(5)
12'-0" TO 16'-0"	(6)

KING STUD REQUIREMENTS ABOVE DO NOT APPLY TO PORTAL FRAMED OPENINGS

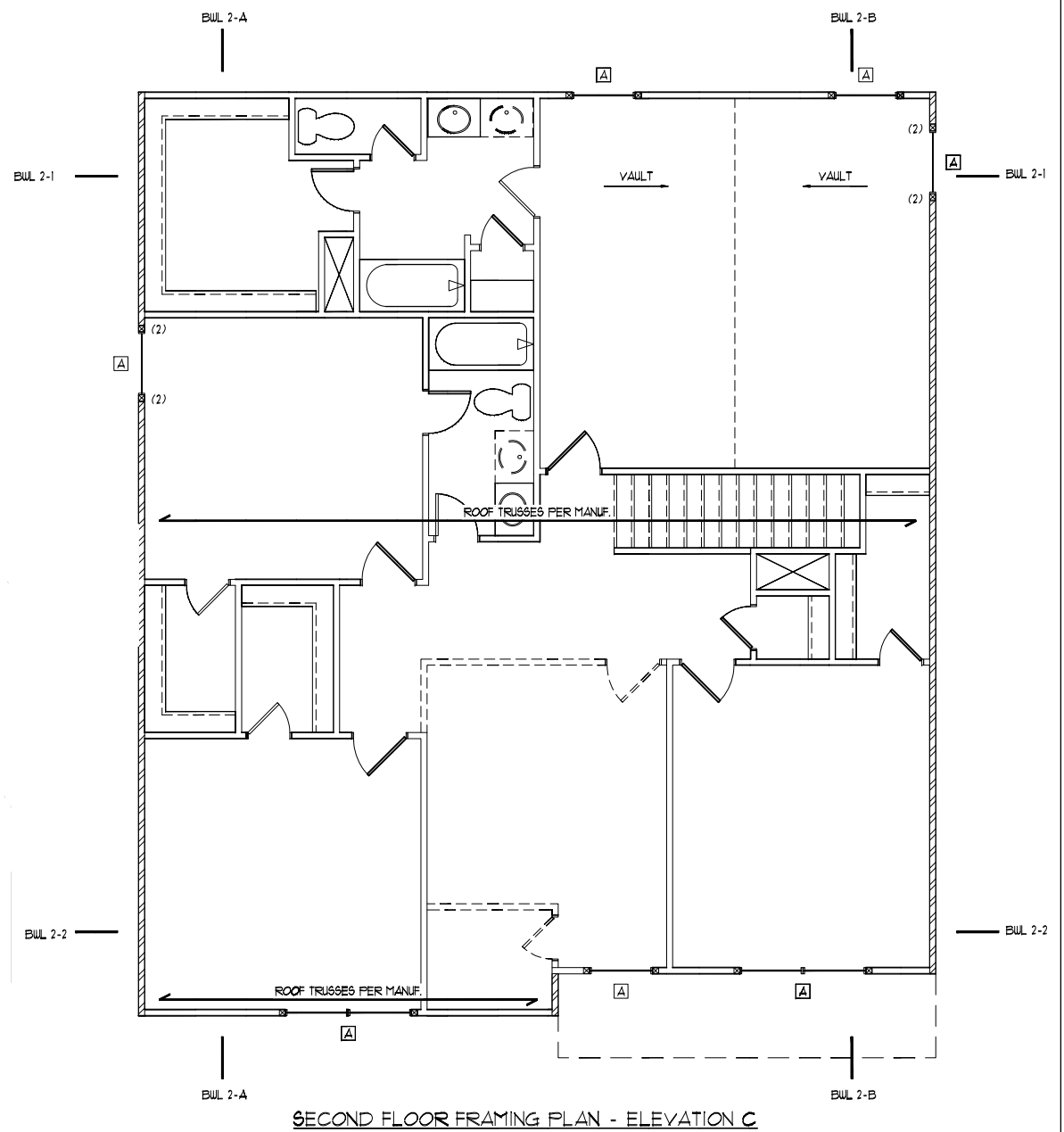

SECOND FLOOR FRAMING PLAN - ELEVATION C

SECOND FLOOR BRACING (FT)		
	CONTINUOUS SHEATHING METHOD	
	REQUIRED	PROVIDED
BUL 2-1	6.8	30.1
BUL 2-2	6.8	21.1
BUL 2-A	5.9	41.0
BUL 2-B	5.9	31.1

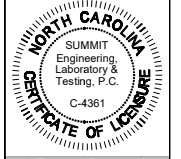

CLIENT:
 DR. HORTON, INC.
 8001 Archdale Blvd.
 Charlotte, NC 28213

PROJECT:
 Wilmington - LH
 Second Floor Framing Plan

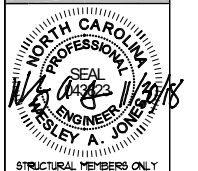

DRAWING
 DATE: 10/02/08
 SCALE: 3/8"=1'-0" INT 1/8"=1'-0"
 PROJECT # 538-0648-1760084
 DRAWN BY: OUP
 CHECKED BY: BAU

ORIGINAL INFORMATION
 PROJECT # 538-0648-1760084
 DATE 09/10/01

REFER TO COVER SHEET FOR A COMPLETE LIST OF REVISIONS

SHEET
 540

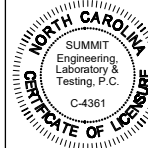

CLIENT:
 DE Lorton, Inc.
 8001 Aronridge Blvd.
 Charlotte, NC 28213

PROJECT:
 Wilmington - LH
 Roof Framing Plan

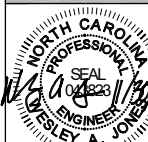

STRUCTURAL MEMBERS ONLY

DRAWING
 DATE: 10/02/08
 SCALE: 22x34 1/4" x 17'-0"
 8x11 1/2" x 17'-0"
 PROJECT # 508-0648-106084
 DRAWN BY: OUP
 CHECKED BY: BAU

ORIGINAL INFORMATION
 PROJECT # DATE
 508 09/10/07

REFER TO COVER SHEET FOR A
 COMPLETE LIST OF REVISIONS

SHEET
 55.2

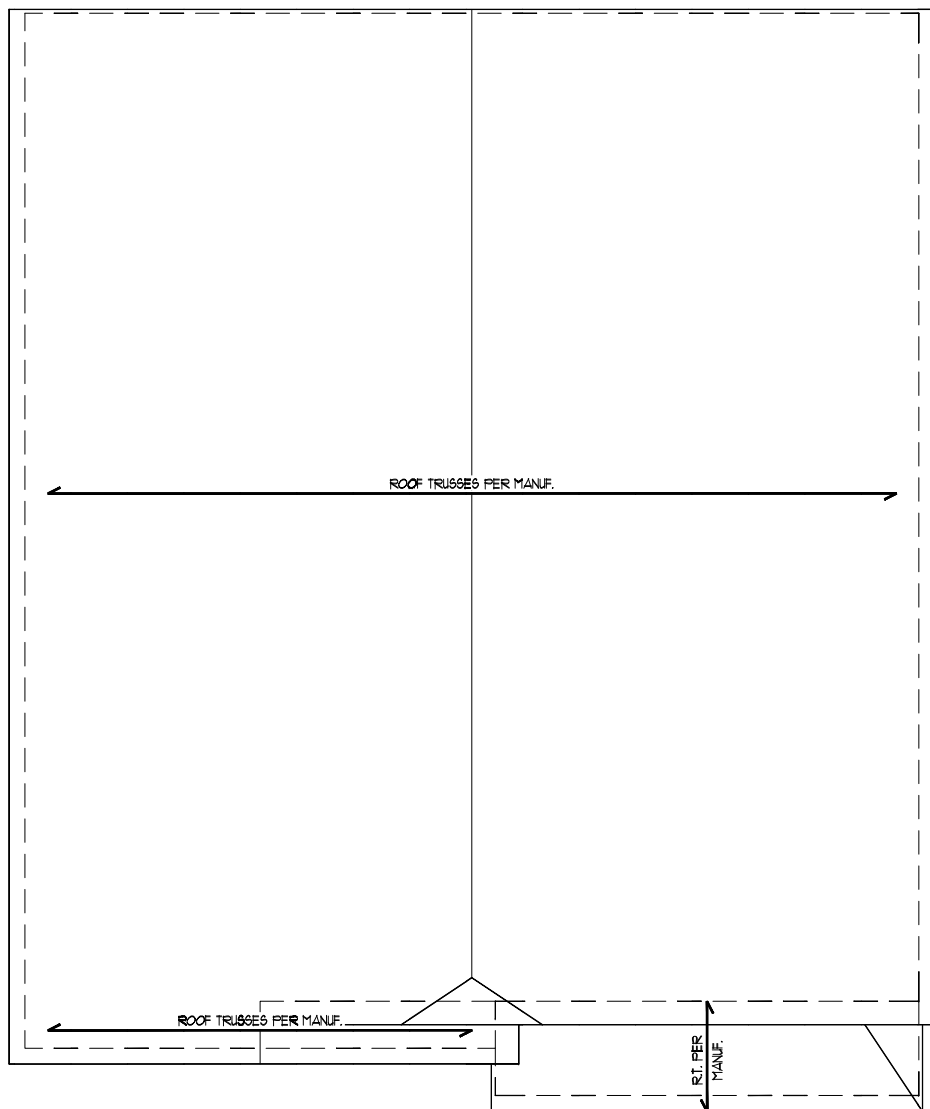

ROOF FRAMING PLAN - ELEVATION C

THESE PLANS ARE DESIGNED IN ACCORDANCE WITH ARCHITECTURAL PLANS PROVIDED BY DR. HORTON. COMPLETED/REVISED ON 6/12/2008. IT IS THE RESPONSIBILITY OF THE CLIENT TO NOTIFY SUMMIT ENGINEERING, LABORATORY & TESTING, P.C. IF ANY CHANGES ARE MADE TO THE ARCHITECTURAL PLANS PRIOR TO CONSTRUCTION. SUMMIT ENGINEERING, LABORATORY & TESTING, P.C. CANNOT GUARANTEE THE ADEQUACY OF THESE STRUCTURAL PLANS WHEN USED WITH ARCHITECTURAL PLANS DATED DIFFERENTLY THAN THE DATE LISTED ABOVE.

NOTE: 1ST PLY OF ALL SHOWN GIRDER TRUSSES TO ALIGN WITH INSIDE FACE OF WALL (TYF, UNO)

NOTE: ROOF TRUSSES SHALL BE SPACE TO SUPPORT FALSE FRAMED DORMER WALLS (TYF, UNO)

STRUCTURAL MEMBERS ONLY
 ENGINEERING SEAL APPLIES ONLY TO STRUCTURAL COMPONENTS ON THIS DOCUMENT. SEAL DOES NOT INCLUDE CONSTRUCTION MEANS, METHODS, TECHNIQUES, SEQUENCES, PROCEDURES OR SAFETY PRECAUTIONS. ANY DEVIATIONS OR DISCREPANCIES ON PLANS ARE TO BE BROUGHT TO THE IMMEDIATE ATTENTION OF SUMMIT ENGINEERING, LABORATORY & TESTING, P.C. FAILURE TO DO SO WILL VOID SUMMIT LIABILITY.

STRUCTURAL ANALYSIS BASED ON 2018 NCRS.

ROOF FRAMING PLAN

SCALE: 1/4"=1'-0" ON 22x34" OR 1/8"=1'-0" ON 11x17"

DESIGN SPECIFICATIONS:

Construction Type: Commercial Residential

Applicable Building Codes:

- 2018 North Carolina Residential Building Code with All Local Amendments
ASCE 7-10: Minimum Design Loads for Buildings and Other Structures

Design Loads:

- 1. Roof Live Loads: 11. Conventional 2x... 20 PSF, 12. Truss... 20 PSF, 12.1. Attic Truss... 60 PSF
2. Roof Dead Loads: 21. Conventional 2x... 10 PSF, 22. Truss... 20 PSF
3. Snow... 15 PSF
3.1. Importance Factor... 1.0
4. Floor Live Loads: 41. Typ. Dwelling... 40 PSF, 42. Sleeping Areas... 30 PSF, 43. Decks... 40 PSF, 44. Passenger Garage... 50 PSF
5. Floor Dead Loads: 51. Conventional 2x... 10 PSF, 52. 1-Joist... 15 PSF, 53. Floor Truss... 15 PSF
6. Ultimate Wind Speed (3 sec. gust)... PER PLAN
6.1. Exposure... B
6.2. Importance Factor... 1.0
6.3. Wind Base Shear: 6.3.1. Vx = 6.3.2. Vy =

7. Component and Cladding (in PSF)

Table with 5 columns: MEAN ROOF HT., UP TO 30', 30'1"-35', 35'1"-40', 40'1"-45'. Rows for ZONE 1 through ZONE 5.

8. Seismic

- 8.1. Site Class... D
8.2. Design Category... C
8.3. Importance Factor... 1.0
8.4. Seismic Use Group... I
8.5. Spectral Response Acceleration: 8.5.1. Sns = %g, 8.5.2. Sm1 = %g
8.6. Seismic Base Shear: 8.6.1. Vx = 8.6.2. Vy =
8.7. Basic Structural System (check one): [x] Bearing Wall, [] Building Frame, [] Moment Frame, [] Dual w/ Special Moment Frame, [] Dual w/ Intermediate R/C or Special Steel, [] Inverted Pendulum
8.8. Arch/Mech Components Anchored... No
8.9. Lateral Design Control: Seismic [] Wind [x]
9. Assumed Soil Bearing Capacity... 2000psf



STRUCTURAL PLANS PREPARED FOR:

STANDARD DETAILS

PROJECT ADDRESS: TBD OUNER: DR Horton Carolinas Division, 8001 Arrowridge Blvd, Charlotte, NC 28273

ARCHITECT/DESIGNER:

These drawings are to be coordinated with the architectural, mechanical, plumbing, electrical and civil drawings. This coordination is not the responsibility of the structural engineering of record (SER). Should any discrepancies become apparent, the contractor shall notify SUMMIT Engineering, Laboratory 4 Testing, P.C. before construction begins.

PLAN ABBREVIATIONS:

Table with 3 columns: ABBREVIATION, DESCRIPTION, MATERIAL. Includes entries like AB ANCHOR BOLT, AFF ABOVE FINISHED FLOOR, etc.

Roof truss and floor joist layouts, and their corresponding loading details, were not provided to SUMMIT Engineering, Laboratory 4 Testing, P.C. (SUMMIT) prior to the initial design. Therefore, truss and joist directions were assumed based on the information provided by DR Horton, Inc. Subsequent plan revisions based on roof truss and floor joist layouts shall be noted in the revision list, indicating the date the layouts were provided. Should any discrepancies become apparent, the contractor shall notify SUMMIT immediately.

SHEET LIST:

Table with 2 columns: Sheet No., Description. Lists sheets CSI, D1m, D1s, D1c, D1b, D1f.

REVISION LIST:

Table with 4 columns: Revision No., Date, Project No., Description. Lists revisions 1 through 9.

DR HORTON PROJECT SIGN-OFF:

Table with 2 columns: Manager, Signature. Rows for Operations, Operations System, Operations Product Development.



CLIENT: DR Horton Carolinas Division, 8001 Arrowridge Blvd, Charlotte, NC 28273

PROJECT: Standard Details, Cover Sheet

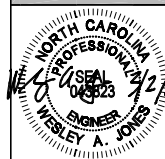

STRUCTURAL MEMBERS ONLY

DRAWN: DATE: 10/28, SCALE: 1/8"=1'-0", PROJECT: P-3801-DR, CHECKED BY: JAJ, ORIGINAL INFORMATION: PROJECT #, DATE: 10/28/21, REFER TO COVER SHEET FOR A COMPLETE LIST OF REVISIONS

SHEET: CSI

GENERAL STRUCTURAL NOTES:

- 1. The design professional whose seal appears on these drawings is the structural engineer of record (SER) for this project. The SER bears the responsibility of the primary structural elements and the performance of this structure. No other party may revise, alter, or delete any structural aspects of these construction documents without written permission of SUMMIT Engineering, Laboratory 4 Testing, P.C. (SUMMIT) or the SER. For the purposes of these construction documents the SER and SUMMIT shall be considered the same entity.
2. The structure is only stable in its completed form. The contractor shall provide all required temporary bracing during construction to stabilize the structure.
3. The SER is not responsible for construction sequences, methods, or techniques in connection with the construction of this structure. The SER will not be held responsible for the contractor's failure to conform to the contract documents, should any non-conformities occur.
4. Any structural elements or details not fully developed on the construction drawings shall be completed under the direction of a licensed professional engineer. These shop drawings shall be submitted to SUMMIT for review before any construction begins. The shop drawings will be reviewed for overall compliance as it relates to the structural design of this project. Verification of the shop drawings for dimensions, or for actual field conditions, is not the responsibility of the SER or SUMMIT.
5. Verification of assumed field conditions is not the responsibility of the SER. The contractor shall verify the field conditions for accuracy and report any discrepancies to SUMMIT before construction begins.
6. The SER is not responsible for any secondary structural elements or non-structural elements, except for the elements specifically noted on the structural drawings.
7. This structure and all construction shall conform to all applicable sections of the International Residential Code.
8. This structure and all construction shall conform to all applicable sections of local building codes.
9. All structural assemblies are to meet or exceed to requirements of the current local building code.

FOUNDATIONS:

- 1. The structural engineer has not performed a subsurface investigation. Verification of this assumed value is the responsibility of the owner or the contractor. Should any adverse soil condition be encountered the SER must be contacted before proceeding.

- 2. The bottom of all footings shall extend below the frost line for the region in which the structure is to be constructed. However, the bottom of all footings shall be a minimum of 12" below grade.
3. Any fill shall be placed under the direction or recommendation of a licensed professional engineer.
4. The resulting soil shall be compacted to a minimum of 95% maximum dry density.
5. Excavations of footings shall be lined temporarily with a 6 mil polyethylene membrane if placement of concrete does not occur within 24 hours of excavation.
6. No concrete shall be placed against any subgrade containing water, ice, frost, or loose material.

STRUCTURAL STEEL:

- 1. Structural steel shall be fabricated and erected in accordance with the American Institute of Steel Construction "Code of Standard Practice for Steel Buildings and Bridges" and the manual of Steel Construction "Load Resistance Factor Design" latest editions.
2. Structural steel shall receive one coat of shop applied rust-inhibitive paint.
3. All steel shall have a minimum yield stress (Fy) of 36 ksi unless otherwise noted.
4. Welding shall conform to the latest edition of the American Welding Society's Structural Welding Code AWS D11. Electrodes for shop and field welding shall be class E70XX. All welding shall be performed by a certified welder per the above standards.

CONCRETE:

- 1. Concrete shall have a normal weight aggregate and a minimum compressive strength (f'c) at 28 days of 3000 psi, unless otherwise noted on the plan.
2. Concrete shall be proportioned, mixed, and placed in accordance with the latest editions of ACI 318: "Building Code Requirements for Reinforced Concrete" and ACI 308: "Specifications for Structural Concrete for Buildings".
3. Air entrained concrete must be used for all structural elements exposed to freeze/thaw cycles and deicing chemicals. Air entrainment amounts (in percent) shall be within -1% to +2% of target values as follows:
3.1. Footings: 5%
3.2. Exterior Slabs: 5%
4. No admixtures shall be added to any structural concrete without written permission of the SER.

- 5. Concrete slabs-on-grade shall be constructed in accordance with ACI 302.1R-96: "Guide for Concrete Slab and Slab Construction".
6. The concrete slab-on-grade has been designed using a subgrade modulus of k=250 pci and a design loading of 200 psf. The SER is not responsible for differential settlement, slab cracking or other future defects resulting from unreported conditions not in accordance with the above assumptions.
7. Control or saw cut joints shall be spaced in interior slabs-on-grade at a maximum of 15'-0" O.C. and in exterior slabs-on-grade at a maximum of 10'-0" unless otherwise noted.
8. Control or saw cut joints shall be produced using conventional process within 4 to 12 hours after the slab has been finished.
9. Reinforcing steel may not extend through a control joint. Reinforcing steel may extend through a saw cut joint.
10. All welded wire fabric (WWF) for concrete slabs-on-grade shall be placed at mid-depth of slab. The WWF shall be securely supported during the concrete pour.

CONCRETE REINFORCEMENT:

- 1. Fibrous concrete reinforcement, or fibermesh, specified in concrete slabs-on-grade may be used for control of cracking due to shrinkage and thermal expansion/contraction, lowered water migration, an increase in impact capacity, increased abrasion resistance, and residual strength.
2. Fibermesh reinforcing to be 100% virgin polypropylene fibers containing no reprocessed olefin materials and specifically manufactured for use as concrete secondary reinforcement.
3. Application of fibermesh per cubic yard of concrete shall equal a minimum of 0.1% by volume (15 pounds per cubic yard).
4. Fibermesh shall comply with ASTM C116, any local building code requirements, and shall meet or exceed the current industry standard.
5. Steel reinforcing bars shall be new billet steel conforming to ASTM A615, grade 60.
6. Detailing, fabrication, and placement of reinforcing steel shall be in accordance with the latest edition of ACI 308: "Manual of Standard Practice for Detailing Concrete Structures".
7. Horizontal footing and wall reinforcement shall be continuous and shall have 90° bends, or corner bars with the same size/spacing as the horizontal reinforcement with a class B tension splice.
8. Lap reinforcement as required, a minimum of 40 bar diameters for tension or compression unless otherwise noted. Splices in masonry shall be a minimum of 48 bar diameters.

- 9. Where reinforcing dowels are required, they shall be equivalent in size and spacing to the vertical reinforcement. The dowel shall extend 48 bar diameters vertically and 20 bar diameters into the footing.
10. Where reinforcing steel is required vertically, dowels shall be provided unless otherwise noted.

WOOD FRAMING:

- 1. Solid sawn wood framing members shall conform to the specifications listed in the latest edition of the "National Design Specification for Wood Construction" (NDS). Unless otherwise noted, all wood framing members are designed to be Spruce-Yellow-Pine (SYP) #2.
2. LVL or PSL engineered wood shall have the following minimum design values:
2.1. E = 1,900,000 psi
2.2. Fv = 2600 psi
2.3. Fx = 285 psi
2.4. Fc = 100 psi
3. Wood in contact with concrete, masonry, or earth shall be pressure treated in accordance with AIAA standard C-19. All other moisture exposed wood shall be treated in accordance with AIAA standard C-2.
4. Nails shall be common wire nails unless otherwise noted.
5. Lag screws shall conform to ANSI/ASME standard B182.1-1981. Lead holes for lag screws shall be in accordance with NDS specifications.
6. All beams shall have full bearing on supporting framing members unless otherwise noted.
7. Exterior and load bearing stud walls are to be 2x4 SYP #2 @ 16" O.C. unless otherwise noted. Studs shall be continuous from the sole plate to the double top plate. Studs shall only be discontinuous at headers for window/door openings. A minimum of one king stud shall be placed at each end of the header. King studs shall be continuous.
8. Individual studs forming a column shall be attached with one 10d nail @ 6" O.C. staggered. The stud column shall be continuous to the foundation or beam. The column shall be properly blocked at all floor levels to ensure proper load transfer.
9. Multi-ply beams shall have each ply attached with (3) 10d nails @ 24" O.C.
10. Fitch beams, 4-ply beams and 3-ply side loaded beams shall be bolted together with (2) rows of 1/2" diameter through bolts staggered @ 16" O.C. unless noted otherwise. Min edge distance shall be 2" and (2) bolts shall be located a min 6" from each end of the beam.

WOOD TRUSSES:

- 1. The wood truss manufacturer/fabricator is responsible for the design of the wood trusses. Submit sealed shop drawings and supporting calculations to the SER for review prior to fabrication. The SER shall have a minimum of five (5) days for review. The review by the SER shall review for overall compliance with the design documents. The SER shall assume no responsibility for the correctness for the structural design of the wood trusses.
2. The wood trusses shall be designed for all required loadings as specified in the local building code, the ASCE Standard "Minimum Design Loads for Buildings and Other Structures" (ASCE 7-05), and the loading requirements shown on these specifications. The truss drawings shall be coordinated with all other construction documents and provisions provided for loads shown on these drawings including but not limited to HVAC equipment, piping, and architectural fixtures attached to the trusses.
3. The trusses shall be designed, fabricated, and erected in accordance with the latest edition of the "National Design Specification for Wood Construction" (NDS) and "Design Specification for Metal Plate Connected Wood Trusses". The truss manufacturer shall provide adequate bracing information in accordance with "Comments and Bracing Recommendations for Handling, Installing and Bracing Metal Plate Connected Wood Trusses" (MIB-9). This bracing, both temporary and permanent, shall be shown on the shop drawings. Also, the shop drawings shall show the required attachments for the trusses.
4. All chords or truss webs shown on these drawings have been shown as a reference only. The final design of the trusses shall be per the manufacturer.
5. EXTERIOR WOOD FRAMED DECKS:
1. Decks are to be framed in accordance with local building codes and as referenced on the structural plans, either through code references or construction details.

EXTERIOR WOOD FRAMED DECKS:

- 1. Fabrication and placement of structural wood sheathing shall be in accordance with the APA Design/Construction Guide "Residential and Commercial," and all other applicable APA standards.
2. All structurally required wood sheathing shall bear the mark of the APA.

WOOD STRUCTURAL PANELS:

- 1. Fabrication and placement of structural wood sheathing shall be in accordance with the APA Design/Construction Guide "Residential and Commercial," and all other applicable APA standards.
2. All structurally required wood sheathing shall bear the mark of the APA.

- 3. Wood wall sheathing shall comply with the requirements of local building codes for the appropriate state as indicated on these drawings. Refer to wall bracing notes in plan set for more information. Sheathing shall be applied with the long direction perpendicular to framing, unless noted otherwise.
4. Roof sheathing shall be APA rated sheathing exposure 1 or 2. Roof sheathing shall be continuous over two supports and attached to its supporting roof framing with (1)-8d CC nail at 6" o/c at panel edges and at 12" o/c in panel field unless otherwise noted on the plans. Sheathing shall be applied with the long direction perpendicular to framing. Sheathing shall have a span rating consistent with the framing spacing. Use suitable edge support by use of plywood clips or lumber blocking unless otherwise noted. Panel end joints shall occur over framing. Apply building paper over the sheathing as required by the state Building Code.
5. Wood floor sheathing shall be APA rated sheathing exposure 1 or 2. Attach sheathing to its supporting framing with (1)-8d CC ringshank nail at 6" o/c at panel edges and at 12" o/c in panel field unless otherwise noted on the plans. Sheathing shall be applied perpendicular to framing. Sheathing shall have a span rating consistent with the framing spacing. Use suitable edge support by use of T&G plywood or lumber blocking unless otherwise noted. Panel end joints shall occur over framing. Apply building paper over the sheathing as required by the state Building Code.
6. Sheathing shall have a 1/8" gap at panel ends and edges as recommended in accordance with the APA.

STRUCTURAL FIBERBOARD PANELS:

- 1. Fabrication and placement of structural fiberboard sheathing shall be in accordance with the applicable AFA standards.
2. All structurally required fiberboard sheathing shall bear the mark of the AFA.
3. Fiberboard wall sheathing shall comply with the requirements of local building codes for the appropriate state as indicated on these drawings. Refer to wall bracing notes in plan set for more information.
4. Sheathing shall have a 1/8" gap at panel ends and edges as recommended in accordance with the AFA.



STANDARD - SIDING



STANDARD - BRICK



STANDARD - SIDING



STANDARD - BRICK

1 TYP. SLAB DETAIL
D1m N.T.S.

2 TYP. GARAGE CURB DETAIL
D1m N.T.S.



3 STEP IN GARAGE
D1m N.T.S.



4 SLAB AT GARAGE DOOR
D1m N.T.S.



5 TYP. THICKENED SLAB DETAIL
D1m N.T.S.

MONOLITHIC FOOTING WIDTH

# OF STORIES	WIDTH BASED ON SOIL BEARING CAPACITY		
	1500 PSF	2000 PSF	2500 PSF
1 STORY - STD.	16"	16"	16"
1 STORY - BRICK VENEER	21"	21"	21"
2 STORY - STD.	16"	16"	16"
2 STORY - BRICK VENEER	21"	21"	21"
3 STORY - STD.	23"	18"	18"
3 STORY - BRICK VENEER	32"	24"	24"

*5" BRICK LEDGE HAS BEEN ADDED TO THE MONOLITHIC FOOTING WIDTH FOR BRICK SUPPORT

WALL ANCHOR SCHEDULE

TYPE OF ANCHOR	MIN. CONC. EMBEDMENT	SPACING EMBEDMENT	INTERIOR WALL	EXTERIOR WALL
1/2" A307 BOLTS w/ STD. 90° BEND	7"	6'-0"	YES	YES
SST - MAS	4"	5'-0"	NO	YES
HILTI KWIK BOLT KBI 1/2-2-3/4	2-1/4"	6'-0"	YES	NO
1/2" HILTI THREADED ROD w/ HIT HY150 ADHESIVE	7"	6'-0"	YES	YES

NOTE: INSTALL ALL ANCHORS 12" MAX. FROM ALL BOTTOM PLATE ENDS AND JOINTS.



STANDARD - SIDING



STANDARD - BRICK

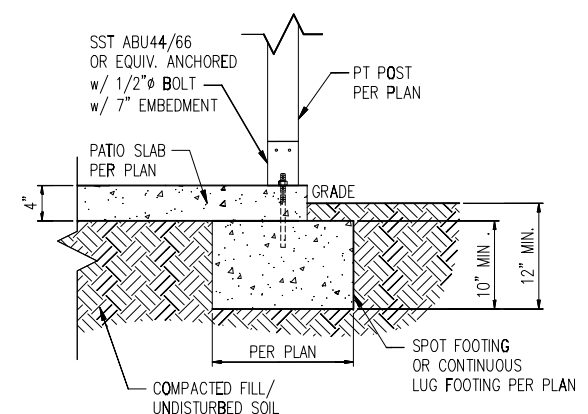

6A COVERED PATIO DETAIL
D1m N.T.S.

6 PATIO SLAB DETAIL
D1m N.T.S.

- NOTES:
- REFER TO GENERAL NOTES & SPECIFICATIONS ON COVERSHEET FOR ADDITIONAL INFORMATION.
 - PROVIDE 6 MIL VAPOR BARRIER UNDER ALL SLABS-ON-GRADE.
 - SEE ARCH. DWGS. FOR ALL TOP OF THE SLAB ELEVATIONS, SLOPES AND DEPRESSIONS.
 - REFER TO STRUCTURAL PLANS AND FRAMING DETAILS FOR BRACED WALL PANEL LAYOUT, DIMENSIONS, ATTACHMENT AND CONNECTIONS
 - REFER TO LOCAL AND STATEWIDE CODES FOR ADDITIONAL AMENDMENTS AND REQUIREMENTS NOT SHOWN
 - PERIMETER INSULATION SHOWN AS REQUIRED BY LOCAL CLIMATE ZONE. INSTALL PER TABLE N1102.1.2 OF THE 2018 NCRC

MIN. 3/8" ROOF SHEATHING SECURED IN ACCORDANCE WITH FIGURE TABLE R602.3(1) (SEE NOTE G FOR ULTIMATE WIND SPEEDS GREATER THAN 120MPH). PROVIDE UNDERLAYMENT IN ACCORDANCE WITH CHAPTER 9 OF THE 2018 NCRC

PROVIDE MINIMUM INSULATION REQUIRED PER N1102.1.2 OF THE 2018 NCRC



1 TYP. INTERIOR LOAD BEARING WALL SECTION
D2m N.T.S.

MIN. 3/8" ROOF SHEATHING SECURED IN ACCORDANCE WITH FIGURE TABLE R602.3(1) (SEE NOTE G FOR ULTIMATE WIND SPEEDS GREATER THAN 120MPH). PROVIDE UNDERLAYMENT IN ACCORDANCE WITH CHAPTER 9 OF THE 2018 NCRC

PROVIDE MINIMUM INSULATION REQUIRED PER N1102.1.2 OF THE 2018 NCRC



2 TYP. EXTERIOR LOAD BEARING WALL SECTION
D2m N.T.S.

-SIMILAR w/ BRICK AND STONE
-BRICK TIES SPACED @ 16" O.C. HORIZ. & 24" O.C. VERT.
-MIN. 3/16" WEEP HOLES @ 33" O.C.

*BRICK TIES SPACED @ 16" O.C. HORIZ. & 24" O.C. VERT. AND 3/16" WEEP HOLES @ 33" O.C. LOCATED A MINIMUM OF 4" ABOVE THE EARTH



3 TALL SLAB DETAIL
D2m N.T.S.

NOTES:

- REFER TO GENERAL NOTES & SPECIFICATIONS ON COVERSHEET FOR ADDITIONAL INFORMATION.
- PROVIDE 6 MIL VAPOR BARRIER UNDER ALL SLABS-ON-GRADE.
- SEE ARCH. DWGS. FOR ALL TOP OF THE SLAB ELEVATIONS, SLOPES AND DEPRESSIONS.
- REFER TO STRUCTURAL PLANS AND FRAMING DETAILS FOR BRACED WALL PANEL LAYOUT, DIMENSIONS, ATTACHMENT AND CONNECTIONS
- REFER TO LOCAL AND STATEWIDE CODES FOR ADDITIONAL AMENDMENTS AND REQUIREMENTS NOT SHOWN
- PERIMETER INSULATION SHOWN AS REQUIRED BY LOCAL CLIMATE ZONE. INSTALL PER TABLE N1102.1.2 OF THE 2018 NCRC



1 METHOD PF: PORTAL FRAME DETAIL
D1f 3/8" = 1'-0"



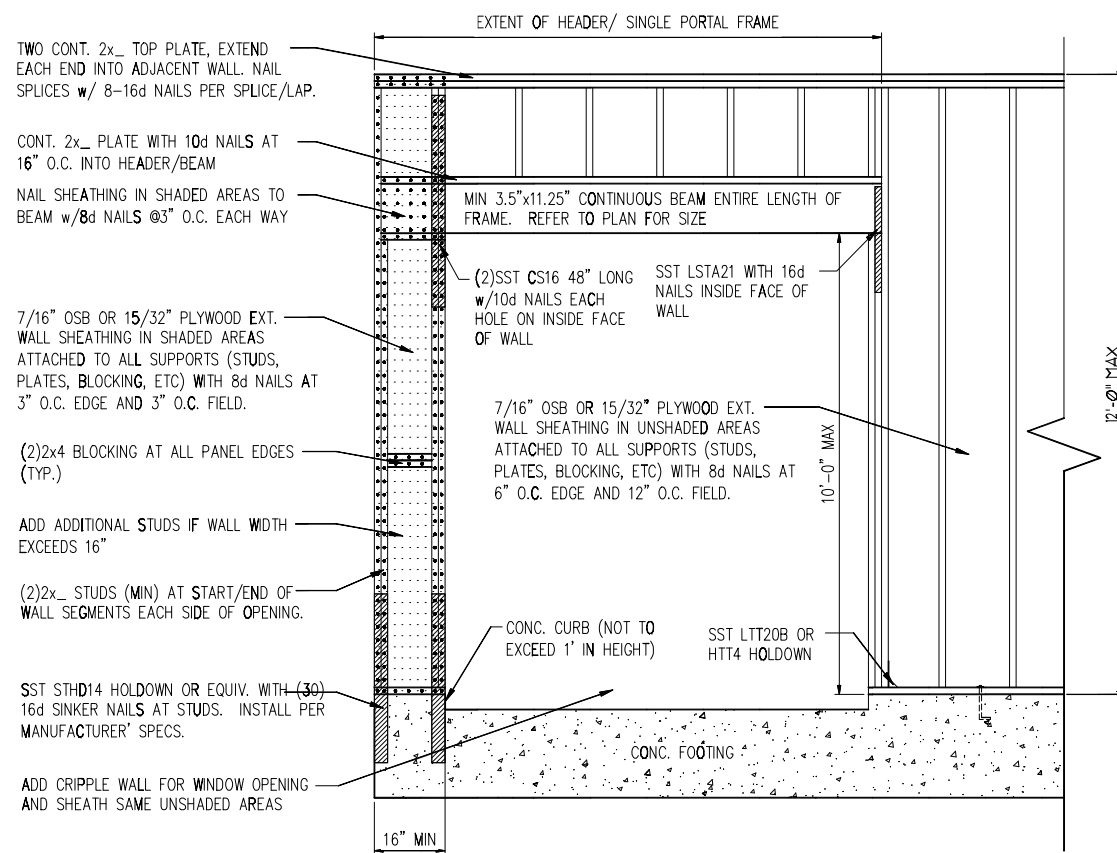

1 METHOD PF: PORTAL FRAME DETAIL w/ HOLD-DOWNS
 D2f 3/4" = 1'-0"

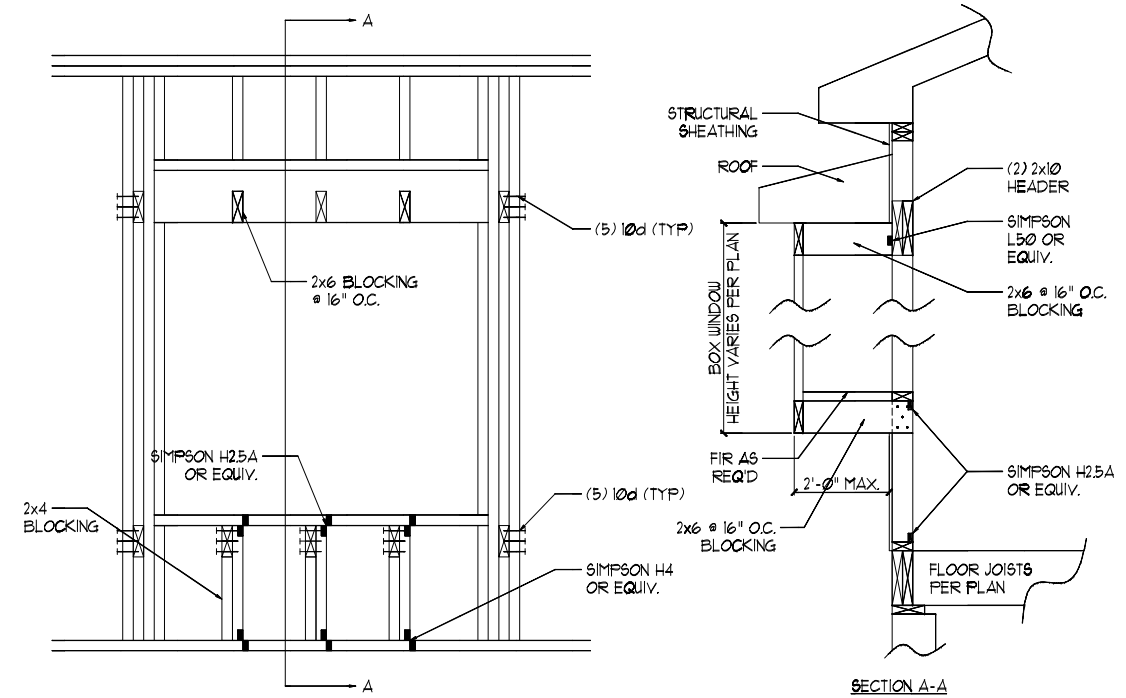
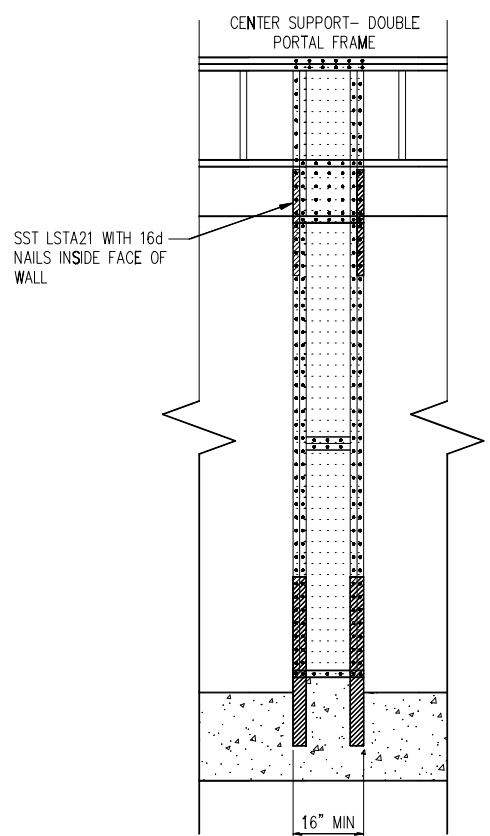

2 BOX WINDOW DETAIL
 D2f N.T.S.

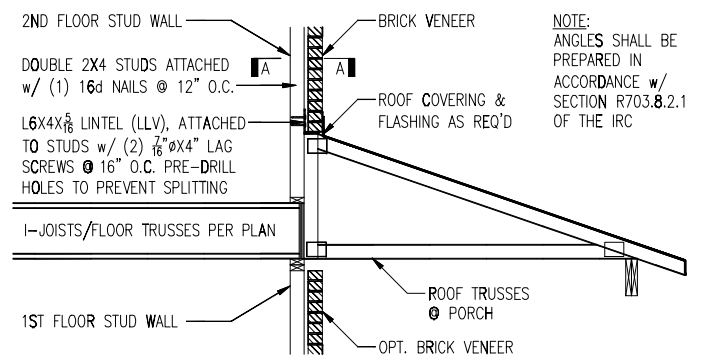

3 BRICK SUPPORT ABOVE STORAGE/PORCH ROOF DETAIL
 D2f N.T.S.

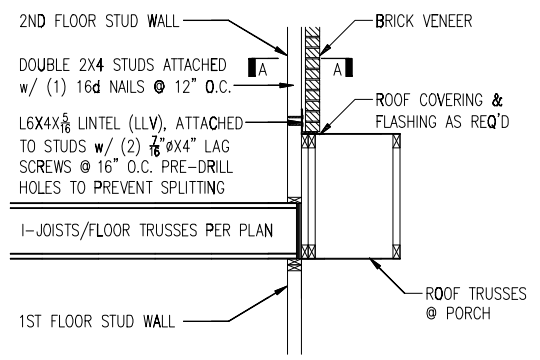

TRUSSES PARALLEL TO STUD WALL

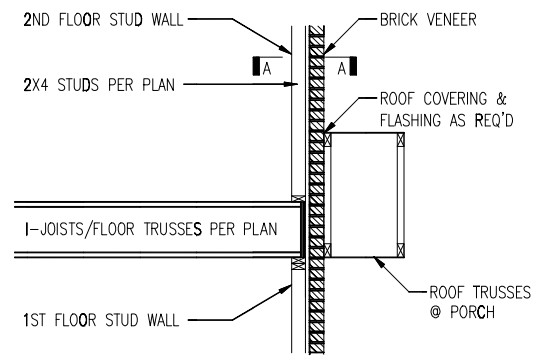

TRUSSES PARALLEL TO STUD WALL
 w/ CONTINUOUS BRICK VENEER

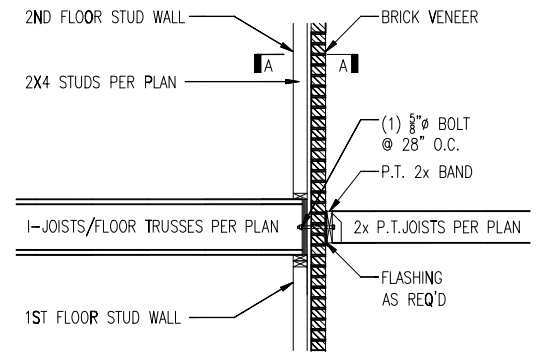

4 BALCONY JOIST ATTACHMENT
 D2f N.T.S.

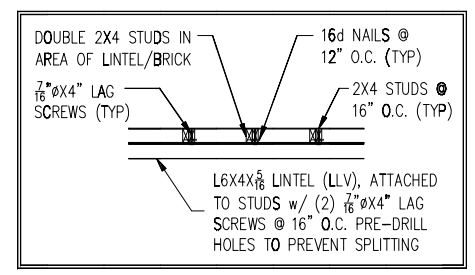

SECTION A-A
 N.T.S.

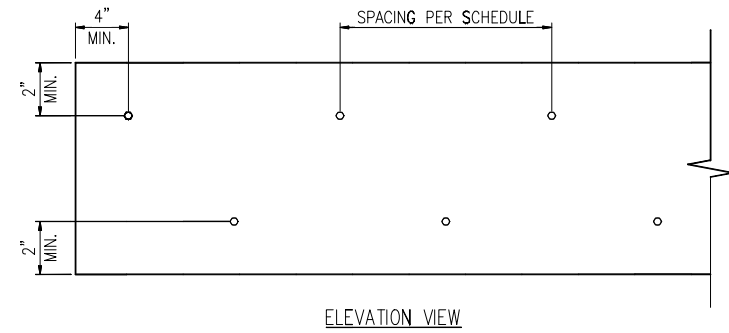

1 MULTI-PLY BEAM CONNECTION DETAIL
D3f N.T.S.

MINIMUM FASTENING REQUIREMENTS FOR TOP- AND SIDE-LOADED MEMBERS

FASTENER TYPE	LVL DEPTH	3 1/2" WIDE		5 1/2" WIDE		7" WIDE	
		2-Ply 1 3/4"	3-Ply 1 3/4"	1 3/4" + 3 1/2"	4-Ply 1 3/4"	2-Ply 1 3/4" + 3 1/2"	2-Ply 3 1/2"
10d (0.128" x 3") Nails	7 1/4" ≤ d < 14"	3 rows @ 12" o.c.	3 rows @ 12" o.c. (ES)	3 rows @ 12" o.c.	-	3 rows @ 12" o.c. (ES)	-
	d ≥ 14"	4 rows @ 12" o.c.	4 rows @ 12" o.c. (ES)	4 rows @ 12" o.c.	-	4 rows @ 12" o.c. (ES)	-
16d (0.162" x 3 1/2") Nails	7 1/4" ≤ d < 14"	2 rows @ 12" o.c.	2 rows @ 12" o.c. (ES)	2 rows @ 12" o.c.	-	2 rows @ 12" o.c. (ES)	-
	d ≥ 14"	3 rows @ 12" o.c.	3 rows @ 12" o.c. (ES)	3 rows @ 12" o.c.	-	3 rows @ 12" o.c. (ES)	-
1/2" Through Bolts		2 rows @ 24" o.c.	2 rows @ 24" o.c.	2 rows @ 24" o.c.	-	2 rows @ 24" o.c.	-
SDS 1/4" x 3 1/2", WS35, 3 1/2" TrussLok	d ≥ 7 1/4"	2 rows @ 24" o.c.	2 rows @ 24" o.c. (ES)	2 rows @ 24" o.c.	-	2 rows @ 24" o.c. (ES)	-
SDS 1/4" x 6", WS6		-	-	-	2 rows @ 24" o.c. (ES)	-	-
5" TrussLok		-	2 rows @ 24" o.c.	-	-	-	-
6 1/4" TrussLok		-	-	-	2 rows @ 24" o.c.	-	-

NOTES:
 1. All fasteners must meet the minimum requirements in the table above. Side-loaded multiple-ply members must meet the minimum fastening and side-loading capacity requirements given on page 48.
 2. Minimum fastening requirements for depths less than 7 1/4" require special consideration. Please contact your technical representative.
 3. Three general rules for staggering or offsetting for a certain fastener schedule:
 (1) If staggering or offsetting is not referenced, then none is required.
 (2) If staggering is referenced, then fasteners installed in adjacent rows on the front side are to be staggered up to one-half the o.c. spacing, but maintaining the fastener clearances above; and
 (3) If "ES" is referenced, then the fastener schedule must be repeated on each side, with the fasteners on the back side offset up to one-half the o.c. spacing of the front side (whether or not it is staggered).

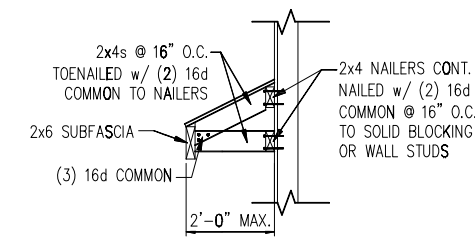

5 GABLE ROOF RETURN
D3f N.T.S.

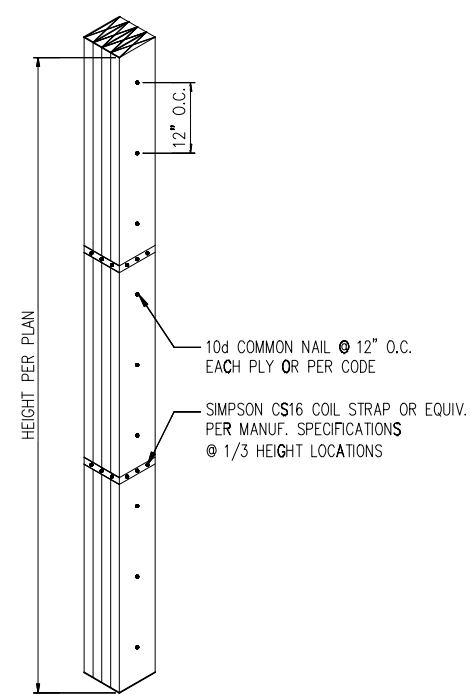

2 MULTI-PLY STUD CONNECTION DETAIL
D3f N.T.S. 4+ PLYS

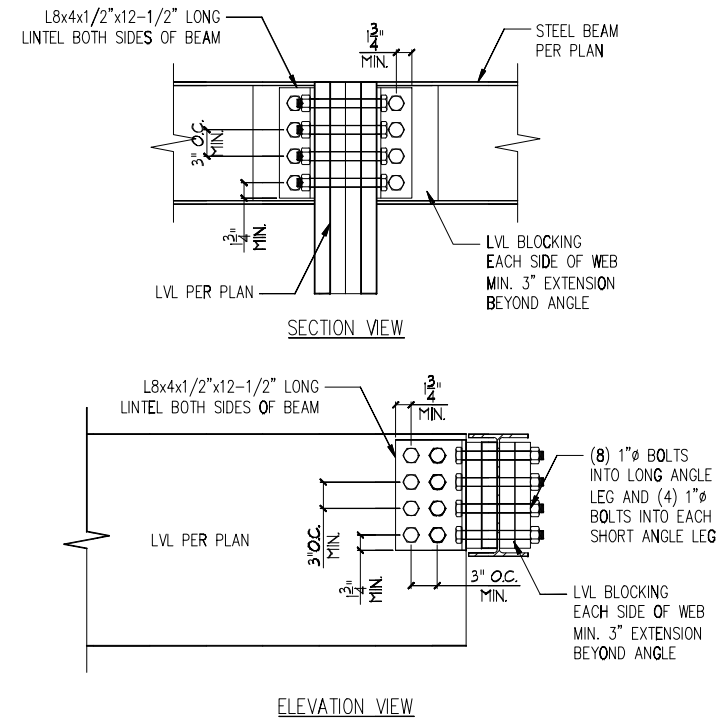

3 LVL TO STEEL DETAIL
D3f N.T.S.

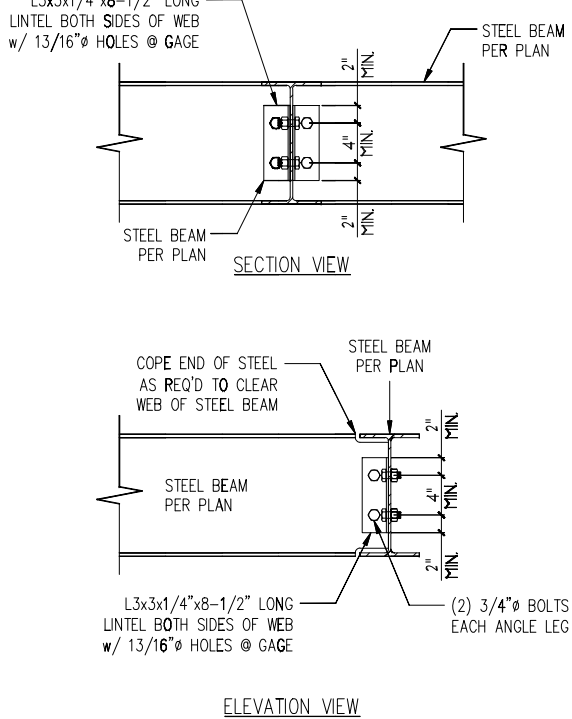

4 STEEL TO STEEL DETAIL
D3f N.T.S.

24" o.c.
SPACING

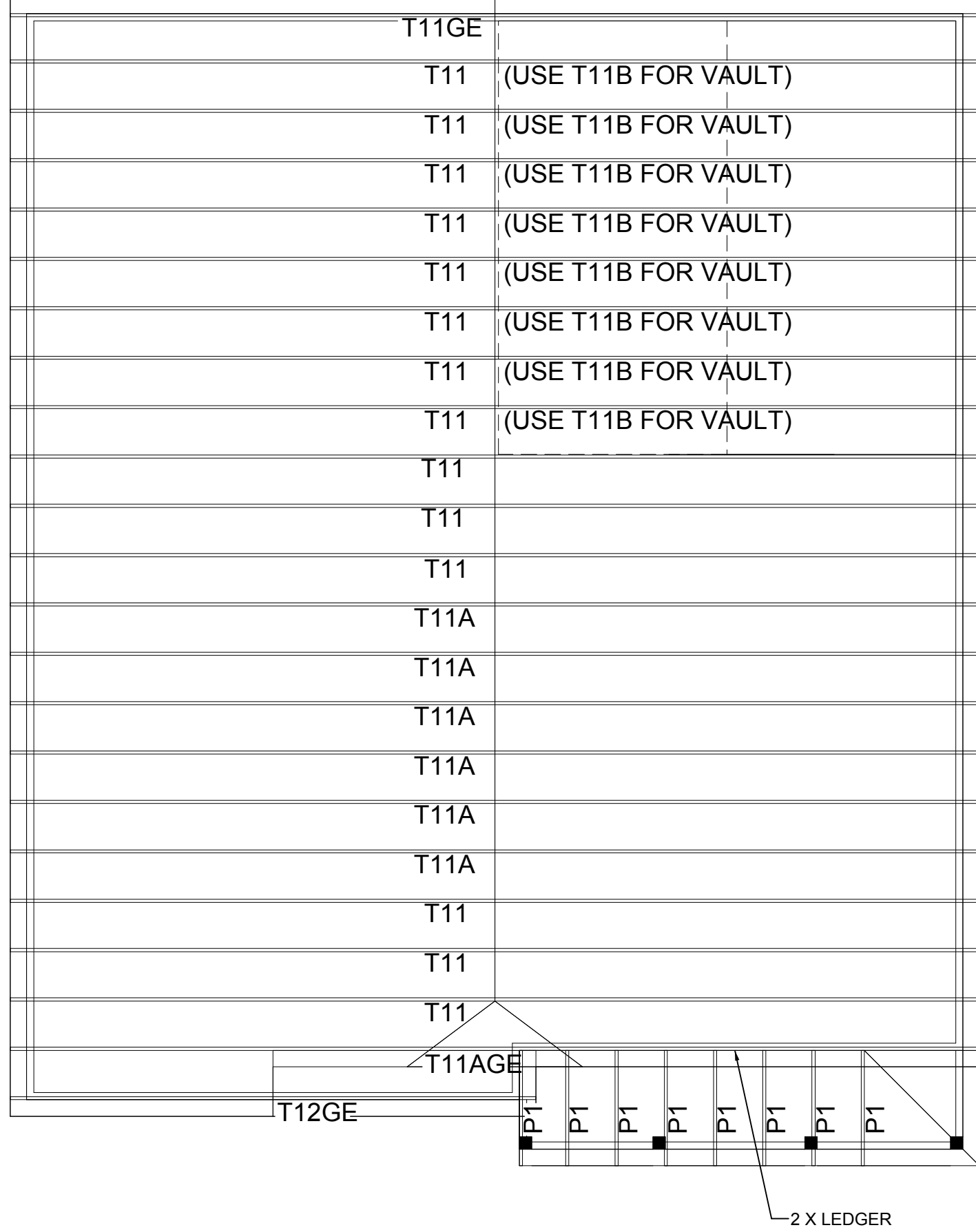

T11GE

- T11 (USE T11B FOR VAULT)
- T11 (USE T11B FOR VAULT)
- T11 (USE T11B FOR VAULT)
- T11 (USE T11B FOR VAULT)
- T11 (USE T11B FOR VAULT)
- T11 (USE T11B FOR VAULT)
- T11 (USE T11B FOR VAULT)
- T11 (USE T11B FOR VAULT)
- T11 (USE T11B FOR VAULT)

T11

T11

T11

T11A

T11A

T11A

T11A

T11A

T11A

T11

T11

T11

T11AGE

T12GE

P1

P1

P1

P1

P1

P1

P1

P1

2 X LEDGER

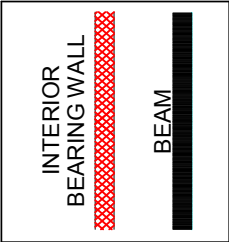

- NOTES:**
- 1) FOLLOW SIMPSONS INSTALLATION RECOMMENDATIONS FOR HANGER CONNECTIONS.
 - 2) VERIFY ALL BUILDING DIMENSIONS PRIOR TO TRUSS ERECTION.
 - 3) EXTERIOR DIMENSIONS ARE FROM OUT TO OUT OF SHEATHING UNLESS NOTED OTHERWISE.
 - 4) SEE DETAIL SHEETS PROVIDED IN THE TRUSS PACKAGE FOR INSTALLATION INFORMATION CONCERNING PIGGY-BACK AND/OR HINGE-PLATE TRUSSES.
 - 5) SHADED AREAS TO BE FRAMED IN FIELD.

MATERIAL SCHEDULE		ROOF LOADING	
SYMBOL	QTY	TLL:	WIND SPEED 90 MPH
■	-	20 PSF	
■	-	10 PSF	
■	-	0 PSF	
■	-	10 PSF	
■	-		

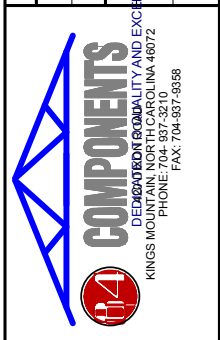

CUSTOMER: REGENT HOMES	
MODEL: WILMINGTON "C" FLAT & VLT ROOF	LOT#: -
COMMUNITY: -	PO#: -
SCALE: NOT TO SCALE	SHIP DATE: -
DATE: 3/28/11	LAST REV: -
DESIGNED BY: RWD	DRAWN BY: RWD
REG234 & 235	

DR Horton The Wilmington Elev.C 44 Morgan North

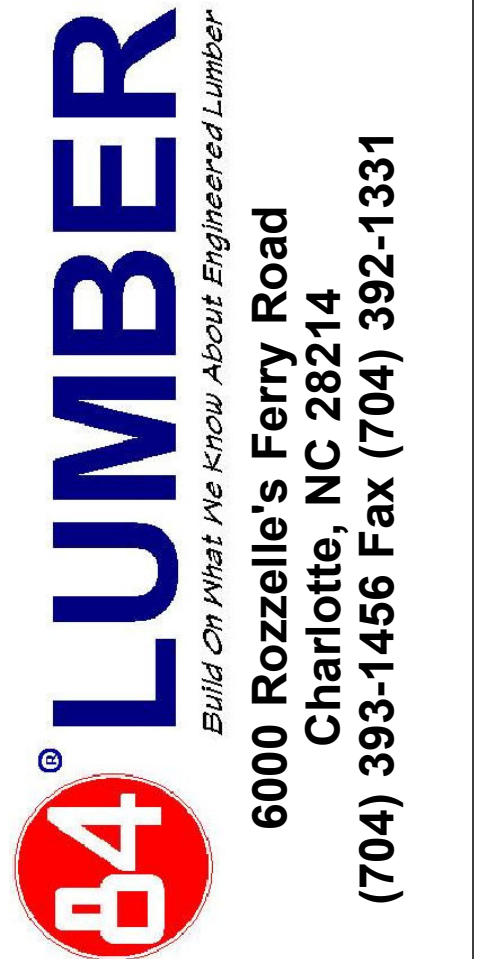

DR Horton
The Wilmington Elev.C
44 Morgan North
84 Lumber Charlotte EWP
Charlotte, North Carolina

BC FRAMER II
Scale: NTS = 1'-0
Arch Date: 02282020
Struc Date: 11302018
Designer: GAT
File:11272019
DWG:The Wilmington
Sheet: 2/2

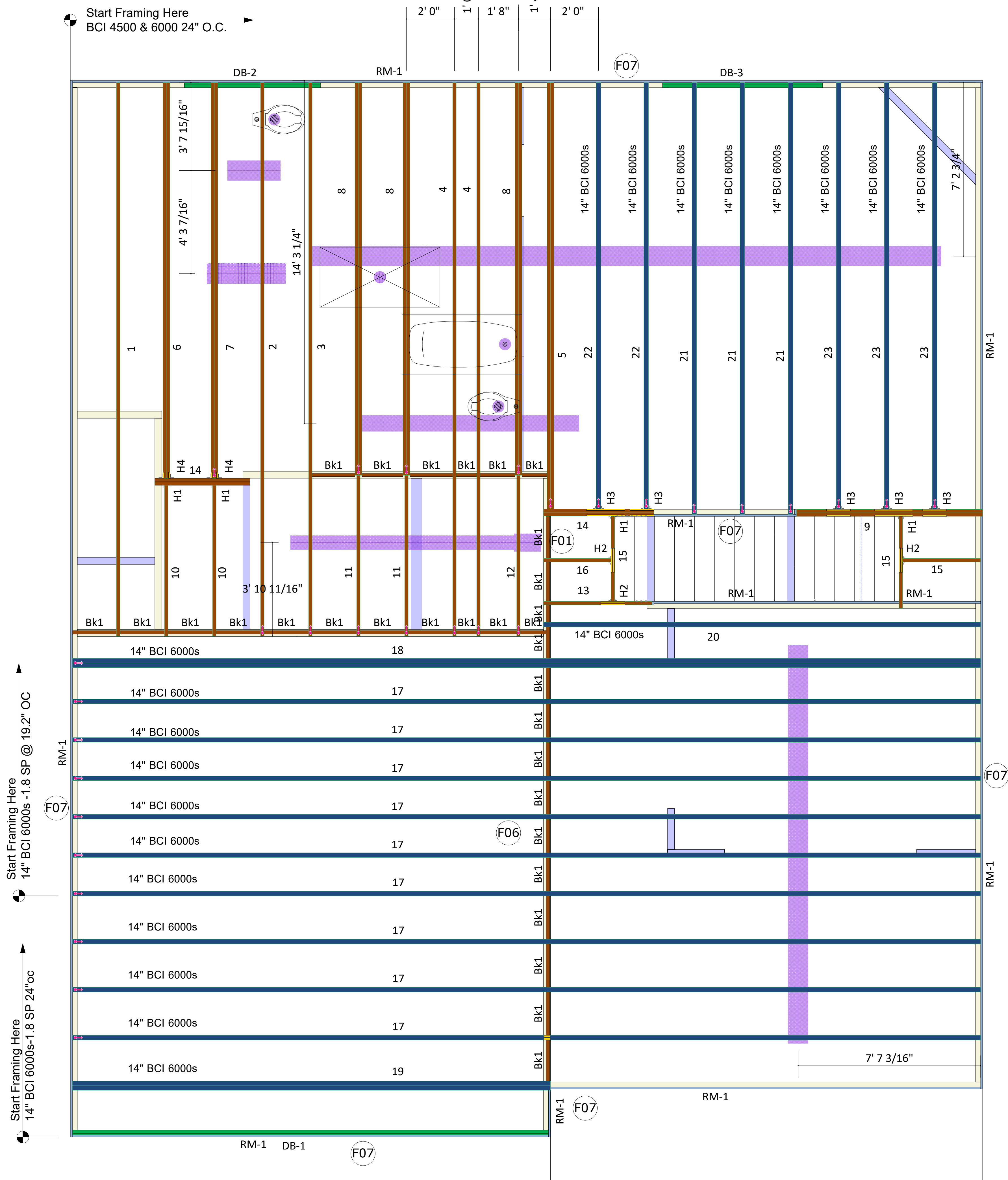

PlotID	Net Qty	Product	Length	Plies
1	1	14" BCI® 4500s-1.8	24' 0"	1
2	1	14" BCI® 4500s-1.8	24' 0"	1
3	1	14" BCI® 4500s-1.8	24' 0"	1
4	2	14" BCI® 4500s-1.8	24' 0"	1
5	2	14" BCI® 4500s-1.8	18' 0"	2
6	2	14" BCI® 4500s-1.8	17' 0"	2
7	2	14" BCI® 4500s-1.8	17' 0"	2
8	6	14" BCI® 4500s-1.8	17' 0"	2
9	2	14" BCI® 4500s-1.8	8' 0"	2
10	2	14" BCI® 4500s-1.8	7' 0"	1
11	2	14" BCI® 4500s-1.8	7' 0"	1
12	1	14" BCI® 4500s-1.8	7' 0"	1
13	1	14" BCI® 4500s-1.8	5' 0"	1
14	2	14" BCI® 4500s-1.8	5' 0"	2
15	3	14" BCI® 4500s-1.8	4' 0"	1
16	1	14" BCI® 4500s-1.8	3' 0"	1
17	9	14" BCI® 6000s-1.8	38' 0"	1
18	2	14" BCI® 6000s-1.8	38' 0"	2
19	2	14" BCI® 6000s-1.8	21' 0"	2
20	1	14" BCI® 6000s-1.8	19' 0"	1
21	3	14" BCI® 6000s-1.8	19' 0"	1
22	2	14" BCI® 6000s-1.8	18' 0"	1
23	3	14" BCI® 6000s-1.8	18' 0"	1
14	2	14" BCI® 4500s-1.8	4' 0"	2
DB-1	2	1-3/4" x 11-7/8" VERSA-LAM® LVL 2.1E 3100 SP	20' 0"	2
RM-1	16	1" x 14" BC RIM BOARD OSB	12' 0"	1
Bk1	28	14" BCI® 4500s-1.8	2' 0"	1

PlotID	Qty	Manuf	Product
H1	4	Simpson	IUS1.81/14
H2	3	Simpson	IUS1.81/14
H3	5	Simpson	IUS2.37/14
H4	2	Simpson	IUS3.56/14

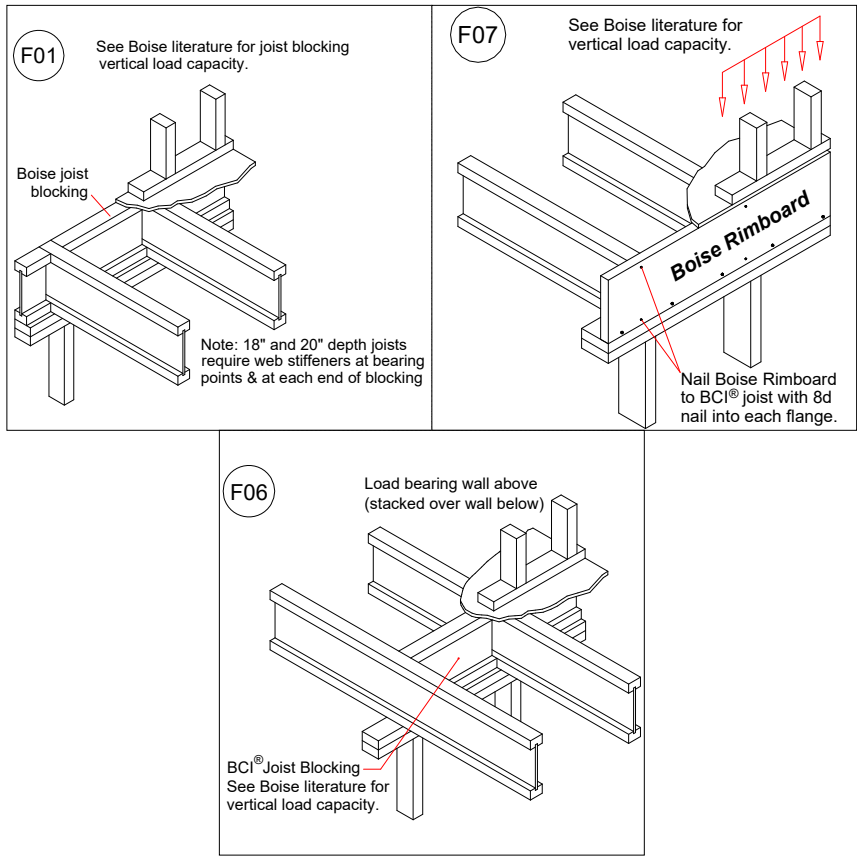

All I-Joist and Versa-Lam Beams Must be Installed per The Boise Cascade Installation Guide!

Squash Blocks Required Under The Ends Of All LVL And Point Loads For Load Transfer - See Details

Second Floor Layout