

KB Homes
2939 Highland Grove Elev.B
41 Highland Grove

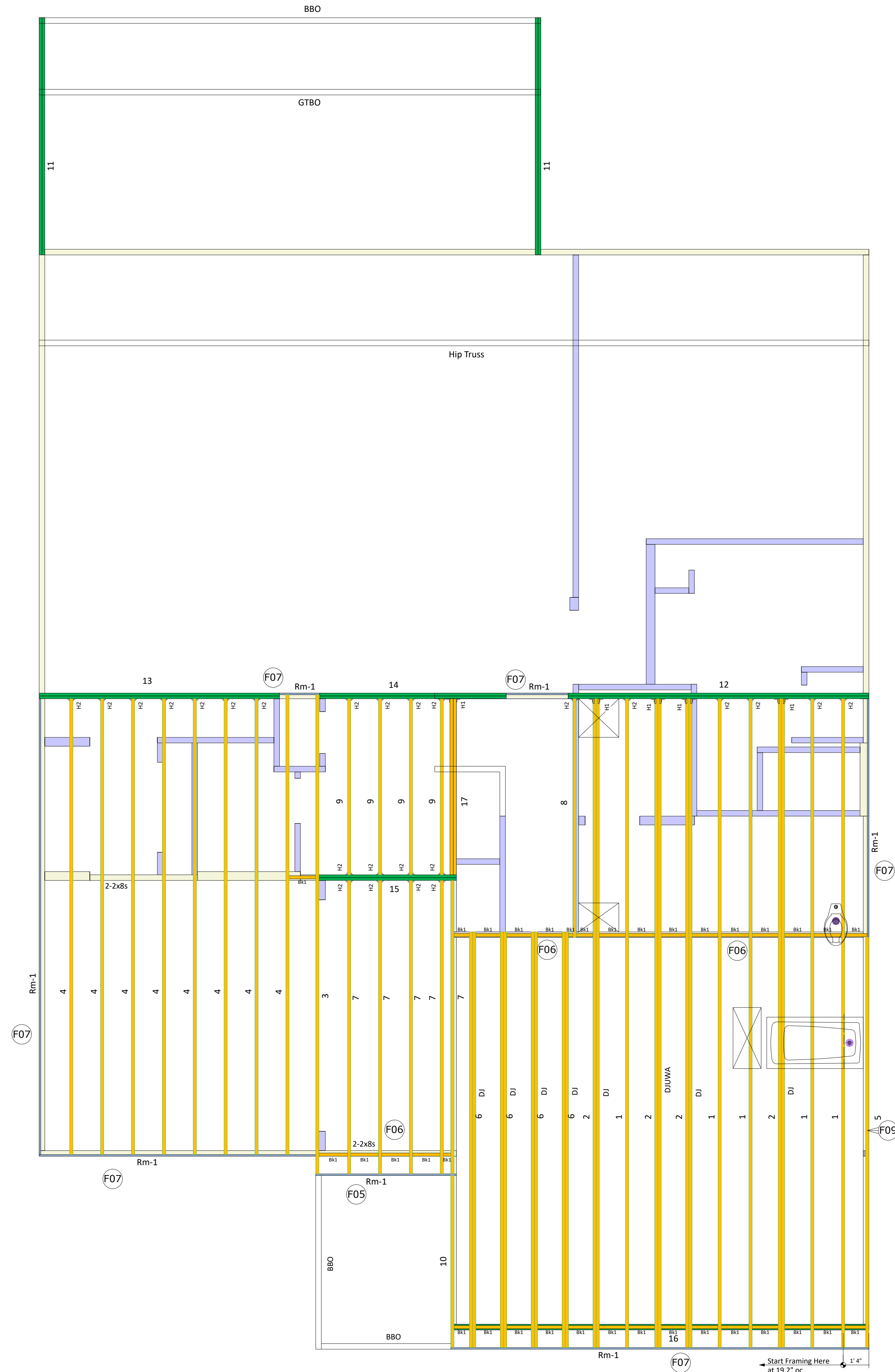

Products				
PlotID	Net Qty	Product	Length	Plies
1	5	14" BCI# 5000s-1.8	34'0"	1
2	8	14" BCI# 5000s-1.8	34'0"	2
3	1	14" BCI# 5000s-1.8	25'0"	1
4	8	14" BCI# 5000s-1.8	24'0"	1
5	1	14" BCI# 5000s-1.8	22'0"	1
6	8	14" BCI# 5000s-1.8	22'0"	2
7	5	14" BCI# 5000s-1.8	16'0"	1
8	1	14" BCI# 5000s-1.8	13'0"	1
9	4	14" BCI# 5000s-1.8	10'0"	1
10	1	14" BCI# 5000s-1.8	9'0"	1
11	4	1-3/4" x 11-7/8" VERSA-LAM# LVL 2.1E 3100 SP	14'0"	2
12	2	1-3/4" x 14" VERSA-LAM# LVL 2.1E 3100 SP	16'0"	2
13	2	1-3/4" x 14" VERSA-LAM# LVL 2.1E 3100 SP	14'0"	2
14	2	1-3/4" x 14" VERSA-LAM# LVL 2.1E 3100 SP	10'0"	2
15	2	1-3/4" x 14" VERSA-LAM# LVL 2.1E 3100 SP	8'0"	2
16	2	1-3/4" x 18" VERSA-LAM# LVL 2.1E 3100 SP	22'0"	2
17	2	14" BCI# 5000s-1.8	10'0"	2
Rm-1	8	1" x 14" BC RIM BOARD OSB	12'0"	1
Bk1	22	14" BCI# 5000s-1.8	2'0"	1

Connector Summary			
PlotID	Qty	Manuf	Product
H1	5	Simpson	HU4.12/11
H2	25	Simpson	IUS2.06/14

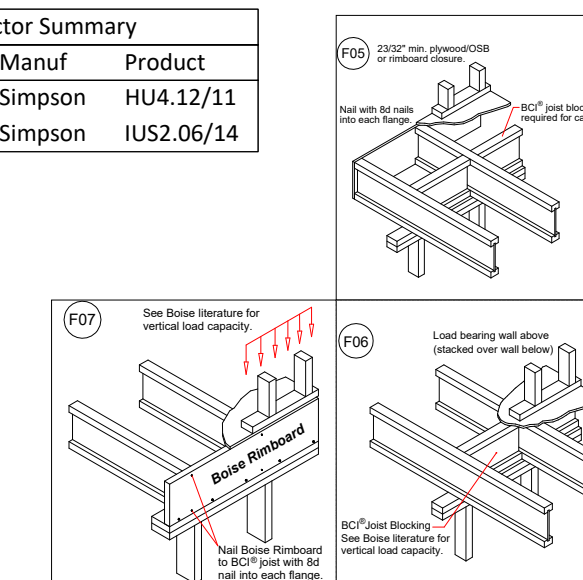

All I-Joist and Versa-Lam Beams
Must be Installed per The
Boise Cascade Installation Guide!

Squash Blocks Required
Under The Ends Of All LVL
And Point Loads For Load
Transfer - See Details

Second Floor Layout

Revisions: BY:

SALES PRESENTATION DRAWING
No structural or dimensional check has been made of this design drawing of the building, therefore, purchaser is to check all applicable dimensions, quantities, loads, and details carefully. This drawing has not been checked by Boise Engineering.

KB Homes
2939 Highland Grove Elev.B
41 Highland Grove
84 Lumber EWP

BC FRAMER II
Plan Date: 07252019
Structural Date: 10072020
By: GAT
Sheet: 2/4

THIS LAYOUT IS INTENDED FOR THE PURPOSE OF TRUSS LOCATION AND PLACEMENT ONLY. REFER TO THE BUILDING PLANS FOR ACTUAL BUILDING CONSTRUCTION.

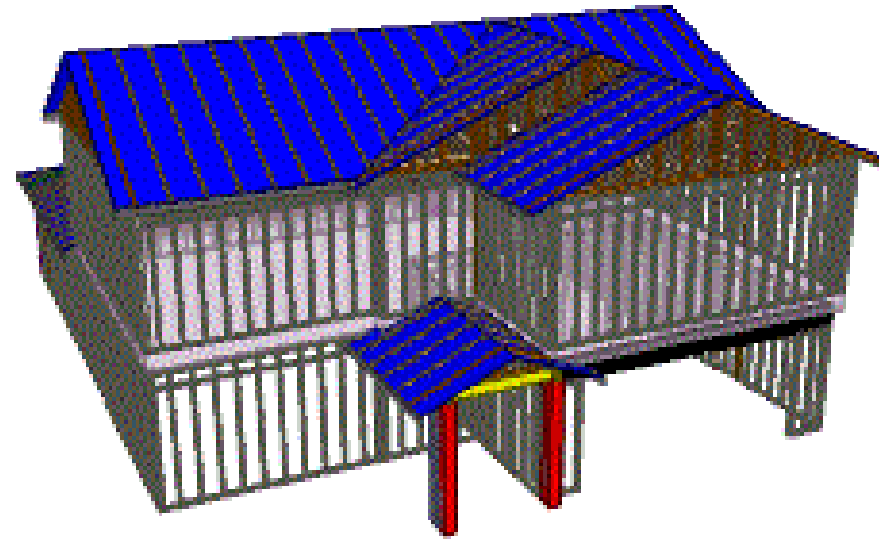
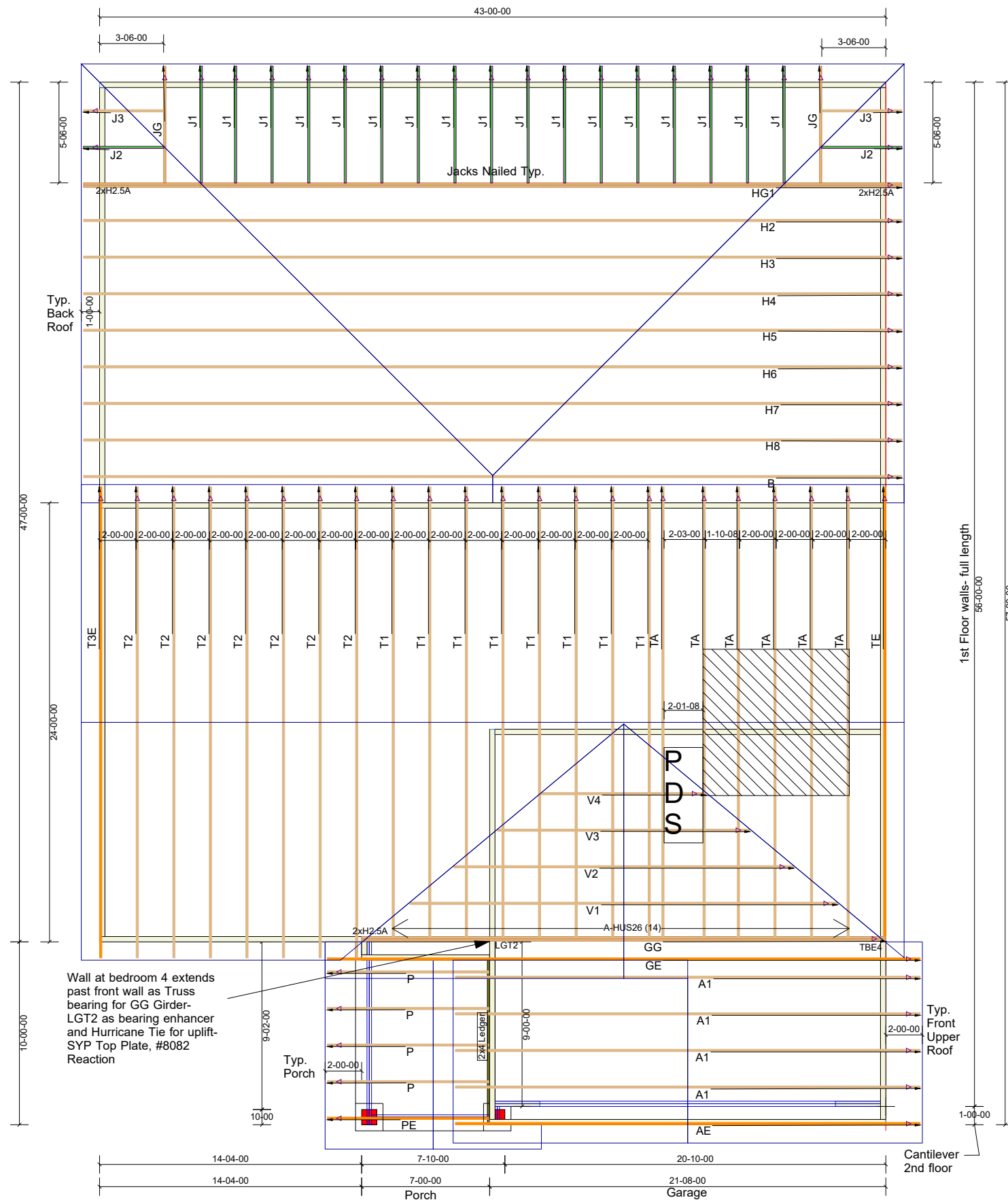

DEDICATED TO QUALITY AND EXCELLENCE
 200 EMMETT ROAD
 DUNN, NORTH CAROLINA 28334
 PHONE: 910-892-8400
 FAX: 910-892-8384

PROJECT:	Lot 41 Highland Grove		
CUSTOMER:	KB HOME		
MODEL:	243.2939 "B" GOR		
SCALE:	NOT TO SCALE	PO #	ORDER: 26042A
DRAWN BY:	MWM	REV:	SHIP DATE: #####
	PRINT DATE:	XXXX	
	2/19/21		

TOP LIVE: 20 PSF
TOP DEAD: 10 PSF
BOTM DEAD: 10 PSF
WIND SPD: 120 MPH

Symbol	Manuf	Product	Qty
A	Simpson	HUS26	14
.	.	.	.
.	Simpson	H2.5A- info	100
TBE4	Simpson	TBE4	1 set
LGT2	Simpson	LGT2	1

LGT2 used as Bearing enhancer and H-Tie

GENERAL NOTES:
 DO NOT CUT OR MODIFY TRUSSES.
 TRUSSES ARE SPACED 24" ON CENTER UNLESS NOTED OTHERWISE.
 REFER TO THE INDIVIDUAL TRUSS DESIGN DRAWINGS FOR THE LOCATION OF LATERAL BRACING AND MULTI-PLY CONNECTION REQUIREMENTS.
 PER ANSI TPI 1-2002 THE TRUSS ENGINEER IS RESPONSIBLE FOR TRUSS TO TRUSS CONNECTIONS AND TRUSS PLY TO PLY CONNECTIONS. THIS TRUSS PLACEMENT PLAN RECOMMENDS TRUSS TO BEARING CONNECTIONS AND TRUSS TO BEAM CONNECTIONS WHICH SHALL BE REVIEWED BY THE BUILDING DESIGNER. IT IS THE RESPONSIBILITY OF THE BUILDING DESIGNER TO RESOLVE ALL ROOF FORCES ADEQUATELY TO THE FOUNDATION.

STRUCTURAL PLANS FOR:



243.2939 - RH GARAGE



PLAN RELEASE / REVISIONS

REV DATE	ARCH PLAN VERSION	REVISION DESCRIPTION	DRFT
02/19/2021	243-2939-01350 RH D6 - 2.18.21	INITIAL SETUP OF LAYOUT	ABS
02/19/2021	243-2939-01350 RH D6 - 2.18.21	CREATED LOT-SPECIFIC STRUCTURAL LAYOUT FROM MASTER PLAN AND EWP LAYOUT	ABS

NOTES

1. ENGINEER'S SEAL APPLIES TO STRUCTURAL COMPONENTS ONLY. ENGINEER'S SEAL DOES NOT CERTIFY DIMENSIONAL ACCURACY OR ARCHITECTURAL LAYOUT, INCLUDING ROOF GEOMETRY. JDSfaulkner, PLLC ASSUMES NO LIABILITY FOR CHANGES MADE TO THESE PLANS BY OTHERS, OR FOR CONSTRUCTION METHODS, OR FOR ANY DEVIATION FROM THE PLANS. ENGINEER TO BE NOTIFIED PRIOR TO CONSTRUCTION IF ANY DISCREPANCIES ARE NOTED ON THE PLANS.
2. DIMENSIONS SHALL GOVERN OVER SCALE, AND CODE SHALL GOVERN OVER DIMENSIONS.
3. PLANS MUST HAVE SIGNED SEAL TO BE VALID AND ARE LIMITED TO THE FOLLOWING USES:
 - A. IF THESE PLANS ARE ISSUED AS A MASTER-PLAN SET, THE SET IS VALID FOR 18 MONTHS FROM THE DATE ON THE SEAL, UNLESS ANY CODE-REQUIRED UPDATES ARE PLACED IN EFFECT BY THE MUNICIPALITY.
 - B. IF THESE PLANS ARE NOT ISSUED AS A MASTER-PLAN SET, THE SET IS VALID FOR A CONDITIONAL, ONE-TIME USE FOR THE LOT OR ADDRESS SPECIFIED ON THE TITLE BLOCK.

CODE

ALL CONSTRUCTION, WORKMANSHIP, AND MATERIAL QUALITY AND SELECTION SHALL BE PER:

**2018
NORTH CAROLINA
STATE BUILDING CODE:
RESIDENTIAL CODE**

ENGINEER OF RECORD

JDSfaulkner, PLLC
ENGINEERING, BUILDING DESIGN, & CONSTRUCTION
CONSULTING SERVICES
8600 'D' JERSEY COURT
RALEIGH, NC 27617
FIRM LIC. NO: P-0961
PROJECT REFERENCE: 21900377

KB HOME
 NORTH CAROLINA DIVISION
 4518 S. MIAMI BLVD.
 SUITE 180
 DURHAM, NC 27703
 TEL: (919) 768-7988
 FAX: (919) 472-0582

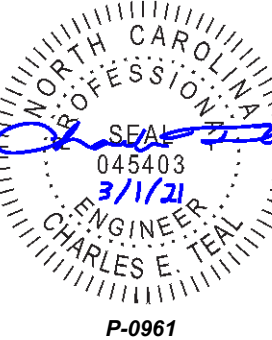

JDSfaulkner, PLLC HAS PERFORMED A STRUCTURAL REVIEW OF THESE PLANS. THE STRUCTURAL COMPONENTS COMPLY WITH THE 2018 NORTH CAROLINA RESIDENTIAL CODE FOR ONE- AND TWO-FAMILY DWELLINGS FOR NC PLAN REVIEW. DEVIATION OF ANY STRUCTURAL REQUIREMENTS OF THESE PLANS WITHOUT THE APPROVAL OF THE EOR IS PROHIBITED.



PROJECT NO.: 21900377
 DATE: 03/01/2021

PLAN:
243.2939

TITLE SHEET
T

These designs and drawings are CONFIDENTIAL, and the exclusive property of KB Home Corporation and are not to be disclosed without the express permission of KB Home Corporation. They may not be used or duplicated without the express permission of KB Home Corporation. Copyright 2019 © KB Home Corporation, all rights reserved.

NOTE: ALL CHAPTERS, SECTIONS, TABLES, AND FIGURES CITED WITHOUT A PUBLICATION TITLE ARE FROM THE APPLICABLE RESIDENTIAL CODE (SEE TITLE SHEET).

GENERAL

1. IT IS THE CONTRACTOR'S RESPONSIBILITY TO VERIFY ALL DIMENSIONS PRIOR TO CONSTRUCTION. FURTHERMORE, CONTRACTOR IS ULTIMATELY RESPONSIBLE FOR CONSTRUCTION MEANS, METHODS, AND SAFETY ON SITE. NOTIFY JDSfaulkner, PLLC IMMEDIATELY IF DISCREPANCIES ON PLAN EXIST.

2. BRACED-WALL DESIGN IS BASED ON SECTION R602.10 - WALL BRACING. PRIMARY PRESCRIPTIVE METHOD TO BE CS-WSP. SEE WALL BRACING PLANS AND DETAILS FOR ADDITIONAL INFORMATION.

ALL NON-PRESCRIPTIVE SOLUTIONS ARE BASED ON GUIDELINES ESTABLISHED IN THE AMERICAN SOCIETY OF CIVIL ENGINEERS PUBLICATION ASCE 7 AND THE NATIONAL DESIGN SPECIFICATION FOR WOOD CONSTRUCTION - SPECIAL DESIGN PROVISIONS FOR WIND AND SEISMIC.

3. SEISMIC DESIGN SHALL BE PER SECTION R301.2.2 - SEISMIC PROVISIONS, INCLUDING ASSOCIATED TABLES AND FIGURES, BASED ON LOCAL SEISMIC DESIGN CATEGORY.

DESIGN LOADS

ASSUMED SOIL BEARING-CAPACITY 2,000 PSF

	LIVE LOAD
ULTIMATE DESIGN WIND SPEED	115 MPH, EXPOSURE B
GROUND SNOW	15 PSF
ROOF	20 PSF

RESIDENTIAL CODE TABLE R301.5	LIVE LOAD (PSF)
DWELLING UNITS	40
SLEEPING ROOMS	30
ATTICS WITH STORAGE	20
ATTICS WITHOUT STORAGE	10
STAIRS	40
DECKS	40
EXTERIOR BALCONIES	60
PASSENGER VEHICLE GARAGES	50
FIRE ESCAPES	40
GUARDS AND HANDRAILS	200 (pounds, concentrated)

COMPONENT AND CLADDING LOADS, INCLUDING THOSE FOR DOORS AND WINDOWS, SHALL BE DERIVED FROM TABLES R301.2(2) AND R301.2(3) FOR A BUILDING WITH A MEAN ROOF HEIGHT OF 35 FEET, LOCATED IN EXPOSURE B.

ABBREVIATIONS

ABV	ABOVE	KS	KING STUD COLUMN
AFF	ABOVE FINISHED FLOOR	LVL	LAMINATED VENEER LUMBER
ALT	ALTERNATE	MAX	MAXIMUM
BRG	BEARING	MECH	MECHANICAL
BSMT	BASEMENT	MFR	MANUFACTURER
CANT	CANTILEVER	MIN	MINIMUM
CJ	CEILING JOIST	NTS	NOT TO SCALE
CLG	CEILING	OA	OVERALL
CMU	CONCRETE MASONRY UNIT	OC	ON CENTER
CO	CASED OPENING	PT	PRESSURE TREATED
COL	COLUMN	R	RISER
CONC	CONCRETE	REF	REFRIGERATOR
CONT	CONTINUOUS	RFG	ROOFING
D	CLOTHES DRYER	RO	ROUGH OPENING
DBL	DOUBLE	RS	ROOF SUPPORT
DIAM	DIAMETER	SC	STUD COLUMN
DJ	DOUBLE JOIST	SF	SQUARE FOOT (FEET)
DN	DOWN	SH	SHELF / SHELVES
DP	DEEP	SHTG	SHEATHING
DR	DOUBLE RAFTER	SHW	SHOWER
DSP	DOUBLE STUD POCKET	SIM	SIMILAR
EA	EACH	SJ	SINGLE JOIST
EE	EACH END	SP	STUD POCKET
EQ	EQUAL	SPEC'D	SPECIFIED
EX	EXTERIOR	SQ	SQUARE
FAU	FORCED-AIR UNIT	T	TREAD
FDN	FOUNDATION	TEMP	TEMPERED GLASS
FF	FINISHED FLOOR	THK	THICK(NESS)
FLR	FLOOR(ING)	TJ	TRIPLE JOIST
FP	FIREPLACE	TOC	TOP OF CURB / CONCRETE
FTG	FOOTING	TR	TRIPLE RAFTER
HB	HOSE BIBB	TYP	TYPICAL
HDR	HEADER	UNO	UNLESS NOTED OTHERWISE
HGR	HANGER	W	CLOTHES WASHER
JS	JACK STUD COLUMN	WH	WATER HEATER
		WWF	WELDED WIRE FABRIC
		XJ	EXTRA JOIST

MATERIALS

1. INTERIOR / TRIMMED FRAMING LUMBER SHALL BE #2 SPRUCE PINE FIR (SPF) WITH THE FOLLOWING DESIGN PROPERTIES (#2 SOUTHERN YELLOW PINE MAY BE SUBSTITUTED):

Fb = 875 PSI Fv = 70 PSI E = 1.4E6 PSI

2. FRAMING LUMBER EXPOSED TO WEATHER OR IN CONTACT WITH THE GROUND, CONCRETE, OR MASONRY SHALL BE PRESSURE TREATED #2 SOUTHERN YELLOW PINE (SYP) WITH THE FOLLOWING DESIGN PROPERTIES:

Fb = 975 PSI Fv = 95 PSI E = 1.6E6 PSI

3. LVL STRUCTURAL MEMBERS TO BE LAMINATED VENEER LUMBER WITH THE FOLLOWING MINIMUM DESIGN PROPERTIES:

Fb = 2600 PSI Fv = 285 PSI E = 1.9E6 PSI

4. PSL STRUCTURAL MEMBERS TO BE PARALLEL STRAND LUMBER WITH THE FOLLOWING MINIMUM DESIGN PROPERTIES:

Fb = 2900 PSI Fv = 290 PSI E = 2.0E6 PSI

5. LSL STRUCTURAL MEMBERS TO BE LAMINATED STRAND LUMBER WITH THE FOLLOWING MINIMUM DESIGN PROPERTIES:

Fb = 2250 PSI Fv = 400 PSI E = 1.55E6 PSI

6. STRUCTURAL STEEL WIDE-FLANGE BEAMS SHALL CONFORM TO ASTM A992. Fy = 50 KSI

7. REBAR SHALL BE DEFORMED STEEL CONFORMING TO ASTM A615, GRADE 60.

8. POURED CONCRETE COMPRESSIVE STRENGTH TO BE A MINIMUM 3,000 PSI AT 28 DAYS. MATERIALS USED TO PRODUCE CONCRETE SHALL COMPLY WITH THE APPLICABLE STANDARDS LISTED IN AMERICAN CONCRETE INSTITUTE STANDARD ACI 318 OR ASTM C1157.

9. CONCRETE SUBJECT TO MODERATE OR SEVERE WEATHERING PROBABILITY PER TABLE R301.2(1) SHALL BE AIR-ENTRAINED WHEN REQUIRED BY TABLE R402.2.

10. CONCRETE MASONRY UNITS (CMU) SHALL CONFORM TO AMERICAN CONCRETE INSTITUTE PUBLICATION 530: BUILDING CODE REQUIREMENTS AND SPECIFICATIONS FOR MASONRY STRUCTURES AND COMPANION COMMENTARIES AND THE MASONRY SOCIETY PUBLICATION TMS 402/602: BUILDING CODE REQUIREMENTS AND SPECIFICATIONS FOR MASONRY STRUCTURES.

11. MORTAR SHALL COMPLY WITH ASTM INTERNATIONAL STANDARD C270.

12. INDICATED MODEL NUMBERS FOR ALL METAL HANGERS, STRAPS, FRAMING CONNECTORS, AND HOLD-DOWNS ARE SIMPSON STRONG-TIE BRAND. EQUIVALENT USP BRAND PRODUCTS ARE ACCEPTABLE.

13. REFER TO I-JOIST EQUIVALENCE CHART ON I-JOIST DETAIL SHEET FOR SUBSTITUTION OF MANUFACTURER SERIES.

FOUNDATION

1. MINIMUM ALLOWABLE SOIL BEARING CAPACITY IS ASSUMED TO BE 2,000 PSF. IT IS THE CONTRACTOR'S RESPONSIBILITY TO VERIFY SOIL BEARING CAPACITY IF UNSATISFACTORY CONDITIONS EXIST.

2. CONCRETE FOUNDATION WALLS TO BE SELECTED AND CONSTRUCTED PER SECTION R404 OR AMERICAN CONCRETE INSTITUTE STANDARD ACI 318.

3. MASONRY FOUNDATION WALLS TO BE SELECTED AND CONSTRUCTED PER SECTION R404 AND/OR AMERICAN CONCRETE INSTITUTE PUBLICATION 530: BUILDING CODE REQUIREMENTS AND SPECIFICATIONS FOR MASONRY STRUCTURES AND COMPANION COMMENTARIES AND/OR THE MASONRY SOCIETY PUBLICATION TMS 402/602: BUILDING CODE REQUIREMENTS AND SPECIFICATIONS FOR MASONRY STRUCTURES.

4. CONCRETE WALL HORIZONTAL REINFORCEMENT TO BE PER TABLE R404.1.2(1) OR AS NOTED OR DETAILED. CONCRETE WALL VERTICAL REINFORCEMENT TO BE PER TABLES R404.1.2(3 AND 4) OR AS NOTED OR DETAILED. ALL CONCRETE WALLS SHALL COMPLY WITH APPLICABLE PROVISIONS OF CHAPTER 6.

- A. TABLES ASSUME THAT WALLS HAVE PERMANENT LATERAL SUPPORT AT THE TOP AND BOTTOM.
- B. FOUNDATION DRAINS ARE ASSUMED AT ALL WALLS PER SECTION R405.

5. PLAIN-MASONRY WALL DESIGN TO BE PER TABLE R404.1.1(1) OR AS NOTED OR DETAILED. MASONRY WALLS WITH VERTICAL REINFORCEMENT TO BE PER TABLES R404.1.1 (2 THROUGH 4) OR AS NOTED OR DETAILED. ALL MASONRY WALLS SHALL COMPLY WITH APPLICABLE PROVISIONS OF CHAPTER 6.

- A. TABLES ASSUME THAT WALLS HAVE PERMANENT LATERAL SUPPORT AT THE TOP AND BOTTOM.
- B. WALL REINFORCING SHALL BE PLACED ACCORDING TO FOOTNOTE (c) OF THE TABLES (REINFORCING IS NOT CENTERED IN WALL).
- C. FOUNDATION DRAINS ARE ASSUMED AT ALL WALLS PER SECTION R405.

6. WOOD SILL PLATES TO BE ANCHORED TO THE FOUNDATION WITH 1/2" DIAMETER ANCHOR BOLTS WITH MINIMUM 7" EMBEDMENT, SPACED A MAXIMUM OF 6'-0" OC AND WITHIN 12" FROM THE ENDS OF EACH PLATE SECTION. INSTALL MINIMUM (2) ANCHOR BOLTS PER SECTION. SEE SECTION R403.1.6 FOR SPECIFIC CONDITIONS.

7. THE UNSUPPORTED HEIGHT OF SOLID MASONRY PIERS SHALL NOT EXCEED TEN TIMES THEIR LEAST DIMENSION. UNFILLED, HOLLOW PIERS MAY BE USED IF THE UNSUPPORTED HEIGHT IS NOT MORE THAN FOUR TIMES THEIR LEAST DIMENSION.

8. CENTERS OF PIERS TO BEAR IN THE MIDDLE THIRD OF THE FOOTINGS, AND GIRDERS SHALL CENTER IN THE MIDDLE THIRD OF THE PIERS.

9. ALL FOOTINGS TO HAVE MINIMUM 2" PROJECTION ON EACH SIDE OF FOUNDATION WALLS (SEE DETAILS).

10. ALL REBAR NOTED IN CONCRETE TO HAVE AT LEAST 2" COVER FROM EDGE OF CONCRETE TO EDGE OF REBAR.

11. FRAMING TO BE FLUSH WITH FOUNDATION WALLS.

12. WITH CLASS 1 SOILS, VAPOR BARRIER AND CRUSHED STONE MAY BE OMITTED.

FRAMING

1. ALL BEARING HEADERS TO BE (2) 2x6 SUPPORTED W/ MIN (1) JACK STUD AND (1) KING STUD EACH END, UNO.

2. ALL NON-BEARING HEADERS TO BE (2) 2x4, UNO.

3. NON-BEARING INTERIOR WALLS NOT MORE THAN 10' NOMINAL HEIGHT AND NOT SHOWN AS BRACED WALLS MAY BE FRAMED WITH 2x4 STUDS @ 24" OC.

4. SOLID BLOCKING TO BE PROVIDED AT ALL POINT LOADS THROUGH FLOOR LEVELS TO THE FOUNDATION OR TO OTHER STRUCTURAL COMPONENTS.

5. ALL BEAMS SPECIFIED ARE MINIMUM SIZES ONLY. LARGER MEMBERS MAY SUBSTITUTED AS NEEDED FOR EASE OF CONSTRUCTION.

6. ALL EXTERIOR WALLS TO BE FULLY SHEATHED WITH 7/16" OSB.

7. PORCH / PATIO COLUMNS TO BE 4x4 MINIMUM PRESSURE-TREATED LUMBER.

- A. ATTACH PORCH COLUMNS TO SLAB / FDN WALL USING ABA, ABU, ABW, OR CPT SIMPSON POST BASES TO FIT COLUMN SIZES NOTED ON PLAN -OR- ANY OTHER COLUMN CONNECTION WITH 500# UPLIFT CAPACITY.
- B. ATTACH PORCH COLUMNS TO PORCH BEAMS USING AC OR BC SIMPSON POST CAPS TO FIT COLUMN SIZES NOTED ON PLAN -OR- ANY OTHER COLUMN CONNECTION WITH 500# UPLIFT CAPACITY.
- C. TRIM OUT COLUMN(S) AND BEAM(S) PER BUILDER AND DETAILS.

8. ALL ENGINEERED WOOD PRODUCTS (LVL, PSL, LSL, ETC.) SHALL BE INSTALLED WITH CONNECTIONS PER MANUFACTURER SPECIFICATIONS.

9. ENGINEERED WOOD FLOOR SYSTEMS AND ROOF TRUSS SYSTEMS:

- A. SHOP DRAWINGS FOR THE SYSTEMS SHALL BE PROVIDED TO THE ENGINEER OF RECORD FOR REVIEW AND COORDINATION BEFORE CONSTRUCTION.
- B. TRUSS PROFILES SHALL BE SEALED BY THE TRUSS MANUFACTURER.
- C. INSTALLATION OF THE SYSTEMS SHALL BE PER MANUFACTURER'S INSTRUCTIONS.
- D. TRUSS LAYOUT AND PLACEMENT BY MANUFACTURER TO COINCIDE WITH THE SUPPORT LOCATIONS SHOWN IN THESE DRAWINGS.

10. ALL BEAMS TO BE CONTINUOUSLY SUPPORTED Laterally AND SHALL BEAR FULL WIDTH ON THE SUPPORTING WALLS OR COLUMNS INDICATED, WITH A MINIMUM OF THREE STUDS, UNO.

11. ALL STEEL BEAMS TO BE SUPPORTED AT EACH END WITH A MIN BEARING LENGTH OF 3 1/2" AND FULL FLANGE WIDTH. BEAMS MUST BE ATTACHED AT EACH END WITH A MINIMUM OF FOUR 16d NAILS OR TWO 1/2" x 4" LAG SCREWS, UNO.

12. STEEL FLITCH BEAMS TO BE BOLTED TOGETHER USING (2) ROWS OF 1/2" DIAMETER BOLTS (ASTM 307) WITH WASHERS PLACED UNDER THE THREADED END OF THE BOLT. BOLTS TO BE SPACED AT 24" OC (MAX) AND STAGGERED TOP AND BOTTOM OF BEAM (2" EDGE DISTANCE), WITH TWO BOLTS TO BE LOCATED AT 6" FROM EACH END OF FLITCH BEAM.

13. WHEN A 4-PLY LVL BEAM IS USED, ATTACH WITH (1) 1/2" DIAMETER BOLT, 12" OC, STAGGERED TOP AND BOTTOM, 1 1/2" MIN FROM ENDS. ALTERNATE EQUIVALENT ATTACHMENT METHOD MAY BE USED, SUCH AS SDS, SDW, OR TRUSSLOK SCREWS (SEE MANUFACTURER SPECIFICATIONS).

14. FOR STUD COLUMNS OF 4-OR-MORE STUDS, INSTALL SIMPSON STRONG-TIE CS16 STRAPS ACROSS STUDS @ 30" OC, 6" MAX FROM PLATES, ON INSIDE FACE OF COLUMN (EXTERIOR WALL), ON BOTH FACES OF COLUMN (INTERIOR WALL).

15. FLOOR JOISTS ADJACENT AND PARALLEL TO THE EXTERIOR FOUNDATION WALL SHALL BE PROVIDED WITH FULL-DEPTH SOLID BLOCKING, NOT LESS THAN TWO (2) INCHES NOMINAL IN THICKNESS, PLACED PERPENDICULAR TO THE JOIST AT SPACING NOT MORE THAN FOUR (4) FEET. THE BLOCKING SHALL BE NAILED TO THE FLOOR SHEATHING, THE SILL PLATE, THE JOIST, AND THE EXTERIOR RIM JOIST / BOARD.

16. BRACED WALL PANELS SHALL BE FASTENED TO MEET THE UPLIFT-RESISTANCE REQUIREMENTS IN CHAPTERS 6 AND 8 OF THE APPLICABLE CODE (SEE TITLE SHEET). REQUIREMENTS OF THE STRUCTURAL DRAWINGS THAT EXCEED THE CODE MINIMUM SHALL BE MET.



KB HOME
NORTH CAROLINA DIVISION
4518 S. MIAMI BLVD.
SUITE 180
DURHAM, NC 27703
TEL: (919) 768-7988
FAX: (919) 472-0582

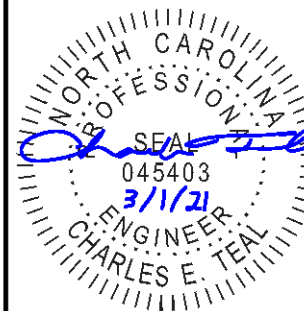

P-0961

JDSfaulkner, PLLC HAS PERFORMED A STRUCTURAL REVIEW OF THESE PLANS. THE STRUCTURAL COMPONENTS COMPLY WITH THE 2018 NORTH CAROLINA RESIDENTIAL CODE FOR ONE- AND TWO-FAMILY DWELLINGS FOR NC PLAN REVIEW. DEVIATION OF ANY STRUCTURAL REQUIREMENTS OF THESE PLANS WITHOUT THE APPROVAL OF THE EOR IS PROHIBITED.



8800 D JERSEY CT, RALEIGH, NC 27617-9194, 1075
INFO@JDSFAULKNER.COM | WWW.JDSFAULKNER.COM

PROJECT NO.: 21900377

DATE: 03/01/2021

PLAN:
243.2939

GENERAL NOTES

GN1.0

These designs and drawings are CONFIDENTIAL and the exclusive property of KB Home Corporation and are not to be disclosed without the express permission of KB Home Corporation. They may not be used or duplicated without the express permission of KB Home Corporation. Copyright 2019 © KB Home Corporation. All rights reserved.

FASTENER SCHEDULE		
CONNECTION	3" x 0.131" NAIL	3" x 0.120" NAIL
JOIST TO SILL PLATE	(4) TOE NAILS	(4) TOE NAILS
SOLE PLATE TO JOIST / BLOCKING	NAILS @ 8" OC (typical) (4) PER 16" SPACE (at braced panels)	NAILS @ 8" OC (typical) (4) PER 16" SPACE (at braced panels)
STUD TO SOLE PLATE	(4) TOE NAILS	(4) TOE NAILS
TOP OR SOLE PLATE TO STUD	(3) FACE NAILS	(4) FACE NAILS
RIM JOIST OR BAND JOIST TO TOP PLATE OR SILL PLATE	TOE NAILS @ 6" OC	TOE NAILS @ 4" OC
BLOCKING BETWEEN JOISTS TO TOP PLATE OR SILL PLATE	(4) TOE NAILS	(4) TOE NAILS
DOUBLE STUD	NAILS @ 8" OC	NAILS @ 8" OC
DOUBLE TOP PLATES	NAILS @ 12" OC	NAILS @ 12" OC
DOUBLE TOP PLATES LAP (24" MIN LAP LENGTH)	(12) NAILS IN LAPPED AREA, EA SIDE OF JOINT	(12) NAILS IN LAPPED AREA, EA SIDE OF JOINT
TOP PLATE LAP AT CORNERS AND INTERSECTING WALLS	(3) FACE NAILS	(3) FACE NAILS
OPEN-WEB TRUSS BOTTOM CHORD TO TOP PLATES OR SILL PLATE (PARALLEL TO WALL)	NAILS @ 6" OC	NAILS @ 4" OC
BOTTOM CHORD OF TRUSS TO TOP PLATES OR SILL PLATE (PERPENDICULAR TO WALL)	(3) TOE NAILS	(3) TOE NAILS

SEE TABLE R602.3(1) FOR ADDITIONAL STRUCTURAL-MEMBER FASTENING REQUIREMENTS.

DETAILS AND NOTES ON DRAWINGS GOVERN.

BALLOON WALL FRAMING SCHEDULE
(USE THESE STANDARDS UNLESS NOTED OTHERWISE ON THE FRAMING PLAN SHEETS)

FRAMING MEMBER SIZE	MAX HEIGHT (PLATE TO PLATE) 115 MPH ULTIMATE DESIGN WIND SPEED
2x4 @ 16" OC	10'-0"
2x4 @ 12" OC	12'-0"
2x6 @ 16" OC	15'-0"
2x6 @ 12" OC	17'-9"
2x8 @ 16" OC	19'-0"
2x8 @ 12" OC	22'-0"
(2) 2x4 @ 16" OC	14'-6"
(2) 2x4 @ 12" OC	17'-0"
(2) 2x6 @ 16" OC	21'-6"
(2) 2x6 @ 12" OC	25'-0"
(2) 2x8 @ 16" OC	27'-0"
(2) 2x8 @ 12" OC	31'-0"

- ALL HEIGHTS ARE MEASURED SUBFLOOR TO TOP OF WALL PLATE.
- WHEN SPLIT-FRAMED WALLS ARE USED FOR HEIGHTS OVER 12', THE CONTRACTOR SHALL ADD 6' MINIMUM OF CS16 COIL STRAPPING (FULLY NAILED), CENTERED OVER THE WALL BREAK.
- FINGER-JOINTED MEMBERS MAY BE USED FOR CONTINUOUS HEIGHTS WHERE TRADITIONALLY MILLED LUMBER LENGTHS ARE LIMITED.
- FOR GREATER WIND SPEED, SEE ENGINEERED SOLUTION FOR CONDITION IN DRAWINGS.

ROOF SYSTEMS

TRUSSED ROOF - STRUCTURAL NOTES

- PROVIDE CONTINUOUS BLOCKING THROUGH STRUCTURE FOR ALL POINT LOADS.
-  DENOTES OVER-FRAMED AREA
- MINIMUM 7/16" OSB ROOF SHEATHING
- TRUSS LAYOUT AND PLACEMENT BY MANUFACTURER TO COINCIDE WITH THE SUPPORT LOCATIONS SHOWN. TRUSS PROFILES SHALL BE SEALED BY THE TRUSS MANUFACTURER. TRUSS PLANS TO BE COORDINATED WITH THE SEALED STRUCTURAL DRAWINGS. INSTALLATION SHALL BE IN ACCORDANCE WITH THE MANUFACTURER'S INSTRUCTIONS.
- MANUFACTURER TO PROVIDE REQUIRED UPLIFT CONNECTION.
- PROVIDE H2.5A (MINIMUM) OR EQUIVALENT AT EACH TRUSS-TO-TOP PLATE CONNECTION AT OVER-FRAMED AREAS, UNLESS NOTED OTHERWISE.
- UPLIFT CONNECTION TO BE CARRIED THROUGH TO FLOOR SYSTEM.

STICK-FRAMED ROOF - STRUCTURAL NOTES

- PROVIDE 2x4 COLLAR TIES AT 48" OC AT UPPER THIRD OF RAFTERS, UNLESS NOTED OTHERWISE.
- FUR RIDGES FOR FULL RAFTER CONTACT.
- PROVIDE CONTINUOUS BLOCKING THROUGH STRUCTURE FOR ALL POINT LOADS.
-  DENOTES OVER-FRAMED AREA
- MINIMUM 7/16" OSB ROOF SHEATHING
- PROVIDE 2x4 RAFTER TIES AT 16" OC AT 45° BETWEEN RAFTERS AND CEILING JOISTS. USE (4) 16d NAILS AT EACH CONNECTION. RAFTER TIES MAY BE SPACED AT 48" OC AT LOCATIONS WHERE NO KNEE WALLS ARE INSTALLED.
- PROVIDE H2.5A (MINIMUM) OR EQUIVALENT AT EACH RAFTER-TO-TOP PLATE CONNECTION AT OVER-FRAMED AREAS, UNLESS NOTED OTHERWISE.
- UPLIFT CONNECTION TO BE CARRIED THROUGH TO FLOOR SYSTEM.

BRICK VENEER LINTEL SCHEDULE		
SPAN	STEEL ANGLE SIZE	END BEARING LENGTH
UP TO 42"	L3-1/2"x3-1/2"x1/4"	8" (MIN. @ EACH END)
UP TO 72"	L6"x4"x5/16" (LLV)	8" (MIN. @ EACH END)
OVER 72"	L6"x4"x5/16" (LLV) ATTACH LINTEL w/ 1/2" THRU BOLT @ 12" OC, 3" FROM EACH END	

* FOR QUEEN BRICK: LINTELS AT THIS CONDITION MAY BE 5"x3-1/2"x5/16"

NOTE: BRICK LINTELS AT SLOPED AREAS TO BE 4"x3-1/2"x1/4" STEEL ANGLE WITH 16D NAILS IN 3/16" HOLES IN 4" ANGLE LEG AT 12" OC TO TRIPLE RAFTER. WHEN THE SLOPE EXCEEDS 4:12 A MINIMUM OF 3"x3"x1/4" PLATES SHALL BE WELDED AT 24" OC ALONG THE STEEL ANGLE.



KB HOME
NORTH CAROLINA DIVISION
4518 S. MIAMI BLVD.
SUITE 180
DURHAM, NC 27703
TEL: (919) 768-7988
FAX: (919) 472-0582

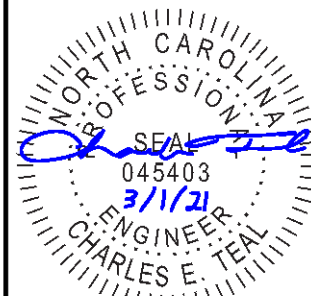

P-0961

JDSfaulkner, PLLC HAS PERFORMED A STRUCTURAL REVIEW OF THESE PLANS. THE STRUCTURAL COMPONENTS COMPLY WITH THE 2018 NORTH CAROLINA RESIDENTIAL CODE FOR ONE- AND TWO-FAMILY DWELLINGS FOR NC PLAN REVIEW. DEVIATION OF ANY STRUCTURAL REQUIREMENTS OF THESE PLANS WITHOUT THE APPROVAL OF THE EOR IS PROHIBITED.



PROJECT NO.: 21900377
DATE: 03/01/2021

PLAN:
243.2939

GENERAL NOTES
GN1.1

These designs and drawings are CONFIDENTIAL, and the enclosure property of KB Home Corporation and are not to be disclosed without the express permission of KB Home Corporation. Copyright 2019 © KB Home Corporation. All rights reserved.

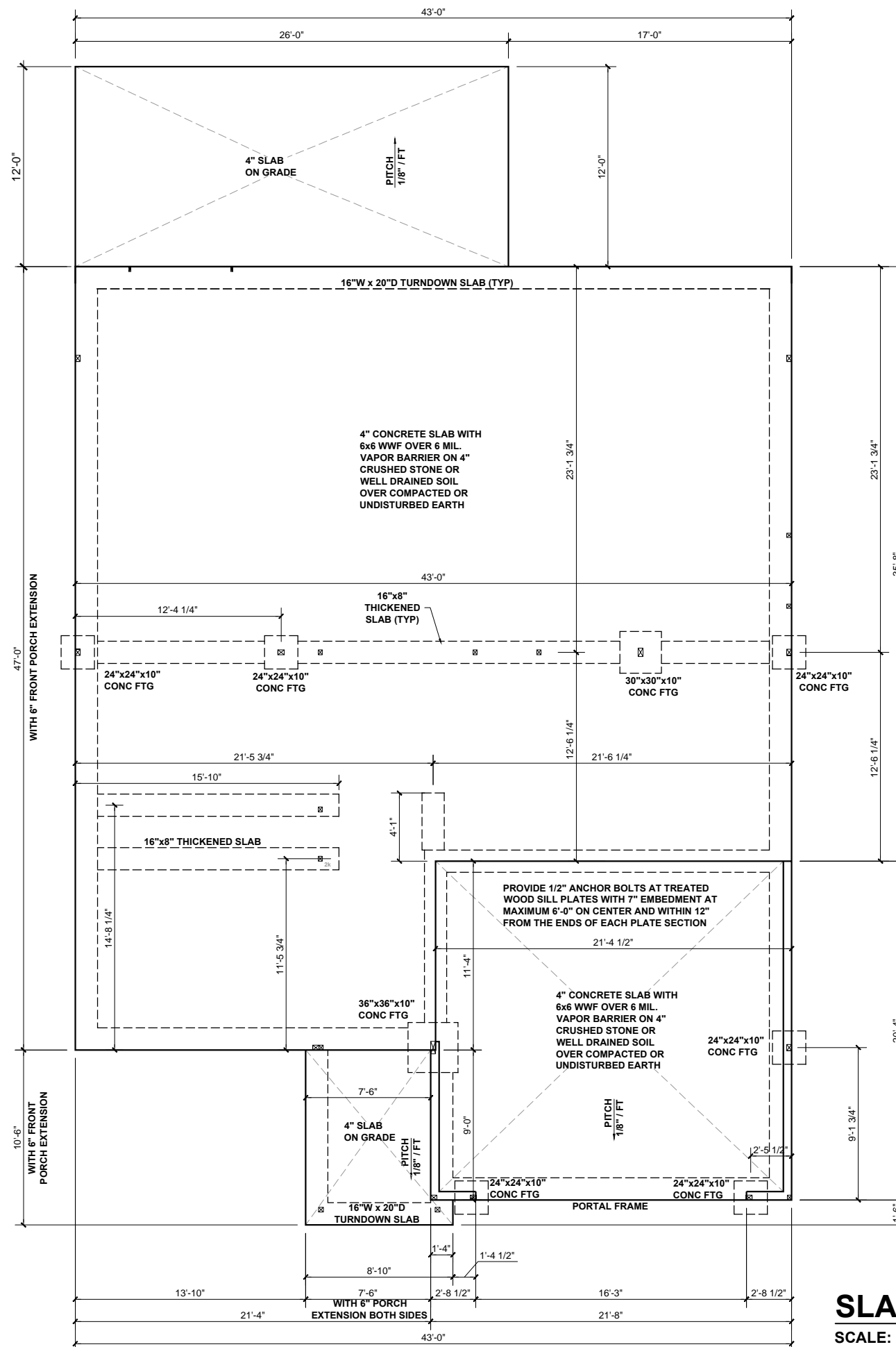

BEAM & POINT LOAD LEGEND	
	INTERIOR LOAD BEARING WALL
	ROOF RAFTER / TRUSS SUPPORT
	DOUBLE RAFTER / DOUBLE JOIST
	STRUCTURAL BEAM / GIRDER
	WINDOW / DOOR HEADER
	POINT LOAD TRANSFER
	POINT LOAD FROM ABOVE BEARING ON BEAM / GIRDER

(1) #5 REBAR @ CENTER OFF ALL PERIMETER AND INTERNAL LOAD BEARING FOOTINGS. (2" C.C. MIN)

ALL CONCRETE CURBS SUPPORTING PORTAL FRAMED OR ENGINEERED OPENINGS IN GARAGES WITH A PONY WALL OVER 24" ABOVE THE GARAGE DOOR HEADER SHALL BE REQUIRED TO BE AT LEAST 8" WIDE.



KB HOME
NORTH CAROLINA DIVISION
4518 S. MIAMI BLVD.
SUITE 180
DURHAM, NC 27703
TEL: (919) 768-7988
FAX: (919) 472-0582

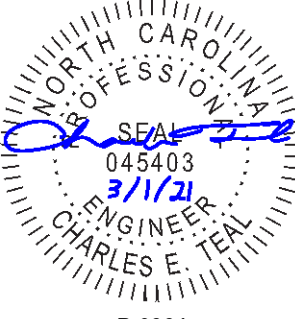

P-0961

JDSfaulkner, PLLC HAS PERFORMED A STRUCTURAL REVIEW OF THESE PLANS. THE STRUCTURAL COMPONENTS COMPLY WITH THE 2018 NORTH CAROLINA RESIDENTIAL CODE FOR ONE- AND TWO-FAMILY DWELLINGS FOR NC PLAN REVIEW. DEVIATION OF ANY STRUCTURAL REQUIREMENTS OF THESE PLANS WITHOUT THE APPROVAL OF THE EOR IS PROHIBITED.



8800 D' JERSEY CT, RALEIGH, NC 27617 919.480.1075
INFO@JDSfaulkner.COM | WWW.JDSfaulkner.COM

PROJECT NO.: 21900377

DATE: 03/01/2021

PLAN:
243.2939

SLAB
FOUNDATION PLAN

S.10B

SLAB FOUNDATION PLAN - 'B'
SCALE: 1/8" = 1'-0"

These designs and drawings are CONFIDENTIAL, and the exclusive property of KB Home Corporation and are not to be disclosed without the express permission of KB Home Corporation. They may not be used or duplicated without the express permission of KB Home Corporation. Copyright 2019 © KB Home Corporation, all rights reserved.

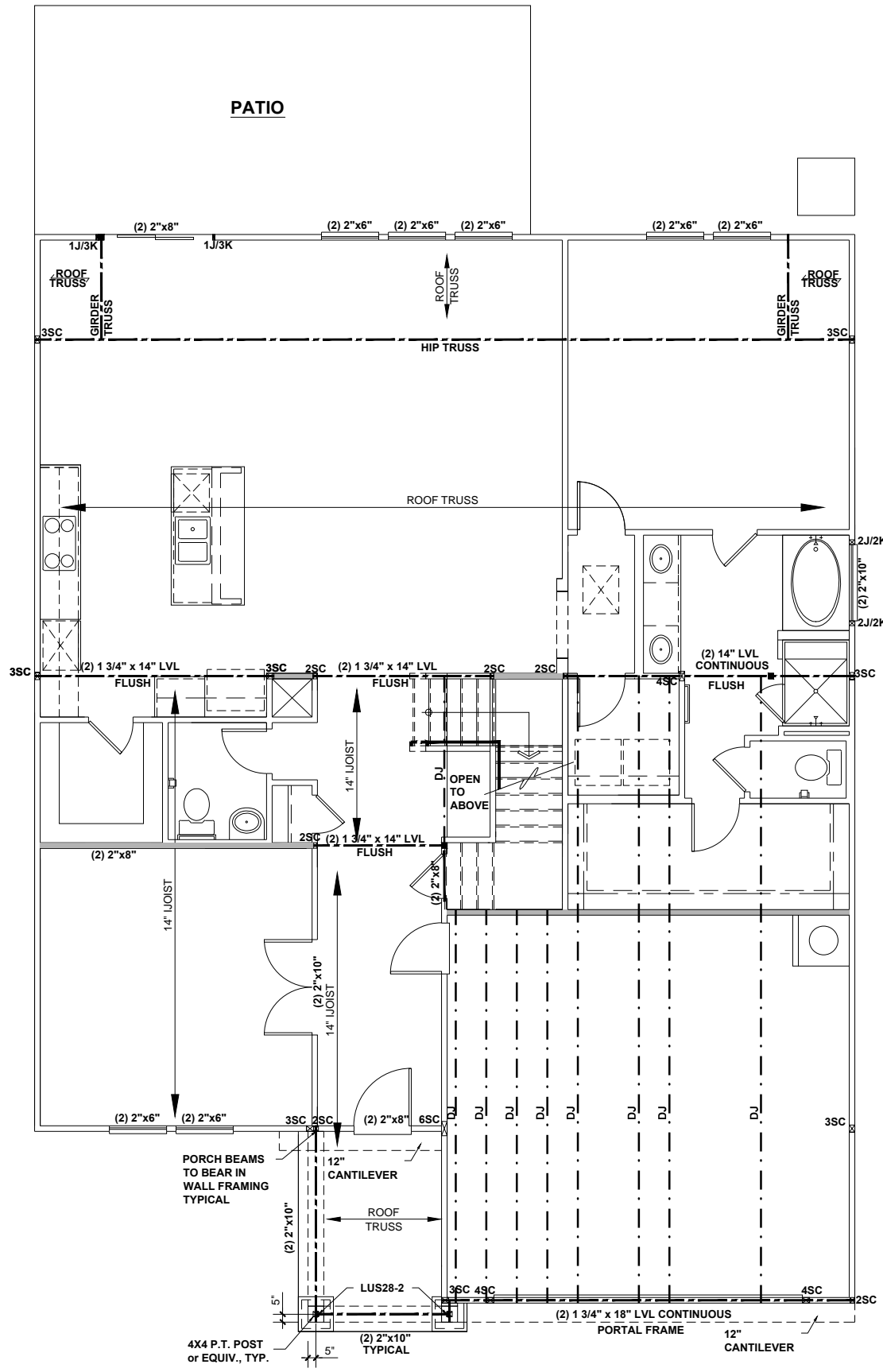

FIRST FLOOR CEILING FRAMING PLAN - 'B'
SCALE: 1/8"=1'-0"

BEAM & POINT LOAD LEGEND

- INTERIOR LOAD BEARING WALL
- - - ROOF RAFTER / TRUSS SUPPORT
- · - · - DOUBLE RAFTER / DOUBLE JOIST
- STRUCTURAL BEAM / GIRDER
- WINDOW / DOOR HEADER
- ⊠ POINT LOAD TRANSFER
- POINT LOAD FROM ABOVE BEARING ON BEAM / GIRDER

- STRUCTURAL FRAMING NOTES - (SEE GENERAL NOTES SHEET FOR ADDITIONAL REQUIREMENTS.)**
- ALL FRAMING TO BE #2 SPF MINIMUM.
 - ALL BEARING HEADERS TO BE (2) 2x6 SUPPORTED w/ MIN (1) JACK AND (1) KING EACH END, UNO.
 - EXTERIOR WALL OPENINGS OVER 3' TO HAVE MULTIPLE KING STUDS AS NOTED ON PLAN.
 - ALL NON-BEARING HEADERS TO BE (2) 2x4 (1) J / (1) K, UNO.
 - PROVIDE CONTINUOUS BLOCKING THROUGH STRUCTURE FOR ALL POINT LOADS.
 - ALL HANGERS AND CONNECTORS SPECIFIED ARE TO BE SIMPSON STRONG-TIE OR EQUIVALENT.
 - ALL BEAMS SPECIFIED ARE MINIMUM SIZES ONLY. LARGER MEMBERS MAY SUBSTITUTED AS NEEDED FOR EASE OF CONSTRUCTION. MINIMUM BEAM SUPPORT IS (1) 2x4 STUD.
 - ALL EXTERIOR WALLS TO BE FULLY SHEATHED WITH 7/16" OSB.
 - FRONT PORCH COLUMNS TO BE MIN 4x4 PT ATTACHED AT TOP AND BOTTOM USING SIMPSON (OR EQUIV) COLUMN BASE OR SST A24 BRACKETS. TRIM OUT PER BUILDER.
 - PORCH COLUMNS TO BE MIN 4x4 PT ATTACHED AT BOTTOM USING SIMPSON (OR EQUIV) ABA44 AND AT TOP USING CS 16 STRAPPING (12" MIN) TO PORCH HEADER / BAND.
 - WHEN A 4-PLY LVL IS USED, ATTACH WITH (1) 1/2" Ø BOLT 12" OC STAGGERED, TOP AND BOTTOM, 1-1/2" MIN FROM ENDS. ALTERNATE ATTACHMENT EQUIVALENT METHOD MAY BE USED, SUCH AS SDW OR TRUSSLOK SCREWS (SEE MANUFACTURER'S SPECIFICATIONS).
 - FOR STUD COLUMNS OF 4 OR MORE, INSTALL SST CS16 STRAPS @ 30" OC, 6" MAX FROM PLATES, ON INSIDE FACE OF COLUMN (EXTERIOR WALL), ON BOTH FACES OF COLUMN (INTERIOR WALL).

I-JOIST SPACING NOT TO EXCEED 19.2" OC IN LOCATIONS WITH TILE FINISH FLOOR

ALL FLUSH BEAMS TO BE DIRECTLY SUPPORTED BY (2) 2X STUDS UNLESS OTHERWISE NOTED. STUD COLUMNS TO BE SUPPORTED BY SOLID BLOCKING TO FOUNDATION OR TO BEARING COMPONENT BELOW.

**REFER TO I-JOIST EQUIVALENCES CHART ON I-JOIST DETAIL SHEET FOR SUBSTITUTION OF MANUFACTURER SERIES

FLOOR FRAMING TO BE 14" DEEP TJI 210 SERIES OR EQUAL, 19.2" OC MAXIMUM SPACING, U.N.O.

ALL HANGERS TO BE LUS26-2 FOR TWO PLY SAWN LUMBER BANDS, JOISTS, HEADERS, AND BEAMS UNLESS OTHERWISE NOTED.



KB HOME
NORTH CAROLINA DIVISION
4518 S. MIAMI BLVD.
SUITE 180
DURHAM, NC 27703
TEL: (919) 768-7988
FAX: (919) 472-0582



P-0961

JDSfaulkner, PLLC HAS PERFORMED A STRUCTURAL REVIEW OF THESE PLANS. THE STRUCTURAL COMPONENTS COMPLY WITH THE 2018 NORTH CAROLINA RESIDENTIAL CODE FOR ONE- AND TWO-FAMILY DWELLINGS FOR NC PLAN REVIEW. DEVIATION OF ANY STRUCTURAL REQUIREMENTS OF THESE PLANS WITHOUT THE APPROVAL OF THE EOR IS PROHIBITED.



PROJECT NO.: 21900377
DATE: 03/01/2021

PLAN:
243.2939

FIRST FLOOR
CEILING FRAMING PLAN

S1.0B

These designs and drawings are CONFIDENTIAL, and the exclusive property of JDSfaulkner, and are not to be disclosed without the express permission of JDSfaulkner. Copyright 2019 © KB Home Corporation, all rights reserved.

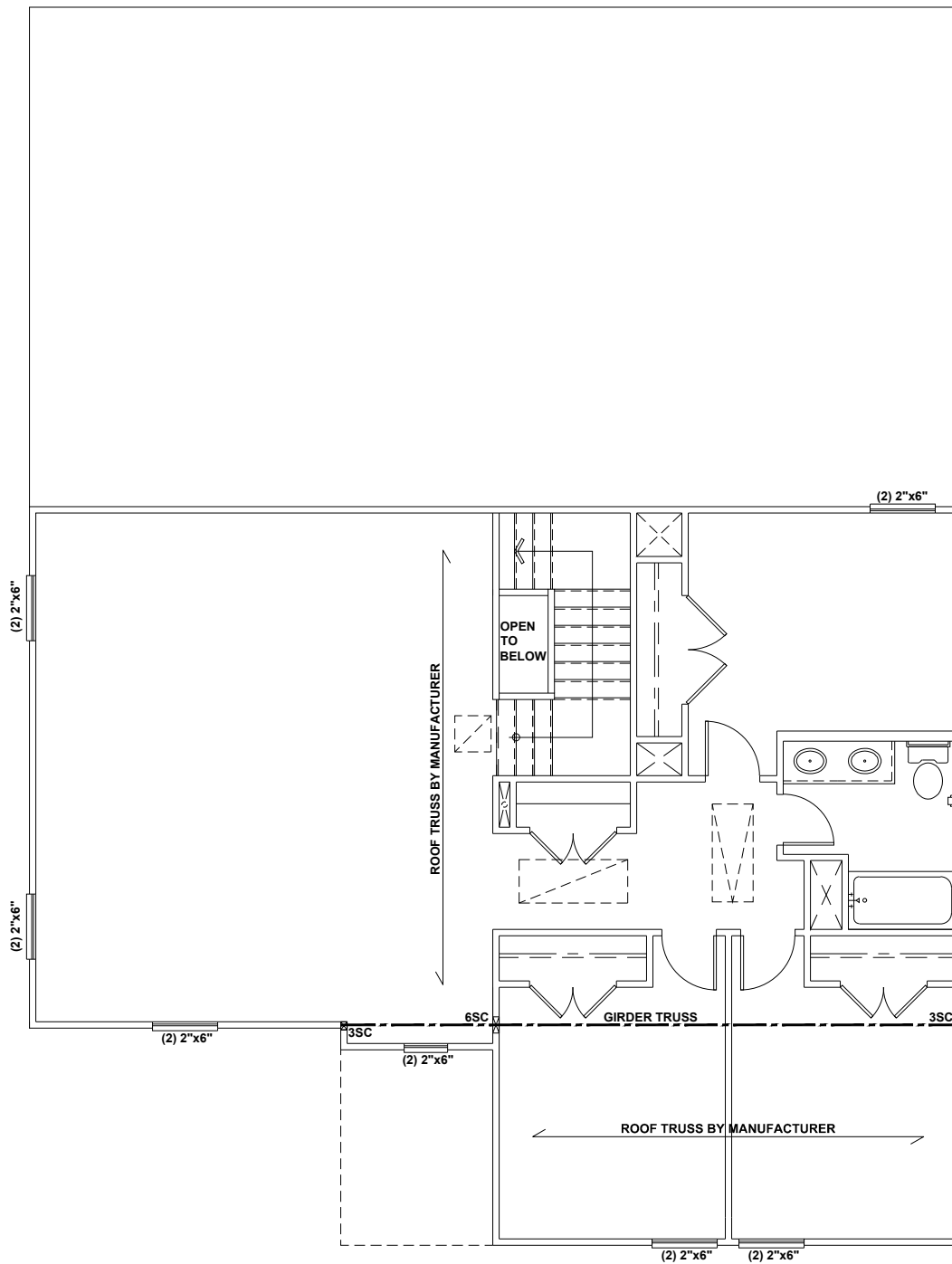

SECOND FLOOR CEILING FRAMING PLAN - 'B'
 SCALE: 1/8" = 1'-0"

BEAM & POINT LOAD LEGEND

	INTERIOR LOAD BEARING WALL
	ROOF RAFTER / TRUSS SUPPORT
	DOUBLE RAFTER / DOUBLE JOIST
	STRUCTURAL BEAM / GIRDER
	WINDOW / DOOR HEADER
	POINT LOAD TRANSFER
	POINT LOAD FROM ABOVE BEARING ON BEAM / GIRDER

- STRUCTURAL FRAMING NOTES - (SEE GENERAL NOTES SHEET FOR ADDITIONAL REQUIREMENTS.)**
- ALL FRAMING TO BE #2 SPF MINIMUM.
 - ALL BEARING HEADERS TO BE (2) 2x6 SUPPORTED w/ MIN (1) JACK AND (1) KING EACH END, UNO.
 - EXTERIOR WALL OPENINGS OVER 3' TO HAVE MULTIPLE KING STUDS AS NOTED ON PLAN.
 - ALL NON-BEARING HEADERS TO BE (2) 2x4 (1) J / (1) K, UNO.
 - PROVIDE CONTINUOUS BLOCKING THROUGH STRUCTURE FOR ALL POINT LOADS.
 - ALL HANGERS AND CONNECTORS SPECIFIED ARE TO BE SIMPSON STRONG-TIE OR EQUIVALENT.
 - ALL BEAMS SPECIFIED ARE MINIMUM SIZES ONLY. LARGER MEMBERS MAY SUBSTITUTED AS NEEDED FOR EASE OF CONSTRUCTION. MINIMUM BEAM SUPPORT IS (1) 2x4 STUD.
 - ALL EXTERIOR WALLS TO BE FULLY SHEATHED WITH 7/16" OSB.
 - FRONT PORCH COLUMNS TO BE MIN 4x4 PT ATTACHED AT TOP AND BOTTOM USING SIMPSON (OR EQUIV) COLUMN BASE OR SST A24 BRACKETS. TRIM OUT PER BUILDER.
 - PORCH COLUMNS TO BE MIN 4x4 PT ATTACHED AT BOTTOM USING SIMPSON (OR EQUIV) ABA44 AND AT TOP USING CS 16 STRAPPING (12" MIN) TO PORCH HEADER / BAND.
 - WHEN A 4-PLY LVL IS USED, ATTACH WITH (1) 1/2" Ø BOLT 12" OC STAGGERED, TOP AND BOTTOM, 1-1/2" MIN FROM ENDS. ALTERNATE ATTACHMENT EQUIVALENT METHOD MAY BE USED, SUCH AS SDW OR TRUSSLOK SCREWS (SEE MANUFACTURER'S SPECIFICATIONS).
 - FOR STUD COLUMNS OF 4 OR MORE, INSTALL SST CS16 STRAPS @ 30" OC, 6" MAX FROM PLATES, ON INSIDE FACE OF COLUMN (EXTERIOR WALL), ON BOTH FACES OF COLUMN (INTERIOR WALL).

ALL FLUSH BEAMS TO BE DIRECTLY SUPPORTED BY (2) 2X STUDS UNLESS OTHERWISE NOTED. STUD COLUMNS TO BE SUPPORTED BY SOLID BLOCKING TO FOUNDATION OR TO BEARING COMPONENT BELOW.



KB HOME
 NORTH CAROLINA DIVISION
 4518 S. MIAMI BLVD.
 SUITE 180
 DURHAM, NC 27703
 TEL: (919) 768-7988
 FAX: (919) 472-0582

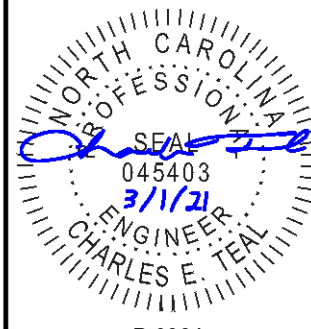

P-0961

JDSfaulkner, PLLC HAS PERFORMED A STRUCTURAL REVIEW OF THESE PLANS. THE STRUCTURAL COMPONENTS COMPLY WITH THE 2018 NORTH CAROLINA RESIDENTIAL CODE FOR ONE- AND TWO-FAMILY DWELLINGS FOR NC PLAN REVIEW. DEVIATION OF ANY STRUCTURAL REQUIREMENTS OF THESE PLANS WITHOUT THE APPROVAL OF THE EOR IS PROHIBITED.



8800 D' JERSEY CT, RALEIGH, NC 27617/919.480.1075
 INFO@JDSFAULKNER.COM | WWW.JDSFAULKNER.COM

PROJECT NO.: 21900377
 DATE: 03/01/2021

PLAN:
243.2939

SECOND FLOOR
 CEILING FRAMING PLAN

S2.0B

These designs and drawings are CONFIDENTIAL, and the exclusive property of KB Home Corporation and are not to be disclosed without the express permission of KB Home Corporation. Copyright 2019 © KB Home Corporation. All rights reserved.



WALL BRACING REQUIREMENTS

- MINIMUM PANEL WIDTH IS 24"
- FIGURES BASED ON THE CONTINUOUS SHEATHING METHOD USING THE RECTANGLE CIRCUMSCRIBED AROUND THE FLOOR PLAN OR PORTION OF THE FLOOR PLAN. IF NO RECTANGLE IS NOTED, THE STRUCTURE HAS BEEN FIGURED ALL WITHIN ONE RECTANGLE.
- PANELS MAY SHIFT UP TO 36" EITHER DIRECTION FOR EASE OF CONSTRUCTION (NAILING & BLOCK REQUIREMENTS STILL APPLY).
- FOR ADDITIONAL WALL BRACING INFORMATION, REFER TO WALL BRACING DETAIL SHEET(S).
- SCHEMATIC BELOW INDICATES HOW SIDES OF RECTANGLE ARE TO BE INTERPRETED IN BRACING CHART WHEN APPLIED TO STRUCTURE:

- ◆ CS16 STRAP FROM STUD, CROSS HEADER, TO WALL TOP PLATE, 36" LONG MINIMUM
- ▶ SIMPSON MSTA15 HOLD DOWN CAPACITY OF 970 POUNDS PER ANCHOR WITH (12) 10d NAILS. STRAP TO BE LOCATED AT EDGE OF BRACED WALL PANEL. (CS16 STRAPPING MAY BE SUBSTITUTED w/ SIMILAR LENGTH AND NAILING PATTERN.) USE HTT4 FOR ATTACHMENT TO CONCRETE.

SCALED LENGTH OF WALL PANEL AT LOCATION NUMERICAL LENGTH OF PANEL
PANEL TYPE

WALL BRACING: RECTANGLE 1

SIDE	REQUIRED LENGTH	PROVIDED LENGTH
FRONT	18.0 FT.	19.75 FT.
RIGHT	23.0 FT.	24.0 FT.
REAR	18.0 FT.	20.08 FT.
LEFT	23.0 FT.	24.0 FT.

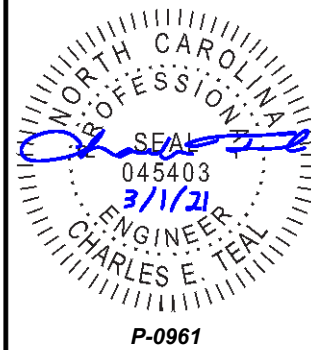

P-0961

JDSfaulkner, PLLC HAS PERFORMED A STRUCTURAL REVIEW OF THESE PLANS. THE STRUCTURAL COMPONENTS COMPLY WITH THE 2018 NORTH CAROLINA RESIDENTIAL CODE FOR ONE- AND TWO-FAMILY DWELLINGS FOR NC PLAN REVIEW. DEVIATION OF ANY STRUCTURAL REQUIREMENTS OF THESE PLANS WITHOUT THE APPROVAL OF THE EOR IS PROHIBITED.



8800 D' JERSEY CT, RALEIGH, NC 27617-919-480,1075
 INFO@JDSFAULKNER.COM | WWW.JDSFAULKNER.COM

PROJECT NO.: 21900377
 DATE: 03/01/2021

PLAN:
243.2939

FIRST FLOOR
 WALL BRACING PLAN

S4.0B

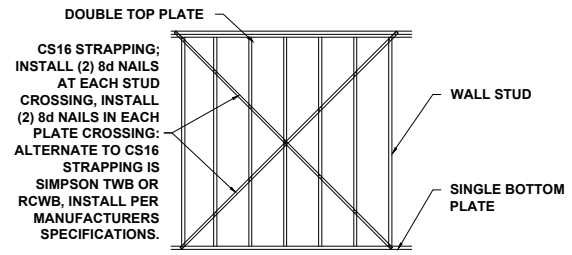
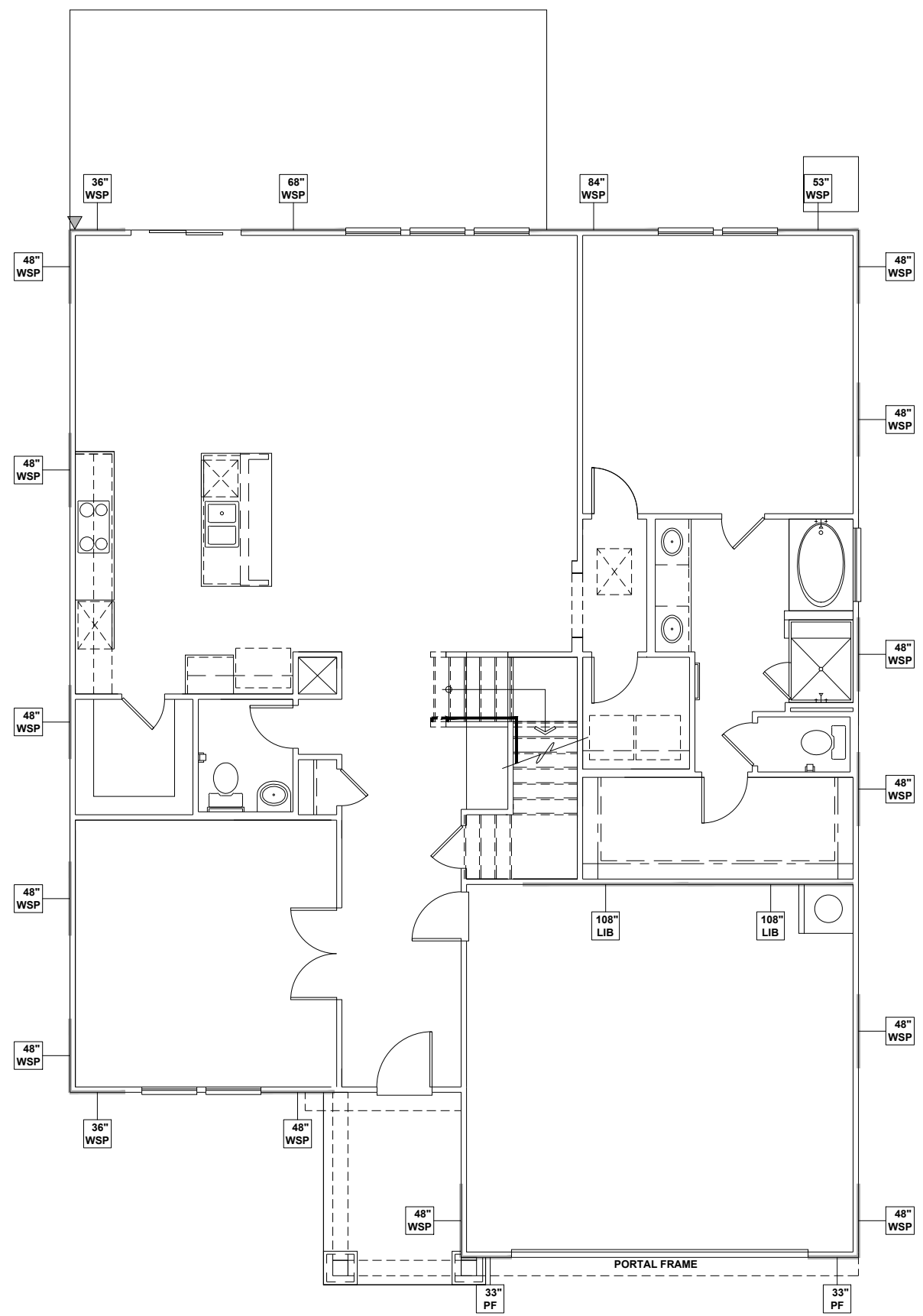

**CROSS BRACED LIB
 CS16 STRAPPING METHOD**
 SCALE: 1/4" = 1'-0" STRAP ANGLES TO BE NO MORE THAN 60° AND NO LESS THAN 40°

FIRST FLOOR WALL BRACING PLAN - 'B'
 SCALE: 1/8"=1'-0"

These designs and drawings are CONFIDENTIAL, and the exclusive property of KB Home Corporation and are not to be disclosed without the express permission of KB Home Corporation. They may not be used or duplicated without the express permission of KB Home Corporation. Copyright 2019 © KB Home Corporation. All rights reserved.

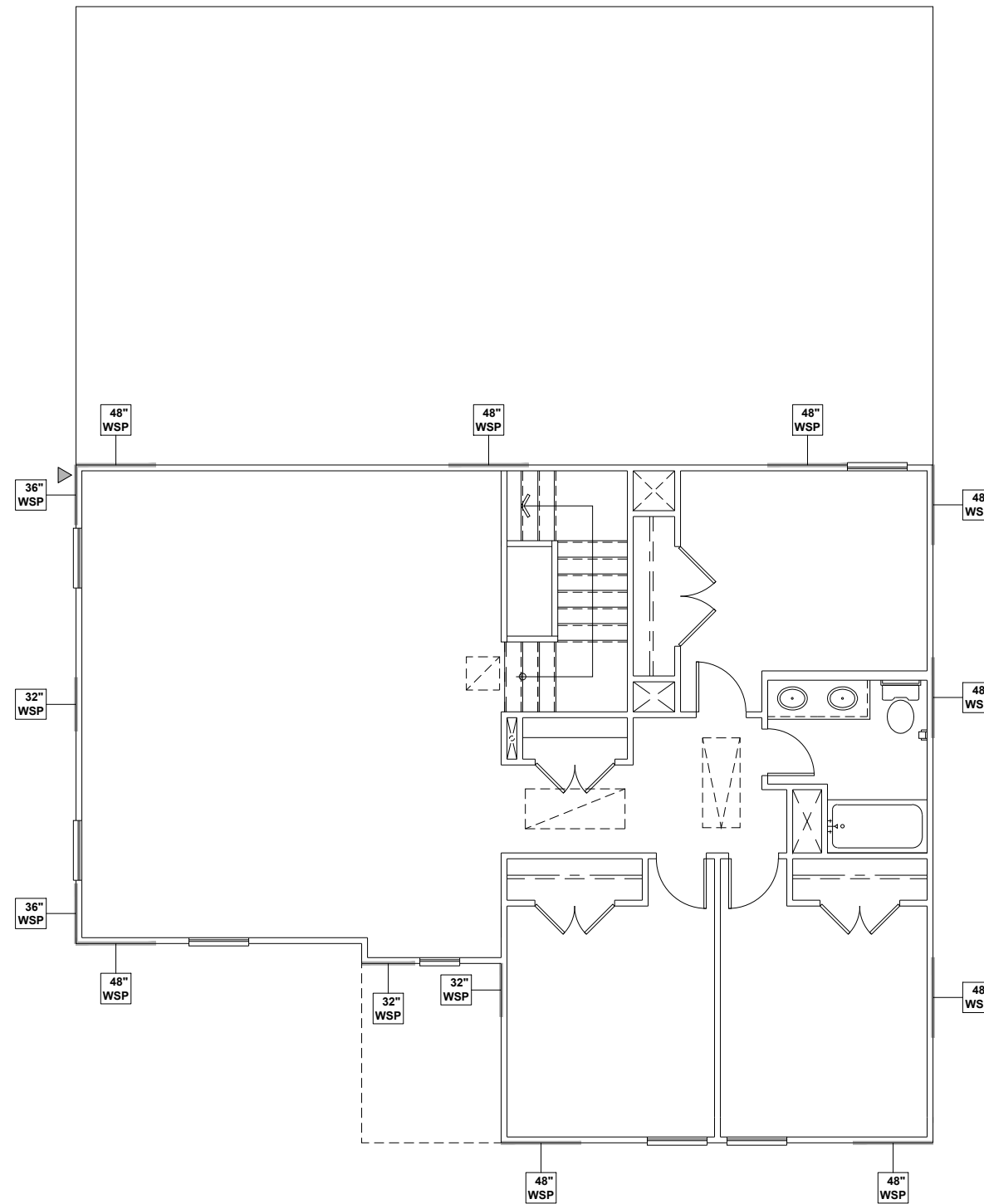

SECOND FLOOR WALL BRACING PLAN - 'B'

SCALE: 1/8" = 1'-0"

WALL BRACING REQUIREMENTS

- MINIMUM PANEL WIDTH IS 24"
- FIGURES BASED ON THE CONTINUOUS SHEATHING METHOD USING THE RECTANGLE CIRCUMSCRIBED AROUND THE FLOOR PLAN OR PORTION OF THE FLOOR PLAN. IF NO RECTANGLE IS NOTED, THE STRUCTURE HAS BEEN FIGURED ALL WITHIN ONE RECTANGLE.
- PANELS MAY SHIFT UP TO 36" EITHER DIRECTION FOR EASE OF CONSTRUCTION (NAILING & BLOCK REQUIREMENTS STILL APPLY).
- FOR ADDITIONAL WALL BRACING INFORMATION, REFER TO WALL BRACING DETAIL SHEET(S).
- SCHEMATIC BELOW INDICATES HOW SIDES OF RECTANGLE ARE TO BE INTERPRETED IN BRACING CHART WHEN APPLIED TO STRUCTURE:

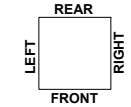

- ◆ CS16 STRAP FROM STUD, CROSS HEADER, TO WALL TOP PLATE, 36" LONG MINIMUM
- ▶ SIMPSON MSTA15 HOLD DOWN CAPACITY OF 970 POUNDS PER ANCHOR WITH (12) 10d NAILS. STRAP TO BE LOCATED AT EDGE OF BRACED WALL PANEL. (CS16 STRAPPING MAY BE SUBSTITUTED w/ SIMILAR LENGTH AND NAILING PATTERN.) USE HTT4 FOR ATTACHMENT TO CONCRETE.

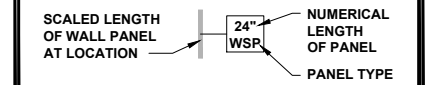

WALL BRACING: RECTANGLE 1

SIDE	REQUIRED LENGTH	PROVIDED LENGTH
FRONT	9.0 FT.	14.66 FT.
RIGHT	7.0 FT.	12.0 FT.
REAR	9.0 FT.	11.33 FT.
LEFT	7.0 FT.	12.0 FT.



KB HOME
NORTH CAROLINA DIVISION
4518 S. MIAMI BLVD.
SUITE 180
DURHAM, NC 27703
TEL: (919) 768-7988
FAX: (919) 472-0582

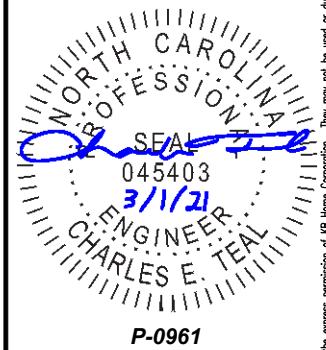

P-0961

JDSfaulkner, PLLC HAS PERFORMED A STRUCTURAL REVIEW OF THESE PLANS. THE STRUCTURAL COMPONENTS COMPLY WITH THE 2018 NORTH CAROLINA RESIDENTIAL CODE FOR ONE- AND TWO-FAMILY DWELLINGS FOR NC PLAN REVIEW. DEVIATION OF ANY STRUCTURAL REQUIREMENTS OF THESE PLANS WITHOUT THE APPROVAL OF THE EOR IS PROHIBITED.



8800 'D' JERSEY CT, RALEIGH, NC 27617/919.480.1075
INFO@JDSfaulkner.COM | WWW.JDSfaulkner.COM

PROJECT NO.: 21900377
DATE: 03/01/2021

PLAN:
243.2939

SECOND FLOOR
WALL BRACING PLAN

S5.0B

These designs and drawings are CONFIDENTIAL, and the exclusive property of KB Home Corporation and are not to be disclosed without the express permission of KB Home Corporation. They may not be used or duplicated without the express permission of KB Home Corporation. Copyright 2019 © KB Home Corporation. All rights reserved.

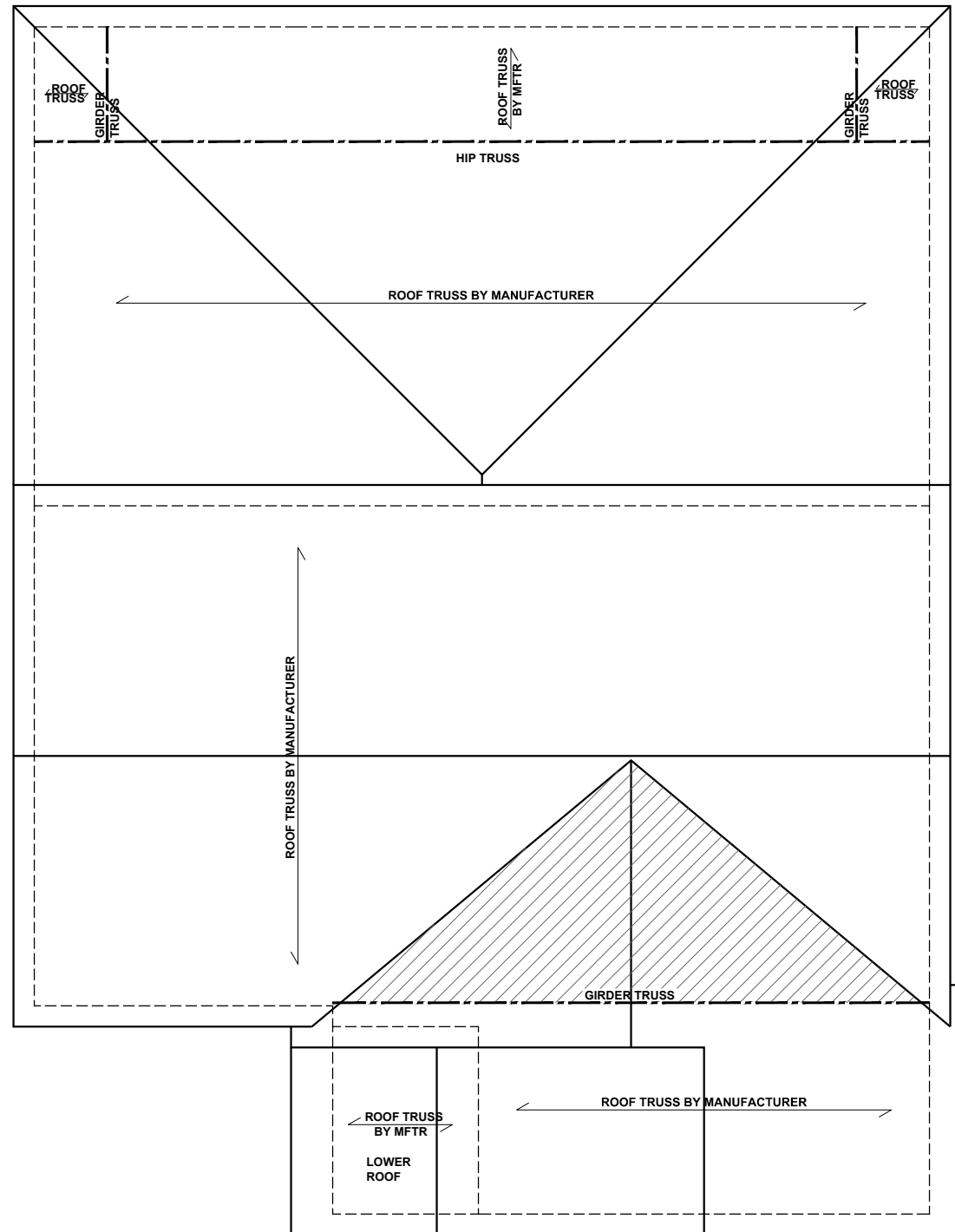

BEAM & POINT LOAD LEGEND

	INTERIOR LOAD BEARING WALL
	ROOF RAFTER / TRUSS SUPPORT
	DOUBLE RAFTER / DOUBLE JOIST
	STRUCTURAL BEAM / GIRDER
	WINDOW / DOOR HEADER
	POINT LOAD TRANSFER
	POINT LOAD FROM ABOVE BEARING ON BEAM / GIRDER

- TRUSSED ROOF - STRUCTURAL NOTES**
- PROVIDE CONTINUOUS BLOCKING THROUGH STRUCTURE FOR ALL POINT LOADS.
 - DENOTES OVER-FRAMED AREA
 - MINIMUM 7/16" OSB ROOF SHEATHING
 - TRUSS LAYOUT AND PLACEMENT BY MANUFACTURER TO COINCIDE WITH THE SUPPORT LOCATIONS SHOWN. TRUSS PROFILES SHALL BE SEALED BY THE TRUSS MANUFACTURER. TRUSS PLANS TO BE COORDINATED WITH THE SEALED STRUCTURAL DRAWINGS. INSTALLATION SHALL BE IN ACCORDANCE WITH THE MANUFACTURER'S INSTRUCTIONS.
 - MANUFACTURER TO PROVIDE REQUIRED UPLIFT CONNECTION.
 - PROVIDE H2.5A (MINIMUM) OR EQUIVALENT AT EACH TRUSS-TO-TOP PLATE CONNECTION AT OVER-FRAMED AREAS, UNLESS NOTED OTHERWISE.
 - UPLIFT CONNECTION TO BE CARRIED THROUGH TO FLOOR SYSTEM.

ATTIC VENTILATION

THE TOTAL NET-FREE VENTILATION AREA SHALL NOT BE LESS THAN 1/150 OF THE AREA OF THE ATTIC SPACE TO BE VENTILATED. THE TOTAL VENTILATION MAY BE REDUCED TO 1/300 PROVIDED AT LEAST 50% BUT NOT MORE THAN 80% OF THE REQUIRED VENTILATION BE LOCATED IN THE UPPER PORTION OF THE AREA TO BE VENTILATED, OR AT LEAST 3' ABOVE THE SOFFIT VENTILATION INTAKE.

2535	SQUARE FEET OF TOTAL ATTIC / 150 =
16.9	SQUARE FEET OF NET-FREE VENTILATION REQUIRED

TRUSS UPLIFT CONNECTORS: EXPOSURE B, 115 MPH. ANY PITCH, 24" O.C. MAX ROOF TRUSS SPACING

TRUSSES SHALL BE ATTACHED TO SUPPORT WALL FOR UPLIFT RESISTANCE. CONTINUOUS OSB WALL SHEATHING BELOW PROVIDES CONTINUOUS UPLIFT RESISTANCE TO FOUNDATION. ALL TRUSSES SUPPORTED BY INTERMEDIATE SUPPORT WALLS, KNEEWALLS, OR BEAMS SHALL BE ATTACHED TO SUPPORTING MEMBER PER SCHEDULE:

ROOF SPAN IS MEASURED HORIZONTALLY BETWEEN FURTHEST SUPPORT POINTS.

ROOF PLAN UP TO 28'	CONNECTOR NAILING PER TABLE 602.3(1) NCRBC 2018 EDITION
OVER 28'	(1) SIMPSON H2.5A HURRICANE CLIP TO DBL TOP PLATE OR BEAM OR (1) SIMPSON H3 CLIP TO SINGLE 2x4 PLATE



KB HOME
NORTH CAROLINA DIVISION
4518 S. MIAMI BLVD.
SUITE 180
DURHAM, NC 27703
TEL: (919) 768-7988
FAX: (919) 472-0582

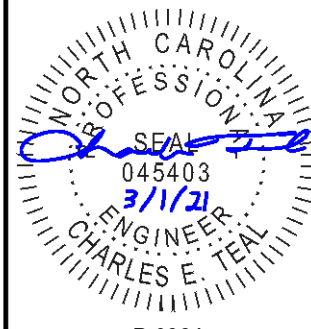

P-0961

JDSfaulkner, PLLC HAS PERFORMED A STRUCTURAL REVIEW OF THESE PLANS. THE STRUCTURAL COMPONENTS COMPLY WITH THE 2018 NORTH CAROLINA RESIDENTIAL CODE FOR ONE- AND TWO-FAMILY DWELLINGS FOR NC PLAN REVIEW. DEVIATION OF ANY STRUCTURAL REQUIREMENTS OF THESE PLANS WITHOUT THE APPROVAL OF THE EOR IS PROHIBITED.



8800 D' JERSEY CT, RALEIGH, NC 27617-919480,1075
INFO@JDSfaulkner.COM ; WWW.JDSfaulkner.COM
PROJECT NO.: 21900377

DATE: 03/01/2021

PLAN:
243.2939

ROOF FRAMING PLAN
S7.0B

ROOF FRAMING PLAN - 'B'
SCALE: 1/8"=1'-0"

These designs and drawings are CONFIDENTIAL, and the exclusive property of KB Home Corporation and are not to be disclosed without the express permission of KB Home Corporation. Copyright 2019 © KB Home Corporation. All rights reserved.

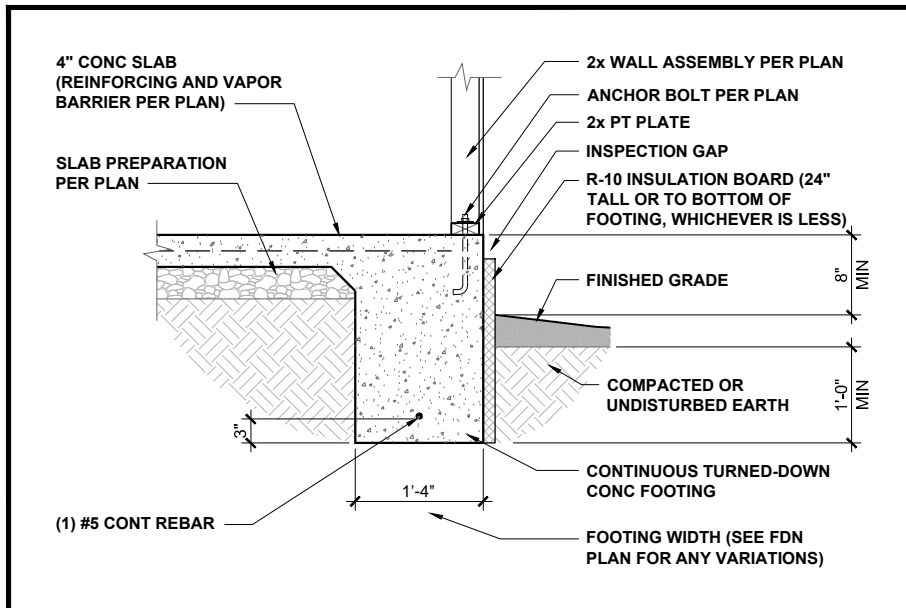

TURNED-DOWN CONC SLAB FOOTING 1/2" = 1'-0" **1**

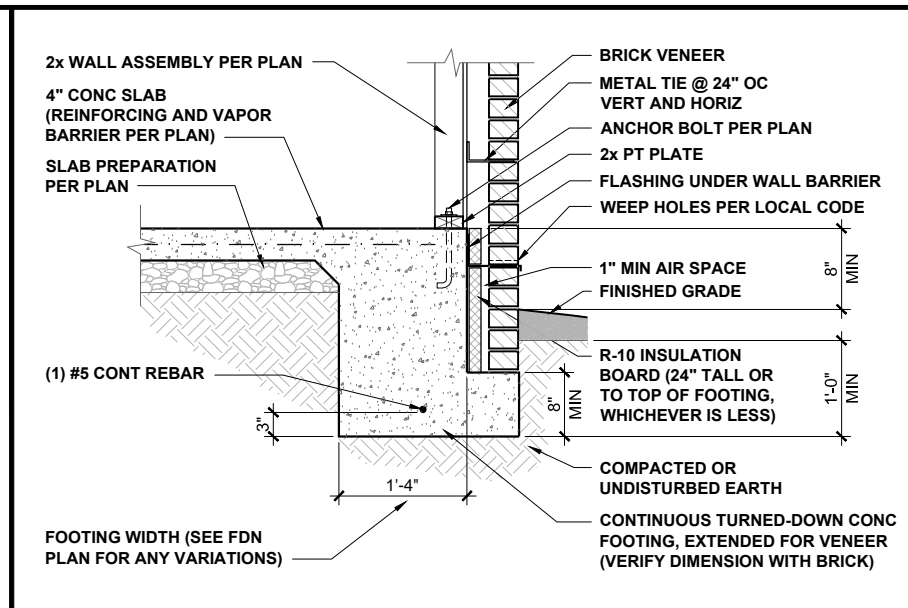

TURNED-DOWN FOOTING w/ BRICK 1/2" = 1'-0" **2**

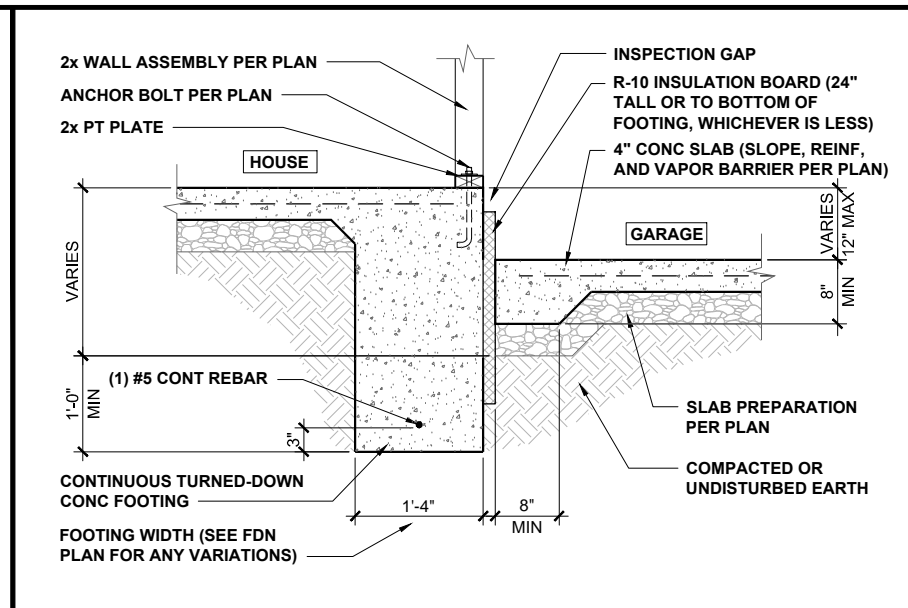

HOUSE / GARAGE FOOTING 1/2" = 1'-0" **3**

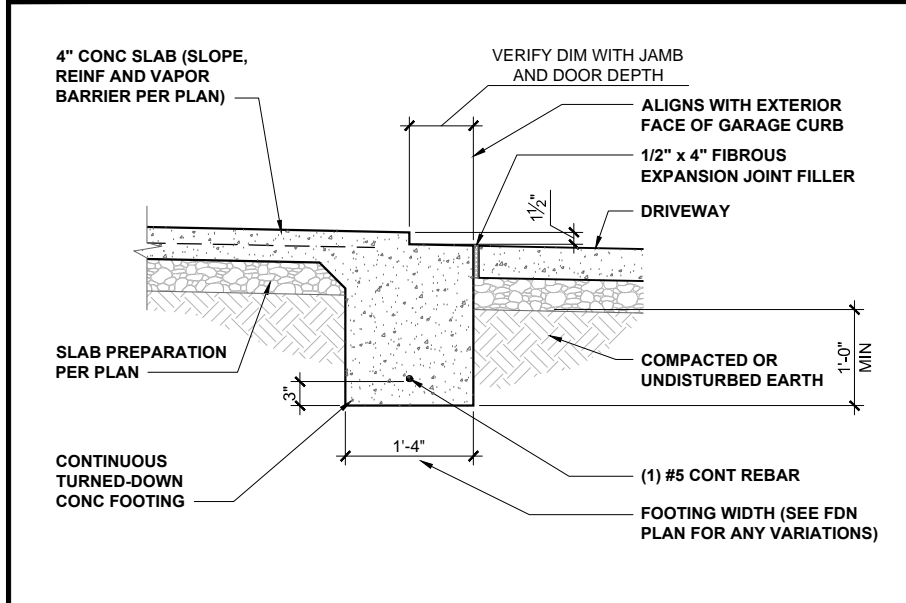

GARAGE DOORWAY FOOTING 1/2" = 1'-0" **4**

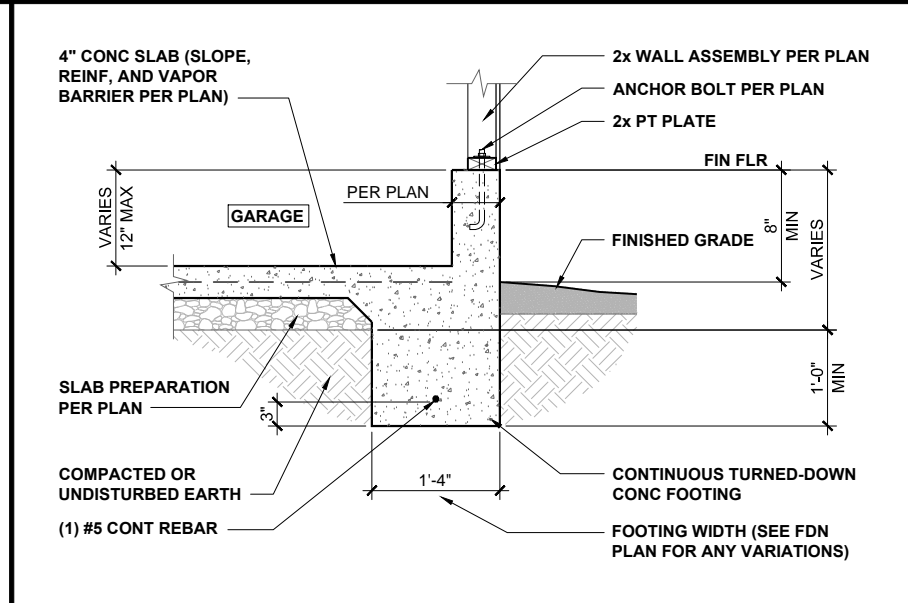

GARAGE FOUNDATION 1/2" = 1'-0" **5**

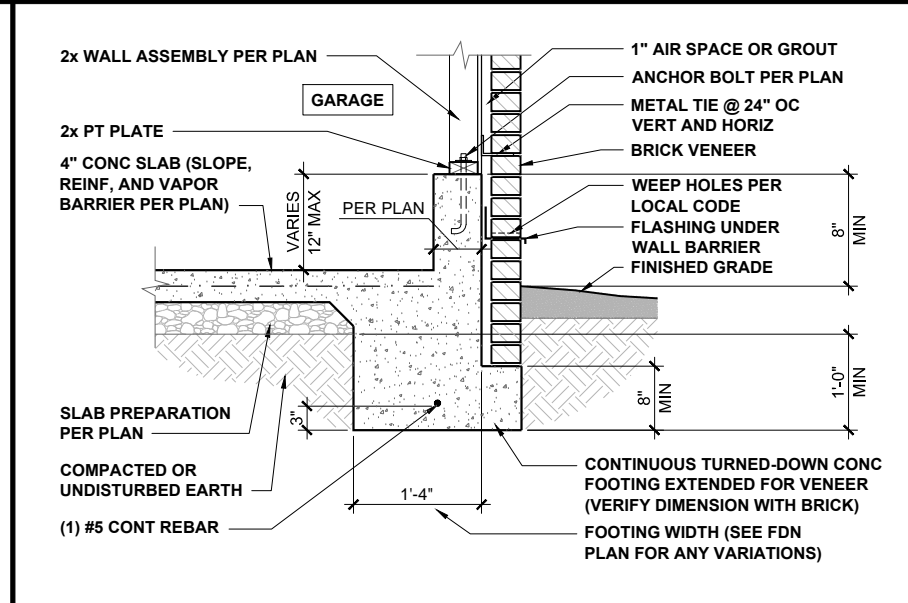

GARAGE FOUNDATION WITH BRICK 1/2" = 1'-0" **6**

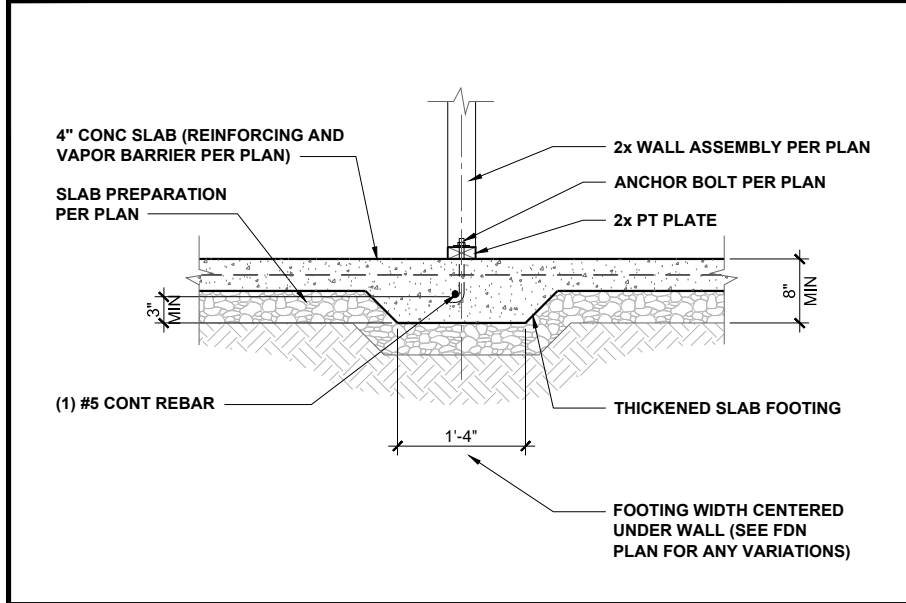

INTERIOR FOOTING 1/2" = 1'-0" **7**

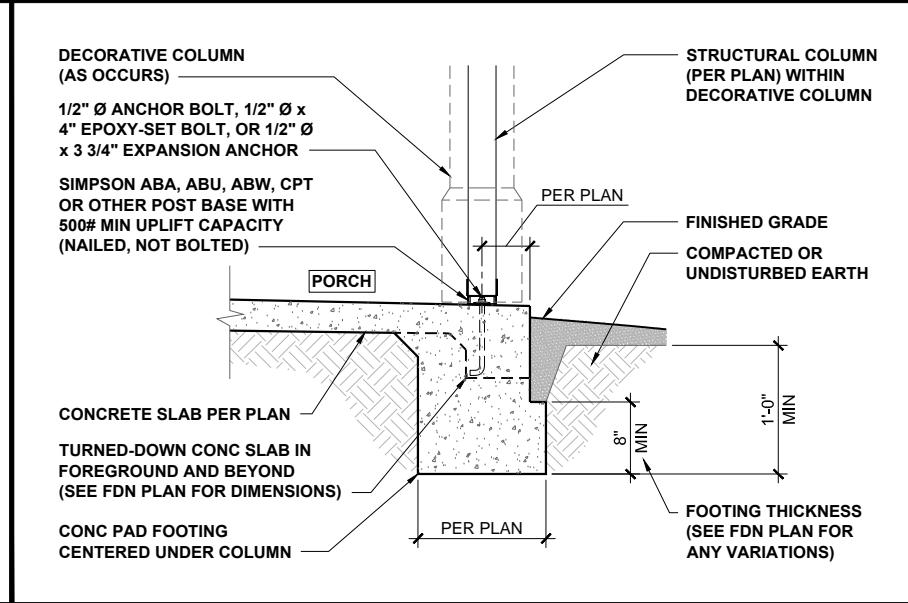

PORCH COLUMN FOUNDATION 1/2" = 1'-0" **8**

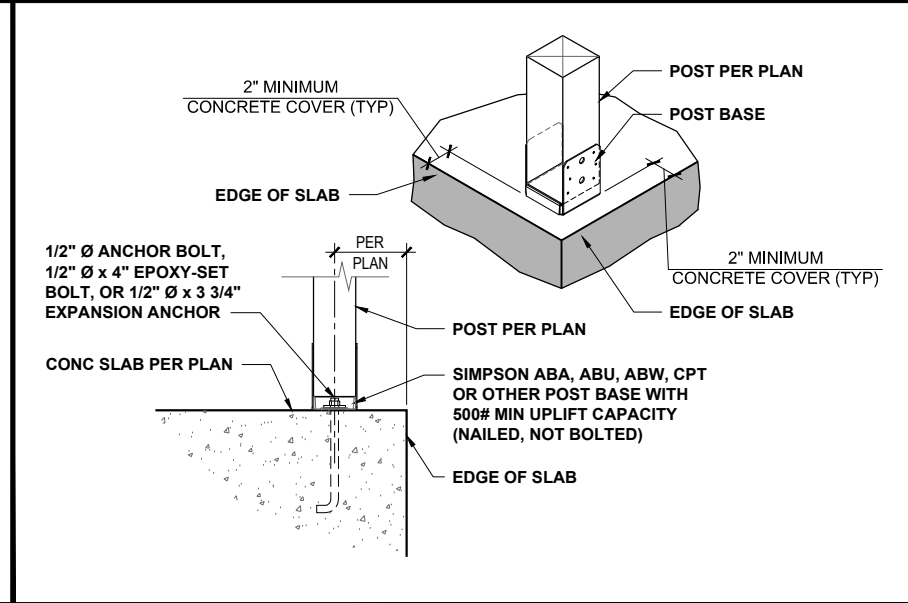

PORCH COLUMN 3/4" = 1'-0" **9**



KB HOME
NORTH CAROLINA DIVISION
4518 S. MIAMI BLVD.
SUITE 180
DURHAM, NC 27703
TEL: (919) 768-7988
FAX: (919) 472-0582

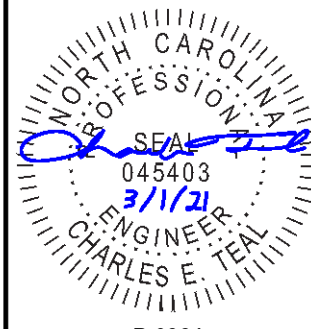

P-0961

JDSfaulkner, PLLC HAS PERFORMED A STRUCTURAL REVIEW OF THESE PLANS. THE STRUCTURAL COMPONENTS COMPLY WITH THE 2018 NORTH CAROLINA RESIDENTIAL CODE FOR ONE- AND TWO-FAMILY DWELLINGS FOR NC PLAN REVIEW. DEVIATION OF ANY STRUCTURAL REQUIREMENTS OF THESE PLANS WITHOUT THE APPROVAL OF THE EOR IS PROHIBITED.



PROJECT NO.: 21900377
DATE: 03/01/2021

PLAN:
243.2939

TURNED-DOWN SLAB
FOUNDATION DETAILS

D1.0

These designs and drawings are CONFIDENTIAL and the exclusive property of KB Home Corporation and are not to be disclosed without the express permission of KB Home Corporation. Copyright 2019 © KB Home Corporation. All rights reserved.

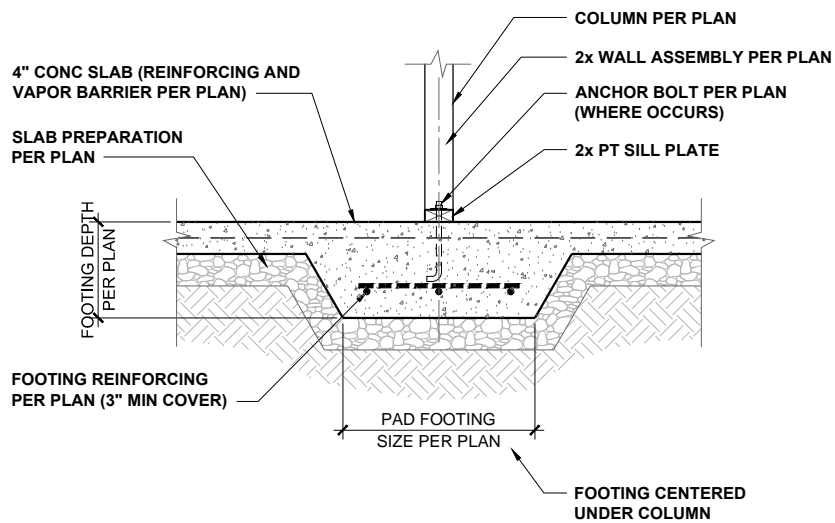

INT POINT-LOAD FOOTING SECTION 1/2" = 1'-0" **1**

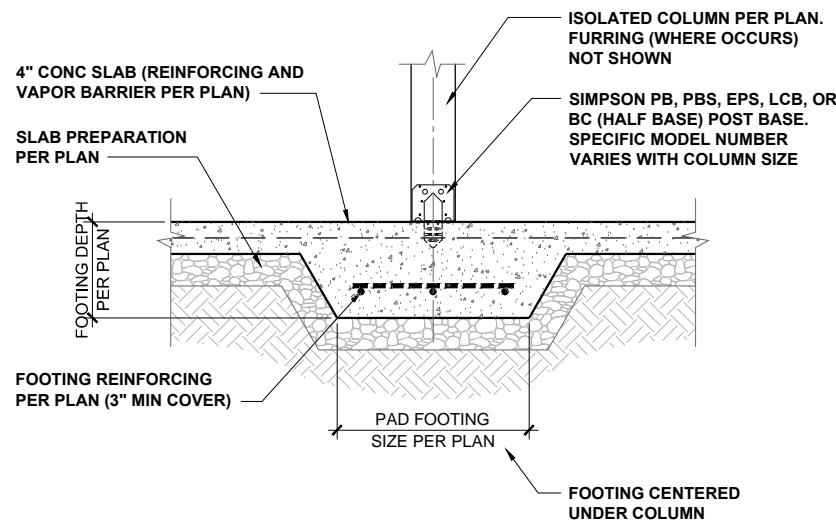

ISOLATED COLUMN FOOTING 1/2" = 1'-0" **2**

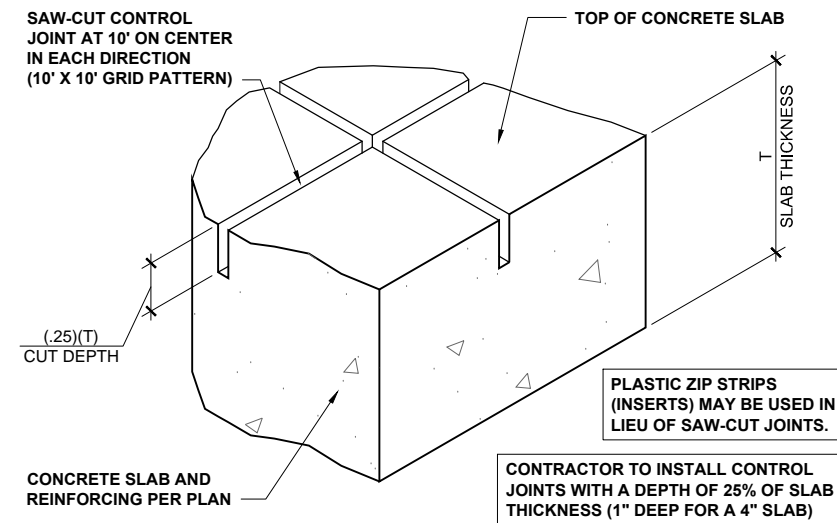

CONCRETE SLAB CONTROL JOINTS 3" = 1'-0" **3**

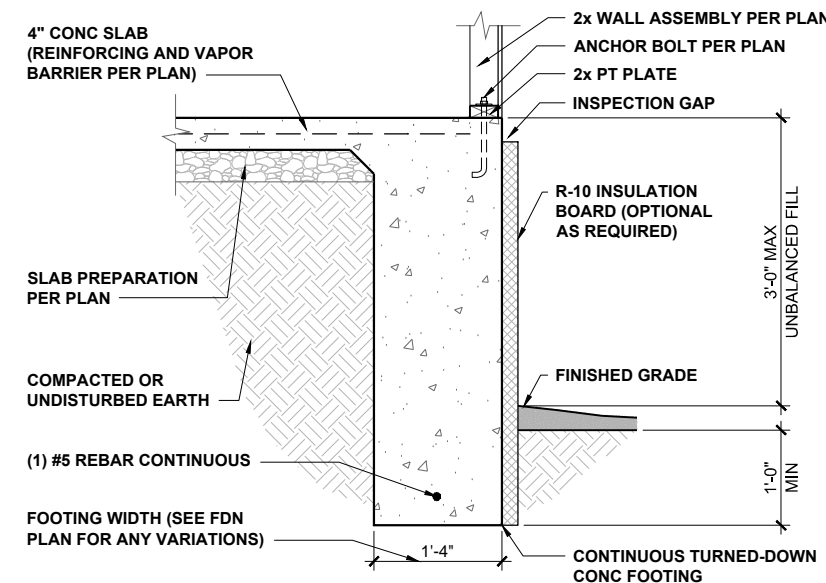

3' EXTENDED TURNED DOWN FOOTING 1/2" = 1'-0" **4**

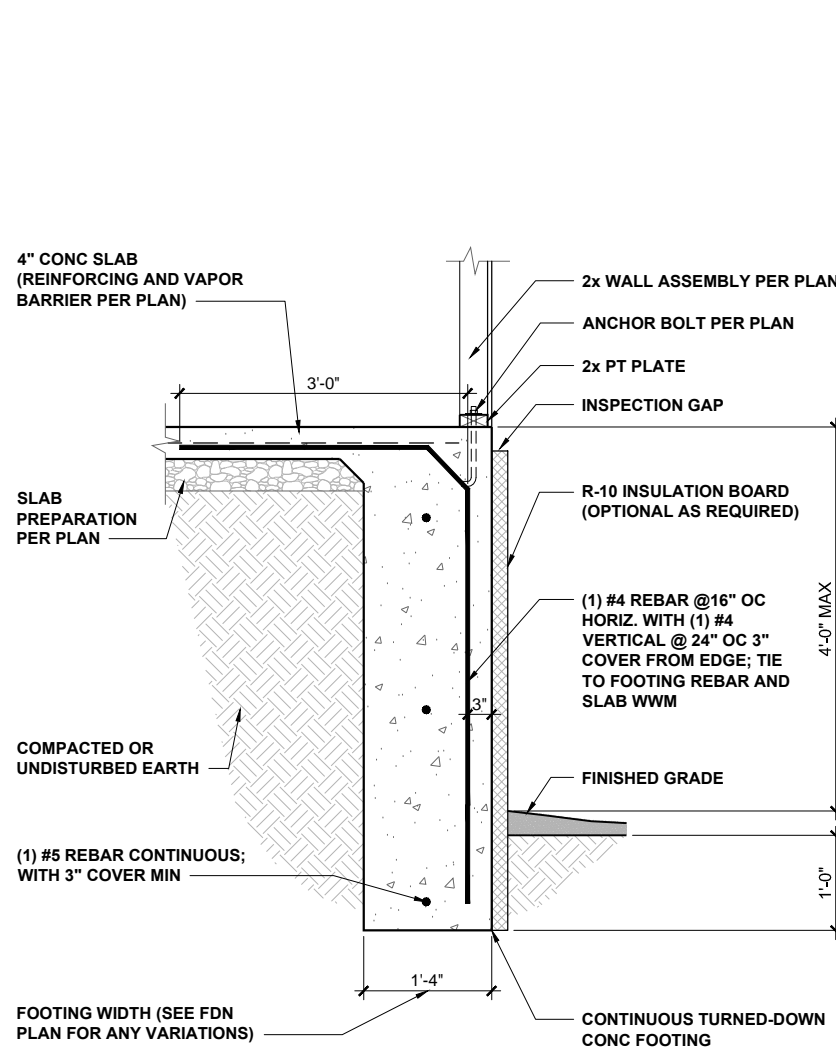

4' EXTENDED RETAINED FOOTING 1/2" = 1'-0" **6**

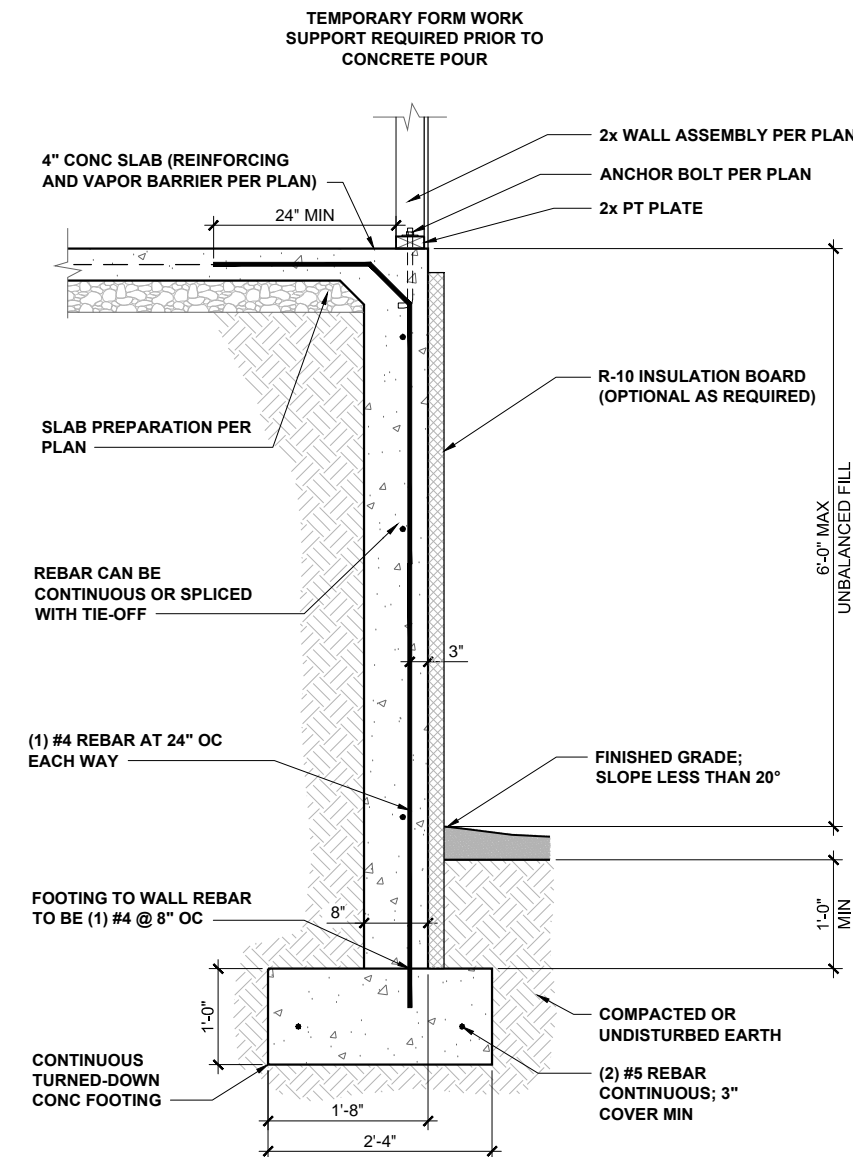

6' EXTENDED REINFORCED FOOTING 1/2" = 1'-0" **7**

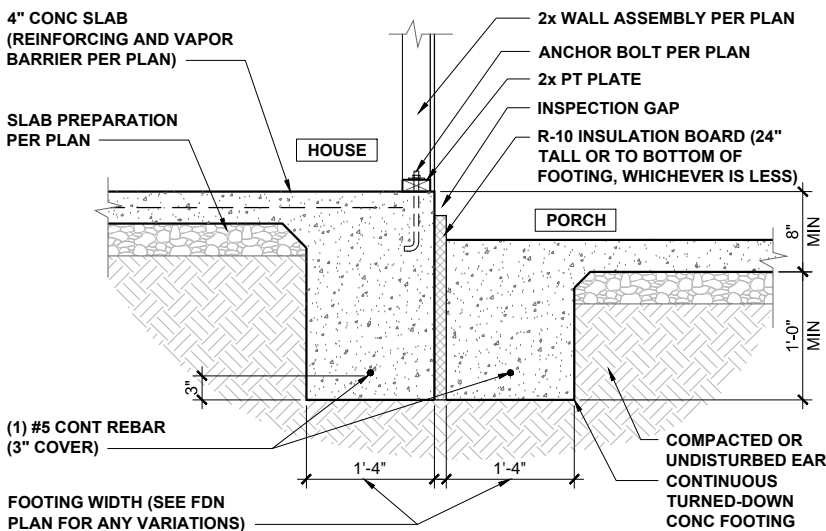

FOOTING AT HOUSE/PORCH 1/2" = 1'-0" **5**



KB HOME
NORTH CAROLINA DIVISION
4518 S. MIAMI BLVD.
SUITE 180
DURHAM, NC 27703
TEL: (919) 768-7988
FAX: (919) 472-0582

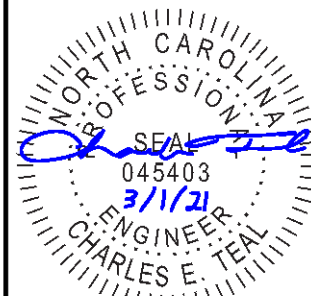

P-0961
JDSfaulkner, PLLC HAS PERFORMED A STRUCTURAL REVIEW OF THESE PLANS. THE STRUCTURAL COMPONENTS COMPLY WITH THE 2018 NORTH CAROLINA RESIDENTIAL CODE FOR ONE- AND TWO-FAMILY DWELLINGS FOR NC PLAN REVIEW. DEVIATION OF ANY STRUCTURAL REQUIREMENTS OF THESE PLANS WITHOUT THE APPROVAL OF THE EOR IS PROHIBITED.
JDSfaulkner
engineering • design • consulting
8800 D' JERSEY CT, RALEIGH, NC 27617-919, 480, 1075
INFO@JDSFAULKNER.COM | WWW.JDSFAULKNER.COM
PROJECT NO.: 21900377
DATE: 03/01/2021

PLAN:
243.2939

TURNED-DOWN SLAB
FOUNDATION DETAILS

D2.0

These designs and drawings are CONFIDENTIAL, and the entire property of KB Home Corporation and are not to be disclosed without the express permission of KB Home Corporation. They may not be used or duplicated without the express permission of KB Home Corporation. Copyright 2019 © KB Home Corporation. All rights reserved.

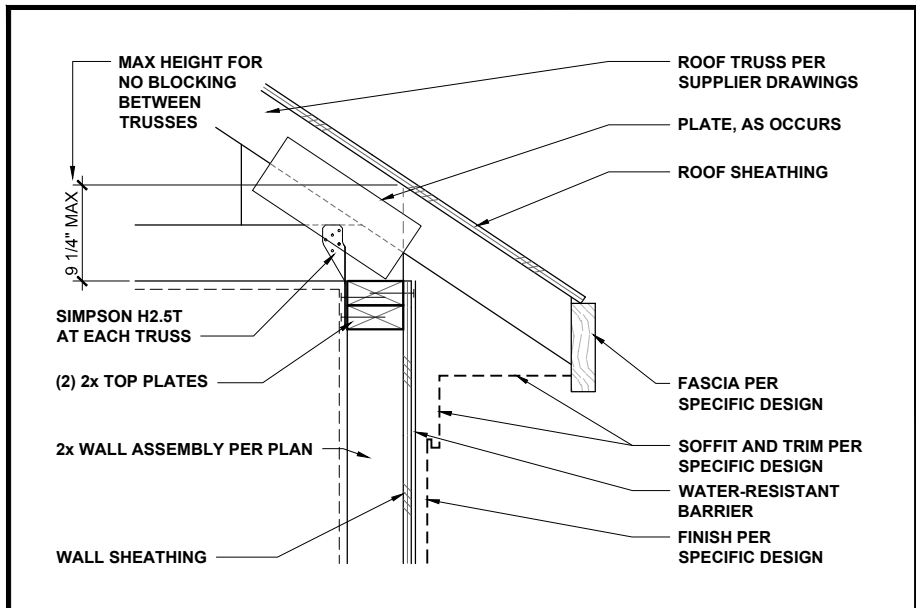

LOW-HEEL TRUSS AT WALL 1" = 1'-0" **1**

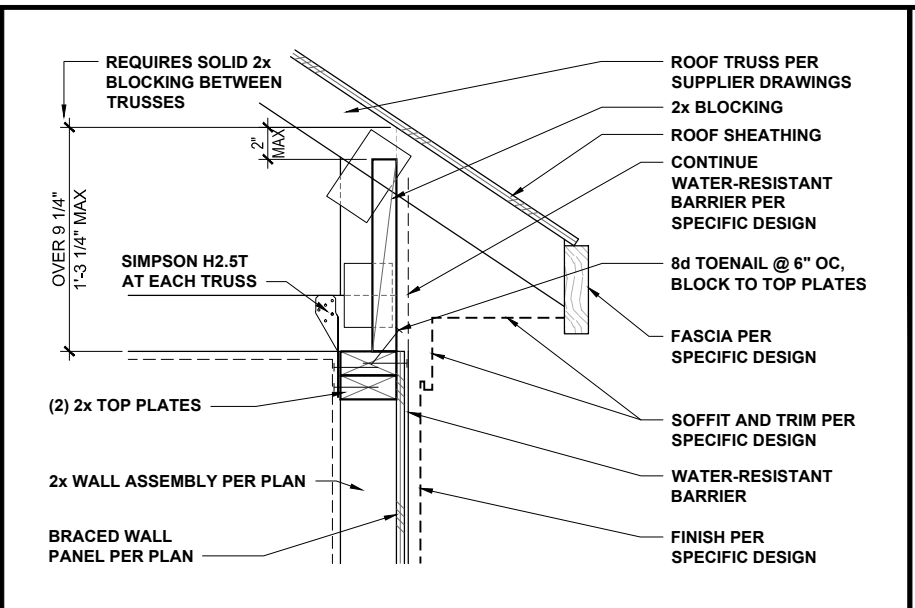

TYPICAL TRUSS AT BRACED WALL 1" = 1'-0" **2**

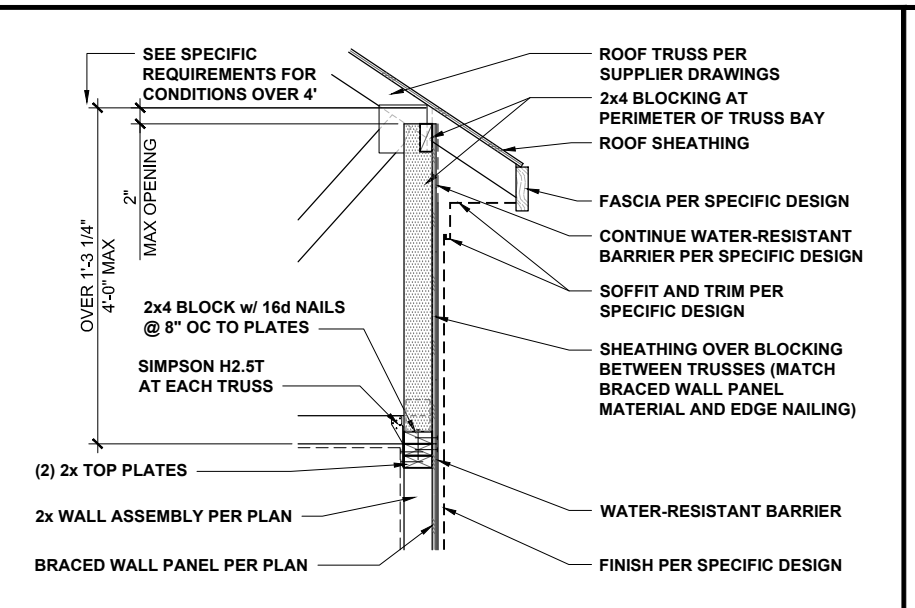

HIGH-HEEL TRUSS AT BRACED WALL 1/2" = 1'-0" **3**

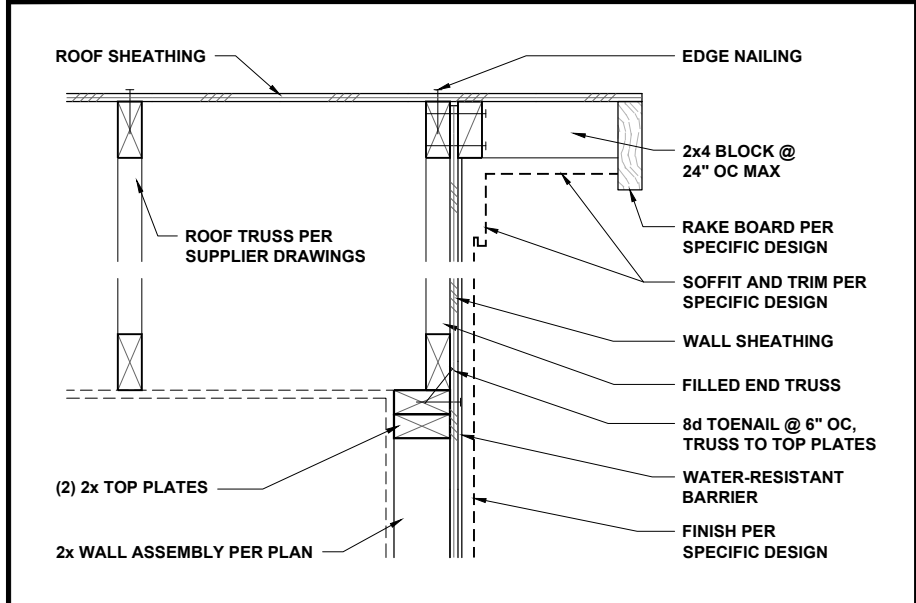

END TRUSS AT WALL 1" = 1'-0" **4**

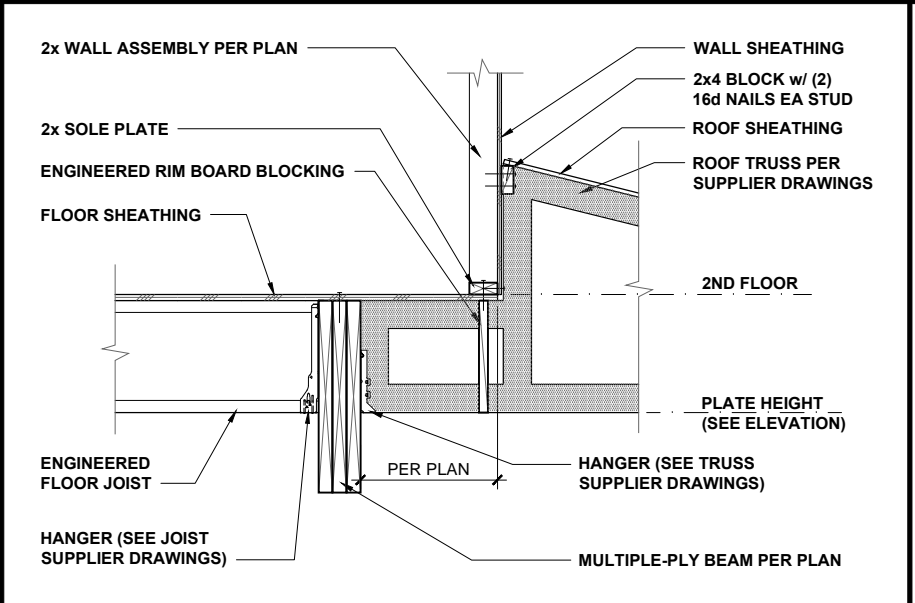

TRUSS AT BEAM AND WALL 1/2" = 1'-0" **5**

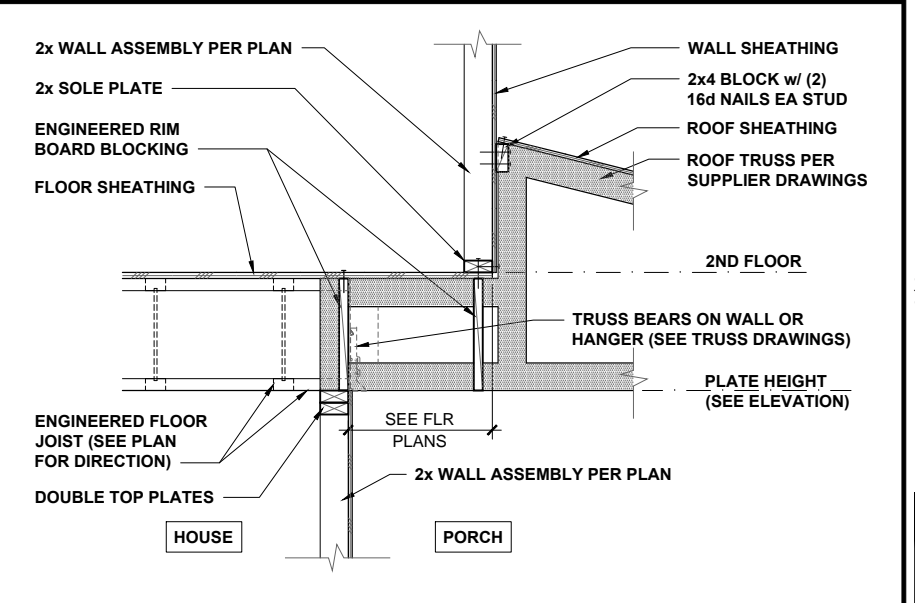

TRUSS AT FLOOR AND WALL 1/2" = 1'-0" **6**

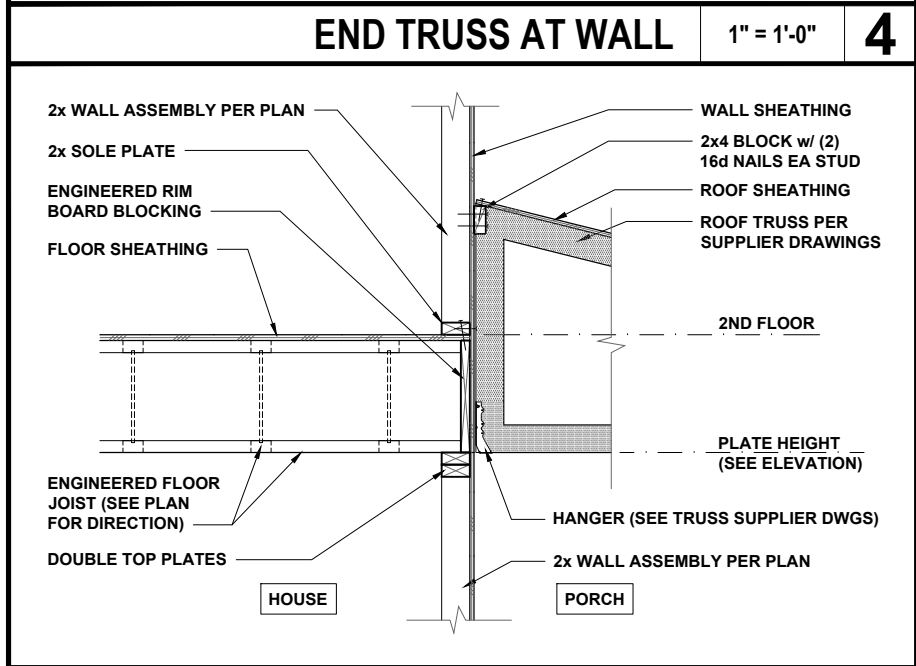

TRUSS AT FLOOR AND WALL 1/2" = 1'-0" **7**

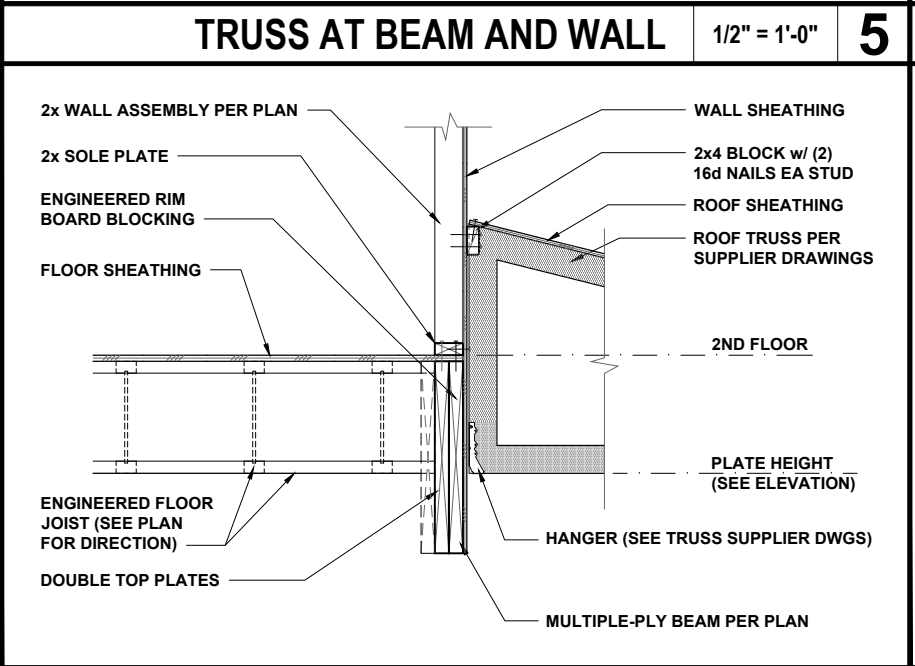

TRUSS AT BEAM AND WALL 1/2" = 1'-0" **8**

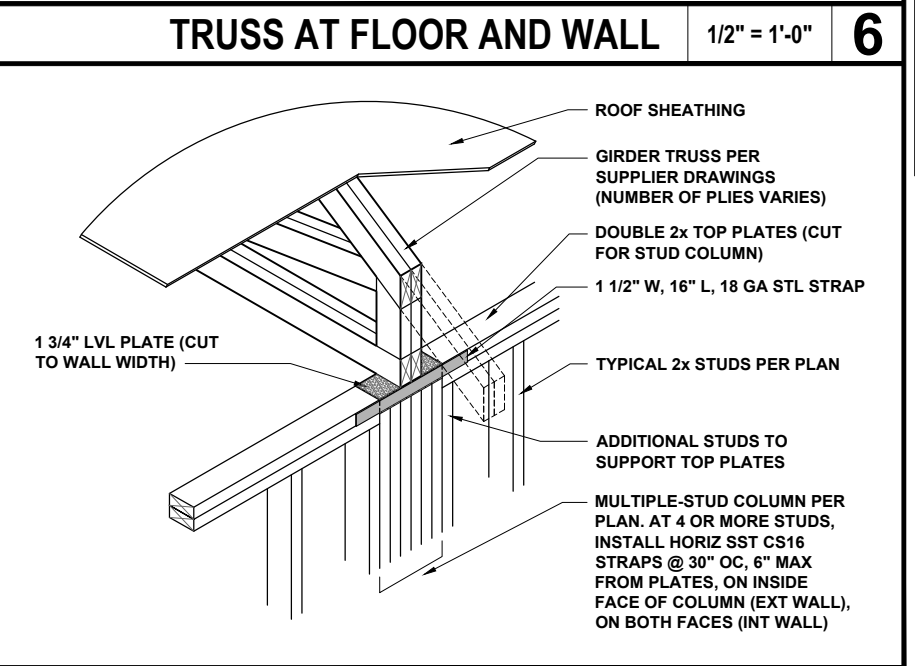

GIRDER TRUSS AT WALL 1/2" = 1'-0" **9**



KB HOME
NORTH CAROLINA DIVISION
4518 S. MIAMI BLVD.
SUITE 180
DURHAM, NC 27703
TEL: (919) 768-7988
FAX: (919) 472-0582

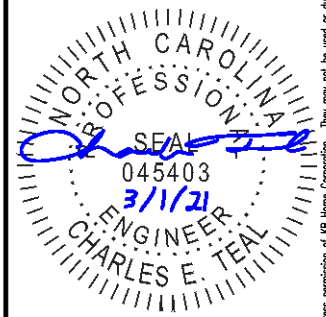

P-0961

JDSfaulkner, PLLC HAS PERFORMED A STRUCTURAL REVIEW OF THESE PLANS. THE STRUCTURAL COMPONENTS COMPLY WITH THE 2018 NORTH CAROLINA RESIDENTIAL CODE FOR ONE- AND TWO-FAMILY DWELLINGS FOR NC PLAN REVIEW. DEVIATION OF ANY STRUCTURAL REQUIREMENTS OF THESE PLANS WITHOUT THE APPROVAL OF THE EOR IS PROHIBITED.



PROJECT NO.: 21900377
DATE: 03/01/2021

PLAN:
243.2939

ROOF TRUSS
FRAMING DETAILS

D3.0

These designs and drawings are CONFIDENTIAL, and the enclosure property of KB Home Corporation and are not to be disclosed without the express permission of KB Home Corporation. Copyright 2019 © KB Home Corporation. All rights reserved.



KB HOME
NORTH CAROLINA DIVISION
4518 S. MIAMI BLVD.
SUITE 180
DURHAM, NC 27703
TEL: (919) 768-7988
FAX: (919) 472-0582



P-0961

JDSfaulkner, PLLC HAS PERFORMED A STRUCTURAL REVIEW OF THESE PLANS. THE STRUCTURAL COMPONENTS COMPLY WITH THE 2018 NORTH CAROLINA RESIDENTIAL CODE FOR ONE- AND TWO-FAMILY DWELLINGS FOR NC PLAN REVIEW. DEVIATION OF ANY STRUCTURAL REQUIREMENTS OF THESE PLANS WITHOUT THE APPROVAL OF THE EOR IS PROHIBITED.

JDSfaulkner
engineering • design • consulting
8800 D'JERSEY CT, RALEIGH, NC 27617 919.480.1075
INFO@JDSFAULKNER.COM WWW.JDSFAULKNER.COM

PROJECT NO.: 21900377
DATE: 03/01/2021

PLAN:
243.2939

WALL BRACING DETAILS

D4.0

These designs and drawings are CONFIDENTIAL, and the enclosure property of KB Home Corporation and are not to be disclosed without the express permission of KB Home Corporation. They may not be used or duplicated without the express permission of KB Home Corporation. Copyright 2019 © KB Home Corporation, all rights reserved.

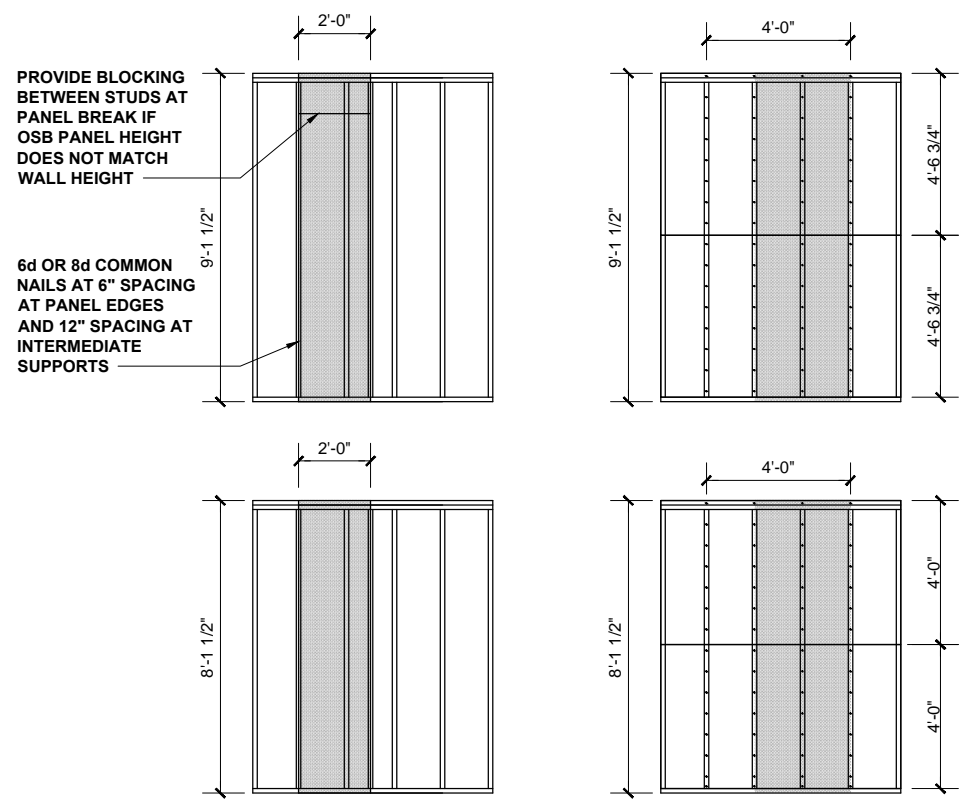
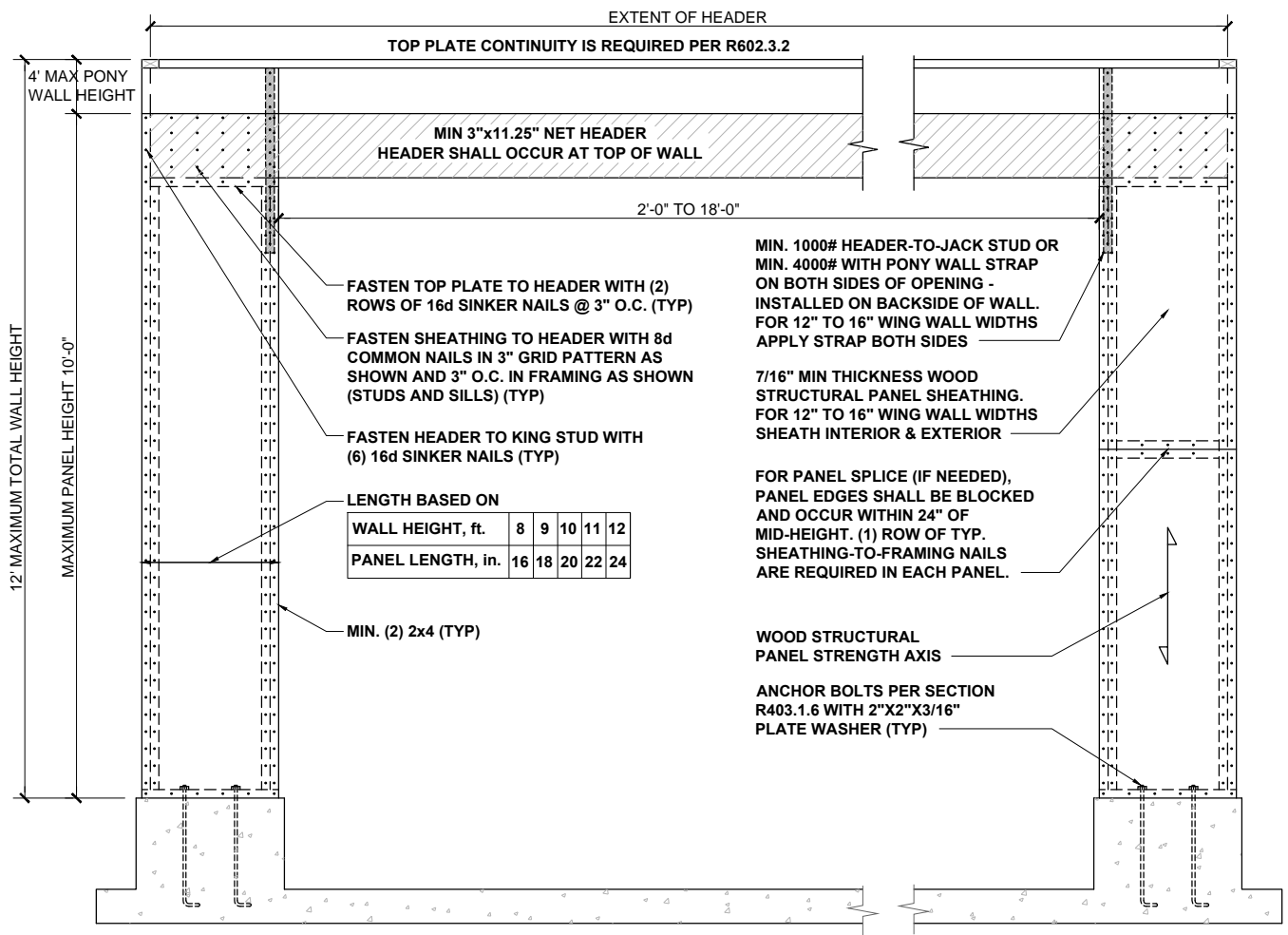

BRACED WALL PANEL 7/16" MIN. OSB SHEATHING ON ONE SIDE OF WALL. MINIMUM PANEL LENGTH 24".

BRACED WALL PANEL 1/2" GYPSUM BOARD NAILED TO STUDS AT 7" O.C. USING 5d COOLER NAILS OR #6 SCREWS. MINIMUM PANEL LENGTH 48" WHEN APPLIED TO BOTH SIDES OF WALL AND 96" WHEN APPLIED TO ONE SIDE OF WALL.

HIGH-SPEED WIND ZONES

FOR LOCATIONS OF 130 MPH OR MORE ULTIMATE DESIGN WIND SPEED (110 MPH OR MORE BASIC WIND SPEED IN VIRGINIA AND GEORGIA), WALLS SHALL BE BRACED PER THE LATEST ADOPTED EDITION OF THE AMERICAN SOCIETY OF CIVIL ENGINEERS PUBLICATION ASCE 7 OR STANDARD FOR RESIDENTIAL CONSTRUCTION IN HIGH-WIND REGIONS (ICC 600).

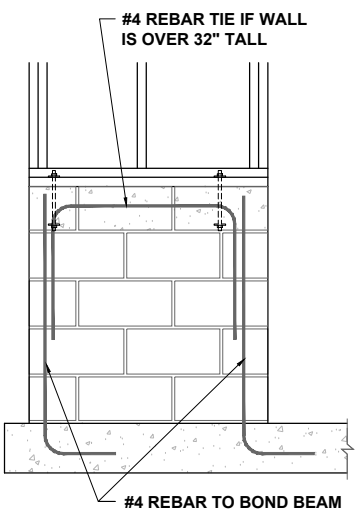

GARAGE WING WALL AT CRAWL
SEE R602.10 - MASONRY STEM WALL SUPPORTING BRACED WALL PANELS FIGURES

METHOD PF: PORTAL FRAME PANEL CONSTRUCTION

3/8" = 1'-0" **1**

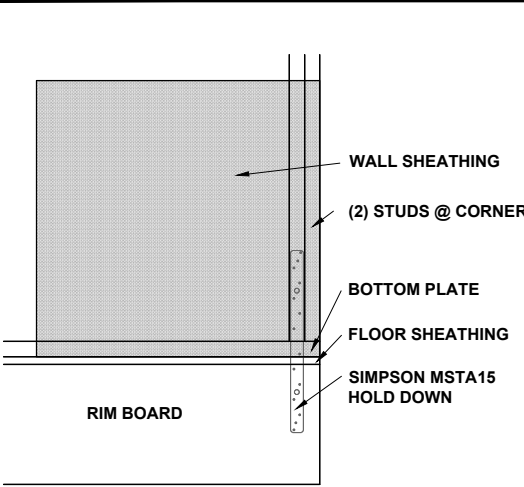

SIMPSON MSTA15 HOLD DOWN CAPACITY OF 970 POUNDS PER ANCHOR WITH (12) 10d NAILS. STRAP TO BE LOCATED AT EDGE OF BRACED WALL PANEL.

BRACED WALL HOLD-DOWN NTS **3**

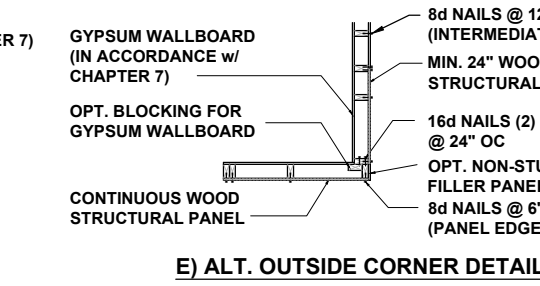
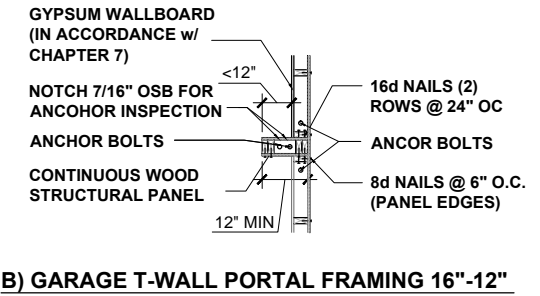
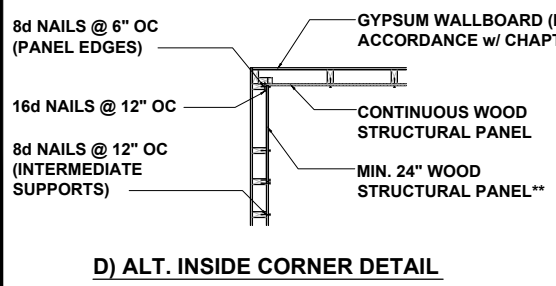
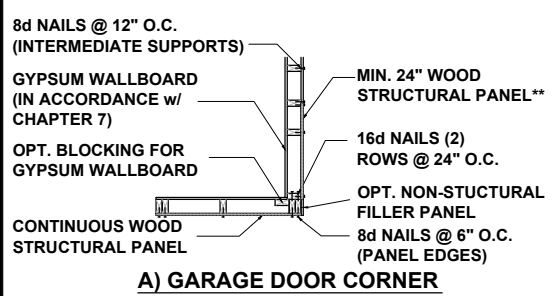

CORNER FRAMING FOR CONTINUOUS SHEATHING 1/4" = 1'-0" **4**

BRACING METHODS

3/16" = 1'-0" **2**

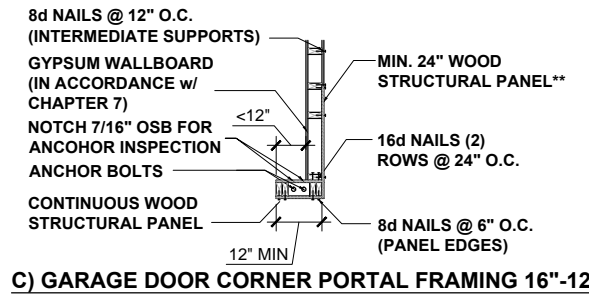

** IN LIEU OF THE CORNER RETURN, A HOLD-DOWN DEVICE WITH A MINIMUM UPLIFT DESIGN VALUE OF 800# SHALL BE FASTENED TO THE CORNER STUD AND TO THE FOUNDATION OR FRAMING BELOW.

WALL BRACING DETAILS

JOIST DETAILS

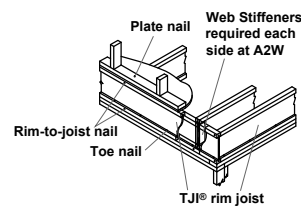

A2 | A2W Must have 1 3/4" minimum joist bearing at ends. Attach rim joist per A3 detail.

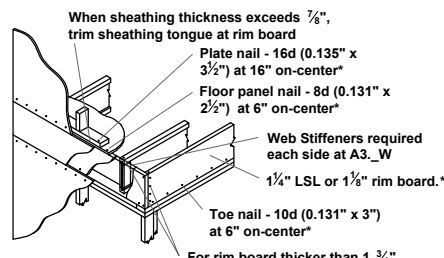

A3 | A3W For rim board thicker than 1 3/4" - Attach Joist to rim board with one 10d (0.128"x3") nail. Top nail from joist into rim board. - Connect corner with four 10d (0.128"x3") nails. Toe nail from side of parallel closure into rim board

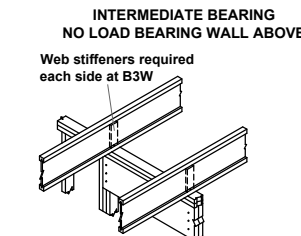

B3 | B3W Blocking panels may be required with shear walls above or below (See detail B1)

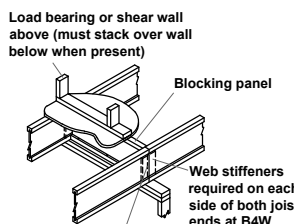

B4 | B4W End of joists at centerline of support

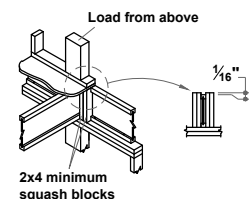

CS Use 2x4 minimum squash blocks to transfer load around joist

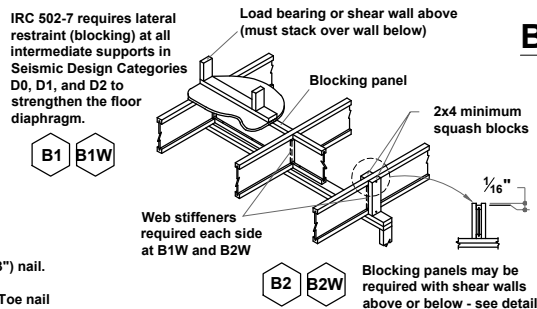

B1 | B1W Blocking panels may be required with shear walls above or below - see detail B1

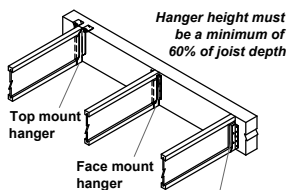

H1 Web stiffeners required if sides of hanger do not laterally support at least 3/8" of joist top flange

BEAM and COLUMN DETAILS

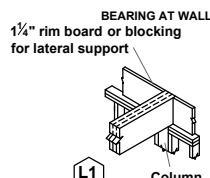

L1 Column

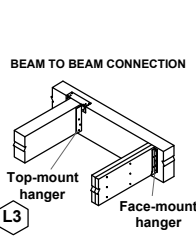

L3 Face-mount hanger

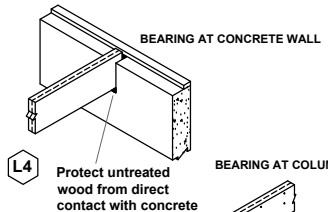

L4 Protect untreated wood from direct contact with concrete

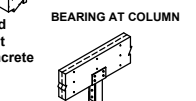

L5 Verify column capacity and beam bearing length.

FASTENING of FLOOR PANELS

Guidelines for Closest On-Center Spacing per Row

Nail Size	I-JOIST *		Rim Board	1 1/2" LSL or wider	LVL	PSL
	110, 210, and 230 EQ.	360 and 560 EQ.	1 1/4" LSL			
8d (0.131" x 2 1/2")	4"	3"	4"	3"	3"	3"
10d (0.148" x 3")	4"	4"	4"	4"	4"	4"
16d (0.162" x 3 1/2")	6"	6"	6" (2)	6" (2)	8"	6"

- (1) One row of fasteners permitted (two at abutting panel edges) for diaphragms. Stagger nails when using 4" on-center spacing and maintain 3/8" joist and panel edge distance. For other applications, multiple rows of fasteners are permitted if the rows are offset at least 1/2" and staggered.
- (2) Can be reduced to 4" on-center if nail penetration into the narrow edge is no more than 1 3/8" (to avoid splitting).
- Recommended nailing is 12" on-center in field and 6" on-center along panel edge. Fastening requirements on engineered drawings supersede recommendations listed above.

- Recommended use of a non-polyurethane subfloor adhesive on all contact points between panels and floor framing.
- Nailing rows must be offset at least 1/2" and staggered.
- 14 ga. staples may be substituted for 8d (0.113" x 2 1/2") nails if minimum penetration of 1" into the joist or rim board is achieved.
- Maximum spacing of nails is 18" on-center for joists.

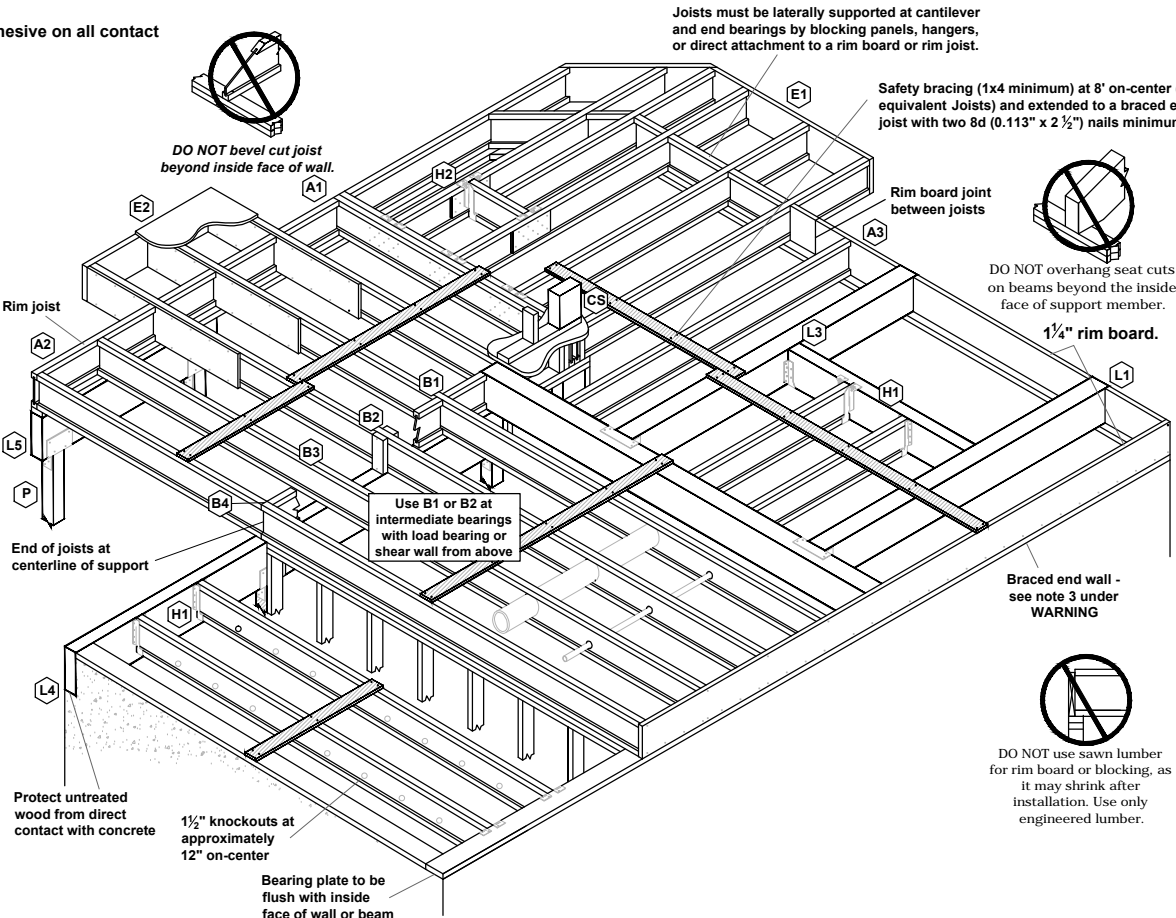

FILLER and BACKER BLOCK SIZES

I-Joists	110 EQ. *		210 EQ. *		230 or 360 EQ. *			560 EQ. *		
	9 1/2" or 11 1/4"	14"	9 1/2" or 11 1/4"	14" or 16"	9 1/2" or 11 1/4"	14" or 16"	18" or 20"	11 1/8" or 14"	14" or 16"	18" or 20"
Depth	2x6	2x8	2x6 + 3/8" sheathing	2x8 + 3/8" sheathing	2x6 + 1/2" sheathing	2x8 + 1/2" sheathing	2x12 + 1/2" sheathing	Two 2x6	Two 2x8	Two 2x12
Filler Block (1) (Detail H2)	2x6	2x10	2x6 + 3/8" sheathing	2x10 + 3/8" sheathing	2x6 + 1/2" sheathing	2x10 + 1/2" sheathing	Not applicable	Not applicable	Not applicable	Not applicable
Cantilever Filler (Detail E4)	4'-0" long	6'-0" long	4'-0" long	6'-0" long	4'-0" long	6'-0" long	Not applicable	Not applicable	Not applicable	Not applicable
Backer Block (1) (Detail F1 or H2)	5/8" or 3/4"	3/4" or 7/8"	1" Net			2x6	2x8	2x12		

(1) If necessary, increase filler and backer block height for face mount hangers and maintain 1/8" gap at top of joist; see detail W. Filler and backer block lengths should accommodate required nailing without splitting (12" minimum for backer blocks and 24" minimum for filler blocks).

Joists must be laterally supported at cantilever and end bearings by blocking panels, hangers, or direct attachment to a rim board or rim joist.

Safety bracing (1x4 minimum) at 8' on-center (6' on-center for 110 or equivalent Joists) and extended to a braced end wall. Fasten at each joist with two 8d (0.113" x 2 1/2") nails minimum (see WARNING).

INSTALLATION TIPS

- Subfloor adhesive will improve floor performance, but may not be required.
- Squash blocks and blocking panels carry stacked vertical loads (details B1 and B2). Packing out the web of a joist (with web stiffeners) is not a substitute for squash blocks or blocking panels.
- When joists are doubled at non-load bearing parallel partitions, space joists apart the width of the wall for plumbing or HVAC.
- Additional joist at plumbing drop (see detail).

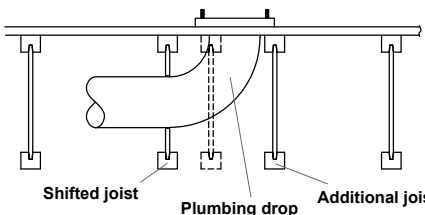

* I-JOIST EQUIVALENCY CHART

Depth	EQUIVALENT IN SPAN AND SPACING		
	Mfrt & Series	Mfrt & Series	Mfrt & Series
9 1/4"	TJI - 110	BCI 4500	
	TJI - 210	BCI 5000	EverEdge 20
	TJI - 230	BCI 6000	EverEdge 20
11 1/8"	TJI - 110	BCI 4500	
	TJI - 210	BCI 5000	EverEdge 20
	TJI - 230	BCI 6000	EverEdge 20
14"	TJI - 360	BCI 6500	EverEdge 30
	TJI - 560	BCI 90'S	EverEdge 50/60
	TJI - 110	BCI 4500	
	TJI - 210	BCI 5000	EverEdge 20
	TJI - 230	BCI 6000	EverEdge 20
	TJI - 360	BCI 60'S	EverEdge 30
16"	TJI - 560	BCI 90'S	EverEdge 50/60
	TJI - 110	BCI 4500	
	TJI - 210	BCI 5000	EverEdge 20
	TJI - 230	BCI 6000	EverEdge 20
	TJI - 360	BCI 60'S	EverEdge 30
	TJI - 560	BCI 90'S	EverEdge 50/60

JOIST NAILING REQUIREMENTS at BEARING

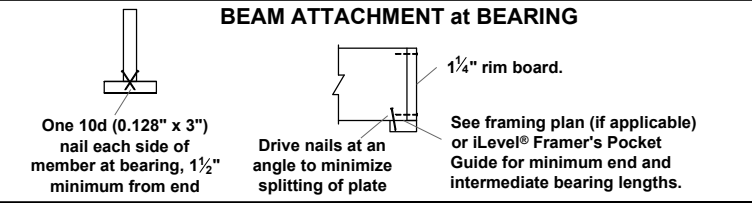
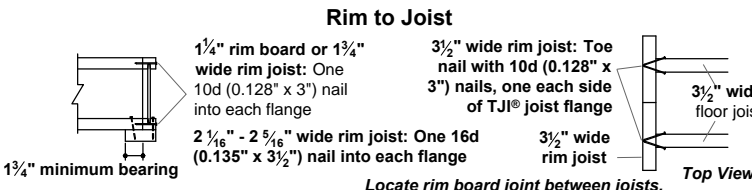
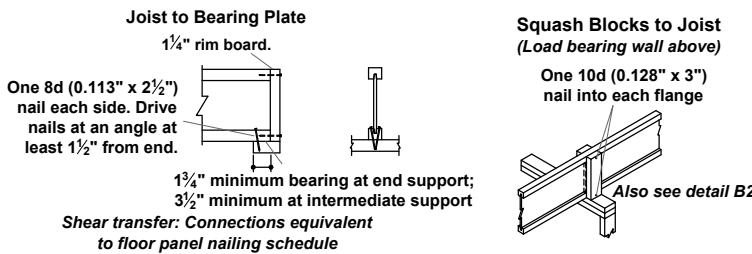

KB HOME
NORTH CAROLINA DIVISION
4518 S. MIAMI BLVD.
SUITE 180
DURHAM, NC 27703
TEL: (919) 768-7988
FAX: (919) 472-0582



P-0961

JDSfaulkner, PLLC HAS PERFORMED A STRUCTURAL REVIEW OF THESE PLANS. THE STRUCTURAL COMPONENTS COMPLY WITH THE 2018 NORTH CAROLINA RESIDENTIAL CODE FOR ONE- AND TWO-FAMILY DWELLINGS FOR NC PLAN REVIEW. DEVIATION OF ANY STRUCTURAL REQUIREMENTS OF THESE PLANS WITHOUT THE APPROVAL OF THE EOR IS PROHIBITED.



PROJECT NO.: 21900377

DATE: 03/01/2021

PLAN:
243.2939

ENGINEERED JOIST
DETAILS
D5.0

These designs and drawings are CONFIDENTIAL, and the exclusive property of KB Home Corporation and are not to be disclosed without the express permission of KB Home Corporation. They may not be used or duplicated without the express permission of KB Home Corporation. Copyright 2019 © KB Home Corporation. All rights reserved.