

WAYFARE H&H HOMES

PLAN REVISIONS

REVISIONS CONTINUED.

12-23-19 REMOVED GLASS INSERTS AND REMOVED ACCENTS FROM GARAGE DOOR FOR H&H STANDARDS.
CHANGE FIREPLACE FROM STD TO OPTIONAL.
VERIFY GOURMET KITCHEN LAYOUT WITH DBL OVEN OPTION.
REMOVE KITCHEN, BATHROOM, AND LAUNDRY FLOOR HATCHING FROM PLANS.

02-18-20 UPDATED DIMENSIONS FOR PAD AND PATIO.
CHANGED WASHER, DRYER, AND REFRIGERATOR TO OPTIONAL COMPONENTS.
CREATED CUTSHEETS.
CHANGE LOCATIONS OF HOSE BIBBS TO BE ON HEATED WALLS.
VERIFY HDR HGTS ARE AT LEAST 1'-0".
VERIFIED MASTERS WAS CHANGED TO OWNER'S.
CHANGED 2X4 WALL AT REAR GARAGE WALL TO 2X6.
REMOVED FLOOD LIGHTS AND SWITCHES/WIRING AT REAR.
VERIFIED ALL LOCATION FOR COACH LIGHTS WERE MARKED W/ SWITCHES.
ADDED ROOF VENT CALCULATIONS.
ADDED THERMOSTAT TO FIRST FLOOR ELECTRICAL PLAN.
DIMENSIONS CEILING FAN IN GATHERING ROOM ON ELECTRICAL PLAN.
UPDATED FOR NC RC 2018 AND SC IRC 2018.
VERIFIED VENTILATION REQMTS AT OWNER'S BEDROOM.
ADDED INSULATION INFORMATION ON PLANS.

SQUARE FOOTAGE	
	ELEV 'A'
HEATED AREAS	
MAIN FLOOR	959 SQ. FT.
UPPER FLOOR	1318 SQ. FT.
TOTAL HEATED SF	2277 SQ. FT.
UNHEATED AREAS	
2-CAR GARAGE	413 SQ. FT.
COVERED AREAS	
FRONT PORCH	60 SQ. FT.
UNCOVERED AREAS	
PAD	16 SQ. FT.
PAD W/ OPT BEDR. 4 W/ BATH 3	9 SQ. FT.
HEATED OPTIONS	
OPT BEDRM. 4 W/ BATH 3	0 SQ. FT.
OPTIONAL BEDRM. 5 I.L.O. LOFT	0 SQ. FT.
UNHEATED OPTIONS	
OPTIONAL 1-CAR GARAGE	240 SQ. FT.

SQUARE FOOTAGE	
	ELEV 'C'
HEATED AREAS	
MAIN FLOOR	959 SQ. FT.
UPPER FLOOR	1314 SQ. FT.
TOTAL HEATED SF	2274 SQ. FT.
UNHEATED AREAS	
2-CAR GARAGE	413 SQ. FT.
COVERED AREAS	
FRONT PORCH	60 SQ. FT.
UNCOVERED AREAS	
PAD	16 SQ. FT.
PAD W/ OPT BEDR. 4 W/ BATH 3	9 SQ. FT.
HEATED OPTIONS	
OPT BEDRM. 4 W/ BATH 3	0 SQ. FT.
OPTIONAL BEDRM. 5 I.L.O. LOFT	0 SQ. FT.
UNHEATED OPTIONS	
OPTIONAL 1-CAR GARAGE	240 SQ. FT.

OFV000048

Inventory Marked

ISSUANCE OF PLANS FROM THIS DRAFTER'S OFFICE SHALL NOT RELIEVE THE BUILDER OF RESPONSIBILITY TO REVIEW AND VERIFY ALL NOTES, DIMENSIONS, AND ADHERENCE TO APPLICABLE BUILDING CODES PRIOR TO COMMENCEMENT OF ANY CONSTRUCTION.
ANY DISCREPANCY OF ERROR IN NOTES, DIMENSIONS, OR ADHERENCE TO APPLICABLE BUILDING CODES SHALL BE BROUGHT TO THE ATTENTION OF THE DRAFTER'S OFFICE FOR CORRECTION BEFORE COMMENCEMENT OF ANY CONSTRUCTION.
ANY REVISIONS OR CHANGES NOT RELATED TO THE CORRECTION OF ERRORS THAT ARE MADE AFTER THE FINAL PLANS HAVE BEEN COMPLETED SHALL BE SUBJECT TO ADDITIONAL FEES.
IF ANY MODIFICATIONS ARE MADE TO THESE PLANS BY ANY OTHER PARTY OTHER THAN THE DRAFTER'S OFFICE, THE DRAFTER SHALL NOT BE HELD RESPONSIBLE.

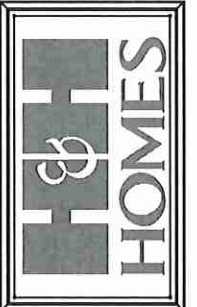

JOB NUMBER	27167.07
CAD FILE NAME	WAYFARE-R
ISSUED	11-08-17
REVISED	11-16-17
	02-18-20

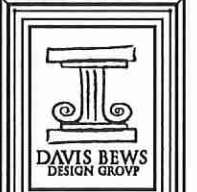

850 STATE STREET SUITE 200
OLDFIELD, FLORIDA 34677
888-925-1800 TEL
888-925-1800 FAX
WWW.DAVISBEWS.COM
TAMPA • DENVER
EST. 1994

DRAWINGS ON 11"x17" SHEET ARE ONE HALF THE SCALE NOTED

WAYFARE (Garage Right)
H&H HOMES

2277

TITLE
REVISION LOG

SHEET
CS

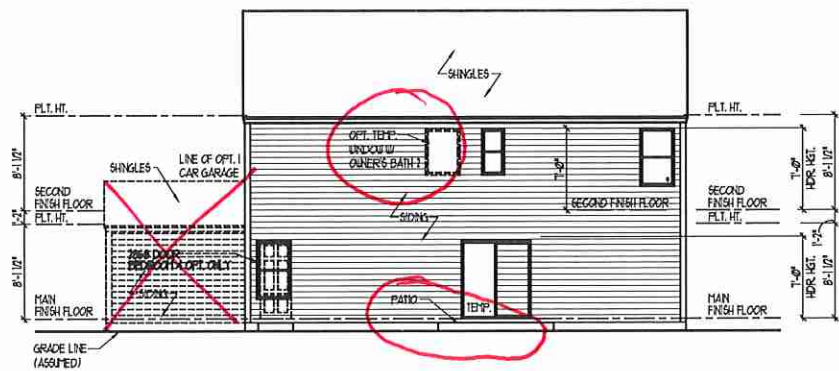

REAR ELEVATION
SCALE: 1/8" = 1'-0"

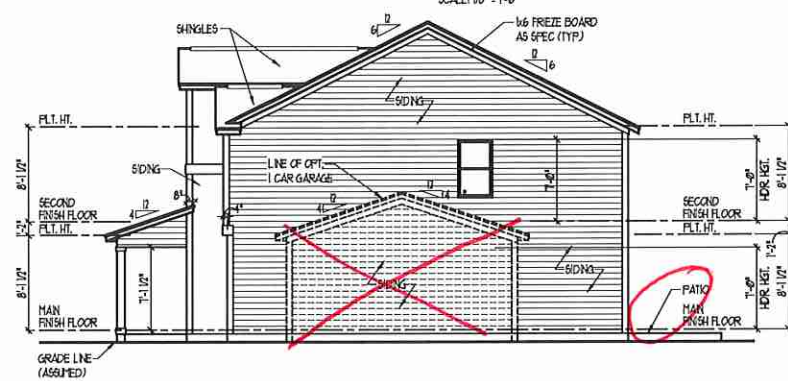

RIGHT ELEVATION
SCALE: 1/8" = 1'-0"

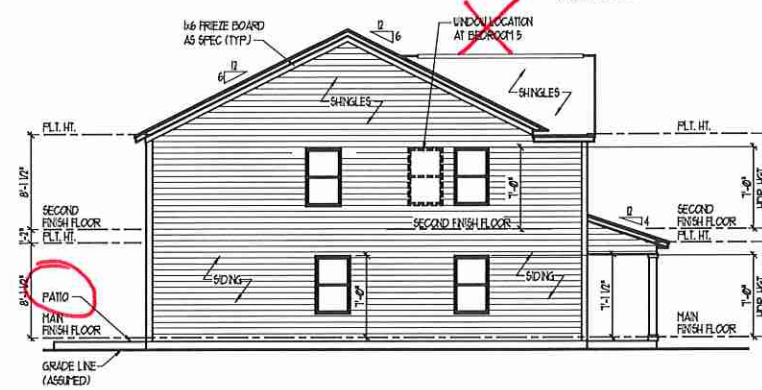

LEFT ELEVATION
SCALE: 1/8" = 1'-0"

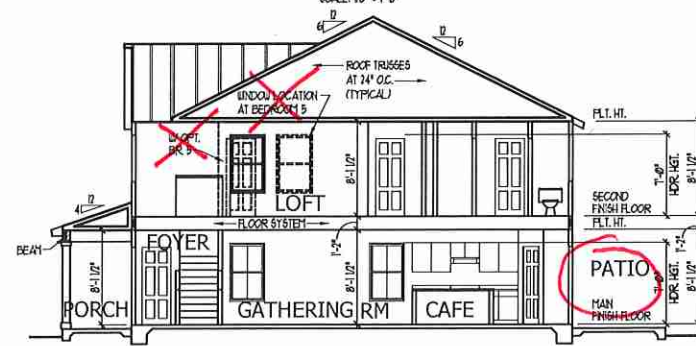

SECTION AA
SCALE: 1/8" = 1'-0"



FRONT ELEVATION
SCALE: 1/4" = 1'-0"

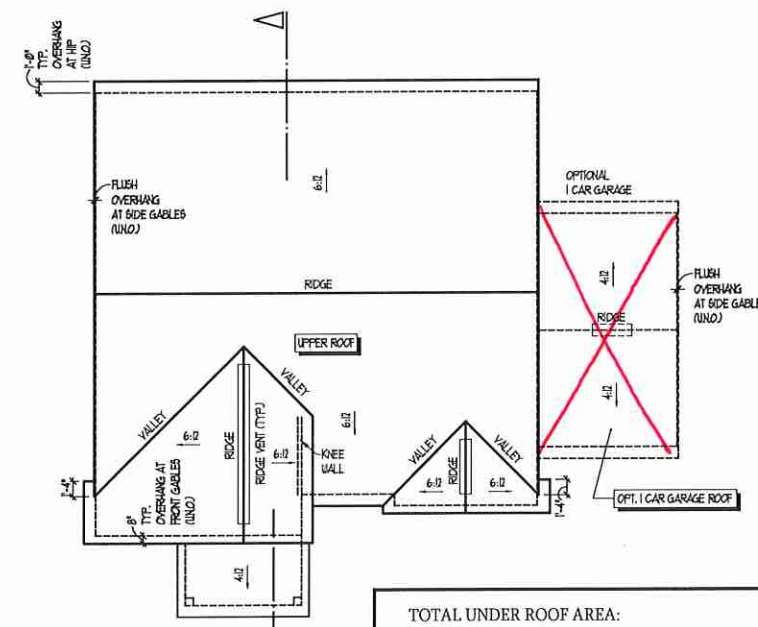

ROOF PLAN
SCALE: 1/8" = 1'-0"

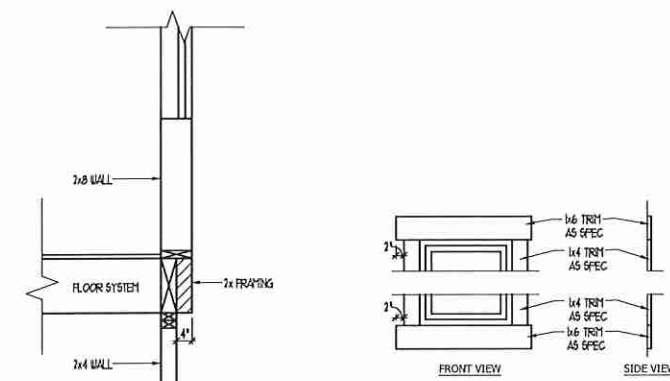

CANTILEVER DETAIL 1
SCALE: 1/2" = 1'-0"

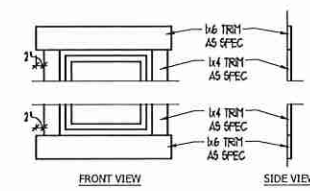

TRIM DETAIL
SCALE: NTS

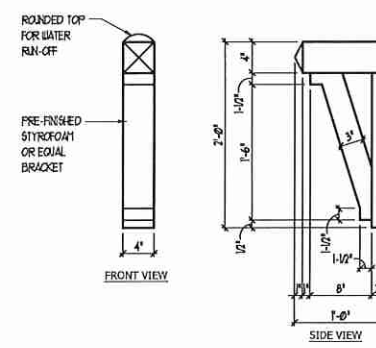

BRACKET DETAIL
SCALE: 1" = 1'-0"

TOTAL UNDER ROOF AREA:	1376	SQ. FT.	1376	SQ. FT.
VENTING AREA REQUIRED:	1376 SQ. FT. / 300 =	4.59	SQ. FT.	
TOTAL REQUIREMENTS:	LOWER: 2.29	UPPER: 2.29		
LOWER AREA VENTING				
SOFFIT VENT	SIZE:	PER UNIT:	# UNITS:	PROVIDED:
	-	.041 SF/LF	76'-0"	3.1
LOWER AREA VENTING PROVIDED:				
UPPER AREA VENTING				
RIDGE VENT	SIZE:	PER UNIT:	# UNITS:	PROVIDED:
	-	.125 SF/LF	32'-0"	4.0
UPPER AREA VENTING PROVIDED:				
TOTAL AREA PROVIDED				
SOFFIT AND RIDGE VENT				7.1

ISSUANCE OF PLANS FROM THIS DRAFTER'S OFFICE SHALL NOT RELIEVE THE BUILDER OF RESPONSIBILITY TO REVIEW AND VERIFY ALL NOTES, DIMENSIONS, AND ADHERENCE TO APPLICABLE BUILDING CODES PRIOR TO COMMENCEMENT OF ANY CONSTRUCTION. ANY DISCREPANCY OF ERROR IN NOTES, DIMENSIONS, OR ADHERENCE TO APPLICABLE BUILDING CODES SHALL BE BROUGHT TO THE ATTENTION OF THE DRAFTER'S OFFICE FOR CORRECTION BEFORE COMMENCEMENT OF ANY CONSTRUCTION. ANY REVISIONS OR CHANGES, NOT RELATED TO THE CORRECTION OF ERRORS THAT ARE MADE AFTER THE FINAL PLANS HAVE BEEN COMPLETED SHALL BE SUBJECT TO ADDITIONAL FEES. IF ANY MODIFICATIONS ARE MADE TO THESE PLANS BY ANY OTHER PARTY OTHER THAN THE DRAFTER'S OFFICE, THE DRAFTER SHALL NOT BE HELD RESPONSIBLE.

ELEVATION "C" - MODERN GARAGE RIGHT

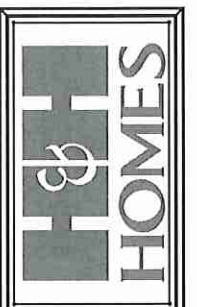

JOB NUMBER	27167.07
CAD FILE NAME	WAYFARE-R
ISSUED	11-09-17
REVISED	11-16-17
	02-18-20



150 STATE STREET EAST
CLEARWATER, FLORIDA 34677
888-928-1300 TEL
888-928-1300 FAX
WWW.DAVISBEWS.COM
TAMPA • DENVER
EST. 1994

DRAWINGS ON 11"x17" SHEET ARE ONE HALF THE SCALE NOTED

WAYFARE (Garage Right)
H&H HOMES

2277

TITLE
FRONT ELEVATION DETAILS
PARTIAL UPPER FLOOR PLAN
AT ELEV. "C"

SHEET
A5.0

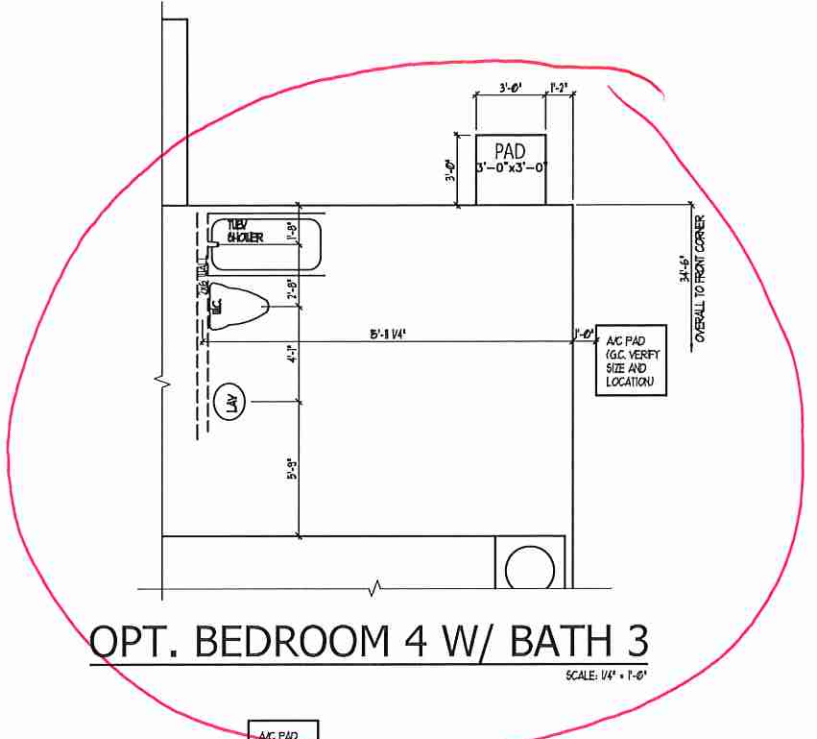

OPT. BEDROOM 4 W/ BATH 3
SCALE: 1/4" = 1'-0"

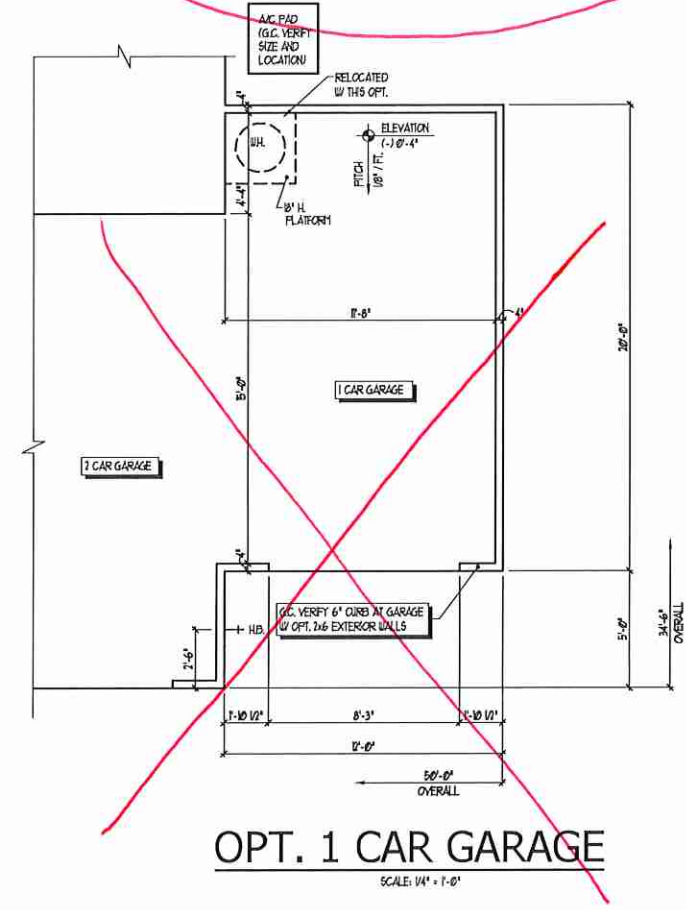

OPT. 1 CAR GARAGE
SCALE: 1/4" = 1'-0"

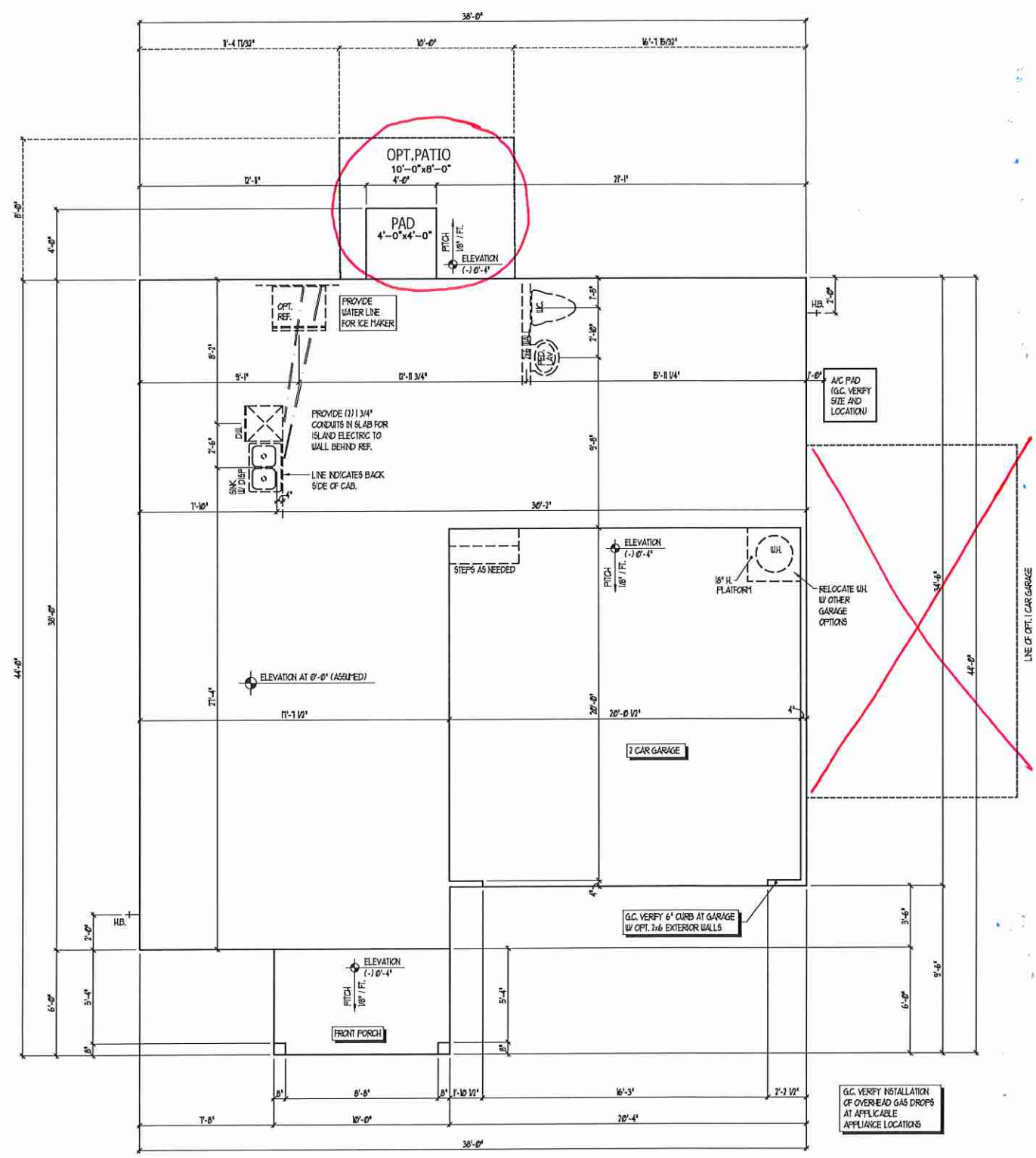

SLAB INTERFACE PLAN
SCALE: 1/4" = 1'-0"
GARAGE RIGHT

ISSUANCE OF PLANS FROM THIS DRAFTER'S OFFICE SHALL NOT RELIEVE THE BUILDER OF RESPONSIBILITY TO REVIEW AND VERIFY ALL NOTES, DIMENSIONS, AND ADHERENCE TO APPLICABLE BUILDING CODES PRIOR TO COMMENCEMENT OF ANY CONSTRUCTION.
 ANY DISCREPANCY OF ERROR IN NOTES, DIMENSIONS, OR ADHERENCE TO APPLICABLE BUILDING CODES SHALL BE BROUGHT TO THE ATTENTION OF THE DRAFTER'S OFFICE FOR CORRECTION BEFORE COMMENCEMENT OF ANY CONSTRUCTION.
 ANY REVISIONS OR CHANGES NOT RELATED TO THE CORRECTION OF ERRORS THAT ARE MADE AFTER THE FINAL PLANS HAVE BEEN COMPLETED SHALL BE SUBJECT TO ADDITIONAL FEES.
 IF ANY MODIFICATIONS ARE MADE TO THESE PLANS BY ANY OTHER PARTY OTHER THAN THE DRAFTER'S OFFICE, THE DRAFTER SHALL NOT BE HELD RESPONSIBLE.

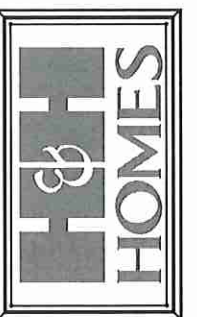

JOB NUMBER	27167.07
CAD FILE NAME	WAYFARE-R
ISSUED	11-08-17
REVISED	11-16-17
	02-18-20



DRAWINGS ON 11"x17" SHEET ARE ONE HALF THE SCALE NOTED

WAYFARE (Garage Right)
H&H HOMES

2277

TITLE
SLAB INTERFACE PLAN

SHEET
A1.0

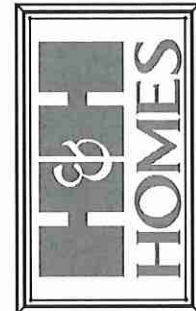

JOB NUMBER	27167.07
CAD FILE NAME	WAYFARE-R
ISSUED	11-08-17
REVISED	11-18-17
	02-18-20



890 STATE STREET EAST
CLEWIS, FLORIDA 33577
888-928-1800 TEL
888-928-1800 FAX
WWW.DAVISBEWS.COM
TAMPA • DENVER
EST. 1994

DRAWINGS ON 11"x17" SHEET ARE ONE HALF THE SCALE NOTED

WAYFARE (Garage Right)
H&H HOMES

2277

TITLE
UPPER FLOOR PLAN

SHEET
A2.1

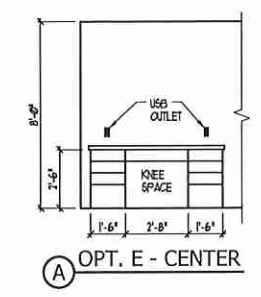
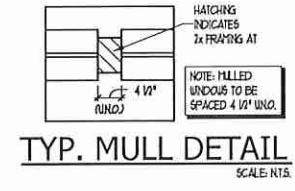
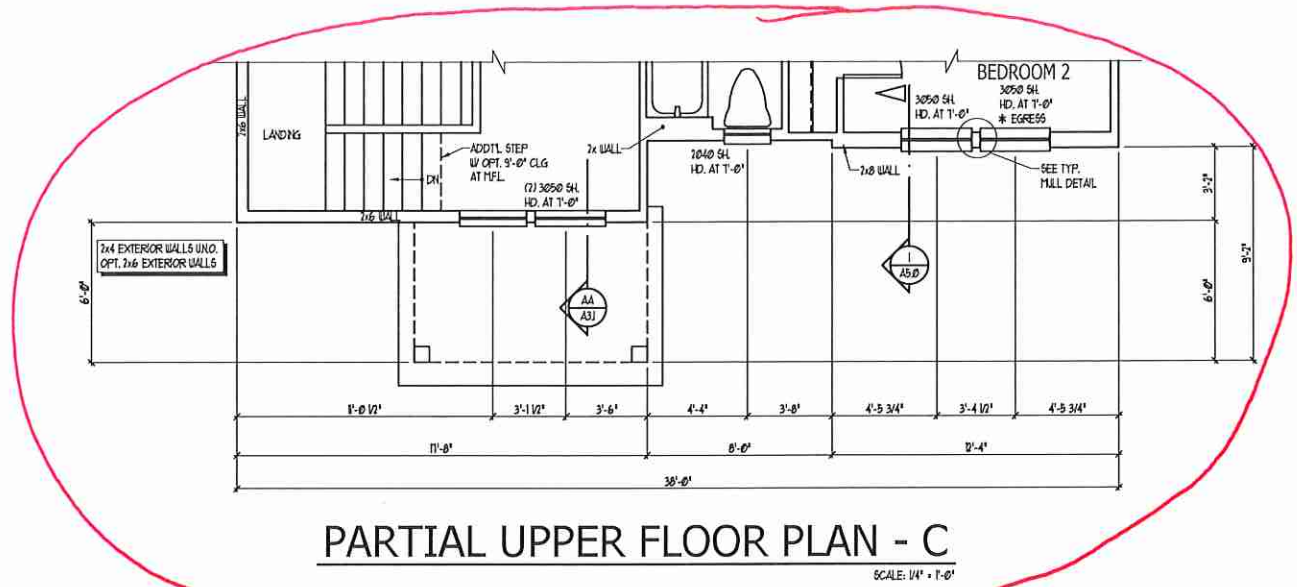

OWNERS BATH #2

SQUARE FOOTAGE

HEATED AREAS	ELEV 'C'
MAIN FLOOR	959 SQ. FT.
UPPER FLOOR	1314 SQ. FT.
TOTAL HEATED SF	2274 SQ. FT.
UNHEATED AREAS	
2-CAR GARAGE	413 SQ. FT.
COVERED AREAS	
FRONT PORCH	60 SQ. FT.
UNCOVERED AREAS	
PAD	16 SQ. FT.
PAD W/ OPT BEDR. 4 W/ BATH 3	9 SQ. FT.
HEATED OPTIONS	
OPT BEDRM. 4 W/ BATH 3	0 SQ. FT.
OPTIONAL BEDRM. 5 I.L.O. LOFT	0 SQ. FT.
UNHEATED OPTIONS	
OPTIONAL 1-CAR GARAGE	240 SQ. FT.

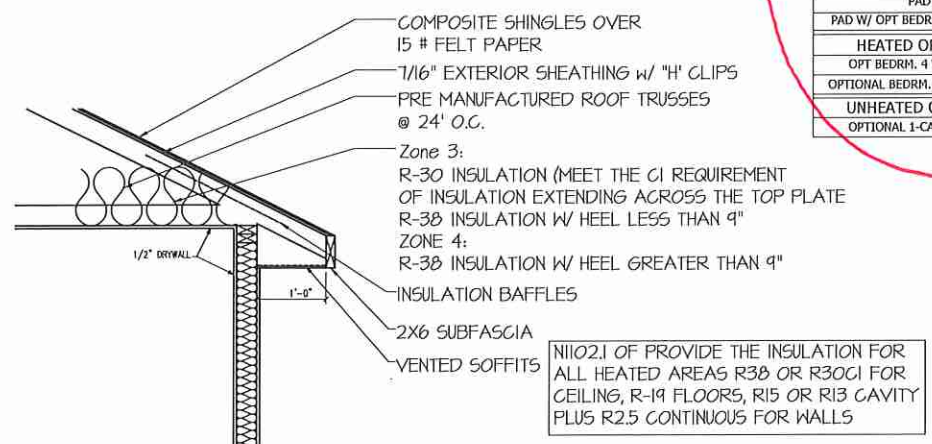
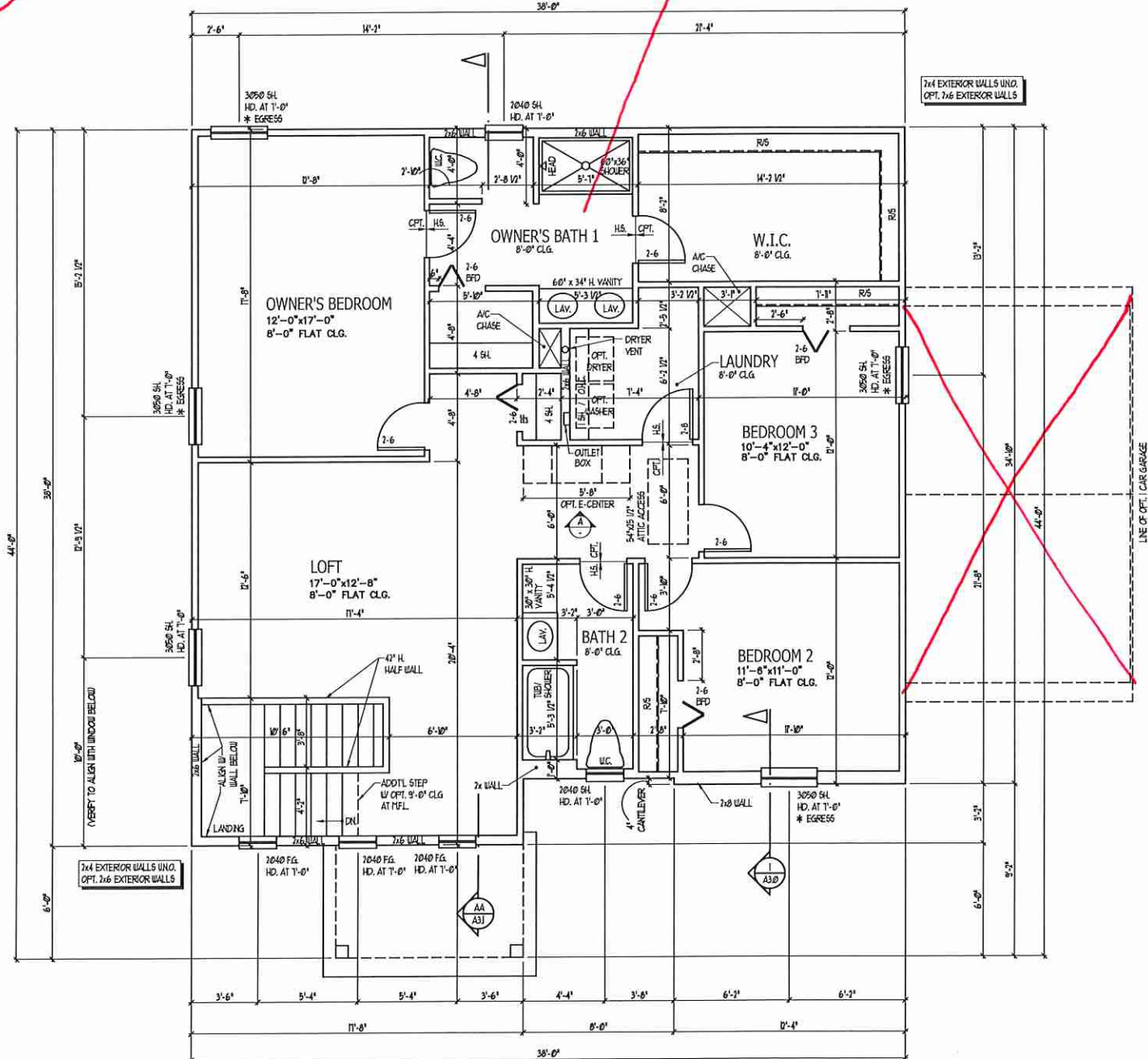

COMPOSITE SHINGLES OVER
15 # FELT PAPER
7/16" EXTERIOR SHEATHING W/ 1" CLIPS
PRE MANUFACTURED ROOF TRUSSES
@ 24" O.C.
Zone 3:
R-30 INSULATION (MEET THE C1 REQUIREMENT
OF INSULATION EXTENDING ACROSS THE TOP PLATE
R-38 INSULATION W HEEL LESS THAN 4"
ZONE 4:
R-38 INSULATION W HEEL GREATER THAN 4"
INSULATION BAFFLES
2X6 SUBFASCIA
VENTED SOFFITS
N1102.1 OF PROVIDE THE INSULATION FOR
ALL HEATED AREAS R38 OR R30C1 FOR
CEILING, R-19 FLOORS, R15 OR R13 CAVITY
PLUS R2.5 CONTINUOUS FOR WALLS
A WATER RESISTIVE BARRIER MEETING THE
REQUIREMENTS OF THE LATEST NORTH CAROLINA
RESIDENTIAL BUILDING CODE MUST BE INSTALLED
OVER ANY EXTERIOR SHEATHING THAT DOES NOT
ALREADY MEET WATER RESISTIVE REQUIREMENTS.
Zone 3 or Zone 4:
R-15 INSULATION OR
R-13 CAVITY INSULATION + R-2.5 CI

ISSUANCE OF PLANS FROM THIS DRAFTER'S OFFICE SHALL NOT RELIEVE THE BUILDER OF RESPONSIBILITY TO REVIEW AND VERIFY ALL NOTES, DIMENSIONS, AND ADHERENCE TO APPLICABLE BUILDING CODES PRIOR TO COMMENCEMENT OF ANY CONSTRUCTION.
ANY DISCREPANCY OF ERROR IN NOTES, DIMENSIONS, OR ADHERENCE TO APPLICABLE BUILDING CODES SHALL BE BROUGHT TO THE ATTENTION OF THE DRAFTER'S OFFICE FOR CORRECTION BEFORE COMMENCEMENT OF ANY CONSTRUCTION.
ANY REVISIONS OR CHANGES, NOT RELATED TO THE CORRECTION OF ERRORS THAT ARE MADE AFTER THE FINAL PLANS HAVE BEEN COMPLETED SHALL BE SUBJECT TO ADDITIONAL FEES.
IF ANY MODIFICATIONS ARE MADE TO THESE PLANS BY ANY OTHER PARTY OTHER THAN THE DRAFTER'S OFFICE, THE DRAFTER SHALL NOT BE HELD RESPONSIBLE.

UPPER FLOOR PLAN
SCALE: 1/4" = 1'-0"
GARAGE RIGHT

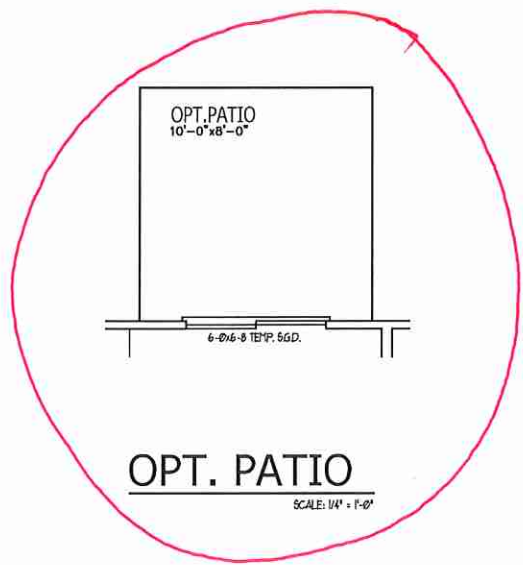

OPT. PATIO
SCALE: 1/4" = 1'-0"

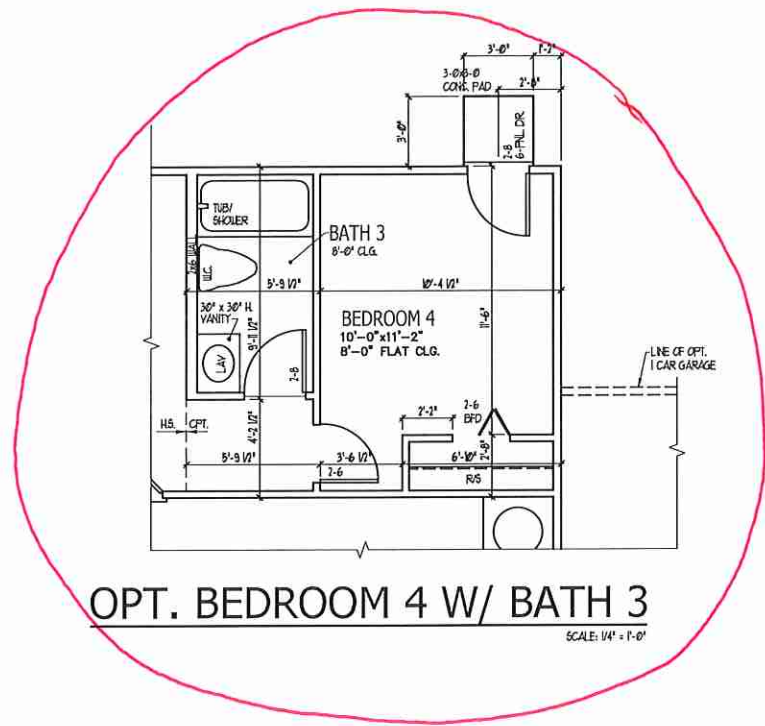

OPT. BEDROOM 4 W/ BATH 3
SCALE: 1/4" = 1'-0"



OPT. OWNER'S BATH 3
SCALE: 1/4" = 1'-0"

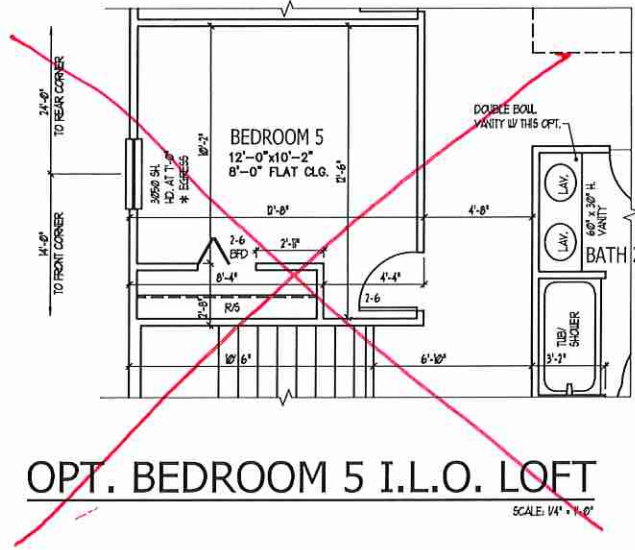

OPT. BEDROOM 5 I.L.O. LOFT
SCALE: 1/4" = 1'-0"

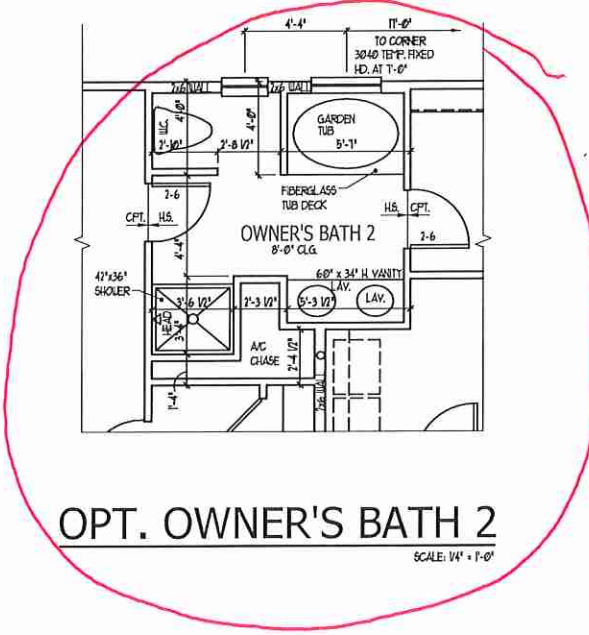

OPT. OWNER'S BATH 2
SCALE: 1/4" = 1'-0"

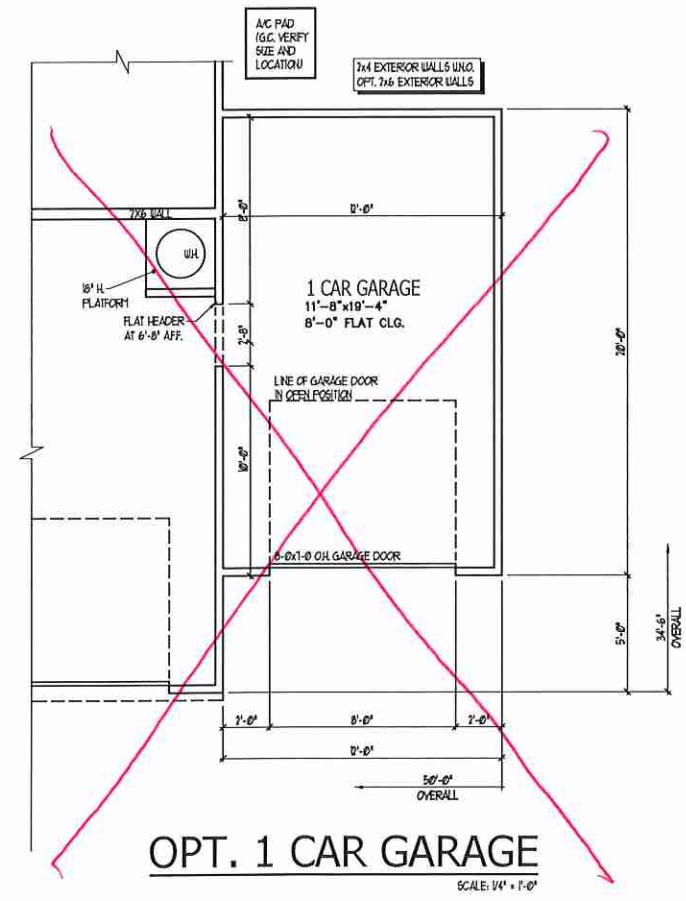

OPT. 1 CAR GARAGE
SCALE: 1/4" = 1'-0"

ISSUANCE OF PLANS FROM THIS DRAFTER'S OFFICE SHALL NOT RELIEVE THE BUILDER OF RESPONSIBILITY TO REVIEW AND VERIFY ALL NOTES, DIMENSIONS, AND ADHERENCE TO APPLICABLE BUILDING CODES PRIOR TO COMMENCEMENT OF ANY CONSTRUCTION.
 ANY DISCREPANCY OF ERROR IN NOTES, DIMENSIONS, OR ADHERENCE TO APPLICABLE BUILDING CODES SHALL BE BROUGHT TO THE ATTENTION OF THE DRAFTER'S OFFICE FOR CORRECTION BEFORE COMMENCEMENT OF ANY CONSTRUCTION.
 ANY REVISIONS OR CHANGES NOT RELATED TO THE CORRECTION OF ERRORS THAT ARE MADE AFTER THE FINAL PLANS HAVE BEEN COMPLETED SHALL BE SUBJECT TO ADDITIONAL FEES.
 IF ANY MODIFICATIONS ARE MADE TO THESE PLANS BY ANY OTHER PARTY OTHER THAN THE DRAFTER'S OFFICE, THE DRAFTER SHALL NOT BE HELD RESPONSIBLE.

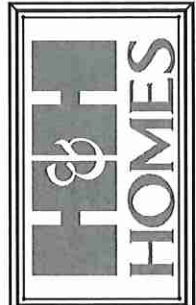

JOB NUMBER	27167.07
CAD FILE NAME	WAYFARE-R
ISSUED	11-08-17
REVISED	11-18-17
	02-18-20

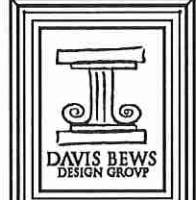

180 BEAVER STREET EAST
 CLEMATON, MICHIGAN 48837
 813 - 923 - 1800 TEL
 813 - 923 - 1800 FAX
 WWW.DAVISBEWS.COM
 TAMPA • DENVER
 EST. 1996

DRAWINGS ON 11"x17" SHEET ARE ONE HALF THE SCALE NOTED

WAYFARE (Garage Right)
H&H HOMES

2277

TITLE
 PLAN OPTIONS

SHEET
A2.2

REFER TO STANDARD PLAN FOR INFORMATION NOT SHOWN.
PLAN OPTIONS
 GARAGE RIGHT

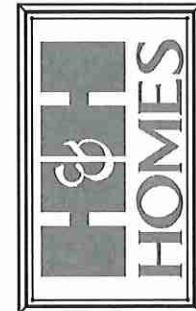

JOB NUMBER	27167.07
CAD FILE NAME	WAYFARE-R
ISSUED	11-08-17
REVISED	11-18-17
	02-18-20



190 STATE STREET SUITE 200
 CLEARWATER, FLORIDA 34617
 813-925-1800 TEL
 813-925-1800 FAX
 WWW.DAVISBEWS.COM
 TAMPA • DENVER
 EST. 1994

DRAWINGS ON 11"x17" SHEET ARE ONE HALF THE SCALE NOTED

WAYFARE (Garage Right)
 H&H HOMES

2277

TITLE
 MAIN FLOOR ELEC. PLAN

SHEET
E1

ELECTRICAL KEY

- ⊕ DUPLEX CONVENIENCE OUTLET
- ⊕ DUPLEX OUTLET ABOVE COUNTER
- ⊕ WEATHER-PROOF DUPLEX OUTLET
- ⊕ GROUND FAULT INTERRUPTER DUPLEX OUTLET
- ⊕ HALF-SWITCHED DUPLEX OUTLET
- ⊕ SPECIAL PURPOSE OUTLET
- ⊕ DUPLEX OUTLET IN FLOOR
- ⊕ 220 VOLT OUTLET
- ⊕ WALL SWITCH
- ⊕ THREE-WAY SWITCH
- ⊕ FOUR-WAY SWITCH
- ⊕ DIMMER SWITCH
- ⊕ CEILING MOUNTED INCANDESCENT LIGHT FIXTURE
- ⊕ WALL MOUNTED INCANDESCENT LIGHT FIXTURE
- ⊕ RECESSED INCANDESCENT LIGHT FIXTURE
- ⊕ LIGHT FIXTURE WITH FULL CHAIN
- ⊕ TRACK LIGHT
- ⊕ FLUORESCENT LIGHT FIXTURE
- ⊕ EXHAUST FAN
- ⊕ EXHAUST FAN/LIGHT COMBINATION
- ⊕ ELECTRIC DOOR OPERATOR (OPTIONAL)
- ⊕ CHIMNEY (OPTIONAL)
- ⊕ FURNITURE SWITCH (OPTIONAL)
- ⊕ CARBON MONOXIDE DETECTOR
- ⊕ SMOKE DETECTOR
- ⊕ SMOKE / CARBON MON. COMBO DETECTOR
- ⊕ TELEPHONE (OPTIONAL)
- ⊕ TELEVISION (OPTIONAL)
- ⊕ THERMOSTAT
- ⊕ ELECTRIC METER
- ⊕ ELECTRIC PANEL
- ⊕ DISCONNECT SWITCH
- ⊕ SPEAKER (OPTIONAL)
- ⊕ ROUGH-IN FOR OPT. CEILING FAN
- ⊕ CEILING MOUNTED INCANDESCENT LIGHT FIXTURE W/ ROUGH-IN FOR OPT. CEILING FAN

- NOTES:**
- PROVIDE AND INSTALL GROUND FAULT CIRCUIT INTERRUPTERS (GFCI) AS INDICATED ON PLANS OR AS ITEM NO. 4 AND 5 BELOW INDICATED.
 - UNLESS OTHERWISE INDICATED, INSTALL SWITCHES AND RECEPTACLES AT THE FOLLOWING HEIGHTS ABOVE FINISHED FLOOR:
 SWITCHES... 48"
 OUTLETS... 18"
 TELEPHONE... 48" (UNLESS ADV. COUNTERTOP)
 TELEVISION... 48"
 - ALL SMOKE DETECTORS SHALL BE HARDWIRED INTO AN ELECTRICAL POWER SOURCE AND SHALL BE EQUIPPED WITH A MONITORED BATTERY BACKUP. PROVIDE AND INSTALL LOCALLY CERTIFIED SMOKE DETECTORS.
 - ALL 120V AND 240V RECEPTACLES IN SLEEPING ROOMS, FAMILY ROOMS, DINING ROOMS, LIVING ROOMS, PAVILIONS, LIBRARIES, DEN'S, SUNROOMS, RECREATION ROOMS, CLOSETS, HALLWAYS, AND SIMILAR AREAS SHALL REQUIRE A COMBINATION TYPE AFCI DEVICE AND TAMPER-PROOF RECEPTACLES PER NEC 201.406(D) AND 406(B).
 - ALL 120V AND 240V RECEPTACLES LOCATED IN THE GARAGE AND UTILITY ROOMS SHALL BE GFCI PROTECTED (GFI).
 - IT IS THE RESPONSIBILITY OF THE LICENSED ELECTRICIAN TO ENSURE THAT ALL ELECTRICAL WORK IS IN FULL COMPLIANCE WITH NFPA 70, NEC 2018, AND ALL APPLICABLE LOCAL STANDARDS, CODES, AND ORDINANCES.
 - EVERY BUILDING HAVING A FOSOL-FUEL-BURNING HEATER OR APPLIANCE, FIREPLACE, OR AN ATTACHED GARAGE SHALL HAVE AN OPERATIONAL CARBON MONOXIDE DETECTOR INSTALLED WITHIN 10 FEET OF EACH ROOM USED FOR SLEEPING PURPOSES.
 - ALARMS SHALL RECEIVE THEIR PRIMARY POWER FROM THE BUILDING WIRING WHEN SUCH WIRING IS SERVED FROM THE LOCAL POWER UTILITY. SUCH ALARMS SHALL HAVE BATTERY BACKUP. COMBINATION SMOKE/CARBON MONOXIDE ALARMS SHALL BE LISTED OR LABELED BY A NATIONALLY RECOGNIZED TESTING LABORATORY.

ISSUANCE OF PLANS FROM THIS DRAFTER'S OFFICE SHALL NOT RELIEVE THE BUILDER OF RESPONSIBILITY TO REVIEW AND VERIFY ALL NOTES, DIMENSIONS, AND ADHERENCE TO APPLICABLE BUILDING CODES PRIOR TO COMMENCEMENT OF ANY CONSTRUCTION.
 ANY DISCREPANCY OF ERROR IN NOTES, DIMENSIONS, OR ADHERENCE TO APPLICABLE BUILDING CODES SHALL BE BROUGHT TO THE ATTENTION OF THE DRAFTER'S OFFICE FOR CORRECTION BEFORE COMMENCEMENT OF ANY CONSTRUCTION.
 ANY REVISIONS OR CHANGES, NOT RELATED TO THE CORRECTION OF ERRORS THAT ARE MADE AFTER THE FINAL PLANS HAVE BEEN COMPLETED SHALL BE SUBJECT TO ADDITIONAL FEES.
 IF ANY MODIFICATIONS ARE MADE TO THESE PLANS BY ANY OTHER PARTY OTHER THAN THE DRAFTER'S OFFICE, THE DRAFTER SHALL NOT BE HELD RESPONSIBLE.

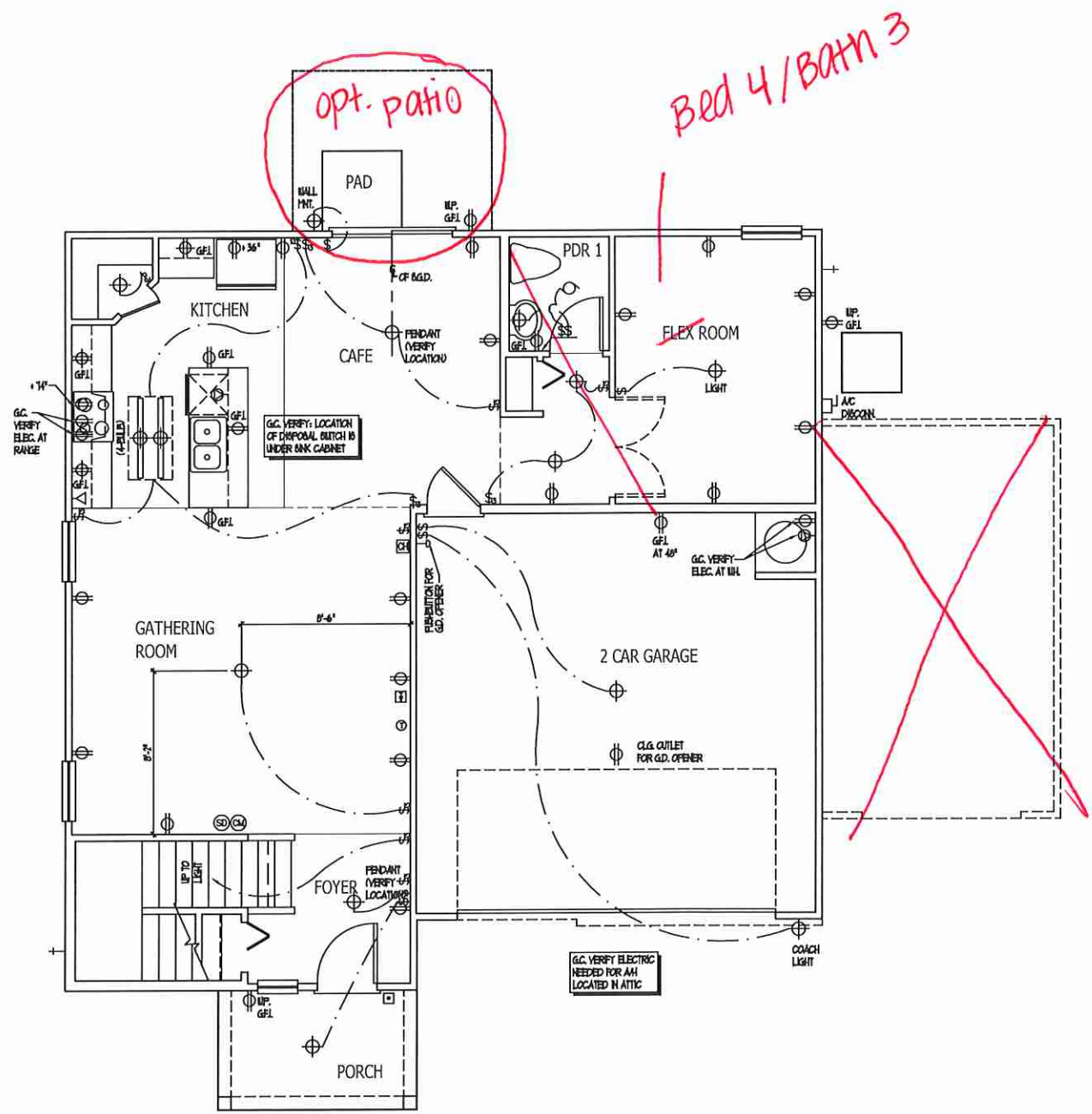

MAIN FLOOR ELECTRICAL PLAN
 GARAGE RIGHT

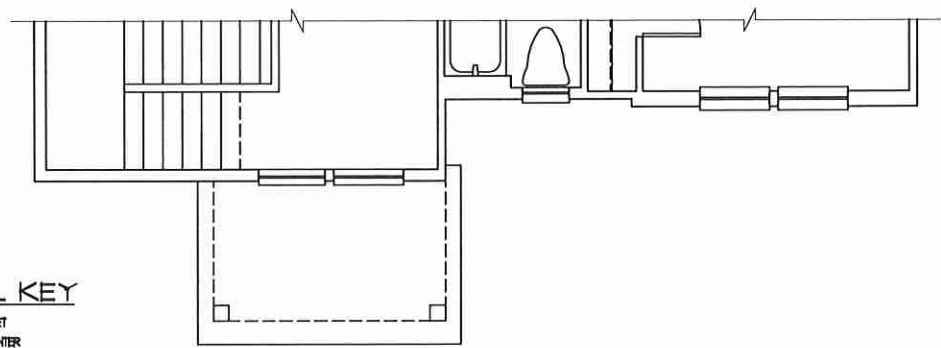

ELECTRICAL KEY

- ⊕ DUPLEX CONVENIENCE OUTLET
- ⊕ DUPLEX OUTLET ABOVE COUNTER
- ⊕ NEAR-PROOF DUPLEX OUTLET
- ⊕ GROUND FAULT INTERRUPTER DUPLEX OUTLET
- ⊕ HALF-SWITCHED DUPLEX OUTLET
- ⊕ SPECIAL PURPOSE OUTLET
- ⊕ DUPLEX OUTLET IN FLOOR
- ⊕ 200 VOLT OUTLET
- ⊕ WALL SWITCH
- ⊕ THREE-WAY SWITCH
- ⊕ FOUR-WAY SWITCH
- ⊕ DIMMER SWITCH
- ⊕ CEILING MOUNTED INCANDESCENT LIGHT FIXTURE
- ⊕ WALL MOUNTED INCANDESCENT LIGHT FIXTURE
- ⊕ RECESSED INCANDESCENT LIGHT FIXTURE
- ⊕ LIGHT FIXTURE WITH FULL CHAIN
- ⊕ TRACK LIGHT
- ⊕ FLUORESCENT LIGHT FIXTURE
- ⊕ EXHAUST FAN
- ⊕ EXHAUST FAN/LIGHT COMBINATION
- ⊕ ELECTRIC DOOR OPERATOR (OPTIONAL)
- ⊕ GFI (OPTIONAL)
- ⊕ PUSHBUTTON SWITCH (OPTIONAL)
- ⊕ CARBON MONOXIDE DETECTOR
- ⊕ SMOKE DETECTOR
- ⊕ SMOKE / CARBON MONOXIDE COMBO DETECTOR
- ⊕ TELEPHONE (OPTIONAL)
- ⊕ TELEVISION (OPTIONAL)
- ⊕ THERMOSTAT
- ⊕ ELECTRIC METER
- ⊕ ELECTRIC PANEL
- ⊕ DISCONNECT SWITCH
- ⊕ SPEAKER (OPTIONAL)
- ⊕ ROUGH-IN FOR OPT. CEILING FAN
- ⊕ CEILING MOUNTED INCANDESCENT LIGHT FIXTURE W/ ROUGH-IN FOR OPT. CEILING FAN

NOTES:

1. PROVIDE AND INSTALL GROUND FAULT CIRCUIT INTERRUPTERS (GFI) AS INDICATED ON PLANS OR AS ITEM NO. 4 AND 5 BELOW INDICATED.
2. UNLESS OTHERWISE INDICATED, INSTALL SWITCHES AND RECEPTACLES AT THE FOLLOWING HEIGHTS ABOVE FINISHED FLOOR:
 SWITCHES... 48"
 OUTLETS... 48"
 TELEPHONE... 48" (UNLESS ABOV. COUNTERTOP)
 TELEVISION... 48"
3. ALL SMOKE DETECTORS SHALL BE HARDWIRED INTO AN ELECTRICAL POWER SOURCE AND SHALL BE EQUIPPED WITH A MONITORED BATTERY BACKUP. PROVIDE AND INSTALL LOCALLY CERTIFIED BECKE DETECTORS.
4. ALL 15A AND 20A RECEPTACLES IN SLEEPING ROOMS, FAMILY ROOMS, DINING ROOMS, LIVING ROOMS, PARLORS, LIBRARIES, DEN, BARRIOCA, RECREATION ROOMS, CLOSETS, HALLWAYS, AND SIMILAR AREAS WILL REQUIRE A COMBINATION TYPE AFCI DEVICE AND TAMPER-PROOF RECEPTACLES PER NEC 406.2 AND 406.3
5. ALL 15A AND 20A 120V RECEPTACLES LOCATED IN THE GARAGE AND UTILITY ROOMS SHALL BE GFCI PROTECTED (GFI)
6. IT IS THE RESPONSIBILITY OF THE LICENSED ELECTRICIAN TO ENSURE THAT ALL ELECTRICAL WORK IS IN FULL COMPLIANCE WITH NFPA 70, NEC 200, AND ALL APPLICABLE LOCAL STANDARDS, CODES, AND ORDINANCES.
7. EVERY BUILDING HAVING A FOSSIL-FUEL-BURNING HEATER OR APPLIANCE, FIREPLACE, OR AN ATTACHED GARAGE SHALL HAVE AN OPERATIONAL CARBON MONOXIDE DETECTOR INSTALLED WITHIN 10 FEET OF EACH ROOM USED FOR SLEEPING PURPOSES.
8. ALARMS SHALL RECEIVE THEIR PRIMARY POWER FROM THE BUILDING WIRING WHEN SUCH WIRING IS SERVED FROM THE LOCAL POWER UTILITY. SUCH ALARMS SHALL HAVE BATTERY BACKUP. COMBINATION SMOKE-CARBON MONOXIDE ALARMS SHALL BE LISTED OR LABELED BY A NATIONALLY RECOGNIZED TESTING LABORATORY.

ISSUANCE OF PLANS FROM THIS DRAFTER'S OFFICE SHALL NOT RELIEVE THE BUILDER OF RESPONSIBILITY TO REVIEW AND VERIFY ALL NOTES, DIMENSIONS, AND ADHERENCE TO APPLICABLE BUILDING CODES PRIOR TO COMMENCEMENT OF ANY CONSTRUCTION.
 ANY DISCREPANCY OF ERROR IN NOTES, DIMENSIONS, OR ADHERENCE TO APPLICABLE BUILDING CODES SHALL BE BROUGHT TO THE ATTENTION OF THE DRAFTER'S OFFICE FOR CORRECTION BEFORE COMMENCEMENT OF ANY CONSTRUCTION.
 ANY REVISIONS OR CHANGES, NOT RELATED TO THE CORRECTION OF ERRORS THAT ARE MADE AFTER THE FINAL PLANS HAVE BEEN COMPLETED SHALL BE SUBJECT TO ADDITIONAL FEES.
 IF ANY MODIFICATIONS ARE MADE TO THESE PLANS BY ANY OTHER PARTY OTHER THAN THE DRAFTER'S OFFICE, THE DRAFTER SHALL NOT BE HELD RESPONSIBLE.

OWNERS BATH #2

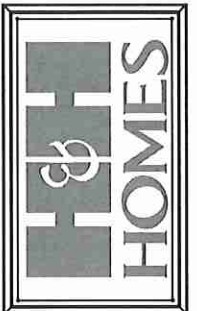
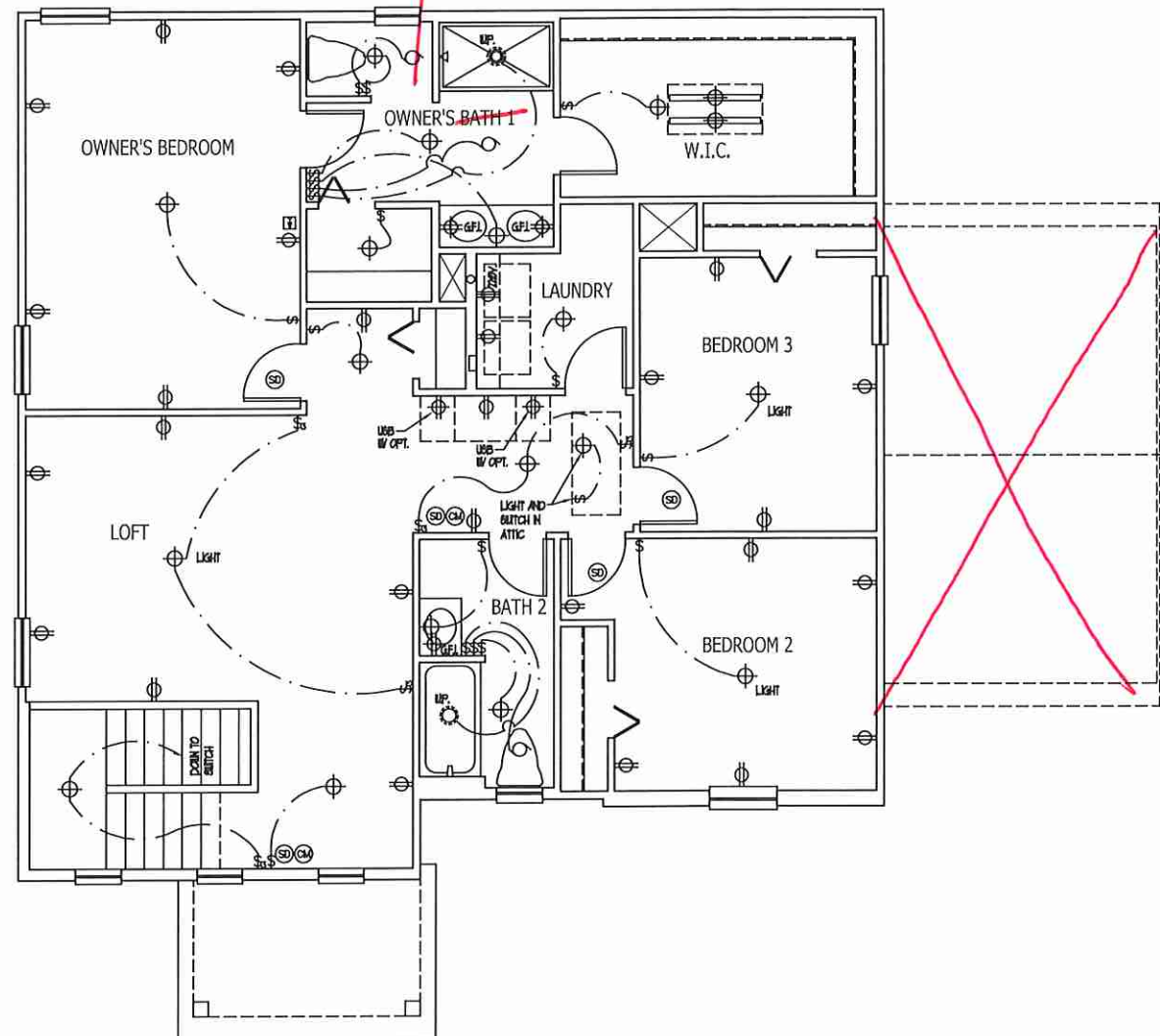

JOB NUMBER	27167.07
CAD FILE NAME	WAYFARE-R
ISSUED	11-08-17
REVISED	11-08-17
	02-18-20



810 874TH STREET EAST
 CLEARWATER, FLORIDA 34617
 813 - 925 - 1500 TEL
 813 - 925 - 1500 FAX
 WWW.DAVISBEWS.COM
 TAMPA - DENVER
 311T.D94

DRAWINGS ON 11"x17" SHEET ARE ONE HALF THE SCALE NOTED

WAYFARE (Garage Right)
 H&H HOMES

2277

TITLE
 UPPER FLOOR ELEC. PLAN

SHEET
 E2

UPPER FLOOR ELECTRICAL PLAN
 GARAGE RIGHT

ELECTRICAL KEY

- DUPLEX CONVENIENCE OUTLET
- DUPLEX OUTLET ABOVE COUNTER
- WEATHERPROOF DUPLEX OUTLET
- GROUND FAULT INTERRUPTER DUPLEX OUTLET
- HALF-SWITCHED DUPLEX OUTLET
- SPECIAL PURPOSE OUTLET
- DUPLEX OUTLET IN FLOOR
- 240 VOLT OUTLET
- WALL SWITCH
- THREE-WAY SWITCH
- FOUR-WAY SWITCH
- DIMMER SWITCH
- CEILING MOUNTED INCANDESCENT LIGHT FIXTURE
- WALL MOUNTED INCANDESCENT LIGHT FIXTURE
- RECESSED INCANDESCENT LIGHT FIXTURE
- LIGHT FIXTURE WITH PULL CHAIN
- TRACK LIGHT
- FLUORESCENT LIGHT FIXTURE
- EXHAUST FAN
- EXHAUST FAN/LIGHT COMBINATION
- ELECTRIC DOOR OPERATOR (OPTIONAL)
- GFI (OPTIONAL)
- PUSHBUTTON SWITCH (OPTIONAL)
- CARBON MONOXIDE DETECTOR
- SMOKE DETECTOR
- SMOKE / CARBON MONO. COMBO DETECTOR
- TELEPHONE (OPTIONAL)
- THERMOSTAT
- ELECTRIC METER
- ELECTRIC PANEL
- DISCONNECT SWITCH
- SPEAKER (OPTIONAL)
- ROUGH-IN FOR OPT. CEILING FAN
- CEILING MOUNTED INCANDESCENT LIGHT FIXTURE W/ ROUGH-IN FOR OPT. CEILING FAN

NOTES:

1. PROVIDE AND INSTALL GROUND FAULT CIRCUIT INTERRUPTERS (GFI) AS INDICATED ON PLANS OR AS ITEM NO. 4 AND 5 BELOW INDICATES.
2. UNLESS OTHERWISE INDICATED, INSTALL SWITCHES AND RECEPTACLES AT THE FOLLOWING HEIGHTS ABOVE FINISHED FLOOR:
 SWITCHES... 48"
 OUTLETS... 18"
 TELEPHONE... 48" (UNLESS ADV. COUNTERTOP)
 TELEVISION... 48"
3. ALL SMOKE DETECTORS SHALL BE HARDWIRED INTO AN ELECTRICAL POWER SOURCE AND SHALL BE EQUIPPED WITH A MONITORED BATTERY BACKUP. PROVIDE AND INSTALL LOCALLY CERTIFIED SMOKE DETECTORS.
4. ALL 120V AND 240V RECEPTACLES IN SLEEPING ROOMS, FAMILY ROOMS, DINING ROOMS, LIVING ROOMS, PARLORS, LIBRARIES, DEN, BUNKROOMS, RECREATION ROOMS, CLOSETS, HALLWAYS, AND SIMILAR AREAS WILL REQUIRE A COMBINATION TYPE AFCI DEVICE AND TAMPER-PROOF RECEPTACLES PER NEC 201.46(D) AND 406.13
5. ALL 120V AND 240V RECEPTACLES LOCATED IN THE GARAGE AND UTILITY ROOMS SHALL BE GFCI PROTECTED (GFI).
6. IT IS THE RESPONSIBILITY OF THE LICENSED ELECTRICIAN TO ENSURE THAT ALL ELECTRICAL WORK IS IN FULL COMPLIANCE WITH NFPA 70, NEC, 2014, AND ALL APPLICABLE LOCAL STANDARDS, CODES, AND ORDINANCES.
7. EVERY BUILDING HAVING A FURNACE, FURNACE-BURNING HEATER OR APPLIANCE, FIREPLACE, OR AN ATTACHED GARAGE SHALL HAVE AN OPERATIONAL CARBON MONOXIDE DETECTOR INSTALLED WITHIN 10 FEET OF EACH ROOM USED FOR SLEEPING PURPOSES.
8. ALARMS SHALL RECEIVE THEIR PRIMARY POWER FROM THE BUILDING WIRING WHEN SUCH WIRING IS DERIVED FROM THE LOCAL POWER UTILITY. SUCH ALARMS SHALL HAVE BATTERY BACKUP. COMBINATION SMOKE/CARBON MONOXIDE ALARMS SHALL BE LISTED OR LABELED BY A NATIONALLY RECOGNIZED TESTING LABORATORY.

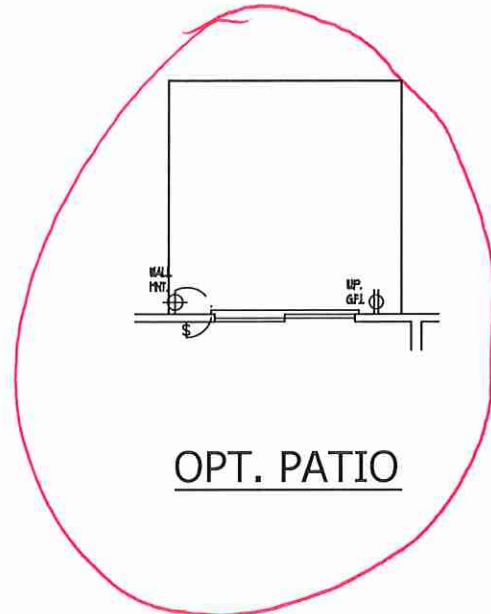

OPT. PATIO

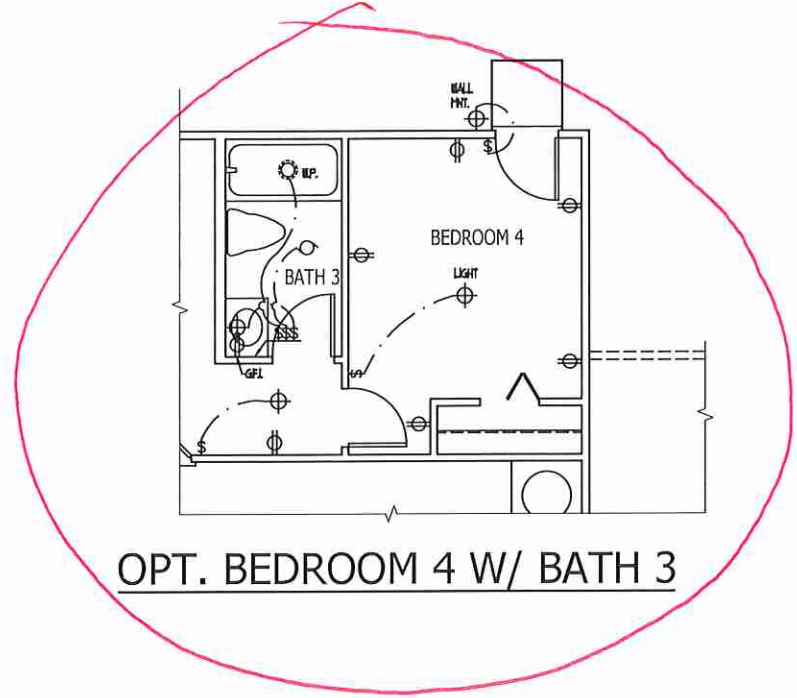

OPT. BEDROOM 4 W/ BATH 3

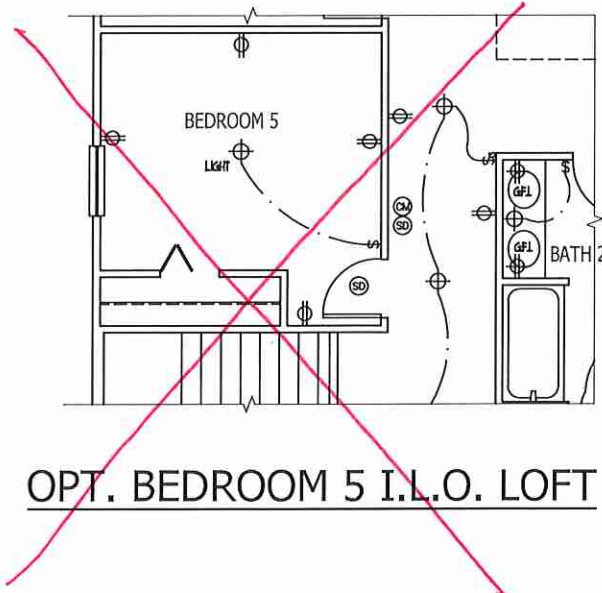

OPT. BEDROOM 5 I.L.O. LOFT

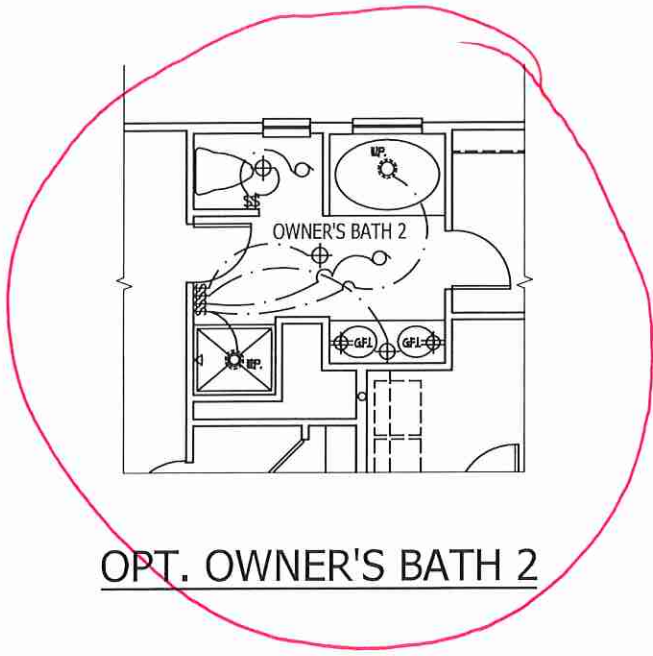

OPT. OWNER'S BATH 2

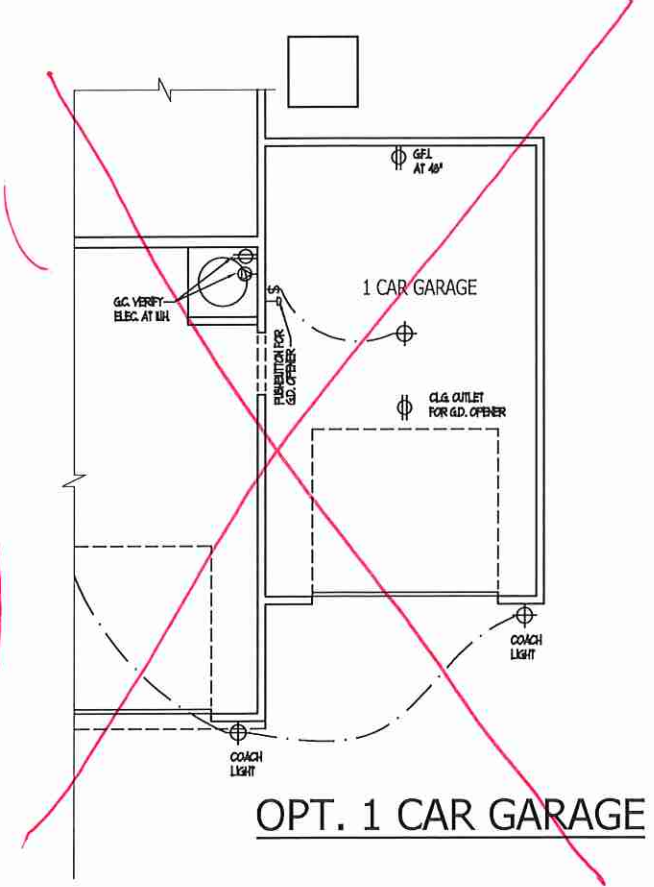

OPT. 1 CAR GARAGE

NOUANCE OF PLANS FROM THIS DRAFTER'S OFFICE SHALL NOT RELIEVE THE BUILDER OF RESPONSIBILITY TO REVIEW AND VERIFY ALL NOTES, DIMENSIONS, AND ADHERENCE TO APPLICABLE BUILDING CODES PRIOR TO COMMENCEMENT OF ANY CONSTRUCTION.
 ANY DISCREPANCY OF ERROR IN NOTES, DIMENSIONS, OR ADHERENCE TO APPLICABLE BUILDING CODES SHALL BE BROUGHT TO THE ATTENTION OF THE DRAFTER'S OFFICE FOR CORRECTION BEFORE COMMENCEMENT OF ANY CONSTRUCTION.
 ANY REVISIONS OR CHANGES NOT RELATED TO THE CORRECTION OF ERRORS THAT ARE MADE AFTER THE FINAL PLANS HAVE BEEN COMPLETED SHALL BE SUBJECT TO ADDITIONAL FEES.
 IF ANY MODIFICATIONS ARE MADE TO THESE PLANS BY ANY OTHER PARTY OTHER THAN THE DRAFTER'S OFFICE, THE DRAFTER SHALL NOT BE HELD RESPONSIBLE.

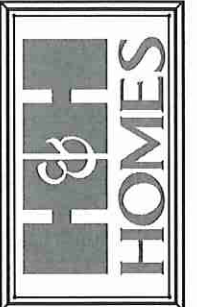

JOB NUMBER	27167.07
CAD FILE NAME	WAYFARE-R
ISSUED	11-08-17
REVISED	11-16-17
	02-18-20



850 STATE STREET SUITE 200
 CLEARWATER, FLORIDA 34677
 813-925-1800 TEL
 813-925-1800 FAX
 WWW.DAVISBEWS.COM
 TAMPA • DENVER
 EST. 1994

DRAWINGS ON 11"x17" SHEET ARE ONE HALF THE SCALE NOTED

WAYFARE (Garage Right)
H&H HOMES

2277

TITLE
 ELECTRIC AT PLAN OPTIONS

SHEET
E3

ELECTRIC AT PLAN OPTIONS
 GARAGE RIGHT

SCALE NOTE:
LARGE FORMAT PRINTS ARE TO SCALE AS NOTED.
11" x 17" PRINTS ARE ONE HALF THE NOTED SCALE

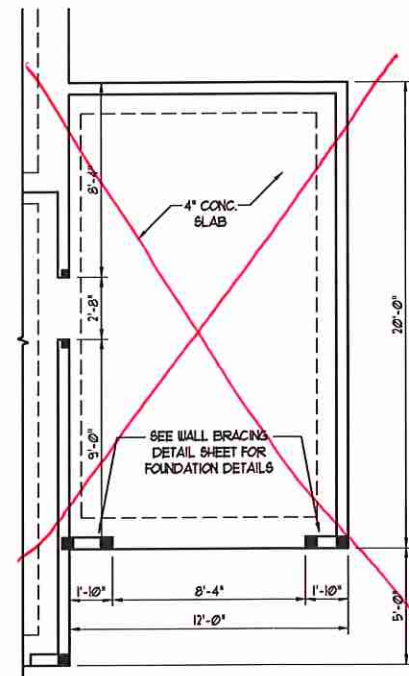
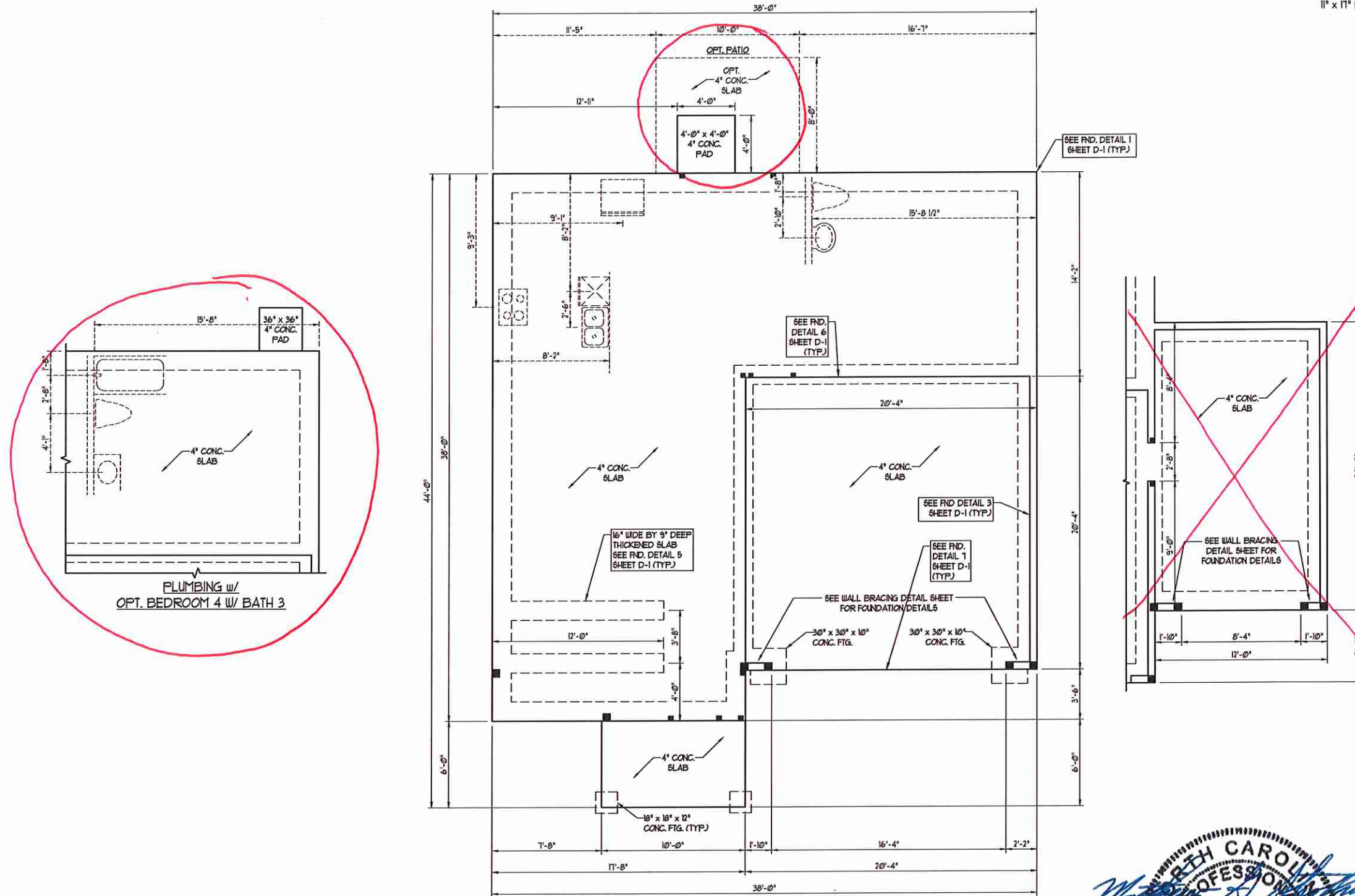

- 150 MPH ULTIMATE DESIGN WIND SPEED NOTES FOR LESS THAN 30' MEAN ROOF HEIGHT:**
- ENGINEER'S SEAL APPLIES ONLY TO STRUCTURAL COMPONENTS. ENGINEER'S SEAL DOES NOT CERTIFY DIMENSIONAL ACCURACY OR ARCHITECTURAL LAYOUT INCLUDING ROOF SYSTEM.
 - STRUCTURAL DESIGN PER NORTH CAROLINA RESIDENTIAL CODE, 2018 EDITION WITH SPECIAL CONSIDERATION TO CHAPTER 45 (HIGH WIND ZONES) FOR 150 MPH WINDS.
 - BUILDER IS TO PROVIDE FRAMING CONNECTIONS AS REQUIRED BY CHAPTER 45 (HIGH WIND ZONES) FOR 150 MPH WINDS) OF THE NORTH CAROLINA RESIDENTIAL CODE, 2018 EDITION.
 - FOUNDATION ANCHORAGE TO COMPLY WITH SECTION 4504 OF THE NORTH CAROLINA RESIDENTIAL CODE, 2018 EDITION.
 - MEAN ROOF HEIGHT IS LESS THAN 30 FEET.
 - WALL CLADDING DESIGNED FOR 443 PSF AND -31 PSF (+/- INDICATE POSITIVE / NEGATIVE PRESSURE (TYP)).
 - ROOF CLADDING DESIGNED FOR 422 PSF AND -28 PSF FOR ROOF PITCHES 1/2 TO 2/3 AND 44 PSF AND -31 PSF FOR ROOF PITCHED 23%/ TO 1/2.
 - 1/8" OSB SHEATHING IS REQUIRED ON ALL EXTERIOR WALLS.
 - WALLS TO BE BRACED IN ACCORDANCE WITH SECTION R602.10.3 OF THE NORTH CAROLINA RESIDENTIAL CODE, 2018 EDITION AND AS NOTED ON PLANS.
 - ENERGY EFFICIENCY COMPLIANCE AND INSULATION VALUES OF THE BUILDING TO BE IN ACCORDANCE WITH CHAPTER 1 OF THE NCRC, 2018 EDITION.

- 120 MPH ULTIMATE DESIGN WIND SPEED NOTES FOR LESS THAN 30' MEAN ROOF HEIGHT:**
- ENGINEER'S SEAL APPLIES ONLY TO STRUCTURAL COMPONENTS. ENGINEER'S SEAL DOES NOT CERTIFY DIMENSIONAL ACCURACY OR ARCHITECTURAL LAYOUT INCLUDING ROOF SYSTEM.
 - STRUCTURAL DESIGN PER NORTH CAROLINA RESIDENTIAL CODE, 2018 EDITION.
 - INSTALL 1/2" ANCHOR BOLTS 6'-0" O.C. AND WITHIN 1'-0" FROM END OF EACH CORNER. ANCHOR BOLTS MUST EXTEND A MINIMUM OF 1" INTO MASONRY OR CONCRETE. LOCATE BOLT WITHIN MIDDLE THIRD OF PLATE WIDTH.
 - MEAN ROOF HEIGHT IS LESS THAN 30 FEET.
 - EXTERIOR WALLS DESIGNED FOR 150 MPH WINDS.
 - WALL CLADDING DESIGNED FOR 455 PSF AND -28 PSF (+/- INDICATE POSITIVE / NEGATIVE PRESSURE (TYP)).
 - ROOF CLADDING DESIGNED FOR 443 PSF AND -18 PSF FOR ROOF PITCHES 1/2 TO 2/3 AND 40 PSF AND -36 PSF FOR ROOF PITCHED 23%/ TO 1/2.
 - INSTALL 1/8" OSB SHEATHING ON ALL EXTERIOR WALLS OF ALL STORES IN ACCORDANCE WITH SECTION R602.10.3 OF THE NCRC, 2018 EDITION. SEE THE WALL BRACING NOTES AND DETAILS SHEET FOR MORE INFORMATION.
 - ENERGY EFFICIENCY COMPLIANCE AND INSULATION VALUES OF THE BUILDING TO BE IN ACCORDANCE WITH CHAPTER 1 OF THE NCRC, 2018 EDITION.
 - REFER TO NOTES AND DETAIL SHEETS FOR ADDITIONAL STRUCTURAL INFORMATION.

J.S. THOMPSON ENGINEERING, INC
606 WADE AVE., SUITE 104 RALEIGH, NC 27605
PHONE: (919) 789-9919 FAX: (919) 789-9921
N.C. LICENSE NO. C-1733

WAYFARE
H & H HOMES



DATE: MARCH 6, 2020
SCALE: 1/4" = 1'-0"
DRAWN BY: DAV'S BCK'S DESIGN CO.
ENGINEERED BY: WTB

SHEET: 2 OF 7
S-1b
MONO SLAB
FOUNDATION PLAN

SCALE NOTE:
LARGE FORMAT PRINTS ARE TO SCALE AS NOTED.
11" x 17" PRINTS ARE ONE HALF THE NOTED SCALE

NOTE: ALL SECOND FLOOR EXTERIOR WALLS AND ATTIC WALLS ARE TO BE 2 x 4 SFF #2 @ 24" O.C. 2 x 6 SFF #2 @ 24" O.C. SECOND FLOOR EXTERIOR WALLS MAY BE CONSTRUCTED IN LIEU OF 2 x 4 WALLS (UNO). ALL INTERIOR LOAD BEARING AND NON-LOAD BEARING WALLS ARE TO BE 2 x 4 SFF #2 @ 24" O.C. (UNO).

BRACED WALL DESIGN NOTES:

- BRACED WALL DESIGN PER SECTION R602.10 OF THE NRC 2018 EDITION.
- C5-UBP REFERS TO "CONTINUOUS SHEATHING - WOOD STRUCTURAL PANELS" CONTRACTOR IS TO INSTALL 1/4" OSB ON ALL EXTERIOR WALLS ATTACHED w/ 8d NAILS SPACED 6" O.C. ALONG PANEL EDGES AND 12" O.C. IN THE FIELD.
- GB REFERS TO "GYPSUM BOARD" CONTRACTOR IS TO INSTALL 1/2" (UNO) GYPSUM WALL BOARD WHERE NOTED ON THE PLANS. FASTEN GB WITH 1 1/4" SCREWS OR 1 5/8" NAILS SPACED 12" O.C. ALONG PANEL EDGES AND IN THE FIELD INCLUDING TOP AND BOTTOM PLATES.
- BRACED WALL DESIGN APPLIED IN WIND ZONES UP TO 130 MPH. FOR HIGH WIND ZONES, BRACE WALLS ARE TO BE CONSTRUCTED IN ACCORDANCE WITH CHAPTER 45 OF THE NRC 2018 EDITION.
- SEE NOTES AND DETAIL SHEETS FOR ADDITIONAL BRACED WALL INFORMATION.

NOTE:

- PER SECTION R602.10.3.2 OF THE 2018 NRC, THE AMOUNT OF BRACING ON THE SECOND FLOOR EXCEEDS THE AMOUNT REQUIRED FOR THE FIRST FLOOR AND NO BRACED WALL ANALYSIS IS REQUIRED.
- SHEATH ALL EXTERIOR WALLS WITH 1/4" OSB SHEATHING ATTACHED WITH 8d NAILS AT 6" O.C. ALONG PANEL EDGES AND 12" O.C. IN THE FIELD.

TABLE R602.15
MINIMUM NUMBER OF FULL HEIGHT STUDS AT EACH END OF HEADERS IN EXTERIOR WALLS

HEADER SPAN (FEET)	MAXIMUM STUD SPACING (INCHES) (PER TABLE R602.15)	
	16	24
UP TO 3'	1	1
4'	2	1
6'	3	2
12'	5	3
16'	6	4

STRUCTURAL NOTES:

- ALL FRAMING LUMBER TO BE SFF #2 (UNO). ALL TREATED LUMBER TO BE SYP #2 (UNO).
- ALL LOAD BEARING HEADERS TO BE (2) 2 x 6 (UNO).
- WINDOW AND DOOR HEADERS TO BE SUPPORTED w/ (1) JACK STUD AND (1) KING STUD EA. END (UNO). SEE TABLE R602.15 FOR ADDITIONAL KING STUD REQUIREMENTS.
- SQUARES DENOTE POINT LOADS WHICH REQUIRE SOLID BLOCKING TO GIRDER OR FOUNDATION. ALL SQUARES TO BE (2) STUDS (UNO).
- FOR HIGH WIND ZONES, ALL EXTERIOR WALLS TO BE SHEATHED WITH 1/4" OSB SHEATHING WITH JOINTS BLOCKED AND SECURED WITH 8d NAILS AT 3" O.C. ALONG EDGES AND 6" O.C. IN THE FIELD.
- FOR HIGH WIND ZONES, SECURE ALL EXTERIOR WALL SHEATHING PANELS TO DOUBLE TOP PLATES, BANDS, JOISTS, AND GIRDERS WITH (2) ROWS OF 8d NAILS STAGGERED AT 3" O.C. PANELS SHALL EXTEND 12" BEYOND CONSTRUCTION JOINTS AND SHALL OVERLAP GIRDERS AND DOUBLE SILL PLATES THEIR FULL DEPTH.
- REFER TO NOTES AND DETAIL SHEETS FOR ADDITIONAL STRUCTURAL INFORMATION.

T&P INDICATES DOUBLE STUD POCKET BETWEEN WINDOW UNITS.

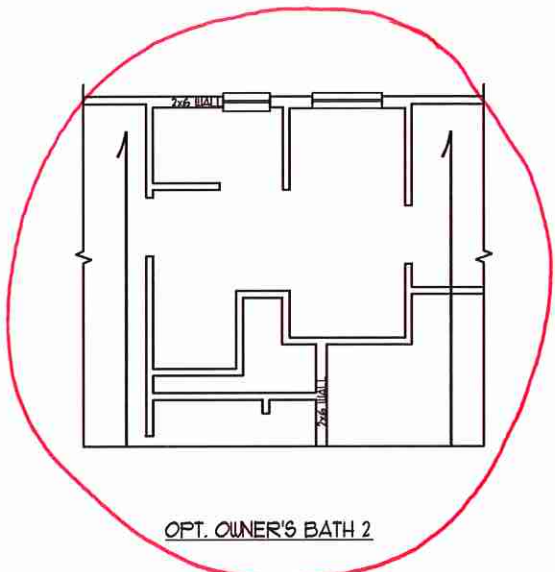

OPT. OWNER'S BATH 2

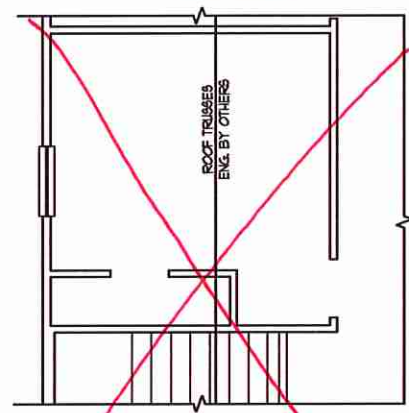

OPT. BEDROOM 5 I.L.O. LOFT

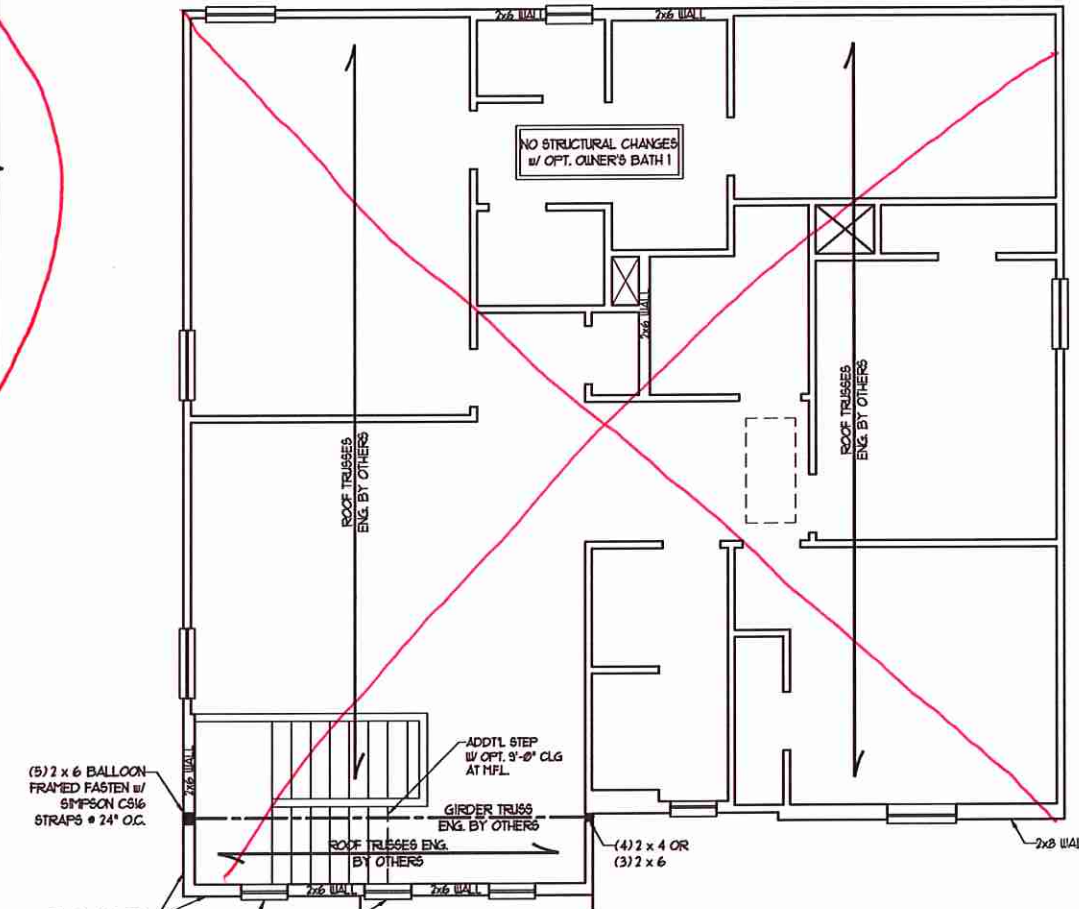

ELEVATION A

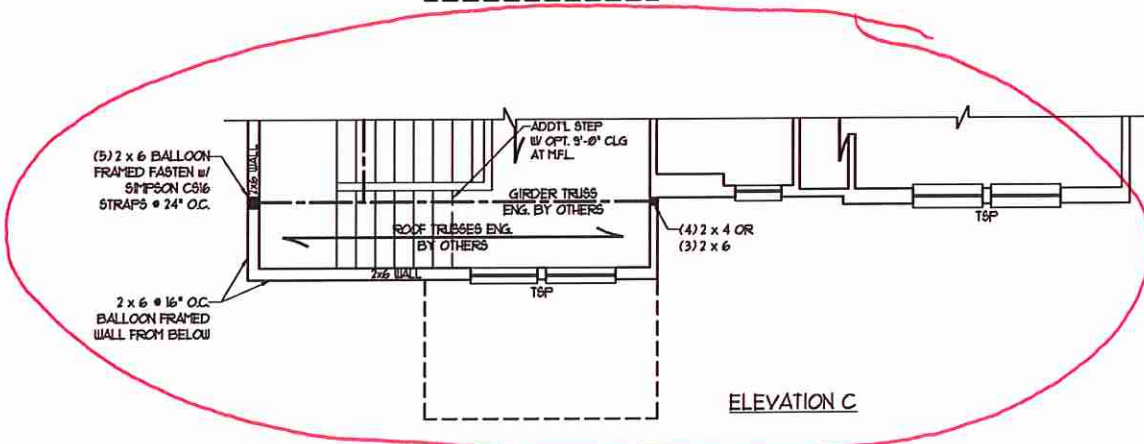

ELEVATION C



J.S. THOMPSON ENGINEERING, INC.
600 WADE AVE. SUITE 104 RALEIGH, NC 27605
PHONE: (919) 789-9919 FAX: (919) 789-9921
N.C. LICENSE NO. 01733

WAYFARE
H & H HOMES

DATE: MARCH 6, 2020
SCALE: 1/4" = 1'-0"
DRAWN BY: DAVIS BOWEN DESIGN CO.
ENGINEERED BY: WFB

SHEET 5 OF 7
S-3
CEILING FRAMING PLAN

SCALE NOTE:
 LARGE FORMAT PRINTS ARE TO SCALE AS NOTED.
 11" x 17" PRINTS ARE ONE HALF THE NOTED SCALE.

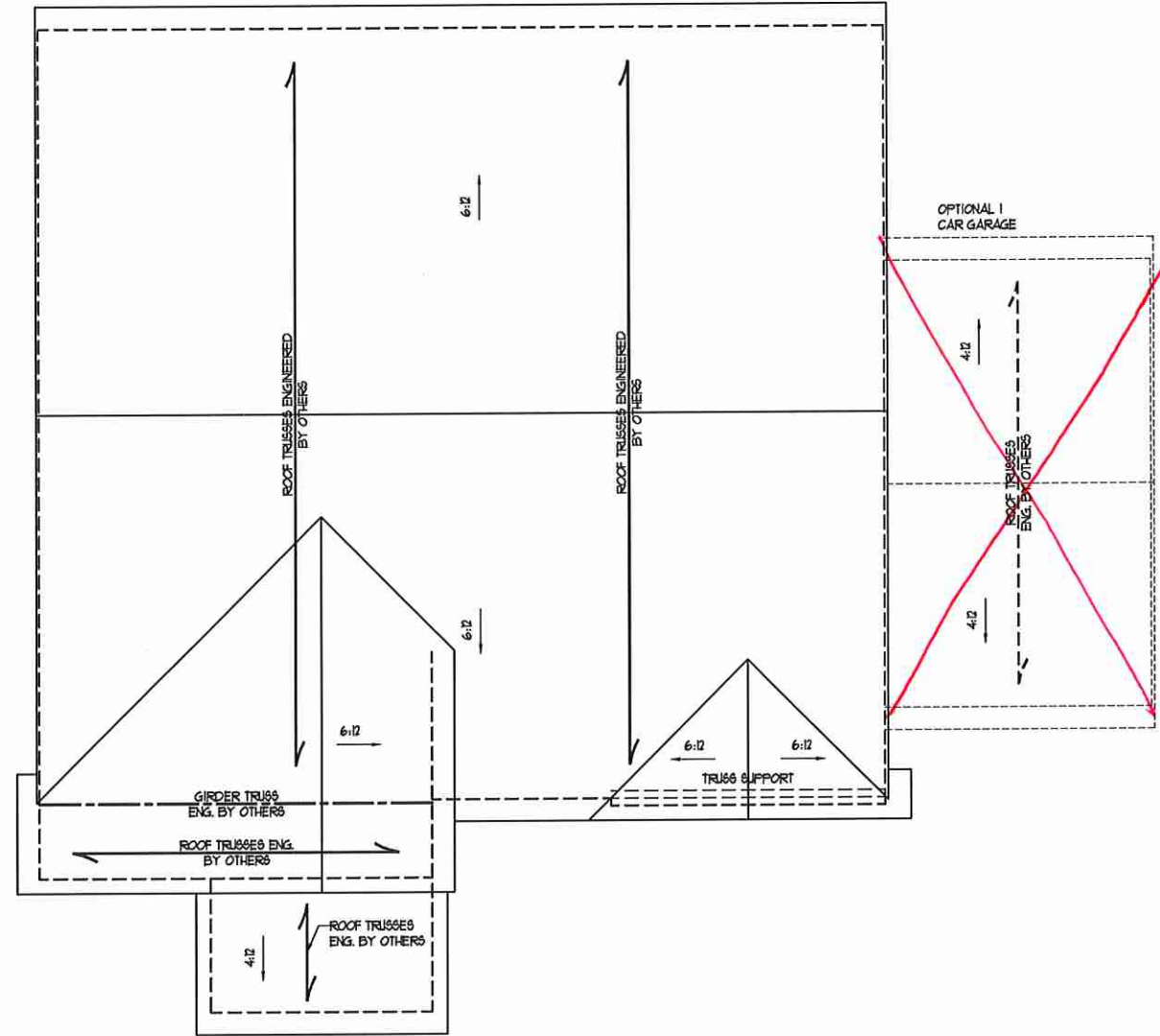

ELEVATION C

- STRUCTURAL NOTES:**
- ALL FRAMING LUMBER TO BE #2 SFF (UND).
 - CIRCLES DENOTE (3) 2 x 4 POSTS FOR ROOF SUPPORT.
 - FRAME DORMER WALLS ON TOP OF DOUBLE OR TRIPLE RAFTERS.
 - HIP SPICES ARE TO BE SPACED A MIN. OF 8'-0". FASTEN MEMBERS WITH THREE ROWS OF 12d NAILS @ 16" O.C. (TYP.)
 - STICK FRAME OVER-FRAMED ROOF SECTIONS W/ 2 x 8 RIDGES, 2 x 6 RAFTERS @ 16" O.C. AND FLAT 2 x 10 VALLEYS OR USE VALLEY TRUSSES.
 - FASTEN FLAT VALLEYS TO RAFTERS OR TRUSSES WITH SIMPSON HZBA HURRICANE TIES @ 32" O.C. MAX. PASS HURRICANE TIES THROUGH NOTCH IN ROOF SHEATHING. EACH RAFTER IS TO BE FASTENED TO THE FLAT VALLEY WITH A MIN. OF (6) 12d TOE NAILS.
 - REFER TO SECTION R20211 OF THE 2018 NRC FOR REQUIRED UPLIFT RESISTANCE AT RAFTERS AND TRUSSES.
 - REFER TO NOTES AND DETAIL SHEETS FOR ADDITIONAL STRUCTURAL INFORMATION.

**J.S. THOMPSON
 ENGINEERING, INC**
 606 WADE AVE., SUITE 104 RALEIGH, NC 27605
 PHONE: (919) 789-9919 FAX: (919) 789-9921
 N.C. LICENSE NO. C-1733

WAYFARE
 H & H HOMES

Matthew G. Strother
 NORTH CAROLINA
 PROFESSIONAL SEAL
 33736
 ENGINEER
 MATTHEW G. STROTHER
 3/6/2020

DATE: MARCH 6, 2020
 SCALE: 1/4" = 1'-0"
 DRAWN BY: DAVIS DEWS DESIGN CO.
 ENGINEERED BY: WTB

SHEET: 7 OF 7
 S-4b
 ROOF FRAMING
 PLAN

MONOLITHIC SLAB DETAILS

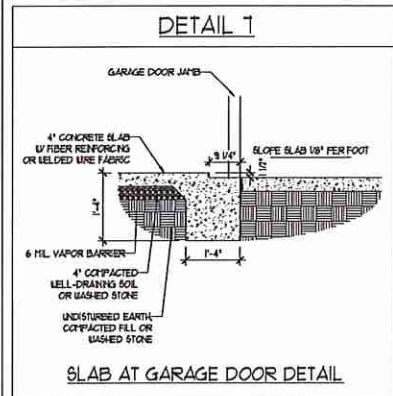
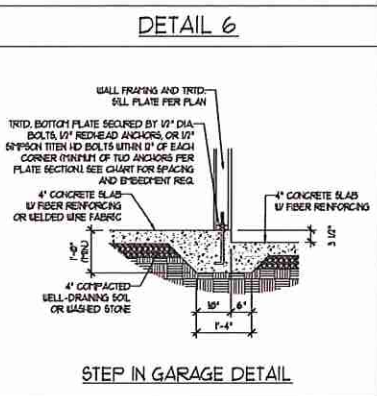
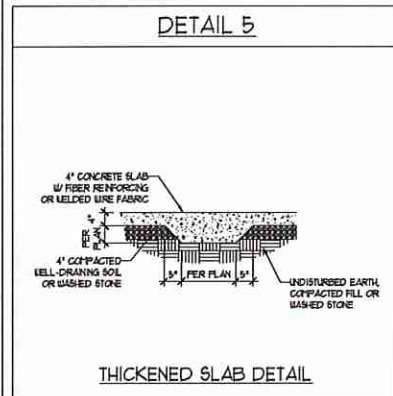
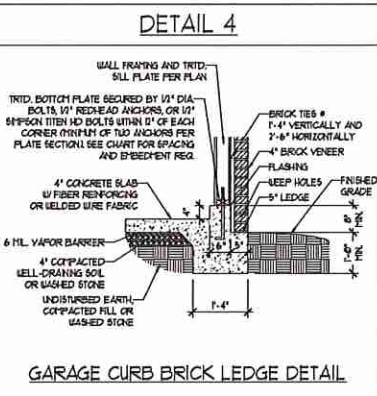
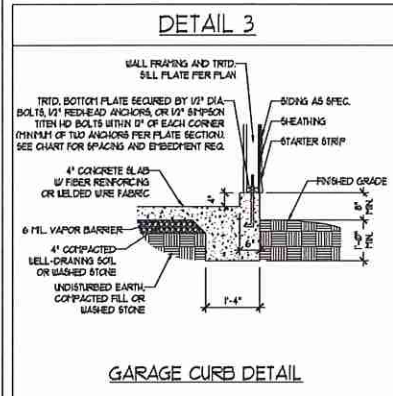
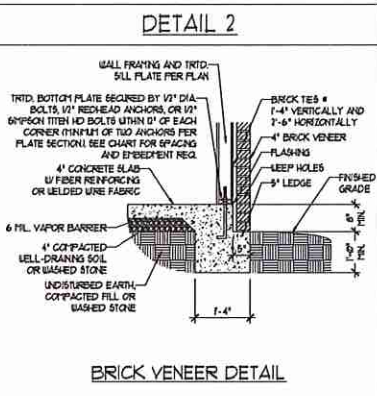
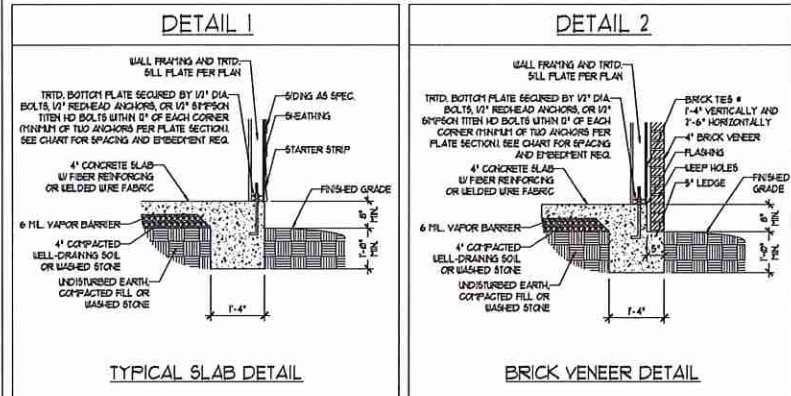

STEMWALL DETAILS

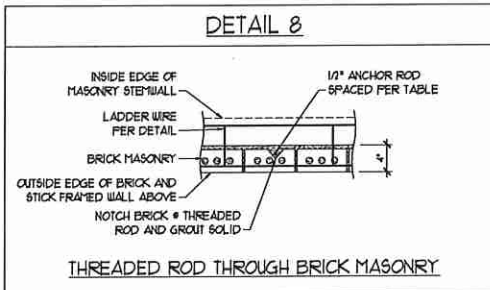
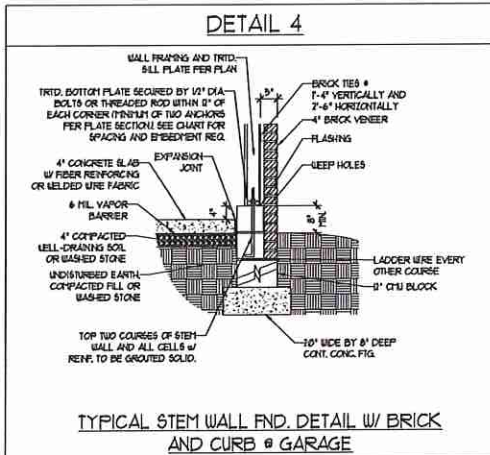
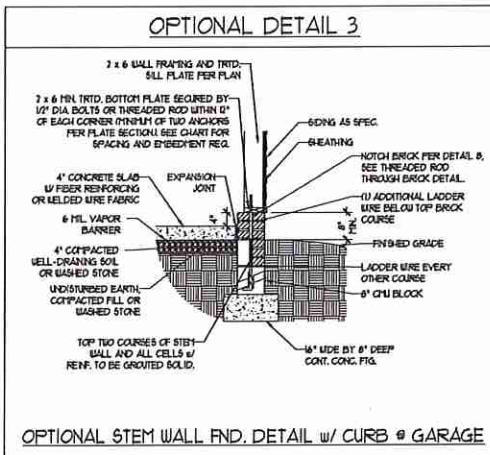
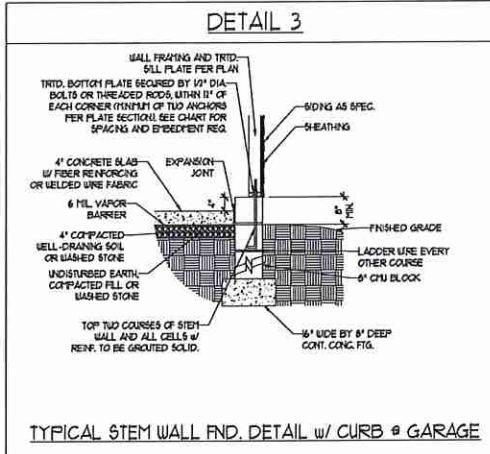
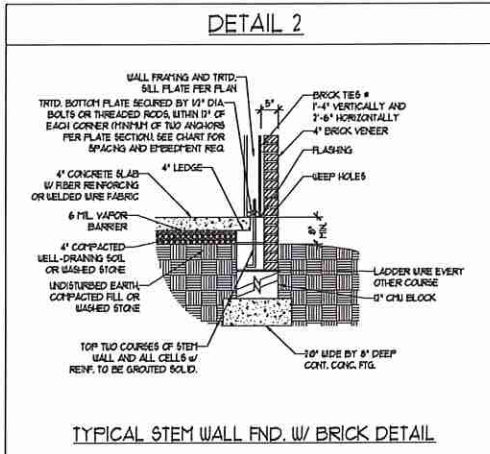
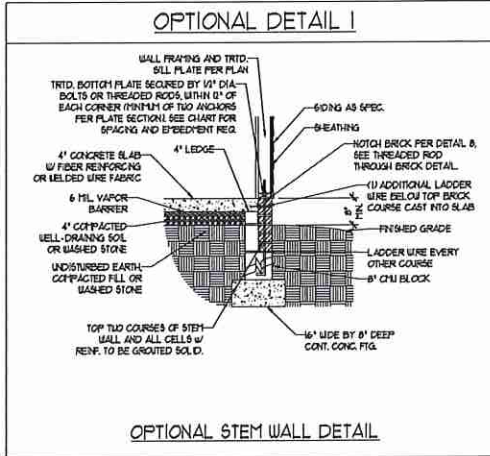
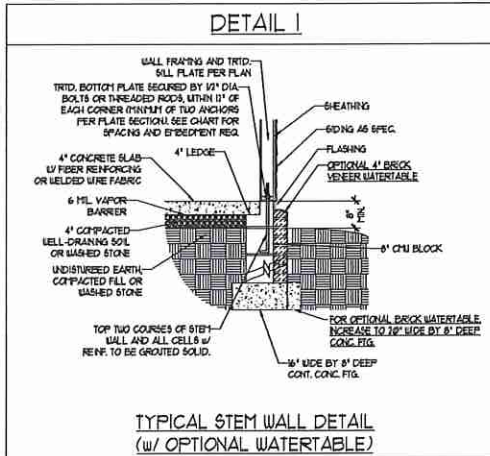

MASONRY STEMWALL SPECIFICATIONS

WALL HEIGHT (FEET)	MASONRY WALL TYPE			
	8" CMU	4" BRICK AND 4" CMU	4" BRICK AND 8" CMU	12" CMU
2 AND BELOW	UNGROUTED	GROUT SOLID	UNGROUTED	UNGROUTED
3	UNGROUTED	GROUT SOLID	UNGROUTED	UNGROUTED
4	GROUT SOLID	GROUT SOLID w/ 4 REBAR # 48" O.C.	GROUT SOLID	GROUT SOLID w/ 4 REBAR # 64" O.C.
5	GROUT SOLID w/ 4 REBAR # 36" O.C.	NOT APPLICABLE	GROUT SOLID w/ 4 REBAR # 36" O.C.	GROUT SOLID w/ 4 REBAR # 64" O.C.
6	GROUT SOLID w/ 4 REBAR # 24" O.C.	NOT APPLICABLE	GROUT SOLID w/ 4 REBAR # 24" O.C.	GROUT SOLID w/ 4 REBAR # 64" O.C.
7 AND GREATER	ENGINEERED DESIGN BASED ON SITE CONDITIONS			

- STRUCTURAL NOTES:**
- WALL HEIGHT MEASURED FROM TOP OF FOOTING TO TOP OF THE WALL.
 - THE MULTIPLE WYTHES TOGETHER WITH LADDER WIRE AT 16" O.C. VERTICALLY.
 - CHART APPLICABLE FOR HOUSE FOUNDATION ONLY, CONSULT ENGINEER FOR DESIGN OF GARAGE FOUNDATION NOT COMMON TO HOUSE.
 - BACKFILL OF CLEAN #1 1/2" WASHED STONE IS ALLOWABLE.
 - BACKFILL OF WELL DRAINED OR SAND - GRAVEL MIXTURE SOILS (AS PER FT. BELOW GRADE) CLASSIFIED AS GROUP 1 ACCORDING TO UNIFIED SOILS CLASSIFICATION SYSTEM IN ACCORDANCE WITH TABLE R402) OF THE 2018 INTERNATIONAL RESIDENTIAL CODE ARE ALLOWABLE.
 - FREP SLAB PER R506.2) AND R506.2) BASE OF THE 2018 INTERNATIONAL RESIDENTIAL CODE. MINIMUM 74" LAP SPlice LENGTH.
 - LOCATE REBAR IN CENTER OF FOUNDATION WALL.
 - WHERE REQUIRED, FILL BLOCK SOLID WITH TYPE "S" MORTAR OR 3000 PSI GROUT. USE OF "LOW LIFT GROUTING" METHOD REQUIRED WHEN FILLING WALLS WITH GROUT AT HEIGHTS OF 3' AND GREATER.

ANCHOR SPACING AND EMBEDMENT

WIND ZONE	120 MPH	130 MPH
SPACING	6'-0" O.C.	4'-0" O.C.
EMBEDMENT	1'	5" INTO MASONRY 1" INTO CONCRETE



J.S. THOMPSON ENGINEERING, INC.
 600 WADE AVE., SUITE 104, RALEIGH, NC 27605
 PHONE: (919) 789-9919 FAX: (919) 789-9921
 N.C. LICENSE NO. C1713

120 MPH - 130 MPH ULTIMATE DESIGN WIND SPEED
 FOUNDATION DETAILS

DATE: NOVEMBER 14, 2018
 SCALE: NTS
 DRAWN BY: JST
 ENGINEERED BY: JES

D-1
 FOUNDATION DETAILS

GENERAL WALL BRACING NOTES:

1. WALL BRACING DESIGNED IN ACCORDANCE WITH CHAPTER 6 OF THE 2018 NC RESIDENTIAL BUILDING CODE (NCR). TABLES AND FIGURES REFERENCED ARE FROM THE 2018 NCR.
2. SEE THIS SHEET FOR GENERAL DETAILS. REFER TO THE 2018 NCR FOR ADDITIONAL INFORMATION AS NEEDED.
3. BRACED EXTERIOR WALLS SUPPORTING ROOF TRUSSES AND RAFTERS, INCLUDING STORIES BELOW THE TOP FLOOR, HAVE BEEN DESIGNED PER R602.3.5 (3). WALL SHEATHING AND FASTENERS HAVE BEEN DESIGNED TO RESIST COMBINED UPLIFT AND SHEAR FORCES IN ACCORDANCE WITH ACCEPTED ENGINEERING PRACTICE.
4. SEE STRUCTURAL SHEETS FOR BRACED WALL LOCATIONS, DIMENSIONS, HOLD DOWN TYPE AND LOCATIONS, BRACED WALL LINE KEY WITH WALL DESIGN SUMMARY OF REQUIRED/PROVIDED TOTALS FOR EACH WALL LINE AND ANY SPECIAL NOTES OR REQUIREMENTS.
5. ALL EXTERIOR WALLS ARE TO BE SHEATHED WITH CS-USP IN ACCORDANCE WITH SECTION R602.10.3 UNLESS NOTED OTHERWISE.
6. ALL EXTERIOR AND INTERIOR WALLS TO HAVE 1/2" GYPSUM INSTALLED. WHEN NOT USING METHOD "GB", GYPSUM TO BE FASTENED PER TABLE R102.3.5. METHOD GB TO BE FASTENED PER TABLE R602.10.
7. CS-USP REFERS TO THE "CONTINUOUS SHEATHING - WOOD STRUCTURAL PANELS" WALL BRACING METHOD. 1/16" OSB SHEATHING IS TO BE INSTALLED ON ALL EXTERIOR WALLS ATTACHED w/ 6d COMMON NAILS OR 8d (2 1/2" LONG x 0.131" DIAMETER) NAILS SPACED 6" O.C. ALONG PANEL EDGES AND 12" O.C. IN THE FIELD (U.N.O.).
8. GB REFERS TO THE "GYPSUM BOARD" WALL BRACING METHOD. 1/2" (MIN) GYPSUM WALL BOARD IS TO BE INSTALLED ON BOTH SIDES OF THE BRACED WALL FASTENED WITH 1 1/4" SCREWS OR 1 5/8" NAILS SPACED 1" O.C. ALONG PANEL EDGES INCLUDING TOP AND BOTTOM PLATES AND INTERMEDIATE SUPPORTS (U.N.O.). VERIFY ALL FASTENER OPTIONS FOR 1/2" AND 5/8" GYPSUM PRIOR TO CONSTRUCTION. FOR INTERIOR FASTENER OPTIONS SEE TABLE R102.3.5. FOR EXTERIOR FASTENER OPTIONS SEE TABLE R602.3(1). EXTERIOR GB TO BE INSTALLED VERTICALLY.
9. REQUIRED BRACED WALL LENGTH FOR EACH SIDE OF THE CIRCUMSCRIBED RECTANGLE ARE INTERPOLATED PER TABLE R602.10.3. METHOD CS-USP CONTRIBUTES ITS ACTUAL LENGTH, METHOD GB CONTRIBUTES 5 TIMES ITS ACTUAL LENGTH, AND METHOD FF CONTRIBUTES 15 TIMES ITS ACTUAL LENGTH.

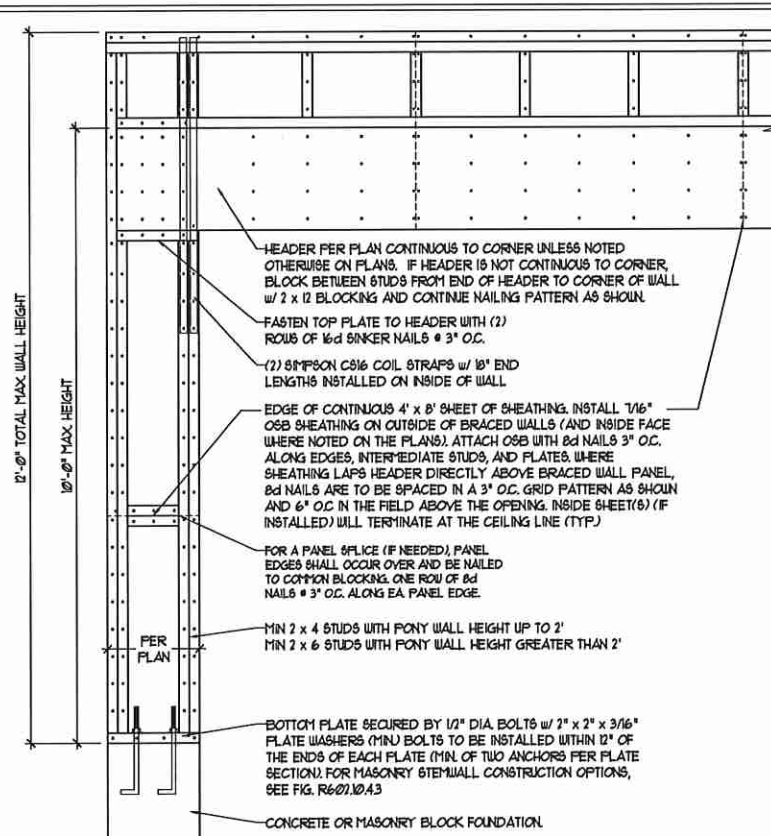

OVER CONCRETE OR MASONRY BLOCK FOUNDATION

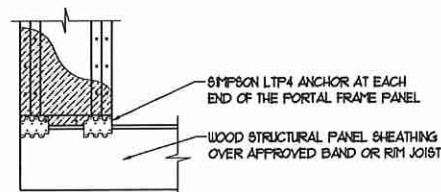

OVER RAISED WOOD FLOOR - FRAMING ANCHOR OPTION
* APPLICABLE w/ GREATER THAN 12" KNEE WALL HEIGHTS IN CRAIL SPACE AND ABOVE FRAMED BASEMENT WALLS *

METHOD FF-PORTAL FRAME DETAIL ①

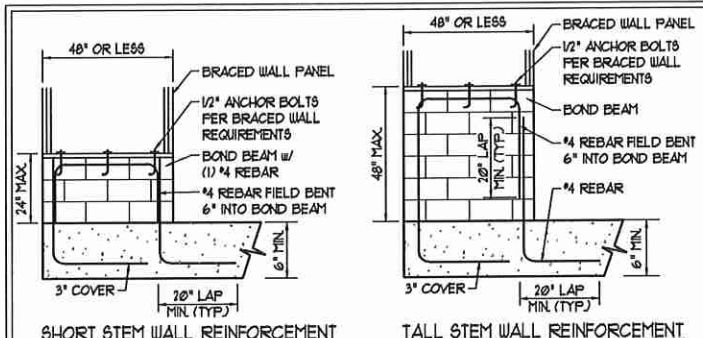

SHORT STEM WALL REINFORCEMENT

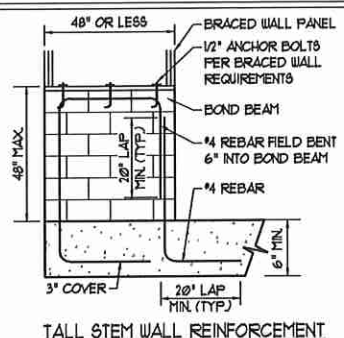

TALL STEM WALL REINFORCEMENT

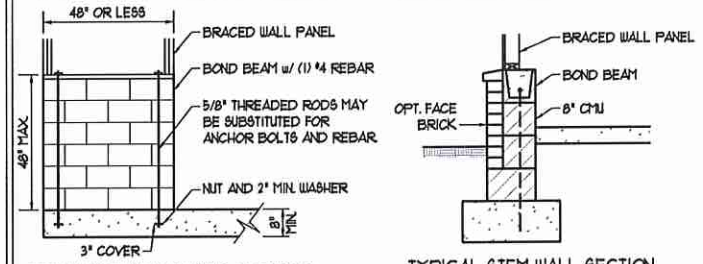

TYPICAL STEM WALL SECTION

RODS MAY BE INSTALLED USING AN ADHESIVE ANCHORING SYSTEM WITH A MINIMUM TENSILE CAPACITY OF 3150 LBS AND INSTALLED IN ACCORDANCE WITH MANUFACTURER'S SPECS.

OPTIONAL STEM WALL REINFORCEMENT

NOTE: GROUT BOND BEAMS AND ALL CELLS WHICH CONTAIN REBAR, THREADED RODS AND ANCHOR BOLTS
MASONRY STEM WALLS SUPPORTING BRACED WALL PANELS ②
PER FIGURE R602.10.4.3

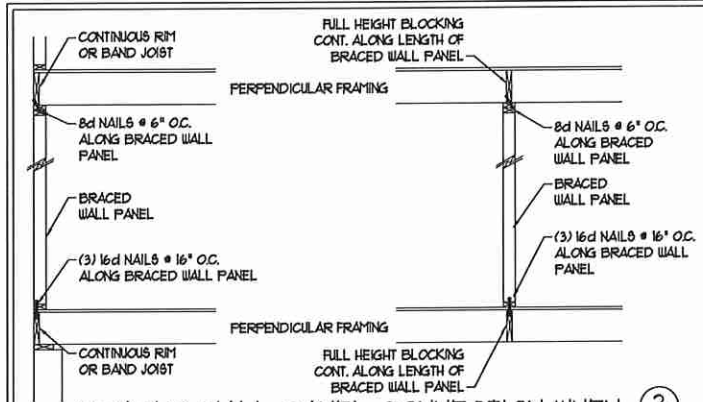

BRACED WALL PANEL CONNECTION WHEN PERPENDICULAR TO FLOOR/CEILING FRAMING ③
PER FIGURE R602.10.4.4(1)

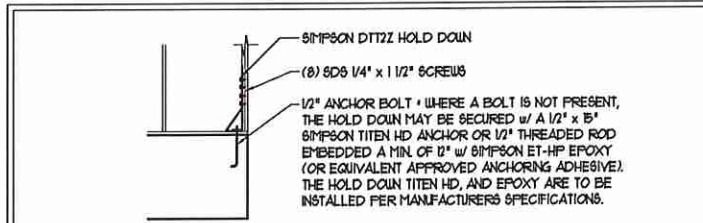

HOLD DOWN DETAIL FOR MASONRY FOUNDATION OR MONOLITHIC SLAB ④
* APPLICABLE ONLY WHERE SPECIFIED ON PLAN *

TYPICAL EXTERIOR CORNER FRAMING FOR CONTINUOUS SHEATHING ⑤
PER FIGURE R602.10.3(5)

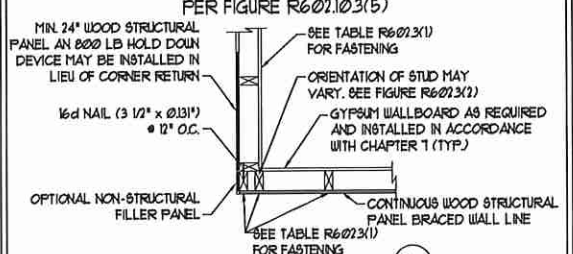

(a) OUTSIDE CORNER DETAIL ⑤a

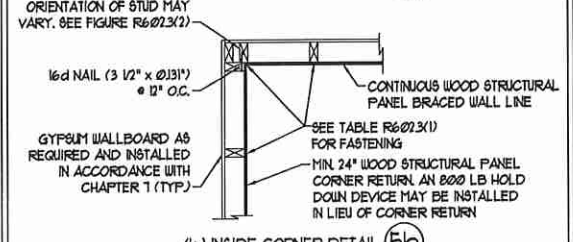

(b) INSIDE CORNER DETAIL ⑤b

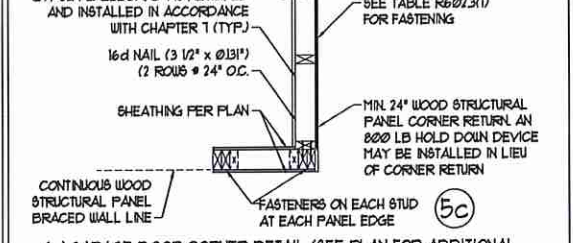

(c) GARAGE DOOR CORNER DETAIL (SEE PLAN FOR ADDITIONAL STRUCTURAL INFORMATION OR ALTERNATE CONFIGURATIONS) ⑤c

BRACED WALL PANEL CONNECTION WHEN PARALLEL TO FLOOR/CEILING FRAMING ⑥
PER FIG. R602.10.4.4(2)

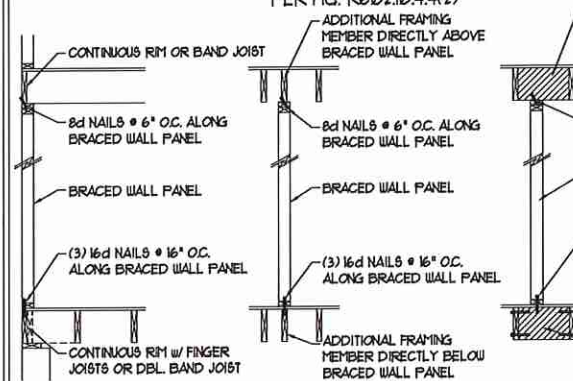

This sealed page is to be used in conjunction with a full plan set engineered by J.S. Thompson Engineering, Inc. only. Use of this individual sealed page within architectural pages or shop drawings by others is a punishable offense under N.C. Statute § 89C-23

SCALE NOTE:
LARGE FORMAT PRINTS ARE TO SCALE AS NOTED.
11" x 17" PRINTS ARE ONE HALF THE NOTED SCALE.

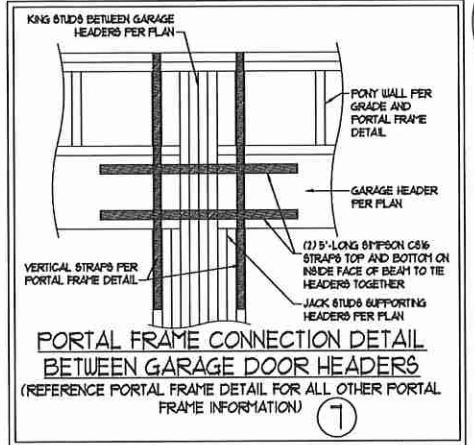

PORTAL FRAME CONNECTION DETAIL BETWEEN GARAGE DOOR HEADERS (REFERENCE PORTAL FRAME DETAIL FOR ALL OTHER PORTAL FRAME INFORMATION) ⑦

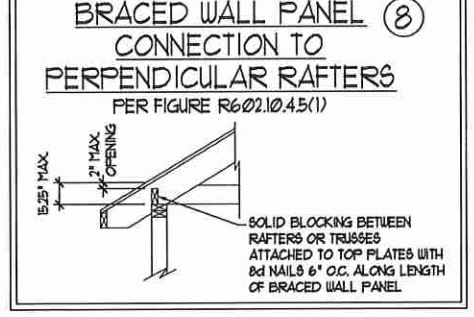

BRACED WALL PANEL CONNECTION TO PERPENDICULAR ROOF TRUSSES ⑨
PER FIGURE R602.10.4.5(3) (OR ALTERNATIVE: FIGURE R602.10.4.5(2))

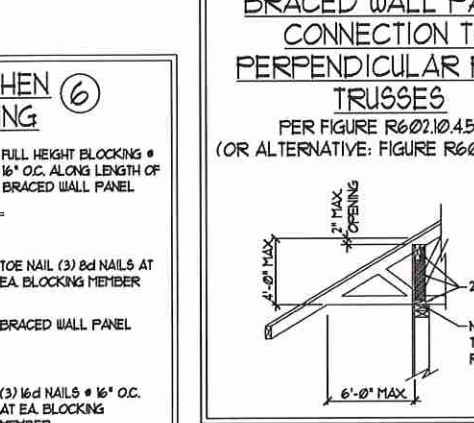

J.S. THOMPSON ENGINEERING, INC.
606 WADE AVE., SUITE 104 - RALEIGH, NC 27605
PHONE: (919) 780-9919 FAX: (919) 789-9921
N.C. LICENSE NO.: C-1173

120 MPH - 130 MPH ULTIMATE DESIGN WIND SPEED
WALL BRACING NOTES AND DETAILS

DATE: OCTOBER 31, 2018
SCALE: 1/4" = 1'-0"
DRAWN BY: JST
ENGINEERED BY: JST

D-2
BRACED WALL NOTES AND DETAILS AND PF DETAILS

3/6/2020

SCALE NOTE:
LARGE FORMAT PRINTS ARE TO SCALE AS NOTED.
11" x 17" PRINTS ARE ONE HALF THE NOTED SCALE

GENERAL NOTES

- ENGINEER'S SEAL APPLIES ONLY TO STRUCTURAL COMPONENTS INCLUDING ROOF RAFTERS, HIPS, VALLEYS, RIDGES, FLOORS, WALLS, BEAMS, HEADERS, COLUMNS, CANTILEVERS, OFFSET LOAD BEARING WALLS, PIERS, GIRDER SYSTEM AND FOOTING. ENGINEER'S SEAL DOES NOT CERTIFY DIMENSIONAL ACCURACY OF ARCHITECTURAL LAYOUT INCLUDING ROOF. ENGINEER'S SEAL DOES NOT APPLY TO I-JOIST OR FLOOR/ROOF TRUSS LAYOUT DESIGN AND ACCURACY.
 - ALL CONSTRUCTION SHALL CONFORM TO THE LATEST REQUIREMENTS OF THE NORTH CAROLINA RESIDENTIAL CODE (NRC), 2018 EDITION, PLUS ALL LOCAL CODES AND REGULATIONS. THE STRUCTURAL ENGINEER IS NOT RESPONSIBLE FOR, AND WILL NOT HAVE CONTROL OF, CONSTRUCTION MEANS, METHODS, TECHNIQUES, SEQUENCES OR PROCEDURES, OR SAFETY PRECAUTIONS AND PROGRAMS IN CONNECTION WITH THE CONSTRUCTION WORK. NOR WILL THE ENGINEER BE RESPONSIBLE FOR THE CONTRACTOR'S FAILURE TO CARRY OUT THE CONSTRUCTION WORK IN ACCORDANCE WITH THE CONTRACT DOCUMENTS.
 - STRUCTURAL DESIGN BASED ON THE PROVISIONS OF THE NRC, 2018 EDITION (R301.4 - R301.7)
- | DESIGN CRITERIA: | LIVE LOAD (PSF) | DEAD LOAD (PSF) | DEFLECTION (IN) |
|--------------------------------|---|-----------------|-----------------------------------|
| ATTIC WITH LIMITED STORAGE | 20 | 10 | L/240 (L/360 w/ BRITTLE FINISHES) |
| ATTIC WITHOUT STORAGE | 10 | 10 | L/360 |
| DECKS | 40 | 10 | L/360 |
| EXTERIOR BALCONIES | 40 | 10 | L/360 |
| FIRE ESCAPES | 40 | 10 | L/360 |
| HANDRAILS/GUARDRAILS | 200 LB OR 50 (PLF) | 10 | L/360 |
| PASSENGER VEHICLE GARAGE | 50 | 10 | L/360 |
| ROOMS OTHER THAN SLEEPING ROOM | 40 | 10 | L/360 |
| SLEEPING ROOMS | 30 | 10 | L/360 |
| STAIRS | 40 | 10 | L/360 |
| WIND LOAD | (BASED ON TABLE R301.2(4) WIND ZONE AND EXPOSURE) | | |
| GROUND SNOW LOAD: Pg | 20 (PSF) | | |
- I-JOIST SYSTEMS DESIGNED WITH 12 PSF DEAD LOAD AND DEFLECTION (IN) OF L/480
 - FLOOR TRUSS SYSTEMS DESIGNED WITH 15 PSF DEAD LOAD
- FOR 115 AND 120 MPH WIND ZONES, FOUNDATION ANCHORAGE IS TO COMPLY WITH SECTION R403.6 OF THE NRC, 2018 EDITION. FOR 130 MPH, 140 MPH, AND 150 MPH WIND ZONES, FOUNDATION ANCHORAGE IS TO COMPLY WITH SECTION 450.4 OF THE NRC, 2018 EDITION.
 - ENERGY EFFICIENCY COMPLIANCE AND INSULATION VALUES OF THE BUILDING TO BE IN ACCORDANCE WITH CHAPTER II OF THE NRC, 2018 EDITION.

FOOTING AND FOUNDATION NOTES

- FOUNDATION DESIGN BASED ON A MINIMUM ALLOWABLE BEARING CAPACITY OF 2000 PSF. CONTACT GEOTECHNICAL ENGINEER IF BEARING CAPACITY IS NOT ACHIEVED.
- FOR ALL CONCRETE SLABS AND FOOTINGS, THE AREA WITHIN THE PERIMETER OF THE BUILDING ENVELOPE SHALL HAVE ALL VEGETATION, TOP SOIL, AND FOREIGN MATERIAL REMOVED. FILL MATERIAL SHALL BE FREE OF VEGETATION AND FOREIGN MATERIAL. THE FILL SHALL BE COMPACTED TO ASSURE UNIFORM SUPPORT OF THE SLAB, AND EXCEPT WHERE APPROVED, THE FILL DEPTHS SHALL NOT EXCEED 24" FOR CLEAN SAND OR GRAVEL. A 4" THICK BASE COURSE CONSISTING OF CLEAN GRADED SAND OR GRAVEL SHALL BE PLACED. A BASE COURSE IS NOT REQUIRED WHERE A CONCRETE SLAB IS INSTALLED ON WELL-DRAINED OR SAND-GRAVEL MIXTURE SOILS CLASSIFIED AS GROUP I, ACCORDING TO THE UNITED SOIL CLASSIFICATION SYSTEM IN ACCORDANCE WITH TABLE R405.1 OF THE NRC, 2018 EDITION.
- PROPERLY DEWATER EXCAVATION PRIOR TO POURING CONCRETE WHEN BOTTOM OF CONCRETE SLAB IS AT OR BELOW WATER TABLE. IF APPLICABLE, 3/4" - 1" DEEP CONTROL JOINTS ARE TO BE SALED WITHIN 4 TO 12 HOURS OF CONCRETE FINISHING AND WALL LOCATIONS HAVE BEEN MARKED. ADJUST WHERE NECESSARY.
- CONCRETE SHALL CONFORM TO SECTION R402.2 OF THE NRC, 2018 EDITION. CONCRETE REINFORCING STEEL TO BE ASTM A615 GRADE 60. WELDED WIRE FABRIC TO BE ASTM A105. MAINTAIN A MINIMUM CONCRETE COVER AROUND REINFORCING STEEL OF 3" IN FOOTINGS AND 1 1/2" IN SLABS. FOR POURED CONCRETE WALLS, CONCRETE COVER FOR REINFORCING STEEL MEASURED FROM THE INSIDE FACE OF THE WALL SHALL NOT BE LESS THAN 3/4". CONCRETE COVER FOR REINFORCING STEEL MEASURED FROM THE OUTSIDE FACE OF THE WALL SHALL NOT BE LESS THAN 1 1/2" FOR #5 BARS OR SMALLER, AND NOT LESS THAN 2" FOR #6 BARS OR LARGER.
- MASONRY UNITS TO CONFORM TO ACE 530/ASCE 5/TMS 402. MORTAR SHALL CONFORM TO ASTM C710.
- THE UNSUPPORTED HEIGHT OF MASONRY PIERS SHALL NOT EXCEED FOUR TIMES THEIR LEAST DIMENSION FOR UNFILLED HOLLOW CONCRETE MASONRY UNITS AND TEN TIMES THEIR LEAST DIMENSION FOR SOLID OR SOLID FILLED PIERS. PIERS MAY BE FILLED SOLID WITH CONCRETE OR TYPE M OR S MORTAR. PIERS AND WALLS SHALL BE CAPPED WITH 8" OF SOLID MASONRY.
- THE CENTER OF EACH OF THE PIERS SHALL BEAR IN THE MIDDLE THIRD OF ITS RESPECTIVE FOOTING. EACH GIRDER SHALL BEAR IN THE MIDDLE THIRD OF THE PIERS.
- ALL CONCRETE AND MASONRY FOUNDATION WALLS ARE TO BE CONSTRUCTED IN ACCORDANCE WITH THE PROVISIONS OF SECTION R404 OF THE NRC, 2018 EDITION OR IN ACCORDANCE WITH ACI 318, ACI 332, NCHA TR68-A OR ACE 530/ASCE 5/TMS 402. MASONRY FOUNDATION WALLS ARE TO BE REINFORCED PER TABLE R404.1X(1), R404.1X(2), R404.1X(3), OR R404.1X(4) OF THE NRC, 2018 EDITION. CONCRETE FOUNDATION WALLS ARE TO BE REINFORCED PER TABLE R404.1X(5) OF THE NRC, 2018 EDITION. STEP CONCRETE FOUNDATION WALLS TO 3 x 6 FRAMED WALLS AT 16" O.C. WHERE GRADE PERMITS (UNO).

This sealed page is to be used in conjunction with a full plan set engineered by J.S. Thompson Engineering, Inc. only. Use of this individual sealed page within architectural pages or shop drawings by others is a punishable offense under N.C. Statute § 89C-23

FRAMING NOTES

- ALL FRAMING LUMBER SHALL BE #2 SFF MINIMUM (Fb = 875 PSI, Fv = 375 PSI, E = 1600000 PSI) UNLESS NOTED OTHERWISE (UNO). ALL TREATED LUMBER SHALL BE #2 SYP MINIMUM (Fb = 975 PSI, Fv = 175 PSI, E = 1600000 PSI) UNLESS NOTED OTHERWISE (UNO).
- LAMINATED VENEER LUMBER (LVL) SHALL HAVE THE FOLLOWING MINIMUM PROPERTIES: Fb = 2600 PSI, Fv = 285 PSI, E = 1300000 PSI. LAMINATED STRAND LUMBER (LSL) SHALL HAVE THE FOLLOWING MINIMUM PROPERTIES: Fb = 2375 PSI, Fv = 310 PSI, E = 1550000 PSI. PARALLEL STRAND LUMBER (PSL) UP TO 1" DEPTH SHALL HAVE THE FOLLOWING MINIMUM PROPERTIES: Fc = 2500 PSI, E = 1000000 PSI. PARALLEL STRAND LUMBER (PSL) MORE THAN 1" DEPTH SHALL HAVE THE FOLLOWING MINIMUM PROPERTIES: Fc = 2300 PSI, E = 1000000 PSI. INSTALL ALL CONNECTIONS PER MANUFACTURER'S SPECIFICATIONS.
- STRUCTURAL STEEL SHALL CONFORM TO THE FOLLOWING ASTM SPECIFICATIONS

A. W AND WT SHAPES:	ASTM A992
B. CHANNELS AND ANGLES:	ASTM A36
C. PLATES AND BARS:	ASTM A36
D. HOLLOW STRUCTURAL SECTIONS:	ASTM A500 GRADE B
E. STEEL PIPE:	ASTM A53, GRADE B, TYPE E OR S
- STEEL BEAMS SHALL BE SUPPORTED AT EACH END WITH A MINIMUM BEARING LENGTH OF 3 1/2" AND FULL FLANGE WIDTH (UNO). PROVIDE SOLID BEARING FROM BEAM SUPPORT TO FOUNDATION. BEAMS SHALL BE ATTACHED AT THE BOTTOM FLANGE TO EACH SUPPORT AS FOLLOWS (UNO):

A. WOOD FRAMING	(2) 1/2" DIA. x 4" LONG LAG SCREWS
B. CONCRETE	(2) 1/2" DIA. x 4" WEDGE ANCHORS
C. MASONRY (FULLY GROUTED)	(2) 1/2" DIA. x 4" LONG SIMPSON TITEN HD ANCHORS

LATERAL SUPPORT IS CONSIDERED ADEQUATE PROVIDING THE JOISTS ARE TOE NAILED TO THE 2x NAILER ON TOP OF THE STEEL BEAM, AND THE 2x NAILER IS SECURED TO THE TOP OF THE STEEL BEAM w/ (2) ROWS OF SELF TAPPING SCREWS @ 16" O.C. OR (2) ROWS OF 1/2" DIAMETER BOLTS @ 16" O.C. IF 1/2" BOLTS ARE USED TO FASTEN THE NAILER, THE STEEL BEAM SHALL BE FABRICATED w/ (2) ROWS OF 3/16" DIAMETER HOLES @ 16" O.C.
- SQUARES DENOTE POINT LOADS WHICH REQUIRE SOLID BLOCKING TO GIRDER OR FOUNDATION. SHADED SQUARES DENOTE POINT LOADS FROM ABOVE WHICH REQUIRE SOLID BLOCKING TO SUPPORTING MEMBER BELOW.
- ALL LOAD BEARING HEADERS TO CONFORM TO TABLE R602.1(1) AND R602.1(2) OF THE NRC, 2018 EDITION OR BE (2) 2 x 6 WITH (1) JACK AND (1) KING STUD EACH END (UNO), WHICHEVER IS GREATER. ALL HEADERS TO BE SECURED TO EACH JACK STUD WITH (4) 8d NAILS. ALL BEAMS TO BE SUPPORTED WITH (2) STUDS AT EACH BEARING POINT (UNO). INSTALL KING STUDS PER SECTION R602.13 OF THE NORTH CAROLINA RESIDENTIAL CODE, 2018 EDITION.
- ALL BEAMS, HEADERS, OR GIRDER TRUSSES PARALLEL TO WALL ARE TO BEAR FULLY ON (1) JACK OR (2) STUDS MINIMUM OR THE NUMBER OF JACKS OR STUDS NOTED. ALL BEAMS OR GIRDER TRUSSES PERPENDICULAR TO WALL AND SUPPORTED BY (3) STUDS OR LESS ARE TO HAVE 1 1/2" MINIMUM BEARING (UNO). ALL BEAMS OR GIRDER TRUSSES PERPENDICULAR TO WALL AND SUPPORTED BY MORE THAN (3) STUDS OR ANOTHER NOTED COLUMN ARE TO BEAR FULLY ON SUPPORT COLUMN FOR ENTIRE WALL DEPTH (UNO). BEAM ENDS THAT BUTT INTO ONE ANOTHER ARE TO EACH BEAR EQUAL LENGTHS (UNO).
- FLITCH BEAMS SHALL BE BOLTED TOGETHER USING 1/2" DIAMETER BOLTS (ASTM A307) WITH WASHERS PLACED AT THREADED END OF BOLT. BOLTS SHALL BE SPACED AT 24" CENTERS (MAXIMUM), AND STAGGERED AT TOP AND BOTTOM OF BEAM (2" EDGE DISTANCE), WITH (2) BOLTS LOCATED AT 6" FROM EACH END (UNO).
- ALL I-JOIST OR TRUSS LAYOUTS ARE TO BE IN COMPLIANCE WITH THE OVERALL DESIGN SPECIFIED ON THE PLANS. ALL DEVIATIONS ARE TO BE BROUGHT TO THE ATTENTION OF THE ENGINEER OF RECORD PRIOR TO INSTALLATION.
- BRACED WALL PANELS SHALL BE CONSTRUCTED ACCORDING TO THE NORTH CAROLINA RESIDENTIAL CODE 2018 EDITION WALL BRACING CRITERIA. THE AMOUNT, LENGTH, AND LOCATION OF BRACING SHALL COMPLY WITH ALL APPLICABLE TABLES IN SECTION R602.10.
- PROVIDE DOUBLE JOIST UNDER ALL WALLS PARALLEL TO FLOOR JOISTS. PROVIDE SUPPORT UNDER ALL WALLS PARALLEL TO FLOOR TRUSSES OR I-JOISTS PER MANUFACTURER'S SPECIFICATIONS. INSTALL BLOCKING BETWEEN JOISTS OR TRUSSES FOR POINT LOAD SUPPORT FOR ALL POINT LOADS ALONG OFFSET LOAD LINES.
- FOR ALL HEADERS SUPPORTING BRICK VENEER THAT ARE LESS THAN 8'-0" IN LENGTH, REST A 6" x 4" x 5/16" STEEL ANGLE WITH 6" MINIMUM EMBEDMENT AT SIDES FOR BRICK SUPPORT (UNO). FOR ALL HEADERS 8'-0" AND GREATER IN LENGTH, BOLT A 6" x 4" x 5/16" STEEL ANGLE TO HEADER WITH 1/2" LAG SCREWS AT 12" O.C. STAGGERED FOR BRICK SUPPORT. FOR ALL BRICK SUPPORT AT ROOF LINES, BOLT A 6" x 4" x 5/16" STEEL ANGLE TO (2) 2 x 10 BLOCKING INSTALLED w/ (4) 12d NAILS EA. PLY BETWEEN WALL STUDS WITH (2) ROWS OF 1/2" LAG SCREWS AT 12" O.C. STAGGERED AND IN ACCORDANCE WITH SECTION R103.2(2) OF THE NRC, 2018 EDITION.
- FOR STICK FRAMED ROOFS: CIRCLES DENOTE (3) 2 x 4 POSTS FOR ROOF MEMBER SUPPORT. HIP SPLICES ARE TO BE SPACED A MINIMUM OF 8'-0". FASTEN MEMBERS WITH THREE ROWS OF 12d NAILS AT 16" O.C. FRAME DORMER WALLS ON TOP OF DOUBLE OR TRIPLE RAFTERS AS SHOWN (UNO).
- FOR TRUSSED ROOFS: FRAME DORMER WALLS ON TOP OF 2 x 4 LADDER FRAMING AT 24" O.C. BETWEEN ADJACENT ROOF TRUSSES. STICK FRAME OVER-FRAMED ROOF SECTIONS WITH 2 x 8 RIDGES, 2 x 6 RAFTERS AT 16" O.C. AND FLAT 2 x 10 VALLEYS (UNO).
- ALL 4 x 4 AND 6 x 6 POSTS TO BE INSTALLED WITH 1000 LB CAPACITY UPLIFT CONNECTORS TOP AND BOTTOM (UNO). POSTS MAY BE SECURED USING ONE SIMPSON H6 OR L7S12 UPLIFT CONNECTOR FASTENED TO THE BAND AT THE BOTTOM AND THE BEAM AT THE TOP OF EACH POST. ONE 16" SECTION OF SIMPSON C816 COLL. STRAPPING WITH (8) 8d HDG NAILS AT EACH END MAY BE USED IN LIEU OF EACH TWIST STRAP IF DESIRED. FOR MASONRY OR CONCRETE FOUNDATION USE SIMPSON POST BASE.

**J.S. THOMPSON
ENGINEERING, INC**
606 WADE AVE., SUITE 104 RALEIGH, NC 27605
PHONE (919) 789-9919 FAX (919) 789-9921
N.C. LICENSE NO.: C-1733

120 MPH - 130 MPH ULTIMATE DESIGN WIND SPEED
STANDARD STRUCTURAL NOTES



DATE: NOVEMBER 14, 2018
DRAWN BY: JES
ENGINEERED BY: JST

S0
STRUCTURAL
NOTES

3/6/2020