

Job 20083567F	Truss FG1	Truss Type Floor Girder	Qty 1	Ply 1	THE NELSON CRAFTSMAN FLOORS
------------------	--------------	----------------------------	----------	----------	-----------------------------

UFP Mid Atlantic LLC, 5631 S. NC 62, Burlington, NC

8:330 s Apr 7 2020 MiTek Industries, Inc. Wed Sep 2 15:38:32 2020 Page 1
ID:ri6G188vpH_Oqfn4vE1rAYzqDyf-d?HiaXHakilXjYtw0v_5KABUo?F1ZWjUdBPqvzyheN5

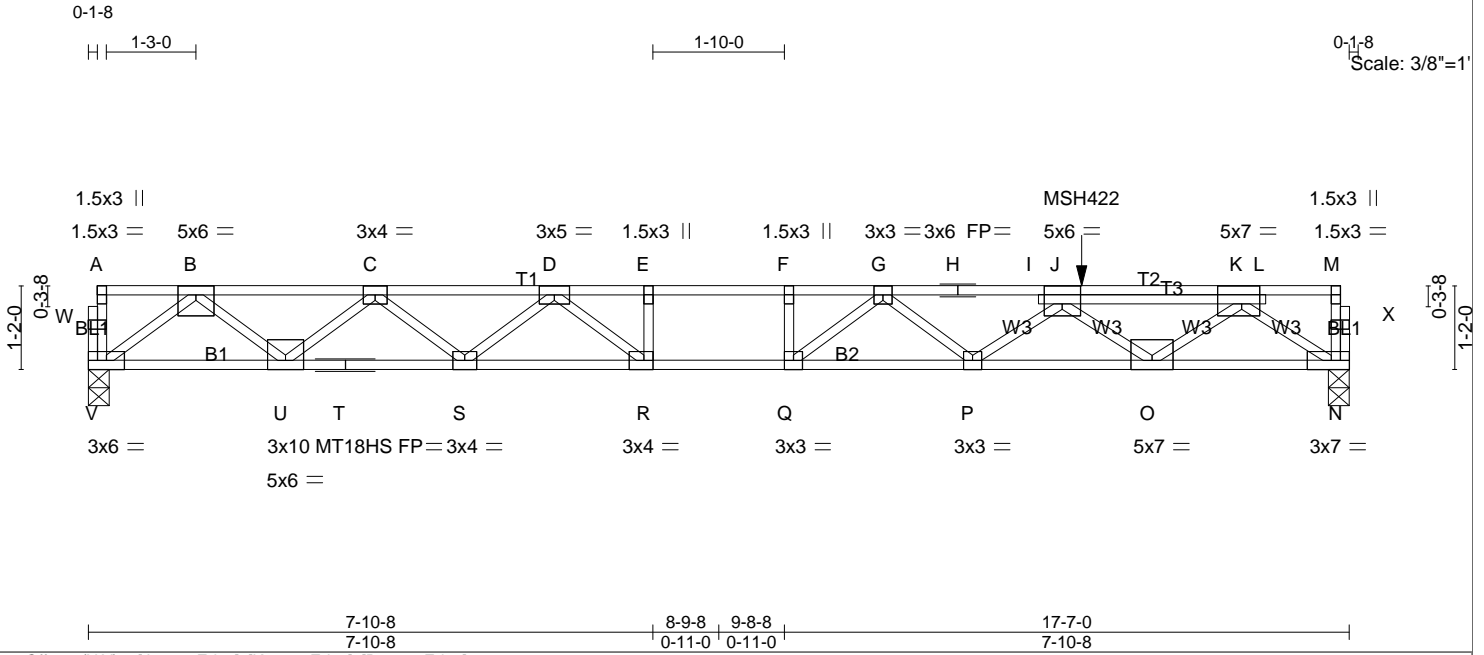

Plate Offsets (X,Y)-- [J:0-3-0,Edge], [K:0-3-0,Edge], [R:0-1-8,Edge]

LOADING (psf)	SPACING-	CSI.	DEFL.	PLATES	GRIP
TCLL 40.0	2-0-0	TC 0.83	in (loc) l/defl L/d	MT20	244/190
TCDL 20.0	Plate Grip DOL 1.00	BC 0.84	Vert(LL) -0.29 Q >718 480	MT18HS	244/190
BCLL 0.0	Lumber DOL 1.00	WB 0.77	Vert(CT) -0.47 P-Q >438 360		
BCDL 5.0	Rep Stress Incr NO	Matrix-SH	Horz(CT) 0.08 N n/a n/a		
	Code IRC2015/TP2014			Weight: 92 lb	FT = 20%F, 12%E

LUMBER-
TOP CHORD 2x4 SP SS(flat)
BOT CHORD 2x4 SP SS(flat)
WEBS 2x4 SP No.3(flat)

BRACING-
TOP CHORD Structural wood sheathing directly applied or 5-7-1 oc purlins, except end verticals.
BOT CHORD Rigid ceiling directly applied or 10-0-0 oc bracing.

REACTIONS. (lb/size) V=1201/0-3-8 (min. 0-1-8), N=1405/0-3-8 (min. 0-1-8)

FORCES. (lb) - Maximum Compression/Maximum Tension
TOP CHORD V-W=-48/0, A-W=-48/0, N-X=-32/0, M-X=-32/0, A-B=-3/0, B-C=-2578/0, C-D=-4245/0, D-E=-5317/0, E-F=-5317/0, F-G=-5317/0, G-H=-4853/0, H-I=-4853/0, I-J=-4808/0, J-K=-3182/0, K-L=-25/0, L-M=-2/0
BOT CHORD U-V=0/1509, T-U=0/3608, S-T=0/3608, R-S=0/4879, Q-R=0/5317, P-Q=0/5206, O-P=0/4422, N-O=0/1913
WEBS B-V=-1889/0, B-U=0/1391, C-U=-1340/0, C-S=0/830, D-S=-825/0, D-R=0/888, E-R=-397/0, K-N=-2346/0, K-O=0/1613, J-O=-1575/0, J-P=0/547, G-P=-459/0, G-Q=-239/411, F-Q=-213/37

- NOTES-**
- 1) Unbalanced floor live loads have been considered for this design.
 - 2) All plates are MT20 plates unless otherwise indicated.
 - 3) This truss is designed in accordance with the 2015 International Residential Code sections R502.11.1 and R802.10.2 and referenced standard ANSI/TPI 1.
 - 4) Recommend 2x6 strongbacks, on edge, spaced at 10-0-0 oc and fastened to each truss with 3-10d (0.131" X 3") nails. Strongbacks to be attached to walls at their outer ends or restrained by other means.
 - 5) Use USP MSH422 (With 10d nails into Girder & 6-10d nails into Truss) or equivalent at 13-10-4 from the left end to connect truss(es) FG2 (1 ply 2x4 SP) to front face of top chord, skewed 0.0 deg.to the left, sloping 0.0 deg. down.
 - 6) Fill all nail holes where hanger is in contact with lumber.
 - 7) In the LOAD CASE(S) section, loads applied to the face of the truss are noted as front (F) or back (B).

LOAD CASE(S) Standard
1) Dead + Floor Live (balanced): Lumber Increase=1.00, Plate Increase=1.00
Uniform Loads (plf)
Vert: N-V=-10, A-M=-120
Concentrated Loads (lb)
Vert: J=-368(F)

Job 20083567F	Truss FG2	Truss Type Floor Girder	Qty 1	Ply 1	THE NELSON CRAFTSMAN FLOORS
------------------	--------------	----------------------------	----------	----------	-----------------------------

UFP Mid Atlantic LLC, 5631 S. NC 62, Burlington, NC
 8.330 s Apr 7 2020 MiTek Industries, Inc. Wed Sep 2 15:38:35 2020 Page 1
 ID:r16G188yH_Oqfn4vE1rAYzqDyf-1ayqCZKS0dga?bVh1Xoyop9ICQzm0hwJ9dU5lyheN2

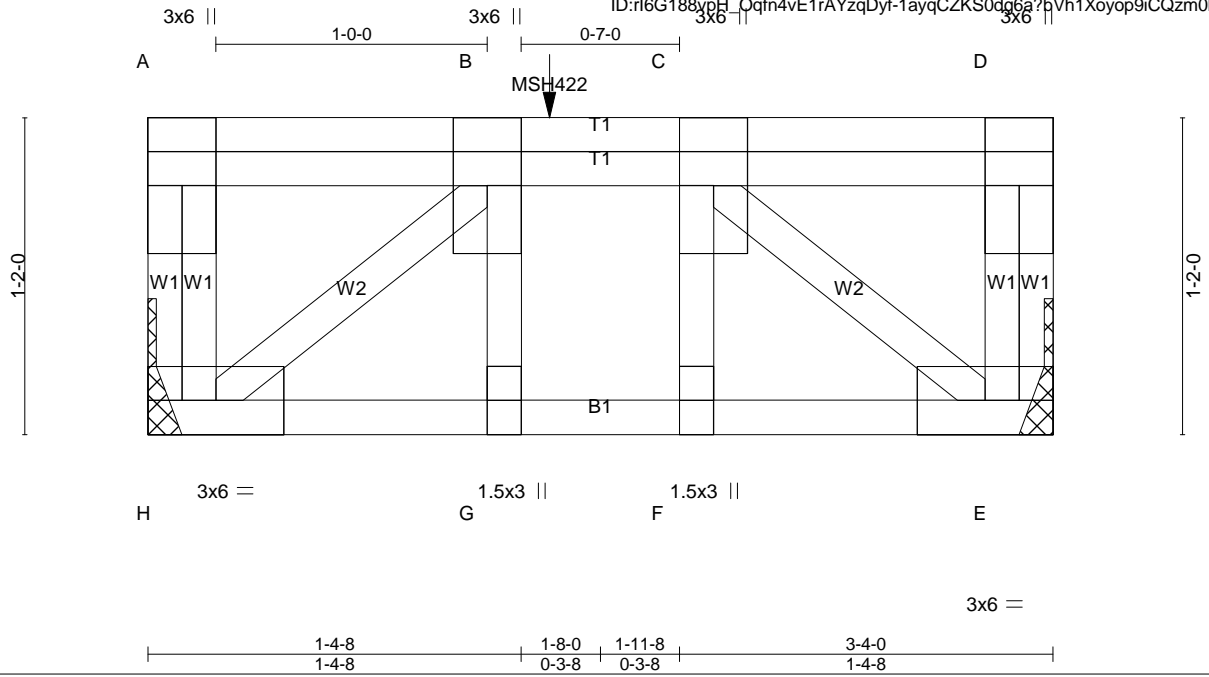

Scale = 1:8.5

LOADING (psf)	SPACING- 2-0-0	CSI.	DEFL. in (loc) l/defl L/d	PLATES GRIP
TCLL 40.0	Plate Grip DOL 1.00	TC 0.22	Vert(LL) -0.01 G >999 480	MT20 244/190
TCDL 20.0	Lumber DOL 1.00	BC 0.31	Vert(CT) -0.01 G >999 360	
BCLL 0.0	Rep Stress Incr NO	WB 0.18	Horz(CT) 0.00 E n/a n/a	
BCDL 5.0	Code IRC2015/TPI2014	Matrix-SH		Weight: 26 lb FT = 20%F, 12%E

LUMBER-	BRACING-
TOP CHORD 2x4 SP No.2(flat)	TOP CHORD Structural wood sheathing directly applied or 3-4-0 oc purlins, except end verticals.
BOT CHORD 2x4 SP No.2(flat)	BOT CHORD Rigid ceiling directly applied or 10-0-0 oc bracing.
WEBS 2x4 SP No.3(flat)	

REACTIONS. (lb/size) H=660/Mechanical, E=488/Mechanical

FORCES. (lb) - Maximum Compression/Maximum Tension
 TOP CHORD A-H=-158/0, D-E=-11/43, A-B=0/0, B-C=-590/0, C-D=0/0
 BOT CHORD G-H=0/590, F-G=0/590, E-F=0/590
 WEBS B-H=-765/0, B-G=-65/0, C-E=-765/0, C-F=0/78

- NOTES-**
- 1) Unbalanced floor live loads have been considered for this design.
 - 2) This truss is designed in accordance with the 2015 International Residential Code sections R502.11.1 and R802.10.2 and referenced standard ANSI/TPI 1.
 - 3) Recommend 2x6 strongbacks, on edge, spaced at 10-0-0 oc and fastened to each truss with 3-10d (0.131" X 3") nails. Strongbacks to be attached to walls at their outer ends or restrained by other means.
 - 4) Use USP MSH422 (With 10d nails into Girder & 6-10d nails into Truss) or equivalent at 1-5-12 from the left end to connect truss(es) ft7 (1 ply 2x4 SP) to front face of top chord, skewed 0.0 deg.to the right, sloping 0.0 deg. down.
 - 5) Fill all nail holes where hanger is in contact with lumber.
 - 6) In the LOAD CASE(S) section, loads applied to the face of the truss are noted as front (F) or back (B).

LOAD CASE(S) Standard
 1) Dead + Floor Live (balanced): Lumber Increase=1.00, Plate Increase=1.00
 Uniform Loads (plf)
 Vert: E-H=-10, A-D=-120
 Concentrated Loads (lb)
 Vert: B=-747(F)

UFP Mid Atlantic LLC, 5631 S. NC 62, Burlington, NC

8.330 s Apr 7 2020 MiTek Industries, Inc. Wed Sep 2 15:38:39 2020 Page 1
ID:xlzMnvGHv6zQ6pXlgn70Kzc57X-wLCL2xNz4sAY3dvGwtck6e_hdpchimaWEnbiE3yheN

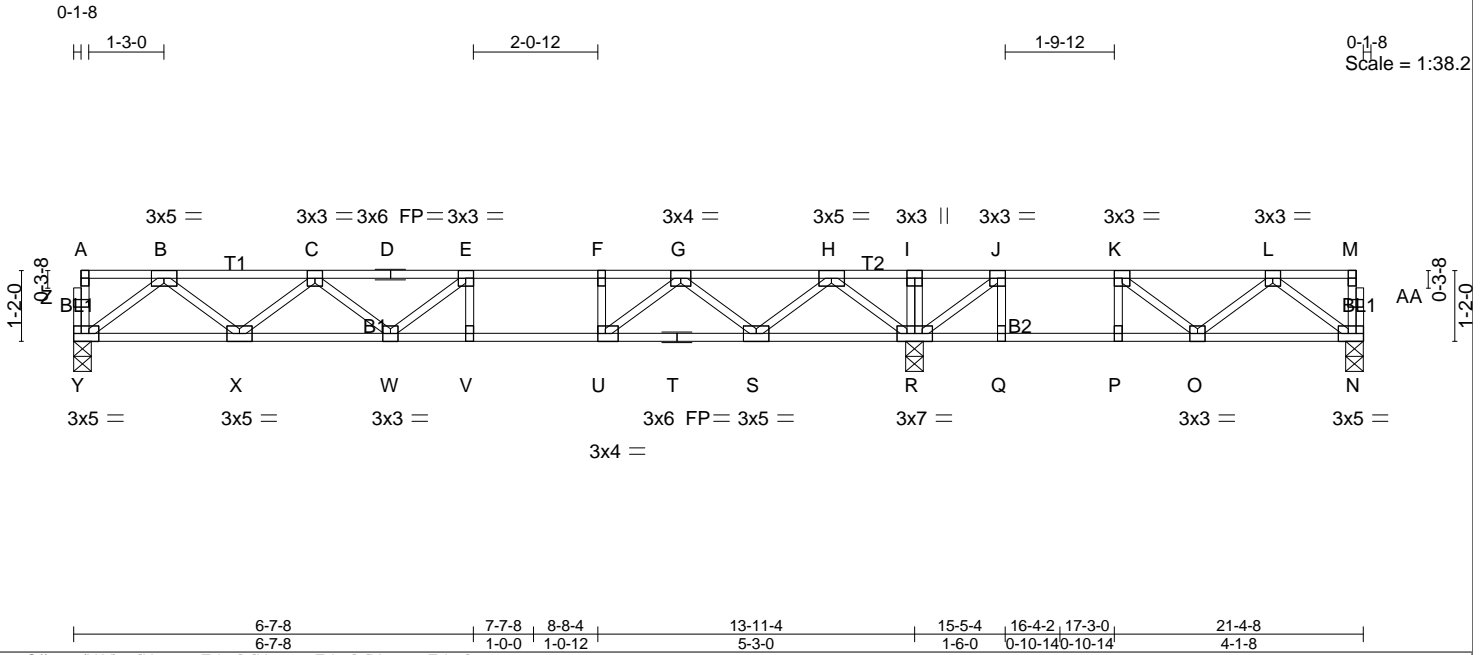

Plate Offsets (X,Y)-- [N:0-2-0,Edge], [U:0-1-8,Edge], [Y:0-2-0,Edge]

LOADING (psf)	SPACING- 2-0-0	CSI.	DEFL. in (loc) l/defl L/d	PLATES	GRIP
TCLL 40.0	Plate Grip DOL 1.00	TC 0.86	Vert(LL) -0.17 V-W >989 480	MT20	244/190
TCDL 20.0	Lumber DOL 1.00	BC 0.97	Vert(CT) -0.26 V-W >626 360		
BCLL 0.0	Rep Stress Incr YES	WB 0.44	Horz(CT) 0.04 N n/a n/a		
BCDL 5.0	Code IRC2015/TPI2014	Matrix-SH			Weight: 106 lb FT = 20%F, 12%E

LUMBER-
TOP CHORD 2x4 SP No.2(flat)
BOT CHORD 2x4 SP No.1(flat)
WEBS 2x4 SP No.3(flat)

BRACING-
TOP CHORD Structural wood sheathing directly applied or 5-10-6 oc purlins, except end verticals.
BOT CHORD Rigid ceiling directly applied or 2-2-0 oc bracing.

REACTIONS. (lb/size) Y=867/0-3-8 (min. 0-1-8), N=425/0-3-8 (min. 0-1-8), R=1439/0-3-8 (min. 0-1-8)
Max GravY=871(LC 10), N=481(LC 4), R=1439(LC 1)

FORCES. (lb) - Maximum Compression/Maximum Tension
TOP CHORD Y-Z=-50/0, A-Z=-50/0, N-AA=-24/0, M-AA=-24/0, A-B=-3/0, B-C=-1748/0, C-D=-2636/0, D-E=-2636/0, E-F=-2769/0, F-G=-2769/0, G-H=-1570/0, H-I=-83/535, I-J=-83/535, J-K=-784/71, K-L=-757/0, L-M=-1/0
BOT CHORD X-Y=0/1070, W-X=0/2401, V-W=0/2769, U-V=0/2769, T-U=0/2262, S-T=0/2262, R-S=0/879, Q-R=-71/784, P-Q=-71/784, O-P=-71/784, N-O=0/597
WEBS E-V=-174/26, F-U=-317/0, I-R=-54/42, B-Y=-1339/0, B-X=0/883, C-X=-850/0, C-W=0/369, H-R=-1459/0, H-S=0/924, G-S=-946/0, G-U=0/761, L-N=-747/0, L-O=-48/209, K-O=-34/212, K-P=-236/0, J-R=-1068/0, J-Q=0/247, E-W=-360/0

- NOTES-**
- 1) Unbalanced floor live loads have been considered for this design.
 - 2) All plates are 1.5x3 MT20 unless otherwise indicated.
 - 3) This truss is designed in accordance with the 2015 International Residential Code sections R502.11.1 and R802.10.2 and referenced standard ANSI/TPI 1.
 - 4) Recommend 2x6 strongbacks, on edge, spaced at 10-0-0 oc and fastened to each truss with 3-10d (0.131" X 3") nails. Strongbacks to be attached to walls at their outer ends or restrained by other means.
 - 5) CAUTION, Do not erect truss backwards.

LOAD CASE(S) Standard

UFP Mid Atlantic LLC, 5631 S. NC 62, Burlington, NC

8.330 s Apr 7 2020 MiTek Industries, Inc. Wed Sep 2 15:38:41 2020 Page 1
 ID:xhlzMnvGHv6zQ6pXlgn70Kzc57X-skJ5TcODcTQG1w3f1leCB33ArdTfAjtoh54olyyhemy

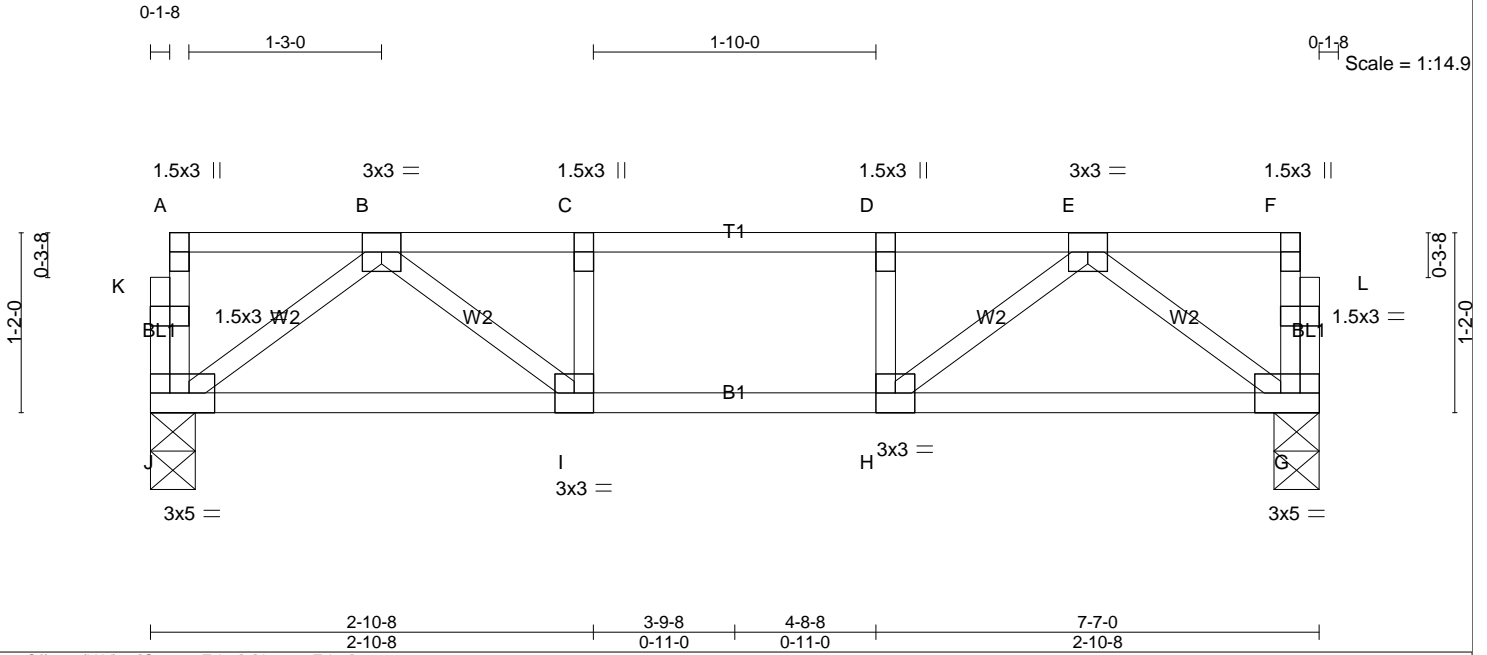

Plate Offsets (X,Y)-- [G:0-2-0,Edge], [J:0-2-0,Edge]

LOADING (psf)	SPACING- 2-0-0	CSI.	DEFL. in (loc) l/defl L/d	PLATES GRIP
TCLL 40.0	Plate Grip DOL 1.00	TC 0.30	Vert(LL) -0.03 I-J >999 480	MT20 244/190
TCDL 20.0	Lumber DOL 1.00	BC 0.29	Vert(CT) -0.04 I-J >999 360	
BCLL 0.0	Rep Stress Incr YES	WB 0.20	Horz(CT) 0.01 G n/a n/a	
BCDL 5.0	Code IRC2015/TPI2014	Matrix-SH		Weight: 39 lb FT = 20%F, 12%E

LUMBER-
 TOP CHORD 2x4 SP No.2(flat)
 BOT CHORD 2x4 SP No.2(flat)
 WEBS 2x4 SP No.3(flat)

BRACING-
 TOP CHORD Structural wood sheathing directly applied or 6-0-0 oc purlins, except end verticals.
 BOT CHORD Rigid ceiling directly applied or 10-0-0 oc bracing.

REACTIONS. (lb/size) J=469/0-3-8 (min. 0-1-8), G=469/0-3-8 (min. 0-1-8)

FORCES. (lb) - Maximum Compression/Maximum Tension
 TOP CHORD J-K=-67/0, A-K=-67/0, G-L=-67/0, F-L=-67/0, A-B=-4/0, B-C=-809/0, C-D=-809/0, D-E=-809/0, E-F=-4/0
 BOT CHORD I-J=0/519, H-I=0/809, G-H=0/519
 WEBS B-J=-646/0, B-I=0/412, C-I=-210/0, E-G=-646/0, E-H=0/412, D-H=-210/0

NOTES-
 1) Unbalanced floor live loads have been considered for this design.
 2) This truss is designed in accordance with the 2015 International Residential Code sections R502.11.1 and R802.10.2 and referenced standard ANSI/TPI 1.
 3) Recommend 2x6 strongbacks, on edge, spaced at 10-0-0 oc and fastened to each truss with 3-10d (0.131" X 3") nails. Strongbacks to be attached to walls at their outer ends or restrained by other means.

LOAD CASE(S) Standard

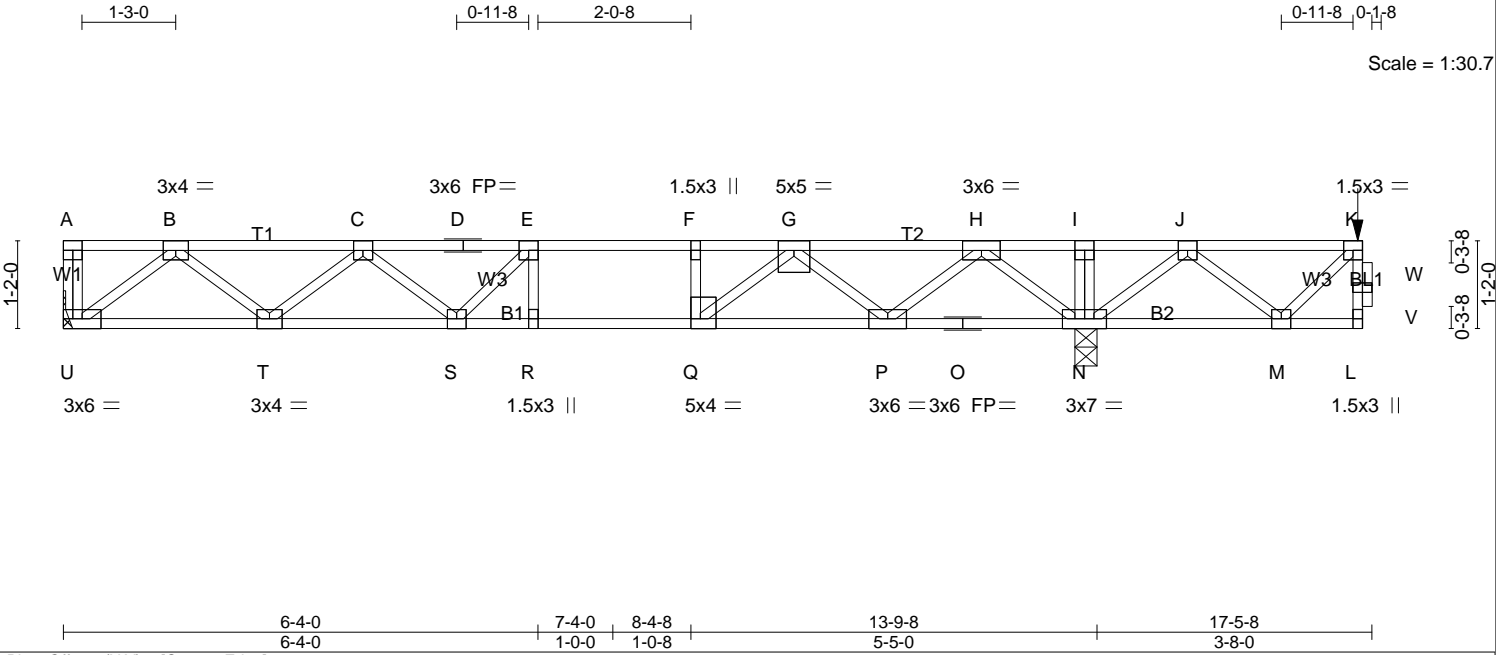

Plate Offsets (X,Y)-- [Q:0-1-8,Edge]

LOADING (psf)	SPACING- 2-0-0	CSI.	DEFL. in (loc) l/defl L/d	PLATES GRIP
TCLL 40.0	Plate Grip DOL 1.00	TC 0.68	Vert(LL) -0.13 R-S >999 480	MT20 244/190
TCDL 20.0	Lumber DOL 1.00	BC 0.77	Vert(CT) -0.21 R-S >775 360	
BCLL 0.0	Rep Stress Incr NO	WB 0.54	Horz(CT) 0.03 N n/a n/a	
BCDL 5.0	Code IRC2015/TPI2014	Matrix-SH		Weight: 89 lb FT = 20%F, 12%E

LUMBER- TOP CHORD 2x4 SP SS(flat) BOT CHORD 2x4 SP SS(flat) WEBS 2x4 SP No.3(flat)	BRACING- TOP CHORD Structural wood sheathing directly applied or 6-0-0 oc purlins, except end verticals. BOT CHORD Rigid ceiling directly applied or 6-0-0 oc bracing.
--	---

REACTIONS. (lb/size) U=732/Mechanical, N=1796/0-3-8 (min. 0-1-8)
Max GravU=822(LC 3), N=1796(LC 1)

FORCES. (lb) - Maximum Compression/Maximum Tension
 TOP CHORD A-U=-56/0, L-V=0/7, V-W=0/7, K-W=0/7, A-B=0/0, B-C=-1604/0, C-D=-2359/0, D-E=-2359/0, E-F=-2394/0, F-G=-2394/0, G-H=-1135/862, H-I=0/1847, I-J=0/1847, J-K=0/409
 BOT CHORD T-U=0/998, S-T=0/2183, R-S=0/2394, Q-R=0/2394, P-Q=-420/1853, O-P=-1270/436, N-O=-1270/436, M-N=-919/0, L-M=0/0
 WEBS E-R=-342/5, F-Q=-456/0, I-N=-104/0, B-U=-1253/0, B-T=0/788, C-T=-754/0, C-S=-137/324, J-N=-1164/0, J-M=0/666, H-N=-1556/0, H-P=0/1032, G-P=-1099/0, G-Q=0/1124, K-M=-585/0, E-S=-260/414

- NOTES-**
- 1) Unbalanced floor live loads have been considered for this design.
 - 2) All plates are 3x3 MT20 unless otherwise indicated.
 - 3) This truss is designed in accordance with the 2015 International Residential Code sections R502.11.1 and R802.10.2 and referenced standard ANSI/TPI 1.
 - 4) Recommend 2x6 strongbacks, on edge, spaced at 10-0-0 oc and fastened to each truss with 3-10d (0.131" X 3") nails. Strongbacks to be attached to walls at their outer ends or restrained by other means.
 - 5) CAUTION, Do not erect truss backwards.

LOAD CASE(S) Standard
 1) Dead + Floor Live (balanced): Lumber Increase=1.00, Plate Increase=1.00
 Uniform Loads (plf)
 Vert: L-U=-10, A-K=-120
 Concentrated Loads (lb)
 Vert: K=-300

Job 20083567F	Truss FT4	Truss Type Floor	Qty 3	Ply 1	THE NELSON CRAFTSMAN FLOORS
------------------	--------------	---------------------	----------	----------	-----------------------------

UFP Mid Atlantic LLC, 5631 S. NC 62, Burlington, NC

8.330 s Apr 7 2020 MiTek Industries, Inc. Wed Sep 2 15:38:46 2020 Page 1

ID:xhIzMnvGHv6zQ6pXlgn70Kzc57X-Dh7_VKSMR03YPixdqrENU7mvNe0TrxbYrNoZz9yheM

0-1-8

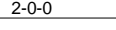
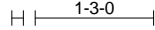

Scale = 1:24.4

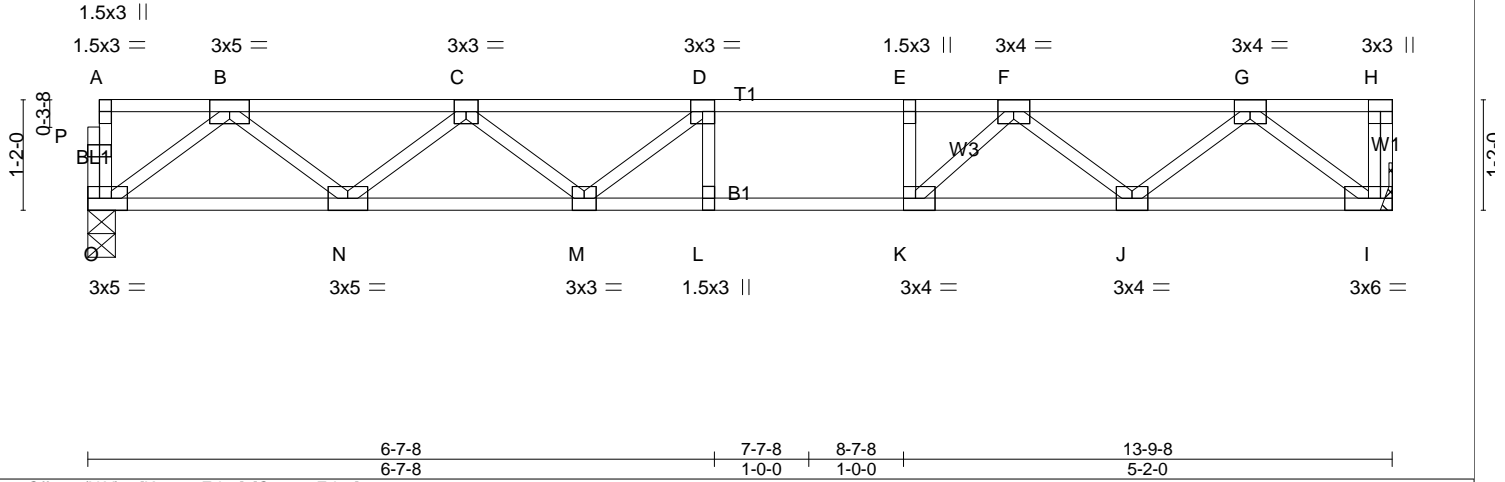

Plate Offsets (X,Y)-- [K:0-1-8,Edge], [O:0-2-0,Edge]

LOADING (psf)	SPACING- 2-0-0	CSI.	DEFL. in (loc) l/defl L/d	PLATES	GRIP
TCLL 40.0	Plate Grip DOL 1.00	TC 0.76	Vert(LL) -0.16 L-M >999 480	MT20	244/190
TCDL 20.0	Lumber DOL 1.00	BC 0.96	Vert(CT) -0.25 L-M >643 360		
BCLL 0.0	Rep Stress Incr YES	WB 0.42	Horz(CT) 0.04 I n/a n/a		
BCDL 5.0	Code IRC2015/TPI2014	Matrix-SH		Weight: 69 lb	FT = 20%F, 12%E

LUMBER-	BRACING-
TOP CHORD 2x4 SP No.2(flat)	TOP CHORD Structural wood sheathing directly applied or 6-0-0 oc purlins, except end verticals.
BOT CHORD 2x4 SP No.1(flat)	BOT CHORD Rigid ceiling directly applied or 2-2-0 oc bracing.
WEBS 2x4 SP No.3(flat)	

REACTIONS. (lb/size) O=873/0-3-8 (min. 0-1-8), I=880/Mechanical

FORCES. (lb) - Maximum Compression/Maximum Tension
TOP CHORD O-P=-51/0, A-P=-51/0, H-I=-45/0, A-B=-3/0, B-C=-1752/0, C-D=-2644/0, D-E=-2786/0, E-F=-2786/0, F-G=-1728/0, G-H=0/0
BOT CHORD N-O=0/1073, M-N=0/2406, L-M=0/2786, K-L=0/2786, J-K=0/2383, I-J=0/1082
WEBS D-L=-182/42, E-K=-337/0, B-O=-1342/0, B-N=0/884, C-N=-851/0, C-M=0/392, G-I=-1357/0, G-J=0/841, D-M=-399/24, F-J=-853/0, F-K=0/735

- NOTES-**
- 1) Unbalanced floor live loads have been considered for this design.
 - 2) This truss is designed in accordance with the 2015 International Residential Code sections R502.11.1 and R802.10.2 and referenced standard ANSI/TPI 1.
 - 3) Recommend 2x6 strongbacks, on edge, spaced at 10-0-0 oc and fastened to each truss with 3-10d (0.131" X 3") nails. Strongbacks to be attached to walls at their outer ends or restrained by other means.
 - 4) CAUTION, Do not erect truss backwards.

LOAD CASE(S) Standard

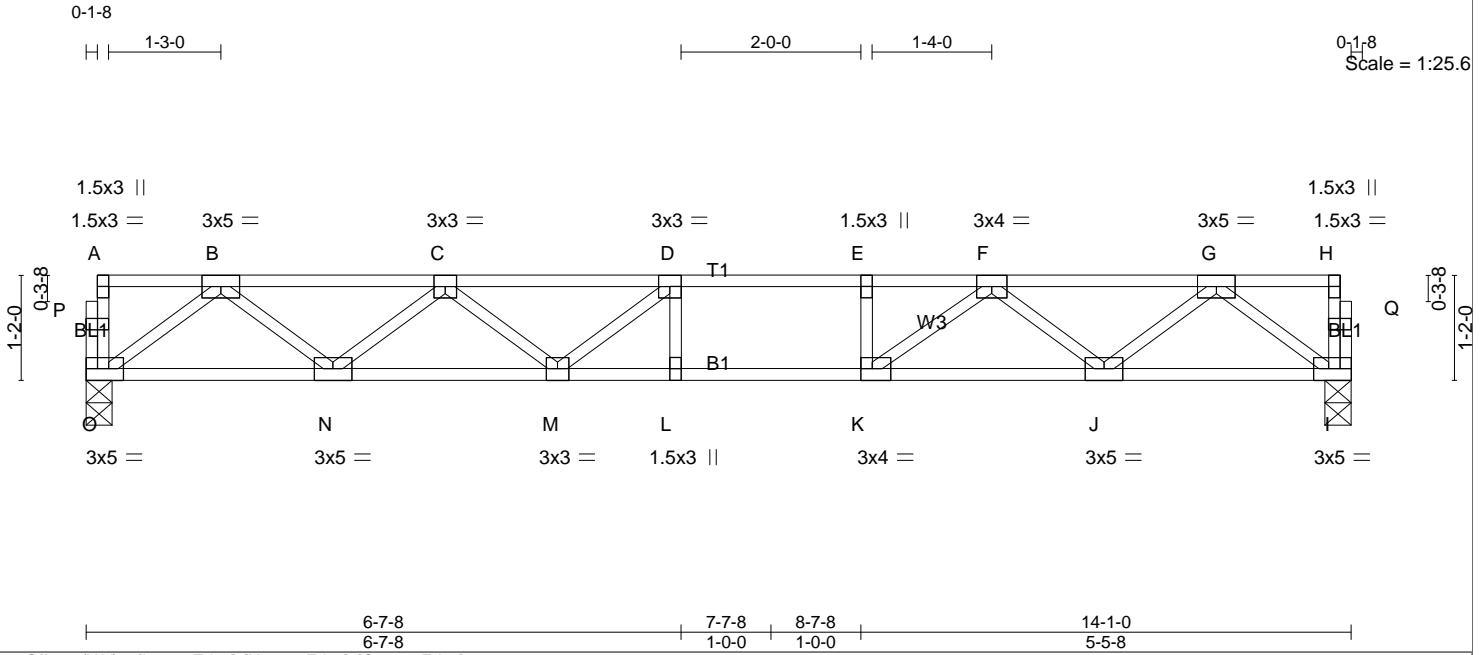

Plate Offsets (X,Y)-- [I:0-2-0,Edge], [K:0-1-8,Edge], [O:0-2-0,Edge]

LOADING (psf)	SPACING- 2-0-0	CSI.	DEFL. in (loc) l/defl L/d	PLATES GRIP
TCLL 40.0	Plate Grip DOL 1.00	TC 0.73	Vert(LL) -0.16 L-M >999 480	MT20 244/190
TCDL 20.0	Lumber DOL 1.00	BC 0.95	Vert(CT) -0.26 L-M >642 360	
BCLL 0.0	Rep Stress Incr YES	WB 0.43	Horz(CT) 0.04 I n/a n/a	
BCDL 5.0	Code IRC2015/TPI2014	Matrix-SH		Weight: 70 lb FT = 20%F, 12%E

LUMBER-
TOP CHORD 2x4 SP No.2(flat)
BOT CHORD 2x4 SP No.1(flat)
WEBS 2x4 SP No.3(flat)

BRACING-
TOP CHORD Structural wood sheathing directly applied or 6-0-0 oc purlins, except end verticals.
BOT CHORD Rigid ceiling directly applied or 10-0-0 oc bracing, Except:
2-2-0 oc bracing: K-L.

REACTIONS. (lb/size) O=892/0-3-8 (min. 0-1-8), I=892/0-3-8 (min. 0-1-8)

FORCES. (lb) - Maximum Compression/Maximum Tension
TOP CHORD O-P=-50/0, A-P=-50/0, I-Q=-41/0, H-Q=-41/0, A-B=-3/0, B-C=-1799/0, C-D=-2737/0, D-E=-2920/0, E-F=-2920/0, F-G=-1778/0, G-H=-2/0
BOT CHORD N-O=0/1098, M-N=0/2473, L-M=0/2920, K-L=0/2920, J-K=0/2446, I-J=0/1107
WEBS D-L=-174/61, E-K=-304/0, B-O=-1374/0, B-N=0/912, C-N=-877/0, C-M=0/422, G-I=-1385/0, G-J=0/874, F-J=-869/0, F-K=0/768, D-M=-447/0

NOTES-
1) Unbalanced floor live loads have been considered for this design.
2) This truss is designed in accordance with the 2015 International Residential Code sections R502.11.1 and R802.10.2 and referenced standard ANSI/TPI 1.
3) Recommend 2x6 strongbacks, on edge, spaced at 10-0-0 oc and fastened to each truss with 3-10d (0.131" X 3") nails. Strongbacks to be attached to walls at their outer ends or restrained by other means.

LOAD CASE(S) Standard

Job 20083567F	Truss FT6	Truss Type Floor	Qty 1	Ply 1	THE NELSON CRAFTSMAN FLOORS
------------------	--------------	---------------------	----------	----------	-----------------------------

UFP Mid Atlantic LLC, 5631 S. NC 62, Burlington, NC

8.330 s Apr 7 2020 MiTek Industries, Inc. Wed Sep 2 15:38:54 2020 Page 1

ID:xhlzMnvGHv6zQ6pXlgn70Kzc57X-_Ec0B3YNYT3QMwY9IXNFDp5G5slfjVoigck_FiyneM

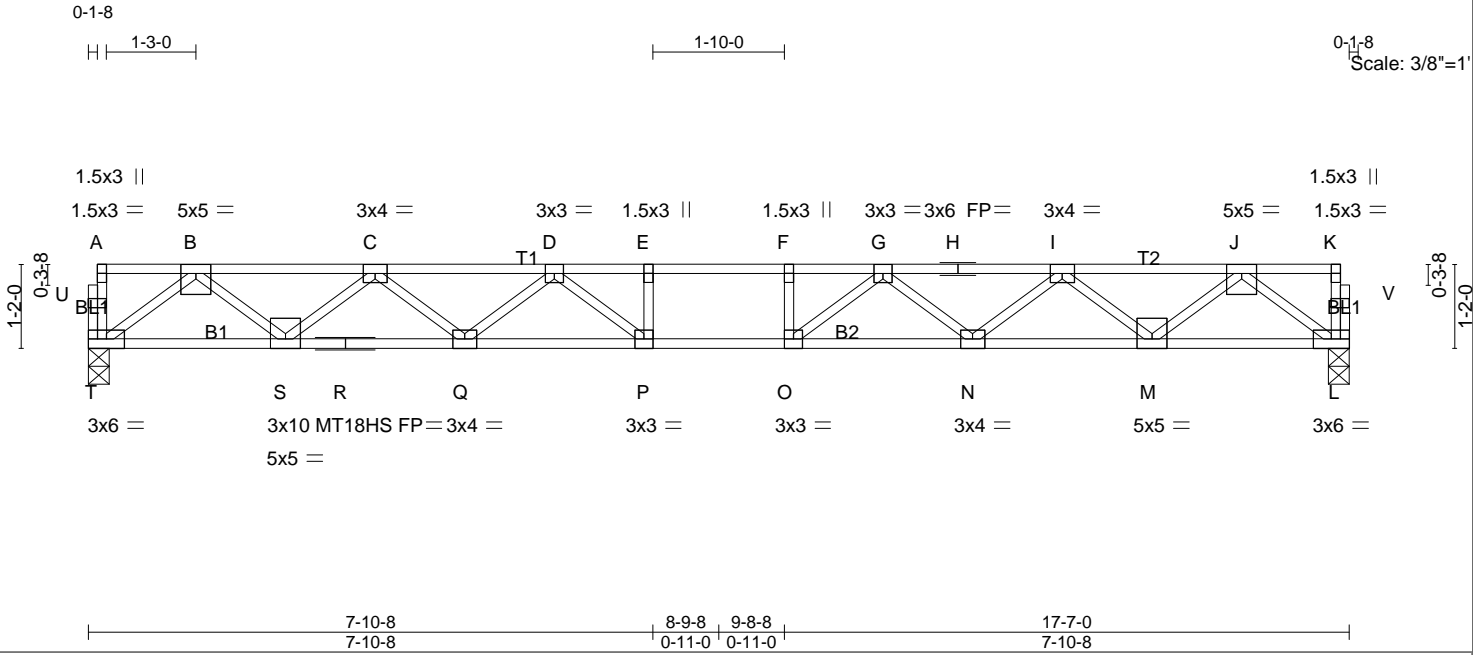

LOADING (psf)	SPACING-	CSI.	DEFL.	PLATES	GRIP
TCLL 40.0	2-0-0	TC 0.78	in (loc) l/defl L/d	MT20	244/190
TCDL 20.0	Plate Grip DOL 1.00	BC 0.94	Vert(LL) -0.28 O-P >733 480	MT18HS	244/190
BCLL 0.0	Lumber DOL 1.00	WB 0.60	Vert(CT) -0.46 O-P >451 360		
BCDL 5.0	Rep Stress Incr YES	Matrix-SH	Horz(CT) 0.08 L n/a n/a		
	Code IRC2015/TPI2014			Weight: 87 lb	FT = 20%F, 12%E

LUMBER-	BRACING-
TOP CHORD 2x4 SP No.2(flat)	TOP CHORD Structural wood sheathing directly applied or 4-6-4 oc purlins, except end verticals.
BOT CHORD 2x4 SP No.1(flat)	BOT CHORD Rigid ceiling directly applied or 2-2-0 oc bracing.
WEBS 2x4 SP No.3(flat)	

REACTIONS. (lb/size) T=1119/0-3-8 (min. 0-1-8), L=1119/0-3-8 (min. 0-1-8)

FORCES. (lb) - Maximum Compression/Maximum Tension
 TOP CHORD T-U=-47/0, A-U=-47/0, L-V=-47/0, K-V=-47/0, A-B=-3/0, B-C=-2369/0, C-D=-3854/0, D-E=-4633/0, E-F=-4633/0, F-G=-4633/0, G-H=-3854/0, H-I=-3854/0, I-J=-2369/0, J-K=-3/0
 BOT CHORD S-T=0/1401, R-S=0/3304, Q-R=0/3304, P-Q=0/4375, O-P=0/4633, N-O=0/4375, M-N=0/3304, L-M=0/1401
 WEBS B-T=-1754/0, B-S=0/1260, C-S=-1217/0, C-Q=0/716, D-Q=678/0, D-P=-42/657, E-P=-298/0, J-L=-1754/0, J-M=0/1260, I-M=-1217/0, I-N=0/716, G-N=-678/0, G-O=-42/657, F-O=-298/0

- NOTES-**
- 1) Unbalanced floor live loads have been considered for this design.
 - 2) All plates are MT20 plates unless otherwise indicated.
 - 3) This truss is designed in accordance with the 2015 International Residential Code sections R502.11.1 and R802.10.2 and referenced standard ANSI/TPI 1.
 - 4) Recommend 2x6 strongbacks, on edge, spaced at 10-0-0 oc and fastened to each truss with 3-10d (0.131" X 3") nails. Strongbacks to be attached to walls at their outer ends or restrained by other means.

LOAD CASE(S) Standard

Job 20083567F	Truss FT7	Truss Type Floor	Qty 1	Ply 1	THE NELSON CRAFTSMAN FLOORS
------------------	--------------	---------------------	----------	----------	-----------------------------

UFP Mid Atlantic LLC, 5631 S. NC 62, Burlington, NC

8.330 s Apr 7 2020 MitTek Industries, Inc. Wed Sep 2 15:38:58 2020 Page 1

ID: xhlzMnvGHv6zQ6pXlgn70Kzc57X-s?rX1QctciZrrYswXNRBNfG?aU7YfMfJbEiCOTyheMh

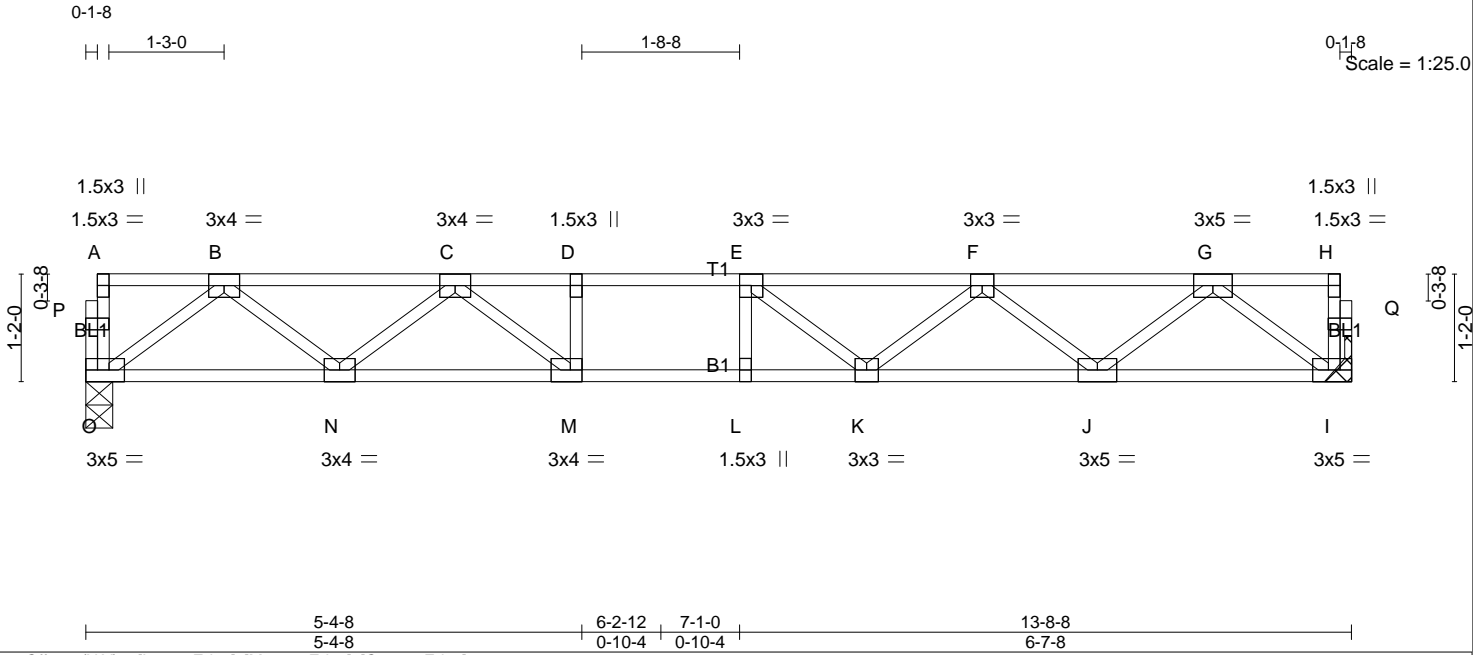

Plate Offsets (X,Y)-- [L:0-2-0,Edge], [M:0-1-8,Edge], [O:0-2-0,Edge]

LOADING (psf)	SPACING- 2-0-0	CSI.	DEFL. in (loc) l/defl L/d	PLATES	GRIP
TCLL 40.0	Plate Grip DOL 1.00	TC 0.62	Vert(LL) -0.14 K-L >999 480	MT20	244/190
TCDL 20.0	Lumber DOL 1.00	BC 0.88	Vert(CT) -0.22 K-L >736 360		
BCLL 0.0	Rep Stress Incr YES	WB 0.42	Horz(CT) 0.04 I n/a n/a		
BCDL 5.0	Code IRC2015/TPI2014	Matrix-SH		Weight: 69 lb	FT = 20%F, 12%E

LUMBER-
TOP CHORD 2x4 SP No.2(flat)
BOT CHORD 2x4 SP No.1(flat)
WEBS 2x4 SP No.3(flat)

BRACING-
TOP CHORD Structural wood sheathing directly applied or 6-0-0 oc purlins, except end verticals.
BOT CHORD Rigid ceiling directly applied or 10-0-0 oc bracing.

REACTIONS. (lb/size) O=867/0-3-8 (min. 0-1-8), I=867/Mechanical

FORCES. (lb) - Maximum Compression/Maximum Tension
TOP CHORD O-P=-41/0, A-P=-41/0, I-Q=-50/0, H-Q=-50/0, A-B=-2/0, B-C=-1718/0, C-D=-2768/0, D-E=-2768/0, E-F=-2617/0, F-G=-1738/0, G-H=-3/0
BOT CHORD N-O=0/1074, M-N=0/2358, L-M=0/2768, K-L=0/2768, J-K=0/2384, I-J=0/1066
WEBS G-I=-1334/0, B-O=-1345/0, G-J=0/875, B-N=0/838, F-J=-840/0, C-N=-833/0, F-K=0/381, C-M=0/693, E-K=-395/21, D-M=-274/0, E-L=-173/51

NOTES-
1) Unbalanced floor live loads have been considered for this design.
2) This truss is designed in accordance with the 2015 International Residential Code sections R502.11.1 and R802.10.2 and referenced standard ANSI/TPI 1.
3) Recommend 2x6 strongbacks, on edge, spaced at 10-0-0 oc and fastened to each truss with 3-10d (0.131" X 3") nails. Strongbacks to be attached to walls at their outer ends or restrained by other means.

LOAD CASE(S) Standard

UFP Mid Atlantic LLC, 5631 S. NC 62, Burlington, NC

8.330 s Apr 7 2020 MiTek Industries, Inc. Wed Sep 2 15:39:03 2020 Page 1
ID:xlhzMnvGHv6zQ6pXlgn70Kzc57X-DyeQ48f0QEC8xJkuKw1M4iznwVtkKZS2IWPz4gyheMc

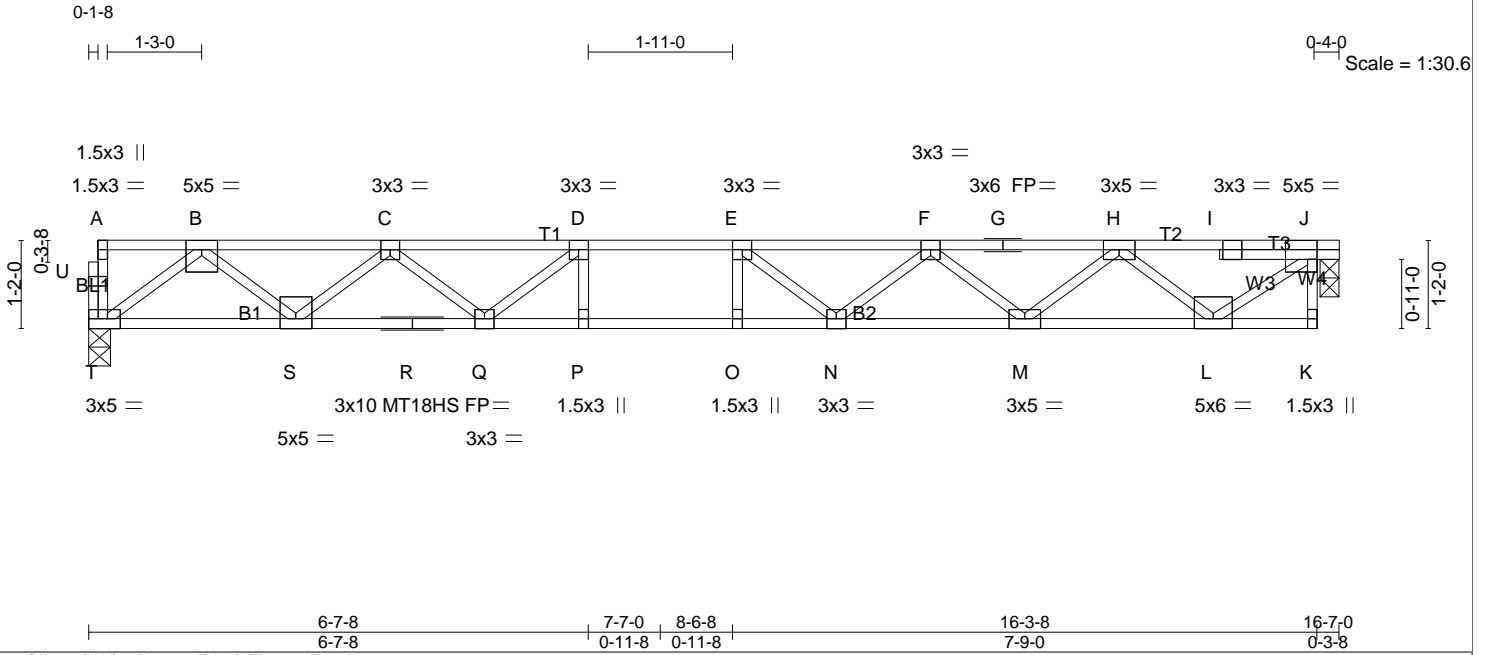

Plate Offsets (X,Y)-- [J:0-1-8,Edge], [T:0-2-0,Edge]

LOADING (psf)	SPACING- 2-0-0	CSI.	DEFL. in (loc) l/defl L/d	PLATES GRIP
TCLL 40.0	Plate Grip DOL 1.00	TC 0.84	Vert(LL) -0.22 O >864 480	MT20 244/190
TCDL 20.0	Lumber DOL 1.00	BC 0.75	Vert(CT) -0.36 O >532 360	MT18HS 244/190
BCLL 0.0	Rep Stress Incr YES	WB 0.70	Horz(CT) -0.01 J n/a n/a	
BCDL 5.0	Code IRC2015/TPI2014	Matrix-SH		Weight: 83 lb FT = 20%F, 12%E

LUMBER- TOP CHORD 2x4 SP No.2(flat) BOT CHORD 2x4 SP SS(flat) WEBS 2x4 SP No.3(flat)	BRACING- TOP CHORD Structural wood sheathing directly applied or 2-2-0 oc purlins, except end verticals. BOT CHORD Rigid ceiling directly applied or 10-0-0 oc bracing.
--	--

REACTIONS. (lb/size) T=1039/0-3-8 (min. 0-1-8), J=1047/0-3-0 (min. 0-1-8)

FORCES. (lb) - Maximum Compression/Maximum Tension
TOP CHORD T-U=-48/0, A-U=-47/0, J-K=0/6, A-B=-3/0, B-C=-2169/0, C-D=-3460/0, D-E=-3990/0, E-F=-3803/0, F-G=-2885/0, G-H=-2885/0, H-I=-1179/0, I-J=-1184/0
BOT CHORD S-T=0/1300, R-S=0/2997, Q-R=0/2997, P-Q=0/3990, O-P=0/3990, N-O=0/3990, M-N=0/3542, L-M=0/2206, K-L=0/0
WEBS J-L=0/1471, B-T=-1627/0, H-L=-1337/0, B-S=0/1131, H-M=0/884, C-S=-1078/0, F-M=-855/0, C-Q=0/642, F-N=0/447, D-Q=-838/0, E-N=-517/66, D-P=-85/258, E-O=-227/117

- NOTES-**
- 1) Unbalanced floor live loads have been considered for this design.
 - 2) All plates are MT20 plates unless otherwise indicated.
 - 3) This truss is designed in accordance with the 2015 International Residential Code sections R502.11.1 and R802.10.2 and referenced standard ANSI/TPI 1.
 - 4) Recommend 2x6 strongbacks, on edge, spaced at 10-0-0 oc and fastened to each truss with 3-10d (0.131" X 3") nails. Strongbacks to be attached to walls at their outer ends or restrained by other means.
 - 5) Gap between inside of top chord bearing and first diagonal or vertical web shall not exceed 0.500in.
 - 6) CAUTION, Do not erect truss backwards.

LOAD CASE(S) Standard

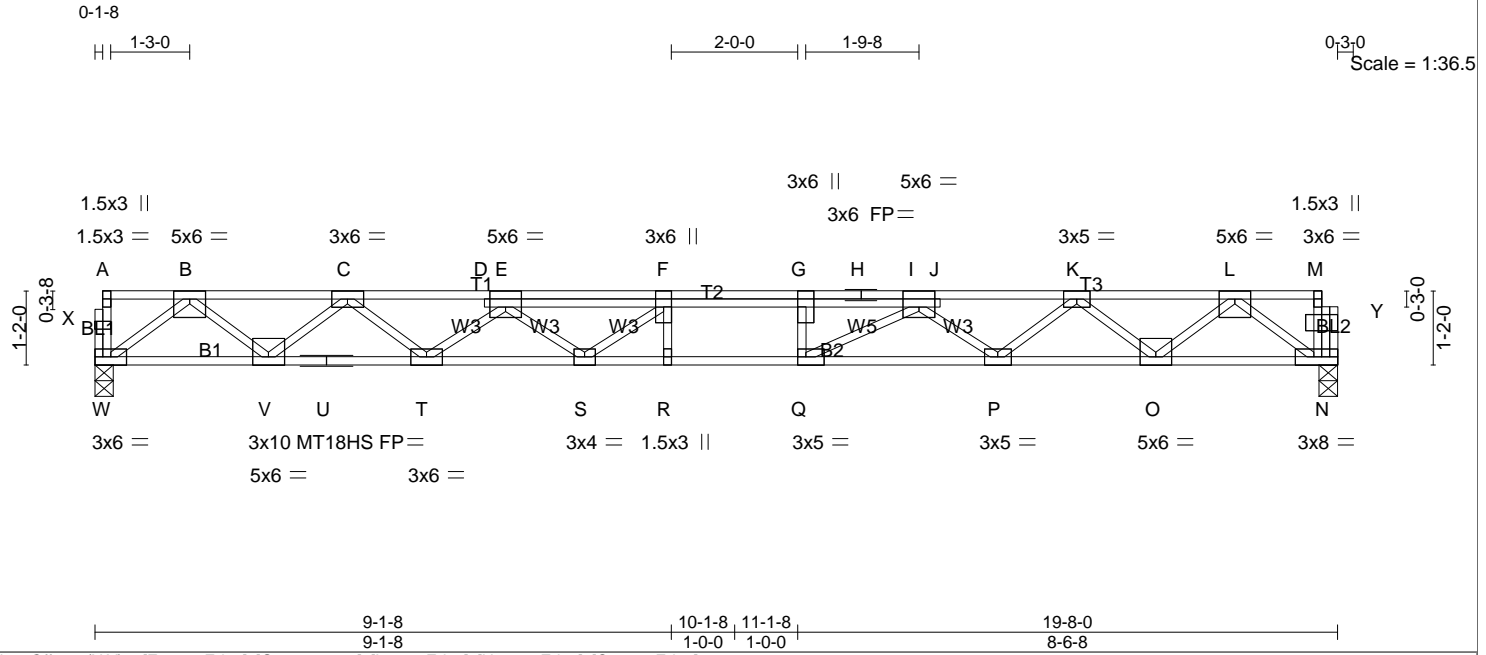

Plate Offsets (X,Y)-- [E:0-3-0,Edge], [G:0-3-0,0-0-0], [I:0-3-0,Edge], [N:0-3-8,Edge], [Q:0-1-8,Edge]

LOADING (psf)	SPACING- 2-0-0	CSI.	DEFL. in (loc) l/defl L/d	PLATES	GRIP
TCLL 40.0	Plate Grip DOL 1.00	TC 0.47	Vert(LL) -0.34 R >691 480	MT20	244/190
TCDL 20.0	Lumber DOL 1.00	BC 0.73	Vert(CT) -0.55 Q-R >425 360	MT18HS	244/190
BCLL 0.0	Rep Stress Incr YES	WB 0.69	Horz(CT) 0.10 N n/a n/a		
BCDL 5.0	Code IRC2015/TPI2014	Matrix-SH			
				Weight: 107 lb	FT = 20%F, 12%E

LUMBER-
 TOP CHORD 2x4 SP SS(flat)
 BOT CHORD 2x4 SP SS(flat)
 WEBS 2x4 SP No.3(flat)

BRACING-
 TOP CHORD Structural wood sheathing directly applied or 6-0-0 oc purlins, except end verticals.
 BOT CHORD Rigid ceiling directly applied or 10-0-0 oc bracing.

REACTIONS. (lb/size) W=1250/0-3-8 (min. 0-1-8), N=1243/0-3-8 (min. 0-1-8)

FORCES. (lb) - Maximum Compression/Maximum Tension
 TOP CHORD W-X=-41/0, A-X=-41/0, N-Y=43/0, M-Y=39/0, A-B=-2/0, B-C=-2690/0, C-D=-4531/0, D-E=-4489/0, E-F=-5752/0, F-G=-6142/0, G-H=-6142/0, H-I=-6142/0, I-J=-4512/0, J-K=-4557/0, K-L=-2746/0, L-M=-5/0
 BOT CHORD V-W=0/1582, U-V=0/3763, T-U=0/3763, S-T=0/5326, R-S=0/6142, Q-R=0/6142, P-Q=0/5321, O-P=0/3815, N-O=0/1642
 WEBS F-R=-74/56, G-Q=-486/0, B-W=-1981/0, B-V=0/1442, C-V=-1396/0, C-T=0/1000, E-T=-1010/0, E-S=0/705, F-S=-729/0, L-N=-2021/0, L-O=0/1437, K-O=-1392/0, K-P=0/966, I-P=-970/0, I-Q=0/1218

NOTES-
 1) Unbalanced floor live loads have been considered for this design.
 2) All plates are MT20 plates unless otherwise indicated.
 3) This truss is designed in accordance with the 2015 International Residential Code sections R502.11.1 and R802.10.2 and referenced standard ANSI/TPI 1.
 4) Recommend 2x6 strongbacks, on edge, spaced at 10-0-0 oc and fastened to each truss with 3-10d (0.131" X 3") nails. Strongbacks to be attached to walls at their outer ends or restrained by other means.

LOAD CASE(S) Standard

Job 20083567F	Truss KW2	Truss Type Floor Supported Gable	Qty 1	Ply 1	THE NELSON CRAFTSMAN FLOORS
------------------	--------------	-------------------------------------	----------	----------	-----------------------------

UFP Mid Atlantic LLC, 5631 S. NC 62, Burlington, NC

8.330 s Apr 7 2020 MiTek Industries, Inc. Wed Sep 2 15:39:15 2020 Page 1

ID:xlzMnvGHv6zQ6pXlgn70Kzc57X-sGNyBpYbwiRN9fB1RFAZET1UK8s88npWOJcV_yheMQ

0-1/8

0-1/8

Scale = 1:25.2

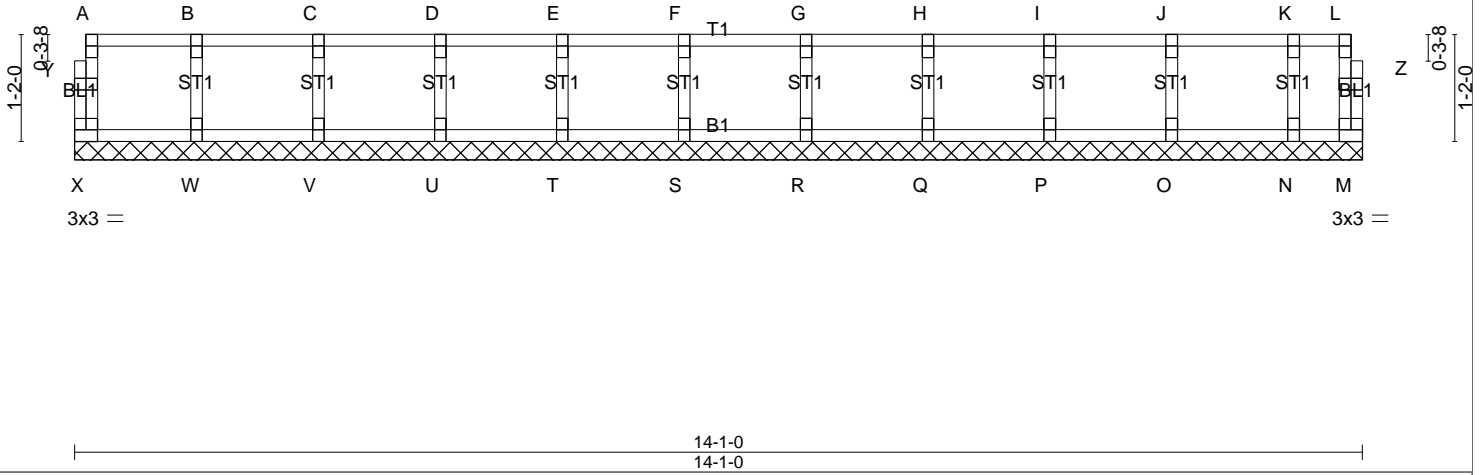

LOADING (psf)	SPACING-	CSI.	DEFL.	PLATES	GRIP
TCLL 40.0	2-0-0	TC 0.10	in (loc) l/defl L/d	MT20	244/190
TCDL 20.0	Plate Grip DOL 1.00	BC 0.02	Vert(LL) n/a - n/a 999		
BCLL 0.0	Lumber DOL 1.00	WB 0.04	Vert(CT) n/a - n/a 999		
BCDL 5.0	Rep Stress Incr YES	Matrix-R	Horz(CT) 0.00 M n/a n/a		
	Code IRC2015/TPI2014			Weight: 60 lb	FT = 20%F, 12%E

LUMBER-	BRACING-
TOP CHORD 2x4 SP No.2(flat)	TOP CHORD Structural wood sheathing directly applied or 6-0-0 oc purlins, except end verticals.
BOT CHORD 2x4 SP No.2(flat)	BOT CHORD Rigid ceiling directly applied or 10-0-0 oc bracing.
WEBS 2x4 SP No.3(flat)	
OTHERS 2x4 SP No.3(flat)	

REACTIONS. (lb/size) X=62/14-1-0 (min. 0-1-8), M=25/14-1-0 (min. 0-1-8), W=174/14-1-0 (min. 0-1-8), V=173/14-1-0 (min. 0-1-8), U=173/14-1-0 (min. 0-1-8), T=173/14-1-0 (min. 0-1-8), S=173/14-1-0 (min. 0-1-8), R=173/14-1-0 (min. 0-1-8), Q=174/14-1-0 (min. 0-1-8), P=171/14-1-0 (min. 0-1-8), O=181/14-1-0 (min. 0-1-8), N=129/14-1-0 (min. 0-1-8)

FORCES. (lb) - Maximum Compression/Maximum Tension
 TOP CHORD X-Y=-59/0, A-Y=-58/0, M-Z=-17/0, L-Z=-17/0, A-B=-7/0, B-C=-7/0, C-D=-7/0, D-E=-7/0, E-F=-7/0, F-G=-7/0, G-H=-7/0, H-I=-7/0, I-J=-7/0, J-K=-7/0, K-L=-7/0
 BOT CHORD W-X=0/7, V-W=0/7, U-V=0/7, T-U=0/7, S-T=0/7, R-S=0/7, Q-R=0/7, P-Q=0/7, O-P=0/7, N-O=0/7, M-N=0/7
 WEBS B-W=-159/0, C-V=-161/0, D-U=-160/0, E-T=-160/0, F-S=-160/0, G-R=-160/0, H-Q=-160/0, I-P=-158/0, J-O=-166/0, K-N=-126/0

- NOTES-**
- 1) All plates are 1.5x3 MT20 unless otherwise indicated.
 - 2) Gable requires continuous bottom chord bearing.
 - 3) Truss to be fully sheathed from one face or securely braced against lateral movement (i.e. diagonal web).
 - 4) Gable studs spaced at 1-4-0 oc.
 - 5) This truss is designed in accordance with the 2015 International Residential Code sections R502.11.1 and R802.10.2 and referenced standard ANSI/TPI 1.
 - 6) Recommend 2x6 strongbacks, on edge, spaced at 10-0-0 oc and fastened to each truss with 3-10d (0.131" X 3") nails. Strongbacks to be attached to walls at their outer ends or restrained by other means.

LOAD CASE(S) Standard

Job 20083567F	Truss KW3	Truss Type Floor Supported Gable	Qty 1	Ply 1	THE NELSON CRAFTSMAN FLOORS
------------------	--------------	-------------------------------------	----------	----------	-----------------------------

UFP Mid Atlantic LLC, 5631 S. NC 62, Burlington, NC

8.330 s Apr 7 2020 MiTek Industries, Inc. Wed Sep 2 15:39:20 2020 Page 1
ID:xlzMnvGHv6zQ6pXlgn70Kzc57X-DEAreythQSLkUwY9q_rLGIAtDLr3pPOYff1NAByheML

0-1-8

Scale = 1:16.3

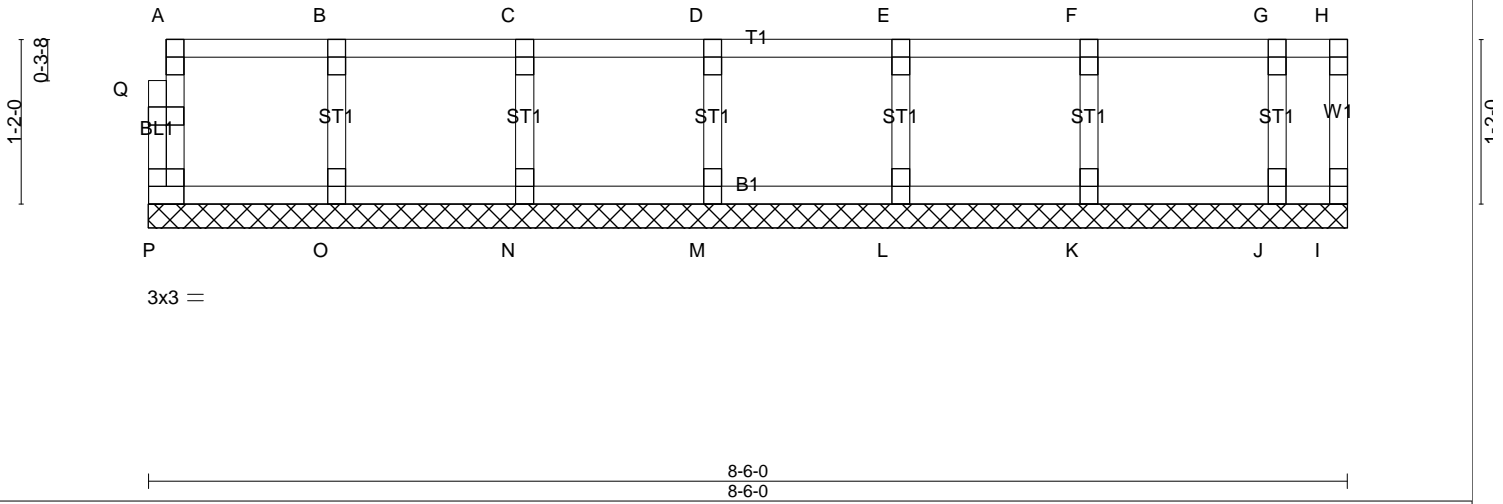

LOADING (psf)	SPACING-	CSI.	DEFL.	PLATES	GRIP
TCLL 40.0	2-0-0	TC 0.10	in (loc) l/defl L/d	MT20	244/190
TCDL 20.0	Plate Grip DOL 1.00	BC 0.02	Vert(LL) n/a - n/a 999		
BCLL 0.0	Lumber DOL 1.00	WB 0.04	Vert(CT) n/a - n/a 999		
BCDL 5.0	Rep Stress Incr YES	Matrix-R	Horz(CT) 0.00 l n/a n/a		
	Code IRC2015/TPI2014			Weight: 37 lb	FT = 20%F, 12%E

LUMBER-	BRACING-
TOP CHORD 2x4 SP No.2(flat)	TOP CHORD Structural wood sheathing directly applied or 6-0-0 oc purlins, except end verticals.
BOT CHORD 2x4 SP No.2(flat)	BOT CHORD Rigid ceiling directly applied or 10-0-0 oc bracing.
WEBS 2x4 SP No.3(flat)	
OTHERS 2x4 SP No.3(flat)	

REACTIONS. (lb/size) P=61/8-6-0 (min. 0-1-8), I=14/8-6-0 (min. 0-1-8), O=176/8-6-0 (min. 0-1-8), N=173/8-6-0 (min. 0-1-8), M=174/8-6-0 (min. 0-1-8), L=171/8-6-0 (min. 0-1-8), K=180/8-6-0 (min. 0-1-8), J=124/8-6-0 (min. 0-1-8)

FORCES. (lb) - Maximum Compression/Maximum Tension
 TOP CHORD P-Q=-58/0, A-Q=-58/0, H-I=-5/0, A-B=-7/0, B-C=-7/0, C-D=-7/0, D-E=-7/0, E-F=-7/0, F-G=-7/0, G-H=-7/0
 BOT CHORD O-P=0/7, N-O=0/7, M-N=0/7, L-M=0/7, K-L=0/7, J-K=0/7, I-J=0/7
 WEBS B-O=-159/0, C-N=-160/0, D-M=-160/0, E-L=-158/0, F-K=-166/0, G-J=-123/0

- NOTES-**
- 1) All plates are 1.5x3 MT20 unless otherwise indicated.
 - 2) Gable requires continuous bottom chord bearing.
 - 3) Truss to be fully sheathed from one face or securely braced against lateral movement (i.e. diagonal web).
 - 4) Gable studs spaced at 1-4-0 oc.
 - 5) This truss is designed in accordance with the 2015 International Residential Code sections R502.11.1 and R802.10.2 and referenced standard ANSI/TPI 1.
 - 6) Recommend 2x6 strongbacks, on edge, spaced at 10-0-0 oc and fastened to each truss with 3-10d (0.131" X 3") nails. Strongbacks to be attached to walls at their outer ends or restrained by other means.
 - 7) CAUTION, Do not erect truss backwards.

LOAD CASE(S) Standard

0-1-8

Scale = 1:17.9

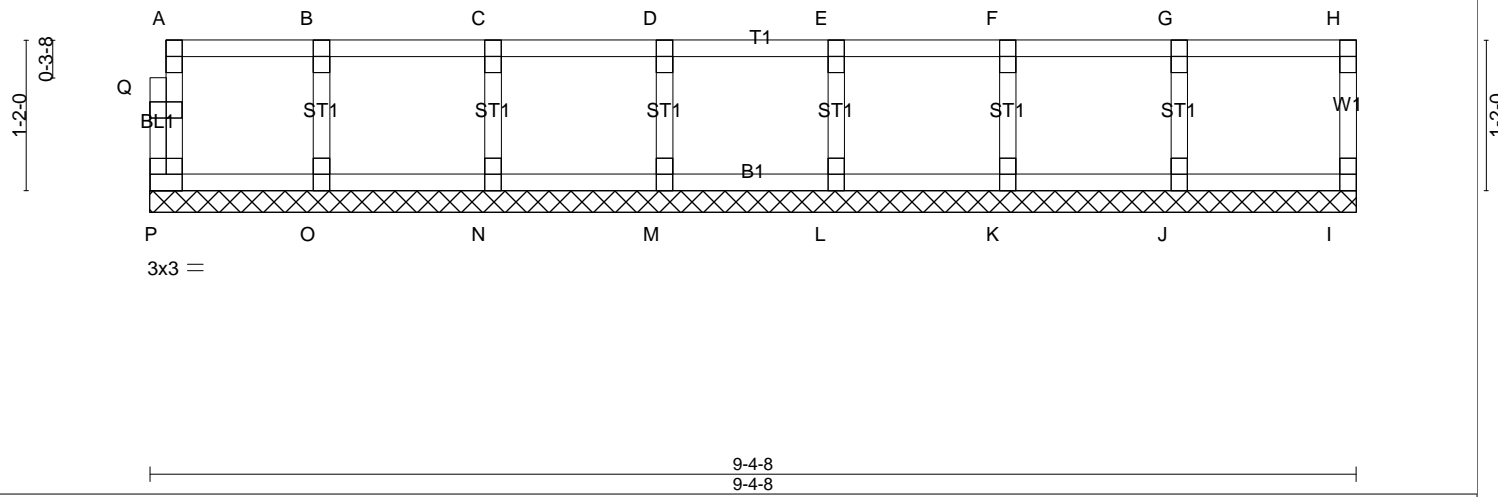

LOADING (psf)	SPACING- 2-0-0	CSI.	DEFL. in (loc) l/defl L/d	PLATES GRIP
TCLL 40.0	Plate Grip DOL 1.00	TC 0.10	Vert(LL) n/a - n/a 999	MT20 244/190
TCDL 20.0	Lumber DOL 1.00	BC 0.02	Vert(CT) n/a - n/a 999	
BCLL 0.0	Rep Stress Incr YES	WB 0.04	Horz(CT) 0.00 l n/a n/a	
BCDL 5.0	Code IRC2015/TPI2014	Matrix-R		Weight: 40 lb FT = 20%F, 12%E

LUMBER- TOP CHORD 2x4 SP No.2(flat) BOT CHORD 2x4 SP No.2(flat) WEBS 2x4 SP No.3(flat) OTHERS 2x4 SP No.3(flat)	BRACING- TOP CHORD Structural wood sheathing directly applied or 6-0-0 oc purlins, except end verticals. BOT CHORD Rigid ceiling directly applied or 10-0-0 oc bracing.
--	--

REACTIONS. (lb/size) P=67/9-4-8 (min. 0-1-8), I=79/9-4-8 (min. 0-1-8), O=169/9-4-8 (min. 0-1-8), N=175/9-4-8 (min. 0-1-8), M=173/9-4-8 (min. 0-1-8), L=174/9-4-8 (min. 0-1-8), K=172/9-4-8 (min. 0-1-8), J=179/9-4-8 (min. 0-1-8)

FORCES. (lb) - Maximum Compression/Maximum Tension
TOP CHORD P-Q=-61/0, A-Q=-61/0, H-I=-71/0, A-B=-12/0, B-C=-12/0, C-D=-12/0, D-E=-12/0, E-F=-12/0, F-G=-12/0, G-H=-12/0
BOT CHORD O-P=0/12, N-O=0/12, M-N=0/12, L-M=0/12, K-L=0/12, J-K=0/12, I-J=0/12
WEBS B-O=-156/0, C-N=-161/0, D-M=-160/0, E-L=-161/0, F-K=-158/0, G-J=-168/0

- NOTES-**
- 1) All plates are 1.5x3 MT20 unless otherwise indicated.
 - 2) Gable requires continuous bottom chord bearing.
 - 3) Truss to be fully sheathed from one face or securely braced against lateral movement (i.e. diagonal web).
 - 4) Gable studs spaced at 1-4-0 oc.
 - 5) This truss is designed in accordance with the 2015 International Residential Code sections R502.11.1 and R802.10.2 and referenced standard ANSI/TPI 1.
 - 6) Recommend 2x6 strongbacks, on edge, spaced at 10-0-0 oc and fastened to each truss with 3-10d (0.131" X 3") nails. Strongbacks to be attached to walls at their outer ends or restrained by other means.
 - 7) CAUTION, Do not erect truss backwards.

LOAD CASE(S) Standard