

Design Passed

Member Report

Label: M1-2 | Design Tag: i3418
2 piece(s) of 1 3/4" x 16" 2.0E Microllam® LVL
Member Type: Beam | Level: Attic

Product is Sufficient for Application and Loads Described

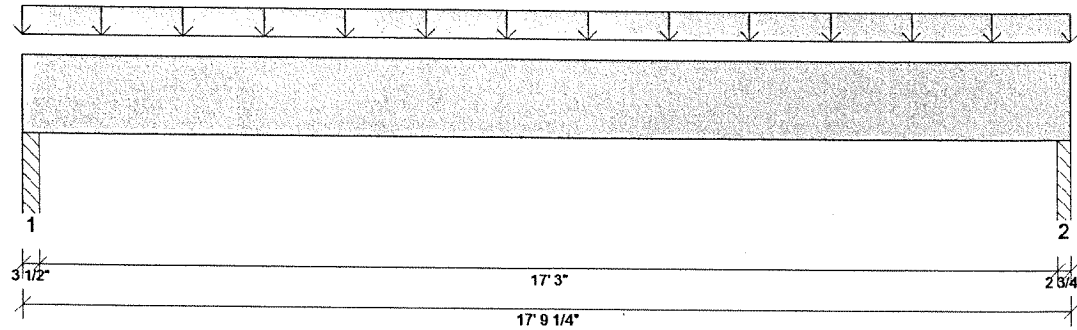

Building Code: IBC 2012 Design Methodology: ASD Member Cut Length: 17' 9 1/4" Member Drawing Not to Scale

Design Results:	Design @ Location	Allowed	Result	LDF	Load Combination - (Load Group)
Critical Reaction	2624 lb @ 17' 8"	7219 lb (2.75")	Passed - 36%	-	1.0 D + 1.0 S - (0)
Shear	2161 lb @ 1' 7 1/2"	12236 lb	Passed - 18%	1.15	1.0 D + 1.0 S - (0)
Moment	11344 lb-ft @ 8' 11"	35781 lb-ft	Passed - 32%	1.15	1.0 D + 1.0 S - (0)
Live Load Deflection	0.15" @ 8' 11"	0.58" L/360	Passed - L/999	-	1.0 D + 1.0 S - (0)
Total Load Deflection	0.29" @ 8' 11"	0.88" L/240	Passed - L/737	-	1.0 D + 1.0 S - (0)

Design Notes:

- * Top Edge Bracing (Lu): Top compression edge must be braced at 17-01-00 o/c based on loads applied, unless detailed otherwise.
- * Bottom Edge Bracing (Lu): Bottom compression edge must be braced at 17-09-00 o/c based on loads applied, unless detailed otherwise.

Supports:

Support	Start : End	Req'd Br'g	Source	Maximum Loads to Supports			
				Dead	Floor Live	Roof Live	Snow
1	0" : 3 1/2"	1.5"	PBO42(i1779)	1208 lb	-	-	1427 lb
2	17' 6 1/2" : 17' 9 1/4"	1.5"	PBO43(i1780)	1199 lb	-	-	1417 lb

Loads:

Type	Start : End	Combine	Source	Maximum Loads on Member			
				Dead	Floor Live	Roof Live	Snow
Self Weight	0" : 17' 9 1/4"	-	Self Weight	15 lb/ft	-	-	-
Uniform	0" : 17' 9 1/4"	-	User Load	120 lb/ft	-	-	160 lb/ft

Errors, Warnings, & Notes:

- * If sloping roof loads are applied to this member, the roof dead load has been adjusted for slope.
- * The member graphic, dimensions, and locations shown on this report are based on the centerline of the member.
- * Analysis and Design has been performed using precision loading from actual modeled conditions. Some loads may have been modified to simplify reporting.
- * Load Duration Factors: Dead - 0.90, Floor Live - 1.00, Roof Live - 1.25, Snow - 1.15



Member Report

Label: M1-2 | Design Tag: i3418

Design Passed

2 piece(s) of 1 3/4" x 16" 2.0E Microllam® LVL

Member Type: Beam | Level: Attic

Product is Sufficient for Application and Loads Described

Weyerhaeuser warrants that the sizing of its products will be in accordance with Weyerhaeuser product design criteria and published design values. Weyerhaeuser expressly disclaims any other warranties related to the software. Refer to current literature for installation details and trademark information available at wy.com/woodproducts. Use of this software is not intended to circumvent the need for a design professional as determined by the authority having jurisdiction. The designer of record, builder or framer is responsible to assure that this calculation is compatible with the overall project. The product application, input design loads, dimensions and support information have been provided by _____ of _____.

Copyright Weyerhaeuser NR Company. All rights reserved.

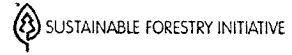

Design Passed

Member Report

Label: M2-2 | Design Tag: i3390
2 piece(s) of 1 3/4" x 16" 2.0E Microllam® LVL
Member Type: Beam | Level: Attic

Product is Sufficient for Application and Loads Described

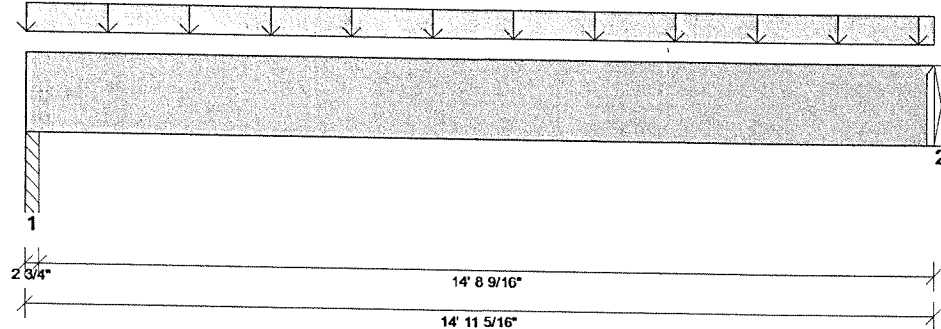

Building Code: IBC 2012 Design Methodology: ASD Member Cut Length: 14' 11 5/16" Member Drawing Not to Scale

Design Results:	Design @ Location	Allowed	Result	LDf	Load Combination - (Load Group)
Critical Reaction	2199 lb @ 14' 11 5/16"	3938 lb (1.5")	Passed - 56%	-	1.0 D + 1.0 S - (0)
Shear	1804 lb @ 13' 7 5/16"	12236 lb	Passed - 15%	1.15	1.0 D + 1.0 S - (0)
Moment	8157 lb-ft @ 7' 6 5/16"	35781 lb-ft	Passed - 23%	1.15	1.0 D + 1.0 S - (0)
Live Load Deflection	0.08" @ 7' 6 5/16"	0.49" L/360	Passed - L/999	-	1.0 D + 1.0 S - (0)
Total Load Deflection	0.15" @ 7' 6 5/16"	0.74" L/240	Passed - L/999	-	1.0 D + 1.0 S - (0)

Design Notes:

- * Top Edge Bracing (Lu): Top compression edge must be braced at 14-11-00 o/c based on loads applied, unless detailed otherwise.
- * Bottom Edge Bracing (Lu): Bottom compression edge must be braced at 14-11-00 o/c based on loads applied, unless detailed otherwise.

Supports:

Support	Start : End	Req'd Br'g	Source	Maximum Loads to Supports			
				Dead	Floor Live	Roof Live	Snow
1	0" : 2 3/4"	1.5"	PBO43(i1780)	1019 lb	-	-	1203 lb
2	14' 11 5/16" : -	1.5"	TRUSS BY	1005 lb	-	-	1186 lb

Loads:

Type	Start : End	Combine	Source	Maximum Loads on Member			
				Dead	Floor Live	Roof Live	Snow
Self Weight	0" : 14' 11 5/16"	-	Self Weight	15 lb/ft	-	-	-
Uniform	0" : 14' 11 1/4"	-	User Load	120 lb/ft	-	-	160 lb/ft

Connector Information:

Support	Manufacturer	Model	Nailing Requirements				Other Information
			Top	Face	Member	Min. Seat Length	
2	SST	HGU3.63/11-SDS	Not Applicable	36- SDS25212	24- SDS25212	1.5"	Minimum seat length reported is based on the design load

Errors, Warnings, & Notes:

- * If sloping roof loads are applied to this member, the roof dead load has been adjusted for slope.
- * The member graphic, dimensions, and locations shown on this report are based on the centerline of the member.
- * Analysis and Design has been performed using precision loading from actual modeled conditions. Some loads may have been modified to simplify reporting.
- * Load Duration Factors: Dead - 0.90, Floor Live - 1.00, Roof Live - 1.25, Snow - 1.15



Design Passed

Member Report

Label: M2-2 | Design Tag: i3390

2 piece(s) of 1 3/4" x 16" 2.0E Microllam® LVL

Member Type: Beam | Level: Attic

Product is Sufficient for Application and Loads Described

Weyerhaeuser warrants that the sizing of its products will be in accordance with Weyerhaeuser product design criteria and published design values. Weyerhaeuser expressly disclaims any other warranties related to the software. Refer to current literature for installation details and trademark information available at wy.com/woodproducts. Use of this software is not intended to circumvent the need for a design professional as determined by the authority having jurisdiction. The designer of record, builder or framer is responsible to assure that this calculation is compatible with the overall project. The product application, input design loads, dimensions and support information have been provided by _____ of _____.

Copyright Weyerhaeuser NR Company. All rights reserved.

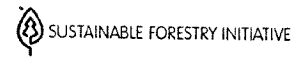

Member Report

Label: M1-2 | Design Tag: i3416

2 piece(s) of 1 3/4" x 11 7/8" 2.0E Microllam® LVL

Member Type: Beam | Level: 1st Floor

Design Passed

Product is Sufficient for Application and Loads Described

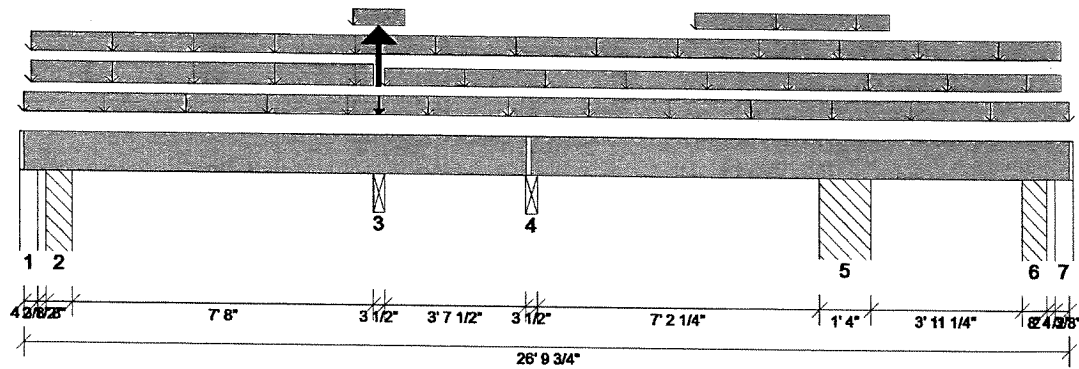

Building Code: IBC 2012 Design Methodology: ASD Member Cut Length: 26' 9 3/4" Member Drawing Not to Scale

Design Results:	Design @ Location	Allowed	Result	LDF	Load Combination - (Load Group)
Critical Reaction	1287 lb @ 9' 0 5/8"	9161 lb (3.49")	Passed - 14%	-	1.0 D + 0.75 L + 0.75 S - (0)
Shear	868 lb @ 7' 11"	9081 lb	Passed - 10%	1.15	1.0 D + 0.75 L + 0.75 S - (0)
Moment	-1368 lb-ft @ 9' 0 5/8"	20525 lb-ft	Passed - 7%	1.15	1.0 D + 0.75 L + 0.75 S - (0)
Live Load Deflection	0.01" @ 4' 9 9/16"	0.26" L/360	Passed - L/999	-	1.0 D + 0.75 L + 0.75 S - (0)
Total Load Deflection	0.02" @ 4' 9 1/2"	0.40" L/240	Passed - L/999	-	1.0 D + 0.75 L + 0.75 S - (0)

Vertical Load Capacity Check Passed

Design Notes:

* Top Edge Bracing (Lu): Top compression edge must be braced at 26-10-00 o/c based on loads applied, unless detailed otherwise.

* Bottom Edge Bracing (Lu): Bottom compression edge must be braced at 26-10-00 o/c based on loads applied, unless detailed otherwise.

Supports:

Support	Start : End	Req'd Br'g	Source	Maximum Loads to Supports			
				Dead	Floor Live	Roof Live	Snow
1	0" : 4 3/8"	-	F1(i1603)	-1190 lb	86 / -611 lb	-	-700 lb
2	6 7/8" : 1' 2 7/8"	1.5"	PBO34(i1636)	1903 lb	915 / -32 lb	-	1090 lb
3	8' 10 7/8" : 9' 2 3/8"	1.5"	M7-2(i3411)	601 lb	347 / -77 lb	-	260 / -54 lb
4	12' 9 7/8" : 13' 1 3/8"	1.5"	M4-2(i3400)	573 lb	591 lb	-	-102 lb
5	20' 3 5/8" : 21' 7 5/8"	-	PBO32(i1634)	1009 / -153 lb	1244 / -510 lb	-	38 / -28 lb
==>	20' 5 1/8" : -	1.5"	PBO32(i1634)	1009 lb	875 / -80 lb	-	38 lb
==>	21' 6 1/8" : -	1.5"	PBO32(i1634)	-153 lb	369 / -430 lb	-	-28 lb
6	25' 6 7/8" : 26' 2 7/8"	1.5"	PBO36(i1638)	616 lb	481 lb	-	3 lb
7	26' 5 3/8" : 26' 9 3/4"	-	F15(i1607)	-253 lb	58 / -239 lb	-	-2 lb

Loads:

Type	Start : End	Combine	Source	Maximum Loads on Member			
				Dead	Floor Live	Roof Live	Snow
Self Weight	0" : 26' 9 3/4"	-	Self Weight	11 lb/ft	-	-	-
Uniform	0" : 26' 9 3/4"	-	FC1 Floor Decking	16 lb/ft	64 lb/ft	-	-
Uniform	2 3/8" : 26' 7 3/8"	-	B1(i1552)	73 lb/ft	-	-	-
Uniform	2 3/8" : 8' 10 7/8"	-	B1(i1552)	40 lb/ft	-	-	80 lb/ft
Uniform	8' 4 5/8" : 9' 8 5/8"	-	B1(i1552)	-	20 lb/ft	-	-
Uniform	9' 2 3/8" : 26' 7 3/8"	-	B1(i1552)	13 lb/ft	26 lb/ft	-	-
Uniform	17' 1 5/8" : 22' 1 5/8"	-	FC1 Floor Decking	13 lb/ft	-	-	-
Point	9' 0 5/8" : -	-	NB10(i1775)	50 lb	-	-	-
Point	9' 0 5/8" : -	-	B1(i1552)	-246 lb	-175 lb	-	-245 lb



Member Report

Label: M1-2 | Design Tag: i3416

2 piece(s) of 1 3/4" x 11 7/8" 2.0E Microllam® LVL

Member Type: Beam | Level: 1st Floor

Product is Sufficient for Application and Loads Described

Design Passed

Errors, Warnings, & Notes:

- * CAUTION: The maximum net analysis reaction exceeds the user-defined maximum uplift value at one or more supports.
- * If sloping roof loads are applied to this member, the roof dead load has been adjusted for slope.
- * The member graphic, dimensions, and locations shown on this report are based on the centerline of the member.
- * Analysis and Design has been performed using precision loading from actual modeled conditions. Some loads may have been modified to simplify reporting.
- * Load Duration Factors: Dead - 0.90, Floor Live - 1.00, Roof Live - 1.25, Snow - 1.15

Weyerhaeuser warrants that the sizing of its products will be in accordance with Weyerhaeuser product design criteria and published design values. Weyerhaeuser expressly disclaims any other warranties related to the software. Refer to current literature for installation details and trademark information available at wy.com/woodproducts. Use of this software is not intended to circumvent the need for a design professional as determined by the authority having jurisdiction. The designer of record, builder or framer is responsible to assure that this calculation is compatible with the overall project. The product application, input design loads, dimensions and support information have been provided by _____ of _____.

Copyright Weyerhaeuser NR Company. All rights reserved.



Member Report

Label: M7-2 | Design Tag: i3411

2 piece(s) of 1 3/4" x 9 1/4" 2.0E Microllam® LVL

Member Type: Beam | Level: 1st Floor

Design Passed

Product is Sufficient for Application and Loads Described

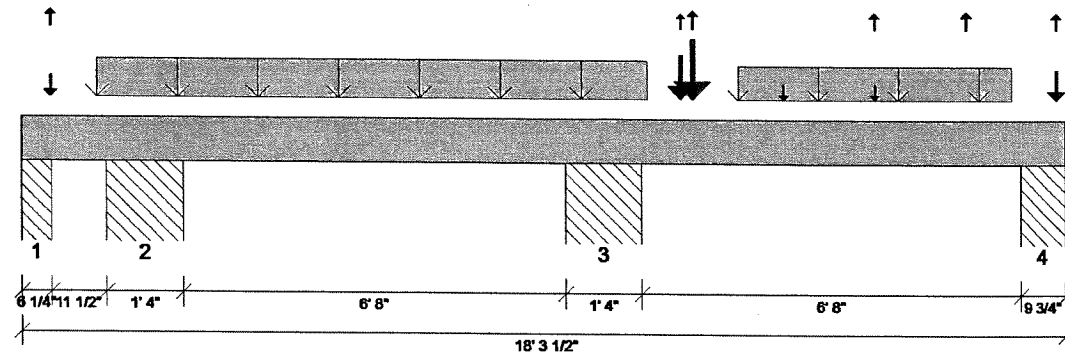

Building Code: IBC 2012 Design Methodology: ASD Member Cut Length: 18' 3 1/2" Member Drawing Not to Scale

Design Results:	Design @ Location	Allowed	Result	LDF	Load Combination -- (Load Group)
Critical Reaction	8738 lb @ 10' 8 1/4"	28219 lb (10.75")	Passed - 31%	-	1.0 D + 0.75 L + 0.75 S - (1)
Shear	7019 lb @ 11' 7"	7074 lb	Passed - 99%	1.15	1.0 D + 0.75 L + 0.75 S - (1)
Moment	-4382 lb-ft @ 10' 8 1/4"	11204 lb-ft	Passed - 39%	1.00	1.0 D + 1.0 L - (1)
Live Load Deflection	0.06" @ 14' 0 3/16"	0.23" L/360	Passed - L/999	-	1.0 D + 0.75 L + 0.75 S - (1)
Total Load Deflection	0.08" @ 13' 11"	0.35" L/240	Passed - L/977	-	1.0 D + 0.75 L + 0.75 S - (1)

Vertical Load Capacity Check Passed

Design Notes:

* Uplift constraint has been released at support location 4-12.

* Top Edge Bracing (Lu): Top compression edge must be braced at 18-04-00 o/c based on loads applied, unless detailed otherwise.

* Bottom Edge Bracing (Lu): Bottom compression edge must be braced at 18-04-00 o/c based on loads applied, unless detailed otherwise.

Supports:

Support	Start : End	Req'd Br'g	Source	Maximum Loads to Supports			
				Dead	Floor Live	Roof Live	Snow
1	0" : 6 1/4"	1.5"	PBO27(i1629)	217 lb	654 / -818 lb	-	-105 lb
2	1' 5 3/4" : 2' 9 3/4"	1.5"	PBO29(i1631)	-76 lb	3011 lb	-	-
==>	1' 7 1/4" : -	1.5"	PBO29(i1631)	-76 lb	577 lb	-	-
==>	2' 8 1/4" : -	1.5"	PBO29(i1631)	-	2434 lb	-	-
3	9' 5 3/4" : 10' 9 3/4"	1.5"	PBO31(i1633)	3721 lb	5602 / -154 lb	-	3062 lb
==>	9' 7 1/4" : -	1.5"	PBO31(i1633)	-	2496 lb	-	-
==>	10' 8 1/4" : -	3.33"	PBO31(i1633)	3721 lb	3106 / -154 lb	-	3062 lb
4	17' 5 3/4" : 18' 3 1/2"	1.5"	PBO24(i1626)	930 lb	1429 / -102 lb	-	625 lb

Loads:

Type	Start : End	Combine	Source	Maximum Loads on Member			
				Dead	Floor Live	Roof Live	Snow
Self Weight	0" : 18' 3 1/2"	-	Self Weight	9 lb/ft	-	-	-
Tapered	1' 3 13/16" : 10' 11"	-	Smoothed Load	47 To 47 lb/ft	410 To 409 lb/ft	-	-
Tapered	12' 6 3/16" : 17' 3"	-	Smoothed Load	-	364 To 369 lb/ft	-	-
Point	6 3/16" : -	-	B28'(i3322)	54 lb	466 / -159 lb	-	-
Point	11' 6 1/8" : -	-	BBk1(i3307)	1098 lb	270 / -1 lb	-	1019 lb
Point	11' 8 9/16" : -	-	B10'-2(i3300)	1623 lb	663 lb	-	1440 lb
Point	11' 8 9/16" : -	-	B18'(i3207)	847 lb	339 / -291 lb	-	826 lb
Point	13' 3 13/16" : -	-	B28'(i3158)	54 lb	-	-	-
Point	14' 11" : -	-	B28'(i3157)	32 lb	-159 lb	-	-
Point	16' 6 3/16" : -	-	B28'(i3156)	-130 lb	-123 lb	-	-
Point	18' 1 3/4" : -	-	M1-2(i3416)	601 lb	347 / -77 lb	-	260 / -54 lb

File Name: SR-285597

DAY/ MURRAY PLAN

REVISION DATE

REVISION COMMENTS

Javelin® Software 6.4.1.3

Design Engine: V8.0.0.21

Data: V7.3.2.0

8/25/2020 9:38:48 AM

Page 1 of 2



Member Report

Label: M7-2 | Design Tag: i3411

Design Passed

2 piece(s) of 1 3/4" x 9 1/4" 2.0E Microllam® LVL

Member Type: Beam | Level: 1st Floor

Product is Sufficient for Application and Loads Described

Errors, Warnings, & Notes:

- * If sloping roof loads are applied to this member, the roof dead load has been adjusted for slope.
- * The member graphic, dimensions, and locations shown on this report are based on the centerline of the member.
- * Analysis and Design has been performed using precision loading from actual modeled conditions. Some loads may have been modified to simplify reporting.
- * Load Duration Factors: Dead - 0.90, Floor Live - 1.00, Roof Live - 1.25, Snow - 1.15

Weyerhaeuser warrants that the sizing of its products will be in accordance with Weyerhaeuser product design criteria and published design values. Weyerhaeuser expressly disclaims any other warranties related to the software. Refer to current literature for installation details and trademark information available at wy.com/woodproducts. Use of this software is not intended to circumvent the need for a design professional as determined by the authority having jurisdiction. The designer of record, builder or framer is responsible to assure that this calculation is compatible with the overall project. The product application, input design loads, dimensions and support information have been provided by _____ of _____.

Copyright Weyerhaeuser NR Company. All rights reserved.



Member Report

Design Passed

Label: M2-3 | Design Tag: i3405
3 piece(s) of 1 3/4" x 11 7/8" 2.0E Microllam® LVL
Member Type: Beam | Level: 1st Floor

Product is Sufficient for Application and Loads Described

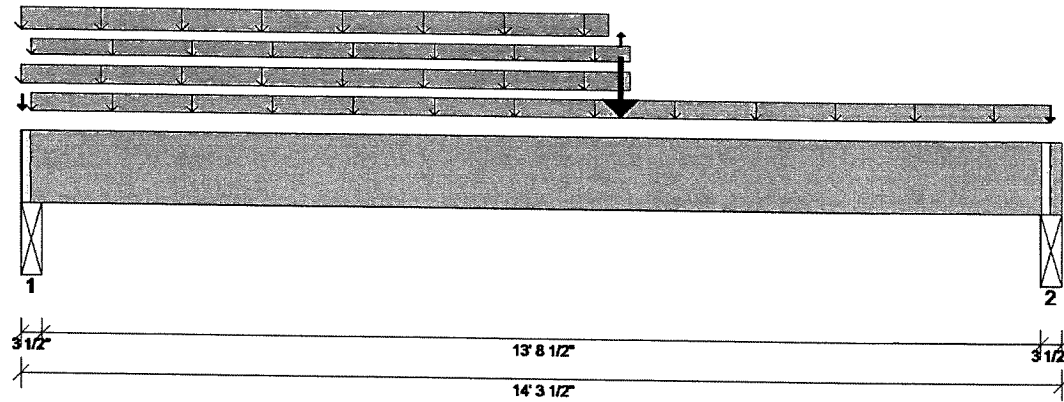

Building Code: IBC 2012 Design Methodology: ASD Member Cut Length: 14' 3 1/2" Member Drawing Not to Scale

Design Results:	Design @ Location	Allowed	Result	LDF	Load Combination - (Load Group)
Critical Reaction	4599 lb @ 14' 1 1/2"	13781 lb (3.5")	Passed - 33%	-	1.0 D + 0.75 L + 0.75 S - (0)
Shear	4408 lb @ 13' 0 1/8"	13622 lb	Passed - 32%	1.15	1.0 D + 0.75 L + 0.75 S - (0)
Moment	25659 lb-ft @ 8' 2 1/8"	30788 lb-ft	Passed - 83%	1.15	1.0 D + 0.75 L + 0.75 S - (0)
Live Load Deflection	0.27" @ 7' 4 7/16"	0.47" L/360	Passed - L/631	-	1.0 D + 0.75 L + 0.75 S - (0)
Total Load Deflection	0.56" @ 7' 3 3/4"	0.70" L/240	Passed - L/300	-	1.0 D + 0.75 L + 0.75 S - (0)

Design Notes:

- * Top Edge Bracing (Lu): Top compression edge must be braced at 8-11-00 o/c based on loads applied, unless detailed otherwise.
- * Bottom Edge Bracing (Lu): Bottom compression edge must be braced at 14-04-00 o/c based on loads applied, unless detailed otherwise.

Supports:

Support	Start : End	Req'd Br'g	Source	Maximum Loads to Supports			
				Dead	Floor Live	Roof Live	Snow
1	0" : 3 1/2"	1.5"	M8-2(i3113)	2585 lb	1203 lb	-	1235 lb
2	14' 0" : 14' 3 1/2"	1.5"	M6-2(i3398)	2369 lb	1295 lb	-	1685 lb

Loads:

Type	Start : End	Combine	Source	Maximum Loads on Member			
				Dead	Floor Live	Roof Live	Snow
Self Weight	0" : 14' 3 1/2"	-	Self Weight	17 lb/ft	-	-	-
Uniform	0" : 8' 3 7/8"	-	B21(i1559)	73 lb/ft	-	-	-
Uniform	0" : 8' 0 3/8"	-	B21(i1559)	98 lb/ft	45 lb/ft	-	-
Uniform	1 3/4" : 14' 1 3/4"	-	FC1 Floor Decking	8 lb/ft	32 lb/ft	-	-
Uniform	1 3/4" : 8' 3 7/8"	-	FC1 Floor Decking	4 lb/ft	-	-	-
Point	1/4" : -	-	B21(i1559)	116 lb	25 lb	-	24 lb
Point	8' 2 3/8" : -	-	B21(i1559)	2971 lb	1637 lb	-	2856 / -4 lb
Point	14' 1 5/8" : -	-	B14(i1568)	78 lb	27 lb	-	44 lb

Errors, Warnings, & Notes:

- * If sloping roof loads are applied to this member, the roof dead load has been adjusted for slope.
- * The member graphic, dimensions, and locations shown on this report are based on the centerline of the member.
- * Analysis and Design has been performed using precision loading from actual modeled conditions. Some loads may have been modified to simplify reporting.

File Name: SR-285597
DAY/MURRAY PLAN
REVISION DATE
REVISION COMMENTS

Javelin® Software 6.4.1.3 Design Engine: V8.0.0.21
Data: V7.3.2.0
8/25/2020 9:38:48 AM
Page 1 of 2



Member Report

Label: M2-3 | Design Tag: i3405

Design Passed

3 piece(s) of 1 3/4" x 11 7/8" 2.0E Microllam® LVL

Member Type: Beam | Level: 1st Floor

Product is Sufficient for Application and Loads Described

* Load Duration Factors: Dead - 0.90, Floor Live - 1.00, Roof Live - 1.25, Snow - 1.15

Weyerhaeuser warrants that the sizing of its products will be in accordance with Weyerhaeuser product design criteria and published design values. Weyerhaeuser expressly disclaims any other warranties related to the software. Refer to current literature for installation details and trademark information available at wy.com/woodproducts. Use of this software is not intended to circumvent the need for a design professional as determined by the authority having jurisdiction. The designer of record, builder or framer is responsible to assure that this calculation is compatible with the overall project. The product application, input design loads, dimensions and support information have been provided by _____ of _____.

Copyright Weyerhaeuser NR Company. All rights reserved.



Member Report

Label: M4-2 | Design Tag: i3400

2 piece(s) of 1 3/4" x 9 1/4" 2.0E Microllam® LVL

Member Type: Beam | Level: 1st Floor

Design Passed

Product is Sufficient for Application and Loads Described

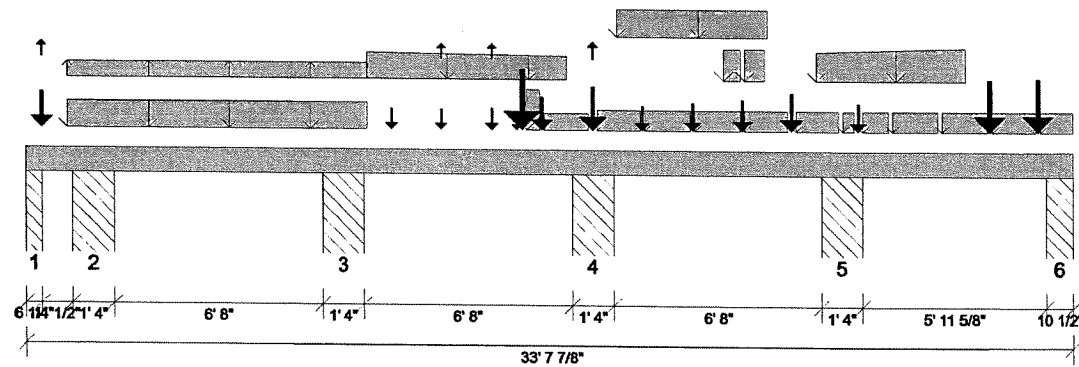

Building Code: IBC 2012 Design Methodology: ASD Member Cut Length: 33' 7 7/8" Member Drawing Not to Scale

Design Results:	Design @ Location	Allowed	Result	LDF	Load Combination - (Load Group)
Critical Reaction	6979 lb @ 26' 8 1/4"	28219 lb (10.75")	Passed - 25%	-	1.0 D + 1.0 L - (1)
Shear	4176 lb @ 24' 8 1/2"	6151 lb	Passed - 68%	1.00	1.0 D + 1.0 L - (1)
Moment	-4991 lb-ft @ 18' 8 1/4"	11204 lb-ft	Passed - 45%	1.00	1.0 D + 1.0 L - (8)
Live Load Deflection	0.05" @ 29' 11 5/8"	0.21" L/360	Passed - L/999	-	1.0 D + 1.0 L - (1)
Total Load Deflection	0.08" @ 22' 3 5/8"	0.35" L/240	Passed - L/999	-	1.0 D + 1.0 L - (1)

Vertical Load Capacity Check Passed

Design Notes:

* Uplift constraint has been released at support location 4-12.

* Top Edge Bracing (Lu): Top compression edge must be braced at 32-02-00 o/c based on loads applied, unless detailed otherwise.

* Bottom Edge Bracing (Lu): Bottom compression edge must be braced at 23-03-00 o/c based on loads applied, unless detailed otherwise.

Supports:

Support	Start : End	Req'd Br'g	Source	Maximum Loads to Supports			
				Dead	Floor Live	Roof Live	Snow
1	0" : 6 1/4"	1.5"	PBO26(i1628)	1 lb	773 / -564 lb	-	1 / -20 lb
2	1' 5 3/4" : 2' 9 3/4"	1.5"	PBO28(i1630)	823 lb	3622 / -39 lb	-	145 / -164 lb
==>	1' 7 1/4" : -	1.5"	PBO28(i1630)	-	578 / -24 lb	-	135 / -8 lb
==>	2' 8 1/4" : -	1.5"	PBO28(i1630)	823 lb	3044 / -15 lb	-	10 / -156 lb
3	9' 5 3/4" : 10' 9 3/4"	1.5"	PBO30(i1632)	1473 / -49 lb	5224 / -40 lb	-	243 / -163 lb
==>	9' 7 1/4" : -	1.5"	PBO30(i1632)	-49 lb	2216 / -9 lb	-	-163 lb
==>	10' 8 1/4" : -	1.5"	PBO30(i1632)	1473 lb	3008 / -31 lb	-	243 lb
4	17' 5 3/4" : 18' 9 3/4"	1.5"	PBO23(i1625)	4090 lb	6522 lb	-	1408 / -138 lb
==>	17' 7 1/4" : -	2.24"	PBO23(i1625)	2261 lb	2246 lb	-	1109 lb
==>	18' 8 1/4" : -	2.47"	PBO23(i1625)	1829 lb	4276 lb	-	299 / -138 lb
5	25' 5 3/4" : 26' 9 3/4"	1.5"	PBO25(i1627)	4127 lb	7465 lb	-	397 / -127 lb
==>	25' 7 1/4" : -	2.5"	PBO25(i1627)	2828 lb	3665 lb	-	397 lb
==>	26' 8 1/4" : -	2.66"	PBO25(i1627)	1299 lb	3800 lb	-	-127 lb
6	32' 9 3/8" : 33' 7 7/8"	1.5"	-	1343 lb	2495 / -50 lb	-	1 / -38 lb
++>	33' 1 3/8" : -	1.5"	PBO33(i1635)	1023 lb	1901 / -38 lb	-	1 / -29 lb
++>	33' 6 5/8" : -	-	F16(i1606)	320 lb	594 / -12 lb	-	-9 lb

Loads:

Type	Start : End	Combine	Source	Maximum Loads on Member			
				Dead	Floor Live	Roof Live	Snow
Self Weight	0" : 33' 7 7/8"	-	Self Weight	9 lb/ft	-	-	-
Uniform	16' 0 3/8" : 16' 5"	-	BBk1(i3385)	642 lb/ft	156 lb/ft	-	598 lb/ft
Uniform	16' 7 1/16" : 17' 11"	-	BBk1(i3385)	73 lb/ft	-	-	-

File Name: SR-285597

DAY/ MURRAY PLAN

REVISION DATE

REVISION COMMENTS

Javelin® Software 6.4.1.3

Design Engine: V8.0.0.21

Data: V7.3.2.0

8/25/2020 9:38:48 AM

Page 1 of 2

Member Report

Label: M4-2 | Design Tag: i3400

2 piece(s) of 1 3/4" x 9 1/4" 2.0E Microllam® LVL

Member Type: Beam | Level: 1st Floor

Design Passed

Product is Sufficient for Application and Loads Described

Uniform	18' 3 1/2" : 19' 7"	-	BBk1(i3385)	139 lb/ft	132 lb/ft	-	-
Uniform	19' 9 7/16" : 21' 2"	-	BBk1(i3385)	139 lb/ft	132 lb/ft	-	-
Uniform	21' 4 11/16" : 22' 10"	-	BBk1(i3385)	139 lb/ft	132 lb/ft	-	-
Uniform	22' 3 5/8" : 22' 10"	-	BBk1(i3385)	422 lb/ft	-	-	449 lb/ft
Uniform	22' 11 7/8" : 24' 4"	-	BBk1(i3385)	139 lb/ft	132 lb/ft	-	-
Uniform	22' 11 7/8" : 23' 7"	-	BBk1(i3385)	422 lb/ft	-	-	449 lb/ft
Uniform	24' 7 15/16" : 26' 0"	-	BBk1(i3385)	139 lb/ft	132 lb/ft	-	-
Uniform	26' 2 1/4" : 26' 6 3/8"	-	BBk1(i3385)	139 lb/ft	132 lb/ft	-	-
Uniform	26' 9 7/8" : 27' 7"	-	BBk1(i3385)	139 lb/ft	132 lb/ft	-	-
Uniform	27' 9 7/16" : 29' 2"	-	BBk1(i3385)	139 lb/ft	132 lb/ft	-	-
Uniform	29' 4 11/16" : 30' 10"	-	BBk1(i3385)	139 lb/ft	132 lb/ft	-	-
Uniform	30' 11 7/8" : 32' 5"	-	BBk1(i3385)	139 lb/ft	132 lb/ft	-	-
Uniform	32' 7 1/16" : 33' 7"	-	BBk1(i3385)	139 lb/ft	132 lb/ft	-	-
Tapered	1' 3 13/16" : 10' 11"	-	Smoothed Load	129 To 129 lb/ft	512 To 513 / -22 To -22 lb/ft	-	-
Tapered	10' 11" : 17' 3 13/16"	-	Smoothed Load	-	608 To 447 lb/ft	-	-
Tapered	18' 11" : 23' 8 9/16"	-	Smoothed Load	-	661 To 669 lb/ft	-	-
Tapered	25' 3 13/16" : 30' 1"	-	Smoothed Load	205 To 295 lb/ft	541 To 693 lb/ft	-	-
Point	6 3/16" :-	-	B28'(i3322)	145 lb	695 / -27 lb	-	-
Point	11' 8 9/16" :-	-	B18'(i3207)	235 lb	-	-	-
Point	13' 3 13/16" :-	-	B28'(i3158)	217 lb	-2 lb	-	-
Point	14' 11" :-	-	B28'(i3157)	256 lb	-2 lb	-	-
Point	15' 8 5/8" :-	-	BBk1(i3385)	27 lb	7 lb	-	25 lb
Point	15' 10 5/8" :-	-	B14'-2(i3210)	875 lb	376 lb	-	603 lb
Point	16' 6 3/16" :-	-	B28'(i3156)	660 lb	-	-	54 lb
Point	18' 1 3/4" :-	-	M1'-2(i3416)	573 lb	591 lb	-	-102 lb
Point	19' 8 9/16" :-	-	B28'(i3155)	377 lb	-	-	-
Point	21' 3 13/16" :-	-	B28'(i3154)	506 lb	-	-	-
Point	22' 11" :-	-	B28'(i3153)	572 lb	-	-	66 lb
Point	24' 6 3/16" :-	-	B14'-2(i3152)	523 lb	409 lb	-	-
Point	24' 6 3/16" :-	-	B14'(i3208)	129 lb	455 lb	-	-
Point	26' 8 1/8" :-	-	B14'-2(i3209)	277 lb	243 lb	-	-
Point	30' 11" :-	-	B28'(i3331)	447 lb	1069 lb	-	-
Point	32' 6 3/16" :-	-	B28'(i3147)	498 lb	1069 lb	-	-

Errors, Warnings, & Notes:

- * If sloping roof loads are applied to this member, the roof dead load has been adjusted for slope.
- * The member graphic, dimensions, and locations shown on this report are based on the centerline of the member.
- * Analysis and Design has been performed using precision loading from actual modeled conditions. Some loads may have been modified to simplify reporting.
- * Load Duration Factors: Dead - 0.90, Floor Live - 1.00, Roof Live - 1.25, Snow - 1.15

Weyerhaeuser warrants that the sizing of its products will be in accordance with Weyerhaeuser product design criteria and published design values. Weyerhaeuser expressly disclaims any other warranties related to the software. Refer to current literature for installation details and trademark information available at wy.com/woodproducts. Use of this software is not intended to circumvent the need for a design professional as determined by the authority having jurisdiction. The designer of record, builder or framer is responsible to assure that this calculation is compatible with the overall project. The product application, input design loads, dimensions and support information have been provided by _____ of _____.

Copyright Weyerhaeuser NR Company. All rights reserved.



Member Report

Label: M6-2 | Design Tag: i3398

2 piece(s) of 1 3/4" x 9 1/4" 2.0E Microllam® LVL

Member Type: Beam | Level: 1st Floor

Design Passed

Product is Sufficient for Application and Loads Described

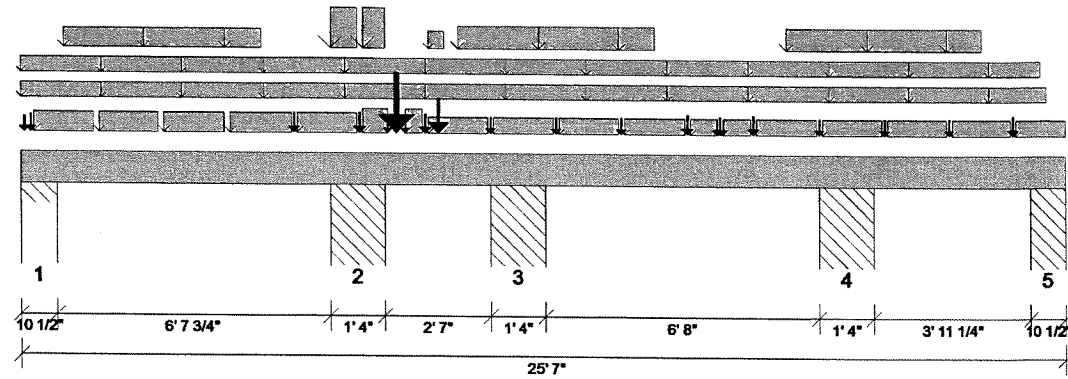

Building Code: IBC 2012 Design Methodology: ASD Member Cut Length: 25' 7" Member Drawing Not to Scale

Design Results:	Design @ Location	Allowed	Result	LDF	Load Combination - (Load Group)
Critical Reaction	7291 lb @ 8' 8 3/4"	28219 lb (10.75")	Passed - 26%	-	1.0 D + 0.75 L + 0.75 S - (0)
Shear	2618 lb @ 9' 7 1/2"	7074 lb	Passed - 37%	1.15	1.0 D + 0.75 L + 0.75 S - (0)
Moment	-1910 lb-ft @ 7' 7 3/4"	11204 lb-ft	Passed - 17%	1.00	1.0 D + 1.0 L - (0)
Live Load Deflection	0.02" @ 16' 2"	0.23" L/360	Passed - L/999	-	1.0 D + 1.0 L - (0)
Total Load Deflection	0.01" @ 10' 2"	0.14" L/240	Passed - L/999	-	1.0 D + 0.75 L + 0.75 S - (0)

Vertical Load Capacity Check Passed

Design Notes:

* Top Edge Bracing (Lu): Top compression edge must be braced at 25-07-00 o/c based on loads applied, unless detailed otherwise.

* Bottom Edge Bracing (Lu): Bottom compression edge must be braced at 25-07-00 o/c based on loads applied, unless detailed otherwise.

* -210 lb uplift at support located at 12-07-12. Strapping or other restraint may be required.

Supports:

Support	Start : End	Req'd Br'g	Source	Maximum Loads to Supports			
				Dead	Floor Live	Roof Live	Snow
1	0" : 10 1/2"	-	-	518 lb	705 lb	-	3 / -28 lb
++>	1 1/4" : -	1.5"	F5(i1602)	123 lb	168 lb	-	1 / -7 lb
++>	6 1/2" : -	-	PBO35(i1637)	395 lb	537 lb	-	2 / -21 lb
2	7' 6 1/4" : 8' 10 1/4"	-	PBO27(i1629)	4428 lb	4602 lb	-	2376 / -199 lb
==>	7' 7 3/4" : -	1.5"	PBO27(i1629)	908 lb	1954 lb	-	-199 lb
==>	8' 8 3/4" : -	2.78"	PBO27(i1629)	3520 lb	2648 lb	-	2376 lb
3	11' 5 1/4" : 12' 9 1/4"	-	PBO26(i1628)	1263 lb	2985 / -124 lb	-	601 / -160 lb
==>	11' 6 3/4" : -	1.5"	PBO26(i1628)	854 lb	806 / -124 lb	-	601 lb
==>	12' 7 3/4" : -	1.5"	PBO26(i1628)	409 lb	2179 lb	-	-160 lb
4	19' 5 1/4" : 20' 9 1/4"	-	PBO38(i1640)	828 / -101 lb	2832 lb	-	98 / -127 lb
==>	19' 6 3/4" : -	1.5"	PBO38(i1640)	828 lb	2049 lb	-	9 / -121 lb
==>	20' 7 3/4" : -	1.5"	PBO38(i1640)	-101 lb	783 lb	-	89 / -6 lb
5	24' 8 1/2" : 25' 7"	-	-	173 lb	612 / -106 lb	-	-2 lb
++>	25' 0 1/2" : -	1.5"	PBO37(i1639)	132 lb	466 / -81 lb	-	-2 lb
++>	25' 5 3/4" : -	-	F15(i1607)	41 lb	146 / -25 lb	-	-

Loads:

Type	Start : End	Combine	Source	Maximum Loads on Member			
				Dead	Floor Live	Roof Live	Snow
Self Weight	0" : 25' 7"	-	Self Weight	9 lb/ft	-	-	-
Uniform	0" : 25' 1 3/8"	-	Smoothed Load	-	1 lb/ft	-	-
Uniform	0" : 24' 11 5/8"	-	Smoothed Load	-	1 lb/ft	-	-
Uniform	3 3/4" : 1' 9 1/4"	-	BBk1(i3377)	107 lb/ft	76 lb/ft	-	-

File Name: SR-285597

DAY/MURRAY PLAN

REVISION DATE

REVISION COMMENTS

Javelin® Software 6.4.1.3

Design Engine: V8.0.0.21

Data: V7.3.2.0

8/25/2020 9:38:48 AM

Page 1 of 3

Member Report

Label: M6-2 | Design Tag: i3398

Design Passed

2 piece(s) of 1 3/4" x 9 1/4" 2.0E Microllam® LVL

Member Type: Beam | Level: 1st Floor

Product is Sufficient for Application and Loads Described

Uniform	1' 0 1/2" : 5' 10 1/8"	-	Smoothed Load	38 lb/ft	120 lb/ft	-	-
Uniform	1' 11" : 3' 4 7/16"	-	BBk1(i3377)	107 lb/ft	76 lb/ft	-	-
Uniform	3' 6 3/16" : 4' 11 5/8"	-	BBk1(i3377)	107 lb/ft	76 lb/ft	-	-
Uniform	5' 1 3/8" : 6' 6 13/16"	-	BBk1(i3377)	107 lb/ft	75 lb/ft	-	-
Uniform	6' 8 9/16" : 8' 2"	-	BBk1(i3377)	107 lb/ft	76 lb/ft	-	-
Uniform	7' 6 1/4" : 8' 2"	-	BBk1(i3377)	426 lb/ft	374 lb/ft	-	223 lb/ft
Uniform	8' 3 3/4" : 8' 11 1/8"	-	BBk1(i3377)	182 lb/ft	76 lb/ft	-	100 lb/ft
Uniform	8' 3 3/4" : 8' 10 1/4"	-	BBk1(i3377)	426 lb/ft	374 lb/ft	-	223 lb/ft
Uniform	9' 4 3/8" : 9' 9 1/4"	-	BBk1(i3377)	182 lb/ft	76 lb/ft	-	100 lb/ft
Uniform	9' 11" : 11' 4 7/16"	-	BBk1(i3377)	3 lb/ft	13 lb/ft	-	-
Uniform	9' 11" : 10' 3 1/2"	-	BBk1(i3377)	73 lb/ft	-	-	-
Uniform	10' 7 11/16" : 15' 5"	-	Smoothed Load	-	280 lb/ft	-	-
Uniform	11' 6 3/16" : 12' 11"	-	BBk1(i3377)	3 lb/ft	13 lb/ft	-	-
Uniform	13' 1 3/8" : 14' 6"	-	BBk1(i3377)	3 lb/ft	13 lb/ft	-	-
Uniform	14' 8 9/16" : 16' 2"	-	BBk1(i3377)	3 lb/ft	13 lb/ft	-	-
Uniform	16' 3 3/4" : 16' 11"	-	BBk1(i3377)	3 lb/ft	13 lb/ft	-	-
Uniform	17' 1 1/4" : 17' 9 1/4"	-	BBk1(i3377)	3 lb/ft	13 lb/ft	-	-
Uniform	17' 11" : 19' 4 7/16"	-	BBk1(i3377)	3 lb/ft	13 lb/ft	-	-
Uniform	19' 6 3/16" : 20' 11"	-	BBk1(i3377)	3 lb/ft	13 lb/ft	-	-
Uniform	21' 1 3/8" : 22' 6"	-	BBk1(i3377)	3 lb/ft	13 lb/ft	-	-
Uniform	22' 8 9/16" : 24' 2"	-	BBk1(i3377)	3 lb/ft	13 lb/ft	-	-
Uniform	24' 3 3/4" : 25' 7"	-	BBk1(i3377)	3 lb/ft	13 lb/ft	-	-
Tapered	18' 7 11/16" : 23' 5"	-	Smoothed Load	-	280 To 278 lb/ft	-	-
Point	1" :-	-	BBk1(i3377)	18 lb	13 lb	-	-
Point	2 7/8" :-	-	B8'(i3200)	49 lb	146 lb	-	-
Point	6' 7 11/16" :-	-	B16'(i3196)	124 lb	443 lb	-	-
Point	8' 2 7/8" :-	-	B16'(i3195)	165 lb	414 lb	-	33 lb
Point	8' 11 1/8" :-	-	BBk1(i3377)	1 lb	3 lb	-	-
Point	9' 1 3/4" :-	-	M2-3(i3405)	2369 lb	1295 lb	-	1685 lb
Point	9' 4 3/8" :-	-	BBk1(i3377)	1 lb	3 lb	-	-
Point	9' 10 1/8" :-	-	B16'(i3194)	145 lb	321 lb	-	-
Point	10' 2" :-	-	BBk1(i3377)	989 lb	511 lb	-	809 lb
Point	11' 5 5/16" :-	-	B16'(i3306)	143 lb	-	-	-
Point	13' 0 1/2" :-	-	B16'(i3192)	112 lb	-	-	-
Point	14' 7 11/16" :-	-	B16'(i3191)	153 lb	-	-	-
Point	16' 2 7/8" :-	-	B16'(i3190)	175 lb	335 lb	-	-
Point	16' 11 1/2" :-	-	BBk1(i3377)	-	1 lb	-	-
Point	17' 0 3/8" :-	-	B16'(i3206)	119 lb	224 lb	-	-
Point	17' 1 1/4" :-	-	BBk1(i3377)	-	1 lb	-	-
Point	17' 10 1/8" :-	-	B16'(i3189)	125 lb	337 lb	-	-
Point	19' 5 5/16" :-	-	B16'(i3337)	112 lb	-	-	-
Point	21' 0 1/2" :-	-	B16'(i3187)	124 lb	-	-	-
Point	22' 7 11/16" :-	-	B16'(i3304)	119 lb	-	-	-
Point	24' 2 7/8" :-	-	B14'(i3320)	103 lb	413 lb	-	-

Errors, Warnings, & Notes:

- * If sloping roof loads are applied to this member, the roof dead load has been adjusted for slope.
- * The member graphic, dimensions, and locations shown on this report are based on the centerline of the member.
- * Analysis and Design has been performed using precision loading from actual modeled conditions. Some loads may have been modified to simplify reporting.
- * Load Duration Factors: Dead - 0.90, Floor Live - 1.00, Roof Live - 1.25, Snow - 1.15



Member Report

Label: M6-2 | Design Tag: i3398

Design Passed

2 piece(s) of 1 3/4" x 9 1/4" 2.0E Microllam® LVL

Member Type: Beam | Level: 1st Floor

Product is Sufficient for Application and Loads Described

Weyerhaeuser warrants that the sizing of its products will be in accordance with Weyerhaeuser product design criteria and published design values. Weyerhaeuser expressly disclaims any other warranties related to the software. Refer to current literature for installation details and trademark information available at wy.com/woodproducts. Use of this software is not intended to circumvent the need for a design professional as determined by the authority having jurisdiction. The designer of record, builder or framer is responsible to assure that this calculation is compatible with the overall project. The product application, input design loads, dimensions and support information have been provided by _____ of _____.

Copyright Weyerhaeuser NR Company. All rights reserved.



Member Report

Label: M5-2 | Design Tag: i3380

2 piece(s) of 1 3/4" x 9 1/4" 2.0E Microllam® LVL

Member Type: Beam | Level: 1st Floor

Design Passed

Product is Sufficient for Application and Loads Described

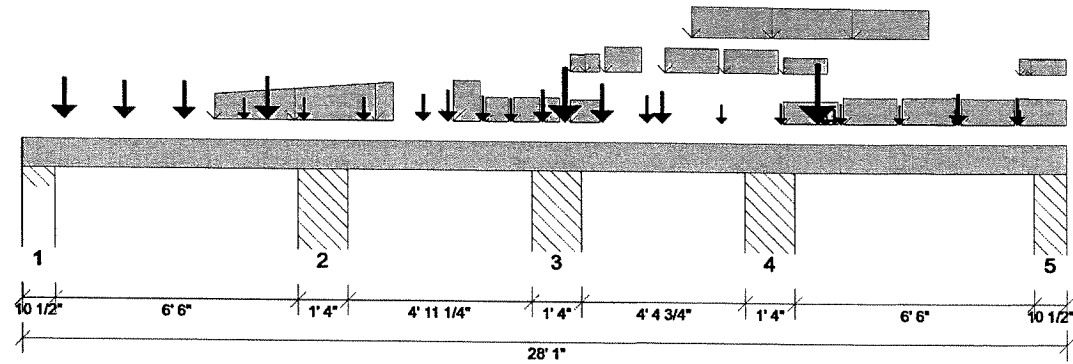

Building Code: IBC 2012 Design Methodology: ASD Member Cut Length: 28' 1" Member Drawing Not to Scale

Design Results:	Design @ Location	Allowed	Result	LDF	Load Combination - (Load Group)
Critical Reaction	9481 lb @ 7' 6"	28219 lb (10.75")	Passed - 34%	-	1.0 D + 1.0 L - (0)
Shear	5212 lb @ 21' 5 3/4"	6151 lb	Passed - 85%	1.00	1.0 D + 1.0 L - (0)
Moment	-5714 lb-ft @ 20' 7"	11204 lb-ft	Passed - 51%	1.00	1.0 D + 1.0 L - (0)
Live Load Deflection	0.07" @ 24' 1 1/2"	0.23" L/360	Passed - L/999	-	1.0 D + 1.0 L - (0)
Total Load Deflection	0.10" @ 24' 1 7/8"	0.34" L/240	Passed - L/843	-	1.0 D + 1.0 L - (0)

Vertical Load Capacity Check Passed

Design Notes:

* Top Edge Bracing (Lu): Top compression edge must be braced at 26-04-00 o/c based on loads applied, unless detailed otherwise.

* Bottom Edge Bracing (Lu): Bottom compression edge must be braced at 20-01-00 o/c based on loads applied, unless detailed otherwise.

Supports:

Support	Start : End	Req'd Br'g	Source	Maximum Loads to Supports			
				Dead	Floor Live	Roof Live	Snow
1	0" : 10 1/2"		-	1290 lb	2205 / -11 lb	-	1 lb
++>	1 1/4" : -	1.5"	F9(i1610)	307 lb	525 / -3 lb	-	-
++>	6 1/2" : -	-	PBO18(i1615)	983 lb	1680 / -8 lb	-	1 lb
2	7' 4 1/2" : 8' 8 1/2"		PBO15(i1612)	3801 lb	8394 / -12 lb	-	272 / -152 lb
==>	7' 6" : -	3.61"	PBO15(i1612)	3645 lb	5592 lb	-	-152 lb
==>	8' 7" : -	1.5"	PBO15(i1612)	156 lb	2802 / -12 lb	-	272 lb
3	13' 7 3/4" : 14' 11 3/4"		PBO16(i1613)	4949 lb	7025 / -2411 lb	-	1421 / -204 lb
==>	13' 9 1/4" : -	1.82"	PBO16(i1613)	3199 lb	4555 lb	-	1010 lb
==>	14' 10 1/4" : -	1.5"	PBO16(i1613)	1750 lb	2470 / -2411 lb	-	411 / -204 lb
4	19' 4 1/2" : 20' 8 1/2"		PBO17(i1614)	4099 lb	8394 lb	-	1195 lb
==>	19' 6" : -	1.5"	PBO17(i1614)	-	2590 lb	-	-
==>	20' 7" : -	3.45"	PBO17(i1614)	4099 lb	5804 lb	-	1195 lb
5	27' 2 1/2" : 28' 1"		-	1242 lb	1992 lb	-	88 lb
++>	27' 6 1/2" : -	1.5"	PBO19(i1616)	946 lb	1518 lb	-	67 lb
++>	27' 11 3/4" : -	-	F12(i1600)	296 lb	474 lb	-	21 lb

Loads:

Type	Start : End	Combine	Source	Maximum Loads on Member			
				Dead	Floor Live	Roof Live	Snow
Self Weight	0" : 28' 1"	-	Self Weight	9 lb/ft	-	-	-
Uniform	11' 6 1/2" : 12' 3 1/4"	-	BBk1(i3384)	409 lb/ft	168 lb/ft	-	310 lb/ft
Uniform	12' 5" : 13' 0 1/4"	-	BBk1(i3384)	157 lb/ft	168 lb/ft	-	-
Uniform	13' 2" : 13' 10 7/16"	-	BBk1(i3384)	157 lb/ft	168 lb/ft	-	-
Uniform	14' 0 3/16" : 14' 4"	-	BBk1(i3384)	157 lb/ft	168 lb/ft	-	-

File Name: SR-285597

DAY/ MURRAY PLAN

REVISION DATE

REVISION COMMENTS

Javelin® Software 6.4.1.3

Design Engine: V8.0.0.21

Data: V7.3.2.0

8/25/2020 9:38:48 AM

Page 1 of 3

Member Report

Label: M5-2 | Design Tag: i3380

2 piece(s) of 1 3/4" x 9 1/4" 2.0E Microllam® LVL

Member Type: Beam | Level: 1st Floor

Design Passed

Product is Sufficient for Application and Loads Described

Uniform	14' 8 1/4" : 15' 5 5/8"	-	BBk1(i3384)	134 lb/ft	123 lb/ft	-	-
Uniform	14' 8 1/4" : 15' 1"	-	BBk1(i3384)	22 lb/ft	45 lb/ft	-	-
Uniform	20' 5" : 21' 10 7/16"	-	BBk1(i3384)	134 lb/ft	123 lb/ft	-	-
Tapered	5' 1 11/16" : 9' 11"	-	Smoothed Load	-	360 To 815 lb/ft	-	-
Tapered	15' 1" : 15' 5 5/8"	-	BBk1(i3384)	33 To 31 lb/ft	66 To 62 lb/ft	-	-
Tapered	15' 7 3/8" : 16' 7"	-	BBk1(i3384)	165 To 160 lb/ft	184 To 174 lb/ft	-	-
Tapered	17' 2 9/16" : 18' 8"	-	BBk1(i3384)	157 To 150 lb/ft	168 To 154 lb/ft	-	-
Tapered	17' 11 5/16" : 24' 4"	-	Smoothed Load	-	559 To 479 lb/ft	-	-
Tapered	18' 9 3/4" : 20' 3 1/4"	-	BBk1(i3384)	149 To 142 lb/ft	153 To 139 lb/ft	-	-
Tapered	20' 5" : 21' 7 1/16"	-	BBk1(i3384)	7 To 2 lb/ft	14 To 3 lb/ft	-	-
Tapered	22' 0 3/16" : 23' 5"	-	BBk1(i3384)	180 To 176 lb/ft	214 To 207 lb/ft	-	-
Tapered	23' 7 3/8" : 25' 0"	-	BBk1(i3384)	176 To 180 lb/ft	208 To 230 lb/ft	-	-
Tapered	25' 2 9/16" : 26' 8"	-	BBk1(i3384)	172 To 168 lb/ft	198 To 191 lb/ft	-	-
Tapered	26' 9 3/4" : 28' 1"	-	BBk1(i3384)	177 To 167 lb/ft	225 To 193 lb/ft	-	-
Tapered	26' 9 3/4" : 27' 1 5/8"	-	BBk1(i3384)	4 To 3 lb/ft	16 To 13 lb/ft	-	-
Tapered	27' 1 5/8" : 28' 1"	-	BBk1(i3384)	3 To 1 lb/ft	13 To 3 lb/ft	-	-
Point	1' 1 11/16" :-	-	B22(i3166)	702 lb	1081 lb	-	-
Point	2' 8 7/8" :-	-	B22(i3167)	589 lb	1016 lb	-	-
Point	4' 4 1/8" :-	-	B22(i3168)	589 lb	1016 lb	-	-
Point	5' 11 5/16" :-	-	B22(i3169)	421 lb	-	-	-
Point	6' 6 3/4" :-	-	B22-2(i3204)	931 lb	1005 lb	-	-
Point	7' 6 1/2" :-	-	B22(i3170)	471 lb	-	-	-
Point	9' 1 11/16" :-	-	B22(i3171)	568 lb	-	-	-
Point	10' 8 7/8" :-	-	B14(i3172)	285 lb	522 lb	-	-
Point	10' 8 7/8" :-	-	B10-2(i3317)	283 lb	281 lb	-	-
Point	11' 4 3/4" :-	-	B14-2(i3315)	680 lb	276 lb	-	136 lb
Point	12' 4 1/8" :-	-	B12(i3203)	331 lb	367 lb	-	27 lb
Point	13' 1 1/8" :-	-	B14(i3173)	238 lb	325 lb	-	-
Point	13' 11 5/16" :-	-	B24(i3335)	476 lb	717 lb	-	-
Point	14' 6 1/2" :-	-	M3-2(i3038)	1330 lb	496 lb	-	946 lb
Point	15' 6 1/2" :-	-	B26(i3175)	720 lb	879 lb	-	40 lb
Point	16' 8 3/4" :-	-	B14-2(i3202)	561 lb	256 lb	-	-
Point	17' 1 11/16" :-	-	B24(i3176)	339 lb	806 lb	-	12 lb
Point	18' 8 7/8" :-	-	B24(i3177)	243 lb	-	-	-
Point	20' 4 1/8" :-	-	B22(i3330)	337 lb	-	-	-
Point	21' 3 7/8" :-	-	BBk1(i3384)	1318 lb	729 lb	-	1143 lb
Point	21' 5 11/16" :-	-	BBk1(i3384)	-	1 lb	-	-
Point	21' 6 7/8" :-	-	BBk1(i3384)	9 lb	19 lb	-	-
Point	21' 9 1/4" :-	-	BBk1(i3384)	9 lb	18 lb	-	-
Point	21' 11 5/16" :-	-	B20(i3179)	369 lb	-	-	-
Point	23' 6 1/2" :-	-	B18(i3382)	281 lb	-	-	-
Point	25' 0 13/16" :-	-	BBk1(i3384)	1 lb	2 lb	-	-
Point	25' 1 11/16" :-	-	B16(i3181)	256 lb	862 lb	-	-
Point	26' 8 7/8" :-	-	B16(i3321)	324 lb	507 lb	-	-
Point	26' 9 3/4" :-	-	BBk1(i3384)	1 lb	4 lb	-	-

Errors, Warnings, & Notes:

- * If sloping roof loads are applied to this member, the roof dead load has been adjusted for slope.
- * The member graphic, dimensions, and locations shown on this report are based on the centerline of the member.
- * Analysis and Design has been performed using precision loading from actual modeled conditions. Some loads may have been modified to simplify reporting.
- * Load Duration Factors: Dead - 0.90, Floor Live - 1.00, Roof Live - 1.25, Snow - 1.15



Member Report

Label: M5-2 | Design Tag: i3380

Design Passed

2 piece(s) of 1 3/4" x 9 1/4" 2.0E Microllam® LVL

Member Type: Beam | Level: 1st Floor

Product is Sufficient for Application and Loads Described

Weyerhaeuser warrants that the sizing of its products will be in accordance with Weyerhaeuser product design criteria and published design values. Weyerhaeuser expressly disclaims any other warranties related to the software. Refer to current literature for installation details and trademark information available at wy.com/woodproducts. Use of this software is not intended to circumvent the need for a design professional as determined by the authority having jurisdiction. The designer of record, builder or framer is responsible to assure that this calculation is compatible with the overall project. The product application, input design loads, dimensions and support information have been provided by _____ of _____

Copyright Weyerhaeuser NR Company. All rights reserved.



Design Passed

Member Report

Floor Container: FC1 | Label: B16' | Design Tag: i3337

1 piece(s) of 11 7/8" TJI@ 110 joist

Member Type: FloorJoist | Level: 1st Floor

Product is Sufficient for Application and Loads Described

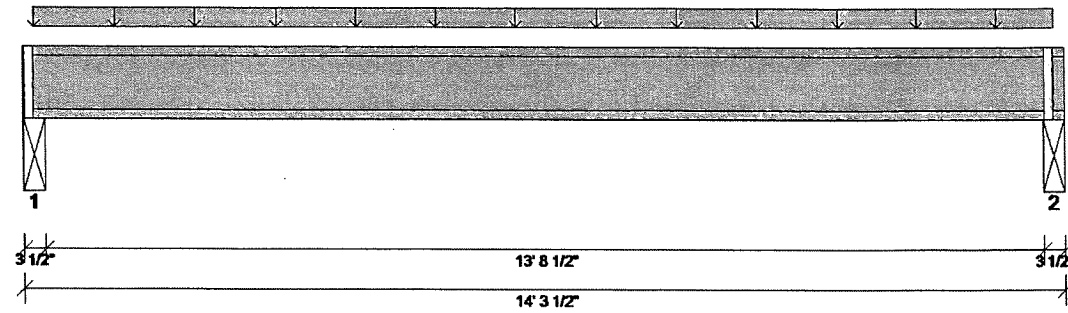

Building Code: IBC 2012 Design Methodology: ASD Member Cut Length: 14' 3 1/2" Member Drawing Not to Scale

Design Results:	Design @ Location	Allowed	Result	LDF	Load Combination -(Load Group)
Critical Reaction	560 lb @ 2 1/2"	1375 lb (3.5")	Passed - 41%	1.00	1.0 D + 1.0 L - (0)
Shear	548 lb @ 3 1/2"	1560 lb	Passed - 35%	1.00	1.0 D + 1.0 L - (0)
Moment	1925 lb-ft @ 7' 1 3/4"	3160 lb-ft	Passed - 61%	1.00	1.0 D + 1.0 L - (0)
Live Load Deflection	0.18" @ 7' 1 11/16"	0.35" L/480	Passed - L/911	-	1.0 D + 1.0 L - (0)
Total Load Deflection	0.23" @ 7' 1 11/16"	0.69" L/240	Passed - L/729	-	1.0 D + 1.0 L - (0)
TJ Pro Rating	43	25	Passed		

Decking Material & Attachment: 23/32"x48"x96" Weyerhaeuser Edge Gold Panel (0/24) T&G SF - Glue And Nail

Design Notes:

- * Top Edge Bracing (Lu): Top compression edge must be braced at 4-01-00 o/c based on loads applied, unless detailed otherwise.
- * Bottom Edge Bracing (Lu): Bottom compression edge must be braced at 14-04-00 o/c based on loads applied, unless detailed otherwise.
- * For TJ-Pro™ Rating calculation the controlling span is considered to be supported by beams.
- * Member design (strength) is based on loads shown in loading section. TJ-Pro™ Rating, if shown, is based on 1-07-03 o.c. spacing.

Supports:

Support	Start : End	Req'd Br'g	Source	Maximum Loads to Supports			
				Dead	Floor Live	Roof Live	Snow
1	0" : 3 1/2"	1.75"	M8-2(i3113)	112 lb	448 lb	-	-
2	14' 0" : 14' 3 1/2"	1.75"	M6-2(i3398)	112 lb	448 lb	-	-

Loads:

Type	Start : End	Combine	Source	Maximum Loads on Member			
				Dead	Floor Live	Roof Live	Snow
Uniform	1 3/4" : 14' 1 3/4"	-	FC1 Floor Decking	16 lb/ft	64 lb/ft	-	-

Errors, Warnings, & Notes:

- * If sloping roof loads are applied to this member, the roof dead load has been adjusted for slope.
- * The member graphic, dimensions, and locations shown on this report are based on the centerline of the member.
- * Analysis and Design has been performed using precision loading from actual modeled conditions. Some loads may have been modified to simplify reporting.
- * The TJ-Pro™ Rating shown above is based on the default decking for the floor container. Special decking (if used) was not used in determination of the TJ-Pro™ Rating.
- * Load Duration Factors: Dead - 0.90, Floor Live - 1.00, Roof Live - 1.25, Snow - 1.15



Member Report

Floor Container: FC1 | Label: B16' | Design Tag: i3337

1 piece(s) of 11 7/8" TJI@ 110 joist

Member Type: FloorJoist | Level: 1st Floor

Product is Sufficient for Application and Loads Described

Design Passed

Weyerhaeuser warrants that the sizing of its products will be in accordance with Weyerhaeuser product design criteria and published design values. Weyerhaeuser expressly disclaims any other warranties related to the software. Refer to current literature for installation details and trademark information available at wy.com/woodproducts. Use of this software is not intended to circumvent the need for a design professional as determined by the authority having jurisdiction. The designer of record, builder or framer is responsible to assure that this calculation is compatible with the overall project. The product application, input design loads, dimensions and support information have been provided by _____ of _____.

Copyright Weyerhaeuser NR Company. All rights reserved.



Design Passed

Member Report

Floor Container: FC1 | Label: B28' | Design Tag: i3331

1 piece(s) of 11 7/8" TJI@ 110 joist

Member Type: FloorJoist | Level: 1st Floor

Product is Sufficient for Application and Loads Described

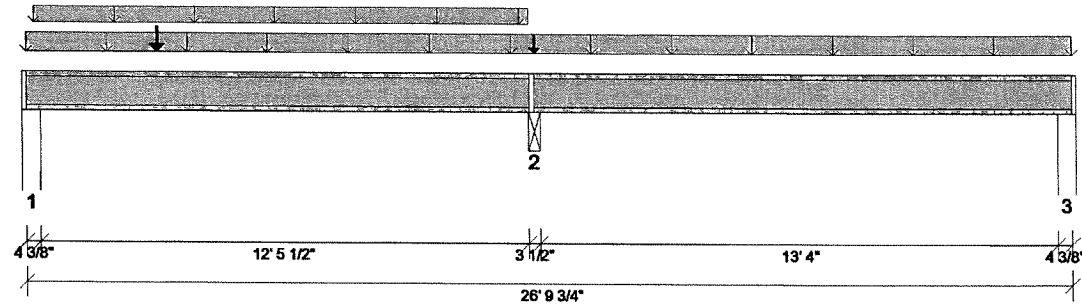

Building Code: IBC 2012 Design Methodology: ASD Member Cut Length: 26' 9 3/4" Member Drawing Not to Scale

Design Results:	Design @ Location	Allowed	Result	LDL	Load Combination - (Load Group)
Critical Reaction	1517 lb @ 12' 11 5/8"	1937 lb (3.51")	Passed - 78%	1.00	1.0 D + 1.0 L - (0)
Shear	734 lb @ 12' 9 7/8"	1716 lb	Passed - 43%	1.00	1.0 D + 1.0 L - (0)
Moment	-1965 lb-ft @ 12' 11 5/8"	3160 lb-ft	Passed - 62%	1.00	1.0 D + 1.0 L - (0)
Live Load Deflection	0.12" @ 20' 1 5/8"	0.34" L/480	Passed - L/999	-	1.0 D + 1.0 L - (0)
Total Load Deflection	0.16" @ 6' 1 1/2"	0.63" L/240	Passed - L/968	-	1.0 D + 1.0 L - (0)
TJ Pro Rating	46	25	Passed		

Decking Material & Attachment: 23/32"x48"x96" Weyerhaeuser Edge Gold Panel (0/24) T&G SF - Glue And Nail

Design Notes:

- * Top Edge Bracing (Lu): Top compression edge must be braced at 5-02-00 o/c based on loads applied, unless detailed otherwise.
- * Bottom Edge Bracing (Lu): Bottom compression edge must be braced at 4-00-00 o/c based on loads applied, unless detailed otherwise.
- * For T-J-Pro™ Rating calculation the controlling span is considered to be supported by beams.
- * Member design (strength) is based on loads shown in loading section. T-J-Pro™ Rating, if shown, is based on 1-07-03 o.c. spacing.

Supports:

Support	Start : End	Req'd Br'g	Source	Maximum Loads to Supports			
				Dead	Floor Live	Roof Live	Snow
1	0" : 4 3/8"	1.75"	F1(i1603)	252 lb	381 / -60 lb	-	-
2	12' 9 7/8" : 13' 1 3/8"	3.5"	M4-2(i3400)	447 lb	1069 lb	-	-
3	26' 5 3/8" : 26' 9 3/4"	1.75"	F15(i1607)	72 lb	402 / -46 lb	-	-

Loads:

Type	Start : End	Combine	Source	Maximum Loads on Member			
				Dead	Floor Live	Roof Live	Snow
Uniform	0" : 26' 9 3/4"	-	FC1 Floor Decking	16 lb/ft	64 lb/ft	-	-
Uniform	2 3/8" : 12' 9 7/8"	-	FC1 Floor Decking	16 lb/ft	-	-	-
Point	3' 4 1/8" : -	-	NB15(i1774)	117 lb	-	-	-
Point	12' 11 5/8" : -	-	B48(i1777)	20 lb	19 lb	-	-

Errors, Warnings, & Notes:

- * If sloping roof loads are applied to this member, the roof dead load has been adjusted for slope.
- * The member graphic, dimensions, and locations shown on this report are based on the centerline of the member.



Member Report

Floor Container: FC1 | Label: B28' | Design Tag: i3331

1 piece(s) of 11 7/8" TJI@ 110 joist

Member Type: FloorJoist | Level: 1st Floor

Product is Sufficient for Application and Loads Described

Design Passed

- * Analysis and Design has been performed using precision loading from actual modeled conditions. Some loads may have been modified to simplify reporting.
- * The TJ-Pro™ Rating shown above is based on the default decking for the floor container. Special decking (if used) was not used in determination of the TJ-Pro™ Rating.
- * Load Duration Factors: Dead - 0.90, Floor Live - 1.00, Roof Live - 1.25, Snow - 1.15

Weyerhaeuser warrants that the sizing of its products will be in accordance with Weyerhaeuser product design criteria and published design values. Weyerhaeuser expressly disclaims any other warranties related to the software. Refer to current literature for installation details and trademark information available at wy.com/woodproducts. Use of this software is not intended to circumvent the need for a design professional as determined by the authority having jurisdiction. The designer of record, builder or framer is responsible to assure that this calculation is compatible with the overall project. The product application, input design loads, dimensions and support information have been provided by _____ of _____.

Copyright Weyerhaeuser NR Company. All rights reserved.



Design Passed

Member Report

Floor Container: FC1 | Label: B14-2 | Design Tag: i3315

2 piece(s) of 11 7/8" TJI@ 110 joist

Member Type: Joist As Flush Beam | Level: 1st Floor

Product is Sufficient for Application and Loads Described

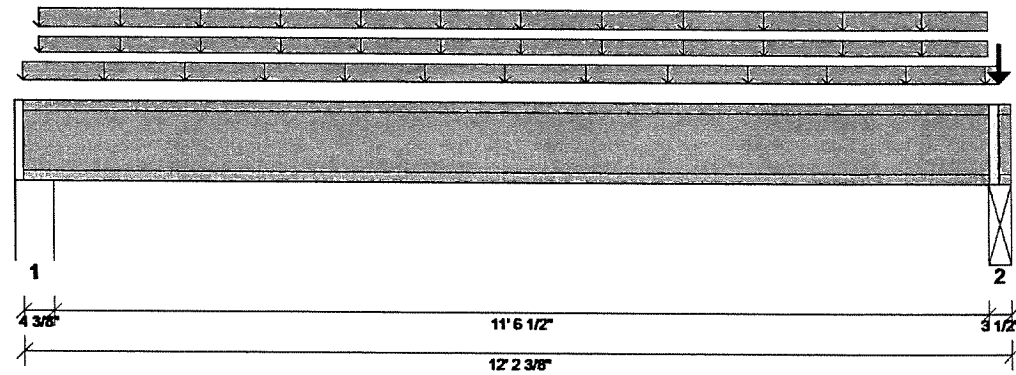

Building Code: IBC 2012 Design Methodology: ASD Member Cut Length: 12' 2 3/8" Member Drawing Not to Scale

Design Results:	Design @ Location	Allowed	Result	LDF	Load Combination - (Load Group)
Critical Reaction	982 lb @ 12' 0 3/8"	2750 lb (3.5")	Passed - 36%	1.00	1.0 D + 1.0 L - (0)
Shear	829 lb @ 11' 10 7/8"	3120 lb	Passed - 27%	1.00	1.0 D + 1.0 L - (0)
Moment	2496 lb-ft @ 6' 1 5/8"	6320 lb-ft	Passed - 39%	1.00	1.0 D + 1.0 L - (0)
Live Load Deflection	0.05" @ 6' 1 5/8"	0.29" L/480	Passed - L/999	-	1.0 D + 1.0 L - (0)
Total Load Deflection	0.14" @ 6' 1 5/8"	0.59" L/240	Passed - L/999	-	1.0 D + 1.0 L - (0)

Design Notes:

- * Top Edge Bracing (Lu): Top compression edge must be braced at 5-01-00 o/c based on loads applied, unless detailed otherwise.
- * Bottom Edge Bracing (Lu): Bottom compression edge must be braced at 12-02-00 o/c based on loads applied, unless detailed otherwise.
- * Member design (strength) is based on loads shown in loading section. TJ-Pro™ Rating, if shown, is based on 1-07-03 o.c. spacing.

Supports:

Support	Start : End	Req'd Br'g	Source	Maximum Loads to Supports			
				Dead	Floor Live	Roof Live	Snow
1	0" : 4 3/8"	1.75"	F10(i1598)	541 lb	294 lb	-	-
2	11' 10 7/8" : 12' 2 3/8"	1.75"	M5-2(i3380)	680 lb	276 lb	-	136 lb

Loads:

Type	Start : End	Combine	Source	Maximum Loads on Member			
				Dead	Floor Live	Roof Live	Snow
Uniform	0" : 12' 0 5/8"	-	FC1 Floor Decking	12 lb/ft	47 lb/ft	-	-
Uniform	2 3/8" : 11' 10 7/8"	-	NB1(i1755)	73 lb/ft	-	-	-
Uniform	2 3/8" : 11' 10 7/8"	-	FC1 Floor Decking	7 lb/ft	-	-	-
Point	12' 0 5/8" : -	-	B27(i1574)	143 lb	-	-	136 lb

Errors, Warnings, & Notes:

- * This member was designed as a girder member due to load and/or framing conditions. TJ-Pro™ Rating, and other joist member modifiers were not used in the design of this member.
- * If sloping roof loads are applied to this member, the roof dead load has been adjusted for slope.
- * The member graphic, dimensions, and locations shown on this report are based on the centerline of the member.
- * Analysis and Design has been performed using precision loading from actual modeled conditions. Some loads may have been modified to simplify reporting.
- * Load Duration Factors: Dead - 0.90, Floor Live - 1.00, Roof Live - 1.25, Snow - 1.15

File Name: SR-285597
DAY/ MURRAY PLAN
REVISION DATE
REVISION COMMENTS

Javelin® Software 6.4.1.3 Design Engine: V8.0.0.21
Data: V7.3.2.0
8/25/2020 9:38:48 AM
Page 1 of 2



Member Report

Floor Container: FC1 | Label: B14'-2 | Design Tag: i3315

2 piece(s) of 11 7/8" TJI@ 110 joist

Member Type: Joist As Flush Beam | Level: 1st Floor

Product is Sufficient for Application and Loads Described

Design Passed

Weyerhaeuser warrants that the sizing of its products will be in accordance with Weyerhaeuser product design criteria and published design values. Weyerhaeuser expressly disclaims any other warranties related to the software. Refer to current literature for installation details and trademark information available at wy.com/woodproducts. Use of this software is not intended to circumvent the need for a design professional as determined by the authority having jurisdiction. The designer of record, builder or framer is responsible to assure that this calculation is compatible with the overall project. The product application, input design loads, dimensions and support information have been provided by _____ of _____.

Copyright Weyerhaeuser NR Company. All rights reserved.



Design Passed

Member Report

Floor Container: FC1 | Label: B10-2 | Design Tag: i3300

2 piece(s) of 11 7/8" TJ@ 110 joist

Member Type: Joist As Flush Beam | Level: 1st Floor

Product is Sufficient for Application and Loads Described

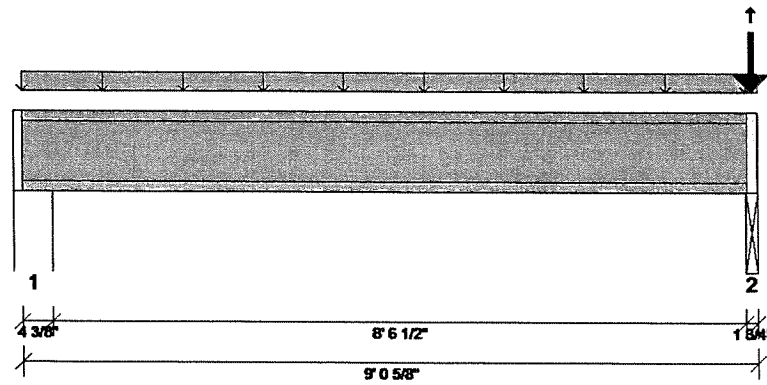

Building Code: IBC 2012 Design Methodology: ASD Member Cut Length: 9' 0 5/8" Member Drawing Not to Scale

Design Results:	Design @ Location	Allowed	Result	LDF	Load Combination - (Load Group)
Critical Reaction	375 lb @ 9' 0 3/8"	1820 lb (1.75")	Passed - 21%	1.00	1.0 D + 1.0 L - (1)
Shear	363 lb @ 4 3/8"	3120 lb	Passed - 12%	1.00	1.0 D + 1.0 L - (1)
Moment	821 lb-ft @ 4' 7 5/8"	6320 lb-ft	Passed - 13%	1.00	1.0 D + 1.0 L - (1)
Live Load Deflection	0.02" @ 4' 7 5/8"	0.22" L/480	Passed - L/999	-	1.0 D + 1.0 L - (1)
Total Load Deflection	0.03" @ 4' 7 5/8"	0.44" L/240	Passed - L/999	-	1.0 D + 1.0 L - (1)

Design Notes:

- * Top Edge Bracing (Lu): Top compression edge must be braced at 7-04-00 o/c based on loads applied, unless detailed otherwise.
- * Bottom Edge Bracing (Lu): Bottom compression edge must be braced at 9-01-00 o/c based on loads applied, unless detailed otherwise.
- * Member design (strength) is based on loads shown in loading section. TJ-Pro™ Rating, if shown, is based on 1-07-03 o.c. spacing.

Supports:

Support	Start : End	Req'd Br'g	Source	Maximum Loads to Supports			
				Dead	Floor Live	Roof Live	Snow
1	0" : 4 3/8"	1.75"	F1(i1603)	74 lb	297 lb	-	-
2	8' 10 7/8" : 9' 0 5/8"	1.75"	M7-2(i3411)	1623 lb	663 lb	-	1440 lb

Loads:

Type	Start : End	Combine	Source	Maximum Loads on Member			
				Dead	Floor Live	Roof Live	Snow
Uniform	-0" : 9' 0 5/8"	-	FC1 Floor Decking	16 lb/ft	64 lb/ft	-	-
Point	8' 11 3/4" :-	-	PBO1(i1527)	1552 lb	381 / -1 lb	-	1440 lb

Column Support (CS) Detail

Location	CS Detail Ratio	Point Load	Load Combination - (Load Group)
9' 0 3/8"	1.5396	2918 lb	1.0 D + 0.75 L + 0.75 S - (1)

Reinforcing Accessories:

Support / Location	Accessory Product(s)
9' 0 3/8"	(2) Column Support (CS) Detail



Member Report

Floor Container: FC1 | Label: B10'-2 | Design Tag: i3300

2 piece(s) of 11 7/8" TJI@ 110 joist

Member Type: Joist As Flush Beam | Level: 1st Floor

Product is Sufficient for Application and Loads Described

Design Passed

Errors, Warnings, & Notes:

- * This member was designed as a girder member due to load and/or framing conditions. TJ-Pro™ Rating, and other joist member modifiers were not used in the design of this member.
- * If sloping roof loads are applied to this member, the roof dead load has been adjusted for slope.
- * The member graphic, dimensions, and locations shown on this report are based on the centerline of the member.
- * Analysis and Design has been performed using precision loading from actual modeled conditions. Some loads may have been modified to simplify reporting.
- * Reinforcement Accessories are required. Refer to current product literature for installation details.
- * Load Duration Factors: Dead - 0.90, Floor Live - 1.00, Roof Live - 1.25, Snow - 1.15

Weyerhaeuser warrants that the sizing of its products will be in accordance with Weyerhaeuser product design criteria and published design values. Weyerhaeuser expressly disclaims any other warranties related to the software. Refer to current literature for installation details and trademark information available at wy.com/woodproducts. Use of this software is not intended to circumvent the need for a design professional as determined by the authority having jurisdiction. The designer of record, builder or framer is responsible to assure that this calculation is compatible with the overall project. The product application, input design loads, dimensions and support information have been provided by _____ of _____.

Copyright Weyerhaeuser NR Company. All rights reserved.



Design Passed

Member Report

Floor Container: FC1 | Label: B14'-2 | Design Tag: i3210

2 piece(s) of 11 7/8" TJI® 110 joist

Member Type: Joist As Flush Beam | Level: 1st Floor

Product is Sufficient for Application and Loads Described

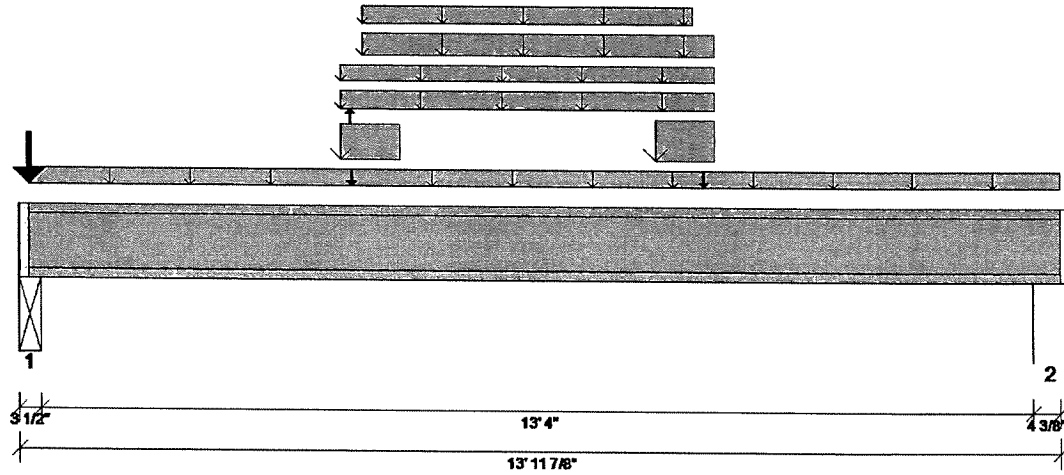

Building Code: IBC 2012 Design Methodology: ASD Member Cut Length: 13' 11 7/8" Member Drawing Not to Scale

Design Results:	Design @ Location	Allowed	Result	LDF	Load Combination - (Load Group)
Critical Reaction	1640 lb @ 2"	3163 lb (3.5")	Passed - 52%	1.15	1.0 D + 0.75 L + 0.75 S - (0)
Shear	1283 lb @ 13' 7 1/2"	3588 lb	Passed - 36%	1.15	1.0 D + 0.75 L + 0.75 S - (0)
Moment	6299 lb-ft @ 7' 0 3/4"	7268 lb-ft	Passed - 87%	1.15	1.0 D + 0.75 L + 0.75 S - (0)
Live Load Deflection	0.18" @ 6' 11 11/16"	0.34" L/480	Passed - L/888	-	1.0 D + 0.75 L + 0.75 S - (0)
Total Load Deflection	0.43" @ 6' 11 5/8"	0.68" L/240	Passed - L/379	-	1.0 D + 0.75 L + 0.75 S - (0)

Design Notes:

- * Top Edge Bracing (Lu): Top compression edge must be braced at 3-01-00 o/c based on loads applied, unless detailed otherwise.
- * Bottom Edge Bracing (Lu): Bottom compression edge must be braced at 14-00-00 o/c based on loads applied, unless detailed otherwise.
- * Member design (strength) is based on loads shown in loading section. T-J-Pro™ Rating, if shown, is based on 1-07-03 o.c. spacing.

Supports:

Support	Start : End	Req'd Br'g	Source	Maximum Loads to Supports			
				Dead	Floor Live	Roof Live	Snow
1	0" : 3 1/2"	1.75"	M4-2(i3400)	875 lb	376 lb	-	603 lb
2	13' 7 1/2" : 13' 11 7/8"	1.75"	F15(i1607)	683 lb	341 lb	-	429 lb

Loads:

Type	Start : End	Combine	Source	Maximum Loads on Member			
				Dead	Floor Live	Roof Live	Snow
Uniform	1 3/4" : 13' 11 7/8"	-	FC1 Floor Decking	8 lb/ft	32 lb/ft	-	-
Uniform	4' 3 3/4" : 9' 3 3/4"	-	B5(i1553)	73 lb/ft	-	-	-
Uniform	4' 3 3/4" : 9' 3 3/4"	-	FC1 Floor Decking	16 lb/ft	-	-	-
Uniform	4' 3 3/4" : 5' 1 1/4"	-	B5(i1553)	200 lb/ft	66 lb/ft	-	216 lb/ft
Uniform	4' 7 1/4" : 9' 3 3/4"	-	B5(i1553)	75 lb/ft	-	-	100 lb/ft
Uniform	4' 7 1/4" : 9' 0 1/4"	-	B5(i1553)	13 lb/ft	26 lb/ft	-	-
Uniform	8' 6 1/4" : 9' 3 3/4"	-	B5(i1553)	267 lb/ft	81 lb/ft	-	273 lb/ft
Point	1 3/4" : -	-	B11(i1548)	187 lb	46 lb	-	174 lb
Point	4' 5 1/4" : -	-	B5(i1553)	-	-5 lb	-	-
Point	4' 5 1/2" : -	-	B3(i1546)	18 lb	-	-	-
Point	9' 2" : -	-	B4(i1555)	18 lb	-	-	-

Errors, Warnings, & Notes:

File Name: SR-285597
DAY/MURRAY PLAN
REVISION DATE
REVISION COMMENTS

Javelin® Software 6.4.1.3 Design Engine: V8.0.0.21

Data: V7.3.2.0

8/25/2020 9:38:48 AM

Page 1 of 2



Member Report

Floor Container: FC1 | Label: B14'-2 | Design Tag: i3210

2 piece(s) of 11 7/8" TJI® 110 joist

Member Type: Joist As Flush Beam | Level: 1st Floor

Product is Sufficient for Application and Loads Described

Design Passed

* This member was designed as a girder member due to load and/or framing conditions. T-J-Pro™ Rating, and other joist member modifiers were not used in the design of this member.

* If sloping roof loads are applied to this member, the roof dead load has been adjusted for slope.

* The member graphic, dimensions, and locations shown on this report are based on the centerline of the member.

* Analysis and Design has been performed using precision loading from actual modeled conditions. Some loads may have been modified to simplify reporting.

* Load Duration Factors: Dead - 0.90, Floor Live - 1.00, Roof Live - 1.25, Snow - 1.15

Weyerhaeuser warrants that the sizing of its products will be in accordance with Weyerhaeuser product design criteria and published design values. Weyerhaeuser expressly disclaims any other warranties related to the software. Refer to current literature for installation details and trademark information available at wy.com/woodproducts. Use of this software is not intended to circumvent the need for a design professional as determined by the authority having jurisdiction. The designer of record, builder or framer is responsible to assure that this calculation is compatible with the overall project. The product application, input design loads, dimensions and support information have been provided by _____ of _____.

Copyright Weyerhaeuser NR Company. All rights reserved.



Design Passed

Member Report

Floor Container: FC1 | Label: B14'-2 | Design Tag: i3209

2 piece(s) of 11 7/8" TJI@ 110 joist

Member Type: Joist As Flush Beam | Level: 1st Floor

Product is Sufficient for Application and Loads Described

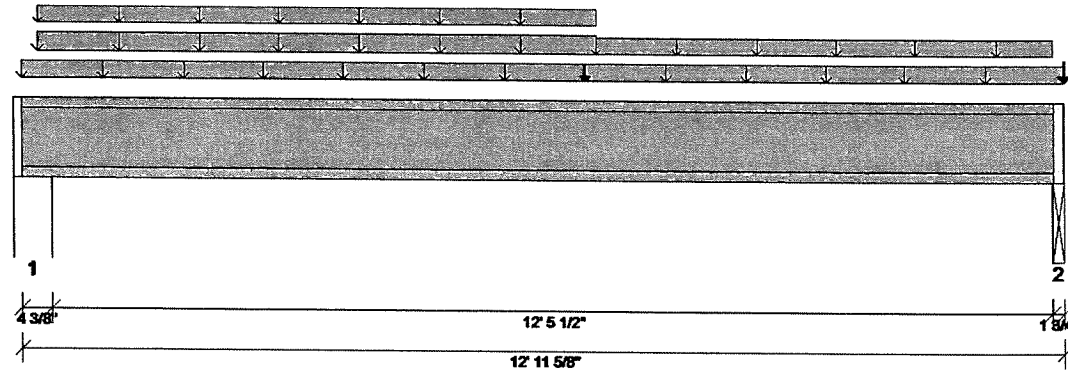

Building Code: IBC 2012 Design Methodology: ASD Member Cut Length: 12' 11 5/8" Member Drawing Not to Scale

Design Results:	Design @ Location	Allowed	Result	LDF	Load Combination - (Load Group)
Critical Reaction	549 lb @ 12' 11 3/8"	1820 lb (1.75")	Passed - 30%	1.00	1.0 D + 1.0 L - (0)
Shear	671 lb @ 4 3/8"	3120 lb	Passed - 22%	1.00	1.0 D + 1.0 L - (0)
Moment	1935 lb-ft @ 5' 10 9/16"	6320 lb-ft	Passed - 31%	1.00	1.0 D + 1.0 L - (0)
Live Load Deflection	0.04" @ 6' 7 1/16"	0.32" L/480	Passed - L/999	-	1.0 D + 1.0 L - (0)
Total Load Deflection	0.12" @ 6' 5"	0.64" L/240	Passed - L/999	-	1.0 D + 1.0 L - (0)

Design Notes:

- * Top Edge Bracing (Lu): Top compression edge must be braced at 5-10-00 o/c based on loads applied, unless detailed otherwise.
- * Bottom Edge Bracing (Lu): Bottom compression edge must be braced at 13-00-00 o/c based on loads applied, unless detailed otherwise.
- * Member design (strength) is based on loads shown in loading section. TJI-Pro™ Rating, if shown, is based on 1-07-03 o.c. spacing.

Supports:

Support	Start : End	Req'd Br'g	Source	Maximum Loads to Supports			
				Dead	Floor Live	Roof Live	Snow
1	0" : 4 3/8"	1.75"	F1(i1603)	455 lb	214 lb	-	-
2	12' 9 7/8" : 12' 11 5/8"	1.75"	M4-2(i3400)	277 lb	243 lb	-	-

Loads:

Type	Start : End	Combine	Source	Maximum Loads on Member			
				Dead	Floor Live	Roof Live	Snow
Uniform	0" : 12' 11 5/8"	-	FC1 Floor Decking	8 lb/ft	32 lb/ft	-	-
Uniform	2 3/8" : 7' 1 3/8"	-	NB11(i1773)	73 lb/ft	-	-	-
Uniform	2 3/8" : 7' 1 3/8"	-	FC1 Floor Decking	4 lb/ft	-	-	-
Uniform	7' 1 3/8" : 12' 9 7/8"	-	FC1 Floor Decking	8 lb/ft	-	-	-
Point	6' 11 5/8" : -	-	FC1 Floor Decking	11 lb	-	-	-
Point	12' 11 5/8" : -	-	B48(i1777)	41 lb	39 lb	-	-

Errors, Warnings, & Notes:

- * This member was designed as a girder member due to load and/or framing conditions. TJI-Pro™ Rating, and other joist member modifiers were not used in the design of this member.
- * If sloping roof loads are applied to this member, the roof dead load has been adjusted for slope.
- * The member graphic, dimensions, and locations shown on this report are based on the centerline of the member.



Member Report

Floor Container: FC1 | Label: B14'-2 | Design Tag: i3209

2 piece(s) of 11 7/8" TJI® 110 joist

Member Type: Joist As Flush Beam | Level: 1st Floor

Product is Sufficient for Application and Loads Described

Design Passed

* Analysis and Design has been performed using precision loading from actual modeled conditions. Some loads may have been modified to simplify reporting.

* Load Duration Factors: Dead - 0.90, Floor Live - 1.00, Roof Live - 1.25, Snow - 1.15

Weyerhaeuser warrants that the sizing of its products will be in accordance with Weyerhaeuser product design criteria and published design values. Weyerhaeuser expressly disclaims any other warranties related to the software. Refer to current literature for installation details and trademark information available at wy.com/woodproducts. Use of this software is not intended to circumvent the need for a design professional as determined by the authority having jurisdiction. The designer of record, builder or framer is responsible to assure that this calculation is compatible with the overall project. The product application, input design loads, dimensions and support information have been provided by _____ of _____.

Copyright Weyerhaeuser NR Company. All rights reserved.



Design Passed

Member Report

Floor Container: FC1 | Label: B22'-2 | Design Tag: i3204

2 piece(s) of 11 7/8" TJI@ 110 joist

Member Type: Joist As Flush Beam | Level: 1st Floor

Product is Sufficient for Application and Loads Described

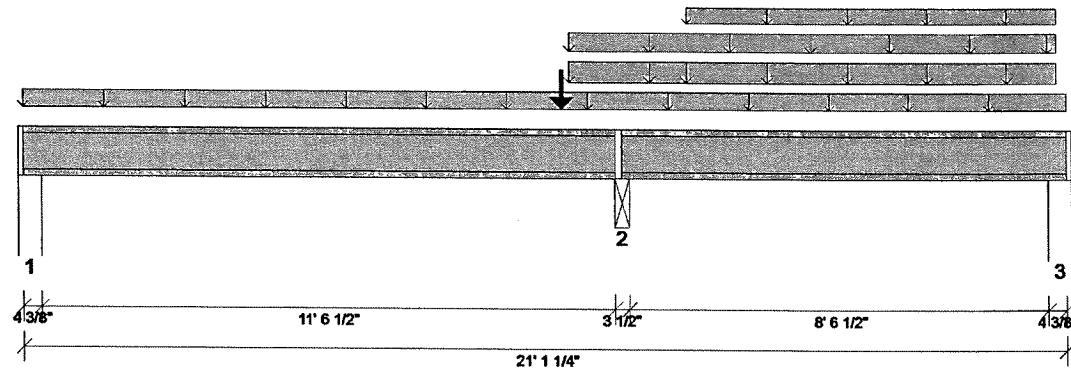

Building Code: IBC 2012 Design Methodology: ASD Member Cut Length: 21' 1 1/4" Member Drawing Not to Scale

Design Results:	Design @ Location	Allowed	Result	LDF	Load Combination - (Load Group)
Critical Reaction	2001 lb @ 12' 0 5/8"	3870 lb (3.5")	Passed - 52%	1.00	1.0 D + 1.0 L - (0)
Shear	1051 lb @ 12' 2 3/8"	3432 lb	Passed - 31%	1.00	1.0 D + 1.0 L - (0)
Moment	1643 lb-ft @ 17' 0 9/16"	6320 lb-ft	Passed - 26%	1.00	1.0 D + 1.0 L - (0)
Live Load Deflection	0.03" @ 16' 7 7/8"	0.22" L/480	Passed - L/999	-	1.0 D + 1.0 L - (0)
Total Load Deflection	0.06" @ 16' 8 5/8"	0.44" L/240	Passed - L/999	-	1.0 D + 1.0 L - (0)

Design Notes:

- * Top Edge Bracing (Lu): Top compression edge must be braced at 6-04-00 o/c based on loads applied, unless detailed otherwise.
- * Bottom Edge Bracing (Lu): Bottom compression edge must be braced at 6-05-00 o/c based on loads applied, unless detailed otherwise.
- * Member design (strength) is based on loads shown in loading section. TJ-Pro™ Rating, if shown, is based on 1-07-03 o.c. spacing.

Supports:

Support	Start : End	Req'd Br'g	Source	Maximum Loads to Supports			
				Dead	Floor Live	Roof Live	Snow
1	0" : 4 3/8"	1.75"	F10(i1598)	10 lb	181 / -36 lb	-	-
2	11' 10 7/8" : 12' 2 3/8"	3.5"	M5-2(i3380)	931 lb	1005 lb	-	-
3	20' 8 7/8" : 21' 1 1/4"	1.75"	F8(i1597)	449 lb	418 / -47 lb	-	-

Loads:

Type	Start : End	Combine	Source	Maximum Loads on Member			
				Dead	Floor Live	Roof Live	Snow
Uniform	0" : 21' 1 1/4"	-	FC1 Floor Decking	8 lb/ft	32 lb/ft	-	-
Uniform	10' 11 7/8" : 20' 10"	-	B15(i1564)	73 lb/ft	-	-	-
Uniform	10' 11 7/8" : 13' 4"	-	B15(i1564)	36 lb/ft	72 lb/ft	-	-
Uniform	13' 4 3/8" : 20' 10"	-	B15(i1564)	35 lb/ft	71 lb/ft	-	-
Uniform	13' 4 3/8" : 20' 10"	-	FC1 Floor Decking	2 lb/ft	-	-	-
Point	10' 10 1/8" : -	-	B18(i1576)	132 lb	136 lb	-	-

Errors, Warnings, & Notes:

- * This member was designed as a girder member due to load and/or framing conditions. TJ-Pro™ Rating, and other joist member modifiers were not used in the design of this member.
- * If sloping roof loads are applied to this member, the roof dead load has been adjusted for slope.



Member Report

Floor Container: FC1 | Label: B22'-2 | Design Tag: i3204

Design Passed

2 piece(s) of 11 7/8" TJI@ 110 joist

Member Type: Joist As Flush Beam | Level: 1st Floor

Product is Sufficient for Application and Loads Described

- * The member graphic, dimensions, and locations shown on this report are based on the centerline of the member.
- * Analysis and Design has been performed using precision loading from actual modeled conditions. Some loads may have been modified to simplify reporting.
- * Load Duration Factors: Dead - 0.90, Floor Live - 1.00, Roof Live - 1.25, Snow - 1.15

Weyerhaeuser warrants that the sizing of its products will be in accordance with Weyerhaeuser product design criteria and published design values. Weyerhaeuser expressly disclaims any other warranties related to the software. Refer to current literature for installation details and trademark information available at wy.com/woodproducts. Use of this software is not intended to circumvent the need for a design professional as determined by the authority having jurisdiction. The designer of record, builder or framer is responsible to assure that this calculation is compatible with the overall project. The product application, input design loads, dimensions and support information have been provided by _____ of _____.

Copyright Weyerhaeuser NR Company. All rights reserved.



Design Passed

Member Report

Floor Container: FC1 | Label: B14'-2 | Design Tag: i3202

2 piece(s) of 11 7/8" TJI® 110 joist

Member Type: Joist As Flush Beam | Level: 1st Floor

Product is Sufficient for Application and Loads Described

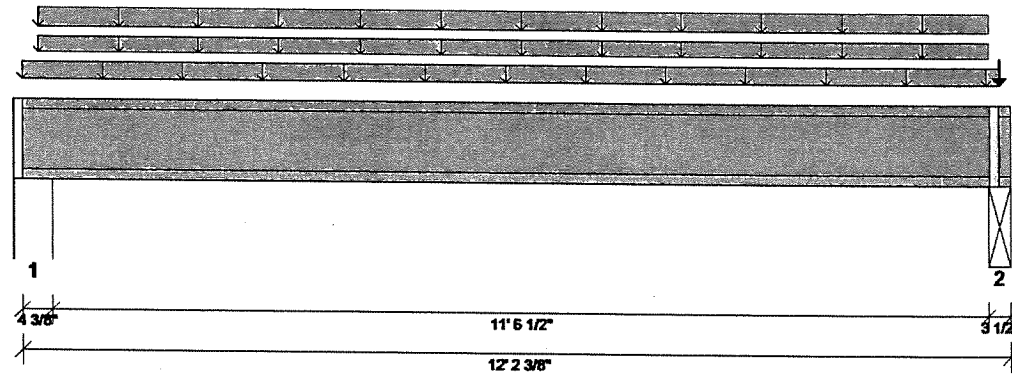

Building Code: IBC 2012 Design Methodology: ASD Member Cut Length: 12' 2 3/8" Member Drawing Not to Scale

Design Results:	Design @ Location	Allowed	Result	LDF	Load Combination - (Load Group)
Critical Reaction	843 lb @ 12' 0 3/8"	2750 lb (3.5")	Passed - 31%	1.00	1.0 D + 1.0 L - (0)
Shear	706 lb @ 11' 10 7/8"	3120 lb	Passed - 23%	1.00	1.0 D + 1.0 L - (0)
Moment	2127 lb-ft @ 6' 1 5/8"	6320 lb-ft	Passed - 34%	1.00	1.0 D + 1.0 L - (0)
Live Load Deflection	0.03" @ 6' 1 5/8"	0.29" L/480	Passed - L/999	-	1.0 D + 1.0 L - (0)
Total Load Deflection	0.12" @ 6' 1 5/8"	0.59" L/240	Passed - L/999	-	1.0 D + 1.0 L - (0)

Design Notes:

- * Top Edge Bracing (Lu): Top compression edge must be braced at 5-07-00 o/c based on loads applied, unless detailed otherwise.
- * Bottom Edge Bracing (Lu): Bottom compression edge must be braced at 12-02-00 o/c based on loads applied, unless detailed otherwise.
- * Member design (strength) is based on loads shown in loading section. T-J-Pro™ Rating, if shown, is based on 1-07-03 o.c. spacing.

Supports:

Support	Start : End	Req'd Br'g	Source	Maximum Loads to Supports			
				Dead	Floor Live	Roof Live	Snow
1	0" : 4 3/8"	1.75"	F10(i1598)	503 lb	201 lb	-	-
2	11' 10 7/8" : 12' 2 3/8"	1.75"	M5-2(i3380)	561 lb	256 lb	-	-

Loads:

Type	Start : End	Combine	Source	Maximum Loads on Member			
				Dead	Floor Live	Roof Live	Snow
Uniform	0" : 12' 0 5/8"	-	FC1 Floor Decking	8 lb/ft	32 lb/ft	-	-
Uniform	2 3/8" : 11' 10 7/8"	-	NB2(i1757)	73 lb/ft	-	-	-
Uniform	2 3/8" : 11' 10 7/8"	-	FC1 Floor Decking	5 lb/ft	-	-	-
Point	12' 0 5/8" :-	-	B27(i1574)	61 lb	67 lb	-	-

Errors, Warnings, & Notes:

- * This member was designed as a girder member due to load and/or framing conditions. T-J-Pro™ Rating, and other joist member modifiers were not used in the design of this member.
- * If sloping roof loads are applied to this member, the roof dead load has been adjusted for slope.
- * The member graphic, dimensions, and locations shown on this report are based on the centerline of the member.
- * Analysis and Design has been performed using precision loading from actual modeled conditions. Some loads may have been modified to simplify reporting.
- * Load Duration Factors: Dead - 0.90, Floor Live - 1.00, Roof Live - 1.25, Snow - 1.15

File Name: SR-285597
DAY/MURRAY PLAN
REVISION DATE
REVISION COMMENTS

Javelin® Software 6.4.1.3 Design Engine: V8.0.0.21
Data: V7.3.2.0
8/25/2020 9:38:48 AM
Page 1 of 2



Design Passed

Member Report

Floor Container: FC1 | Label: B14'-2 | Design Tag: i3202

2 piece(s) of 11 7/8" TJI® 110 joist

Member Type: Joist As Flush Beam | Level: 1st Floor

Product is Sufficient for Application and Loads Described

Weyerhaeuser warrants that the sizing of its products will be in accordance with Weyerhaeuser product design criteria and published design values. Weyerhaeuser expressly disclaims any other warranties related to the software. Refer to current literature for installation details and trademark information available at wy.com/woodproducts. Use of this software is not intended to circumvent the need for a design professional as determined by the authority having jurisdiction. The designer of record, builder or framer is responsible to assure that this calculation is compatible with the overall project. The product application, input design loads, dimensions and support information have been provided by _____ of _____.

Copyright Weyerhaeuser NR Company. All rights reserved.



Member Report

Floor Container: FC1 | Label: B22' | Design Tag: i3167

1 piece(s) of 11 7/8" TJI@ 110 joist

Member Type: FloorJoist | Level: 1st Floor

Design Passed

Product is Sufficient for Application and Loads Described

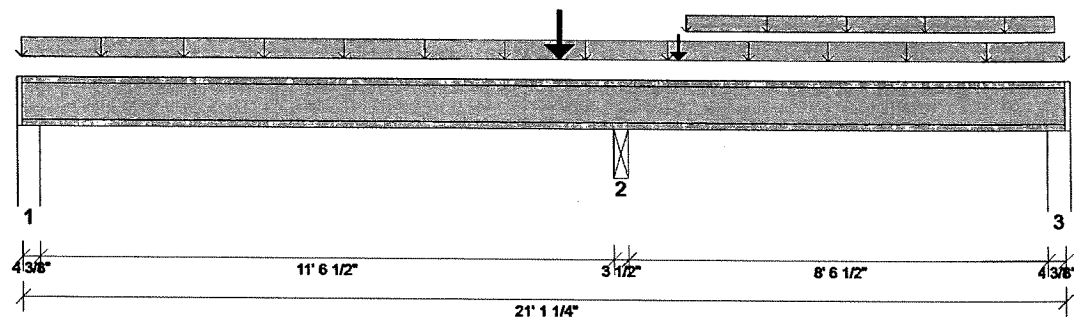

Building Code: IBC 2012 Design Methodology: ASD Member Cut Length: 21' 1 1/4" Member Drawing Not to Scale

Design Results:	Design @ Location	Allowed	Result	LDF	Load Combination -(Load Group)
Critical Reaction	1607 lb @ 12' 0 5/8"	1935 lb (3.5")	Passed - 83%	1.00	1.0 D + 1.0 L - (0)
Shear	841 lb @ 10' 10 1/8"	1560 lb	Passed - 54%	1.00	1.0 D + 1.0 L - (0)
Moment	-1456 lb-ft @ 12' 0 5/8"	3160 lb-ft	Passed - 46%	1.00	1.0 D + 1.0 L - (0)
Live Load Deflection	0.08" @ 5' 10 7/16"	0.29" L/480	Passed - L/999	-	1.0 D + 1.0 L - (0)
Total Load Deflection	0.10" @ 5' 9 7/8"	0.59" L/240	Passed - L/999	-	1.0 D + 1.0 L - (0)
TJ Pro Rating	53	25	Passed		

Decking Material & Attachment: 23/32"x48"x96" Weyerhaeuser Edge Gold Panel (0/24) T&G SF - Glue And Nail

Design Notes:

- * Top Edge Bracing (Lu): Top compression edge must be braced at 5-07-00 o/c based on loads applied, unless detailed otherwise.
- * Bottom Edge Bracing (Lu): Bottom compression edge must be braced at 4-09-00 o/c based on loads applied, unless detailed otherwise.
- * For TJ-Pro™ Rating calculation the controlling span is considered to be supported by beams.
- * Member design (strength) is based on loads shown in loading section. TJ-Pro™ Rating, if shown, is based on 1-07-03 o.c. spacing.

Supports:

Support	Start : End	Req'd Br'g	Source	Maximum Loads to Supports			
				Dead	Floor Live	Roof Live	Snow
1	0" : 4 3/8"	1.75"	F10(i1598)	82 lb	357 / -22 lb	-	-
2	11' 10 7/8" : 12' 2 3/8"	3.5"	M5-2(i3380)	589 lb	1016 lb	-	-
3	20' 8 7/8" : 21' 1 1/4"	1.75"	F8(i1597)	111 lb	275 / -84 lb	-	-

Loads:

Type	Start : End	Combine	Source	Maximum Loads on Member			
				Dead	Floor Live	Roof Live	Snow
Uniform	0" : 21' 1 1/4"	-	FC1 Floor Decking	16 lb/ft	64 lb/ft	-	-
Uniform	13' 4 3/8" : 20' 10"	-	FC1 Floor Decking	16 lb/ft	-	-	-
Point	10' 10 1/8" : -	-	B18(i1576)	205 lb	178 lb	-	-
Point	13' 2 5/8" : -	-	NB7(i1767)	117 lb	-	-	-

Errors, Warnings, & Notes:

- * If sloping roof loads are applied to this member, the roof dead load has been adjusted for slope.
- * The member graphic, dimensions, and locations shown on this report are based on the centerline of the member.



Design Passed

Member Report

Floor Container: FC1 | Label: B22' | Design Tag: i3167

1 piece(s) of 11 7/8" TJI® 110 joist

Member Type: FloorJoist | Level: 1st Floor

Product is Sufficient for Application and Loads Described

- * Analysis and Design has been performed using precision loading from actual modeled conditions. Some loads may have been modified to simplify reporting.
- * The TJ-Pro™ Rating shown above is based on the default decking for the floor container. Special decking (if used) was not used in determination of the TJ-Pro™ Rating.
- * Load Duration Factors: Dead - 0.90, Floor Live - 1.00, Roof Live - 1.25, Snow - 1.15

Weyerhaeuser warrants that the sizing of its products will be in accordance with Weyerhaeuser product design criteria and published design values. Weyerhaeuser expressly disclaims any other warranties related to the software. Refer to current literature for installation details and trademark information available at wy.com/woodproducts. Use of this software is not intended to circumvent the need for a design professional as determined by the authority having jurisdiction. The designer of record, builder or framer is responsible to assure that this calculation is compatible with the overall project. The product application, input design loads, dimensions and support information have been provided by _____ of _____.

Copyright Weyerhaeuser NR Company. All rights reserved.



Member Report

Floor Container: FC1 | Label: B14'-2 | Design Tag: i3152

2 piece(s) of 11 7/8" TJI@ 110 joist

Member Type: Joist As Flush Beam | Level: 1st Floor

Design Passed

Product is Sufficient for Application and Loads Described

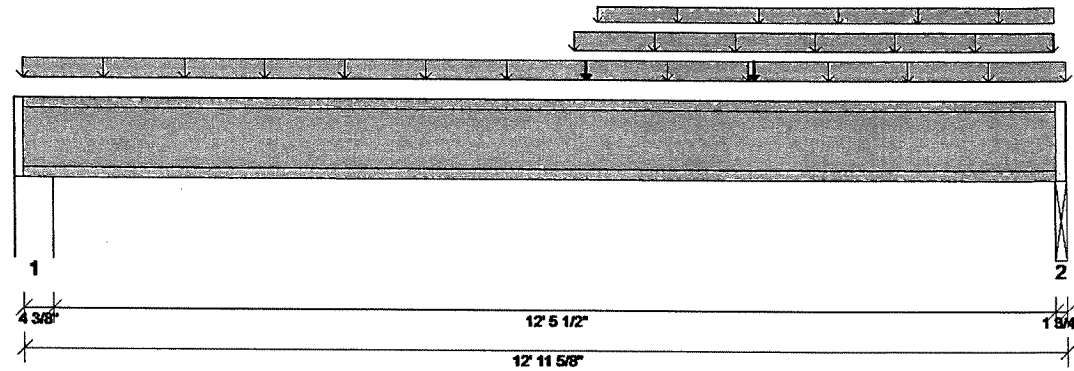

Building Code: IBC 2012 Design Methodology: ASD Member Cut Length: 12' 11 5/8" Member Drawing Not to Scale

Design Results:	Design @ Location	Allowed	Result	LDF	Load Combination - (Load Group)
Critical Reaction	958 lb @ 12' 11 3/8"	1820 lb (1.75")	Passed - 53%	1.00	1.0 D + 1.0 L - (0)
Shear	945 lb @ 12' 9 7/8"	3120 lb	Passed - 30%	1.00	1.0 D + 1.0 L - (0)
Moment	2746 lb-ft @ 7' 4 3/4"	6320 lb-ft	Passed - 43%	1.00	1.0 D + 1.0 L - (0)
Live Load Deflection	0.08" @ 6' 7 1/16"	0.32" L/480	Passed - L/999	-	1.0 D + 1.0 L - (0)
Total Load Deflection	0.17" @ 6' 11 5/8"	0.64" L/240	Passed - L/895	-	1.0 D + 1.0 L - (0)

Design Notes:

- * Top Edge Bracing (Lu): Top compression edge must be braced at 4-10-00 o/c based on loads applied, unless detailed otherwise.
- * Bottom Edge Bracing (Lu): Bottom compression edge must be braced at 13-00-00 o/c based on loads applied, unless detailed otherwise.
- * Member design (strength) is based on loads shown in loading section. T-J-Pro™ Rating, if shown, is based on 1-07-03 o.c. spacing.

Supports:

Support	Start : End	Req'd Br'g	Source	Maximum Loads to Supports			
				Dead	Floor Live	Roof Live	Snow
1	0" : 4 3/8"	1.75"	F1(i1603)	254 lb	427 lb	-	-
2	12' 9 7/8" : 12' 11 5/8"	1.75"	M4-2(i3400)	523 lb	409 lb	-	-

Loads:

Type	Start : End	Combine	Source	Maximum Loads on Member			
				Dead	Floor Live	Roof Live	Snow
Uniform	0" : 12' 11 5/8"	-	FC1 Floor Decking	16 lb/ft	64 lb/ft	-	-
Uniform	6' 9 7/8" : 12' 9 7/8"	-	NB12(i1769)	73 lb/ft	-	-	-
Uniform	7' 1 3/8" : 12' 9 7/8"	-	FC1 Floor Decking	6 lb/ft	-	-	-
Point	6' 11 5/8" :-	-	FC1 Floor Decking	40 lb	-	-	-
Point	9' 0 5/8" :-	-	NB10(i1775)	59 lb	-	-	-

Errors, Warnings, & Notes:

- * This member was designed as a girder member due to load and/or framing conditions. T-J-Pro™ Rating, and other joist member modifiers were not used in the design of this member.
- * If sloping roof loads are applied to this member, the roof dead load has been adjusted for slope.
- * The member graphic, dimensions, and locations shown on this report are based on the centerline of the member.
- * Analysis and Design has been performed using precision loading from actual modeled conditions. Some loads may have been modified to simplify reporting.



Member Report

Floor Container: FC1 | Label: B14'-2 | Design Tag: I3152

2 piece(s) of 11 7/8" TJI® 110 joist

Member Type: Joist As Flush Beam | Level: 1st Floor

Product is Sufficient for Application and Loads Described

Design Passed

* Load Duration Factors: Dead - 0.90, Floor Live - 1.00, Roof Live - 1.25, Snow - 1.15

Weyerhaeuser warrants that the sizing of its products will be in accordance with Weyerhaeuser product design criteria and published design values. Weyerhaeuser expressly disclaims any other warranties related to the software. Refer to current literature for installation details and trademark information available at wy.com/woodproducts. Use of this software is not intended to circumvent the need for a design professional as determined by the authority having jurisdiction. The designer of record, builder or framer is responsible to assure that this calculation is compatible with the overall project. The product application, input design loads, dimensions and support information have been provided by _____ of _____.

Copyright Weyerhaeuser NR Company. All rights reserved.



Design Passed

Member Report

Label: M8-2 | Design Tag: i3113
2 piece(s) of 1 3/4" x 9 1/4" 2.0E Microllam® LVL
Member Type: Beam | Level: 1st Floor

Product is Sufficient for Application and Loads Described

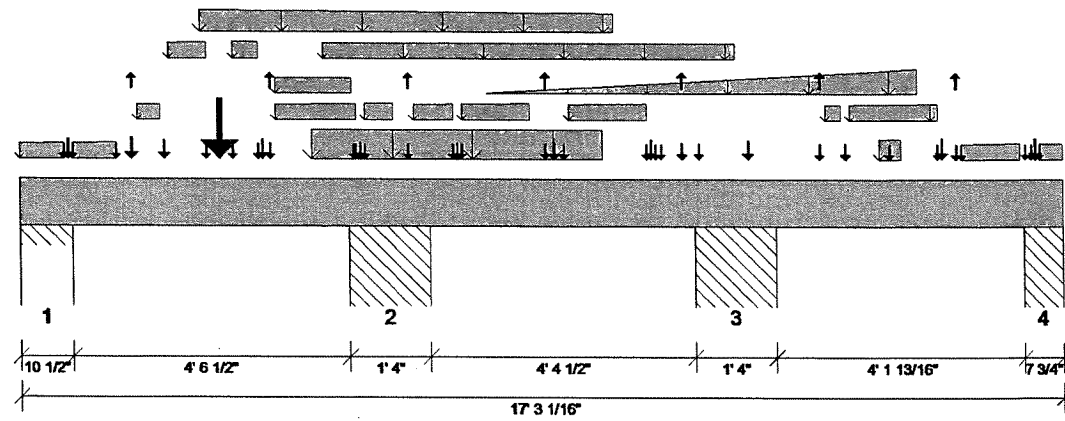

Building Code: IBC 2012 Design Methodology: ASD Member Cut Length: 17' 4 13/16" Member Drawing Not to Scale

Design Results:	Design @ Location	Allowed	Result	LDF	Load Combination - (Load Group)
Critical Reaction	5758 lb @ 5' 6 1/2"	28219 lb (10.75")	Passed - 20%	-	1.0 D + 1.0 L - (1)
Shear	3645 lb @ 4' 7 3/4"	6151 lb	Passed - 59%	1.00	1.0 D + 1.0 L - (1)
Moment	4636 lb-ft @ 3' 3 3/4"	11204 lb-ft	Passed - 41%	1.00	1.0 D + 1.0 L - (1)
Live Load Deflection	0.03" @ 3' 3 3/4"	0.16" L/360	Passed - L/999	-	1.0 D + 0.75 L + 0.75 S - (1)
Total Load Deflection	0.06" @ 3' 3 3/4"	0.24" L/240	Passed - L/996	-	1.0 D + 0.75 L + 0.75 S - (1)

Vertical Load Capacity Check Passed

Design Notes:

- * Top Edge Bracing (Lu): Top compression edge must be braced at 17-03-00 o/c based on loads applied, unless detailed otherwise.
- * Bottom Edge Bracing (Lu): Bottom compression edge must be braced at 17-03-00 o/c based on loads applied, unless detailed otherwise.

Supports:

Support	Start : End	Req'd Br'g	Source	Maximum Loads to Supports			
				Dead	Floor Live	Roof Live	Snow
1	0" : 10 1/2"	-	-	1467 lb	1549 lb	-	492 lb
++>	1 1/4" : -	1.5"	F7(i1599)	349 lb	369 lb	-	117 lb
++>	6 1/2" : -	-	PBO39(i1641)	1118 lb	1180 lb	-	375 lb
2	5' 5" : 6' 9"	-	PBO20(i1618)	2813 lb	4794 / -244 lb	-	874 lb
==>	5' 6 1/2" : -	2.19"	PBO20(i1618)	2813 lb	3198 / -74 lb	-	874 lb
==>	6' 7 1/2" : -	1.5"	PBO20(i1618)	-	1596 / -170 lb	-	-
3	11' 1 1/2" : 12' 5 1/2"	-	PBO21(i1619)	561 lb	2228 / -101 lb	-	-135 lb
==>	11' 3" : -	1.5"	PBO21(i1619)	-	1319 lb	-	-
==>	12' 4" : -	1.5"	PBO21(i1619)	561 lb	909 / -101 lb	-	-135 lb
4	16' 7 5/16" : 17' 3 1/16"	-	-	375 lb	927 / -29 lb	-	36 lb
++>	16' 9 7/16" : -	1.5"	PBO22(i1620)	205 lb	506 / -16 lb	-	20 lb
++>	16' 11 9/16" : -	-	PBO19(i1616)	42 lb	104 / -3 lb	-	4 lb
++>	17' 1 3/4" : -	-	F12(i1600)	128 lb	317 / -10 lb	-	12 lb

Loads:

Type	Start : End	Combine	Source	Maximum Loads on Member			
				Dead	Floor Live	Roof Live	Snow
Self Weight	0" : 17' 3 1/16"	-	Self Weight	9 lb/ft	-	-	-
Uniform	4' 9 11/16" : 9' 7"	-	Smoothed Load	-	280 lb/ft	-	-
Uniform	5' 0" : 11' 9 1/2"	-	Smoothed Load	-	2 lb/ft	-	-
Uniform	14' 2" : 14' 6 3/16"	-	BBk1(i3338)	103 lb/ft	-	-	-
Tapered	0" : 8 13/16"	-	BBk1(i3338)	1 To 3 lb/ft	5 To 12 lb/ft	-	-
Tapered	10 9/16" : 1' 7 5/16"	-	BBk1(i3338)	3 To 5 lb/ft	14 To 21 lb/ft	-	-
Tapered	1' 11 1/2" : 2' 4"	-	BBk1(i3338)	0 To 1 lb/ft	2 To 6 lb/ft	-	-

Member Report

Label: M8-2 | Design Tag: i3113

2 piece(s) of 1 3/4" x 9 1/4" 2.0E Microllam® LVL

Member Type: Beam | Level: 1st Floor

Design Passed

Product is Sufficient for Application and Loads Described

Tapered	2' 5 3/4" : 3' 1 1/8"	-	BBk1(i3338)	2 To 3 lb/ft	7 To 13 lb/ft	-	-
Tapered	3' 0" : 9' 9 1/2"	-	Smoothed Load	-	122 To 64 lb/ft	-	-
Tapered	3' 6 3/8" : 3' 11 1/4"	-	BBk1(i3338)	6 To 13 lb/ft	18 To 22 lb/ft	-	-
Tapered	4' 2 11/16" : 5' 6"	-	BBk1(i3338)	0 To 4 lb/ft	2 To 15 lb/ft	-	-
Tapered	4' 2 11/16" : 5' 5 1/2"	-	BBk1(i3338)	1 To 7 lb/ft	-	-	-
Tapered	5' 8 3/16" : 6' 1 9/16"	-	BBk1(i3338)	9 To 7 lb/ft	16 To 21 lb/ft	-	-
Tapered	6' 5 13/16" : 7' 1 5/8"	-	BBk1(i3338)	0 To 2 lb/ft	2 To 8 lb/ft	-	-
Tapered	7' 3 3/8" : 8' 4 3/4"	-	BBk1(i3338)	2 To 5 lb/ft	10 To 21 lb/ft	-	-
Tapered	7' 8 3/8" : 14' 9 1/2"	-	Smoothed Load	-	0 To 190 lb/ft	-	-
Tapered	9' 0 9/16" : 10' 4"	-	BBk1(i3338)	1 To 4 lb/ft	5 To 18 lb/ft	-	-
Tapered	13' 3 1/4" : 13' 6"	-	BBk1(i3338)	0 To 1 lb/ft	2 To 4 lb/ft	-	-
Tapered	13' 8 3/16" : 15' 1"	-	BBk1(i3338)	2 To 5 lb/ft	6 To 20 lb/ft	-	-
Tapered	15' 6 7/16" : 16' 6"	-	BBk1(i3338)	1 To 6 lb/ft	4 To 23 lb/ft	-	-
Tapered	16' 10 9/16" : 17' 3"	-	BBk1(i3338)	4 To 2 lb/ft	16 To 9 lb/ft	-	-
Point	8' 13/16" : -	-	BBk1(i3338)	-	1 lb	-	-
Point	9' 11/16" : -	-	B16(i3196)	102 lb	410 lb	-	-
Point	10' 9/16" : -	-	BBk1(i3338)	-	1 lb	-	-
Point	1' 7 5/16" : -	-	BBk1(i3338)	1 lb	4 lb	-	-
Point	1' 10 7/16" : -	-	B24(i3176)	359 lb	362 / -32 lb	-	31 lb
Point	2' 4 7/8" : -	-	B16(i3195)	88 lb	351 lb	-	-
Point	3' 1 1/8" : -	-	BBk1(i3338)	1 lb	3 lb	-	-
Point	3' 3 3/4" : -	-	M2-3(i3405)	2585 lb	1203 lb	-	1235 lb
Point	3' 6 3/8" : -	-	BBk1(i3338)	1 lb	4 lb	-	-
Point	3' 11 1/4" : -	-	BBk1(i3338)	-	2 lb	-	-
Point	4' 0 1/8" : -	-	B16(i3194)	210 lb	320 lb	-	-
Point	4' 1 5/8" : -	-	B24(i3177)	83 lb	-63 lb	-	-
Point	5' 5 15/16" : -	-	BBk1(i3338)	1 lb	-	-	-
Point	5' 6 7/16" : -	-	BBk1(i3338)	-	1 lb	-	-
Point	5' 7 5/16" : -	-	B16(i3306)	188 lb	-	-	-
Point	5' 8 3/16" : -	-	BBk1(i3338)	1 lb	1 lb	-	-
Point	6' 4 3/4" : -	-	B22(i3330)	45 lb	-83 lb	-	-
Point	7' 1 5/8" : -	-	BBk1(i3338)	-	1 lb	-	-
Point	7' 2 1/2" : -	-	B16(i3192)	112 lb	-	-	-
Point	7' 3 3/8" : -	-	BBk1(i3338)	-	1 lb	-	-
Point	8' 7 7/8" : -	-	B20(i3179)	69 lb	-114 lb	-	-
Point	8' 9 11/16" : -	-	B16(i3191)	154 lb	-	-	-
Point	8' 11 9/16" : -	-	BBk1(i3338)	-	1 lb	-	-
Point	10' 4" : -	-	BBk1(i3338)	-	1 lb	-	-
Point	10' 4 7/8" : -	-	B16(i3190)	178 lb	335 lb	-	-
Point	10' 5 3/4" : -	-	BBk1(i3338)	-	1 lb	-	-
Point	10' 6 13/16" : -	-	BBk1(i3338)	1 lb	4 lb	-	-
Point	10' 11 1/16" : -	-	B18(i3382)	47 lb	144 / -167 lb	-	-
Point	11' 2 3/8" : -	-	B16(i3206)	121 lb	-	-	-
Point	12' 0 1/8" : -	-	B16(i3189)	126 lb	337 lb	-	-
Point	13' 2 3/16" : -	-	B16(i3181)	12 lb	80 / -199 lb	-	-
Point	13' 7 5/16" : -	-	B16(i3337)	112 lb	-	-	-
Point	14' 4 1/16" : -	-	BBk1(i3338)	47 lb	-	-	-
Point	15' 1 5/8" : -	-	BBk1(i3338)	-	1 lb	-	-
Point	15' 2 1/2" : -	-	B16(i3187)	260 lb	445 lb	-	-
Point	15' 5 5/16" : -	-	B16(i3321)	-158 lb	41 lb	-	-
Point	15' 6 7/16" : -	-	BBk1(i3338)	-	1 lb	-	-
Point	16' 7 9/16" : -	-	BBk1(i3338)	1 lb	4 lb	-	-
Point	16' 8 13/16" : -	-	BBk1(i3338)	-	1 lb	-	-
Point	16' 9 11/16" : -	-	B16(i3304)	230 lb	447 lb	-	-
Point	16' 10 9/16" : -	-	BBk1(i3338)	-	1 lb	-	-

Errors, Warnings, & Notes:

File Name: SR-285597
DAY/ MURRAY PLAN
REVISION DATE
REVISION COMMENTS

Javelin® Software 6.4.1.3

Design Engine: V8.0.0.21

Data: V7.3.2.0

8/25/2020 9:38:48 AM

Page 2 of 3



Member Report

Label: M8-2 | Design Tag: i3113

2 piece(s) of 1 3/4" x 9 1/4" 2.0E Microllam® LVL

Member Type: Beam | Level: 1st Floor

Product is Sufficient for Application and Loads Described

Design Passed

- * If sloping roof loads are applied to this member, the roof dead load has been adjusted for slope.
- * The member graphic, dimensions, and locations shown on this report are based on the centerline of the member.
- * Analysis and Design has been performed using precision loading from actual modeled conditions. Some loads may have been modified to simplify reporting.
- * Load Duration Factors: Dead - 0.90, Floor Live - 1.00, Roof Live - 1.25, Snow - 1.15

Weyerhaeuser warrants that the sizing of its products will be in accordance with Weyerhaeuser product design criteria and published design values. Weyerhaeuser expressly disclaims any other warranties related to the software. Refer to current literature for installation details and trademark information available at wy.com/woodproducts. Use of this software is not intended to circumvent the need for a design professional as determined by the authority having jurisdiction. The designer of record, builder or framer is responsible to assure that this calculation is compatible with the overall project. The product application, input design loads, dimensions and support information have been provided by _____ of _____.

Copyright Weyerhaeuser NR Company. All rights reserved.



Design Passed

Member Report

Label: M3-2 | Design Tag: i3038

2 piece(s) of 1 3/4" x 11 7/8" 2.0E Microllam® LVL

Member Type: Beam | Level: 1st Floor

Product is Sufficient for Application and Loads Described

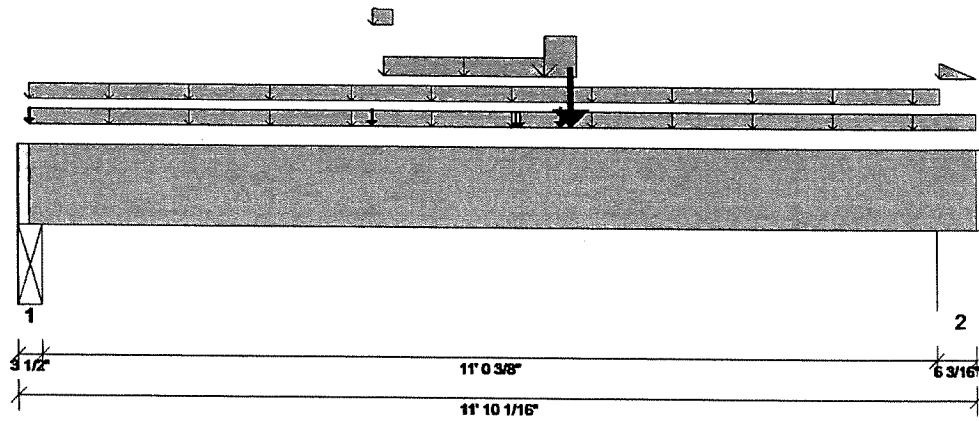

Building Code: IBC 2012 Design Methodology: ASD Member Cut Length: 11' 11 13/16" Member Drawing Not to Scale

Design Results:	Design @ Location	Allowed	Result	LDf	Load Combination - (Load Group)
Critical Reaction	2379 lb @ 2"	9188 lb (3.5")	Passed - 26%	-	1.0 D + 0.75 L + 0.75 S - (0)
Shear	2904 lb @ 10' 4"	9081 lb	Passed - 32%	1.15	1.0 D + 0.75 L + 0.75 S - (0)
Moment	13213 lb-ft @ 6' 9 3/4"	20525 lb-ft	Passed - 64%	1.15	1.0 D + 0.75 L + 0.75 S - (0)
Live Load Deflection	0.13" @ 6' 1 9/16"	0.38" L/360	Passed - L/999	-	1.0 D + 0.75 L + 0.75 S - (0)
Total Load Deflection	0.29" @ 6' 1 9/16"	0.56" L/240	Passed - L/464	-	1.0 D + 0.75 L + 0.75 S - (0)

Design Notes:

- * Top Edge Bracing (Lu): Top compression edge must be braced at 10-04-00 o/c based on loads applied, unless detailed otherwise.
- * Bottom Edge Bracing (Lu): Bottom compression edge must be braced at 11-10-00 o/c based on loads applied, unless detailed otherwise.

Supports:

Support	Start : End	Req'd Br'g	Source	Maximum Loads to Supports			
				Dead	Floor Live	Roof Live	Snow
1	0" : 3 1/2"	1.5"	M5-2(i3380)	1330 lb	496 lb	-	946 lb
2	11' 3 7/8" : 11' 10 1/16"	1.5"	F7(i1599)	1600 lb	530 lb	-	1328 lb

Loads:

Type	Start : End	Combine	Source	Maximum Loads on Member			
				Dead	Floor Live	Roof Live	Snow
Self Weight	0" : 11' 10 1/16"	-	Self Weight	11 lb/ft	-	-	-
Uniform	1 3/4" : 11' 10 1/16"	-	FC1 Floor Decking	5 lb/ft	20 lb/ft	-	-
Uniform	1 3/4" : 11' 4 7/16"	-	FC1 Floor Decking	3 lb/ft	12 lb/ft	-	-
Uniform	4' 6" : 6' 5 7/8"	-	B22(i1571)	149 lb/ft	-	-	-
Uniform	6' 5 7/8" : 6' 10 5/8"	-	B21(i1559)	502 lb/ft	63 lb/ft	-	487 lb/ft
Tapered	4' 4 7/16" : 4' 7 7/16"	-	FC1 Floor Decking	45 To 20 lb/ft	-	-	-
Tapered	11' 4 7/16" : 11' 10"	-	FC1 Floor Decking	3 To 0 lb/ft	12 To 0 lb/ft	-	-
Point	1 3/4" : -	-	B27(i1574)	46 lb	49 lb	-	-
Point	4' 4 1/4" : -	-	B20(i1575)	141 lb	80 lb	-	-
Point	4' 4 1/4" : -	-	FC1 Floor Decking	1 lb	-	-	-
Point	6' 1 9/16" : -	-	B24(i1561)	26 lb	-	-	-
Point	6' 2 3/16" : -	-	B24(i1561)	38 lb	-	-	-
Point	6' 8 1/4" : -	-	B21(i1559)	237 lb	31 lb	-	225 lb
Point	6' 9 3/4" : -	-	B21(i1559)	1711 lb	466 lb	-	1857 lb



Member Report

Label: M3-2 | Design Tag: i3038

Design Passed

2 piece(s) of 1 3/4" x 11 7/8" 2.0E Microllam® LVL

Member Type: Beam | Level: 1st Floor

Product is Sufficient for Application and Loads Described

Errors, Warnings, & Notes:

- * If sloping roof loads are applied to this member, the roof dead load has been adjusted for slope.
- * The member graphic, dimensions, and locations shown on this report are based on the centerline of the member.
- * Analysis and Design has been performed using precision loading from actual modeled conditions. Some loads may have been modified to simplify reporting.
- * Load Duration Factors: Dead - 0.90, Floor Live - 1.00, Roof Live - 1.25, Snow - 1.15

Weyerhaeuser warrants that the sizing of its products will be in accordance with Weyerhaeuser product design criteria and published design values. Weyerhaeuser expressly disclaims any other warranties related to the software. Refer to current literature for installation details and trademark information available at wy.com/woodproducts. Use of this software is not intended to circumvent the need for a design professional as determined by the authority having jurisdiction. The designer of record, builder or framer is responsible to assure that this calculation is compatible with the overall project. The product application, input design loads, dimensions and support information have been provided by _____ of _____.

Copyright Weyerhaeuser NR Company. All rights reserved.



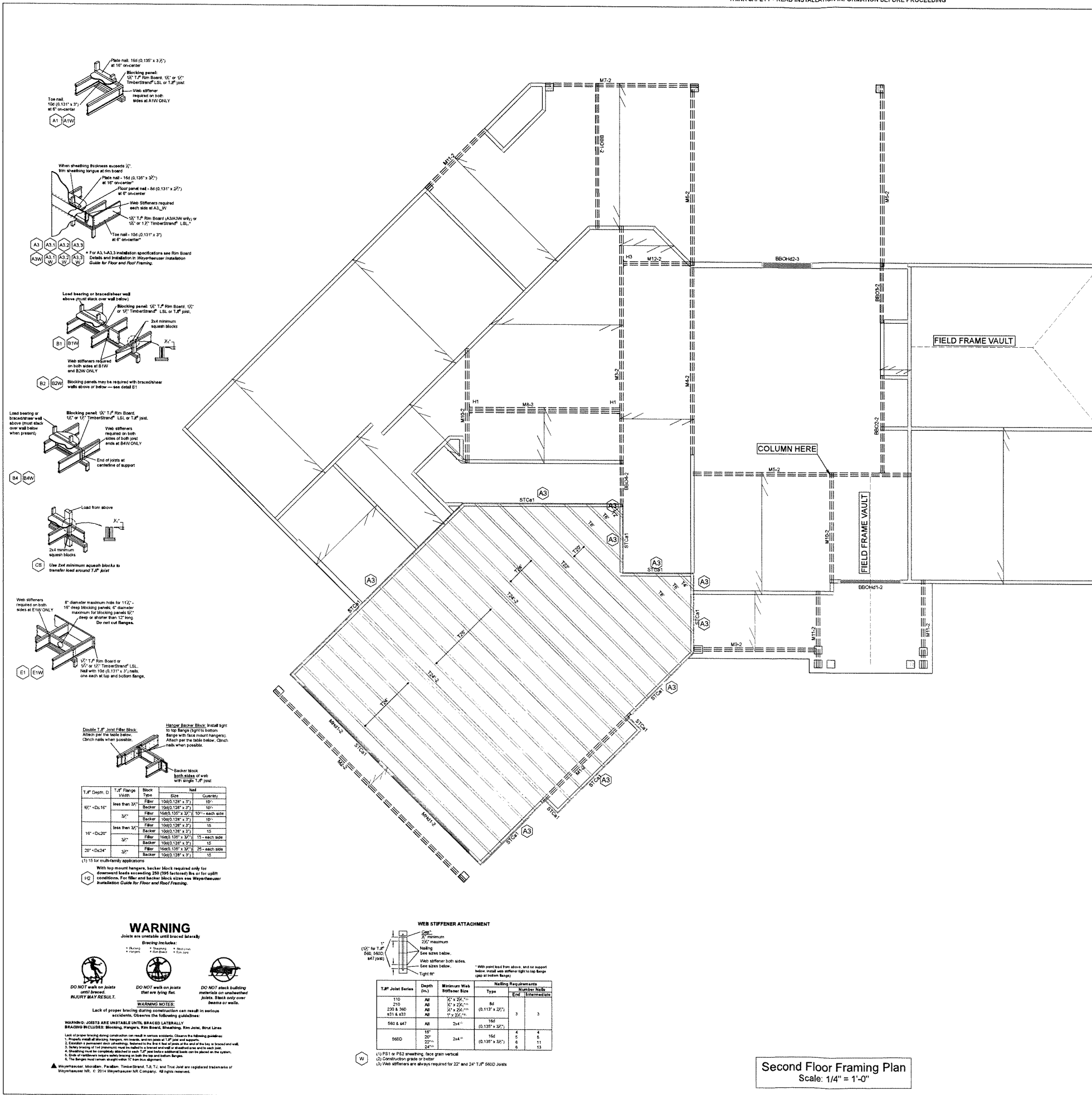

ProdID	Qty	Manuf	Product	Backer Bks	Web Stiff
H1	2	Simpson	HQJUS3010	No	No
H3	1	Simpson	HJ410	No	No

ProdID	Length	Product	Pieces	Net Qty
T26	20'-0"	16" TJI 360 joist	1	6
T24-2	24'-0"	16" TJI 360 joist	2	4
T24	24'-0"	16" TJI 360 joist	1	6
T22	22'-0"	16" TJI 360 joist	1	1
T20	20'-0"	16" TJI 360 joist	1	2
T8	8'-0"	16" TJI 360 joist	1	2
T6	6'-0"	16" TJI 360 joist	1	2
T4	4'-0"	16" TJI 360 joist	1	1
T2	2'-0"	16" TJI 360 joist	1	1
M1-2	12'-0"	1 3/4" x 16" 2.0E Microlam LVL	2	2
M2-2	24'-0"	1 3/4" x 16" 2.0E Microlam LVL	2	2
M3-2	22'-0"	1 3/4" x 16" 2.0E Microlam LVL	2	2
M4-2	18'-0"	1 3/4" x 16" 2.0E Microlam LVL	2	2
M5-2	20'-0"	1 3/4" x 16" 2.0E Microlam LVL	2	2
M6-2	16'-0"	1 3/4" x 16" 2.0E Microlam LVL	2	4
M8-3	14'-0"	1 3/4" x 16" 2.0E Microlam LVL	3	3
M7-2	14'-0"	1 3/4" x 16" 2.0E Microlam LVL	2	2
M9-2	12'-0"	1 3/4" x 16" 2.0E Microlam LVL	2	2
M10-2	10'-0"	1 3/4" x 16" 2.0E Microlam LVL	2	4
M11-2	8'-0"	1 3/4" x 16" 2.0E Microlam LVL	2	6
M12-2	6'-0"	1 3/4" x 16" 2.0E Microlam LVL	2	2
STCcat	16'-0"	1 1/8" x 16" TJI Rim Board	1	7

ProdID	Length	Product	Pieces	Net Qty
MH9-2	12'-0"	1 3/4" x 11 7/8" 2.0E Microlam LVL	2	4

ProdID	Length	Product	Pieces	Net Qty
		23/32" x 48" x 96" Weyerhaeuser Edge Gold Panel (D24) T&G SF	1	21

Length	Product
546'-0"	16" TJI 360 joist
24'-0"	1 3/4" x 16" 2.0E Microlam LVL
128'-0"	1 3/4" x 16" 2.0E Microlam LVL
48'-0"	1 3/4" x 11 7/8" 2.0E Microlam LVL
298'-0"	1 3/4" x 9 1/4" 2.0E Microlam LVL
112'-0"	1 1/8" x 16" TJI Rim Board

Current Date	8/25/2020
File Name	SR-285597.rvt
Level Name	2nd Floor
Building Code - Design Methodology	IBC 2012
Members with Design Overrides	48
TJI Pro Rating (Weighted Average)	48
Minimum Level TJI - Pro Rating & Joist	TJI-Pro rating = 48 (joist = T24)(3340)
Maximum Level TJI - Pro Rating & Joist	TJI-Pro rating = 73 (joist = T8)(3359)
FLOOR	
Floor Container	FC2
Use/Occupancy	Residential, livingAreas
Floor Area Loading is	20.0 kN/m² Live Load & 10.0 kN/m² Dead Load
Maximum Allowed Deflection	L/480 Live Load & L/240 Total Load
TJI Pro Rating Information	
Weighted Average	48
Directly Applied Ceiling	Gypsum 1/2"
Decking Attachment	Glue and Nail
Decking Material	23/32" x 48" x 96" Weyerhaeuser Edge Gold Panel (D24) T&G SF
Perpendicular Partition	No
Strapping at max 8' o.c.	None
Blocking at max 8' o.c.	No
Poured Flooring	No

An additional 20 psf LL has been added to account for code minimum requirements in living areas.

○	Bearing Length Requirement
—	Line Load
●	Point Load
□	Area Load
ESD	Member By Others
ESB	Closure By Others
ULA	Under Load Above
○	Toilet/Shower Plumbing Drop
○	Plumbing Drop
○	Walls Above
○	Detail Callout Label

- GENERAL NOTES:**
- Joists may be shifted up to 3" from on center spacing to avoid rafter interference, flush beams and/or plumbing drops. **DO NOT CUT JOIST FLANGES.**
 - All EWP beams have been designed assuming full width support of the members/plies, unless noted otherwise.
 - This drawing may contain deviations from the original project documents. It is the responsibility of the contractor to notify the project Design Professional of these deviations to verify conformance with the original design intent of the project.
 - This layout is intended for the use of TrueJoist engineered wood products only. The substitution of other wood products with this layout is NOT PERMITTED. Please identify the TJI, TimberStrand® LSL, Microlam® LVL and Parallam® PSL stamps on the product to ensure that this layout is valid for the products actually installed.
 - Only header openings and roof loads which affect Weyerhaeuser product sizes have been denoted on this layout. In addition to and 'CS' detail callouts shown, solid blocking and/or squash blocks are required to provide vertical load transfer from all concentrated load locations to foundation below. See Pocket Framers Guide for appropriate detail(s).

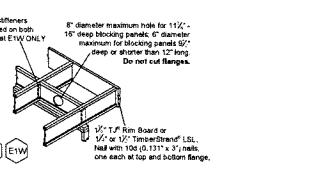
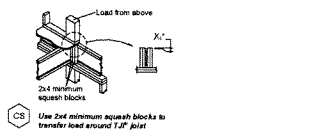
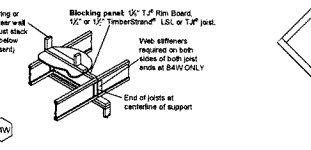
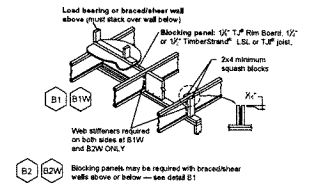
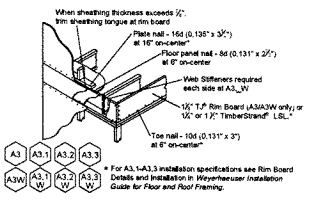
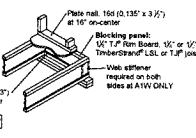

TJI Depth (D)	TJI Flange Width	Block Type	Block Size	Qty																																		
6\"/> <tr><td>Backer</td><td>10x6x12</td><td>10"</td><td>10"</td></tr> <tr><td>Fiber</td><td>10x6x12</td><td>10"</td><td>10"</td></tr> <tr><td>Backer</td><td>10x6x12</td><td>10"</td><td>10"</td></tr> <tr> <td rowspan="3">10\"/> <tr><td>Backer</td><td>10x6x12</td><td>10"</td><td>10"</td></tr> <tr><td>Fiber</td><td>10x6x12</td><td>10"</td><td>10"</td></tr> <tr><td>Backer</td><td>10x6x12</td><td>10"</td><td>10"</td></tr> <tr> <td rowspan="3">20\"/> <tr><td>Backer</td><td>10x6x12</td><td>10"</td><td>10"</td></tr> <tr><td>Fiber</td><td>10x6x12</td><td>10"</td><td>10"</td></tr> <tr><td>Backer</td><td>10x6x12</td><td>10"</td><td>10"</td></tr> </td></tr></td></tr>	Backer	10x6x12	10"	10"	Fiber	10x6x12	10"	10"	Backer	10x6x12	10"	10"	10\"/> <tr><td>Backer</td><td>10x6x12</td><td>10"</td><td>10"</td></tr> <tr><td>Fiber</td><td>10x6x12</td><td>10"</td><td>10"</td></tr> <tr><td>Backer</td><td>10x6x12</td><td>10"</td><td>10"</td></tr> <tr> <td rowspan="3">20\"/> <tr><td>Backer</td><td>10x6x12</td><td>10"</td><td>10"</td></tr> <tr><td>Fiber</td><td>10x6x12</td><td>10"</td><td>10"</td></tr> <tr><td>Backer</td><td>10x6x12</td><td>10"</td><td>10"</td></tr> </td></tr>	Backer	10x6x12	10"	10"	Fiber	10x6x12	10"	10"	Backer	10x6x12	10"	10"	20\"/> <tr><td>Backer</td><td>10x6x12</td><td>10"</td><td>10"</td></tr> <tr><td>Fiber</td><td>10x6x12</td><td>10"</td><td>10"</td></tr> <tr><td>Backer</td><td>10x6x12</td><td>10"</td><td>10"</td></tr>	Backer	10x6x12	10"	10"	Fiber	10x6x12	10"	10"	Backer	10x6x12	10"	10"
	Backer	10x6x12	10"	10"																																		
	Fiber	10x6x12	10"	10"																																		
Backer	10x6x12	10"	10"																																			
10\"/> <tr><td>Backer</td><td>10x6x12</td><td>10"</td><td>10"</td></tr> <tr><td>Fiber</td><td>10x6x12</td><td>10"</td><td>10"</td></tr> <tr><td>Backer</td><td>10x6x12</td><td>10"</td><td>10"</td></tr> <tr> <td rowspan="3">20\"/> <tr><td>Backer</td><td>10x6x12</td><td>10"</td><td>10"</td></tr> <tr><td>Fiber</td><td>10x6x12</td><td>10"</td><td>10"</td></tr> <tr><td>Backer</td><td>10x6x12</td><td>10"</td><td>10"</td></tr> </td></tr>	Backer	10x6x12	10"	10"	Fiber	10x6x12	10"	10"	Backer	10x6x12	10"	10"	20\"/> <tr><td>Backer</td><td>10x6x12</td><td>10"</td><td>10"</td></tr> <tr><td>Fiber</td><td>10x6x12</td><td>10"</td><td>10"</td></tr> <tr><td>Backer</td><td>10x6x12</td><td>10"</td><td>10"</td></tr>	Backer	10x6x12	10"	10"	Fiber	10x6x12	10"	10"	Backer	10x6x12	10"	10"													
	Backer	10x6x12	10"	10"																																		
	Fiber	10x6x12	10"	10"																																		
Backer	10x6x12	10"	10"																																			
20\"/> <tr><td>Backer</td><td>10x6x12</td><td>10"</td><td>10"</td></tr> <tr><td>Fiber</td><td>10x6x12</td><td>10"</td><td>10"</td></tr> <tr><td>Backer</td><td>10x6x12</td><td>10"</td><td>10"</td></tr>	Backer	10x6x12	10"	10"	Fiber	10x6x12	10"	10"	Backer	10x6x12	10"	10"																										
	Backer	10x6x12	10"	10"																																		
	Fiber	10x6x12	10"	10"																																		
Backer	10x6x12	10"	10"																																			

(1) 10 for multi-family applications
 With top mounted hangers, backer block required only for downward loads exceeding 250 (255 factored) lbs or for uplift conditions. For fiber and backer block sizes see Weyerhaeuser Installation Guide for Floor and Roof Framing.

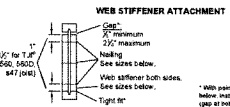

Depth (in.)	Minimum Web Stiffener Size	Minimum Spacing (in.)	Maximum Spacing (in.)
110	2x4	24"	24"
210	2x4	24"	24"
230 & 360	2x4	24"	24"
414 & 433	2x4	24"	24"
560 & 647	2x4	24"	24"

WARNING
 Joists are unstable until braced laterally.
 Lack of proper bracing during construction can result in serious accidents. Observe the following guidelines:
 1. Properly install all blocking, hangers, joists, and joists at 12" joist and supports.
 2. Establish a permanent bracing system. Members to be braced are those to be braced and will.
 3. Safety bracing of all members must be installed in a braced area or braced area and not over.
 4. Bracing must be installed within 12" of the top and bottom flanges.
 5. All bracing must be installed within 12" of the top and bottom flanges.
 6. The bracing must extend through the full length of the joist.
 7. The bracing must be installed within 12" of the top and bottom flanges.
 8. The bracing must be installed within 12" of the top and bottom flanges.
 9. The bracing must be installed within 12" of the top and bottom flanges.
 10. The bracing must be installed within 12" of the top and bottom flanges.
 11. The bracing must be installed within 12" of the top and bottom flanges.
 12. The bracing must be installed within 12" of the top and bottom flanges.
 13. The bracing must be installed within 12" of the top and bottom flanges.
 14. The bracing must be installed within 12" of the top and bottom flanges.
 15. The bracing must be installed within 12" of the top and bottom flanges.
 16. The bracing must be installed within 12" of the top and bottom flanges.
 17. The bracing must be installed within 12" of the top and bottom flanges.
 18. The bracing must be installed within 12" of the top and bottom flanges.
 19. The bracing must be installed within 12" of the top and bottom flanges.
 20. The bracing must be installed within 12" of the top and bottom flanges.
 21. The bracing must be installed within 12" of the top and bottom flanges.
 22. The bracing must be installed within 12" of the top and bottom flanges.
 23. The bracing must be installed within 12" of the top and bottom flanges.
 24. The bracing must be installed within 12" of the top and bottom flanges.
 25. The bracing must be installed within 12" of the top and bottom flanges.
 26. The bracing must be installed within 12" of the top and bottom flanges.
 27. The bracing must be installed within 12" of the top and bottom flanges.
 28. The bracing must be installed within 12" of the top and bottom flanges.
 29. The bracing must be installed within 12" of the top and bottom flanges.
 30. The bracing must be installed within 12" of the top and bottom flanges.
 31. The bracing must be installed within 12" of the top and bottom flanges.
 32. The bracing must be installed within 12" of the top and bottom flanges.
 33. The bracing must be installed within 12" of the top and bottom flanges.
 34. The bracing must be installed within 12" of the top and bottom flanges.
 35. The bracing must be installed within 12" of the top and bottom flanges.
 36. The bracing must be installed within 12" of the top and bottom flanges.
 37. The bracing must be installed within 12" of the top and bottom flanges.
 38. The bracing must be installed within 12" of the top and bottom flanges.
 39. The bracing must be installed within 12" of the top and bottom flanges.
 40. The bracing must be installed within 12" of the top and bottom flanges.
 41. The bracing must be installed within 12" of the top and bottom flanges.
 42. The bracing must be installed within 12" of the top and bottom flanges.
 43. The bracing must be installed within 12" of the top and bottom flanges.
 44. The bracing must be installed within 12" of the top and bottom flanges.
 45. The bracing must be installed within 12" of the top and bottom flanges.
 46. The bracing must be installed within 12" of the top and bottom flanges.
 47. The bracing must be installed within 12" of the top and bottom flanges.
 48. The bracing must be installed within 12" of the top and bottom flanges.
 49. The bracing must be installed within 12" of the top and bottom flanges.
 50. The bracing must be installed within 12" of the top and bottom flanges.
 51. The bracing must be installed within 12" of the top and bottom flanges.
 52. The bracing must be installed within 12" of the top and bottom flanges.
 53. The bracing must be installed within 12" of the top and bottom flanges.
 54. The bracing must be installed within 12" of the top and bottom flanges.
 55. The bracing must be installed within 12" of the top and bottom flanges.
 56. The bracing must be installed within 12" of the top and bottom flanges.
 57. The bracing must be installed within 12" of the top and bottom flanges.
 58. The bracing must be installed within 12" of the top and bottom flanges.
 59. The bracing must be installed within 12" of the top and bottom flanges.
 60. The bracing must be installed within 12" of the top and bottom flanges.
 61. The bracing must be installed within 12" of the top and bottom flanges.
 62. The bracing must be installed within 12" of the top and bottom flanges.
 63. The bracing must be installed within 12" of the top and bottom flanges.
 64. The bracing must be installed within 12" of the top and bottom flanges.
 65. The bracing must be installed within 12" of the top and bottom flanges.
 66. The bracing must be installed within 12" of the top and bottom flanges.
 67. The bracing must be installed within 12" of the top and bottom flanges.
 68. The bracing must be installed within 12" of the top and bottom flanges.
 69. The bracing must be installed within 12" of the top and bottom flanges.
 70. The bracing must be installed within 12" of the top and bottom flanges.
 71. The bracing must be installed within 12" of the top and bottom flanges.
 72. The bracing must be installed within 12" of the top and bottom flanges.
 73. The bracing must be installed within 12" of the top and bottom flanges.
 74. The bracing must be installed within 12" of the top and bottom flanges.
 75. The bracing must be installed within 12" of the top and bottom flanges.
 76. The bracing must be installed within 12" of the top and bottom flanges.
 77. The bracing must be installed within 12" of the top and bottom flanges.
 78. The bracing must be installed within 12" of the top and bottom flanges.
 79. The bracing must be installed within 12" of the top and bottom flanges.
 80. The bracing must be installed within 12" of the top and bottom flanges.
 81. The bracing must be installed within 12" of the top and bottom flanges.
 82. The bracing must be installed within 12" of the top and bottom flanges.
 83. The bracing must be installed within 12" of the top and bottom flanges.
 84. The bracing must be installed within 12" of the top and bottom flanges.
 85. The bracing must be installed within 12" of the top and bottom flanges.
 86. The bracing must be installed within 12" of the top and bottom flanges.
 87. The bracing must be installed within 12" of the top and bottom flanges.
 88. The bracing must be installed within 12" of the top and bottom flanges.
 89. The bracing must be installed within 12" of the top and bottom flanges.
 90. The bracing must be installed within 12" of the top and bottom flanges.
 91. The bracing must be installed within 12" of the top and bottom flanges.
 92. The bracing must be installed within 12" of the top and bottom flanges.
 93. The bracing must be installed within 12" of the top and bottom flanges.
 94. The bracing must be installed within 12" of the top and bottom flanges.
 95. The bracing must be installed within 12" of the top and bottom flanges.
 96. The bracing must be installed within 12" of the top and bottom flanges.
 97. The bracing must be installed within 12" of the top and bottom flanges.
 98. The bracing must be installed within 12" of the top and bottom flanges.
 99. The bracing must be installed within 12" of the top and bottom flanges.
 100. The bracing must be installed within 12" of the top and bottom flanges.
 101. The bracing must be installed within 12" of the top and bottom flanges.
 102. The bracing must be installed within 12" of the top and bottom flanges.
 103. The bracing must be installed within 12" of the top and bottom flanges.
 104. The bracing must be installed within 12" of the top and bottom flanges.
 105. The bracing must be installed within 12" of the top and bottom flanges.
 106. The bracing must be installed within 12" of the top and bottom flanges.
 107. The bracing must be installed within 12" of the top and bottom flanges.
 108. The bracing must be installed within 12" of the top and bottom flanges.
 109. The bracing must be installed within 12" of the top and bottom flanges.
 110. The bracing must be installed within 12" of the top and bottom flanges.
 111. The bracing must be installed within 12" of the top and bottom flanges.
 112. The bracing must be installed within 12" of the top and bottom flanges.
 113. The bracing must be installed within 12" of the top and bottom flanges.
 114. The bracing must be installed within 12" of the top and bottom flanges.
 115. The bracing must be installed within 12" of the top and bottom flanges.
 116. The bracing must be installed within 12" of the top and bottom flanges.
 117. The bracing must be installed within 12" of the top and bottom flanges.
 118. The bracing must be installed within 12" of the top and bottom flanges.
 119. The bracing must be installed within 12" of the top and bottom flanges.
 120. The bracing must be installed within 12" of the top and bottom flanges.
 121. The bracing must be installed within 12" of the top and bottom flanges.
 122. The bracing must be installed within 12" of the top and bottom flanges.
 123. The bracing must be installed within 12" of the top and bottom flanges.
 124. The bracing must be installed within 12" of the top and bottom flanges.
 125. The bracing must be installed within 12" of the top and bottom flanges.
 126. The bracing must be installed within 12" of the top and bottom flanges.
 127. The bracing must be installed within 12" of the top and bottom flanges.
 128. The bracing must be installed within 12" of the top and bottom flanges.
 129. The bracing must be installed within 12" of the top and bottom flanges.
 130. The bracing must be installed within 12" of the top and bottom flanges.
 131. The bracing must be installed within 12" of the top and bottom flanges.
 132. The bracing must be installed within 12" of the top and bottom flanges.
 133. The bracing must be installed within 12" of the top and bottom flanges.
 134. The bracing must be installed within 12" of the top and bottom flanges.
 135. The bracing must be installed within 12" of the top and bottom flanges.
 136. The bracing must be installed within 12" of the top and bottom flanges.
 137. The bracing must be installed within 12" of the top and bottom flanges.
 138. The bracing must be installed within 12" of the top and bottom flanges.
 139. The bracing must be installed within 12" of the top and bottom flanges.
 140. The bracing must be installed within 12" of the top and bottom flanges.
 141. The bracing must be installed within 12" of the top and bottom flanges.
 142. The bracing must be installed within 12" of the top and bottom flanges.
 143. The bracing must be installed within 12" of the top and bottom flanges.
 144. The bracing must be installed within 12" of the top and bottom flanges.
 145. The bracing must be installed within 12" of the top and bottom flanges.
 146. The bracing must be installed within 12" of the top and bottom flanges.
 147. The bracing must be installed within 12" of the top and bottom flanges.
 148. The bracing must be installed within 12" of the top and bottom flanges.
 149. The bracing must be installed within 12" of the top and bottom flanges.
 150. The bracing must be installed within 12" of the top and bottom flanges.
 151. The bracing must be installed within 12" of the top and bottom flanges.
 152. The bracing must be installed within 12" of the top and bottom flanges.
 153. The bracing must be installed within 12" of the top and bottom flanges.
 154. The bracing must be installed within 12" of the top and bottom flanges.
 155. The bracing must be installed within 12" of the top and bottom flanges.
 156. The bracing must be installed within 12" of the top and bottom flanges.
 157. The bracing must be installed within 12" of the top and bottom flanges.
 158. The bracing must be installed within 12" of the top and bottom flanges.
 159. The bracing must be installed within 12" of the top and bottom flanges.
 160. The bracing must be installed within 12" of the top and bottom flanges.
 161. The bracing must be installed within 12" of the top and bottom flanges.
 162. The bracing must be installed within 12" of the top and bottom flanges.
 163. The bracing must be installed within 12" of the top and bottom flanges.
 164. The bracing must be installed within 12" of the top and bottom flanges.
 165. The bracing must be installed within 12" of the top and bottom flanges.
 166. The bracing must be installed within 12" of the top and bottom flanges.
 167. The bracing must be installed within 12" of the top and bottom flanges.
 168. The bracing must be installed within 12" of the top and bottom flanges.
 169. The bracing must be installed within 12" of the top and bottom flanges.
 170. The bracing must be installed within 12" of the top and bottom flanges.
 171. The bracing must be installed within 12" of the top and bottom flanges.
 172. The bracing must be installed within 12" of the top and bottom flanges.
 173. The bracing must be installed within 12" of the top and bottom flanges.
 174. The bracing must be installed within 12" of the top and bottom flanges.
 175. The bracing must be installed within 12" of the top and bottom flanges.
 176. The bracing must be installed within 12" of the top and bottom flanges.
 177. The bracing must be installed within 12" of the top and bottom flanges.
 178. The bracing must be installed within 12" of the top and bottom flanges.
 179. The bracing must be installed within 12" of the top and bottom flanges.
 180. The bracing must be installed within 12" of the top and bottom flanges.
 181. The bracing must be installed within 12" of the top and bottom flanges.
 182. The bracing must be installed within 12" of the top and bottom flanges.
 183. The bracing must be installed within 12" of the top and bottom flanges.
 184. The bracing must be installed within 12" of the top and bottom flanges.
 185. The bracing must be installed within 12" of the top and bottom flanges.
 186. The bracing must be installed within 12" of the top and bottom flanges.
 187. The bracing must be installed within 12" of the top and bottom flanges.
 188. The bracing must be installed within 12" of the top and bottom flanges.
 189. The bracing must be installed within 12" of the top and bottom flanges.
 190. The bracing must be installed within 12" of the top and bottom flanges.
 191. The bracing must be installed within 12" of the top and bottom flanges.
 192. The bracing must be installed within 12" of the top and bottom flanges.
 193. The bracing must be installed within 12" of the top and bottom flanges.
 194. The bracing must be installed within 12" of the top and bottom flanges.
 195. The bracing must be installed within 12" of the top and bottom flanges.
 196. The bracing must be installed within 12" of the top and bottom flanges.
 197. The bracing must be installed within 12" of the top and bottom flanges.
 198. The bracing must be installed within 12" of the top and bottom flanges.
 199. The bracing must be installed within 12" of the top and bottom flanges.
 200. The bracing must be installed within 12" of the top and bottom flanges.
 201. The bracing must be installed within 12" of the top and bottom flanges.
 202. The bracing must be installed within 12" of the top and bottom flanges.
 203. The bracing must be installed within 12" of the top and bottom flanges.
 204. The bracing must be installed within 12" of the top and bottom flanges.
 205. The bracing must be installed within 12" of the top and bottom flanges.
 206. The bracing must be installed within 12" of the top and bottom flanges.
 207. The bracing must be installed within 12" of the top and bottom flanges.
 208. The bracing must be installed within 12" of the top and bottom flanges.
 209. The bracing must be installed within 12" of the top and bottom flanges.
 210. The bracing must be installed within 12" of the top and bottom flanges.
 211. The bracing must be installed within 12" of the top and bottom flanges.
 212. The bracing must be installed within 12" of the top and bottom flanges.
 213. The bracing must be installed within 12" of the top and bottom flanges.
 214. The bracing must be installed within 12" of the top and bottom flanges.
 215. The bracing must be installed within 12" of the top and bottom flanges.
 216. The bracing must be installed within 12" of the top and bottom flanges.
 217. The bracing must be installed within 12" of the top and bottom flanges.
 218. The bracing must be installed within 12" of the top and bottom flanges.
 219. The bracing must be installed within 12" of the top and bottom flanges.
 220. The bracing must be installed within 12" of the top and bottom flanges.
 221. The bracing must be installed within 12" of the top and bottom flanges.
 222. The bracing must be installed within 12" of the top and bottom flanges.
 223. The bracing must be installed within 12" of the top and bottom flanges.
 224. The bracing must be installed within 12" of the top and bottom flanges.
 225. The bracing must be installed within 12" of the top and bottom flanges.
 226. The bracing must be installed within 12" of the top and bottom flanges.
 227. The bracing must be installed within 12" of the top and bottom flanges.
 228. The bracing must be installed within 12" of the top and bottom flanges.
 229. The bracing must be installed within 12" of the top and bottom flanges.
 230. The bracing must be installed within 12" of the top and bottom flanges.
 231. The bracing must be installed within 12" of the top and bottom flanges.
 232. The bracing must be installed within 12" of the top and bottom flanges.
 233. The bracing must be installed within 12" of the top and bottom flanges.
 234. The bracing must be installed within 12" of the top and bottom flanges.
 235. The bracing must be installed within 12" of the top and bottom flanges.
 236. The bracing must be installed within 12" of the top and bottom flanges.
 237. The bracing must be installed within 12" of the top and bottom flanges.
 238. The bracing must be installed within 12" of the top and bottom flanges.
 239. The bracing must be installed within 12" of the top and bottom flanges.
 240. The bracing must be installed within 12" of the top and bottom flanges.
 241. The bracing must be installed within 12" of the top and bottom flanges.
 242. The bracing must be installed within 12" of the top and bottom flanges.
 243. The bracing must be installed within 12" of the top and bottom flanges.
 244. The bracing must be installed within 12" of the top and bottom flanges.
 245. The bracing must be installed within 12" of the top and bottom flanges.
 246. The bracing must be installed within 12" of the top and bottom flanges.
 247. The bracing must be installed within 12" of the top and bottom flanges.
 248. The bracing must be installed within 12" of the top and bottom flanges.
 249. The bracing must be installed within 12" of the top and bottom flanges.
 250. The bracing must be installed within 12" of the top and bottom flanges.
 251. The bracing must be installed within 12" of the top and bottom flanges.
 252. The bracing must be installed within 12" of the top and bottom flanges.
 253. The bracing must be installed within 12" of the top and bottom flanges.
 254. The bracing must be installed within 12" of the top and bottom flanges.
 255. The bracing must be installed within 12" of the top and bottom flanges.
 256. The bracing must be installed within 12" of the top and bottom flanges.
 257. The bracing must be installed within 12" of the top and bottom flanges.
 258. The bracing must be installed within 12" of the top and bottom flanges.
 25

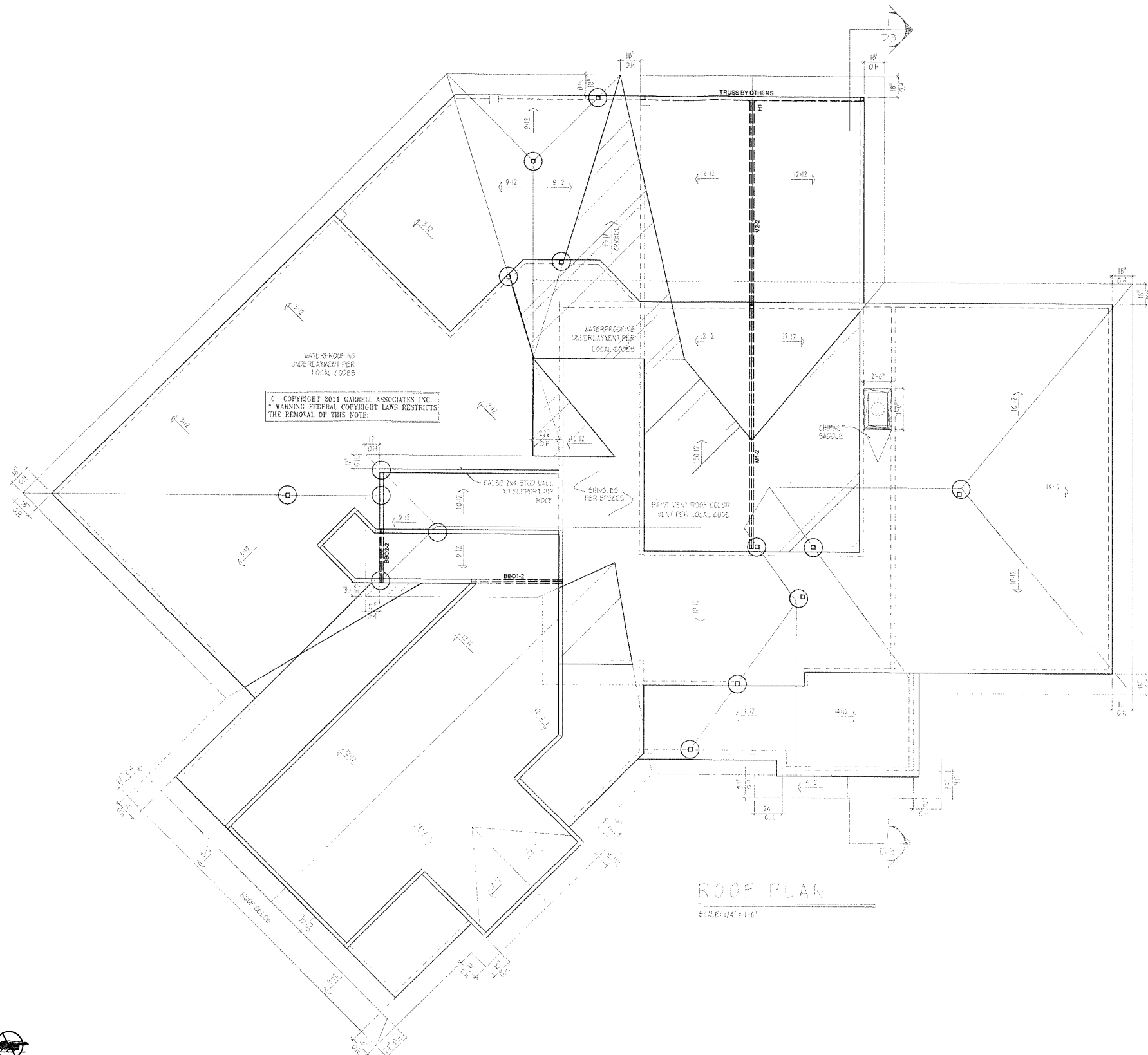

ROOF PLAN
SCALE: 1/4" = 1'-0"

Framing Connector Summary					
ProdID	Qty	Manuf	Product	Backer Blocks	Web Stiff
H1	1	Simpson	HCU3.5311-SDS	No	No

Products				
ProdID	Length	Product	Piles	Net Qty
M1-2	18' 0"	1 3/4" x 16' 2.0E Microlam LVL	2	2
M2-2	16' 0"	1 3/4" x 16' 2.0E Microlam LVL	2	2

Total Lengths	
Length	Product
68' 0"	1 3/4" x 16' 2.0E Microlam LVL

Roof Design Loads:
20 PSF Live Load (115%)
10 PSF Dead Load

Hatch Legend	
	OVERFRAMING

SYMBOL LEGEND

	Bearing Length Requirement
	Line Load
	Point Load
	Area Load
	ESO Member By Others
	CBO Closure By Others
	ULA Under Load Above
	Toilet/Shower Plumbing Drop
	Tub Plumbing Drop
	Walls Above
	Detail Callout Label

GENERAL NOTES:

- Joists may be shifted up to 3' from on center spacing to avoid hanger interference, flush beams and/or plumbing drops. **DO NOT CUT JOIST FLANGES.**
- All EWP beams have been designed assuming full width support of the members/piles, unless noted otherwise.
- This drawing may contain deviations from the original project documents. It is the responsibility of the contractor to notify the project Design Professional of these deviations to verify conformance with the original design intent of the project.
- This layout is intended for the use of TrusJoist engineered wood products only. The substitution of other wood products with this layout is NOT PERMITTED. Please identify the TJI, TimberStrand® LSL, Microlam® LVL and Parallam® PSL stamps on the product to ensure that this layout is valid for the products actually installed.
- Only header openings and roof loads which affect Weyerhaeuser product sizes have been denoted on this layout. In addition to and 'CS' detail callouts shown, solid blocking and/or squash blocks are required to provide vertical load transfer from all concentrated load locations to foundation below. See Pocket Framers Guide for appropriate detail(s).

© COPYRIGHT 2011 GARRELL ASSOCIATES INC.
WARNING FEDERAL COPYRIGHT LAWS RESTRICTS THE REMOVAL OF THIS NOTE:

WARNING

Joists are unstable until braced laterally.

Bracing includes:

- Plywood
- Sheathing
- Stud Line
- Stringer
- Diaphragm
- Shear Wall



DO NOT walk on joists until braced. INJURY MAY RESULT.



DO NOT walk on joists that are lying flat.



DO NOT stack building materials on unbraced joists. Stack only over beams or walls.

WARNING NOTES:

Lack of proper bracing during construction can result in serious accidents. Observe the following guidelines:

WARNING: JOISTS ARE UNSTABLE UNTIL BRACED LATERALLY.

BRACING INCLUDES: Sheathing, Stringer, Ply Shear, Sheathing, Shear Wall, Stud Line.

Lack of proper bracing during construction can result in serious accidents. Observe the following guidelines:

1. Always install all bracing, stringer, sheathing, and stud line 12" from end supports.
2. Establish a permanent deck, sheathing, sheathing, sheathing the first 4 feet of joist at the end of the bay or braced end wall.
3. Safety bracing of all temporary walls to support a floor or roof structure must be installed.
4. Sheathing must be completely attached to each 12" joist before additional bracing can be placed on the system.
5. Size of lumber must ensure safety bracing on both the top and bottom flanges.
6. The stringer must remain at least 12" from top alignment.

Weyerhaeuser, Microlam, Parallam, TimberStrand, LVL, LVL and TrusJoist are registered trademarks of Weyerhaeuser NR. © 2014 Weyerhaeuser NR Company. All rights reserved.

Ceiling/Roof Framing Plan
Scale: 1/4" = 1'-0"



Specification Team
SERVICE REQUESTS@WEYERHAEUSER.COM
WWW.AXIS.WEYERHAEUSER.COM

Weyerhaeuser prepared these plans for the specification of TrusJoist products based on project information provided to us. This service is solely intended for use for the project specified and is not intended to be used for any other project. The designer of record and/or building official is responsible to assure these drawings are compatible with the overall project. Copyright 2009 Weyerhaeuser NR Company. All rights reserved. Any copying or reproduction will constitute an infringement of copyright.

Architectural Drawings Prepared By: GARRELL ASSOC
Structural Drawings Prepared By: N/A
Date: 2/28/12

Latest Revision Date:	Revision Comments:	Revised By:	Drawn By:	Original Date
			Terry O	8/25/20

DAY/MURRAY PLAN	R20-228875
	SR-285597
Sheet	3 of 3