

NOTICE TO CONTRACTOR  
 All construction must comply with current NC Building Codes  
 and is subject to field inspection and verification.

APPROVED  
 Limited building only review  
 Permit holder responsible for  
 full compliance with the code

06/24/2020

*Boydston*



# Vision H&H HOMES - GARAGE LEFT

## PLAN REVISIONS

REVISION DATE: 08/19/2019  
 1) UPDATE ISSUE DATE  
 2) ALIGN FLOOR PLAN WITH FOUNDATION  
 3) UPDATE ELEVATION KEY NOTES

SQUARE FOOTAGE			
AREA	ELEV 'A'	ELEV 'B'	ELEV 'C'
1ST FLOOR	616 SQ. FT.	616 SQ. FT.	616 SQ. FT.
2ND FLOOR	896 SQ. FT.	896 SQ. FT.	896 SQ. FT.
TOTAL HEATING	1512 SQ. FT.	1512 SQ. FT.	1512 SQ. FT.
GARAGE (UNHEATED)	280 SQ. FT.	280 SQ. FT.	280 SQ. FT.
PORCH	24 SQ. FT.	68 SQ. FT.	48 SQ. FT.
PATIO	100 SQ. FT.	100 SQ. FT.	100 SQ. FT.
OPTIONAL PATIO	100 SQ. FT.	100 SQ. FT.	100 SQ. FT.
OPTIONAL GARAGE	240 SQ. FT.	240 SQ. FT.	240 SQ. FT.

ISSUANCE OF PLANS FROM THIS DRAFTER'S OFFICE SHALL NOT RELIEVE THE BUILDER OF RESPONSIBILITY TO REVIEW AND VERIFY ALL NOTES, DIMENSIONS, AND ADHERENCE TO APPLICABLE BUILDING CODES PRIOR TO COMMENCEMENT OF ANY CONSTRUCTION.  
 ANY DISCREPANCY OF ERROR IN NOTES, DIMENSIONS, OR ADHERENCE TO APPLICABLE BUILDING CODES SHALL BE BROUGHT TO THE ATTENTION OF THE DRAFTER'S OFFICE FOR CORRECTION BEFORE COMMENCEMENT OF ANY CONSTRUCTION.  
 ANY REVISIONS OR CHANGES NOT RELATED TO THE CORRECTION OF ERRORS THAT ARE MADE AFTER THE FINAL PLANS HAVE BEEN COMPLETED SHALL BE SUBJECT TO ADDITIONAL FEES.  
 IF ANY MODIFICATIONS ARE MADE TO THESE PLANS BY ANY OTHER PARTY OTHER THAN THE DRAFTER'S OFFICE, THE DRAFTER SHALL NOT BE HELD RESPONSIBLE.



JOB NUMBER	00000.00
CAD FILE NAME	VISION-R
ISSUED	09-18-17
REVISED	08-19-19

DRAWINGS ON 11"x17" SHEET ARE ONE HALF THE SCALE NOTED

*Inventory Marked*

*CS0000078*

VISION  
 H&H HOMES

1514

TITLE  
 REVISION LOG

SHEET  
 CS

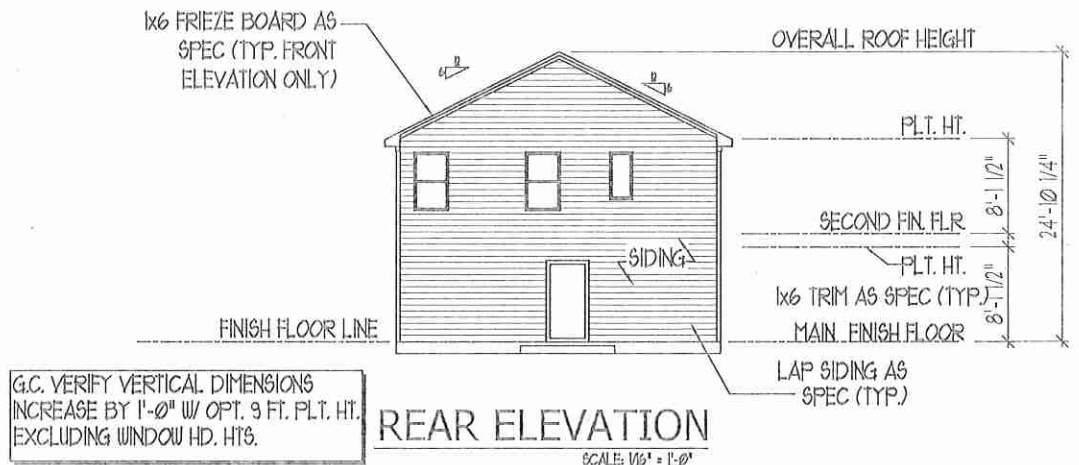

G.C. VERIFY VERTICAL DIMENSIONS INCREASE BY 1'-0" W/ OPT. 9 FT. PLT. HT. EXCLUDING WINDOW HD. HTS.

REAR ELEVATION  
SCALE: 1/8" = 1'-0"

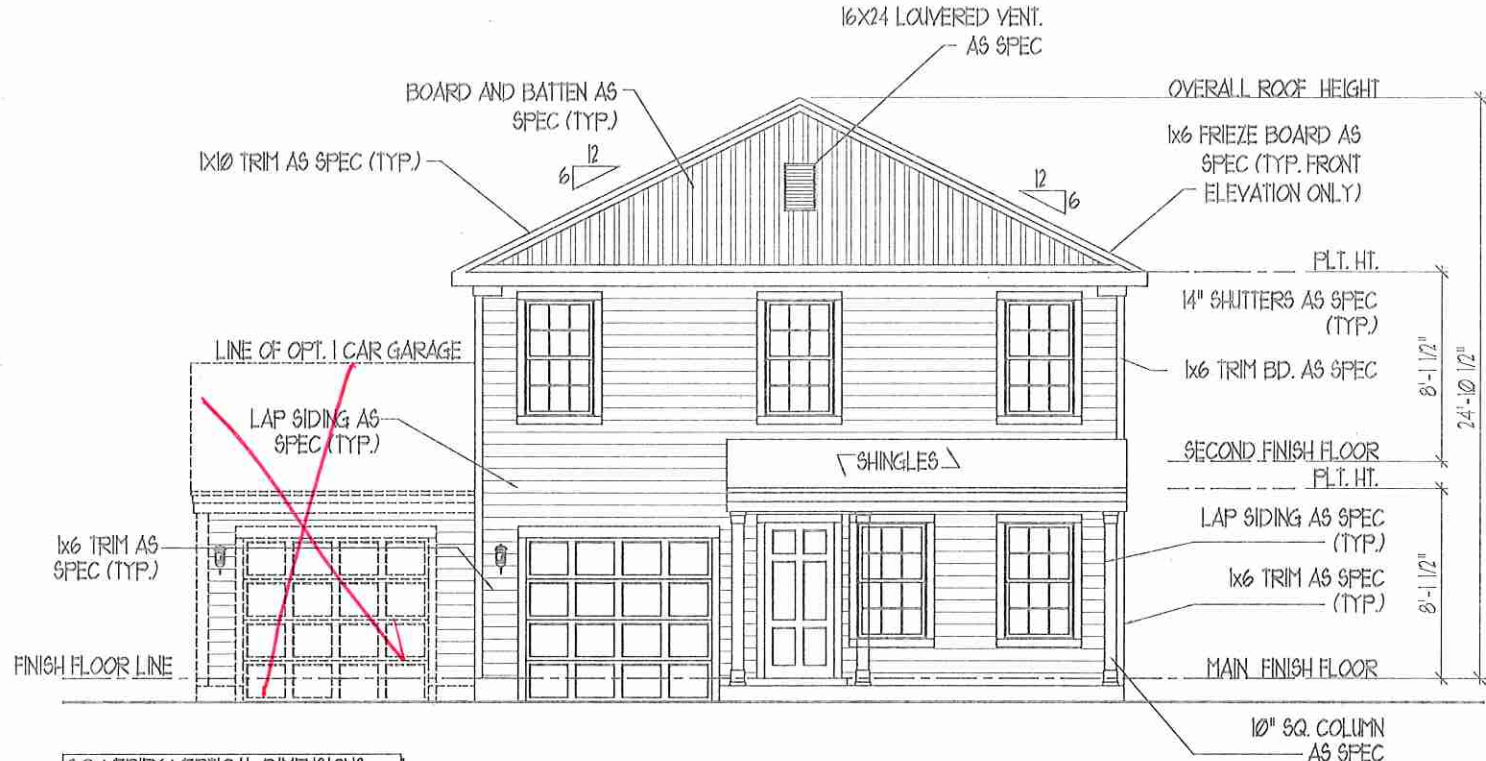

G.C. VERIFY VERTICAL DIMENSIONS INCREASE BY 1'-0" W/ OPT. 9 FT. PLT. HT. EXCLUDING WINDOW HD. HTS.

FRONT ELEVATION  
SCALE: 1/8" = 1'-0"

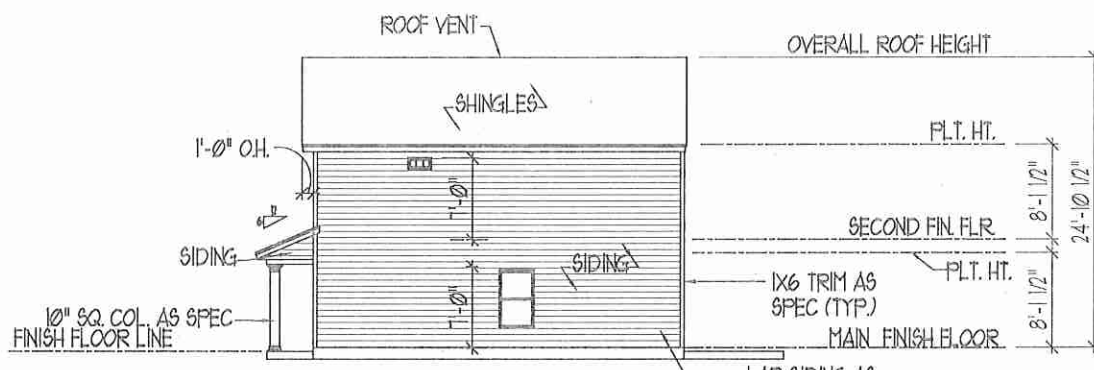

G.C. VERIFY VERTICAL DIMENSIONS INCREASE BY 1'-0" W/ OPT. 9 FT. PLT. HT. EXCLUDING WINDOW HD. HTS.

RIGHT ELEVATION  
SCALE: 1/8" = 1'-0"

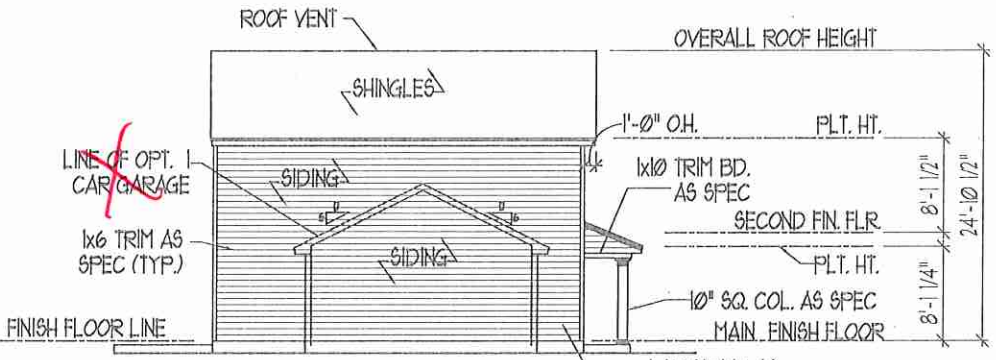

G.C. VERIFY VERTICAL DIMENSIONS INCREASE BY 1'-0" W/ OPT. 9 FT. PLT. HT. EXCLUDING WINDOW HD. HTS.

LEFT ELEVATION  
SCALE: 1/8" = 1'-0"

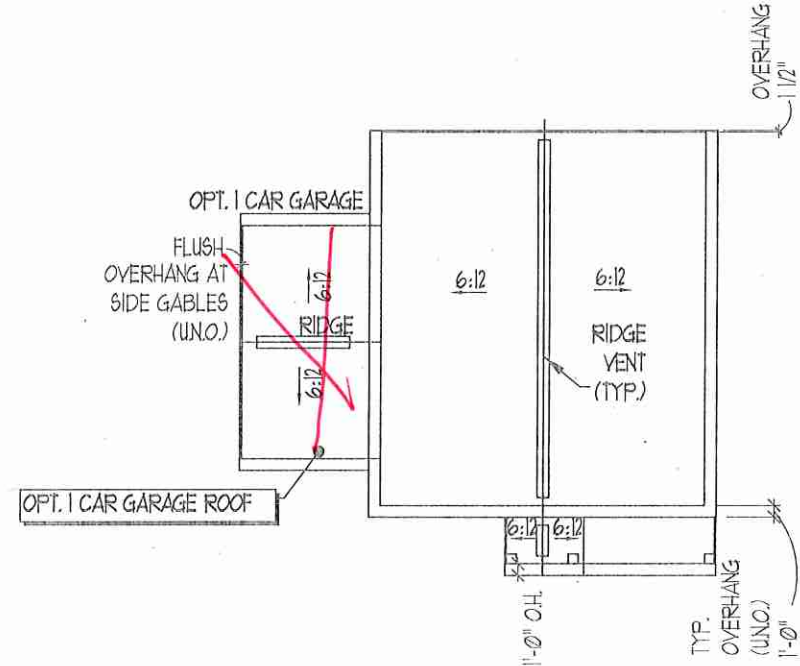

ISSUANCE OF PLANS FROM THIS DRAFTER'S OFFICE SHALL NOT RELIEVE THE BUILDER OF RESPONSIBILITY TO REVIEW AND VERIFY ALL NOTES, DIMENSIONS, AND ADHERENCE TO APPLICABLE BUILDING CODES PRIOR TO COMMENCEMENT OF ANY CONSTRUCTION.  
ANY DISCREPANCY OF ERROR IN NOTES, DIMENSIONS, OR ADHERENCE TO APPLICABLE BUILDING CODES SHALL BE BROUGHT TO THE ATTENTION OF THE DRAFTER'S OFFICE FOR CORRECTION BEFORE COMMENCEMENT OF ANY CONSTRUCTION.  
ANY REVISIONS OR CHANGES, NOT RELATED TO THE CORRECTION OF ERRORS THAT ARE MADE AFTER THE FINAL PLANS HAVE BEEN COMPLETED SHALL BE SUBJECT TO ADDITIONAL FEES.  
IF ANY MODIFICATIONS ARE MADE TO THESE PLANS BY ANY OTHER PARTY OTHER THAN THE DRAFTER'S OFFICE, THE DRAFTER SHALL NOT BE HELD RESPONSIBLE.



JOB NUMBER	00000.00
CAD FILE NAME	VISION-R
ISSUED	09-18-17
REVISED	08-19-19

DRAWINGS ON 11"x17" SHEET ARE ONE HALF THE SCALE NOTED

VISION  
H&H HOMES

1514

TITLE  
FRONT ELEVATION  
REAR ELEVATION  
RIGHT ELEVATION  
LEFT ELEVATION  
ROOF PLAN

SHEET  
A4.0

ELEVATION & ROOF  
PLAN "B" - TRADITIONAL  
GARAGE LEFT

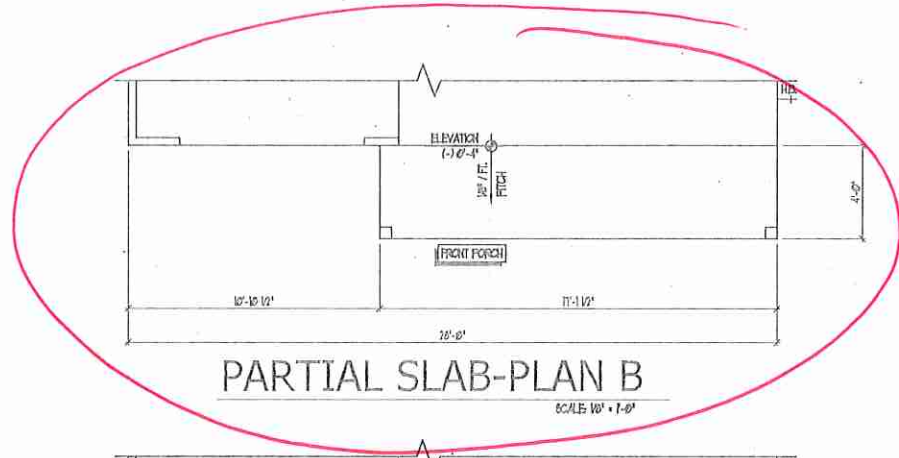

PARTIAL SLAB-PLAN B  
SCALE 1/8" = 1'-0"

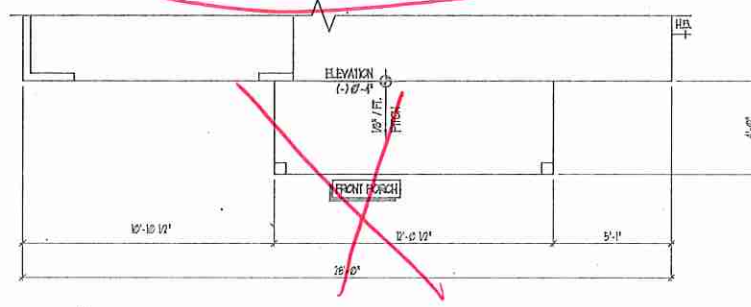

PARTIAL SLAB-PLAN C  
SCALE 1/8" = 1'-0"

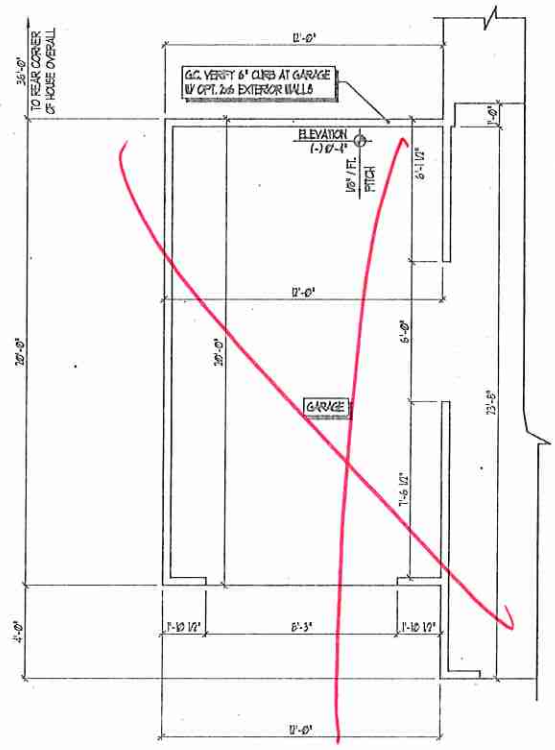

OPT. 1 CAR GARAGE  
SLAB PLAN  
SCALE 1/8" = 1'-0"

GC. VERIFY INSTALLATION OF OVERHEAD GAS DROPS AT APPLICABLE AFFLIANCE LOCATIONS

REFER TO STANDARD PLAN FOR INFORMATION NOT SHOWN

ISSUANCE OF PLANS FROM THIS DRAFTER'S OFFICE SHALL NOT RELIEVE THE BUILDER OF RESPONSIBILITY TO REVIEW AND VERIFY ALL NOTES, DIMENSIONS, AND ADHERENCE TO APPLICABLE BUILDING CODES PRIOR TO COMMENCEMENT OF ANY CONSTRUCTION.  
ANY DISCREPANCY OF ERROR IN NOTES, DIMENSIONS, OR ADHERENCE TO APPLICABLE BUILDING CODES SHALL BE BROUGHT TO THE ATTENTION OF THE DRAFTER'S OFFICE FOR CORRECTION BEFORE COMMENCEMENT OF ANY CONSTRUCTION.  
ANY REVISIONS OR CHANGES NOT RELATED TO THE CORRECTION OF ERRORS THAT ARE MADE AFTER THE FINAL PLANS HAVE BEEN COMPLETED SHALL BE SUBJECT TO ADDITIONAL FEES.  
IF ANY MODIFICATIONS ARE MADE TO THESE PLANS BY ANY OTHER PARTY OTHER THAN THE DRAFTER'S OFFICE, THE DRAFTER SHALL NOT BE HELD RESPONSIBLE.

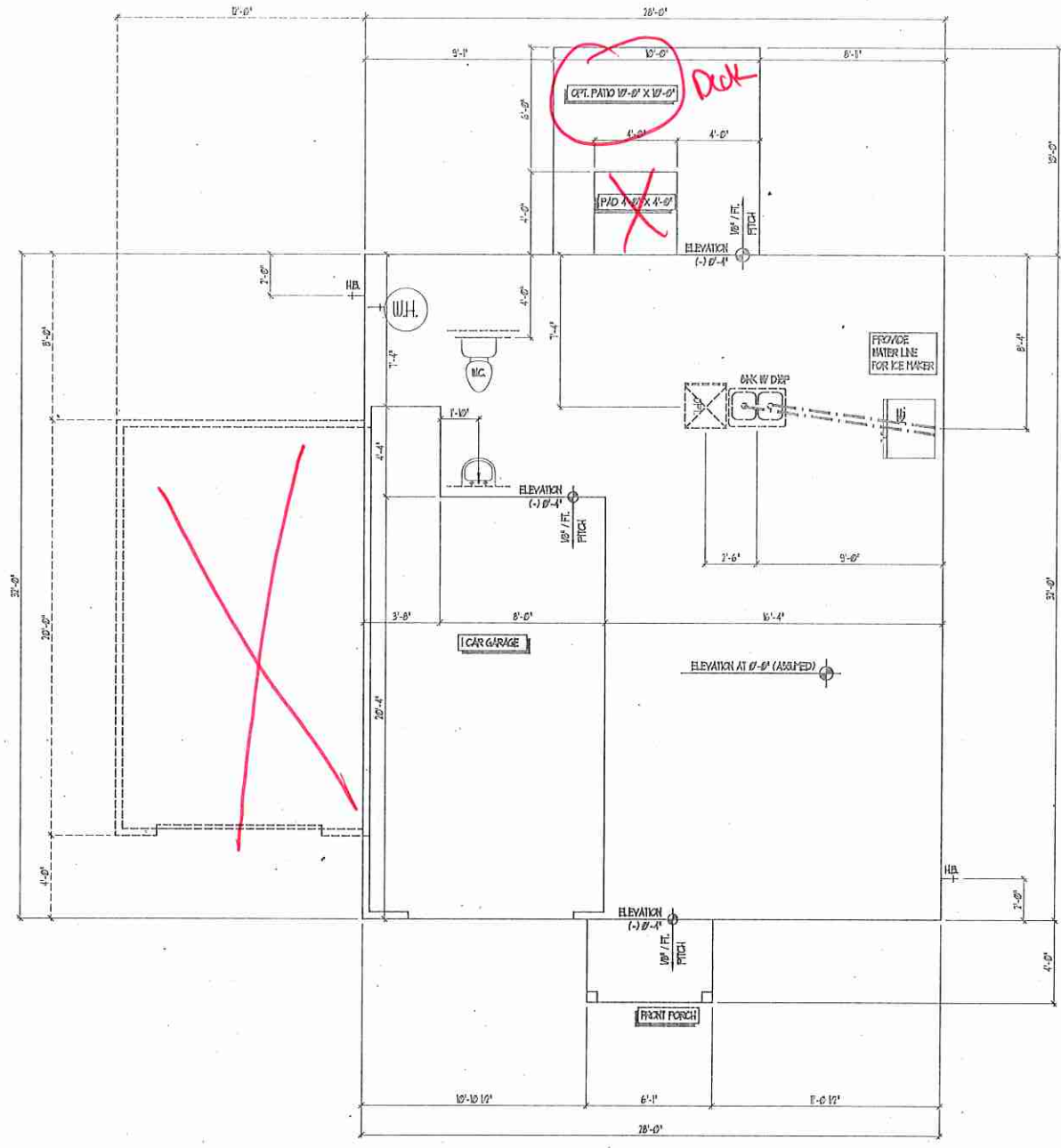

SLAB PLAN-A  
SCALE 1/8" = 1'-0"

GC. VERIFY INSTALLATION OF OVERHEAD GAS DROPS AT APPLICABLE AFFLIANCE LOCATIONS

See Elevation B



JOB NUMBER	00000.00
CAD FILE NAME	VISION-R
ISSUED	09-18-17
REVISED	09-19-19

DRAWINGS ON 11"x17" SHEET ARE ONE HALF THE SCALE NOTED

VISION  
H&H HOMES

1514

TITLE  
SLAB INTERFACE PLAN A  
PARTIAL SLABS B AND C  
OPT. 1 CAR GARAGE SLAB

SHEET  
A1.0

SLAB INTERFACE PLAN  
GARAGE LEFT



PROJ NUMBER	00000.00
CAD FILE NAME	VISION-R
ISSUED	09-18-17
REVISED	09-19-19

DRAWINGS ON 11"x17" SHEET ARE ONE HALF THE SCALE NOTED

VISION  
H&H HOMES

1514

TITLE  
MAIN FLOOR PLAN  
PARTIAL FLOOR PLANS  
OPT. 1 CAR GARAGE PLAN

SHEET  
A2.0

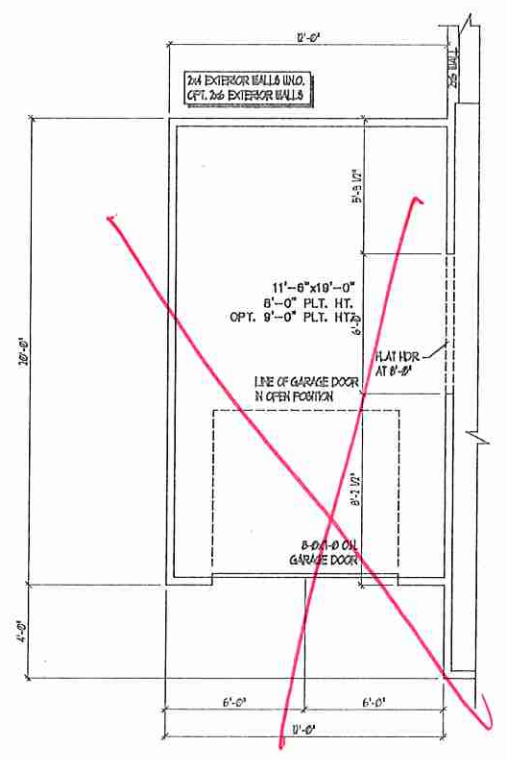
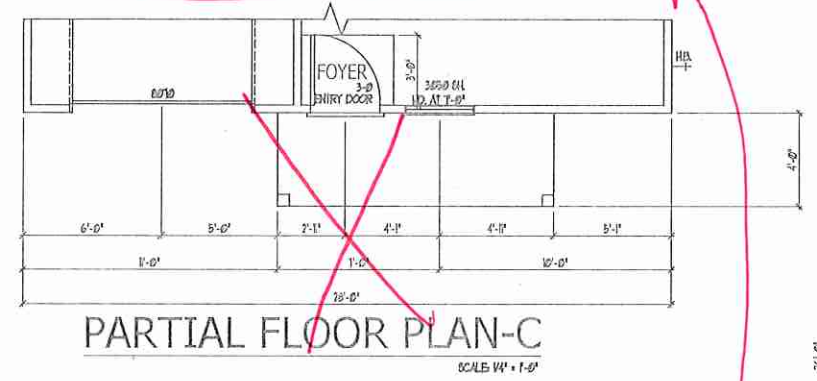
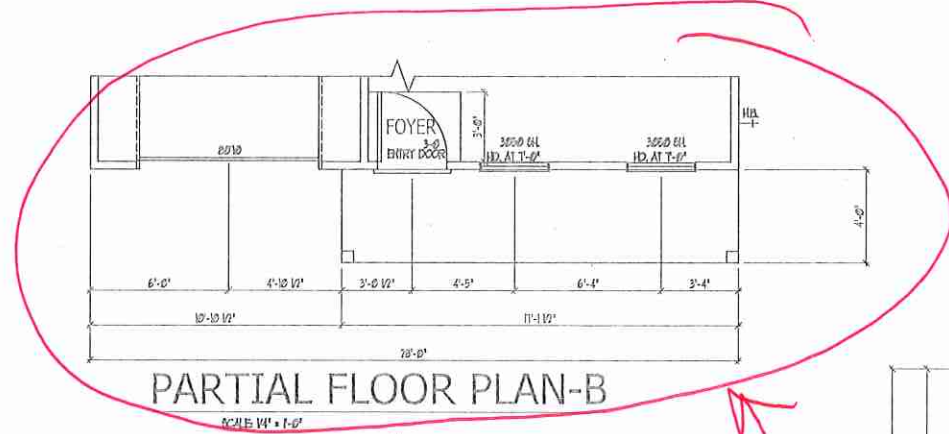

OPT. 1 CAR GARAGE  
SCALE 1/4" = 1'-0"  
1 CAR GARAGE (+) 240 SF.

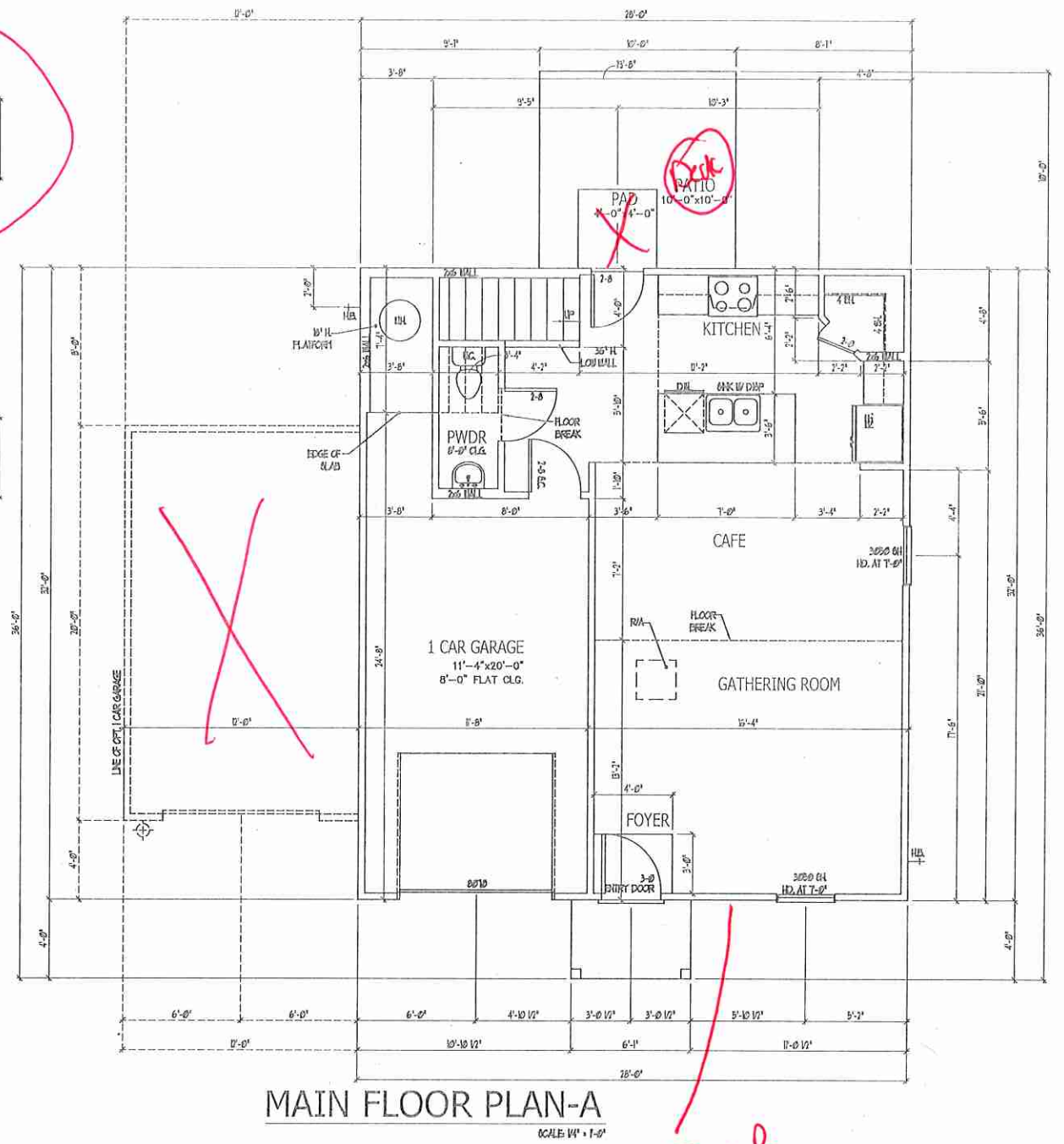

MAIN FLOOR PLAN-A  
SCALE 1/4" = 1'-0"  
See Elev. B

THE GARAGE SHALL BE SEPARATED FROM THE RESIDENCE AND ITS ATTIC AREA BY NOT LESS THAN 1/2 INCH (12.5 mm) GYPSUM BOARD APPLIED TO THE GARAGE SIDE. GARAGES BENEATH HABITABLE ROOMS SHALL BE SEPARATED FROM ALL HABITABLE ROOMS ABOVE BY NOT LESS THAN 5/8 INCH (15.9 mm) TYPE "X" GYPSUM BOARD OR EQUIVALENT. WHERE THE SEPARATION IS A FLOOR-CEILING ASSEMBLY, THE STRUCTURE SUPPORTING THE SEPARATION SHALL ALSO BE PROTECTED BY NOT LESS THAN 1/2 INCH (12.5 mm) GYPSUM BOARD OR EQUIVALENT.

AREA	SQUARE FOOTAGE		
	ELEV 'A'	ELEV 'B'	ELEV 'C'
1ST FLOOR	616 SQ. FT.	616 SQ. FT.	616 SQ. FT.
2ND FLOOR	895 SQ. FT.	895 SQ. FT.	895 SQ. FT.
TOTAL HEATING	1512 SQ. FT.	1512 SQ. FT.	1512 SQ. FT.
GARAGE (UNHEATED)	240 SQ. FT.	240 SQ. FT.	240 SQ. FT.
PORCH	24 SQ. FT.	66 SQ. FT.	48 SQ. FT.
PATIO	100 SQ. FT.	100 SQ. FT.	100 SQ. FT.
OPTIONAL PATIO	100 SQ. FT.	100 SQ. FT.	100 SQ. FT.
OPTIONAL GARAGE	240 SQ. FT.	240 SQ. FT.	240 SQ. FT.

ISSUANCE OF PLANS FROM THIS DRAFTER'S OFFICE SHALL NOT RELIEVE THE BUILDER OF RESPONSIBILITY TO REVIEW AND VERIFY ALL NOTES, DIMENSIONS, AND ADHERENCE TO APPLICABLE BUILDING CODES PRIOR TO COMMENCEMENT OF ANY CONSTRUCTION.  
ANY DISCREPANCY OF ERROR IN NOTES, DIMENSIONS, OR ADHERENCE TO APPLICABLE BUILDING CODES SHALL BE BROUGHT TO THE ATTENTION OF THE DRAFTER'S OFFICE FOR CORRECTION BEFORE COMMENCEMENT OF ANY CONSTRUCTION.  
ANY REVISIONS OR CHANGES NOT RELATED TO THE CORRECTION OF ERRORS THAT ARE MADE AFTER THE FINAL PLANS HAVE BEEN COMPLETED SHALL BE SUBJECT TO ADDITIONAL FEES.  
IF ANY MODIFICATIONS ARE MADE TO THESE PLANS BY ANY OTHER PARTY OTHER THAN THE DRAFTER'S OFFICE, THE DRAFTER SHALL NOT BE HELD RESPONSIBLE.

MAIN FLOOR PLAN  
SCALE 1/4" = 1'-0"  
GARAGE LEFT

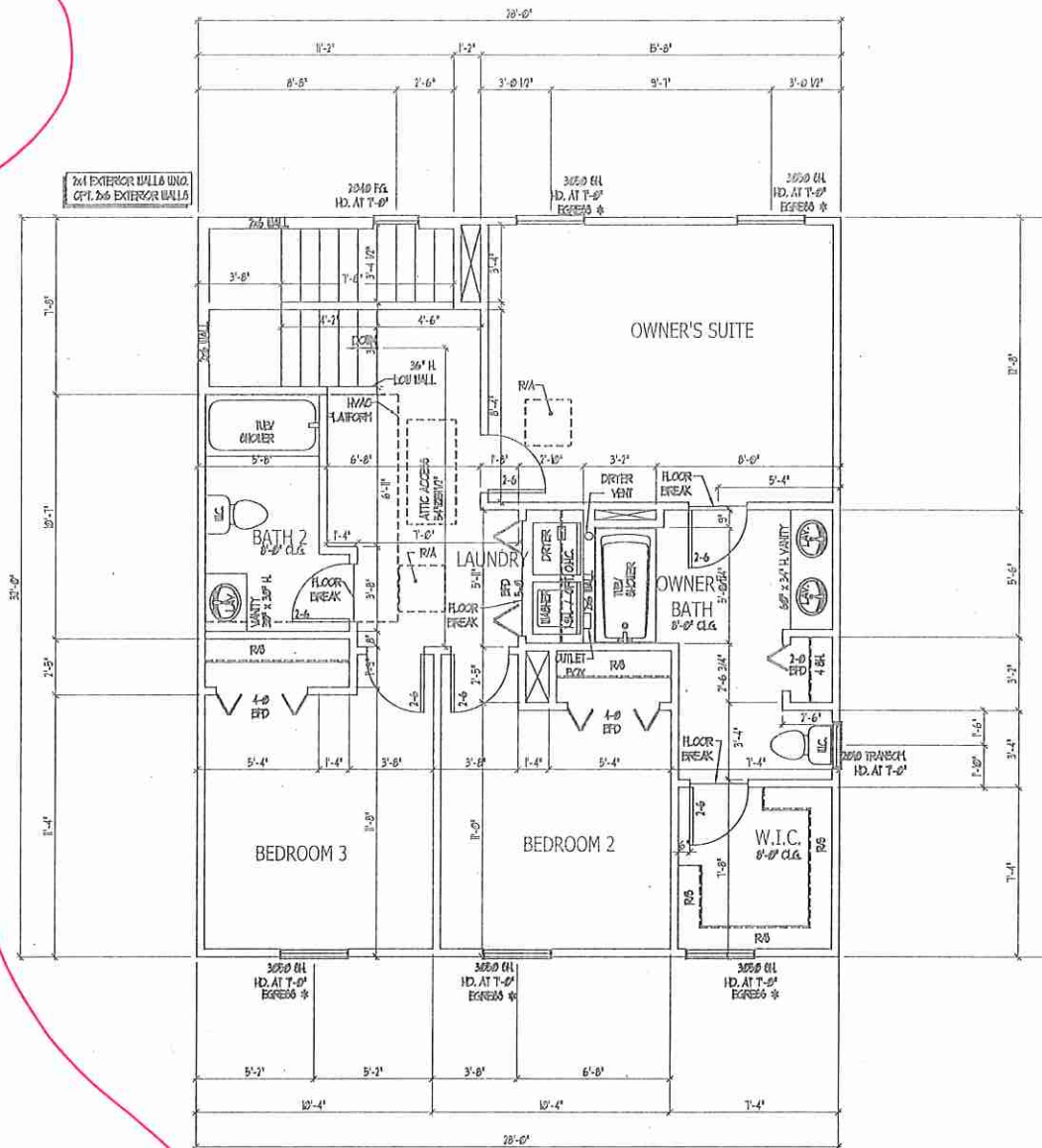
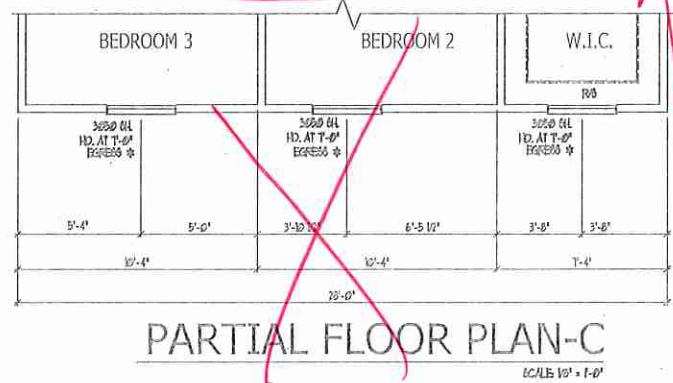
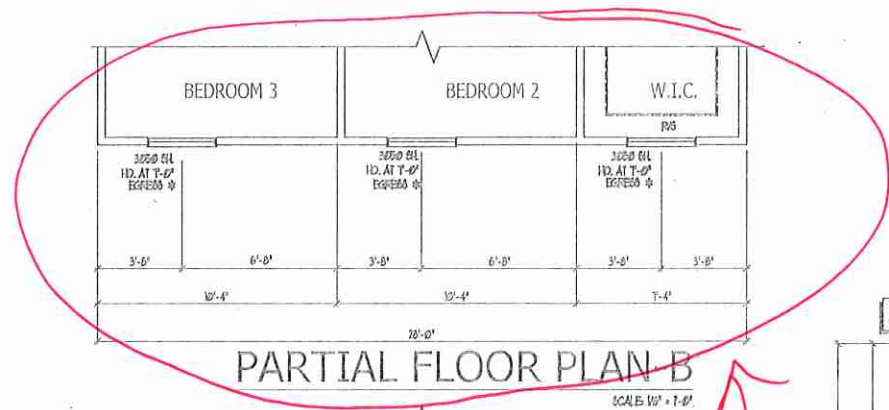

*See Dev. B*

GS ON 11"x11" ARE ONE HALF ALE NOTED

ISSUANCE OF PLANS FROM THIS DRAFTER'S OFFICE SHALL NOT RELIEVE THE BUILDER OF RESPONSIBILITY TO REVIEW AND VERIFY ALL NOTES, DIMENSIONS, AND ADHERENCE TO APPLICABLE BUILDING CODES PRIOR TO COMMENCEMENT OF ANY CONSTRUCTION.  
 ANY DISCREPANCY OF ERROR IN NOTES, DIMENSIONS, OR ADHERENCE TO APPLICABLE BUILDING CODES SHALL BE BROUGHT TO THE ATTENTION OF THE DRAFTER'S OFFICE FOR CORRECTION BEFORE COMMENCEMENT OF ANY CONSTRUCTION.  
 ANY REVISIONS OR CHANGES, NOT RELATED TO THE CORRECTION OF ERRORS THAT ARE MADE AFTER THE FINAL PLANS HAVE BEEN COMPLETED SHALL BE SUBJECT TO ADDITIONAL FEES.  
 IF ANY MODIFICATIONS ARE MADE TO THESE PLANS BY ANY OTHER PARTY OTHER THAN THE DRAFTER'S OFFICE, THE DRAFTER SHALL NOT BE HELD RESPONSIBLE.

**UPPER FLOOR PLAN**  
SCALE 1/8" = 1'-0"  
GARAGE LEFT

**H&H HOMES**  
UPPER FLOOR PLAN  
**A2.1**



JOB NUMBER	00000.00
CAD FILE NAME	VISION-R
ISSUED	09-18-17
REVISED	08-19-19

DRAWINGS ON 11"x17" SHEET ARE ONE HALF THE SCALE NOTED

VISION  
H&H HOMES

1514

TITLE  
MAIN FLOOR ELEC. PLAN

SHEET  
E1

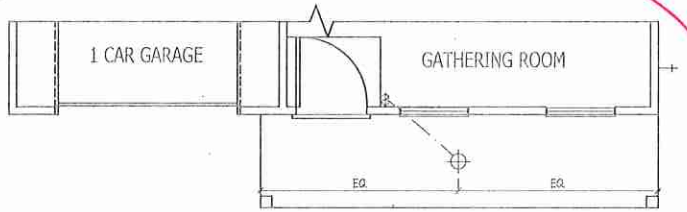

PARTIAL FLOOR PLAN-B  
SCALE: 1/4" = 1'-0"

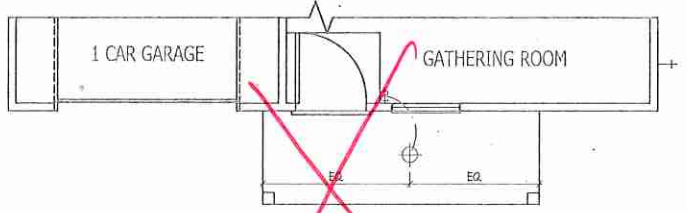

PARTIAL FLOOR PLAN-C  
SCALE: 1/4" = 1'-0"

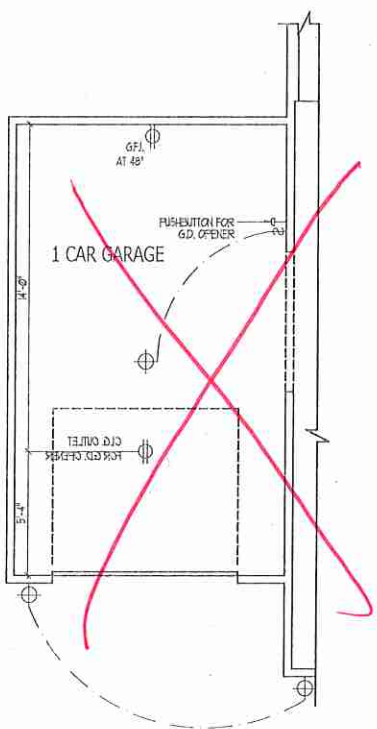

OPT. 1 CAR GARAGE

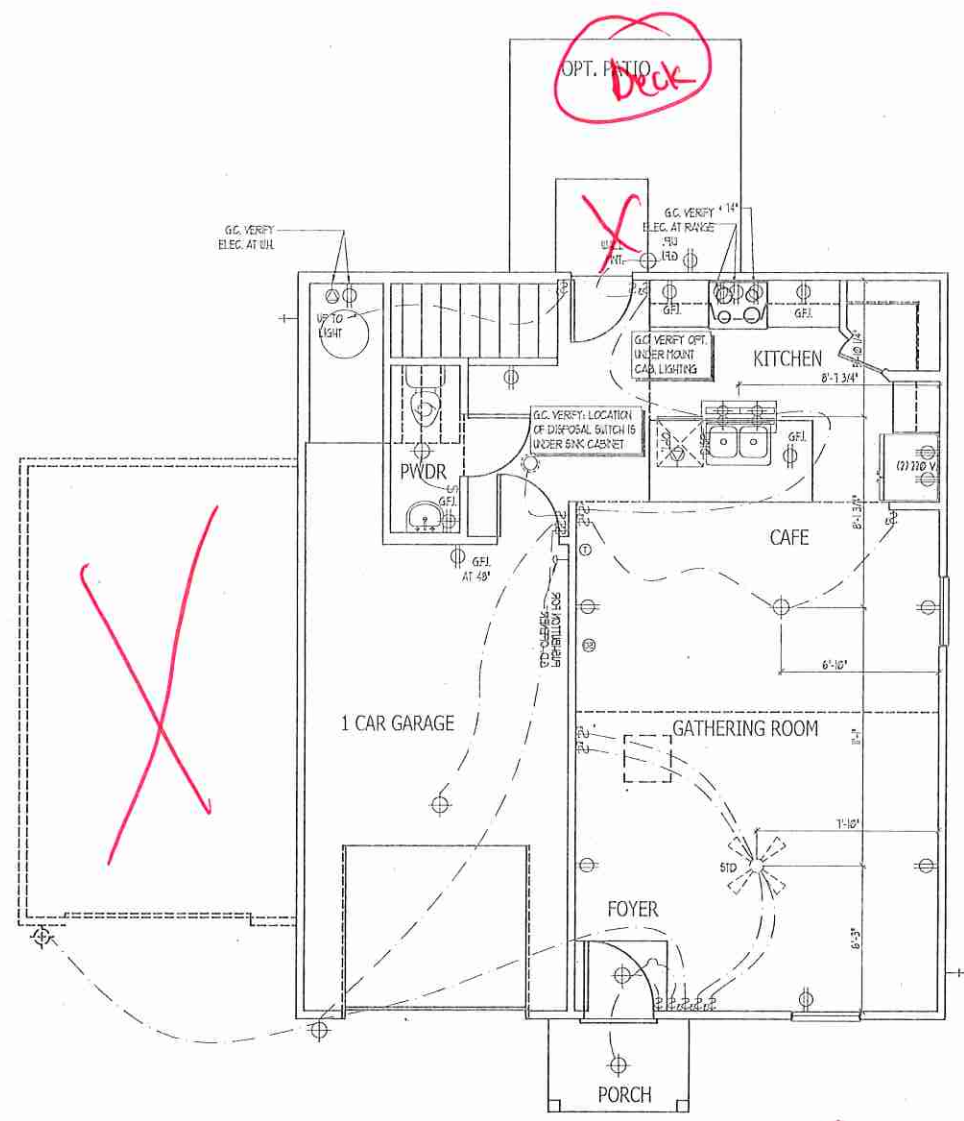

MAIN FLOOR PLAN-A  
SCALE: 1/4" = 1'-0"

See Dev. B

ELECTRICAL KEY

- ⊕ DUPLEX CONVENIENCE OUTLET
- ⊕ DUPLEX OUTLET ABOVE COUNTER
- ⊕ LEATHERPROOF DUPLEX OUTLET
- ⊕ GROUND FAULT INTERRUPTER DUPLEX OUTLET
- ⊕ HALF-SWITCHED DUPLEX OUTLET
- ⊕ SPECIAL PURPOSE OUTLET
- ⊕ DUPLEX OUTLET IN FLOOR
- ⊕ 220 VOLT OUTLET
- ⊕ WALL SWITCH
- ⊕ THREE-WAY SWITCH
- ⊕ FOUR-WAY SWITCH
- ⊕ DIMMER SWITCH
- ⊕ CEILING MOUNTED INCANDESCENT LIGHT FIXTURE
- ⊕ WALL MOUNTED INCANDESCENT LIGHT FIXTURE
- ⊕ RECESSED INCANDESCENT LIGHT FIXTURE
- ⊕ LIGHT FIXTURE WITH FULL CHAIN
- ⊕ TRACK LIGHT
- ⊕ FLUORESCENT LIGHT FIXTURE
- ⊕ EXHAUST FAN
- ⊕ EXHAUST FAN, LIGHT COORDINATION
- ⊕ ELECTRIC DOOR OPERATOR (OPTIONAL)
- ⊕ CHIMES (OPTIONAL)
- ⊕ PUSHBUTTON SWITCH (OPTIONAL)
- ⊕ CARBON MONOXIDE DETECTOR
- ⊕ SMOKE DETECTOR
- ⊕ SMOKE / CARBON MONOXIDE DETECTOR
- ⊕ TELEPHONE (OPTIONAL)
- ⊕ TELEVISION (OPTIONAL)
- ⊕ THERMOSTAT
- ⊕ ELECTRIC METER
- ⊕ ELECTRIC PANEL
- ⊕ DISCONNECT SWITCH
- ⊕ SPEAKER (OPTIONAL)
- ⊕ ROUGH-IN FOR OPT. CEILING FAN
- ⊕ CEILING MOUNTED INCANDESCENT LIGHT FIXTURE W/ ROUGH-IN FOR OPT. CEILING FAN

NOTES:

1. PROVIDE AND INSTALL GROUND FAULT CIRCUIT INTERRUPTERS (GFCI) AS INDICATED ON PLANS OR AS ITEM NO. 4 AND 5 BELOW INDICATES.
2. UNLESS OTHERWISE INDICATED, INSTALL SWITCHES AND RECEPTACLES AT THE FOLLOWING HEIGHTS ABOVE FINISHED FLOOR:  
SWITCHES, ... 48"  
OUTLETS, ... 18"  
TELEPHONE, ... 36" (UNLESS ABOVE COUNTERTOP)  
TELEVISION, ... 36"
3. ALL SMOKE DETECTORS SHALL BE HARDCWIRED INTO AN ELECTRICAL POWER SOURCE AND SHALL BE EQUIPPED WITH A MONITORED BATTERY BACKUP. PROVIDE AND INSTALL LOCALLY CERTIFIED SMOKE DETECTORS.
4. ALL 15A AND 20A RECEPTACLES IN SLEEPING ROOMS, FAMILY ROOMS, DINING ROOMS, LIVING ROOMS, PARLORS, LIBRARIES, DEN, SUNROOMS, RECREATION ROOMS, CLOSETS, HALLWAYS, AND SIMILAR AREAS WILL REQUIRE A COORDINATION TYPE AFCI DEVICE AND TAMPER-PROOF RECEPTACLES PER NEC 200.406(B) AND 406(D).
5. ALL 15A AND 20A 120V RECEPTACLES LOCATED IN THE GARAGE AND UTILITY ROOMS SHALL BE GFCI PROTECTED (GFI).
6. IT IS THE RESPONSIBILITY OF THE LICENSED ELECTRICIAN TO ENSURE THAT ALL ELECTRICAL WORK IS IN FULL COMPLIANCE WITH NFPA 70, NEC 201, AND ALL APPLICABLE LOCAL STANDARDS, CODES, AND ORDINANCES.
7. EVERY BUILDING HAVING A FOSSEL-FUEL-BURNING HEATER OR APPLIANCE, FIREPLACE, OR AN ATTACHED GARAGE SHALL HAVE AN OPERATIONAL CARBON MONOXIDE DETECTOR INSTALLED WITHIN 10 FEET OF EACH ROOM USED FOR SLEEPING PURPOSES.
8. ALARMS SHALL RECEIVE THEIR PRIMARY POWER FROM THE BUILDING WIRING WHEN SUCH WIRING IS SERVED FROM THE LOCAL POWER UTILITY. SUCH ALARMS SHALL HAVE BATTERY BACKUP COORDINATION SMOKE/CARBON MONOXIDE ALARMS SHALL BE LISTED OR LABELED BY A NATIONALLY RECOGNIZED TESTING LABORATORY.

ISSUANCE OF PLANS FROM THIS DRAFTER'S OFFICE SHALL NOT RELIEVE THE BUILDER OF RESPONSIBILITY TO REVIEW AND VERIFY ALL NOTES, DIMENSIONS, AND ADHERENCE TO APPLICABLE BUILDING CODES PRIOR TO COMMENCEMENT OF ANY CONSTRUCTION.  
ANY DISCREPANCY OF ERROR IN NOTES, DIMENSIONS, OR ADHERENCE TO APPLICABLE BUILDING CODES SHALL BE BROUGHT TO THE ATTENTION OF THE DRAFTER'S OFFICE FOR CORRECTION BEFORE COMMENCEMENT OF ANY CONSTRUCTION.  
ANY REVISIONS OR CHANGES NOT RELATED TO THE CORRECTION OF ERRORS THAT ARE MADE AFTER THE FINAL PLANS HAVE BEEN COMPLETED SHALL BE SUBJECT TO ADDITIONAL FEES.  
IF ANY MODIFICATIONS ARE MADE TO THESE PLANS BY ANY OTHER PARTY OTHER THAN THE DRAFTER'S OFFICE, THE DRAFTER SHALL NOT BE HELD RESPONSIBLE.

MAIN FLOOR ELECTRICAL PLAN  
GARAGE LEFT

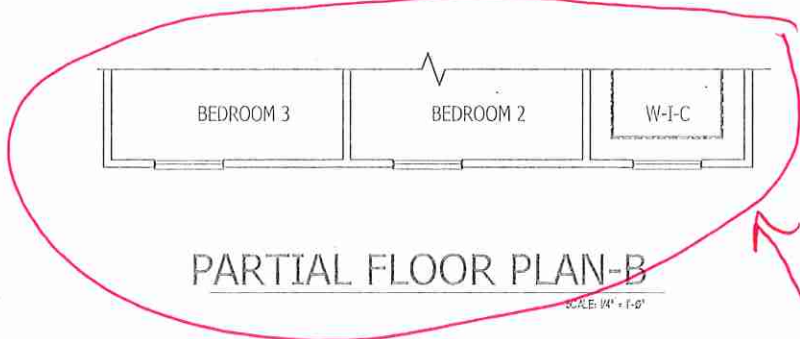

PARTIAL FLOOR PLAN-B  
SCALE: 1/4" = 1'-0"

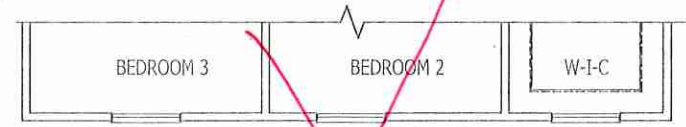

PARTIAL FLOOR PLAN-C  
SCALE: 1/4" = 1'-0"

**ELECTRICAL KEY**

- ⊕ DUPLEX CONVENIENCE OUTLET
- ⊕ DUPLEX OUTLET ABOVE COUNTER
- ⊕ WEATHER-PROOF DUPLEX OUTLET
- ⊕ GROUND FAULT INTERRUPTER DUPLEX OUTLET
- ⊕ HALF-SWITCHED DUPLEX OUTLET
- ⊕ SPECIAL PURPOSE OUTLET
- ⊕ DUPLEX OUTLET IN FLOOR
- ⊕ 220 VOLT OUTLET
- ⊕ WALL SWITCH
- ⊕ THREE-WAY SWITCH
- ⊕ FOUR-WAY SWITCH
- ⊕ DIMMER SWITCH
- ⊕ CEILING MOUNTED INCANDESCENT LIGHT FIXTURE
- ⊕ WALL MOUNTED INCANDESCENT LIGHT FIXTURE
- ⊕ RECESSED INCANDESCENT LIGHT FIXTURE
- ⊕ LIGHT FIXTURE WITH FULL CHAIN
- ⊕ TRACK LIGHT
- ⊕ FLUORESCENT LIGHT FIXTURE
- ⊕ EXHAUST FAN
- ⊕ EXHAUST FAN LIGHT COORDINATION
- ⊕ ELECTRIC DOOR OPERATOR (OPTIONAL)
- ⊕ CHIMES (OPTIONAL)
- ⊕ PUSHBUTTON SWITCH (OPTIONAL)
- ⊕ CARBON MONOXIDE DETECTOR
- ⊕ SMOKE DETECTOR
- ⊕ SMOKE / CARBON MONOXIDE COMBO DETECTOR
- ⊕ TELEPHONE (OPTIONAL)
- ⊕ TELEVISION (OPTIONAL)
- ⊕ THERMOSTAT
- ⊕ ELECTRIC METER
- ⊕ ELECTRIC PANEL
- ⊕ DISCONNECT SWITCH
- ⊕ SPEAKER (OPTIONAL)
- ⊕ ROUGH-IN FOR OPT. CEILING FAN
- ⊕ CEILING MOUNTED INCANDESCENT LIGHT FIXTURE W/ ROUGH-IN FOR OPT. CEILING FAN

**NOTES:**

1. PROVIDE AND INSTALL GROUND FAULT CIRCUIT INTERRUPTERS (GFCI) AS INDICATED ON PLANS OR AS ITEM NO. 4 AND 5 BELOW INDICATES.
2. UNLESS OTHERWISE INDICATED, INSTALL SWITCHES AND RECEPTACLES AT THE FOLLOWING HEIGHTS ABOVE FINISHED FLOOR:  
 SWITCHES... 4'  
 OUTLETS... 14"  
 TELEPHONE... 14" (UNLESS ASV COUNTERTOP)  
 TELEVISION... 14'
3. ALL SMOKE DETECTORS SHALL BE HARDCWIRED INTO AN ELECTRICAL POWER SOURCE AND SHALL BE EQUIPPED WITH A MONITORED BATTERY BACKUP. PROVIDE AND INSTALL LOCALLY CERTIFIED SMOKE DETECTORS.
4. ALL 15A AND 20A RECEPTACLES IN SLEEPING ROOMS, FAMILY ROOMS, DINING ROOMS, LIVING ROOMS, PARLORS, LIBRARIES, DEN, SUNROOMS, RECREATION ROOMS, CLOSETS, HALLWAYS, AND SIMILAR AREAS SHALL REQUIRE A COORDINATION TYPE AFCI DEVICE AND TAMPER-PROOF RECEPTACLES PER NEC 700.406(B) AND 406(B).
5. ALL 15A AND 20A 120V RECEPTACLES LOCATED IN THE GARAGE AND UTILITY ROOMS SHALL BE GFCI PROTECTED (GFPI).
6. IT IS THE RESPONSIBILITY OF THE LICENSED ELECTRICIAN TO ENSURE THAT ALL ELECTRICAL WORK IS IN FULL COMPLIANCE WITH NFPA 70, NEC 200, AND ALL APPLICABLE LOCAL STANDARDS, CODES, AND ORDINANCES.
7. EVERY BUILDING HAVING A FOSSIL FUEL-BURNING HEATER OR APPLIANCE, FIREPLACE, OR AN ATTACHED GARAGE SHALL HAVE AN OPERATIONAL CARBON MONOXIDE DETECTOR INSTALLED WITHIN 10 FEET OF EACH ROOM USED FOR SLEEPING PURPOSES.
8. ALARMS SHALL RECEIVE THEIR PRIMARY POWER FROM THE BUILDING WIRING WHEN SUCH WIRING IS SERVED FROM THE LOCAL POWER UTILITY. SUCH ALARMS SHALL HAVE BATTERY BACKUP, COORDINATION SMOKE/CARBON MONOXIDE ALARMS SHALL BE LISTED OR LABELED BY A NATIONALLY RECOGNIZED TESTING LABORATORY.

ISSUANCE OF PLANS FROM THIS DRAFTER'S OFFICE SHALL NOT RELIEVE THE BUILDER OF RESPONSIBILITY TO REVIEW AND VERIFY ALL NOTES, DIMENSIONS, AND ADHERENCE TO APPLICABLE BUILDING CODES PRIOR TO COMMENCEMENT OF ANY CONSTRUCTION.  
 ANY DISCREPANCY OF ERROR IN NOTES, DIMENSIONS, OR ADHERENCE TO APPLICABLE BUILDING CODES SHALL BE BROUGHT TO THE ATTENTION OF THE DRAFTER'S OFFICE FOR CORRECTION BEFORE COMMENCEMENT OF ANY CONSTRUCTION.  
 ANY REVISIONS OR CHANGES, NOT RELATED TO THE CORRECTION OF ERRORS THAT ARE MADE AFTER THE FINAL PLANS HAVE BEEN COMPLETED SHALL BE SUBJECT TO ADDITIONAL FEES.  
 IF ANY MODIFICATIONS ARE MADE TO THESE PLANS BY ANY OTHER PARTY OTHER THAN THE DRAFTER'S OFFICE, THE DRAFTER SHALL NOT BE HELD RESPONSIBLE.

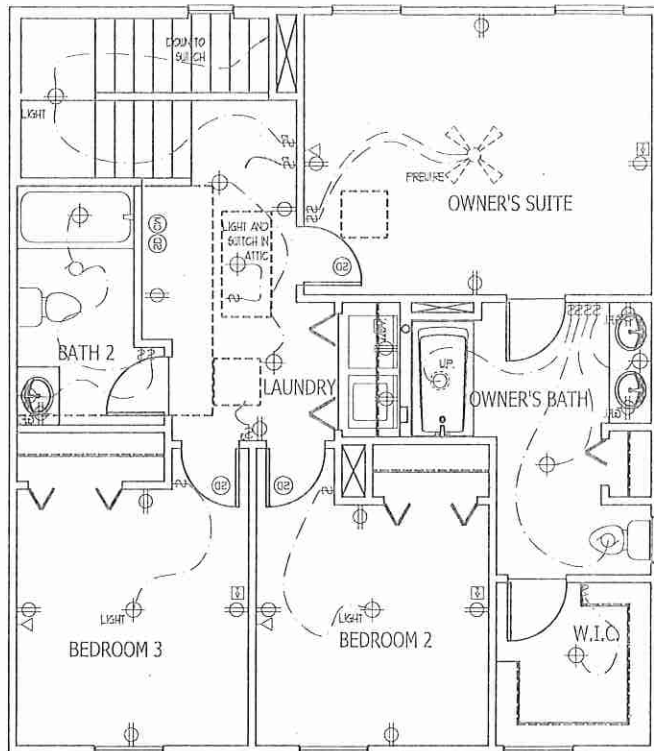

UPPER FLOOR PLAN-A  
SCALE: 1/4" = 1'-0"

*See Draw. B*



JOB NUMBER	00000.00
CAD FILE NAME	VISION-R
ISSUED	09-18-17
REVISED	08-19-18

DRAWINGS ON 11"x17" SHEET ARE ONE HALF THE SCALE NOTED

VISION  
H&H HOMES

1514

TITLE  
UPPER FLOOR ELEC. PLAN

SHEET  
E2

UPPER FLOOR ELECTRICAL PLAN  
GARAGE LEFT

SCALE NOTE:  
 LARGE FORMAT PRINTS ARE TO SCALE AS NOTED.  
 11" x 17" PRINTS ARE ONE HALF THE NOTED SCALE

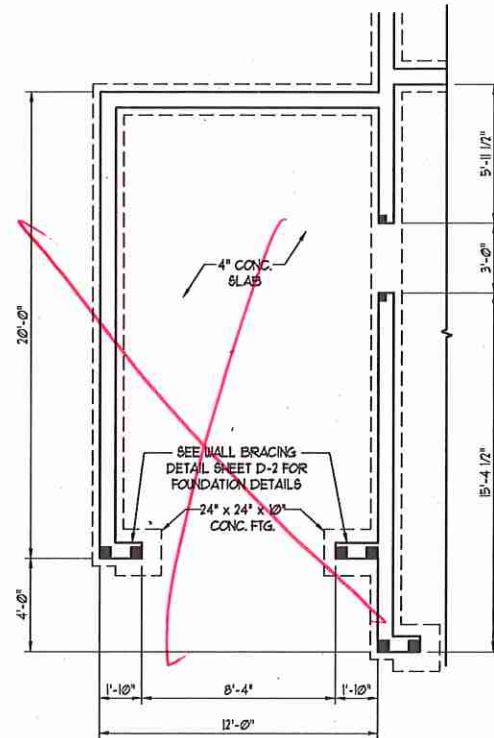

OPTIONAL THIRD CAR GARAGE

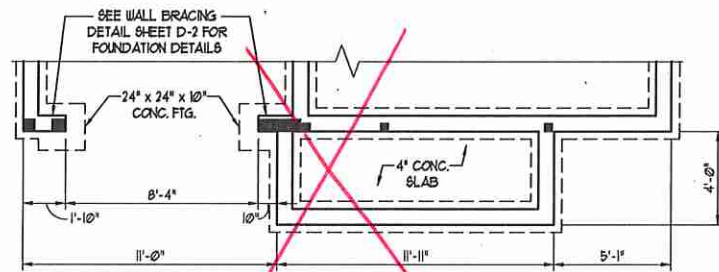

ELEVATION "C"

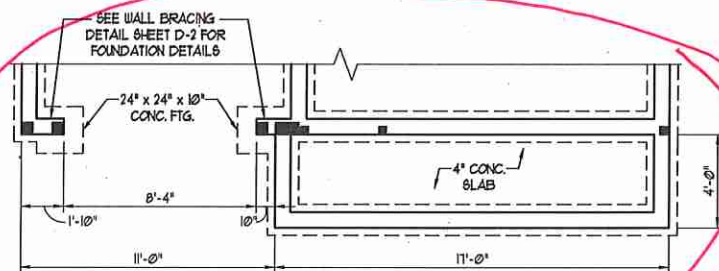

ELEVATION "B"

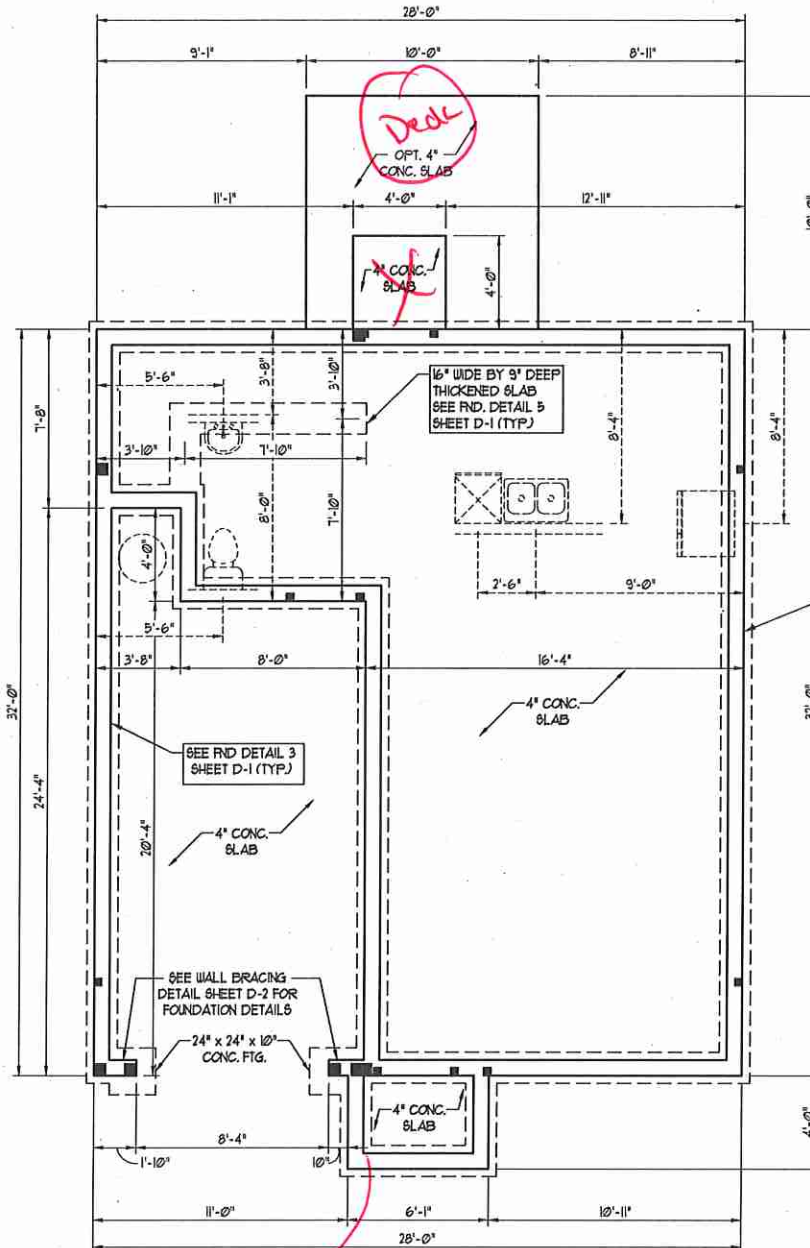

ELEVATION "A" See B elev.

- 150 MPH ULTIMATE DESIGN WIND SPEED NOTES FOR LESS THAN 30' MEAN ROOF HEIGHT:
- ENGINEER'S SEAL APPLIES ONLY TO STRUCTURAL COMPONENTS. ENGINEER'S SEAL DOES NOT CERTIFY DIMENSIONAL ACCURACY OR ARCHITECTURAL LAYOUT INCLUDING ROOF SYSTEM.
  - STRUCTURAL DESIGN PER NORTH CAROLINA RESIDENTIAL CODE, 2018 EDITION WITH SPECIAL CONSIDERATION TO CHAPTER 45 ("HIGH WIND ZONES" FOR 50 MPH WINDS).
  - BUILDER IS TO PROVIDE FRAMING CONNECTIONS AS REQUIRED BY CHAPTER 45 ("HIGH WIND ZONES" FOR 50 MPH WINDS) OF THE NORTH CAROLINA RESIDENTIAL CODE, 2018 EDITION.
  - FOUNDATION ANCHORAGE TO COMPLY WITH SECTION 4504 OF THE NORTH CAROLINA RESIDENTIAL CODE, 2018 EDITION.
  - MEAN ROOF HEIGHT IS LESS THAN 30 FEET.
  - WALL CLADDING DESIGNED FOR 0.43 PSF AND -0.37 PSF (-/- INDICATE POSITIVE / NEGATIVE PRESSURE (TYP)).
  - ROOF CLADDING DESIGNED FOR 0.22 PSF AND -0.18 PSF FOR ROOF PITCHES 1/2 TO 2/3 AND 0.44 PSF AND -0.31 PSF FOR ROOF PITCHES 2/3 TO 1/2.
  - 1/8" OSB SHEATHING IS REQUIRED ON ALL EXTERIOR WALLS.
  - WALLS TO BE BRACED IN ACCORDANCE WITH SECTION R6-07.10 OF THE NORTH CAROLINA RESIDENTIAL CODE, 2018 EDITION AND AS NOTED ON PLANS.
  - ENERGY EFFICIENCY COMPLIANCE AND INSULATION VALUES OF THE BUILDING TO BE IN ACCORDANCE WITH CHAPTER 11 OF THE NRC, 2018 EDITION.

- 120 MPH ULTIMATE DESIGN WIND SPEED NOTES FOR LESS THAN 30' MEAN ROOF HEIGHT:
- ENGINEER'S SEAL APPLIES ONLY TO STRUCTURAL COMPONENTS. ENGINEER'S SEAL DOES NOT CERTIFY DIMENSIONAL ACCURACY OR ARCHITECTURAL LAYOUT INCLUDING ROOF SYSTEM.
  - STRUCTURAL DESIGN PER NORTH CAROLINA RESIDENTIAL CODE, 2018 EDITION.
  - INSTALL 1/2" ANCHOR BOLTS 6'-0" O.C. AND WITHIN 1'-0" FROM END OF EACH CORNER. ANCHOR BOLTS MUST EXTEND A MINIMUM OF 1" INTO MASONRY OR CONCRETE. LOCATE BOLT WITHIN MIDDLE THIRD OF FLATE WIDTH.
  - MEAN ROOF HEIGHT IS LESS THAN 30 FEET.
  - EXTERIOR WALLS DESIGNED FOR 80 MPH WINDS.
  - WALL CLADDING DESIGNED FOR 0.5 PSF AND -0.20 PSF (-/- INDICATE POSITIVE / NEGATIVE PRESSURE (TYP)).
  - ROOF CLADDING DESIGNED FOR 0.42 PSF AND -0.18 PSF FOR ROOF PITCHES 1/2 TO 2/3 AND 0.40 PSF AND -0.30 PSF FOR ROOF PITCHES 2/3 TO 1/2.
  - INSTALL 1/8" OSB SHEATHING ON ALL EXTERIOR WALLS OF ALL STORES IN ACCORDANCE WITH SECTION R6-07.10.3 OF THE NRC, 2018 EDITION. SEE THE WALL BRACING NOTES AND DETAILS SHEET FOR MORE INFORMATION.
  - ENERGY EFFICIENCY COMPLIANCE AND INSULATION VALUES OF THE BUILDING TO BE IN ACCORDANCE WITH CHAPTER 11 OF THE NRC, 2018 EDITION.
  - REFER TO NOTES AND DETAIL SHEETS FOR ADDITIONAL STRUCTURAL INFORMATION.

**J.S. THOMPSON ENGINEERING, INC.**  
 608 WADE AVE., SUITE 104 RALEIGH, NC 27605  
 PHONE: (919) 786-9919 FAX: (919) 786-9921  
 N.C. LICENSE NO.: C1717

VISION  
 H & H HOMES



7/22/19

DATE: JULY 19, 2019  
 SCALE: 1/4" = 1'-0"  
 DRAWN BY: H & H HOMES, INC.  
 ENGINEERED BY: WFB

SHEET 3 OF 8  
 S-1c  
 STEEWALL SLAB  
 FOUNDATION PLAN



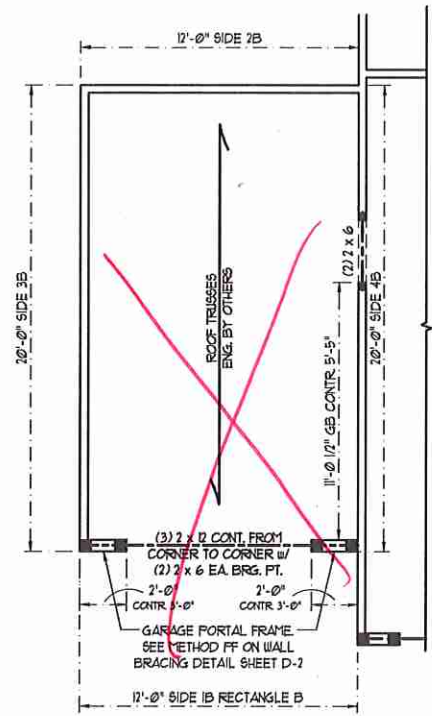

OPTIONAL THIRD CAR GARAGE

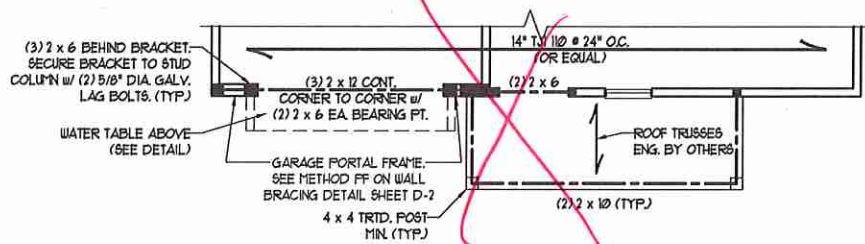

ELEVATION "C"

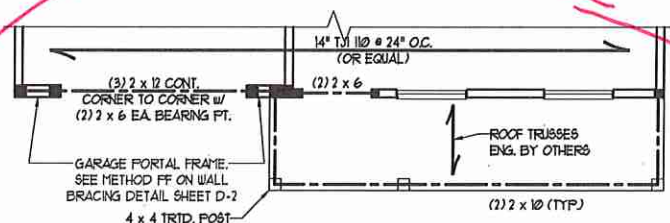

ELEVATION "B"

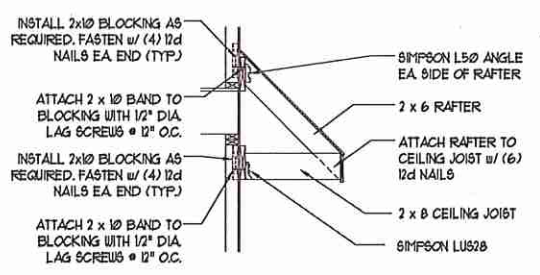

WATER TABLE DETAIL  
SCALE: NTS

**NOTE:** ALL FIRST FLOOR EXTERIOR WALLS ARE TO BE 2 x 4 @ 16" O.C. (UNO). 2 x 6 @ 16" O.C. FIRST FLOOR EXTERIOR WALLS MAY BE CONSTRUCTED IN LIEU OF 2 x 4 WALLS (UNO). ALL INTERIOR LOAD BEARING AND NON-LOAD BEARING WALLS ARE TO BE 2 x 4 SFF #2 @ 24" O.C. (UNO).

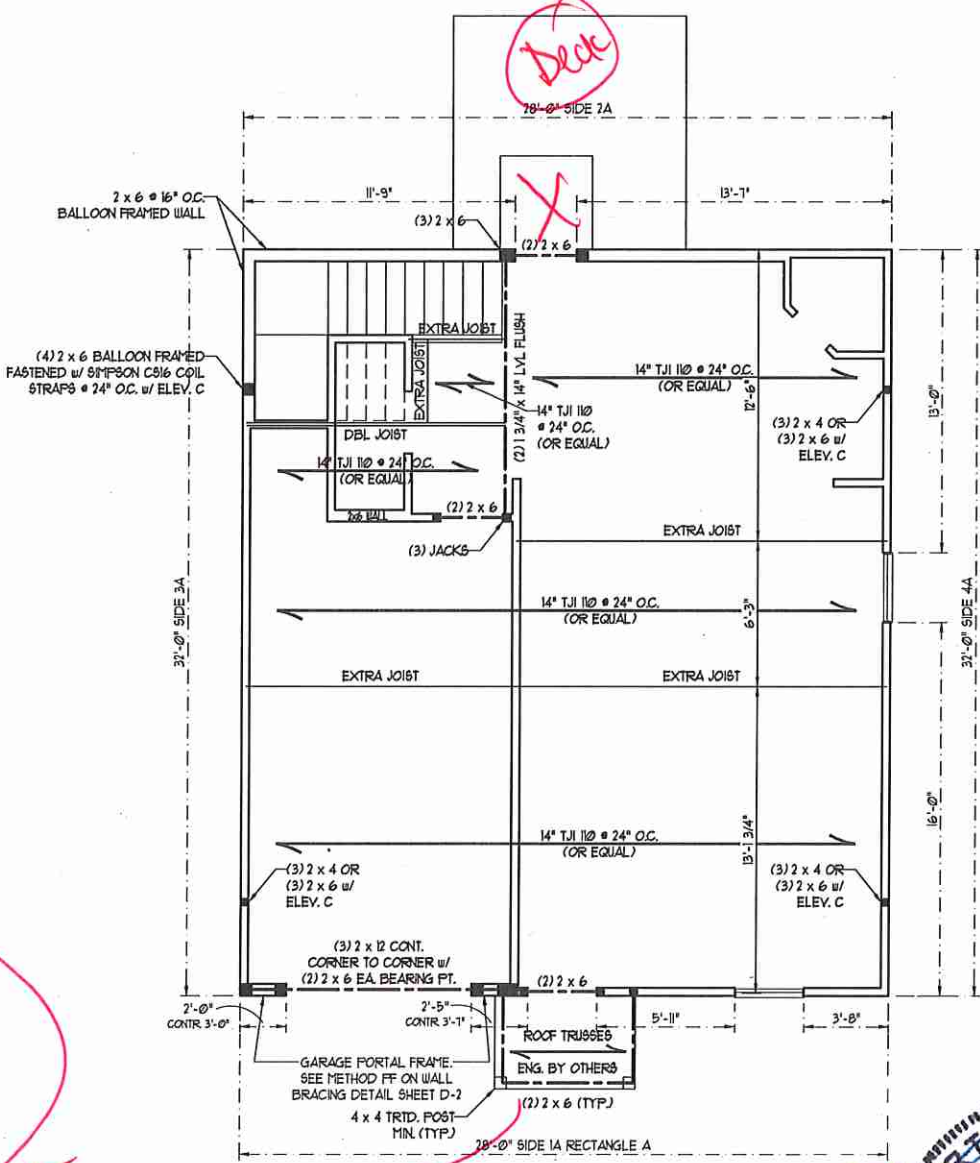

ELEVATION "A"

*See Elev. B*

**SCALE NOTE:**  
LARGE FORMAT PRINTS ARE TO SCALE AS NOTED.  
11" x 17" PRINTS ARE ONE HALF THE NOTED SCALE

- BRACED WALL DESIGN NOTES:**
- BRACED WALL DESIGN PER SECTION R60210 OF THE NCR 2018 EDITION.
  - C5-USP REFERS TO 'CONTINUOUS SHEATHING - WOOD STRUCTURAL PANELS' CONTRACTOR IS TO INSTALL 1/8" OSB ON ALL EXTERIOR WALLS ATTACHED w/ 8d NAILS SPACED 6" O.C. ALONG PANEL EDGES AND 12" O.C. IN THE FIELD.
  - GB REFERS TO 'GYPSUM BOARD' CONTRACTOR IS TO INSTALL 1/2" (MIN) GYPSUM WALL BOARD WHERE NOTED ON THE PLANS. FASTEN GB WITH 1 1/4" SCREWS OR 1 5/8" NAILS SPACED 1" O.C. ALONG PANEL EDGES AND IN THE FIELD INCLUDING TOP AND BOTTOM FLATES.
  - BRACED WALL DESIGN APPLIED IN WIND ZONES UP TO 120 MPH. FOR HIGH WIND ZONES, BRACE WALLS ARE TO BE CONSTRUCTED IN ACCORDANCE WITH CHAPTER 45 OF THE NCR 2018 EDITION.
  - SEE NOTES AND DETAIL SHEETS FOR ADDITIONAL BRACED WALL INFORMATION.

**BRACED WALL DESIGN**

RECTANGLE A		RECTANGLE B	
SIDE 1A METHOD: C5-USP/FF TOTAL REQUIRED LENGTH: 11' TOTAL PROVIDED LENGTH: 16.1'	SIDE 1B METHOD: C5-USP/FF TOTAL REQUIRED LENGTH: 3.8' TOTAL PROVIDED LENGTH: 6.0'	SIDE 2A METHOD: C5-USP TOTAL REQUIRED LENGTH: 11' TOTAL PROVIDED LENGTH: 7.53'	SIDE 2B METHOD: C5-USP TOTAL REQUIRED LENGTH: 3.8' TOTAL PROVIDED LENGTH: 12.0'
SIDE 3A 1 1/2 B COMBINED METHOD: C5-USP TOTAL REQUIRED LENGTH: 9.88' TOTAL PROVIDED LENGTH: 32.0'	SIDE 3B METHOD: C5-USP TOTAL REQUIRED LENGTH: 0.36' TOTAL PROVIDED LENGTH: 2.00'	SIDE 4A METHOD: C5-USP TOTAL REQUIRED LENGTH: 9.88' TOTAL PROVIDED LENGTH: 29.0'	SIDE 4B 1 3/4 COMBINED METHOD: C5-USP/GB TOTAL REQUIRED LENGTH: 12.54' TOTAL PROVIDED LENGTH: 11.5'

- STRUCTURAL NOTES:**
- ALL FRAMING LUMBER TO BE SFF #2 (UNO). ALL TREATED LUMBER TO BE 5TP #2 (UNO).
  - ALL LOAD BEARING HEADERS TO BE (2) 2 x 6 (UNO).
  - INSTALL AN EXTRA JOIST UNDER WALLS PARALLEL TO FLOOR JOISTS WHERE NOTED ON THE PLANS.
  - WINDOW AND DOOR HEADERS TO BE SUPPORTED w/ (1) JACK STUD AND (1) KING STUD EA END (UNO). SEE TABLE R602.15 FOR ADDITIONAL KING STUD REQUIREMENTS.
  - SQUARES DENOTE POINT LOADS WHICH REQUIRE SOLID BLOCKING TO GIRDER OR FOUNDATION. ALL SQUARES TO BE (2) STUDS (UNO).
  - FOR HIGH WIND ZONES, ALL EXTERIOR WALLS TO BE SHEATHED WITH 1/8" OSB SHEATHING WITH JOINTS BLOCKED AND SECURED WITH 8d NAILS AT 3" O.C. ALONG EDGES AND 6" O.C. IN THE FIELD.
  - FOR HIGH WIND ZONES, SECURE ALL EXTERIOR WALL SHEATHING PANELS TO DOUBLE TOP PLATES, BANDS, JOISTS, AND GIRDERS WITH (2) ROWS OF 8d NAILS STAGGERED AT 3" O.C. PANELS SHALL EXTEND 12" BEYOND CONSTRUCTION JOINTS AND SHALL OVERLAP GIRDERS AND DOUBLE SILL PLATES THEIR FULL DEPTH.
  - ALL 4 x 4 POSTS SHALL BE ANCHORED TO SLABS w/ SIMPSON ABU44 POST BASES (OR EQUAL) AND 6 x 6 POSTS w/ ABU66 POST BASES (OR EQUAL) (UNO). ALL 4 x 4 AND 6 x 6 POSTS TO BE INSTALLED WITH 1000 LB CAPACITY UPLIFT CONNECTORS AT TOP (UNO).
  - FOR FIBERGLASS, ALUMINUM, OR COLUMN ENG. BY OTHERS, SECURE TO SLAB w/ (2) METAL ANGLES USING 2" CONC. SCREWS, FASTEN ANGLES TO COLLUMS w/ 1/4" THROUGH BOLTS w/ NUTS AND WASHERS. LOCATE ANGLES ON OPPOSITE SIDES OF COLUMN. THROUGH BOLTS MUST BE INSTALLED PRIOR TO SETTING COLUMN.
  - REFER TO NOTES AND DETAIL SHEETS FOR ADDITIONAL STRUCTURAL INFORMATION.

TABLE R602.15  
MINIMUM NUMBER OF FULL HEIGHT STUDS AT EACH END OF HEADERS IN EXTERIOR WALLS

HEADER SPAN (FEET)	MAXIMUM STUD SPACING (INCHES) (PER TABLE R602.3(5))	
	16	24
UP TO 3'	1	1
4'	2	1
8'	3	2
12'	5	3
16'	6	4



**J.S. THOMPSON ENGINEERING, INC.**  
608 WADE AVE., SUITE 104, RALEIGH, NC 27603  
PHONE: (919) 789-9919 FAX: (919) 789-9921  
N.C. LICENSE NO. 01717

VISION  
H & H HOMES

DATE: JULY 19, 2019  
SCALE: 1/4" = 1'-0"  
DRAWN BY: H & H HOMES, INC.  
ENGINEERED BY: WTB

SHEET 4 OF 8  
S-2  
SECOND FLOOR FRAMING PLAN

**NOTE:** ALL SECOND FLOOR EXTERIOR WALLS AND ATTIC WALLS ARE TO BE 2 x 4 SFF #2 @ 24" O.C. 2 x 6 SFF #2 @ 24" O.C. (UNO). SECOND FLOOR EXTERIOR WALLS MAY BE CONSTRUCTED IN LIEU OF 2 x 4 WALLS (UNO). ALL INTERIOR LOAD BEARING AND NON-LOAD BEARING WALLS ARE TO BE 2 x 4 SFF #2 @ 24" O.C. (UNO).

**SCALE NOTE:**  
LARGE FORMAT PRINTS ARE TO SCALE AS NOTED.  
11" x 17" PRINTS ARE ONE HALF THE NOTED SCALE

**BRACED WALL DESIGN NOTES:**

- BRACED WALL DESIGN PER SECTION R60210 OF THE NRC 2018 EDITION.
- CS-16P REFERS TO "CONTINUOUS SHEATHING - WOOD STRUCTURAL PANELS" CONTRACTOR IS TO INSTALL 1/8" OSB ON ALL EXTERIOR WALLS ATTACHED w/ 8d NAILS SPACED 6" O.C. ALONG PANEL EDGES AND 12" O.C. IN THE FIELD.
- GB REFERS TO "GYPSUM BOARD" CONTRACTOR IS TO INSTALL 1/2" (MIN) GYPSUM WALL BOARD WHERE NOTED ON THE PLANS. FASTEN GB WITH 1 1/4" SCREWS OR 1 5/8" NAILS SPACED 1" O.C. ALONG PANEL EDGES AND IN THE FIELD INCLUDING TOP AND BOTTOM FLATES.
- BRACED WALL DESIGN APPLIED IN WIND ZONES UP TO 130 MPH. FOR HIGH WIND ZONES, BRACE WALLS ARE TO BE CONSTRUCTED IN ACCORDANCE WITH CHAPTER 45 OF THE NRC 2018 EDITION.
- SEE NOTES AND DETAIL SHEETS FOR ADDITIONAL BRACED WALL INFORMATION.

**NOTE:**

- PER SECTION R60210.32 OF THE 2018 NRC, THE AMOUNT OF BRACINGS ON THE SECOND FLOOR EXCEEDS THE AMOUNT REQUIRED FOR THE FIRST FLOOR AND NO BRACED WALL ANALYSIS IS REQUIRED.
- SHEATH ALL EXTERIOR WALLS WITH 1/8" OSB SHEATHING ATTACHED WITH 8d NAILS AT 6" O.C. ALONG PANEL EDGES AND 12" O.C. IN THE FIELD.

**STRUCTURAL NOTES:**

- ALL FRAMING LUMBER TO BE SFF #2 (UNO). ALL TREATED LUMBER TO BE SYP #2 (UNO).
- ALL LOAD BEARING HEADERS TO BE (2) 2 x 6 (UNO).
- WINDOW AND DOOR HEADERS TO BE SUPPORTED w/ (1) JACK STUD AND (1) KING STUD EA. END (UNO). SEE TABLE R602.15 FOR ADDITIONAL KING STUD REQUIREMENTS.
- SQUARES DENOTE POINT LOADS WHICH REQUIRE SOLID BLOCKING TO GIRDER OR FOUNDATION. ALL SQUARES TO BE (2) STUDS (UNO).
- FOR HIGH WIND ZONES, ALL EXTERIOR WALLS TO BE SHEATHED WITH 1/8" OSB SHEATHING WITH JOINTS BLOCKED AND SECURED WITH 8d NAILS AT 3" O.C. ALONG EDGES AND 6" O.C. IN THE FIELD.
- FOR HIGH WIND ZONES, SECURE ALL EXTERIOR WALL SHEATHING PANELS TO DOUBLE TOP PLATES, BANDS, JOISTS, AND GIRDERS WITH (2) ROWS OF 8d NAILS STAGGERED AT 3" O.C. PANELS SHALL EXTEND 12" BEYOND CONSTRUCTION JOINTS AND SHALL OVERLAP GIRDERS AND DOUBLE GILL PLATES THEIR FULL DEPTH. REFER TO NOTES AND DETAIL SHEETS FOR ADDITIONAL STRUCTURAL INFORMATION.

\*D&P\* INDICATES DOUBLE STUD POCKET BETWEEN WINDOW UNITS.

TABLE R602.15  
MINIMUM NUMBER OF FULL HEIGHT STUDS AT EACH END OF HEADERS IN EXTERIOR WALLS

HEADER SPAN (FEET)	MAXIMUM STUD SPACINGS (INCHES) (PER TABLE R602.3.5)	
	16	24
UP TO 3'	1	1
4'	2	1
8'	3	2
12'	5	3
16'	6	4

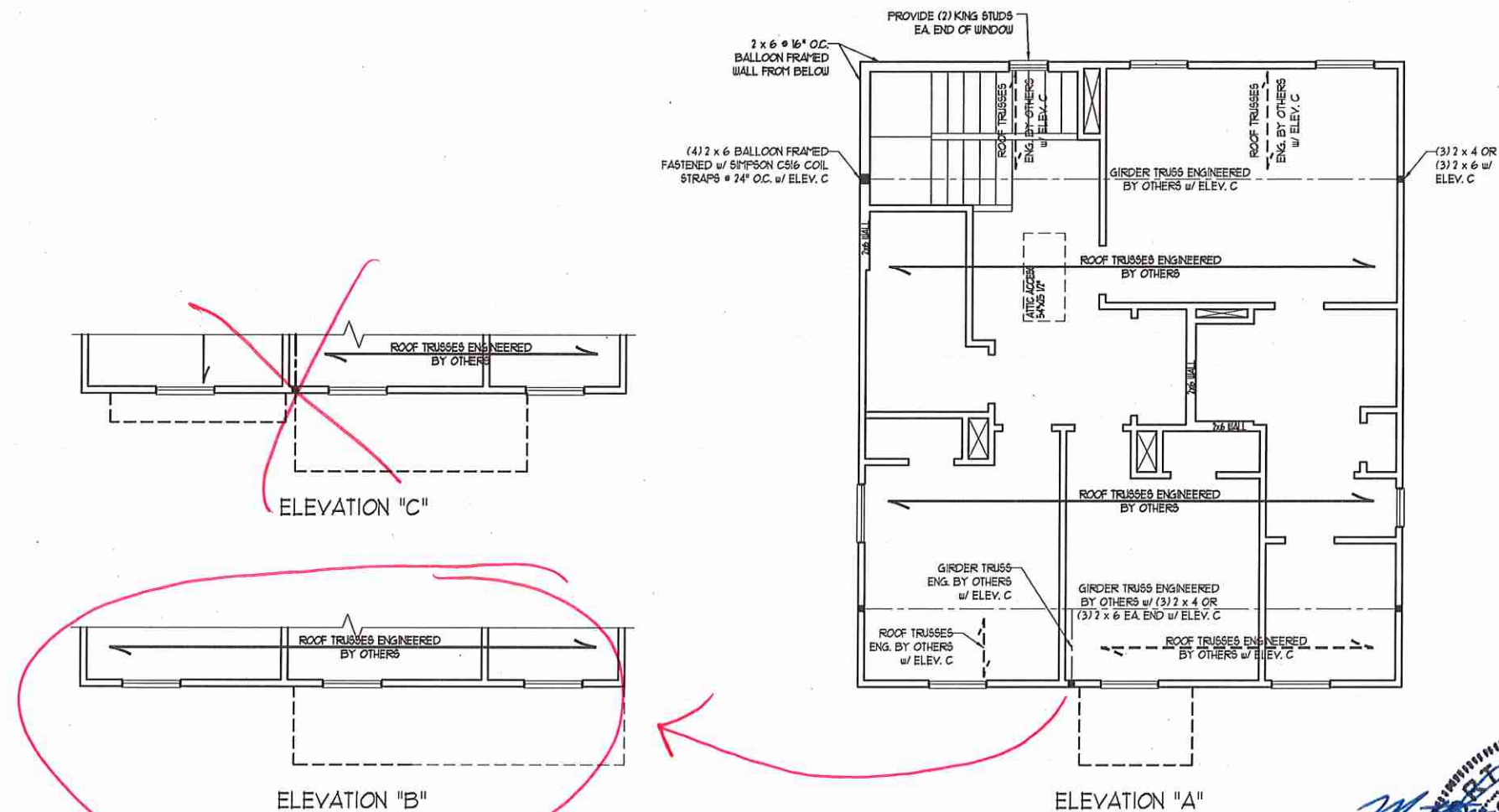

**J.S. THOMPSON ENGINEERING, INC.**  
100 WADE AVE., SUITE 104 RALEIGH, NC 27603  
PHONE: (919) 786-9919 FAX: (919) 786-9921  
N.C. LICENSE NO.: C-1713

VISION  
H & H HOMES

DATE: JULY 19, 2019

SCALE: 1/4" = 1'-0"

DRAWN BY: H & H HOMES, INC.

ENGINEERED BY: WFB

SHEET 5 OF 8

S-3  
CEILING FRAMING  
PLAN

SCALE NOTE:  
 LARGE FORMAT PRINTS ARE TO SCALE AS NOTED.  
 11" x 17" PRINTS ARE ONE HALF THE NOTED SCALE

ATTIC VENT CALCULATION:  
 921 SQ. FT. OF ATTIC DIVIDED BY  
 150 REQUIRES 61 SQ. FT. OF NET  
 FREE VENTILATING AREA (MIN).

- STRUCTURAL NOTES:
1. ALL FRAMING LUMBER TO BE #2 SFF (INO).
  2. CIRCLES DENOTE (3) 2 x 4 POSTS FOR ROOF SUPPORT.
  3. FRAME DORMER WALLS ON TOP OF DOUBLE OR TRIPLE RAFTERS.
  4. HIP SPLICES ARE TO BE SPACED A MIN. OF 8'-0". FASTEN MEMBERS WITH THREE ROWS OF 12d NAILS @ 16" O.C. (TYP.)
  5. STICK FRAME OVER-FRAMED ROOF SECTIONS W/ 2 x 8 RIDGES, 2 x 6 RAFTERS @ 16" O.C. AND FLAT 2 x 12 VALLEYS OR USE VALLEY TRUSSES.
  6. FASTEN FLAT VALLEYS TO RAFTERS OR TRUSSES WITH SIMPSON H25A HURRICANE TIES @ 32" O.C. MAX. PASS HURRICANE TIES THROUGH NOTCH IN ROOF SHEATHING. EACH RAFTER IS TO BE FASTENED TO THE FLAT VALLEY WITH A MIN. OF (6) 12d TOE NAILS.
  7. REFER TO SECTION R802.11 OF THE 2018 NRC FOR REQUIRED UPLIFT RESISTANCE AT RAFTERS AND TRUSSES.
  8. REFER TO NOTES AND DETAIL SHEETS FOR ADDITIONAL STRUCTURAL INFORMATION.

**J.S. THOMPSON  
 ENGINEERING, INC.**  
 606 WADE AVE., SUITE 104 RALEIGH, NC 27605  
 PHONE: (919) 789-9919 FAX: (919) 789-9921  
 N.C. LICENSE NO.: C1713

VISION  
 H & H HOMES

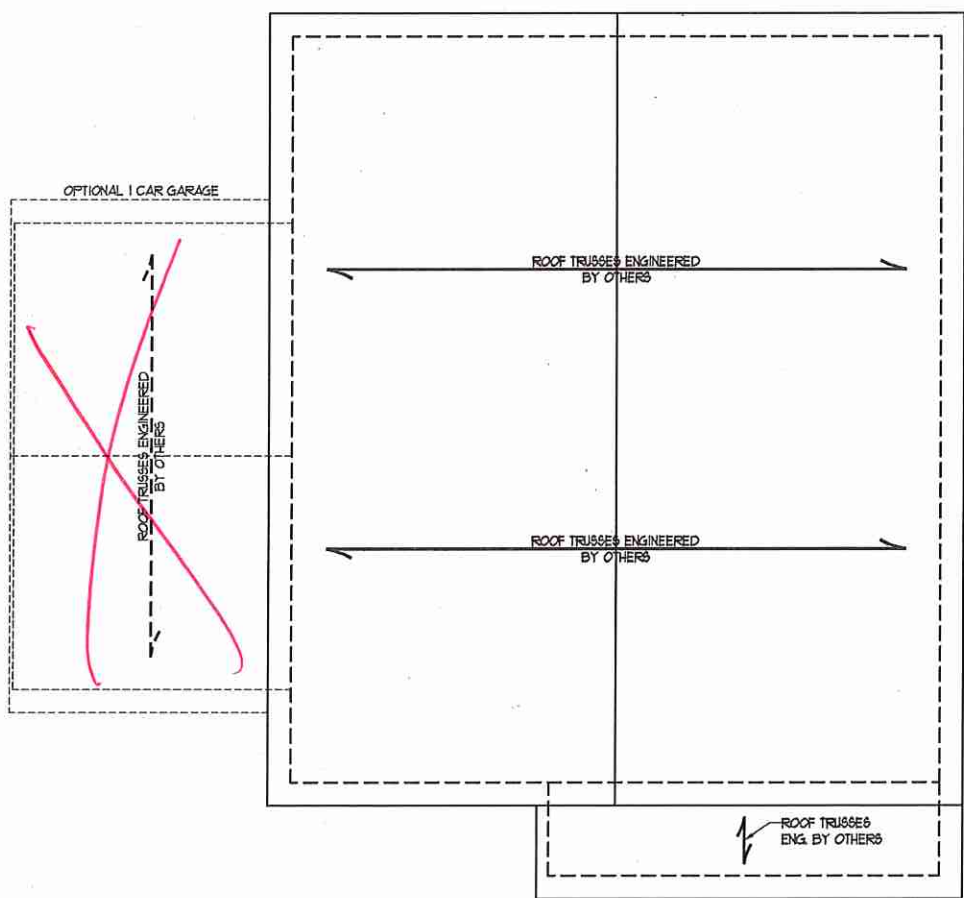

ELEVATION "B" - MODERN

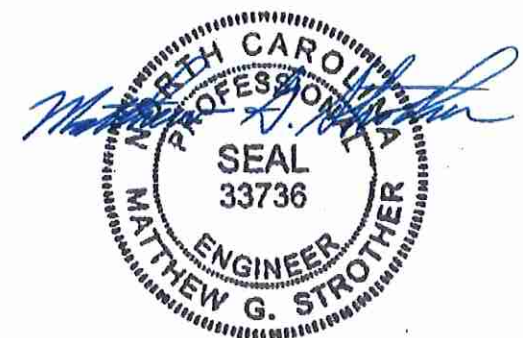

7/22/19

DATE: JULY 19, 2019  
 SCALE: 1/4" = 1'-0"  
 DRAWN BY: H & H HOMES, INC.  
 ENGINEERED BY: WFB

SHEET 7 OF 8  
 S-4b  
 ROOF FRAMING  
 PLAN

MONOLITHIC SLAB DETAILS

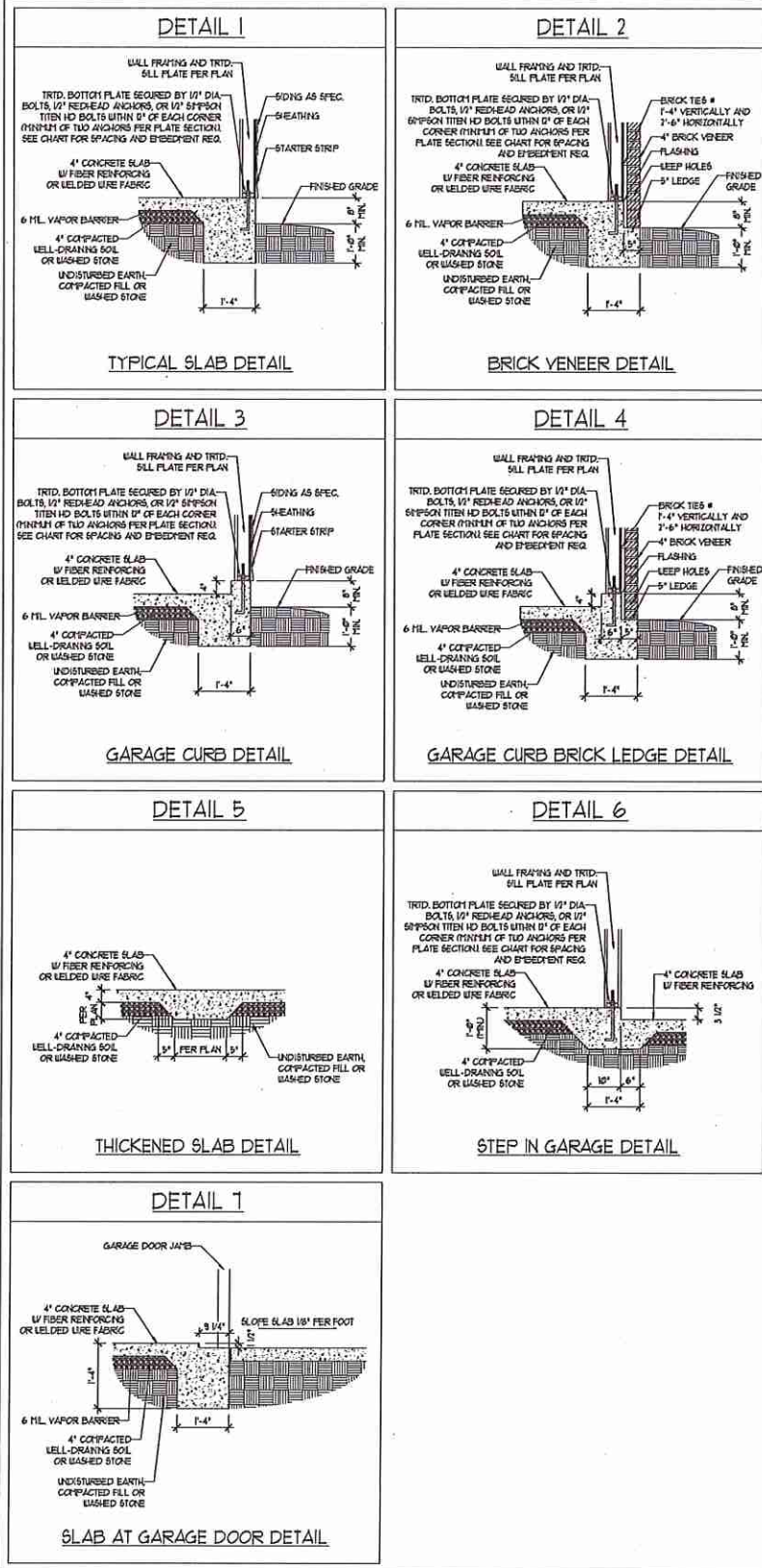

STEMWALL DETAILS

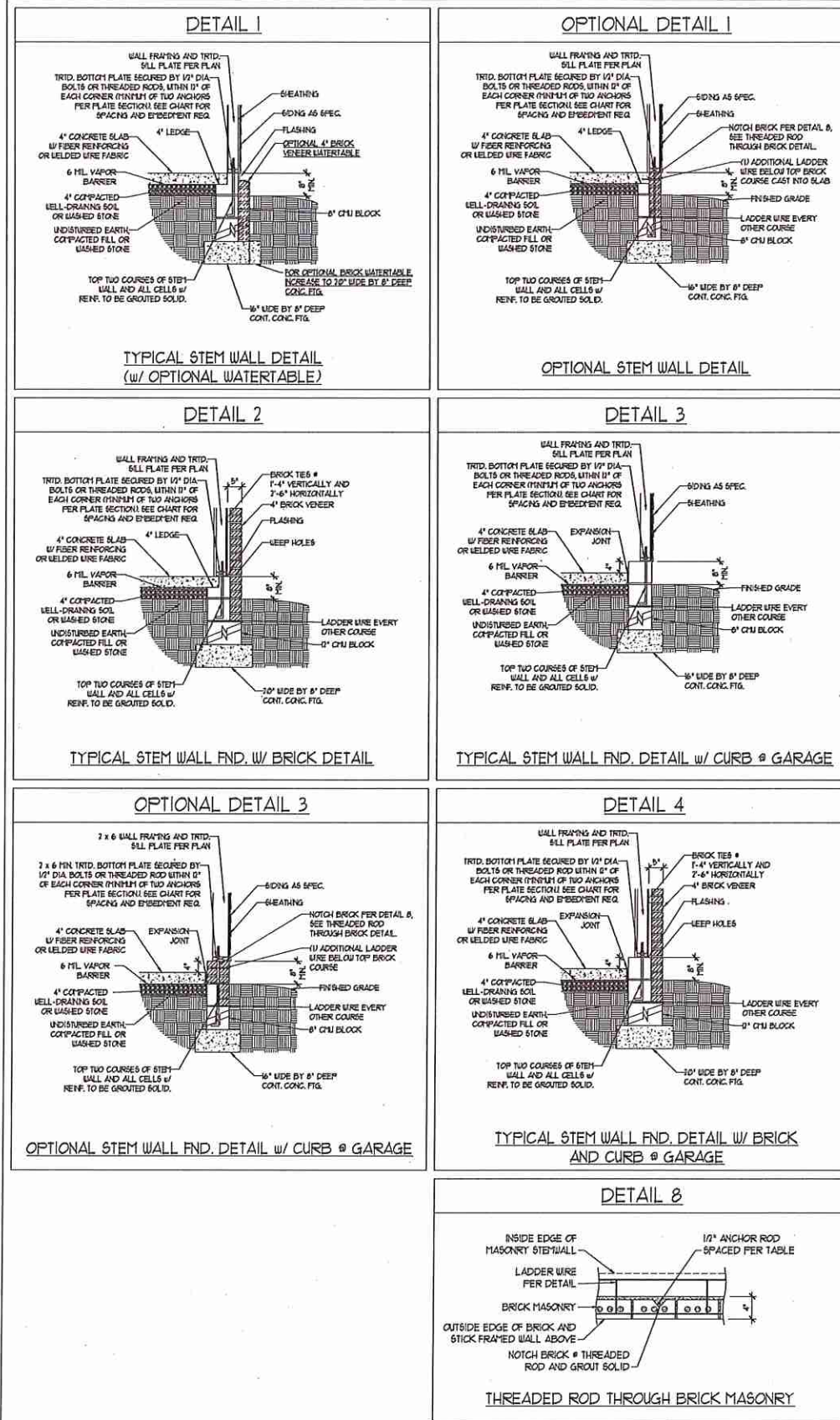

MASONRY STEMWALL SPECIFICATIONS

WALL HEIGHT (FEET)	MASONRY WALL TYPE			
	8" CMU	4" BRICK AND 4" CMU	4" BRICK AND 8" CMU	12" CMU
2 AND BELOW	UNGROUTED	GROUT SOLID	UNGROUTED	UNGROUTED
3	UNGROUTED	GROUT SOLID	UNGROUTED	UNGROUTED
4	GROUT SOLID	GROUT SOLID w/ #4 REBAR @ 48" O.C.	GROUT SOLID	GROUT SOLID w/ #4 REBAR @ 64" O.C.
5	GROUT SOLID w/ #4 REBAR @ 36" O.C.	NOT APPLICABLE	GROUT SOLID w/ #4 REBAR @ 36" O.C.	GROUT SOLID w/ #4 REBAR @ 64" O.C.
6	GROUT SOLID w/ #4 REBAR @ 24" O.C.	NOT APPLICABLE	GROUT SOLID w/ #4 REBAR @ 24" O.C.	GROUT SOLID w/ #4 REBAR @ 64" O.C.
7 AND GREATER	ENGINEERED DESIGN BASED ON SITE CONDITIONS			

STRUCTURAL NOTES:

- WALL HEIGHT MEASURED FROM TOP OF FOOTING TO TOP OF THE WALL.
- THE #4 REBAR WITHES TOGETHER WITH LADDER WIRE AT 16" O.C. VERTICALLY.
- CHART APPLICABLE FOR HOUSE FOUNDATION ONLY, CONSULT ENGINEER FOR DESIGN OF GARAGE FOUNDATION NOT COMMON TO HOUSE.
- BACKFILL OF CLEAN #1 / #1 WASHED STONE IS ALLOWABLE.
- BACKFILL OF WELL DRAINED OR SAND - GRAVEL MIXTURE SOLID (45 POUNDS PER CUBIC FOOT BELOW GRADE) CLASSIFIED AS GROUP 1 ACCORDING TO UNIFIED SOILS CLASSIFICATION SYSTEM IN ACCORDANCE WITH TABLE 2002.1 OF THE 2018 INTERNATIONAL RESIDENTIAL CODE ARE ALLOWABLE.
- PREP SLABS PER RS&S 2.1 AND RS&S 2.2 BASE OF THE 2018 INTERNATIONAL RESIDENTIAL CODE. MINIMUM 2" LAP SPlice LENGTH.
- LOCATE REBAR IN CENTER OF FOUNDATION WALL.
- WHERE REQUIRED, FILL BLOCK SOLID WITH TYPE "S" MORTAR OR 3000 PSI GROUT. USE OF "LOW LIFT GROUTING" METHOD REQUIRED WHEN FILLING WALLS WITH GROUT AT HEIGHTS OF 5' AND GREATER.

ANCHOR SPACING AND EMBEDMENT

WIND ZONE	120 MPH	130 MPH
SPACING	6'-0" O.C.	4'-0" O.C.
EMBEDMENT	1'	5" INTO MASONRY 1" INTO CONCRETE



**J.S. THOMPSON ENGINEERING, INC.**  
608 WADE AVE., SUITE 104 RALEIGH, NC 27603  
PHONE: (919) 789-9919 FAX: (919) 789-9921  
N.C. LICENSE NO.: C-1171

120 MPH - 130 MPH ULTIMATE DESIGN WIND SPEED  
FOUNDATION DETAILS

DATE: NOVEMBER 14, 2018  
SCALE: NTS  
DRAWN BY: JST  
ENGINEERED BY: JES

D-1  
FOUNDATION DETAILS

**GENERAL WALL BRACING NOTES:**

1. WALL BRACING DESIGNED IN ACCORDANCE WITH CHAPTER 6 OF THE 2018 NC RESIDENTIAL BUILDING CODE (NCRBC). TABLES AND FIGURES REFERENCED ARE FROM THE 2018 NCRBC.
2. SEE THIS SHEET FOR GENERAL DETAILS. REFER TO THE 2018 NCRBC FOR ADDITIONAL INFORMATION AS NEEDED.
3. BRACED EXTERIOR WALLS SUPPORTING ROOF TRUSSES AND RAFTERS, INCLUDING STORIES BELOW THE TOP FLOOR HAVE BEEN DESIGNED PER R602.3.5 (3). WALL SHEATHING AND FASTENERS HAVE BEEN DESIGNED TO RESIST COMBINED UPLIFT AND SHEAR FORCES IN ACCORDANCE WITH ACCEPTED ENGINEERING PRACTICE.
4. SEE STRUCTURAL SHEETS FOR BRACED WALL LOCATIONS, DIMENSIONS, HOLD DOWN TYPE AND LOCATIONS, BRACED WALL LINE KEY WITH WALL DESIGN SUMMARY OF REQUIRED/PROVIDED TOTALS FOR EACH WALL LINE AND ANY SPECIAL NOTES OR REQUIREMENTS.
5. ALL EXTERIOR WALLS ARE TO BE SHEATHED WITH CS-USP IN ACCORDANCE WITH SECTION R602.10.3 UNLESS NOTED OTHERWISE.
6. ALL EXTERIOR AND INTERIOR WALLS TO HAVE 1/2" GYPSUM INSTALLED. WHEN NOT USING METHOD "GB", GYPSUM TO BE FASTENED PER TABLE R102.3.5. METHOD GB TO BE FASTENED PER TABLE R602.10.1.
7. CS-USP REFERS TO THE "CONTINUOUS SHEATHING - WOOD STRUCTURAL PANELS" WALL BRACING METHOD. 7/16" OSB SHEATHING IS TO BE INSTALLED ON ALL EXTERIOR WALLS ATTACHED W/ 6d COMMON NAILS OR 8d (2 1/2" LONG x 0.131" DIAMETER) NAILS SPACED 6" O.C. ALONG PANEL EDGES AND 12" O.C. IN THE FIELD (UNO).
8. GB REFERS TO THE "GYPSUM BOARD" WALL BRACING METHOD. 1/2" (MIN) GYPSUM WALL BOARD IS TO BE INSTALLED ON BOTH SIDES OF THE BRACED WALL FASTENED WITH 1 1/4" SCREWS OR 1 5/8" NAILS SPACED 1" O.C. ALONG PANEL EDGES INCLUDING TOP AND BOTTOM PLATES AND INTERMEDIATE SUPPORTS (UNO). VERIFY ALL FASTENER OPTIONS FOR 1/2" AND 5/8" GYPSUM PRIOR TO CONSTRUCTION. FOR INTERIOR FASTENER OPTIONS SEE TABLE R102.3.5. FOR EXTERIOR FASTENER OPTIONS SEE TABLE R602.3(1). EXTERIOR GB TO BE INSTALLED VERTICALLY.
9. REQUIRED BRACED WALL LENGTH FOR EACH SIDE OF THE CIRCUMSCRIBED RECTANGLE ARE INTERPOLATED PER TABLE R602.10.3. METHOD CS-USP CONTRIBUTES ITS ACTUAL LENGTH, METHOD GB CONTRIBUTES 5 ITS ACTUAL LENGTH, AND METHOD PF CONTRIBUTES 15 TIMES ITS ACTUAL LENGTH.

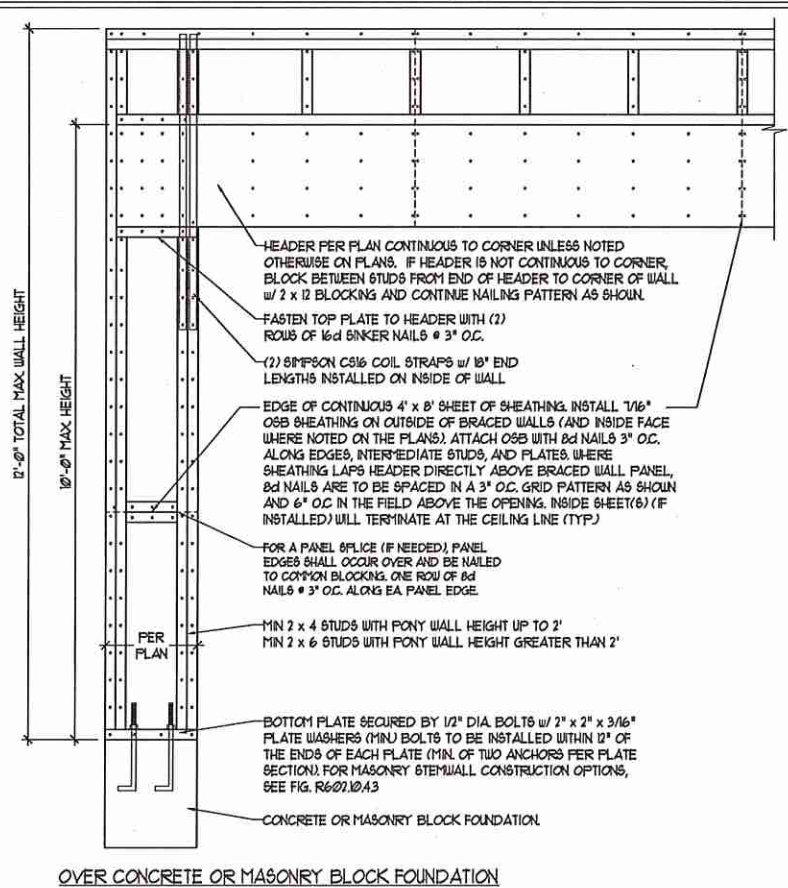

**METHOD PF-PORTAL FRAME DETAIL ①**

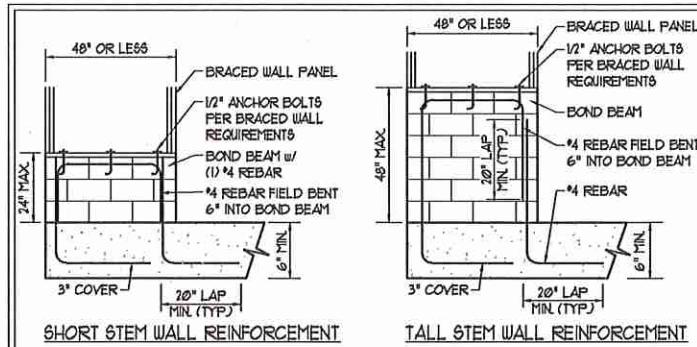

**SHORT STEM WALL REINFORCEMENT**

**TALL STEM WALL REINFORCEMENT**

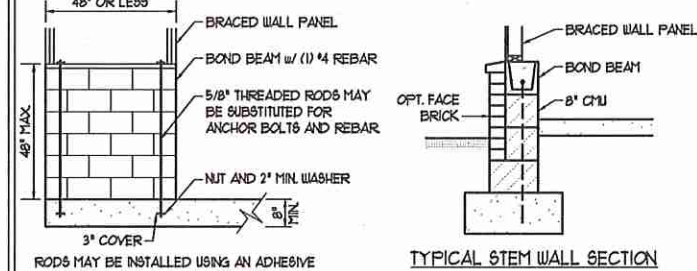

**TYPICAL STEM WALL SECTION**

**OPTIONAL STEM WALL REINFORCEMENT**

**NOTE: GROUT BOND BEAMS AND ALL CELLS WHICH CONTAIN REBAR, THREADED RODS AND ANCHOR BOLTS MASONRY STEM WALLS SUPPORTING BRACED WALL PANELS ②**  
PER FIGURE R602.10.4.3

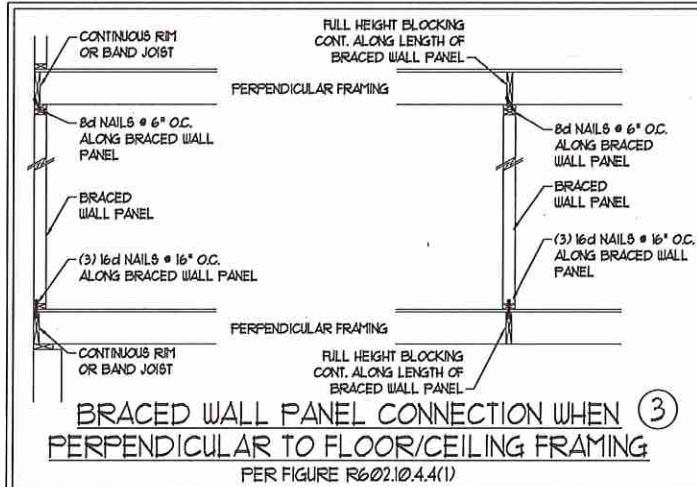

**BRACED WALL PANEL CONNECTION WHEN PERPENDICULAR TO FLOOR/CEILING FRAMING ③**  
PER FIGURE R602.10.4.4(1)

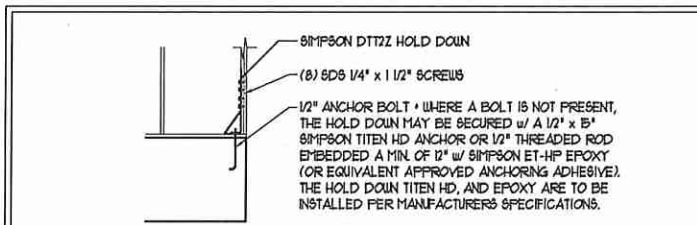

**HOLD DOWN DETAIL FOR MASONRY FOUNDATION OR MONOLITHIC SLAB ④**  
\* APPLICABLE ONLY WHERE SPECIFIED ON PLAN \*

**TYPICAL EXTERIOR CORNER FRAMING FOR CONTINUOUS SHEATHING ⑤**

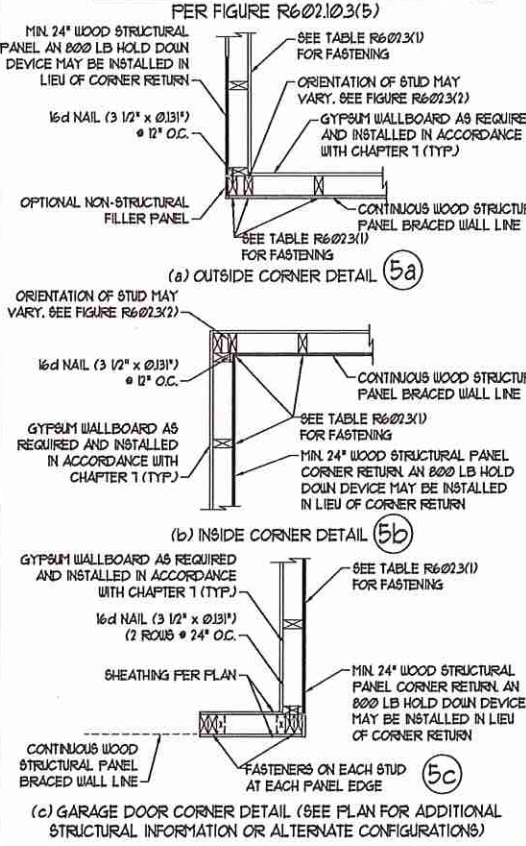

**BRACED WALL PANEL CONNECTION WHEN PARALLEL TO FLOOR/CEILING FRAMING ⑥**

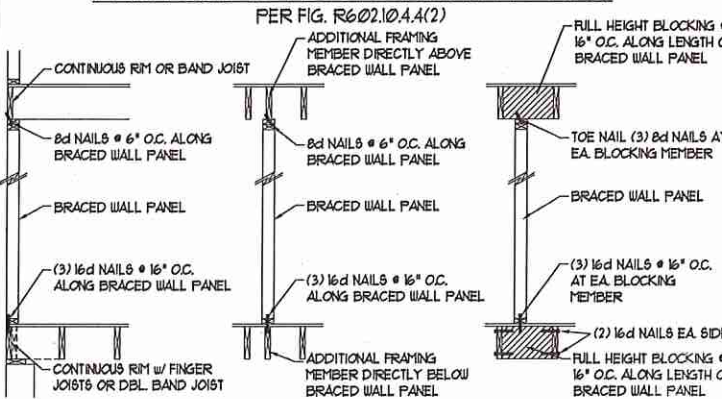

**SCALE NOTE:**  
LARGE FORMAT PRINTS ARE TO SCALE AS NOTED.  
11\"/>

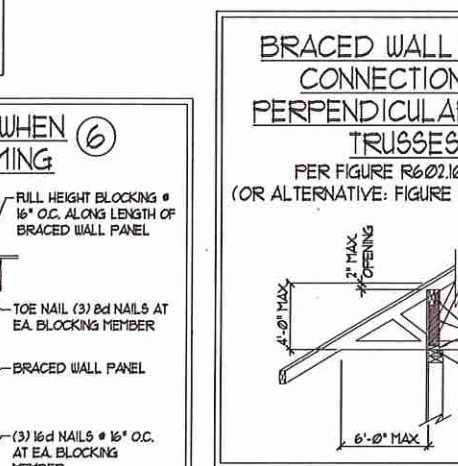
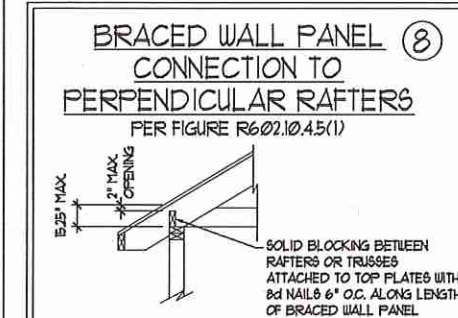
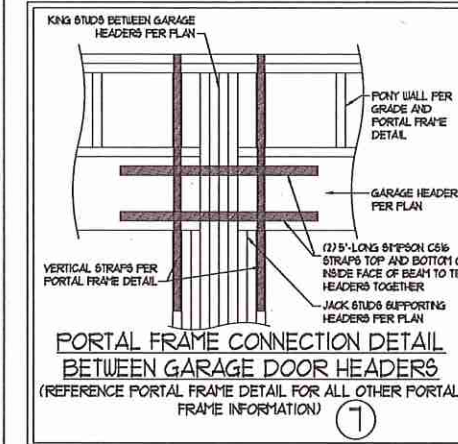

**SEAL**  
33736  
**ENGINEER**  
**MATTHEW G. STROTHER**

**J.S. THOMPSON ENGINEERING, INC.**  
608 WADE AVE., SUITE 104 RALEIGH, NC 27605  
PHONE: (919) 789-9119 FAX: (919) 789-9921  
N.C. LICENSE NO.: C-1173

120 MPH - 130 MPH ULTIMATE DESIGN WIND SPEED  
WALL BRACING NOTES AND DETAILS

DATE: OCTOBER 30, 2018  
SCALE: 1/4\"/>

D-2  
BRACED WALL NOTES AND DETAILS AND PF DETAILS

7/22/19

This sealed page is to be used in conjunction with a full plan set engineered by J.S. Thompson Engineering, Inc. only. Use of this individual sealed page within architectural pages or shop drawings by others is a punishable offense under N.C. Statute § 89C-23

SCALE NOTE:  
LARGE FORMAT PRINTS ARE TO SCALE AS NOTED.  
11" x 17" PRINTS ARE ONE HALF THE NOTED SCALE

GENERAL NOTES

- ENGINEER'S SEAL APPLIES ONLY TO STRUCTURAL COMPONENTS INCLUDING ROOF RAFTERS, HIPS, VALLEYS, RIDGES, FLOORS, WALLS, BEAMS, HEADERS, COLUMNS, CANTILEVERS, OFFSET LOAD BEARING WALLS, PIERS, GIRDER SYSTEM AND FOOTING. ENGINEER'S SEAL DOES NOT CERTIFY DIMENSIONAL ACCURACY OF ARCHITECTURAL LAYOUT INCLUDING ROOF. ENGINEER'S SEAL DOES NOT APPLY TO I-JOIST OR FLOOR/ROOF TRUSS LAYOUT DESIGN AND ACCURACY.
- ALL CONSTRUCTION SHALL CONFORM TO THE LATEST REQUIREMENTS OF THE NORTH CAROLINA RESIDENTIAL CODE (NCRC) 2018 EDITION PLUS ALL LOCAL CODES AND REGULATIONS. THE STRUCTURAL ENGINEER IS NOT RESPONSIBLE FOR, AND WILL NOT HAVE CONTROL OF, CONSTRUCTION MEANS, METHODS, TECHNIQUES, SEQUENCES OR PROCEDURES, OR SAFETY PRECAUTIONS AND PROGRAMS IN CONNECTION WITH THE CONSTRUCTION WORK. NOR WILL THE ENGINEER BE RESPONSIBLE FOR THE CONTRACTOR'S FAILURE TO CARRY OUT THE CONSTRUCTION WORK IN ACCORDANCE WITH THE CONTRACT DOCUMENTS.
- STRUCTURAL DESIGN BASED ON THE PROVISIONS OF THE NCRC, 2018 EDITION (R301.4 - R301.1)

DESIGN CRITERIA:	LIVE LOAD (PSF)	DEAD LOAD (PSF)	DEFLECTION (IN)
ATTIC WITH LIMITED STORAGE	20	10	L/240 (L/360 w/ BRITTLE FINISHES)
ATTIC WITHOUT STORAGE	10	10	L/360
DECKS	40	10	L/360
EXTERIOR BALCONIES	40	10	L/360
FIRE ESCAPES	40	10	L/360
HANDRAILS/GUARDRAILS	200 LB OR 50 (PLF)	10	L/360
PASSENGER VEHICLE GARAGE	50	10	L/360
ROOMS OTHER THAN SLEEPING ROOM	40	10	L/360
SLEEPING ROOMS	30	10	L/360
STAIRS	40	10	L/360
WIND LOAD	(BASED ON TABLE R301.2(4) WIND ZONE AND EXPOSURE)		
GROUND SNOW LOAD: Pg	20 (PSF)		

- I-JOIST SYSTEMS DESIGNED WITH 12 PSF DEAD LOAD AND DEFLECTION (IN) OF L/480
  - FLOOR TRUSS SYSTEMS DESIGNED WITH 15 PSF DEAD LOAD
- FOR 15 AND 100 MPH WIND ZONES, FOUNDATION ANCHORAGE IS TO COMPLY WITH SECTION R403.16 OF THE NCRC, 2018 EDITION. FOR 130 MPH, 140 MPH, AND 150 MPH WIND ZONES, FOUNDATION ANCHORAGE IS TO COMPLY WITH SECTION 450.4 OF THE NCRC, 2018 EDITION.
  - ENERGY EFFICIENCY COMPLIANCE AND INSULATION VALUES OF THE BUILDING TO BE IN ACCORDANCE WITH CHAPTER 11 OF THE NCRC, 2018 EDITION.

FOOTING AND FOUNDATION NOTES

- FOUNDATION DESIGN BASED ON A MINIMUM ALLOWABLE BEARING CAPACITY OF 2000 PSF. CONTACT GEOTECHNICAL ENGINEER IF BEARING CAPACITY IS NOT ACHIEVED.
- FOR ALL CONCRETE SLABS AND FOOTINGS, THE AREA WITHIN THE PERIMETER OF THE BUILDING ENVELOPE SHALL HAVE ALL VEGETATION, TOP SOIL, AND FOREIGN MATERIAL REMOVED. FILL MATERIAL SHALL BE FREE OF VEGETATION AND FOREIGN MATERIAL. THE FILL SHALL BE COMPACTED TO ASSURE UNIFORM SUPPORT OF THE SLAB, AND EXCEPT WHERE APPROVED, THE FILL DEPTHS SHALL NOT EXCEED 24" FOR CLEAN SAND OR GRAVEL. A 4" THICK BASED COURSE CONSISTING OF CLEAN GRADED SAND OR GRAVEL SHALL BE PLACED. A BASE COURSE IS NOT REQUIRED WHERE A CONCRETE SLAB IS INSTALLED ON WELL-DRAINED OR SAND-GRAVEL MIXTURE SOILS CLASSIFIED AS GROUP 1, ACCORDING TO THE UNITED SOIL CLASSIFICATION SYSTEM IN ACCORDANCE WITH TABLE R405.1 OF THE NCRC, 2018 EDITION.
- PROPERLY DEWATER EXCAVATION PRIOR TO POURING CONCRETE WHEN BOTTOM OF CONCRETE SLAB IS AT OR BELOW WATER TABLE. IF APPLICABLE, 3/4" - 1" DEEP CONTROL JOINTS ARE TO BE SAWED WITHIN 4 TO 12 HOURS OF CONCRETE FINISHING AND WALL LOCATIONS HAVE BEEN MARKED. ADJUST WHERE NECESSARY.
- CONCRETE SHALL CONFORM TO SECTION R402.2 OF THE NCRC, 2018 EDITION. CONCRETE REINFORCING STEEL TO BE ASTM A615 GRADE 60. WELDED WIRE FABRIC TO BE ASTM A185. MAINTAIN A MINIMUM CONCRETE COVER AROUND REINFORCING STEEL OF 3" IN FOOTINGS AND 1 1/2" IN SLABS. FOR POURED CONCRETE WALLS, CONCRETE COVER FOR REINFORCING STEEL MEASURED FROM THE INSIDE FACE OF THE WALL SHALL NOT BE LESS THAN 3/4". CONCRETE COVER FOR REINFORCING STEEL MEASURED FROM THE OUTSIDE FACE OF THE WALL SHALL NOT BE LESS THAN 1 1/2" FOR #5 BARS OR SMALLER, AND NOT LESS THAN 2" FOR #6 BARS OR LARGER.
- MASONRY UNITS TO CONFORM TO ACE 530/ASCE 5/TMS 402. MORTAR SHALL CONFORM TO ASTM C710.
- THE UNSUPPORTED HEIGHT OF MASONRY PIERS SHALL NOT EXCEED FOUR TIMES THEIR LEAST DIMENSION FOR UNFILLED HOLLOW CONCRETE MASONRY UNITS AND TEN TIMES THEIR LEAST DIMENSION FOR SOLID OR SOLID FILLED PIERS. PIERS MAY BE FILLED SOLID WITH CONCRETE OR TYPE M OR S MORTAR. PIERS AND WALLS SHALL BE CAPPED WITH 8" OF SOLID MASONRY.
- THE CENTER OF EACH OF THE PIERS SHALL BEAR IN THE MIDDLE THIRD OF ITS RESPECTIVE FOOTING. EACH GIRDER SHALL BEAR IN THE MIDDLE THIRD OF THE PIERS.
- ALL CONCRETE AND MASONRY FOUNDATION WALLS ARE TO BE CONSTRUCTED IN ACCORDANCE WITH THE PROVISIONS OF SECTION R404 OF THE NCRC, 2018 EDITION OR IN ACCORDANCE WITH ACI 318, ACI 332, NCHA TR68-A OR ACE 530/ASCE 5/TMS 402. MASONRY FOUNDATION WALLS ARE TO BE REINFORCED PER TABLE R404.1(1), R404.1(2), R404.1(3), OR R404.1(4) OF THE NCRC, 2018 EDITION. CONCRETE FOUNDATION WALLS ARE TO BE REINFORCED PER TABLE R404.1(5) OF THE NCRC, 2018 EDITION. STEP CONCRETE FOUNDATION WALLS TO 2 x 6 FRAMED WALLS AT 16" O.C. WHERE GRADE PERMITS (UNO).

This sealed page is to be used in conjunction with a full plan set engineered by J.S. Thompson Engineering, Inc. only. Use of this individual sealed page within architectural pages or shop drawings by others is a punishable offense under N.C. Statute § 89C-23

FRAMING NOTES

- ALL FRAMING LUMBER SHALL BE #2 SFF MINIMUM (Fb = 875 PSI, Fv = 375 PSI, E = 1600000 PSI) UNLESS NOTED OTHERWISE (UNO). ALL TREATED LUMBER SHALL BE #2 SYP MINIMUM (Fb = 975 PSI, Fv = 175 PSI, E = 1600000 PSI) UNLESS NOTED OTHERWISE (UNO).
- LAMINATED VENEER LUMBER (LVL) SHALL HAVE THE FOLLOWING MINIMUM PROPERTIES: Fb = 2600 PSI, Fv = 205 PSI, E = 1300000 PSI. LAMINATED STRAND LUMBER (LSL) SHALL HAVE THE FOLLOWING MINIMUM PROPERTIES: Fb = 2325 PSI, Fv = 310 PSI, E = 1550000 PSI. PARALLEL STRAND LUMBER (PSL) UP TO 1" DEPTH SHALL HAVE THE FOLLOWING MINIMUM PROPERTIES: Fc = 2500 PSI, E = 1000000 PSI. PARALLEL STRAND LUMBER (PSL) MORE THAN 1" DEPTH SHALL HAVE THE FOLLOWING MINIMUM PROPERTIES: Fc = 2300 PSI, E = 1000000 PSI. INSTALL ALL CONNECTIONS PER MANUFACTURER'S SPECIFICATIONS.
- STRUCTURAL STEEL SHALL CONFORM TO THE FOLLOWING ASTM SPECIFICATIONS
 

A. W AND WT SHAPES:	ASTM A992
B. CHANNELS AND ANGLES:	ASTM A36
C. PLATES AND BARS:	ASTM A36
D. HOLLOW STRUCTURAL SECTIONS:	ASTM A500 GRADE B
E. STEEL PIPE:	ASTM A53, GRADE B, TYPE E OR S
- STEEL BEAMS SHALL BE SUPPORTED AT EACH END WITH A MINIMUM BEARING LENGTH OF 3 1/2" AND FULL FLANGE WIDTH (UNO). PROVIDE SOLID BEARING FROM BEAM SUPPORT TO FOUNDATION. BEAMS SHALL BE ATTACHED AT THE BOTTOM FLANGE TO EACH SUPPORT AS FOLLOWS (UNO):
 

A. WOOD FRAMING	(2) 1/2" DIA x 4" LONG LAG SCREWS
B. CONCRETE	(2) 1/2" DIA x 4" WEDGE ANCHORS
C. MASONRY (FULLY GROUTED)	(2) 1/2" DIA x 4" LONG SIMPSON TITEN HD ANCHORS

LATERAL SUPPORT IS CONSIDERED ADEQUATE PROVIDING THE JOISTS ARE TOE NAILED TO THE 2x NAILER ON TOP OF THE STEEL BEAM, AND THE 2x NAILER IS SECURED TO THE TOP OF THE STEEL BEAM w/ (2) ROWS OF SELF TAPPING SCREWS @ 16" O.C. OR (2) ROWS OF 1/2" DIAMETER BOLTS @ 16" O.C. IF 1/2" BOLTS ARE USED TO FASTEN THE NAILER, THE STEEL BEAM SHALL BE FABRICATED w/ (2) ROWS OF 3/16" DIAMETER HOLES @ 16" O.C.
- SQUARES DENOTE POINT LOADS WHICH REQUIRE SOLID BLOCKING TO GIRDER OR FOUNDATION. SHADED SQUARES DENOTE POINT LOADS FROM ABOVE WHICH REQUIRE SOLID BLOCKING TO SUPPORTING MEMBER BELOW.
- ALL LOAD BEARING HEADERS TO CONFORM TO TABLE R602.1(1) AND R602.1(2) OF THE NCRC, 2018 EDITION OR BE (2) 2 x 6 WITH (1) JACK AND (1) KING STUD EACH END (UNO), WHICHEVER IS GREATER. ALL HEADERS TO BE SECURED TO EACH JACK STUD WITH (4) 8d NAILS. ALL BEAMS TO BE SUPPORTED WITH (2) STUDS AT EACH BEARING POINT (UNO). INSTALL KING STUDS PER SECTION R602.15 OF THE NORTH CAROLINA RESIDENTIAL CODE, 2018 EDITION.
- ALL BEAMS, HEADERS, OR GIRDER TRUSSES PARALLEL TO WALL ARE TO BEAR FULLY ON (1) JACK OR (2) STUDS MINIMUM OR THE NUMBER OF JACKS OR STUDS NOTED. ALL BEAMS OR GIRDER TRUSSES PERPENDICULAR TO WALL AND SUPPORTED BY (3) STUDS OR LESS ARE TO HAVE 1 1/2" MINIMUM BEARING (UNO). ALL BEAMS OR GIRDER TRUSSES PERPENDICULAR TO WALL AND SUPPORTED BY MORE THAN (3) STUDS OR OTHER NOTED COLUMN ARE TO BEAR FULLY ON SUPPORT COLUMN FOR ENTIRE WALL DEPTH (UNO). BEAM ENDS THAT BUTT INTO ONE ANOTHER ARE TO EACH BEAR EQUAL LENGTHS (UNO).
- FLITCH BEAMS SHALL BE BOLTED TOGETHER USING 1/2" DIAMETER BOLTS (ASTM A307) WITH WASHERS PLACED AT THREADED END OF BOLT. BOLTS SHALL BE SPACED AT 24" CENTERS (MAXIMUM), AND STAGGERED AT TOP AND BOTTOM OF BEAM (2" EDGE DISTANCE), WITH (2) BOLTS LOCATED AT 6" FROM EACH END (UNO).
- ALL I-JOIST OR TRUSS LAYOUTS ARE TO BE IN COMPLIANCE WITH THE OVERALL DESIGN SPECIFIED ON THE PLANS. ALL DEVIATIONS ARE TO BE BROUGHT TO THE ATTENTION OF THE ENGINEER OF RECORD PRIOR TO INSTALLATION.
- BRACED WALL PANELS SHALL BE CONSTRUCTED ACCORDING TO THE NORTH CAROLINA RESIDENTIAL CODE 2018 EDITION WALL BRACING CRITERIA. THE AMOUNT, LENGTH, AND LOCATION OF BRACING SHALL COMPLY WITH ALL APPLICABLE TABLES IN SECTION R602.10.
- PROVIDE DOUBLE JOIST UNDER ALL WALLS PARALLEL TO FLOOR JOISTS. PROVIDE SUPPORT UNDER ALL WALLS PARALLEL TO FLOOR TRUSSES OR I-JOISTS PER MANUFACTURER'S SPECIFICATIONS. INSTALL BLOCKING BETWEEN JOISTS OR TRUSSES FOR POINT LOAD SUPPORT FOR ALL POINT LOADS ALONG OFFSET LOAD LINES.
- FOR ALL HEADERS SUPPORTING BRICK VENEER THAT ARE LESS THAN 8'-0" IN LENGTH, REST A 6" x 4" x 5/16" STEEL ANGLE WITH 6" MINIMUM EMBEDMENT AT SIDES FOR BRICK SUPPORT (UNO). FOR ALL HEADERS 8'-0" AND GREATER IN LENGTH, BOLT A 6" x 4" x 5/16" STEEL ANGLE TO HEADER WITH 1/2" LAG SCREWS AT 12" O.C. STAGGERED FOR BRICK SUPPORT. FOR ALL BRICK SUPPORT AT ROOF LINES, BOLT A 6" x 4" x 5/16" STEEL ANGLE TO (2) 2 x 10 BLOCKING INSTALLED w/ (4) 12d NAILS EA. PLY BETWEEN WALL STUDS WITH (2) ROWS OF 1/2" LAG SCREWS AT 12" O.C. STAGGERED AND IN ACCORDANCE WITH SECTION R103.2(1) OF THE NCRC, 2018 EDITION.
- FOR STICK FRAMED ROOFS: CIRCLES DENOTE (3) 2 x 4 POSTS FOR ROOF MEMBER SUPPORT. HIP SPLICES ARE TO BE SPACED A MINIMUM OF 8'-0". FASTEN MEMBERS WITH THREE ROWS OF 12d NAILS AT 16" O.C. FRAME DORMER WALLS ON TOP OF DOUBLE OR TRIPLE RAFTERS AS SHOWN (UNO).
- FOR TRUSSED ROOFS: FRAME DORMER WALLS ON TOP OF 2 x 4 LADDER FRAMING AT 24" O.C. BETWEEN ADJACENT ROOF TRUSSES. STICK FRAME OVER-FRAMED ROOF SECTIONS WITH 2 x 8 RIDGES, 2 x 6 RAFTERS AT 16" O.C. AND FLAT 2 x 10 VALLEYS (UNO).
- ALL 4 x 4 AND 6 x 6 POSTS TO BE INSTALLED WITH 100 LB CAPACITY UPLIFT CONNECTORS TOP AND BOTTOM (UNO). POSTS MAY BE SECURED USING ONE SIMPSON 146 OR L782 UPLIFT CONNECTOR FASTENED TO THE BAND AT THE BOTTOM AND THE BEAM AT THE TOP OF EACH POST. ONE 16" SECTION OF SIMPSON C516 COIL STRAPPING WITH (8) 8d HDG NAILS AT EACH END MAY BE USED IN LIEU OF EACH TWIN STRAP IF DESIRED. FOR MASONRY OR CONCRETE FOUNDATION USE SIMPSON POST BASE.

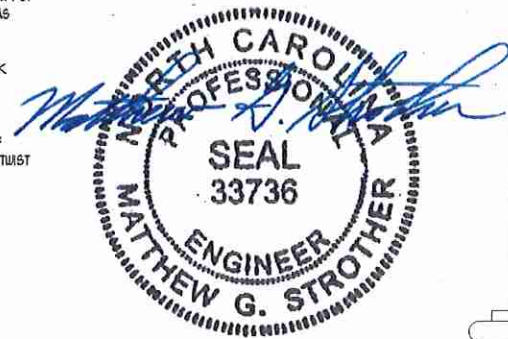

**J.S. THOMPSON ENGINEERING, INC.**  
605 WADE AVE., SUITE 104 RALEIGH, NC 27605  
PHONE: (919) 789-9919 FAX: (919) 789-9921  
N.C. LICENSE NO. C-1733

120 MPH - 130 MPH ULTIMATE DESIGN WIND SPEED  
STANDARD STRUCTURAL NOTES

DATE: NOVEMBER 14, 2018  
DRAWN BY: JES  
ENGINEERED BY: JST

S-0  
STRUCTURAL NOTES

7/22/19