

ISSUANCE OF PLANS FROM THIS DRAFTER'S OFFICE SHALL NOT RELIEVE THE BUILDER OF RESPONSIBILITY TO REVIEW AND VERIFY ALL NOTES, DIMENSIONS, AND ADHERENCE TO APPLICABLE BUILDING CODES PRIOR TO COMMENCEMENT OF ANY CONSTRUCTION.
 ANY DISCREPANCY OF ERROR IN NOTES, DIMENSIONS, OR ADHERENCE TO APPLICABLE BUILDING CODES SHALL BE BROUGHT TO THE ATTENTION OF THE DRAFTER'S OFFICE FOR CORRECTION BEFORE COMMENCEMENT OF ANY CONSTRUCTION.
 ANY REVISIONS OR CHANGES, NOT RELATED TO THE CORRECTION OF ERRORS THAT ARE MADE AFTER THE FINAL PLANS HAVE BEEN COMPLETED SHALL BE SUBJECT TO ADDITIONAL FEES.
 IF ANY MODIFICATIONS ARE MADE TO THESE PLANS BY ANY OTHER PARTY OTHER THAN THE DRAFTER'S OFFICE, THE DRAFTER SHALL NOT BE HELD RESPONSIBLE.

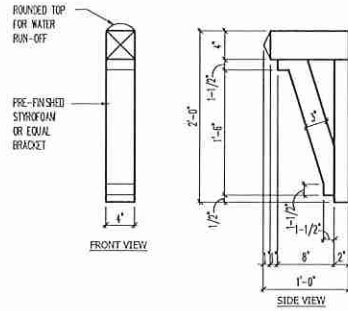

BRACKET DETAIL
 SCALE: 1" = 1'-0"

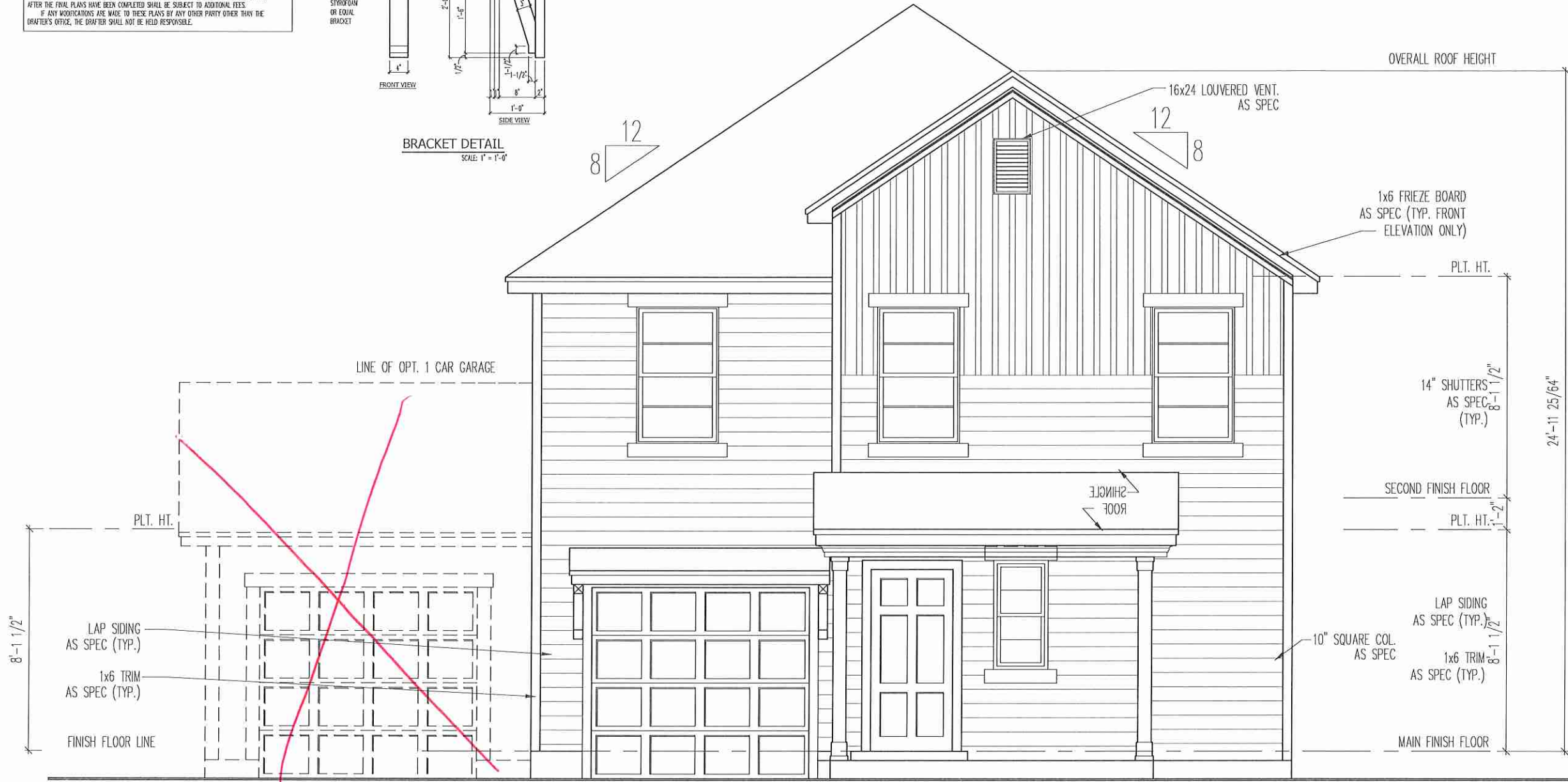

FRONT ELEVATION

SCALE: 1/4" = 1'-0"



JOB NUMBER	00000.00
CAD FILE NAME	VISION-R
ISSUED	09-10-12
REVISED	

DRAWINGS ON 11"x17" SHEET ARE ONE HALF THE SCALE NOTED

VISION
 H&H HOMES

1514

TITLE
 FRONT ELEVATION
 DETAILS
 PARTIAL UPPER FLOOR PLAN
 AT ELEV. "C"

SHEET
A5.0

ELEVATION "C" - MODERN
 GARAGE LEFT

Inventory Marked

CSQ000067

ISSUANCE OF PLANS FROM THIS DRAFTER'S OFFICE SHALL NOT RELIEVE THE BUILDER OF RESPONSIBILITY TO REVIEW AND VERIFY ALL NOTES, DIMENSIONS, AND ADHERENCE TO APPLICABLE BUILDING CODES PRIOR TO COMMENCEMENT OF ANY CONSTRUCTION.
 ANY DISCREPANCY OF ERROR IN NOTES, DIMENSIONS, OR ADHERENCE TO APPLICABLE BUILDING CODES SHALL BE BROUGHT TO THE ATTENTION OF THE DRAFTER'S OFFICE FOR CORRECTION BEFORE COMMENCEMENT OF ANY CONSTRUCTION.
 ANY REVISIONS OR CHANGES, NOT RELATED TO THE CORRECTION OF ERRORS THAT ARE MADE AFTER THE FINAL PLANS HAVE BEEN COMPLETED SHALL BE SUBJECT TO ADDITIONAL FEES.
 IF ANY MODIFICATIONS ARE MADE TO THESE PLANS BY ANY OTHER PARTY OTHER THAN THE DRAFTER'S OFFICE, THE DRAFTER SHALL NOT BE HELD RESPONSIBLE.

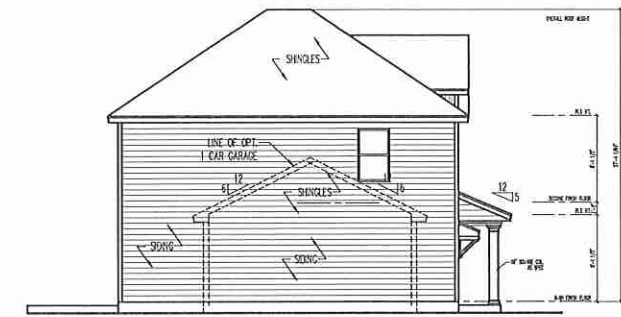
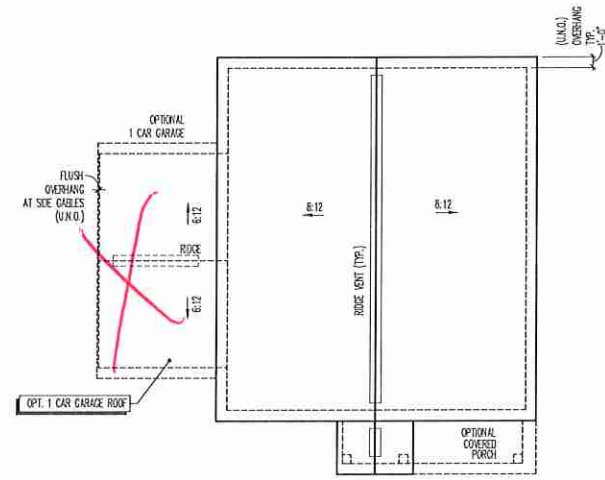

LEFT ELEVATION
SCALE: 1/8" = 1'-0"

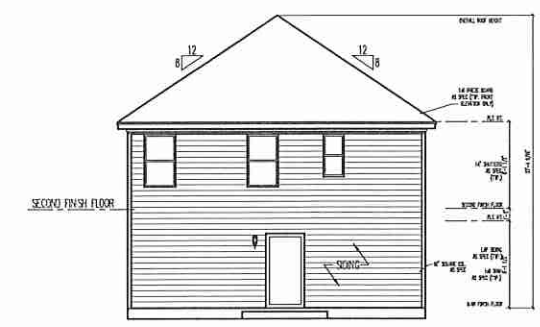

REAR ELEVATION
SCALE: 1/8" = 1'-0"

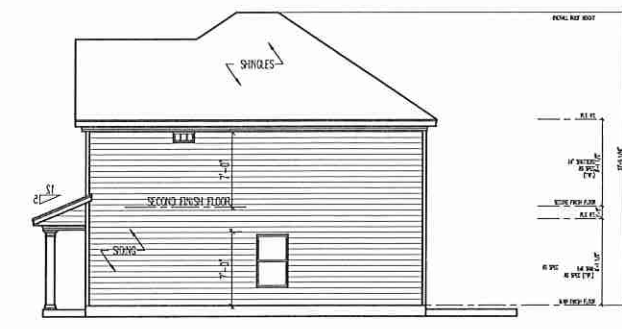

RIGHT ELEVATION
SCALE: 1/8" = 1'-0"

ELEVATION "C" -
GARAGE LEFT

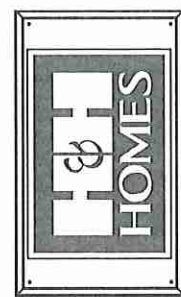

JOB NUMBER	00000.00
CAD FILE NAME	15000 - A
ISSUED	09-18-17
REVISED	

DRAWINGS ON 11"x17" SHEET ARE ONE HALF THE SCALE NOTED

**VISION
H&H HOMES**

1514

TITLE
SIDE AND REAR ELEVATIONS
ROOF PLAN
BUILDING SECTION

SHEET
A5.1

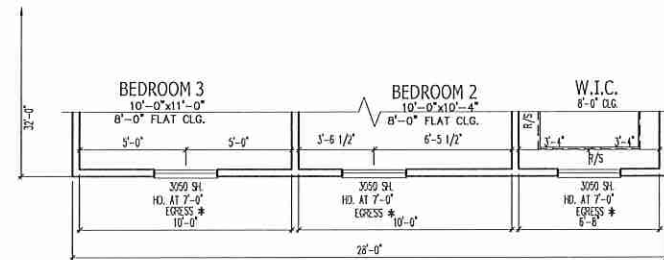

PARTIAL UPPER FLOOR PLAN

SCALE: 1/4" = 1'-0"

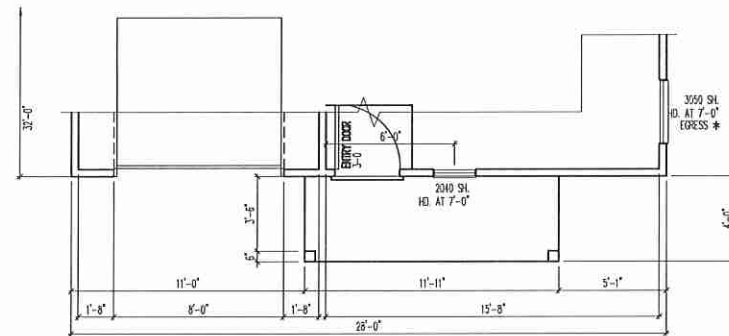

PARTIAL MAIN FLOOR PLAN

SCALE: 1/4" = 1'-0"



JOB NUMBER	00000.00
CAD FILE NAME	VISION-B
ISSUED	02-10-17
REVISED	

DRAWINGS ON 11"x17" SHEET ARE ONE HALF THE SCALE NOTED

VISION
H&H HOMES

1514

TITLE
PLAN OPTIONS

SHEET
A2.2

REFER TO STANDARD PLAN FOR INFORMATION NOT SHOWN.

PARTIAL PLANS AT ELEVATION "C"
GARAGE RIGHT

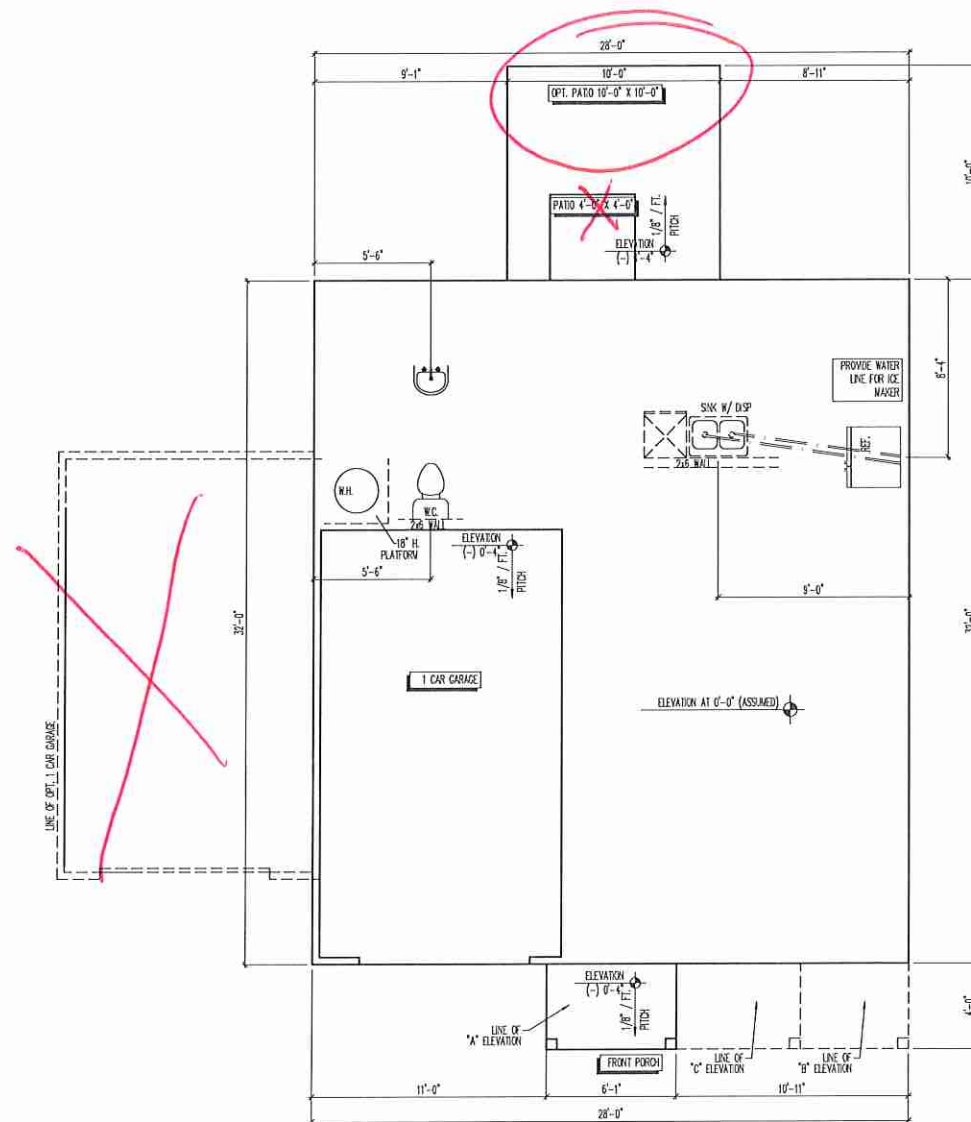

ISSUANCE OF PLANS FROM THIS DRAFTER'S OFFICE SHALL NOT RELIEVE THE BUILDER OF RESPONSIBILITY TO REVIEW AND VERIFY ALL NOTES, DIMENSIONS, AND ADHERENCE TO APPLICABLE BUILDING CODES PRIOR TO COMMENCEMENT OF ANY CONSTRUCTION.
 ANY DISCREPANCY OF ERROR IN NOTES, DIMENSIONS, OR ADHERENCE TO APPLICABLE BUILDING CODES SHALL BE BROUGHT TO THE ATTENTION OF THE DRAFTER'S OFFICE FOR CORRECTION BEFORE COMMENCEMENT OF ANY CONSTRUCTION.
 ANY REVISIONS OR CHANGES, NOT RELATED TO THE CORRECTION OF ERRORS THAT ARE MADE AFTER THE FINAL PLANS HAVE BEEN COMPLETED SHALL BE SUBJECT TO ADDITIONAL FEES.
 IF ANY MODIFICATIONS ARE MADE TO THESE PLANS BY ANY OTHER PARTY OTHER THAN THE DRAFTER'S OFFICE, THE DRAFTER SHALL NOT BE HELD RESPONSIBLE.

SLAB INTERFACE PLAN

C.C. VERIFY INSTALLATION OF OVERHEAD GAS DROPS AT APPLICABLE APPLIANCE LOCATIONS

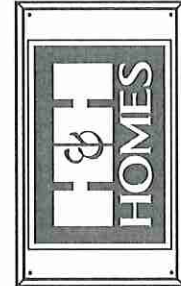

JOB NUMBER	00000000
CAD FILE NAME	VISION-A
ISSUED	09-10-17
REVISED	

DRAWINGS ON 11"x17" SHEET ARE ONE HALF THE SCALE NOTED

VISION
H&H HOMES

1514

TITLE
SLAB INTERFACE PLAN

SHEET
A1.0

SCALE: 1/4" = 1'-0"
GARAGE RIGHT



*JOB NUMBER	00001.00
CAD FILE NAME	VISION-7
ISSUED	09-19-17
REVISED	

DRAWINGS ON 11"x17" SHEET ARE ONE HALF THE SCALE NOTED

VISION
H&H HOMES

1514

TITLE
MAIN FLOOR PLAN
STAR SECTION

SHEET
A2.0

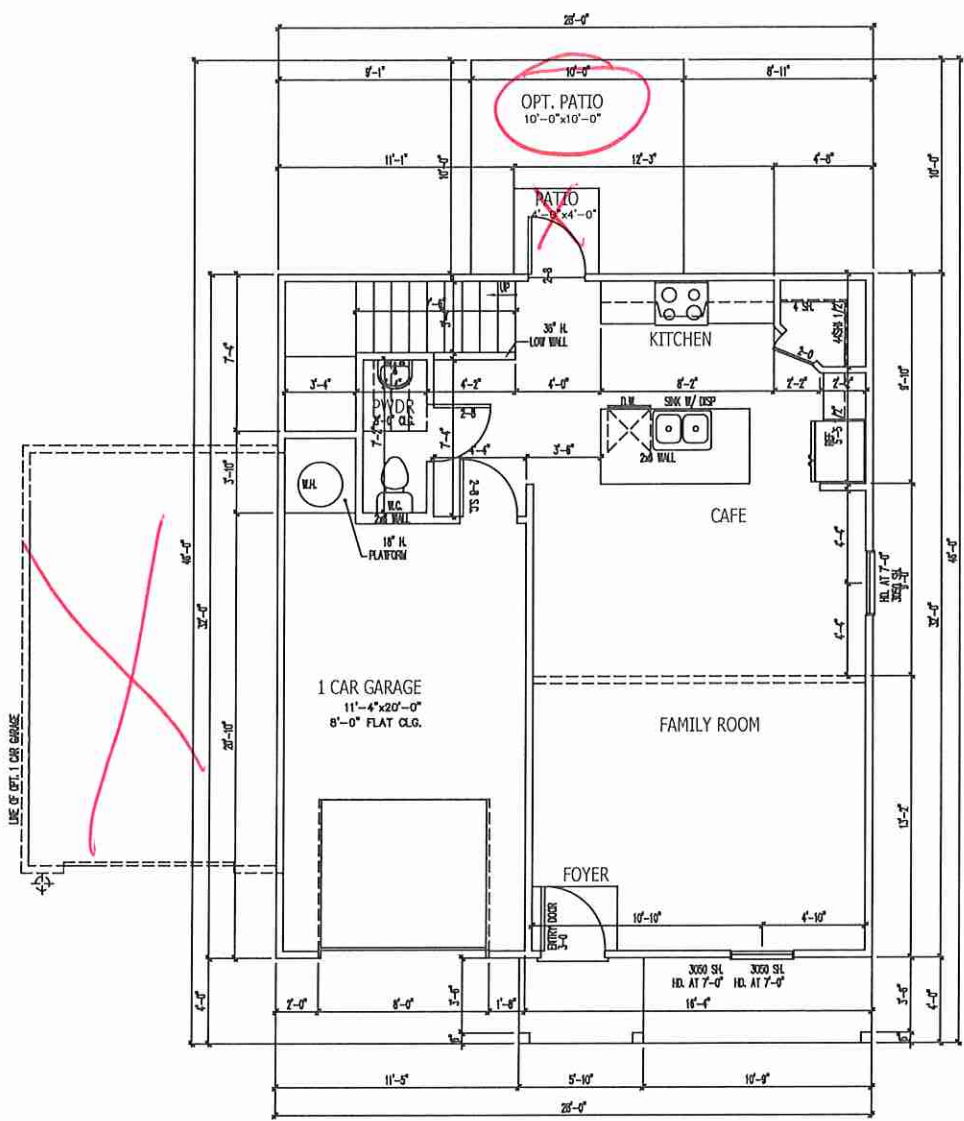

THE GARAGE SHALL BE SEPARATED FROM THE RESIDENCE AND ITS ATTIC AREA BY NOT LESS THAN 1/2 INCH (12.7 mm) GYPSUM BOARD APPLIED TO THE GARAGE SIDE. GARAGES BENEATH HABITABLE ROOMS SHALL BE SEPARATED FROM ALL HABITABLE ROOMS ABOVE BY NOT LESS THAN 5/8 INCH (15.9 mm) TYPE "X" GYPSUM BOARD OR EQUIVALENT. WHERE THE SEPARATION IS A FLOOR-CEILING ASSEMBLY, THE STRUCTURE SUPPORTING THE SEPARATION SHALL ALSO BE PROTECTED BY NOT LESS THAN 1/2 INCH (12.7 mm) GYPSUM BOARD OR EQUIVALENT.

MAIN FLOOR	659 S.F.
UPPER FLOOR	855 S.F.
TOTAL LIVING	1514 S.F.
GARAGE	237 S.F.
FRONT PORCH	23 S.F.
TOTAL SQ. FT.	1774 S.F.

MAIN FLOOR PLAN
SCALE: 1/4" = 1'-0"
GARAGE RIGHT

ISSUANCE OF PLANS FROM THIS DRAFTER'S OFFICE SHALL NOT RELIEVE THE BUILDER OF RESPONSIBILITY TO REVIEW AND VERIFY ALL NOTES, DIMENSIONS, AND ADHERENCE TO APPLICABLE BUILDING CODES PRIOR TO COMMENCEMENT OF ANY CONSTRUCTION.
ANY DISCREPANCY OF ERROR IN NOTES, DIMENSIONS, OR ADHERENCE TO APPLICABLE BUILDING CODES SHALL BE BROUGHT TO THE ATTENTION OF THE DRAFTER'S OFFICE FOR CORRECTION BEFORE COMMENCEMENT OF ANY CONSTRUCTION.
ANY REVISIONS OR CHANGES, NOT RELATED TO THE CORRECTION OF ERRORS THAT ARE MADE AFTER THE FINAL PLANS HAVE BEEN COMPLETED SHALL BE SUBJECT TO ADDITIONAL FEES.
IF ANY MODIFICATIONS ARE MADE TO THESE PLANS BY ANY OTHER PARTY OTHER THAN THE DRAFTER'S OFFICE, THE DRAFTER SHALL NOT BE HELD RESPONSIBLE.



*JOB NUMBER	00000.00
CAD FILE NAME	VISION-2
ISSUED	09-18-17
REVISED	

DRAWINGS ON 11"x17" SHEET ARE ONE HALF THE SCALE NOTED

VISION
H&H HOMES

1514

TITLE
UPPER FLOOR PLAN

SHEET
A2.1

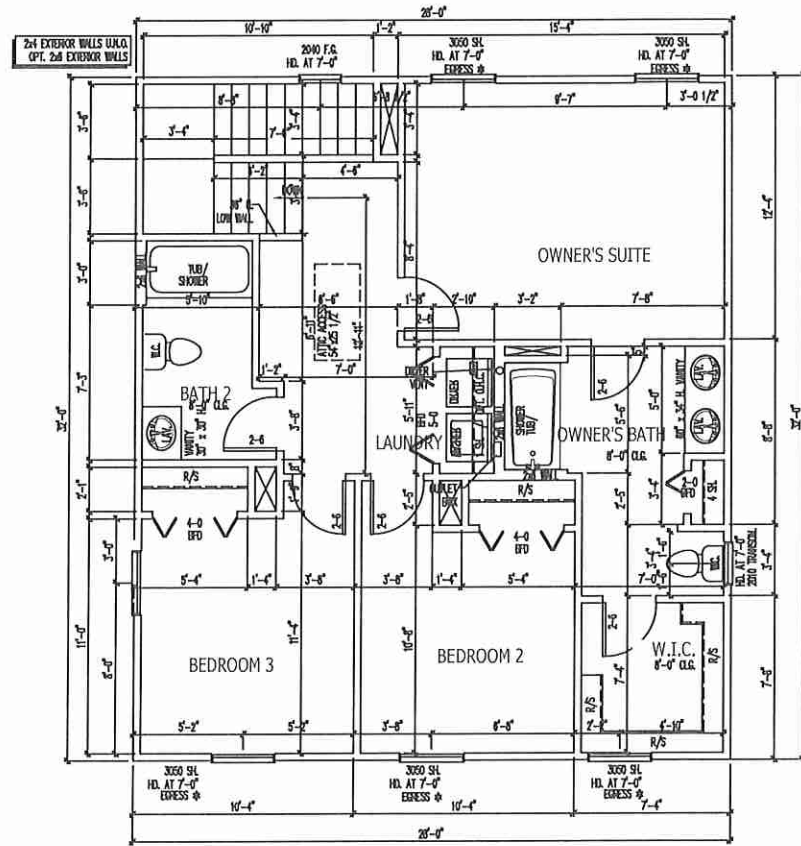

ISSUANCE OF PLANS FROM THIS DRAFTER'S OFFICE SHALL NOT RELIEVE THE BUILDER OF RESPONSIBILITY TO REVIEW AND VERIFY ALL NOTES, DIMENSIONS, AND ADHERENCE TO APPLICABLE BUILDING CODES PRIOR TO COMMENCEMENT OF ANY CONSTRUCTION. ANY DISCREPANCY OF ERROR IN NOTES, DIMENSIONS, OR ADHERENCE TO APPLICABLE BUILDING CODES SHALL BE BROUGHT TO THE ATTENTION OF THE DRAFTER'S OFFICE FOR CORRECTION BEFORE COMMENCEMENT OF ANY CONSTRUCTION. ANY PERSONS OR COMPANIES NOT RELATED TO THE CORRECTION OF ERRORS THAT ARE MADE AFTER THE FINAL PLANS HAVE BEEN COMPLETED SHALL BE SUBJECT TO ADDITIONAL FEES. IF ANY MODIFICATIONS ARE MADE TO THESE PLANS BY ANY OTHER PARTY OTHER THAN THE DRAFTER'S OFFICE, THE DRAFTER SHALL NOT BE HELD RESPONSIBLE.

UPPER FLOOR PLAN
SCALE: 1/4" = 1'-0"
GARAGE RIGHT

ELECTRICAL KEY

- ⊕ DUPLEX CONVENIENCE OUTLET
- ⊕ DUPLEX OUTLET ABOVE COUNTER
- ⊕ WEATHERPROOF DUPLEX OUTLET
- ⊕ GROUND FAULT INTERRUPTER DUPLEX OUTLET
- ⊕ HALF-SWITCHED DUPLEX OUTLET
- ⊕ SPECIAL PURPOSE OUTLET
- ⊕ DUPLEX OUTLET IN FLOOR
- ⊕ 220 VOLT OUTLET
- ⊕ WALL SWITCH
- ⊕ THREE-WAY SWITCH
- ⊕ FOUR-WAY SWITCH
- ⊕ DIMMER SWITCH
- ⊕ CEILING MOUNTED INCANDESCENT LIGHT FIXTURE
- ⊕ WALL MOUNTED INCANDESCENT LIGHT FIXTURE
- ⊕ RECESSED INCANDESCENT LIGHT FIXTURE
- ⊕ LIGHT FIXTURE WITH PULL CHAIN
- ⊕ TRACK LIGHT
- ⊕ FLUORESCENT LIGHT FIXTURE
- ⊕ EXHAUST FAN
- ⊕ EXHAUST FAN/LIGHT COMBINATION
- ⊕ ELECTRIC DOOR OPERATOR (OPTIONAL)
- ⊕ CHIMES (OPTIONAL)
- ⊕ PUSHBUTTON SWITCH (OPTIONAL)
- ⊕ CARBON MONOXIDE DETECTOR
- ⊕ SMOKE DETECTOR
- ⊕ SMOKE / CARBON MONOXIDE COMBO DETECTOR
- ⊕ TELEPHONE (OPTIONAL)
- ⊕ TELEVISION (OPTIONAL)
- ⊕ THERMOSTAT
- ⊕ ELECTRIC METER
- ⊕ ELECTRIC PANEL
- ⊕ DISCONNECT SWITCH
- ⊕ SPEAKER (OPTIONAL)
- ⊕ ROUGH-IN FOR OPT. CEILING FAN
- ⊕ CEILING MOUNTED INCANDESCENT LIGHT FIXTURE W/ ROUGH-IN FOR OPT. CEILING FAN

NOTES:

1. PROVIDE AND INSTALL GROUND FAULT CIRCUIT-INTERRUPTERS (G.F.I.) AS INDICATED ON PLANS OR AS ITEM NO. 4 AND 5 BELOW INDICATES.
2. UNLESS OTHERWISE INDICATED, INSTALL SWITCHES AND RECEPTACLES AT THE FOLLOWING HEIGHTS ABOVE FINISHED FLOOR:
 SWITCHES . . . 42"
 OUTLETS . . . 14"
 TELEPHONE . . . 14" (UNLESS ANY COUNTERTOP)
 TELEVISION . . . 14"
3. ALL SMOKE DETECTORS SHALL BE HARDWIRED INTO AN ELECTRICAL POWER SOURCE AND SHALL BE EQUIPPED WITH A MONITORED BATTERY BACKUP. PROVIDE AND INSTALL LOCALLY CERTIFIED SMOKE DETECTORS.
4. ALL 15A AND 20A RECEPTACLES IN SLEEPING ROOMS, FAMILY ROOMS, DINING ROOMS, LIVING ROOMS, PARLORS, LIBRARIES, BENS, SUNROOMS, RECREATION ROOMS, CLOSETS, HALLWAYS, AND SIMILAR AREAS WILL REQUIRE A COMBINATION TYPE A.F.C.I. DEVICE AND TAMPER-PROOF RECEPTACLES PER N.E.C. 2011 406.12 AND 406.13.
5. ALL 15A AND 20A 120V RECEPTACLES LOCATED IN THE GARAGE AND UTILITY ROOMS SHALL BE G.F.C.I. PROTECTED (G.F.I.).
6. IT IS THE RESPONSIBILITY OF THE LICENSED ELECTRICIAN TO ENSURE THAT ALL ELECTRICAL WORK IS IN FULL COMPLIANCE WITH N.E.P.A. 70, N.E.C. 2011, AND ALL APPLICABLE LOCAL STANDARDS, CODES, AND ORDINANCES.
7. EVERY BUILDING HAVING A FOSSIL-FUEL-BURNING HEATER OR APPLIANCE, FIREPLACE, OR AN ATTACHED GARAGE SHALL HAVE AN OPERATIONAL CARBON MONOXIDE DETECTOR INSTALLED WITHIN 10 FEET OF EACH ROOM USED FOR SLEEPING PURPOSES.
8. ALARMS SHALL RECEIVE THEIR PRIMARY POWER FROM THE BUILDING WIRING WHEN SUCH WIRING IS SERVED FROM THE LOCAL POWER UTILITY. SUCH ALARMS SHALL HAVE BATTERY BACKUP. COMBINATION SMOKE/CARBON MONOXIDE ALARMS SHALL BE LISTED OR LABELED BY A NATIONALLY RECOGNIZED TESTING LABORATORY.

ISSUANCE OF PLANS FROM THIS DRAFTER'S OFFICE SHALL NOT RELIEVE THE BUILDER OF RESPONSIBILITY TO REVIEW AND VERIFY ALL NOTES, DIMENSIONS, AND ADHERENCE TO APPLICABLE BUILDING CODES PRIOR TO COMMENCEMENT OF ANY CONSTRUCTION.
 ANY DISCREPANCY OF ERROR IN NOTES, DIMENSIONS, OR ADHERENCE TO APPLICABLE BUILDING CODES SHALL BE BROUGHT TO THE ATTENTION OF THE DRAFTER'S OFFICE FOR CORRECTION BEFORE COMMENCEMENT OF ANY CONSTRUCTION.
 ANY REVISIONS OR CHANGES, NOT RELATED TO THE CORRECTION OF ERRORS THAT ARE MADE AFTER THE FINAL PLANS HAVE BEEN COMPLETED SHALL BE SUBJECT TO ADDITIONAL FEES.
 IF ANY MODIFICATIONS ARE MADE TO THESE PLANS BY ANY OTHER PARTY OTHER THAN THE DRAFTER'S OFFICE, THE DRAFTER SHALL NOT BE HELD RESPONSIBLE.

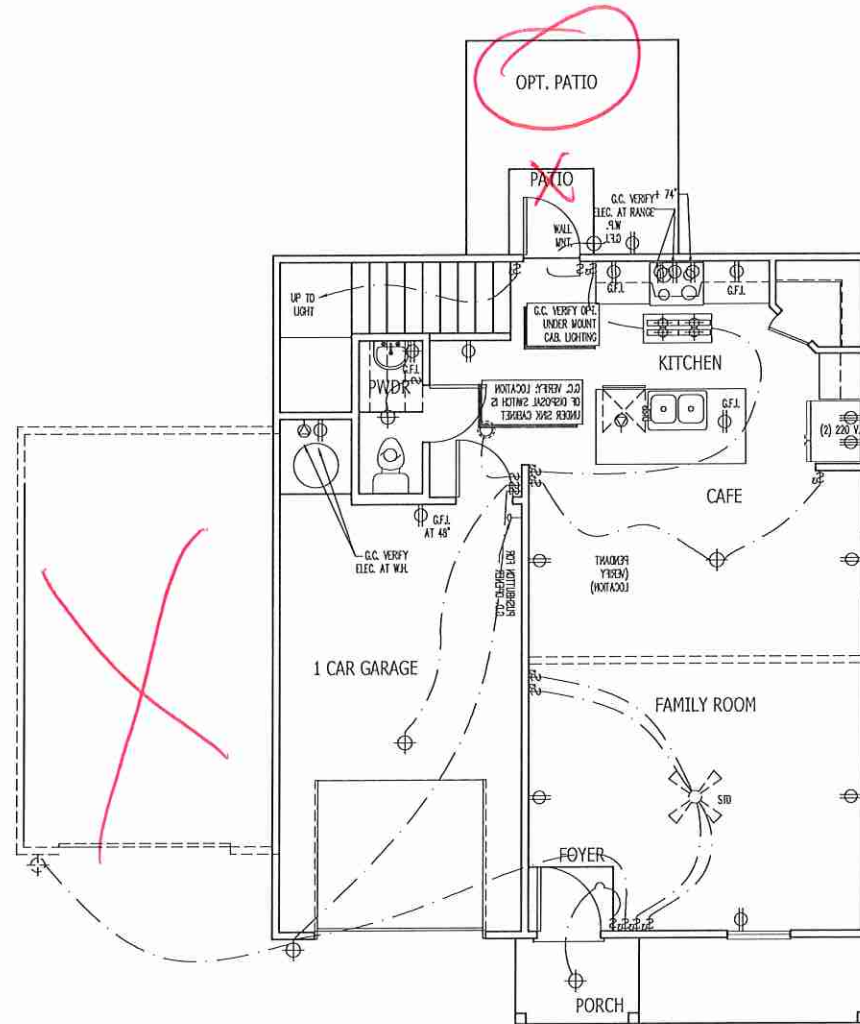

JOB NUMBER	00001.00
CAD FILE NAME	VISION-R
ISSUED	02-18-17
REVISED	

DRAWINGS ON 11"x17" SHEET ARE ONE HALF THE SCALE NOTED

VISION
H&H HOMES

1514

TITLE
MAIN FLOOR ELEC. PLAN

SHEET
E1

MAIN FLOOR ELECTRICAL PLAN
GARAGE RIGHT

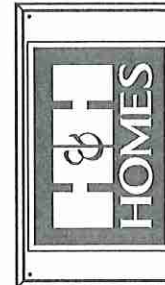

JOB NUMBER	00001.00
CAD FILE NAME	VISION-E
ISSUED	09-19-17
REVISED	

DRAWINGS ON 11"x17" SHEET ARE ONE HALF THE SCALE NOTED

VISION
H&H HOMES

1514

TITLE
UPPER FLOOR ELEC. PLAN

SHEET
E2

ELECTRICAL KEY

- ⊕ DUPLEX CONNEXENCE OUTLET
- ⊕ DUPLEX OUTLET ABOVE COUNTER
- ⊕ WEATHERPROOF DUPLEX OUTLET
- ⊕ GROUND FAULT INTERRUPTER DUPLEX OUTLET
- ⊕ HALF-SWITCHED DUPLEX OUTLET
- ⊕ SPECIAL PURPOSE OUTLET
- ⊕ DUPLEX OUTLET IN FLOOR
- ⊕ 220 VOLT OUTLET
- ⊕ WALL SWITCH
- ⊕ THREE-WAY SWITCH
- ⊕ FOUR-WAY SWITCH
- ⊕ DIMMER SWITCH
- ⊕ CEILING MOUNTED INCANDESCENT LIGHT FIXTURE
- ⊕ WALL MOUNTED INCANDESCENT LIGHT FIXTURE
- ⊕ RECESSED INCANDESCENT LIGHT FIXTURE
- ⊕ LIGHT FIXTURE WITH PULL CHAIN
- ⊕ TRACK LIGHT
- ⊕ FLUORESCENT LIGHT FIXTURE
- ⊕ EXHAUST FAN
- ⊕ EXHAUST FAN/LIGHT COMBINATION
- ⊕ ELECTRIC DOOR OPERATOR (OPTIONAL)
- ⊕ DIMES (OPTIONAL)
- ⊕ PUSHBUTTON SWITCH (OPTIONAL)
- ⊕ CARBON MONOXIDE DETECTOR
- ⊕ SMOKE DETECTOR
- ⊕ SMOKE / CARBON MONOXIDE DETECTOR
- ⊕ TELEPHONE (OPTIONAL)
- ⊕ TELEVISION (OPTIONAL)
- ⊕ THERMOSTAT
- ⊕ ELECTRIC METER
- ⊕ ELECTRIC PANEL
- ⊕ DISCONNECT SWITCH
- ⊕ SPEAKER (OPTIONAL)
- ⊕ ROUGH-IN FOR OPT. CEILING FAN
- ⊕ CEILING MOUNTED INCANDESCENT LIGHT FIXTURE W/ ROUGH-IN FOR OPT. CEILING FAN

NOTES:

1. PROVIDE AND INSTALL GROUND FAULT CIRCUIT INTERRUPTERS (G.F.I.) AS INDICATED ON PLANS OR AS ITEM NO. 4 AND 5 BELOW INDICATES.
2. UNLESS OTHERWISE INDICATED, INSTALL SWITCHES AND RECEPTACLES AT THE FOLLOWING HEIGHTS ABOVE FINISHED FLOOR:
 SWITCHES . . . 42"
 OUTLETS . . . 14"
 TELEPHONE . . . 14" (UNLESS AOV COUNTERTOP)
 TELEVISION . . . 14"
3. ALL SMOKE DETECTORS SHALL BE HARDWIRED INTO AN ELECTRICAL POWER SOURCE AND SHALL BE EQUIPPED WITH A MONITORED BATTERY BACKUP. PROVIDE AND INSTALL LOCALLY CERTIFIED SMOKE DETECTORS.
4. ALL 15A AND 20A RECEPTACLES IN SLEEPING ROOMS, FAMILY ROOMS, DINING ROOMS, LIVING ROOMS, PARLORS, LIBRARIES, DECKS, SUNROOMS, RECREATION ROOMS, CLOSETS, HALLWAYS, AND SIMILAR AREAS WILL REQUIRE A COMBINATION TYPE AFCI DEVICE AND TAMPER-PROOF RECEPTACLES PER N.E.C. 2011 406.12 AND 406.13.
5. ALL 15A AND 20A 120V RECEPTACLES LOCATED IN THE GARAGE AND UTILITY ROOMS SHALL BE GFCI PROTECTED (GFI).
6. IT IS THE RESPONSIBILITY OF THE LICENSED ELECTRICIAN TO ENSURE THAT ALL ELECTRICAL WORK IS IN FULL COMPLIANCE WITH N.E.P.A. 70, N.E.C. 2011, AND ALL APPLICABLE LOCAL STANDARDS, CODES, AND ORDINANCES.
7. EVERY BUILDING HAVING A FISSILE-FUEL-BURNING HEATER OR APPLIANCE, FIREPLACE, OR AN ATTACHED GARAGE SHALL HAVE AN OPERATIONAL CARBON MONOXIDE DETECTOR INSTALLED WITHIN 10 FEET OF EACH ROOM USED FOR SLEEPING PURPOSES.
8. ALARMS SHALL RECEIVE THEIR PRIMARY POWER FROM THE BUILDING WIRING WHEN SUCH WIRING IS SUPPLIED FROM THE LOCAL POWER UTILITY. SUCH ALARMS SHALL HAVE BATTERY BACKUP. COMBINATION SMOKE/CARBON MONOXIDE ALARMS SHALL BE LISTED OR LABELED BY A NATIONALLY RECOGNIZED TESTING LABORATORY.

ISSUANCE OF PLANS FROM THIS DRAFTER'S OFFICE SHALL NOT RELIEVE THE BUILDER OF RESPONSIBILITY TO REVIEW AND VERIFY ALL NOTES, DIMENSIONS, AND ADHERENCE TO APPLICABLE BUILDING CODES PRIOR TO COMMENCEMENT OF ANY CONSTRUCTION.
 ANY DISCREPANCY OF ERROR IN NOTES, DIMENSIONS, OR ADHERENCE TO APPLICABLE BUILDING CODES SHALL BE BROUGHT TO THE ATTENTION OF THE DRAFTER'S OFFICE FOR CORRECTION BEFORE COMMENCEMENT OF ANY CONSTRUCTION.
 ANY REVISIONS OR CHANGES, NOT RELATED TO THE CORRECTION OF ERRORS THAT ARE MADE AFTER THE FINAL PLANS HAVE BEEN COMPLETED SHALL BE SUBJECT TO ADDITIONAL FEES.
 IF ANY MODIFICATIONS ARE MADE TO THESE PLANS BY ANY OTHER PARTY OTHER THAN THE DRAFTER'S OFFICE, THE DRAFTER SHALL NOT BE HELD RESPONSIBLE.

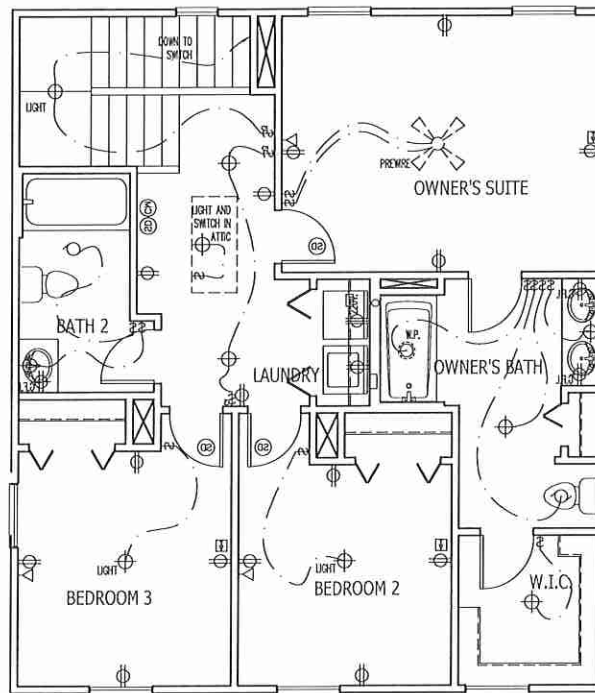

UPPER FLOOR ELECTRICAL PLAN
GARAGE RIGHT

SCALE NOTE:
 LARGE FORMAT PRINTS ARE TO SCALE AS NOTED.
 11" x 17" PRINTS ARE ONE HALF THE NOTED SCALE

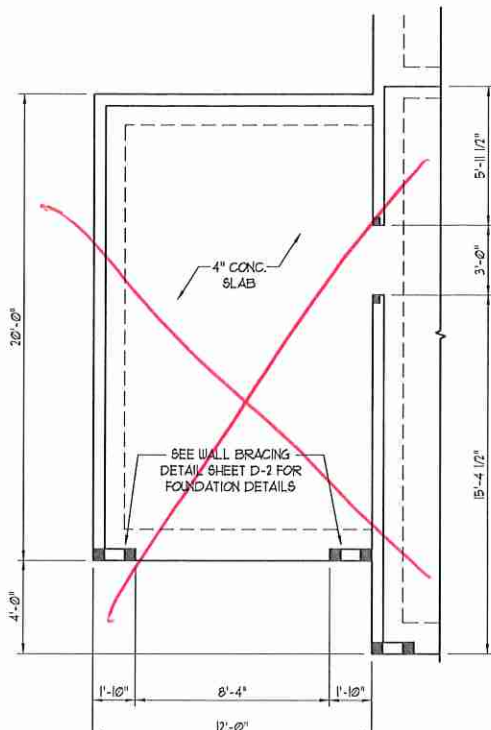

OPTIONAL THIRD CAR GARAGE

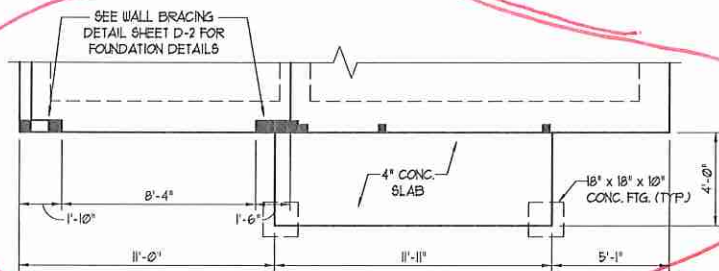

ELEVATION "C"

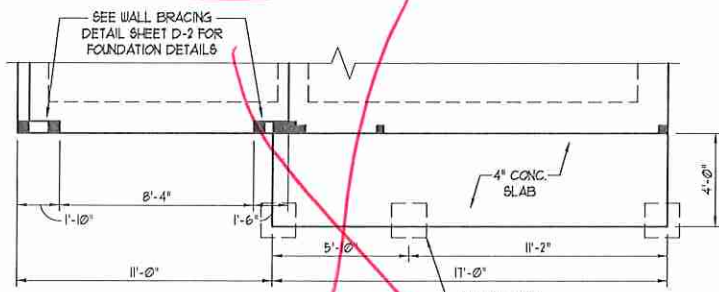

ELEVATION "B"

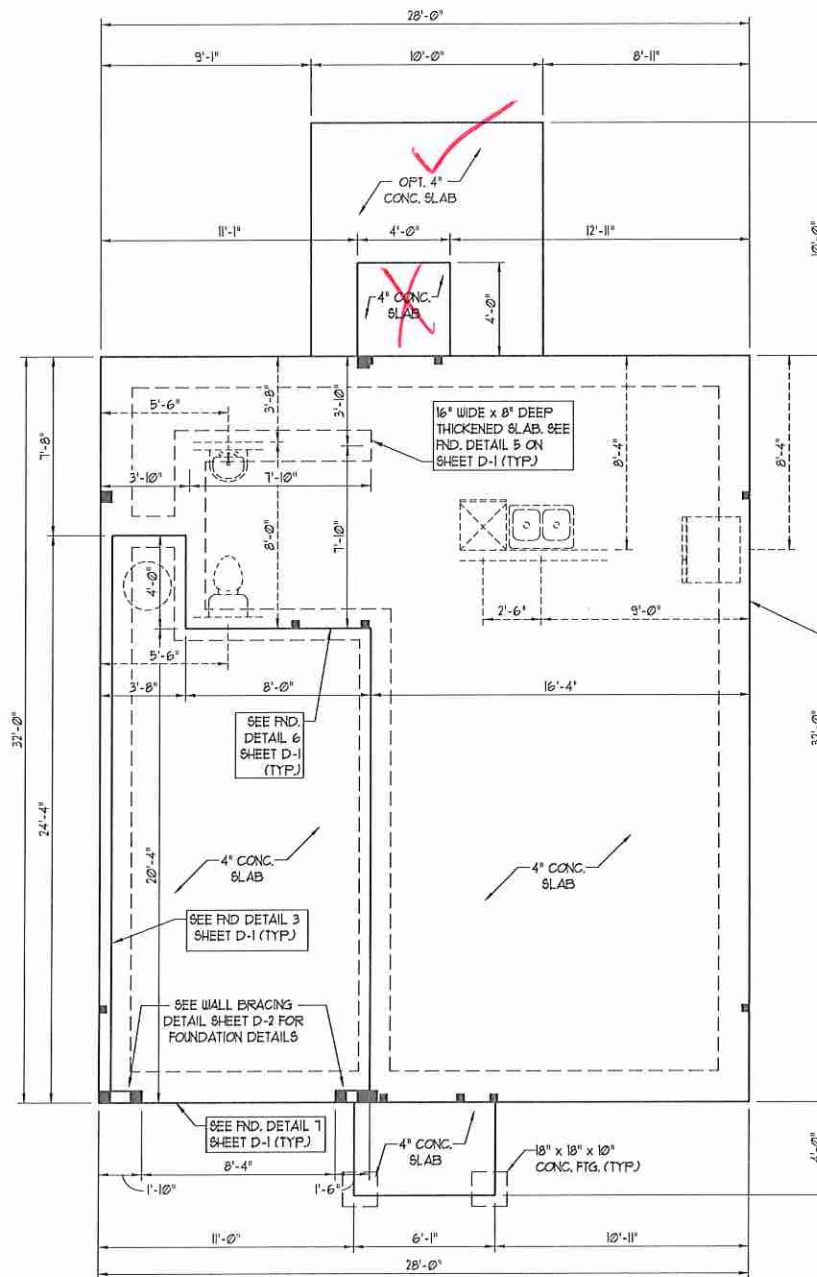

ELEVATION "A"

120 MPH ULTIMATE DESIGN WIND SPEED
 NOTES FOR LESS THAN
 30' MEAN ROOF HEIGHT:

- ENGINEER'S SEAL APPLIES ONLY TO STRUCTURAL COMPONENTS. ENGINEER'S SEAL DOES NOT CERTIFY DIMENSIONAL ACCURACY OR ARCHITECTURAL LAYOUT INCLUDING ROOF SYSTEM.
- STRUCTURAL DESIGN PER NORTH CAROLINA RESIDENTIAL CODE, 2018 EDITION.
- INSTALL 1/2" ANCHOR BOLTS 6'-0" O.C. AND WITHIN 1'-0" FROM END OF EACH CORNER. ANCHOR BOLTS MUST EXTEND A MINIMUM OF 1' INTO MASONRY OR CONCRETE. LOCATE BOLT WITH MIDDLE THIRD OF PLATE WIDTH.
- MEAN ROOF HEIGHT IS LESS THAN 30 FEET.
- EXTERIOR WALLS DESIGNED FOR 120 MPH WINDS.
- WALL CLADDING DESIGNED FOR 15.5 PSF AND -20 PSF (+/-). INDICATE POSITIVE / NEGATIVE PRESSURE (TYP.).
- ROOF CLADDING DESIGNED FOR 44.2 PSF AND -18 PSF FOR ROOF PITCHES 1/2 TO 1/12 AND 10 PSF AND -36 PSF FOR ROOF PITCHES 22/12 TO 1/12.
- INSTALL 1/4" OSB SHEATHING ON ALL EXTERIOR WALLS OF ALL STORIES IN ACCORDANCE WITH SECTION R6.02.103 OF THE NRC, 2018 EDITION. SEE THE WALL BRACING NOTES AND DETAILS SHEET FOR MORE INFORMATION.
- ENERGY EFFICIENCY COMPLIANCE AND INSULATION VALUES OF THE BUILDING TO BE IN ACCORDANCE WITH CHAPTER 11 OF THE NRC, 2018 EDITION.
- REFER TO NOTES AND DETAIL SHEETS FOR ADDITIONAL STRUCTURAL INFORMATION.

150 MPH ULTIMATE DESIGN WIND SPEED
 NOTES FOR LESS THAN
 30' MEAN ROOF HEIGHT:

- ENGINEER'S SEAL APPLIES ONLY TO STRUCTURAL COMPONENTS. ENGINEER'S SEAL DOES NOT CERTIFY DIMENSIONAL ACCURACY OR ARCHITECTURAL LAYOUT INCLUDING ROOF SYSTEM.
- STRUCTURAL DESIGN PER NORTH CAROLINA RESIDENTIAL CODE, 2018 EDITION WITH SPECIAL CONSIDERATION TO CHAPTER 45 ("HIGH WIND ZONES" FOR 80 MPH WINDS).
- BUILDER IS TO PROVIDE FRAMING CONNECTIONS AS REQUIRED BY CHAPTER 45 ("HIGH WIND ZONES" FOR 80 MPH WINDS) OF THE NORTH CAROLINA RESIDENTIAL CODE, 2018 EDITION.
- FOUNDATION ANCHORAGE TO COMPLY WITH SECTION 45.04 OF THE NORTH CAROLINA RESIDENTIAL CODE, 2018 EDITION.
- MEAN ROOF HEIGHT IS LESS THAN 30 FEET.
- WALL CLADDING DESIGNED FOR 24.3 PSF AND -31 PSF (+/-). INDICATE POSITIVE / NEGATIVE PRESSURE (TYP.).
- ROOF CLADDING DESIGNED FOR 42.3 PSF AND -18 PSF FOR ROOF PITCHES 1/2 TO 1/12 AND 14 PSF AND -51 PSF FOR ROOF PITCHES 22/12 TO 1/12.
- 1/4" OSB SHEATHING IS REQUIRED ON ALL EXTERIOR WALLS.
- WALLS TO BE BRACED IN ACCORDANCE WITH SECTION R6.02.103 OF THE NORTH CAROLINA RESIDENTIAL CODE, 2018 EDITION AND AS NOTED ON PLANS.
- ENERGY EFFICIENCY COMPLIANCE AND INSULATION VALUES OF THE BUILDING TO BE IN ACCORDANCE WITH CHAPTER 11 OF THE NRC, 2018 EDITION.

**J.S. THOMPSON
 ENGINEERING INC.**
 600 WATKINS AVE. SUITE 104 RALEIGH, NC 27605
 PHONE: (919) 789-9919 FAX: (919) 789-9921
 N.C. LICENSE NO.: CA1713

VISION
 H & H HOMES



7/22/19

DATE: JULY 19, 2019
 SCALE: 1/4" = 1'-0"
 DRAWN BY: H & H HOMES, INC.
 ENGINEERED BY: WEB

SHEET 2 OF 8
 S-1b
 MONO SLAB
 FOUNDATION PLAN

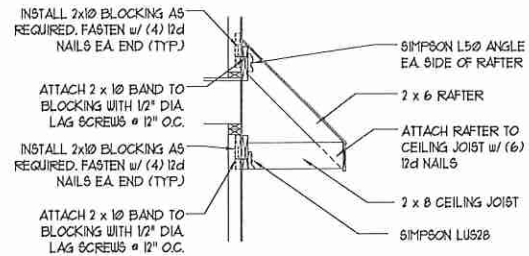

WATER TABLE DETAIL
SCALE: NTS

NOTE: ALL FIRST FLOOR EXTERIOR WALLS ARE TO BE 2 x 4 @ 16" O.C. (UNO). 2 x 6 @ 16" O.C. FIRST FLOOR EXTERIOR WALLS MAY BE CONSTRUCTED IN LIEU OF 2 x 4 WALLS (UNO). ALL INTERIOR LOAD BEARING AND NON-LOAD BEARING WALLS ARE TO BE 2 x 4 @ 16" O.C. (UNO).

SCALE NOTE:
LARGE FORMAT PRINTS ARE TO SCALE AS NOTED
11" x 17" PRINTS ARE ONE HALF THE NOTED SCALE

BRACED WALL DESIGN NOTES:

- BRACED WALL DESIGN PER SECTION R6-0210 OF THE NRC 2018 EDITION.
- C5-WSF REFERS TO "CONTINUOUS SHEATHING - WOOD STRUCTURAL PANELS" CONTRACTOR IS TO INSTALL 1/8" OSB ON ALL EXTERIOR WALLS ATTACHED w/ 8d NAILS SPACED 6" O.C. ALONG PANEL EDGES AND 12" O.C. IN THE FIELD.
- GB REFERS TO "GYPSUM BOARD" CONTRACTOR IS TO INSTALL 1/2" (MIN) GYPSUM WALL BOARD WHERE NOTED ON THE PLANS. FASTEN GB WITH 1 1/4" SCREWS OR 1 5/8" NAILS SPACED 7" O.C. ALONG PANEL EDGES AND IN THE FIELD INCLUDING TOP AND BOTTOM FLATES.
- BRACED WALL DESIGN APPLIED IN WIND ZONES UP TO 130 MPH. FOR HIGH WIND ZONES, BRACE WALLS ARE TO BE CONSTRUCTED IN ACCORDANCE WITH CHAPTER 45 OF THE NRC 2018 EDITION.
- SEE NOTES AND DETAIL SHEETS FOR ADDITIONAL BRACED WALL INFORMATION.

BRACED WALL DESIGN

RECTANGLE A		RECTANGLE B	
SIDE 1A METHOD: C5-WSF/FF TOTAL REQUIRED LENGTH: 11' TOTAL PROVIDED LENGTH: 16.11'	SIDE 1B METHOD: C5-WSF/FF TOTAL REQUIRED LENGTH: 3.8' TOTAL PROVIDED LENGTH: 6.0'	SIDE 2A METHOD: C5-WSF TOTAL REQUIRED LENGTH: 11' TOTAL PROVIDED LENGTH: 25.33'	SIDE 2B METHOD: C5-WSF TOTAL REQUIRED LENGTH: 3.8' TOTAL PROVIDED LENGTH: 12.0'
SIDE 3A METHOD: C5-WSF TOTAL REQUIRED LENGTH: 9.88' TOTAL PROVIDED LENGTH: 32.0'	SIDE 3B METHOD: C5-WSF TOTAL REQUIRED LENGTH: 8.36' TOTAL PROVIDED LENGTH: 20.0'	SIDE 4A METHOD: C5-WSF TOTAL REQUIRED LENGTH: 9.88' TOTAL PROVIDED LENGTH: 23.0'	SIDE 4B METHOD: C5-WSF/GB TOTAL REQUIRED LENGTH: 12.54' TOTAL PROVIDED LENGTH: 11.5'

STRUCTURAL NOTES:

- ALL FRAMING LUMBER TO BE 6FF 1/2 (UNO). ALL TREATED LUMBER TO BE 6TP 1/2 (UNO).
- ALL LOAD BEARING HEADERS TO BE (2) 2 x 6 (UNO).
- INSTALL AN EXTRA JOIST UNDER WALLS PARALLEL TO FLOOR JOISTS WHERE NOTED ON THE PLANS.
- WINDOW AND DOOR HEADERS TO BE SUPPORTED w/ (1) JACK STUD AND (1) KING STUD EA. END (UNO). SEE TABLE R6-02.15 FOR ADDITIONAL KING STUD REQUIREMENTS.
- SQUARES DENOTE POINT LOADS WHICH REQUIRE SOLID BLOCKING TO GIRDER OR FOUNDATION. ALL SQUARES TO BE (2) STUDS (UNO).
- FOR HIGH WIND ZONES, ALL EXTERIOR WALLS TO BE SHEATHED WITH 1/8" OSB SHEATHING WITH JOINTS BLOCKED AND SECURED WITH 8d NAILS AT 3" O.C. ALONG EDGES AND 6" O.C. IN THE FIELD.
- FOR HIGH WIND ZONES, SECURE ALL EXTERIOR WALL SHEATHING PANELS TO DOUBLE TOP FLATES, BANDS, JOISTS, AND GIRDERS WITH (2) ROWS OF 8d NAILS STAGGERED AT 3" O.C. PANELS SHALL EXTEND 12" BEYOND CONSTRUCTION JOINTS AND SHALL OVERLAP GIRDERS AND DOUBLE 9/16" PLATES THEIR FULL DEPTH.
- ALL 4 x 4 POSTS SHALL BE ANCHORED TO SLABS w/ SIMPSON ABU44 POST BASES (OR EQUAL) AND 6 x 6 POSTS w/ ABU66 POST BASES (OR EQUAL) (UNO). ALL 4 x 4 AND 6 x 6 POSTS TO BE INSTALLED WITH 100 LB CAPACITY UPLIFT CONNECTORS AT TOP (UNO).
- FOR FIBERGLASS, ALUMINUM, OR COLUMN ENG. BY OTHERS, SECURE TO SLAB w/ (2) METAL ANGLES USING 2" CONC. SCREWS. FASTEN ANGLES TO COLUMNS w/ 1/4" THROUGH BOLTS w/ NUTS AND WASHERS. LOCATE ANGLES ON OPPOSITE SIDES OF COLUMN. THROUGH BOLTS MUST BE INSTALLED PRIOR TO SETTING COLUMN.
- REFER TO NOTES AND DETAIL SHEETS FOR ADDITIONAL STRUCTURAL INFORMATION.

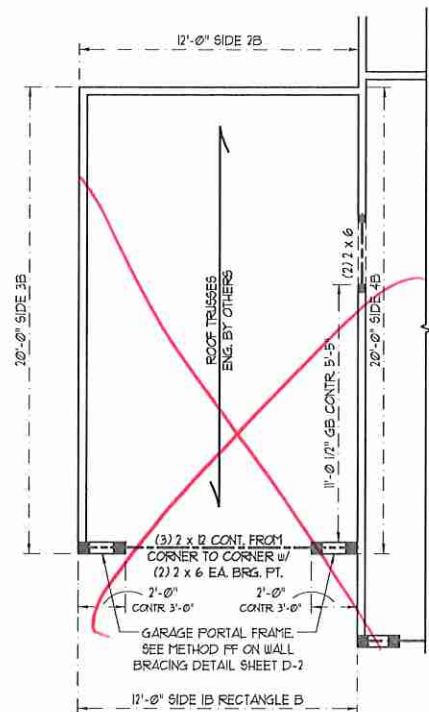

OPTIONAL THIRD CAR GARAGE

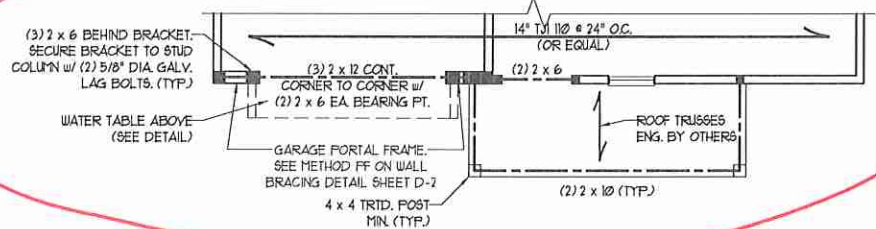

ELEVATION "C"

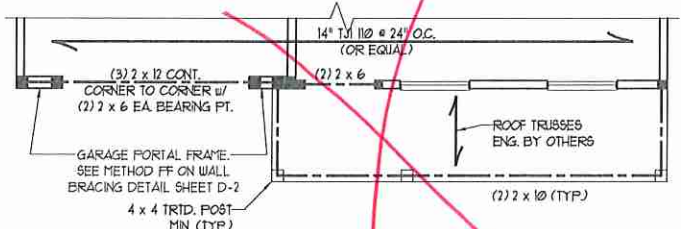

ELEVATION "B"

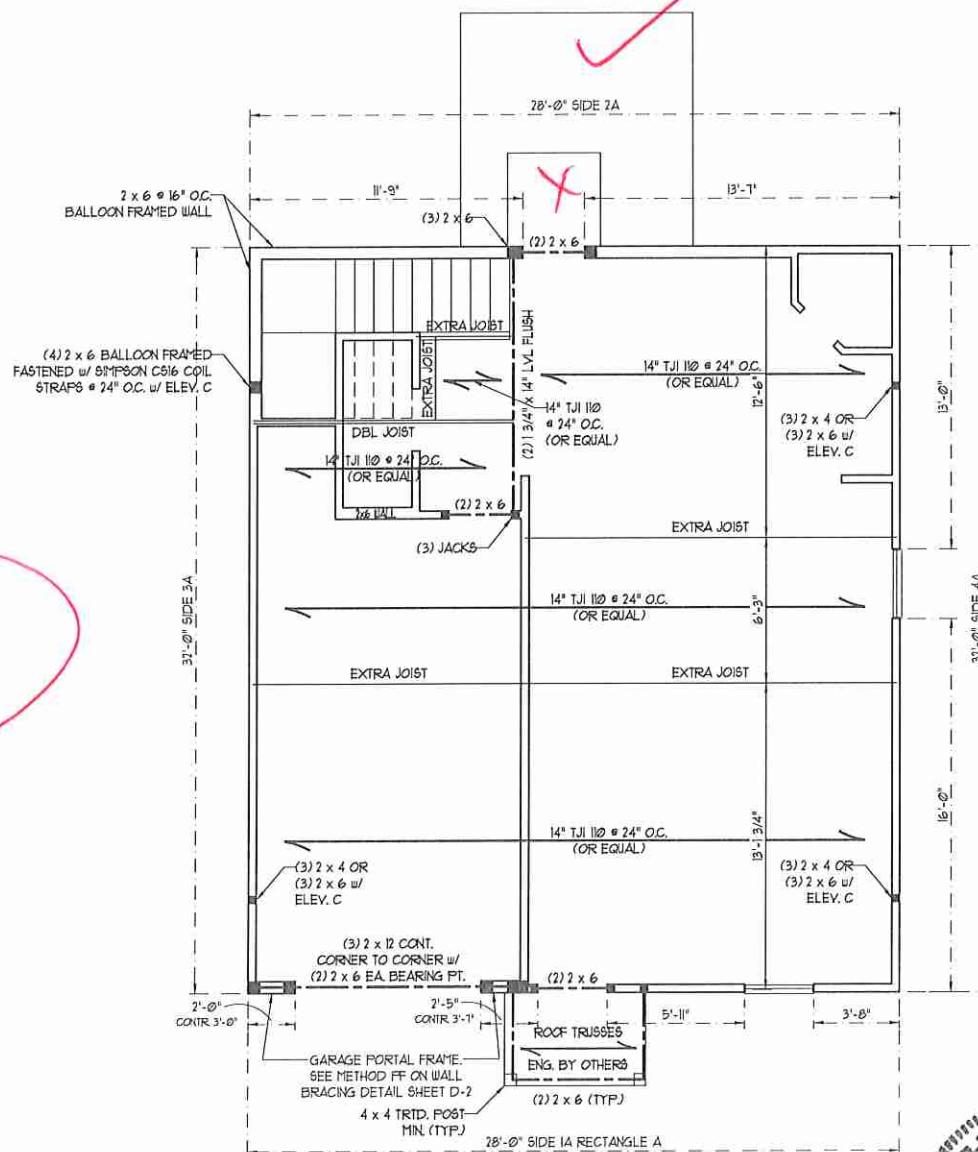

ELEVATION "A"

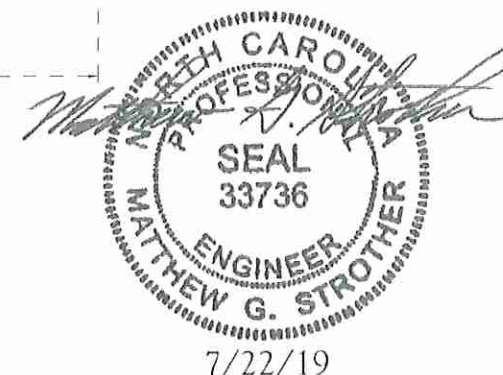

TABLE R6-02.15
MINIMUM NUMBER OF FULL HEIGHT STUDS AT EACH END OF HEADERS IN EXTERIOR WALLS

HEADER SPAN (FEET)	MAXIMUM STUD SPACING (INCHES) (PER TABLE R6-02.15)	
	16	24
UP TO 3'	1	1
4'	2	1
8'	3	2
12'	5	3
16'	6	4

J.S. THOMPSON ENGINEERING, INC.
605 WADE AVE. SUITE 104 RALEIGH, NC 27605
PHONE: (919) 789-9919 FAX: (919) 789-9921
N.C. LICENSE NO.: C17133

VISION
H & H HOMES

DATE: JULY 19, 2019
SCALE: 1/4" = 1'-0"
DRAWN BY: H & H HOMES, INC.
ENGINEERED BY: WJB

SHEET 4 OF 8
S-2
SECOND FLOOR FRAMING PLAN

NOTE: ALL SECOND FLOOR EXTERIOR WALLS AND ATTIC WALLS ARE TO BE 2 x 4 SFF 12 @ 24" O.C. 2 x 6 SFF 12 @ 24" O.C. (UNO). SECOND FLOOR EXTERIOR WALLS MAY BE CONSTRUCTED IN LIEU OF 2 x 4 WALLS (UNO). ALL INTERIOR LOAD BEARING AND NON-LOAD BEARING WALLS ARE TO BE 2 x 4 SFF 12 @ 24" O.C. (UNO).

SCALE NOTE:
LARGE FORMAT PRINTS ARE TO SCALE AS NOTED.
11" x 17" PRINTS ARE ONE HALF THE NOTED SCALE

- BRACED WALL DESIGN NOTES:**
- BRACED WALL DESIGN PER SECTION R60210 OF THE NRC 2018 EDITION.
 - C5-W5F REFERS TO "CONTINUOUS SHEATHING - WOOD STRUCTURAL PANELS" CONTRACTOR IS TO INSTALL 1/8" OSB ON ALL EXTERIOR WALLS ATTACHED w/ 8d NAILS SPACED 6" O.C. ALONG PANEL EDGES AND 12" O.C. IN THE FIELD.
 - GB REFERS TO "GYPSUM BOARD" CONTRACTOR IS TO INSTALL 1/2" (MIN) GYPSUM WALL BOARD WHERE NOTED ON THE PLANS. FASTEN GB WITH 1 1/4" SCREWS OR 1 5/8" NAILS SPACED 7" O.C. ALONG PANEL EDGES AND IN THE FIELD INCLUDING TOP AND BOTTOM FLATES.
 - BRACED WALL DESIGN AFFLIED IN WIND ZONES UP TO 130 MPH. FOR HIGH WIND ZONES, BRACE WALLS ARE TO BE CONSTRUCTED IN ACCORDANCE WITH CHAPTER 45 OF THE NRC 2018 EDITION.
 - SEE NOTES AND DETAIL SHEETS FOR ADDITIONAL BRACED WALL INFORMATION.

J.S. THOMPSON ENGINEERING, INC.
600 WADE AVE. SUITE 104 RALEIGH, NC 27605
PHONE: (919) 789-9919 FAX: (919) 789-9921
N.C. LICENSE NO.: C21733

- NOTE:**
- PER SECTION R60210.3.2 OF THE 2018 NRC, THE AMOUNT OF BRACING ON THE SECOND FLOOR EXCEEDS THE AMOUNT REQUIRED FOR THE FIRST FLOOR AND NO BRACED WALL ANALYSIS IS REQUIRED.
 - SHEATH ALL EXTERIOR WALLS WITH 1/8" OSB SHEATHING ATTACHED WITH 8d NAILS AT 6" O.C. ALONG PANEL EDGES AND 12" O.C. IN THE FIELD.

- STRUCTURAL NOTES:**
- ALL FRAMING LUMBER TO BE SFF 12 (UNO). ALL TREATED LUMBER TO BE SYP 12 (UNO).
 - ALL LOAD BEARING HEADERS TO BE (2) 2 x 6 (UNO).
 - WINDOW AND DOOR HEADERS TO BE SUPPORTED w/ (1) JACK STUD AND (1) KING STUD EA. END (UNO). SEE TABLE R60215 FOR ADDITIONAL KING STUD REQUIREMENTS.
 - SQUARES DEVOTE POINT LOADS WHICH REQUIRE SOLID BLOCKING TO GIRDER OR FOUNDATION. ALL SQUARES TO BE (2) STUDS (UNO).
 - FOR HIGH WIND ZONES, ALL EXTERIOR WALLS TO BE SHEATHED WITH 1/8" OSB SHEATHING WITH JOINTS BLOCKED AND SECURED WITH 8d NAILS AT 3" O.C. ALONG EDGES AND 6" O.C. IN THE FIELD.
 - FOR HIGH WIND ZONES, SECURE ALL EXTERIOR WALL SHEATHING PANELS TO DOUBLE TOP FLATES, BANDS, JOISTS, AND GIRDERS WITH (2) ROWS OF 8d NAILS STAGGERED AT 3" O.C. PANELS SHALL EXTEND 1" BEYOND CONSTRUCTION JOINTS AND SHALL OVERLAP GIRDERS AND DOUBLE SILL FLATES THEIR FULL DEPTH. REFER TO NOTES AND DETAIL SHEETS FOR ADDITIONAL STRUCTURAL INFORMATION.

D6P INDICATES DOUBLE STUD POCKET BETWEEN WINDOW UNITS.

TABLE R60215
MINIMUM NUMBER OF FULL HEIGHT STUDS AT EACH END OF HEADERS IN EXTERIOR WALLS

HEADER SPAN (FEET)	MAXIMUM STUD SPACINGS (INCHES) (PER TABLE R60215)	
	16	24
UP TO 3'	1	1
4'	2	1
8'	3	2
12'	5	3
16'	6	4

DATE: JULY 19, 2019
SCALE: 1/4" = 1'-0"
DRAWN BY: H & H HOMES, INC.
ENGINEERED BY: WEB

SHEET 5 OF 8
S-3
CEILING FRAMING PLAN

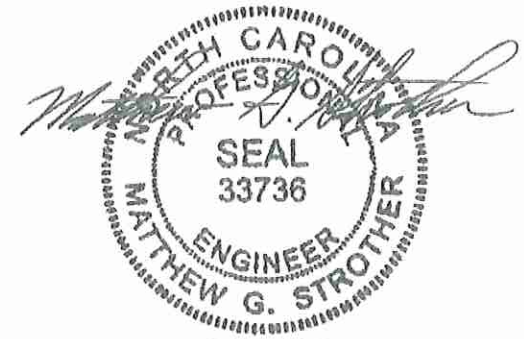
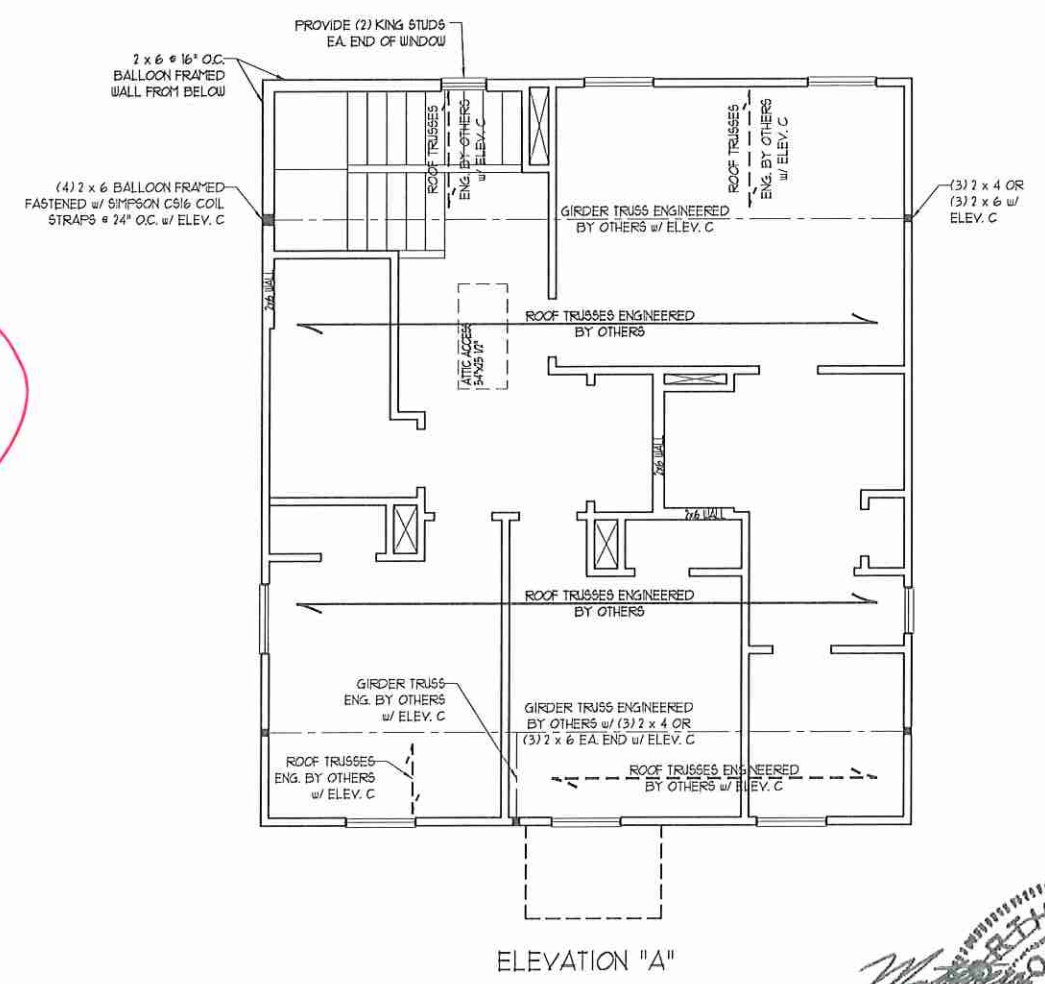
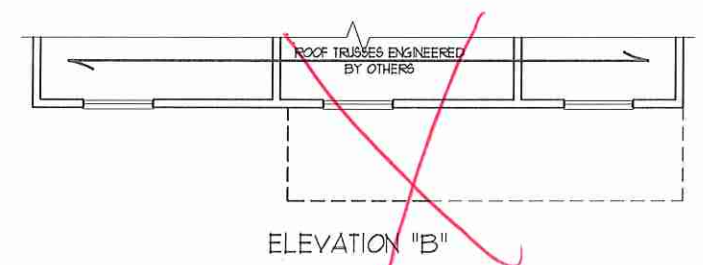
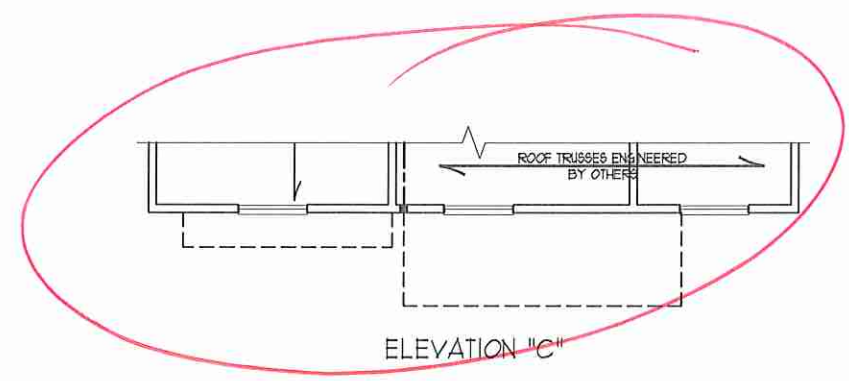

SCALE NOTE:
 LARGE FORMAT PRINTS ARE TO SCALE AS NOTED.
 11" x 17" PRINTS ARE ONE HALF THE NOTED SCALE

ATTIC VENT CALCULATION:
 921 SQ. FT. OF ATTIC DIVIDED BY
 150 REQUIRES 6.1 SQ. FT. OF NET
 FREE VENTILATING AREA (MIN).

- STRUCTURAL NOTES:
1. ALL FRAMING LUMBER TO BE #2 SFF (INO).
 2. CIRCLES DENOTE (3) 2 x 4 POSTS FOR ROOF SUPPORT.
 3. FRAME DORMER WALLS ON TOP OF DOUBLE OR TRIPLE RAFTERS.
 4. HIP SPLICES ARE TO BE SPACED A MIN. OF 8'-0". FASTEN MEMBERS WITH THREE ROWS OF 12d NAILS @ 16" O.C. (TYP.)
 5. STICK FRAME OVER-FRAMED ROOF SECTIONS W/ 2 x 8 RIDGES, 2 x 6 RAFTERS @ 16" O.C. AND FLAT 2 x 10 VALLEYS OR USE VALLEY TRUSSES.
 6. FASTEN FLAT VALLEYS TO RAFTERS OR TRUSSES WITH SIMPSON H25A HURRICANE TIES @ 32" O.C. MAX. PASS HURRICANE TIES THROUGH NOTCH IN ROOF SHEATHING. EACH RAFTER IS TO BE FASTENED TO THE FLAT VALLEY WITH A MIN. OF (6) 12d TOE NAILS.
 7. REFER TO SECTION R202.11 OF THE 2018 NRC FOR REQUIRED UPLIFT RESISTANCE AT RAFTERS AND TRUSSES.
 8. REFER TO NOTES AND DETAIL SHEETS FOR ADDITIONAL STRUCTURAL INFORMATION.

**J.S. THOMPSON
 ENGINEERING, INC.**
 608 WADE AVE. SUITE 104 RALEIGH, NC 27605
 PHONE: (919) 789-9919 FAX: (919) 789-9921
 N.C. LICENSE NO.: C-1713

VISION
 H & H HOMES

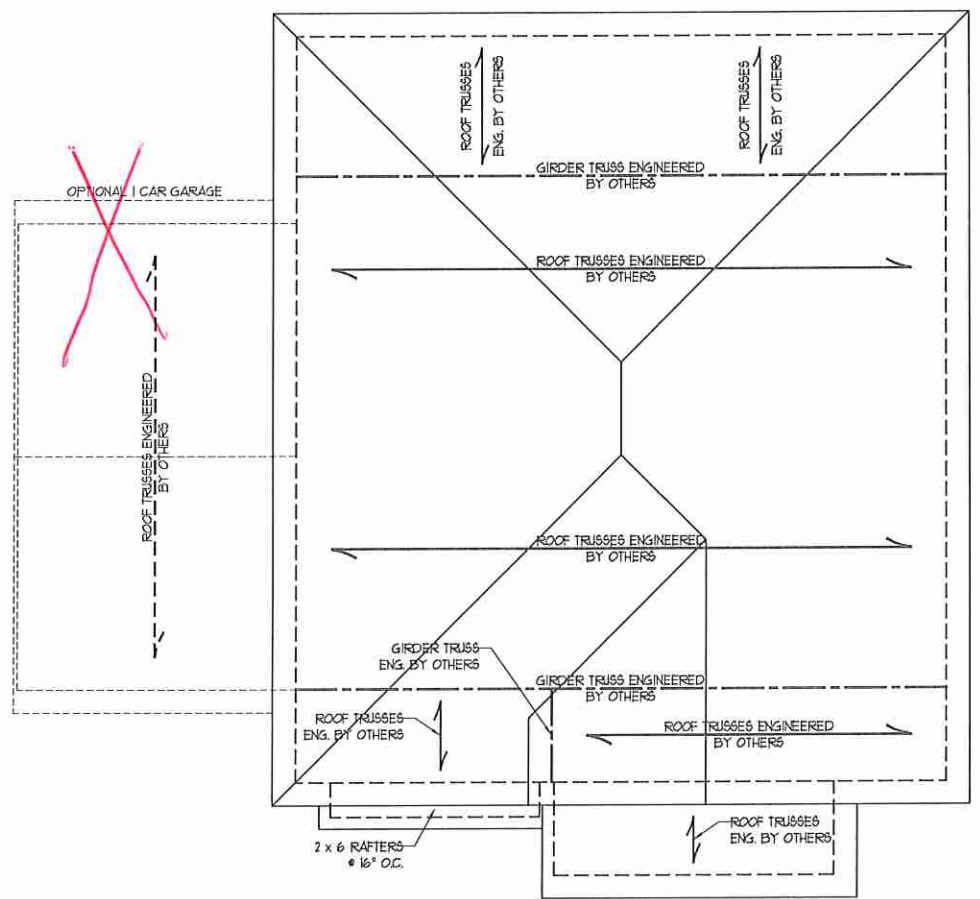

ELEVATION "C" - MODERN



7/22/19

DATE: JULY 19, 2019
 SCALE: 1/4" = 1'-0"
 DRAWN BY: H.A. HOMES, INC.
 ENGINEERED BY: WTB

SHEET 8 OF 8
 S-4c
 ROOF FRAMING
 PLAN

MONOLITHIC SLAB DETAILS

STEMWALL DETAILS

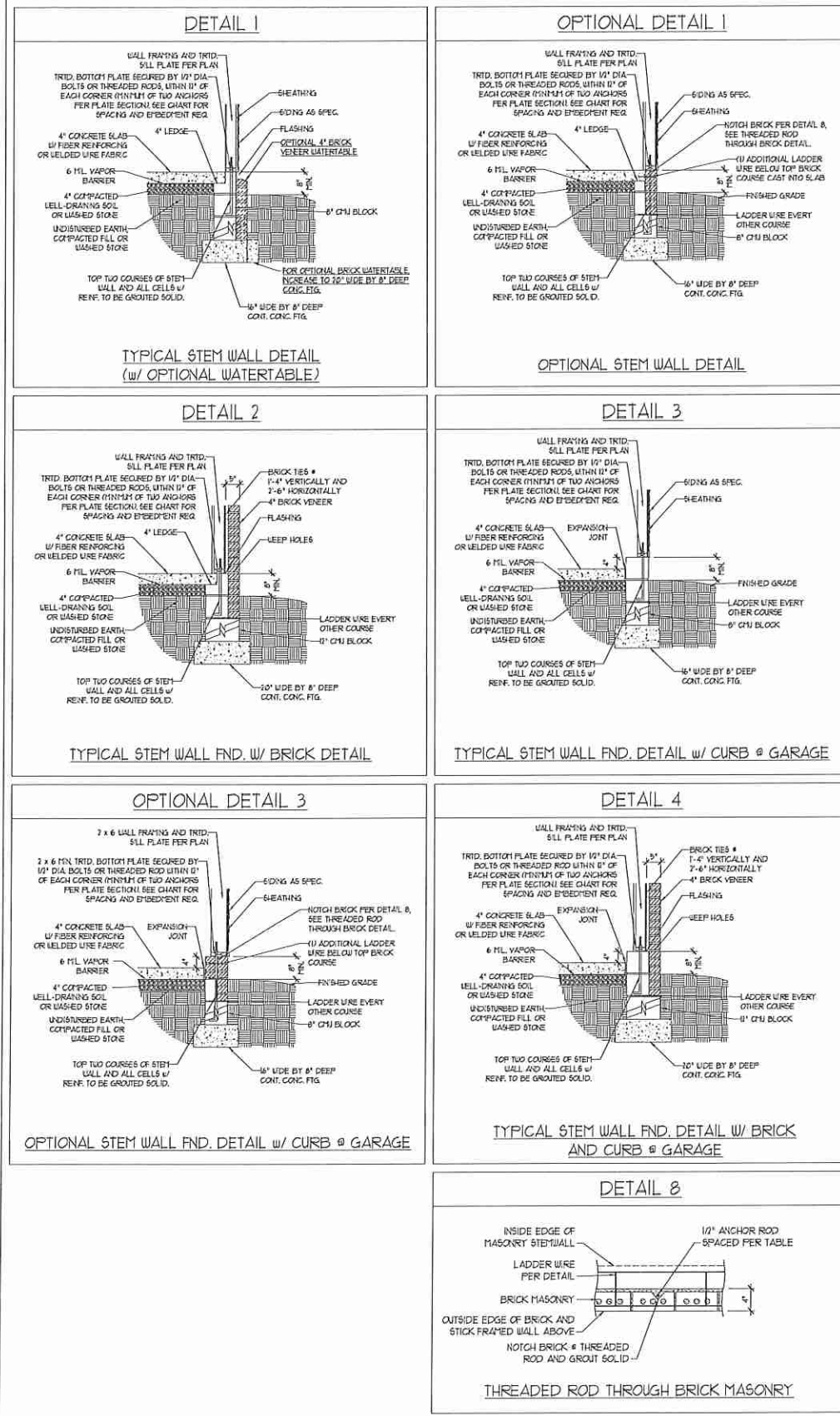
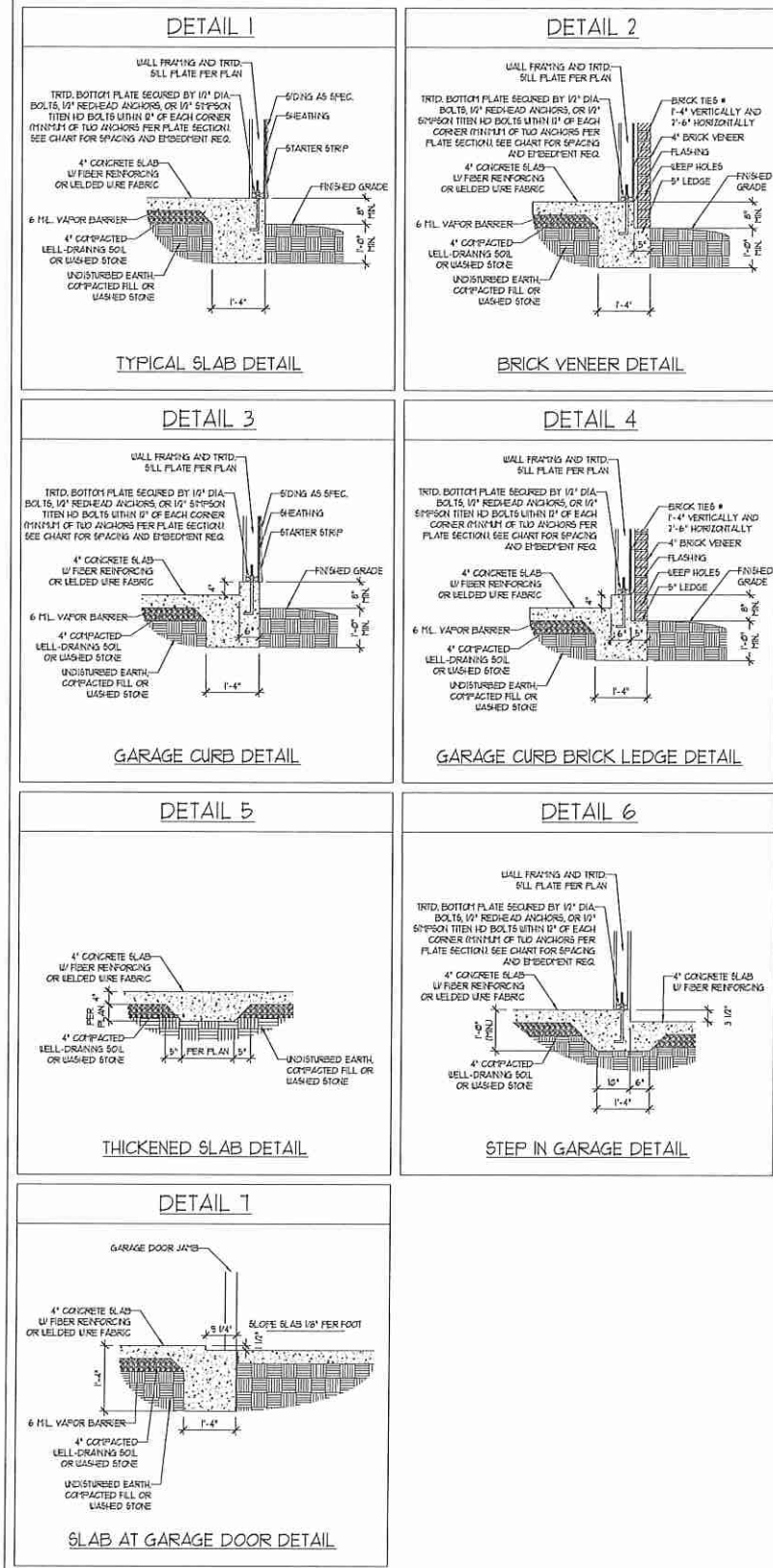

MASONRY STEMWALL SPECIFICATIONS

WALL HEIGHT (FEET)	MASONRY WALL TYPE			
	8" CMU	4" BRICK AND 4" CMU	4" BRICK AND 8" CMU	12" CMU
2 AND BELOW	UNGROUTED	GROUT SOLID	UNGROUTED	UNGROUTED
3	UNGROUTED	GROUT SOLID	UNGROUTED	UNGROUTED
4	GROUT SOLID	GROUT SOLID w/ #4 REBAR @ 48" O.C.	GROUT SOLID	GROUT SOLID w/ #4 REBAR @ 64" O.C.
5	GROUT SOLID w/ #4 REBAR @ 36" O.C.	NOT APPLICABLE	GROUT SOLID w/ #4 REBAR @ 36" O.C.	GROUT SOLID w/ #4 REBAR @ 64" O.C.
6	GROUT SOLID w/ #4 REBAR @ 24" O.C.	NOT APPLICABLE	GROUT SOLID w/ #4 REBAR @ 24" O.C.	GROUT SOLID w/ #4 REBAR @ 64" O.C.
7 AND GREATER	ENGINEERED DESIGN BASED ON SITE CONDITIONS			

- STRUCTURAL NOTES:
- WALL HEIGHT MEASURED FROM TOP OF FOOTING TO TOP OF THE WALL.
 - THE MULTIPLE WYTHES TOGETHER WITH LADDER WIRE AT 16" O.C. VERTICALLY.
 - CHART APPLICABLE FOR HOUSE FOUNDATION ONLY. CONSULT ENGINEER FOR DESIGN OF GARAGE FOUNDATION NOT COMMON TO HOUSE.
 - BACKFILL OF CLEAN #51 / #1 WASHED STONE IS ALLOWABLE.
 - BACKFILL OF WELL DRAINED OR SAND - GRAVEL MIXTURE SOILS (45 PERCENT BELOW GRADE) CLASSIFIED AS GROUP 1 ACCORDING TO UNIFIED SOILS CLASSIFICATION SYSTEM IN ACCORDANCE WITH TABLE R405) OF THE 2018 INTERNATIONAL RESIDENTIAL CODE ARE ALLOWABLE.
 - PREP SLAB PER R506.2) AND R506.2.2) BASE OF THE 2018 INTERNATIONAL RESIDENTIAL CODE. MINIMUM 24" LAP SPlice LENGTH.
 - LOCATE REBAR IN CENTER OF FOUNDATION WALL.
 - WHERE REQUIRED, FILL BLOCK SOLID WITH TYPE "S" MORTAR OR 3000 PSI GROUT. USE OF "LOW LET GROUTING" METHOD REQUIRED WHEN FILLING WALLS WITH GROUT AT HEIGHTS OF 5' AND GREATER.

ANCHOR SPACING AND EMBEDMENT

WIND ZONE	120 MPH	130 MPH
SPACING	6'-0" O.C.	4'-0" O.C.
EMBEDMENT	1"	5" INTO MASONRY 1" INTO CONCRETE

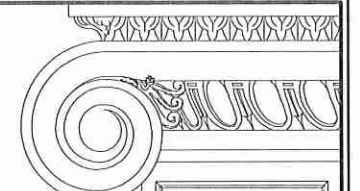

J.S. THOMPSON ENGINEERING, INC.
 606 WADE AVE., SUITE 104 RALEIGH, NC 27605
 PHONE: (919) 786-9119 FAX: (919) 786-9921
 N.C. LICENSE NO.: C-1713

120 MPH - 130 MPH ULTIMATE DESIGN WIND SPEED
 FOUNDATION DETAILS



DATE: NOVEMBER 14, 2018
 SCALE: NTS
 DRAWN BY: JST
 ENGINEERED BY: JST

D-1
 FOUNDATION DETAILS

GENERAL WALL BRACING NOTES:

1. WALL BRACING DESIGNED IN ACCORDANCE WITH CHAPTER 6 OF THE 2018 NC RESIDENTIAL BUILDING CODE (NCR). TABLES AND FIGURES REFERENCED ARE FROM THE 2018 NCR.
2. SEE THIS SHEET FOR GENERAL DETAILS. REFER TO THE 2018 NCR FOR ADDITIONAL INFORMATION AS NEEDED.
3. BRACED EXTERIOR WALLS SUPPORTING ROOF TRUSSES AND RAFTERS, INCLUDING STORIES BELOW THE TOP FLOOR, HAVE BEEN DESIGNED PER R602.3.5 (3) WALL SHEATHING AND FASTENERS HAVE BEEN DESIGNED TO RESIST COMBINED UPLIFT AND SHEAR FORCES IN ACCORDANCE WITH ACCEPTED ENGINEERING PRACTICE.
4. SEE STRUCTURAL SHEETS FOR BRACED WALL LOCATIONS, DIMENSIONS, HOLD DOWN TYPE AND LOCATIONS, BRACED WALL LINE KEY WITH WALL DESIGN SUMMARY OF REQUIRED/PROVIDED TOTALS FOR EACH WALL LINE AND ANY SPECIAL NOTES OR REQUIREMENTS.
5. ALL EXTERIOR WALLS ARE TO BE SHEATHED WITH CS-WSP IN ACCORDANCE WITH SECTION R602.10.3 UNLESS NOTED OTHERWISE.
6. ALL EXTERIOR AND INTERIOR WALLS TO HAVE 1/2" GYPSUM INSTALLED, WHEN NOT USING METHOD "GB", GYPSUM TO BE FASTENED PER TABLE R102.3.5, METHOD GB TO BE FASTENED PER TABLE R602.10.1
7. CS-WSP REFERS TO THE "CONTINUOUS SHEATHING - WOOD STRUCTURAL PANELS" WALL BRACING METHOD. 1/16" OSB SHEATHING IS TO BE INSTALLED ON ALL EXTERIOR WALLS ATTACHED w/ 6d COMMON NAILS OR 8d (2 1/2" LONG x Ø13) DIAMETER NAILS SPACED 6" O.C. ALONG PANEL EDGES AND 12" O.C. IN THE FIELD (UNO).
8. GB REFERS TO THE "GYPSUM BOARD" WALL BRACING METHOD. 1/2" (MIN) GYPSUM WALL BOARD IS TO BE INSTALLED ON BOTH SIDES OF THE BRACED WALL FASTENED WITH 1 1/4" SCREWS OR 1 5/8" NAILS SPACED 1" O.C. ALONG PANEL EDGES INCLUDING TOP AND BOTTOM PLATES AND INTERMEDIATE SUPPORTS (UNO). VERIFY ALL FASTENER OPTIONS FOR 1/2" AND 5/8" GYPSUM PRIOR TO CONSTRUCTION. FOR INTERIOR FASTENER OPTIONS SEE TABLE R102.3.5. FOR EXTERIOR FASTENER OPTIONS SEE TABLE R602.3.11. EXTERIOR GB TO BE INSTALLED VERTICALLY.
9. REQUIRED BRACED WALL LENGTH FOR EACH SIDE OF THE CIRCUMSCRIBED RECTANGLE ARE INTERPOLATED PER TABLE R602.10.3, METHOD CS-WSP CONTRIBUTES ITS ACTUAL LENGTH, METHOD GB CONTRIBUTES 5 TIMES ITS ACTUAL LENGTH, AND METHOD FF CONTRIBUTES 15 TIMES ITS ACTUAL LENGTH.

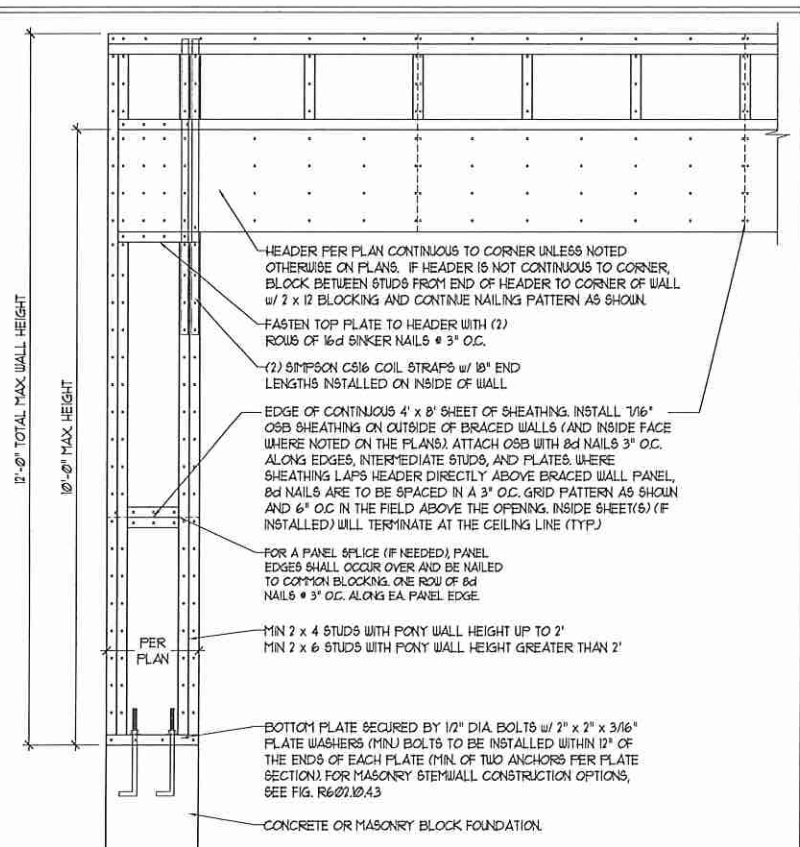

OVER CONCRETE OR MASONRY BLOCK FOUNDATION

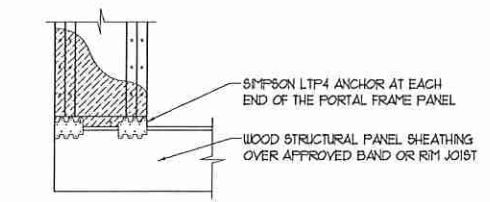

OVER RAISED WOOD FLOOR - FRAMING ANCHOR OPTION
* APPLICABLE w/ GREATER THAN 12" KNEE WALL HEIGHTS IN CRAWL SPACE AND ABOVE FRAMED BASEMENT WALLS *

METHOD PF-PORTAL FRAME DETAIL ①

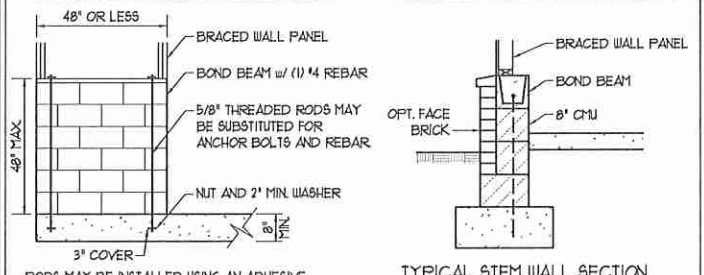
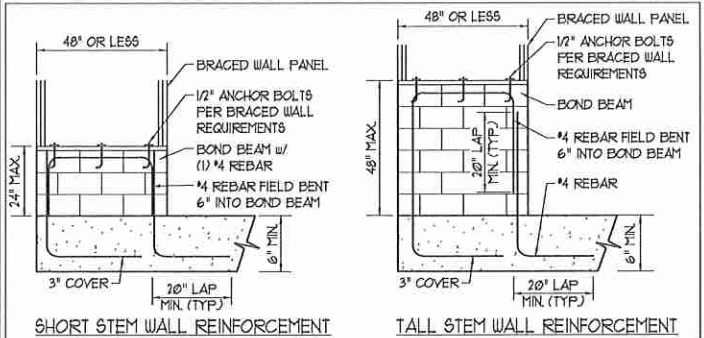

NOTE: GROUT BOND BEAMS AND ALL CELLS WHICH CONTAIN REBAR THREADED RODS AND ANCHOR BOLTS
MASONRY STEM WALLS SUPPORTING BRACED WALL PANELS ②
PER FIGURE R602.10.4.3

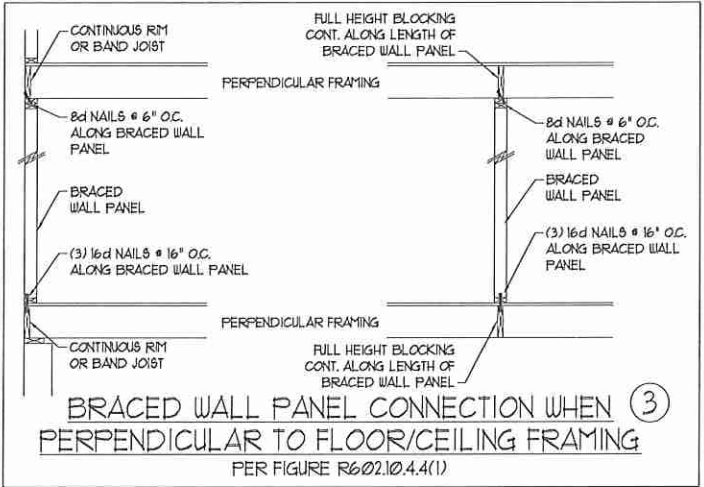

BRACED WALL PANEL CONNECTION WHEN PERPENDICULAR TO FLOOR/CEILING FRAMING ③
PER FIGURE R602.10.4.4(1)

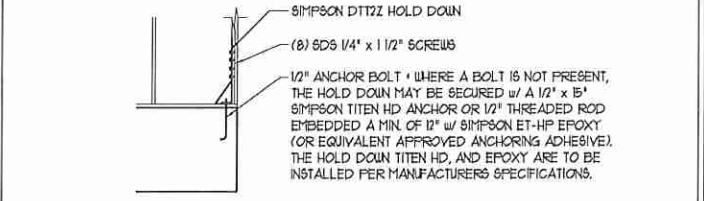

HOLD DOWN DETAIL FOR MASONRY FOUNDATION OR MONOLITHIC SLAB ④
* APPLICABLE ONLY WHERE SPECIFIED ON PLAN *

TYPICAL EXTERIOR CORNER FRAMING FOR CONTINUOUS SHEATHING ⑤
PER FIGURE R602.10.3(5)

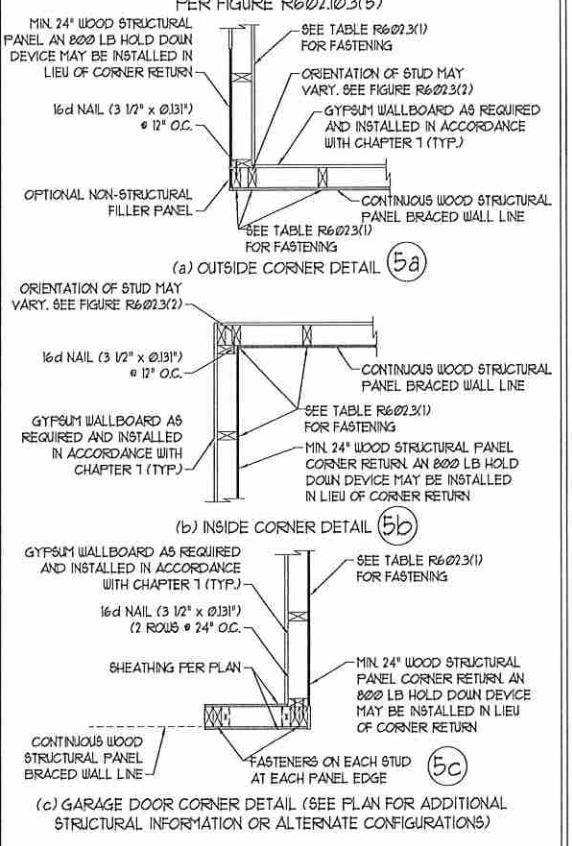

BRACED WALL PANEL CONNECTION WHEN PARALLEL TO FLOOR/CEILING FRAMING ⑥
PER FIG. R602.10.4.4(2)

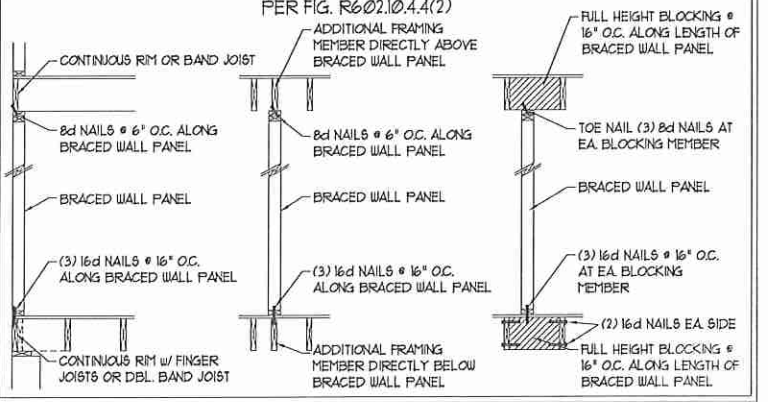

This sealed page is to be used in conjunction with a full plan set engineered by J.S. Thompson Engineering, Inc. only. Use of this individual sealed page within architectural pages or shop drawings by others is a punishable offense under N.C. Statute § 89C-23

SCALE NOTE:
LARGE FORMAT PRINTS ARE TO SCALE AS NOTED.
11" x 17" PRINTS ARE ONE HALF THE NOTED SCALE

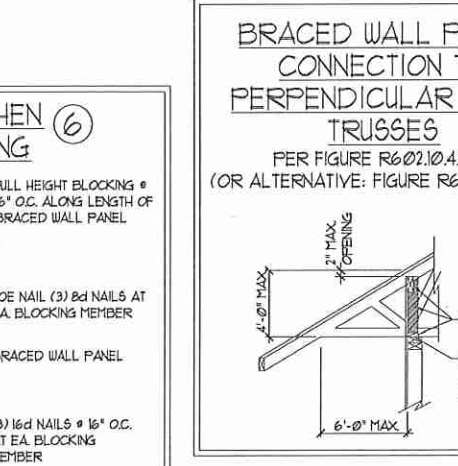
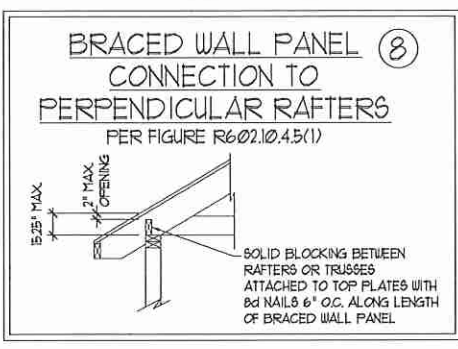
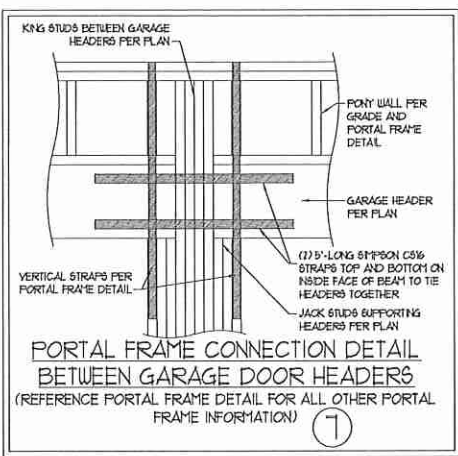

BRACED WALL PANEL CONNECTION TO PERPENDICULAR ROOF TRUSSES ⑨
PER FIGURE R602.10.4.5(3)
(OR ALTERNATIVE: FIGURE R602.10.4.5(2))

Professional Engineer Seal for Matthew G. Strother, State of North Carolina, License No. 33736. The seal is circular with the text 'NORTH CAROLINA PROFESSIONAL ENGINEER SEAL 33736 MATTHEW G. STROTHER' around the perimeter. The date 7/22/19 is stamped below the seal.

J.S. THOMPSON ENGINEERING INC.
605 WADE AVE. SUITE 104 BALEIGH, NC 27605
PHONE: (919) 789-9119 FAX: (919) 789-9921
N.C. LICENSE NO. C-1731

120 MPH - 130 MPH ULTIMATE DESIGN WIND SPEED
WALL BRACING NOTES AND DETAILS

DATE: OCTOBER 22, 2018
SCALE: 1/4" = 1'-0"
DRAWN BY: JST
ENGINEERED BY: JST

D-2
BRACED WALL NOTES AND DETAILS AND PF DETAILS

SCALE NOTE:
LARGE FORMAT PRINTS ARE TO SCALE AS NOTED.
11" x 17" PRINTS ARE ONE HALF THE NOTED SCALE

GENERAL NOTES

- ENGINEER'S SEAL APPLIES ONLY TO STRUCTURAL COMPONENTS INCLUDING ROOF RAFTERS, HIPS, VALLEYS, RIDGES, FLOORS, WALLS, BEAMS, HEADERS, COLUMNS, CANTILEVERS, OFFSET LOAD BEARING WALLS, PIERS, GIRDER SYSTEM AND FOOTING. ENGINEER'S SEAL DOES NOT CERTIFY DIMENSIONAL ACCURACY OF ARCHITECTURAL LAYOUT INCLUDING ROOF. ENGINEER'S SEAL DOES NOT APPLY TO I-JOIST OR FLOOR/ROOF TRUSS LAYOUT DESIGN AND ACCURACY.
- ALL CONSTRUCTION SHALL CONFORM TO THE LATEST REQUIREMENTS OF THE NORTH CAROLINA RESIDENTIAL CODE (NRC), 2018 EDITION, PLUS ALL LOCAL CODES AND REGULATIONS. THE STRUCTURAL ENGINEER IS NOT RESPONSIBLE FOR, AND WILL NOT HAVE CONTROL OF, CONSTRUCTION MEANS, METHODS, TECHNIQUES, SEQUENCES OR PROCEDURES, OR SAFETY PRECAUTIONS AND PROGRAMS IN CONNECTION WITH THE CONSTRUCTION WORK. NOR WILL THE ENGINEER BE RESPONSIBLE FOR THE CONTRACTOR'S FAILURE TO CARRY OUT THE CONSTRUCTION WORK IN ACCORDANCE WITH THE CONTRACT DOCUMENTS.
- STRUCTURAL DESIGN BASED ON THE PROVISIONS OF THE NRC, 2018 EDITION (R301.4 - R301.7)

DESIGN CRITERIA:	LIVE LOAD (PSF)	DEAD LOAD (PSF)	DEFLECTION (IN)
ATTIC WITH LIMITED STORAGE	20	10	L/240 (L/360 w/ BRITTLE FINISHES)
ATTIC WITHOUT STORAGE	10	10	L/360
DECKS	40	10	L/360
EXTERIOR BALCONIES	40	10	L/360
FIRE ESCAPES	40	10	L/360
HANDRAILS/GUARDRAILS	200 LB OR 50 (PLF)	10	L/360
PASSENGER VEHICLE GARAGE	50	10	L/360
ROOFS OTHER THAN SLEEPING ROOM	40	10	L/360
SLEEPING ROOMS	30	10	L/360
STAIRS	40	10	L/360
WIND LOAD	(BASED ON TABLE R301.2(4) WIND ZONE AND EXPOSURE)		
GROUND SNOW LOAD, Pg	20 (PSF)		

- I-JOIST SYSTEMS DESIGNED WITH 12 PSF DEAD LOAD AND DEFLECTION (IN) OF L/480
- FLOOR TRUSS SYSTEMS DESIGNED WITH 15 PSF DEAD LOAD

- FOR 15 AND 120 MPH WIND ZONES, FOUNDATION ANCHORAGE IS TO COMPLY WITH SECTION R403.16 OF THE NRC, 2018 EDITION. FOR 130 MPH, 140 MPH, AND 150 MPH WIND ZONES, FOUNDATION ANCHORAGE IS TO COMPLY WITH SECTION 450.4 OF THE NRC, 2018 EDITION.
- ENERGY EFFICIENCY COMPLIANCE AND INSULATION VALUES OF THE BUILDING TO BE IN ACCORDANCE WITH CHAPTER II OF THE NRC, 2018 EDITION.

FOOTING AND FOUNDATION NOTES

- FOUNDATION DESIGN BASED ON A MINIMUM ALLOWABLE BEARING CAPACITY OF 2000 PSF. CONTACT GEOTECHNICAL ENGINEER IF BEARING CAPACITY IS NOT ACHIEVED.
- FOR ALL CONCRETE SLABS AND FOOTINGS, THE AREA WITHIN THE PERIMETER OF THE BUILDING ENVELOPE SHALL HAVE ALL VEGETATION, TOP SOIL AND FOREIGN MATERIAL REMOVED. FILL MATERIAL SHALL BE FREE OF VEGETATION AND FOREIGN MATERIAL. THE FILL SHALL BE COMPACTED TO ASSURE UNIFORM SUPPORT OF THE SLAB, AND EXCEPT WHERE APPROVED, THE FILL DEPTHS SHALL NOT EXCEED 24" FOR CLEAN SAND OR GRAVEL. A 4" THICK BASED COURSE CONSISTING OF CLEAN GRADED SAND OR GRAVEL SHALL BE PLACED. A BASE COURSE IS NOT REQUIRED WHERE A CONCRETE SLAB IS INSTALLED ON WELL-DRAINED OR SAND-GRAVEL MIXTURE SOILS CLASSIFIED AS GROUP 1, ACCORDING TO THE UNITED SOIL CLASSIFICATION SYSTEM IN ACCORDANCE WITH TABLE R405.1 OF THE NRC, 2018 EDITION.
- PROPERLY DEWATER EXCAVATION PRIOR TO POURING CONCRETE WHEN BOTTOM OF CONCRETE SLAB IS AT OR BELOW WATER TABLE. IF APPLICABLE, 3/4" - 1" DEEP CONTROL JOINTS ARE TO BE SAUED WITHIN 4 TO 12 HOURS OF CONCRETE FINISHING AND WALL LOCATIONS HAVE BEEN MARKED. ADJUST WHERE NECESSARY.
- CONCRETE SHALL CONFORM TO SECTION R402.2 OF THE NRC, 2018 EDITION. CONCRETE REINFORCING STEEL TO BE ASTM A615 GRADE 60. WELDED WIRE FABRIC TO BE ASTM A105. MAINTAIN A MINIMUM CONCRETE COVER AROUND REINFORCING STEEL OF 3" IN FOOTINGS AND 1 1/2" IN SLABS. FOR FOURED CONCRETE WALLS, CONCRETE COVER FOR REINFORCING STEEL MEASURED FROM THE INSIDE FACE OF THE WALL SHALL NOT BE LESS THAN 3/4". CONCRETE COVER FOR REINFORCING STEEL MEASURED FROM THE OUTSIDE FACE OF THE WALL SHALL NOT BE LESS THAN 1 1/2" FOR #5 BARS OR SMALLER, AND NOT LESS THAN 2" FOR #6 BARS OR LARGER.
- MASONRY UNITS TO CONFORM TO ACE 530/ASCE 5/TMS 402. MORTAR SHALL CONFORM TO ASTM C770.
- THE UNSUPPORTED HEIGHT OF MASONRY PIERS SHALL NOT EXCEED FOUR TIMES THEIR LEAST DIMENSION FOR UNFILLED HOLLOW CONCRETE MASONRY UNITS AND TEN TIMES THEIR LEAST DIMENSION FOR SOLID FILLED PIERS. PIERS MAY BE FILLED SOLID WITH CONCRETE OR TYPE M OR S MORTAR. PIERS AND WALLS SHALL BE CAPPED WITH 8" OF SOLID MASONRY.
- THE CENTER OF EACH OF THE PIERS SHALL BEAR IN THE MIDDLE THIRD OF ITS RESPECTIVE FOOTING. EACH GIRDER SHALL BEAR IN THE MIDDLE THIRD OF THE PIERS.
- ALL CONCRETE AND MASONRY FOUNDATION WALLS ARE TO BE CONSTRUCTED IN ACCORDANCE WITH THE PROVISIONS OF SECTION R404 OF THE NRC, 2018 EDITION OR IN ACCORDANCE WITH ACI 318, ACI 332, NCMR TR68-A OR ACE 530/ASCE 5/TMS 402. MASONRY FOUNDATION WALLS ARE TO BE REINFORCED PER TABLE R404.1(1), R404.1(2), R404.1(3), OR R404.1(4) OF THE NRC, 2018 EDITION. CONCRETE FOUNDATION WALLS ARE TO BE REINFORCED PER TABLE R404.1(5) OF THE NRC, 2018 EDITION. STEP CONCRETE FOUNDATION WALLS TO 2 x 6 FRAME WALLS AT 16" O.C. WHERE GRADE PERMITS (UNO).

This sealed page is to be used in conjunction with a full plan set engineered by J.S. Thompson Engineering, Inc. only. Use of this individual sealed page within architectural pages or shop drawings by others is a punishable offense under N.C. Statute § 89C-23

FRAMING NOTES

- ALL FRAMING LUMBER SHALL BE #2 GFF MINIMUM (Fb = 815 PSI, Fv = 375 PSI, E = 1600000 PSI) UNLESS NOTED OTHERWISE (UNO). ALL TREATED LUMBER SHALL BE #2 SYP MINIMUM (Fb = 975 PSI, Fv = 475 PSI, E = 1600000 PSI) UNLESS NOTED OTHERWISE (UNO).
- LAMINATED VENEER LUMBER (LVL) SHALL HAVE THE FOLLOWING MINIMUM PROPERTIES: Fb = 2600 PSI, Fv = 285 PSI, E = 1800000 PSI. LAMINATED STRAND LUMBER (LSL) SHALL HAVE THE FOLLOWING MINIMUM PROPERTIES: Fb = 2375 PSI, Fv = 310 PSI, E = 1500000 PSI. PARALLEL STRAND LUMBER (PSL) UP TO 1" DEPTH SHALL HAVE THE FOLLOWING MINIMUM PROPERTIES: Fc = 2500 PSI, E = 1800000 PSI. PARALLEL STRAND LUMBER (PSL) MORE THAN 1" DEPTH SHALL HAVE THE FOLLOWING MINIMUM PROPERTIES: Fc = 2900 PSI, E = 2000000 PSI. INSTALL ALL CONNECTIONS PER MANUFACTURER'S SPECIFICATIONS.
- STRUCTURAL STEEL SHALL CONFORM TO THE FOLLOWING ASTM SPECIFICATIONS

A. W AND WT SHAFES:	ASTM A992
B. CHANNELS AND ANGLES:	ASTM A36
C. FLATES AND BARS:	ASTM A36
D. HOLLOW STRUCTURAL SECTIONS:	ASTM A500 GRADE B
E. STEEL PIPE:	ASTM A53, GRADE B, TYPE E OR S
- STEEL BEAMS SHALL BE SUPPORTED AT EACH END WITH A MINIMUM BEARING LENGTH OF 3 1/2" AND FULL FLANGE WIDTH (UNO). PROVIDE SOLID BEARINGS FROM BEAM SUPPORT TO FOUNDATION. BEAMS SHALL BE ATTACHED AT THE BOTTOM FLANGE TO EACH SUPPORT AS FOLLOWS (UNO):

A. WOOD FRAMING	(2) 1/2" DIA x 4" LONG LAG SCREWS
B. CONCRETE	(2) 1/2" DIA x 4" WEDGE ANCHORS
C. MASONRY (FULLY GROUTED)	(2) 1/2" DIA x 4" LONG SIMPSON TITEN HD ANCHORS

LATERAL SUPPORT IS CONSIDERED ADEQUATE PROVIDING THE JOISTS ARE TOE NAILED TO THE 2x NAILER ON TOP OF THE STEEL BEAM, AND THE 2x NAILER IS SECURED TO THE TOP OF THE STEEL BEAM w/ (2) ROWS OF SELF TAPPING SCREWS @ 16" O.C. OR (1) ROWS OF 1/2" DIAMETER BOLTS @ 16" O.C. IF 1/2" BOLTS ARE USED TO FASTEN THE NAILER, THE STEEL BEAM SHALL BE FABRICATED w/ (2) ROWS OF 9/16" DIAMETER HOLES @ 16" O.C.
- SQUARES DENOTE POINT LOADS WHICH REQUIRE SOLID BLOCKING TO GIRDER OR FOUNDATION. SHADED SQUARES DENOTE POINT LOADS FROM ABOVE WHICH REQUIRE SOLID BLOCKING TO SUPPORTING MEMBER BELOW.
- ALL LOAD BEARING HEADERS TO CONFORM TO TABLE R602.1(1) AND R602.1(2) OF THE NRC, 2018 EDITION OR BE (2) 2 x 6 WITH (1) JACK AND (1) KING STUD EACH END (UNO) WHICHEVER IS GREATER. ALL HEADERS TO BE SECURED TO EACH JACK STUD WITH (4) 8d NAILS. ALL BEAMS TO BE SUPPORTED WITH (2) STUDS AT EACH BEARING POINT (UNO). INSTALL KING STUDS PER SECTION R602.15 OF THE NORTH CAROLINA RESIDENTIAL CODE, 2018 EDITION.
- ALL BEAMS, HEADERS, OR GIRDER TRUSSES PARALLEL TO WALL ARE TO BEAR FULLY ON (1) JACK OR (2) STUDS MINIMUM OR THE NUMBER OF JACKS OR STUDS NOTED. ALL BEAMS OR GIRDER TRUSSES PERPENDICULAR TO WALL AND SUPPORTED BY (3) STUDS OR LESS ARE TO HAVE 1 1/2" MINIMUM BEARING (UNO). ALL BEAMS OR GIRDER TRUSSES PERPENDICULAR TO WALL AND SUPPORTED BY MORE THAN (3) STUDS OR OTHER NOTED COLUMN ARE TO BEAR FULLY ON SUPPORT COLUMN FOR ENTIRE WALL DEPTH (UNO). BEAM ENDS THAT BUTT INTO ONE ANOTHER ARE TO EACH BEAR EQUAL LENGTHS (UNO).
- FLITCH BEAMS SHALL BE BOLTED TOGETHER USING 1/2" DIAMETER BOLTS (ASTM A307) WITH WASHERS PLACED AT THREADED END OF BOLT. BOLTS SHALL BE SPACED AT 24" CENTERS (MAXIMUM), AND STAGGERED AT TOP AND BOTTOM OF BEAM (2" EDGE DISTANCE), WITH (2) BOLTS LOCATED AT 6" FROM EACH END (UNO).
- ALL I-JOIST OR TRUSS LAYOUTS ARE TO BE IN COMPLIANCE WITH THE OVERALL DESIGN SPECIFIED ON THE PLANS. ALL DEVIATIONS ARE TO BE BROUGHT TO THE ATTENTION OF THE ENGINEER OF RECORD PRIOR TO INSTALLATION.
- BRACED WALL PANELS SHALL BE CONSTRUCTED ACCORDING TO THE NORTH CAROLINA RESIDENTIAL CODE 2018 EDITION WALL BRACING CRITERIA. THE AMOUNT, LENGTH, AND LOCATION OF BRACING SHALL COMPLY WITH ALL APPLICABLE TABLES IN SECTION R602.10.
- PROVIDE DOUBLE JOIST UNDER ALL WALLS PARALLEL TO FLOOR JOISTS. PROVIDE SUPPORT UNDER ALL WALLS PARALLEL TO FLOOR TRUSSES OR I-JOISTS PER MANUFACTURER'S SPECIFICATIONS. INSTALL BLOCKING BETWEEN JOISTS OR TRUSSES FOR POINT LOAD SUPPORT FOR ALL POINT LOADS ALONG OFFSET LOAD LINES.
- FOR ALL HEADERS SUPPORTING BRICK VENEER THAT ARE LESS THAN 8'-0" IN LENGTH, REST A 6" x 4" x 5/16" STEEL ANGLE WITH 6" MINIMUM EMBEDMENT AT SIDES FOR BRICK SUPPORT (UNO). FOR ALL HEADERS 8'-0" AND GREATER IN LENGTH, BOLT A 6" x 4" x 5/16" STEEL ANGLE TO HEADER WITH 1/2" LAG SCREWS AT 12" O.C. STAGGERED FOR BRICK SUPPORT. FOR ALL BRICK SUPPORT AT ROOF LINES, BOLT A 6" x 4" x 5/16" STEEL ANGLE TO (2) 2 x 10 BLOCKING INSTALLED w/ (4) 12d NAILS EA. FLY BETWEEN WALL STUDS WITH (2) ROWS OF 1/2" LAG SCREWS AT 12" O.C. STAGGERED AND IN ACCORDANCE WITH SECTION R103.8(2) OF THE NRC, 2018 EDITION.
- FOR STICK FRAMED ROOFS, CIRCLES DENOTE (3) 2 x 4 POSTS FOR ROOF MEMBER SUPPORT. HIP SPLICES ARE TO BE SPACED A MINIMUM OF 8'-0". FASTEN MEMBERS WITH THREE ROWS OF 12d NAILS AT 16" O.C. FRAME DORMER WALLS ON TOP OF DOUBLE OR TRIPLE RAFTERS AS SHOWN (UNO).
- FOR TRUSSED ROOFS, FRAME DORMER WALLS ON TOP OF 2 x 4 LADDER FRAMING AT 24" O.C. BETWEEN ADJACENT ROOF TRUSSES. STICK FRAME OVER-FRAMED ROOF SECTIONS WITH 2 x 8 RIDGES, 2 x 6 RAFTERS AT 16" O.C. AND FLAT 2 x 10 VALLEYS (UNO).
- ALL 4 x 4 AND 6 x 6 POSTS TO BE INSTALLED WITH 100 LB CAPACITY UPLIFT CONNECTORS TOP AND BOTTOM (UNO). POSTS MAY BE SECURED USING ONE SIMPSON H6 OR L1512 UPLIFT CONNECTOR FASTENED TO THE BAND AT THE BOTTOM AND THE BEAM AT THE TOP OF EACH POST. ONE 16" SECTION OF SIMPSON C816 COIL STRAPPING WITH (8) 8d HDG NAILS AT EACH END MAY BE USED IN LIEU OF EACH TWIST STRAP IF DESIRED. FOR MASONRY OR CONCRETE FOUNDATION USE SIMPSON POST BASE.

J.S. THOMPSON ENGINEERING, INC.
600 WADE AVE., SUITE 1014, RENO, NC 27605
PHONE: (704) 949-1019 FAX: (704) 789-9921
N.C. LICENSE NO.: C-1733

120 MPH - 130 MPH ULTIMATE DESIGN WIND SPEED
STANDARD STRUCTURAL NOTES



DATE: NOVEMBER 14, 2018
DRAWN BY: JES
ENGINEERED BY: JST

S-0
STRUCTURAL
NOTES

7/22/19