



# NORTH CAROLINA 40' SERIES PLAN 240.2596-R

## LOT 7 MASON POINTE - ELEVATION C

### SHEET INDEX

#### PLAN #240.2596-R

- TS TITLE SHEET
- GN1 GENERAL NOTES
- GN2 GENERAL NOTES
- GN3 GENERAL NOTES
- 1.1 FIRST FLOOR PLAN
- 1.2 SECOND FLOOR PLAN
- 1.3 FIRST FLOOR PLAN W/ CRAWL SPACE
- 1.4 FIRST FLOOR PLAN OPTIONS
- 1.5 SECOND FLOOR PLAN OPTIONS
- 2.1 SLAB INTERFACE PLAN 'A'
- 2.2 PARTIAL SLAB INTERFACE PLAN 'B', 'C', & 'D'
- 2.3 CRAWL SPACE FOUNDATION PLAN 'A'
- 2.4 PARTIAL CRAWL SPACE FOUNDATION PLAN 'B', 'C', & 'D'
- 2.5 SLAB INTERFACE PLAN OPTIONS
- 3.A1 ROOF PLAN, FRONT & REAR ELEVATIONS 'A'
- 3.A2 LEFT & RIGHT ELEVATIONS 'A'
- 3.A3 PARTIAL FIRST FLOOR PLAN, FRONT & RIGHT ELEVATIONS 'A' AT CRAWL SPACE
- 3.A4 PARTIAL FRONT & RIGHT ELEVATIONS AT CONCRETE PORCH
- 3.A5 FRONT ELEVATIONS 'A' AT OPTIONAL 9'-1" PLATE HEIGHT
- 3.A6 PARTIAL RIGHT, LEFT, AND FRONT ELEVATION 'A' W/ MASONRY OPT #1 AND #2
- 3.B1 PARTIAL FIRST & SECOND FLOOR PLANS 'B'
- 3.B2 ROOF PLAN, FRONT & REAR ELEVATIONS 'B'
- 3.B3 LEFT & RIGHT ELEVATIONS 'B'
- 3.B4 PARTIAL FIRST FLOOR PLAN, FRONT & RIGHT ELEVATIONS 'B' AT CRAWL SPACE
- 3.B5 PARTIAL FRONT & RIGHT ELEVATIONS AT CONCRETE PORCH
- 3.B6 FRONT ELEVATIONS 'B' AT OPTIONAL 9'-1" PLATE HEIGHT
- 3.B7 PARTIAL FLOOR PLAN, ROOF, FRONT ELEVATION, PARTIAL RIGHT ELEVATION 'B' AT EXTENDED PORCH OPTION
- 3.B8 PARTIAL RIGHT, LEFT, AND FRONT ELEVATION 'B' W/ STONE
- 3.C1 PARTIAL FIRST & SECOND FLOOR PLANS 'C'
- 3.C2 ROOF PLAN, FRONT & REAR ELEVATIONS 'C'
- 3.C3 LEFT & RIGHT ELEVATIONS 'C'
- 3.C4 PARTIAL FIRST FLOOR PLAN, FRONT & RIGHT ELEVATIONS 'C' AT CRAWL SPACE
- 3.C5 PARTIAL FRONT & RIGHT ELEVATIONS AT CONCRETE PORCH
- 3.C6 FRONT ELEVATIONS 'C' AT OPTIONAL 9'-1" PLATE HEIGHT
- 3.C7 PARTIAL FLOOR PLAN, ROOF, FRONT ELEVATION, PARTIAL RIGHT ELEVATION 'C' AT EXTENDED PORCH OPTION
- 3.C8 PARTIAL RIGHT, LEFT, AND FRONT ELEVATION 'C' W/ STONE OPT #1 AND #2
- 3.C9 PARTIAL RIGHT, LEFT, AND FRONT ELEVATION 'C' W/ STONE OPT #1 AND #2 AT EXTENDED PORCH OPTION
- 3.D1 PARTIAL FIRST & SECOND FLOOR PLANS 'D'
- 3.D2 ROOF PLAN, FRONT & REAR ELEVATIONS 'D'
- 3.D3 LEFT & RIGHT ELEVATIONS 'D'
- 3.D4 PARTIAL FIRST FLOOR PLAN, FRONT & RIGHT ELEVATIONS 'D' AT CRAWL SPACE
- 3.D5 PARTIAL FRONT & RIGHT ELEVATIONS W/ OPTIONAL MASONRY AT CONCRETE PORCH
- 3.D6 FRONT ELEVATIONS 'D' AT OPTIONAL 9'-1" PLATE HEIGHT
- 3.D7 PARTIAL RIGHT, LEFT, AND FRONT ELEVATION 'D' W/ STONE OPT #1 AND #2

- 4.1 INTERIOR ELEVATIONS
- 4.2 SECTIONS
- 4.3 SECTIONS AT CRAWL SPACE
- 5.1 FIRST FLOOR UTILITY PLAN
- 5.2 SECOND FLOOR UTILITY PLAN
- 5.3 FIRST FLOOR UTILITY PLAN OPTIONS
- 5.4 SECOND FLOOR UTILITY PLAN OPTIONS
- 7.1 PARTIAL FLOOR PLANS & ELEVATIONS W/ OPT. 12'X12' DECK AT CRAWL SPACE
- 7.2 PARTIAL FLOOR PLANS & ELEVATIONS W/ OPT. 12'X24' DECK AT CRAWL SPACE
- 7.3 PARTIAL FLOOR PLANS & ELEVATIONS W/ OPT. 12'X12' SCREENED-IN DECK AT CRAWL SPACE
- 7.4 PARTIAL FLOOR PLANS & ELEVATIONS W/ OPT. 12'X24' SCREENED-IN DECK AT CRAWL SPACE
- 7.5 PARTIAL FLOOR PLANS & ELEVATIONS W/ OPT. SUNROOM AT SLAB INTERFACE
- 7.6 PARTIAL FLOOR PLANS & ELEVATIONS W/ OPT. SUNROOM AT CRAWL SPACE
- 8.1 PARTIAL FLOOR PLAN, ROOF & ELEVATIONS W/ OPT. COVERED PATIO
- 8.2 PARTIAL FLOOR PLAN, ROOF & ELEVATIONS W/ OPT. EXTENDED COVERED PATIO
- 8.3 PARTIAL FLOOR PLAN, ROOF & ELEVATIONS W/ OPT. SCREENED-IN COVERED PATIO
- 8.4 PARTIAL FLOOR PLAN, ROOF & ELEVATIONS W/ OPT. SCREENED-IN EXTENDED COVERED PATIO
- AD1 ARCHITECTURAL DETAILS
- AD2 ARCHITECTURAL DETAILS
- AD3 ARCHITECTURAL DETAILS
- AD4 ARCHITECTURAL DETAILS
- AD5 ARCHITECTURAL DETAILS
- AD6 ARCHITECTURAL DETAILS
- AD7 ARCHITECTURAL DETAILS
- AD8 ARCHITECTURAL DETAILS

### ABBREVIATIONS

ABV.	ABOVE	G.F.I.	GROUND-FAULT	R.O.	ROUGH OPENING
A/C	AIR CONDITIONING	CIRCUIT	CIRCUIT INTERRUPTER	S & P	SHELF AND POLE
ADJ.	ADJUSTABLE	G.I.	GALVANIZED IRON	S.C.	SOLID CORE
ALT	ALTERNATE	GL.	GLASS	S.D.	SMOKE DETECTOR
AMP.	AMPERAGE	GYP. BD.	GYP. BOARD	SEC.	SECTION
BD.	BOARD	H.C.	HOLLOW CORE	S.H.	SINGLE HUNG
CL.	CENTER LINE	HDR.	HEADER	SHT.	SHEET
CAB.	CABINET	HGT. / HT.	HEIGHT	SHTR.	SHEATHING
CLS.	CEILING	H.H.	HEADER HEIGHT	SHWR.	SHOWER
CLR.	CLEAR	H.S.	HORIZONTAL SLIDER	SIM.	SIMILAR
CONC.	CONCRETE	I.L.O.	IN LIEU OF	SL. GL.	SLIDING GLASS
CPT.	CARPET	INSUL.	INSULATION	STD.	STANDARD
D.	DRYER	INT.	INTERIOR	S.V.	SHEET VINYL
DBL.	DOUBLE	LAM.	LAMINATED	TEMP.	TEMPERED GLASS
D.S.	DUAL GLAZED	LAV.	LAVATORY	THK.	THICK
DIA.	DIAMETER	LUM.	LUMINOUS	T.O.C.	TOP OF CURB
DIM.	DIMENSION	M.C.	MEDICINE CABINET	T.O.P.	TOP OF PLATE
DISP.	DISPOSAL	MFR.	MANUFACTURER	T.O.S.	TOP OF SLAB
D.L.	DIVIDED LIGHT	MIN.	MINIMUM	TYP.	TYPICAL
DP.	DEEP	MTD.	MOUNTED	U.N.O.	UNLESS NOTED OTHERWISE
DR.	DOOR	MTL.	METAL	V.P.	VAPOR PROOF
D.S.	DOWNSPOUT	N.I.C.	NOT IN CONTRACT	W.	WITH
DTL.	DETAIL	N.T.S.	NOT TO SCALE	W/	WOOD
D.W.	DISHWASHER	O/	OVER	WDM.	WINDOW
EA.	EACH	O.C.	ON CENTER	W/H	WATER HEATER
ELEV.	ELEVATION	OPT.	OPTIONAL	W/I.	WROUGHT IRON
EQ.	EQUAL	O.S.A.	OUTSIDE AIR	W.P.	WEATHER PROOF
EXH.	EXHAUST	PL.	PLATE		
EXT.	EXTERIOR	PH.	PHONE		
FAU.	FORCED AIR UNIT	PLT.	PLATE		
F.G./FX.	FIXED GLASS	PLYMD.	PLYWOOD		
F.G.	FUEL GAS	FR.	PAIR		
FIN.	FINISH	P.T.D.F.	PRESSURE TREATED DOUGLAS FIR		
FLR.	FLOOR	R.	RISER		
FLR. LINE	FLOOR LINE	RAD.	RADIUS		
FLUOR.	FLUORESCENT	R.A.G.	RETURN AIR GRILL		
FR. DR.	FRENCH DOOR	REF.	REFRIGERATOR		
F.M.C.	FLOOR MATERIAL CHANGE	RE/S	RE-SAWN		
FTS.	FOOTING	REV.	REVERSE		
GA.	GAUGE	RM.	ROOM		
GAR. DISP.	GARBAGE DISPOSAL				

### ARCH. SYMBOLS

BUILDING SECTION  
SECTION INDICATOR  
--- SHEET NUMBER

DETAIL REFERENCE  
--- DETAIL NUMBER

KEYNOTE REFERENCE  
--- REFERENCE NUMBER

OFFSET REFERENCE  
DIFFERENTIAL IN FLOOR LEVEL OR FINISH SURFACE

REVISION REFERENCE  
--- REVISION NUMBER  
REFER TO TITLE SHEET

### SCALE NOTE

IF BOX IS 1" SQ. THEN SCALE IS 1/4" = 1'-0"

IF BOX IS 1/2" SQ. THEN SCALE IS 1/8" = 1'-0"

### CONSULTANTS

**OWNER :**  
KB HOME  
NORTH CAROLINA DIVISION  
4506 S. MIAMI BLVD., SUITE 180  
DURHAM, NC 27705  
TEL. (919) 768-7980  
FAX. (919) 544-2928

**ARCHITECT**  
KB HOME  
5250 PACIFIC CONCOURSE DRIVE, SUITE 330  
LOS ANGELES, CA 90045  
TEL. (424) 244-8100  
FAX. (310) 247-2671

### SQUARE FOOTAGE

PLAN 240.2596-R		
FIRST FLOOR AREA	1158	SQ. FT.
SECOND FLOOR AREA	1415	SQ. FT.
<b>TOTAL AREA</b>	<b>2573</b>	<b>SQ. FT.</b>
GARAGE AREA	416	SQ. FT.
PORCH AREA(S)		
ELEVATION 'A'	88	SQ. FT.
ELEVATION 'B'	84	SQ. FT.
ELEVATION 'C'	62	SQ. FT.
ELEVATION 'D'	136	SQ. FT.
PATIO AREA(S)		
10'X10' COVERED	100	SQ. FT.
10'X26'-1" COVERED	266	SQ. FT.
DECK AREA(S)		
OPEN 12'X12'	144	SQ. FT.
OPEN 12'X24'	288	SQ. FT.
SCREENED-IN 12'X12'	144	SQ. FT.
SCREENED-IN 12'X24'	288	SQ. FT.
SUNROOM AREA		
12'X12'	144	SQ. FT.

### CODE INFORMATION

**APPLICABLE CODES:**  
2018 NORTH CAROLINA STATE BUILDING CODE, RESIDENTIAL CODE, INCLUDING REFERENCED CODES AND STANDARDS

**PROJECT DESCRIPTION:**  
2 STORY SINGLE FAMILY DETACHED RESIDENTIAL PLAN W/ 4 ELEVATIONS

**OCCUPANCY:**  
R3

**CONSTRUCTION TYPE:**  
V - B

REVISION LIST			
DELTA	DATE	SHEETS REVISED	LOG NUMBER
1	08/24/18	T5, 1.1 - 1.5, 2.1, 2.3, 2.4, 2.5, 3.A1 - 3.D6, 4.1 - 5.4	NC18024NCP
2	09/15/19	T5, 6.N1, 6.N2, 6.N3, 1.2, 3.A1, 3.B1, 3.B2, 3.B7, 3.C1, 3.C2, 3.C6, 3.D2, 5.1 7.3 - 7.6, 8.1 - 8.4	NC18024NCP
3	04/01/19	1.1, 2.1, 3.A1, 3.B2, 3.C2, 3.D2, 5.1	NC19017NCP
4	05/07/19	T5, 1.1-1.5, 3.A1-3.A5, 3.B1, 3.B3, 3.B4, 3.B6, 3.B7, 3.C1-3.C6, 3.D1-3.D6 4.1, 4.2, 5.1, 5.2, 5.4, 7.5, 7.6	NC19033NCP



**NORTH CAROLINA  
40' SERIES**

KB HOME  
NORTH CAROLINA DIVISION  
4506 S. MIAMI BLVD.  
SUITE 180  
DURHAM, NC 27703  
TEL: (919) 768-7980  
FAX: (919) 544-2928

**2018 NORTH  
CAROLINA STATE  
BUILDING  
CODES**

- ISSUE DATE: 06/02/15  
PROJECT No.: 1350999:56  
DIVISION MGR.: MCP  
REVISIONS: 05/07/19
- 1 DIVISION REVISION NC18024NCP - 08/24/18 - CTD
  - 2 2018 CODE UPDATE NC19033NCP / 03/15/19 / CTD
  - 3 DIVISION REVISION NC19017NCP - 04/01/19 CTD
  - 4 FRAMEWALK REVISIONS NC19033NCP - 05/07/19 - CTD

FOR INTERNAL USE ONLY

REVISION BY:	DATE
1	
2	
3	
4	
5	
6	

PLAN:  
**240.2596-R**  
SHEET:  
**TS**

**SPEC. LEVEL 1  
RALEIGH-DURHAM  
40' SERIES**

These designs and drawings are CONFIDENTIAL and the exclusive property of KB Home Corporation and are not to be disclosed without the express permission of KB Home Corporation. Copyright 2019 © KB Home Corporation, all rights reserved.



## GENERAL REQUIREMENTS

- THE WORD "CONTRACTOR" AS USED HEREIN SHALL MEAN THE GENERAL CONTRACTOR, SUBCONTRACTORS AND ALL PERSONS DIRECTLY OR INDIRECTLY EMPLOYED BY ANY OF THEM.
- CONTRACTOR SHALL PERFORM THE WORK IN ACCORDANCE WITH THE FOLLOWING APPLICABLE CODE REQUIREMENTS:
  - ALL LAWS, STATUTES, THE MOST RECENT BUILDING CODES, ORDINANCES, RULES, REGULATIONS, AND LAWFUL ORDERS OF ALL PUBLIC AUTHORITIES HAVING JURISDICTION OVER OWNER, CONTRACTOR, ANY SUBCONTRACTOR, THE PROJECT, THE PROJECT SITE, THE WORK, OR THE PROSECUTION OF THE WORK.
  - THE FEDERAL OCCUPATIONAL SAFETY AND HEALTH ACT AND ALL OTHER APPLICABLE CODE REQUIREMENTS RELATING TO SAFETY.
  - THE FAIR HOUSING AMENDMENTS ACT, THE AMERICANS WITH DISABILITIES ACT, AND ALL OTHER APPLICABLE CODE REQUIREMENTS RELATING THERETO.
- CONTRACTOR SHALL CAREFULLY STUDY AND REVIEW THE CONSTRUCTION DOCUMENTS AND INFORMATION FURNISHED BY OWNER, AND SOONEST PROMPTLY REPORT IN WRITING TO OWNER'S REPRESENTATIVE ANY ERRORS, INCONSISTENCIES, OR OMISSIONS IN THE CONSTRUCTION DOCUMENTS OR INCONSISTENCIES WITH APPLICABLE CODE REQUIREMENTS OBSERVED BY THE CONTRACTOR.
- IF CONTRACTOR PERFORMS WORK WHICH HE KNOWS OR SHOULD KNOW IS CONTRARY TO APPLICABLE CODE REQUIREMENTS, WITHOUT THE AGREEMENT OF OWNER, CONTRACTOR SHALL BE RESPONSIBLE FOR SUCH WORK AND SHALL BEAR THE RESULTANT LOSSES, INCLUDING, WITHOUT LIMITATION, THE COSTS OF CORRECTING DEFECTIVE WORK.
- CONTRACTOR SHALL PROVIDE CERTIFICATES OF INSURANCE ACCEPTABLE TO OWNER PRIOR TO COMMENCEMENT OF WORK.
- CONTRACTOR SHALL TAKE FIELD MEASUREMENTS, VERIFY FIELD CONDITIONS, AND CAREFULLY COMPARE WITH THE CONSTRUCTION DOCUMENTS SUCH FIELD MEASUREMENTS, CONDITIONS, AND OTHER INFORMATION KNOWN TO CONTRACTOR BEFORE COMMENCING THE WORK. ERRORS, INCONSISTENCIES, OR OMISSIONS DISCOVERED AT ANY TIME SHALL BE PROMPTLY REPORTED IN WRITING TO THE OWNER.
- CONTRACTOR SHALL PROMPTLY NOTIFY OWNER'S REPRESENTATIVE IF CONTRACTOR BECOMES AWARE DURING THE PERFORMANCE OF THE WORK THAT THE CONSTRUCTION DOCUMENTS ARE NOT IN COMPLIANCE WITH APPLICABLE CODE REQUIREMENTS.
- BY SUBMITTAL OF BID, CONTRACTOR WARRANTS TO OWNER THAT ALL MATERIALS AND METHODS TO BE FURNISHED ARE NEW UNLESS NOTED OTHERWISE AND ALL WORK WILL BE OF GOOD QUALITY AND FREE FROM FAULTS AND DEFECTS.
- SUB-CONTRACTORS SHALL INSURE THAT ALL WORK IS DONE IN A PROFESSIONAL WORKMANLIKE MANNER BY SKILLED MECHANICS AND SHALL REPLACE ANY MATERIALS OR ITEMS DAMAGED BY SUB-CONTRACTOR'S PERFORMANCE. SUB-CONTRACTORS AND SUPPLIERS ARE HEREBY NOTIFIED THAT THEY ARE TO CONFER AND COOPERATE FULLY WITH EACH OTHER DURING THE COURSE OF CONSTRUCTION TO DETERMINE THE EXACT EXTENT AND OVERLAP OF EACH OTHER'S WORK AND TO SUCCESSFULLY COMPLETE THE EXECUTION OF THE WORK. ALL SUB-CONTRACTOR WORKMANSHIP SHALL BE OF QUALITY TO PASS INSPECTIONS BY LOCAL AUTHORITIES, LENDING INSTITUTIONS, ARCHITECT OR BUILDER. ANY ONE OR ALL OF THE ABOVE MENTIONED INSPECTORS MAY INSPECT WORKMANSHIP AT ANY TIME, AND CORRECTIONS NEEDED TO ENHANCE THE QUALITY OF BUILDING WILL BE DONE IMMEDIATELY. EACH SUB-CONTRACTOR UNLESS SPECIFICALLY EXEMPTED BY THE TERMS OF HIS/HERS SUB-CONTRACT AGREEMENT, SHALL BE RESPONSIBLE FOR CLEANING UP AND REMOVING FROM THE JOB SITE ALL TRASH AND DEBRIS NOT LEFT BY OTHER SUB-CONTRACTORS. BUILDER WILL DETERMINE HOW SOON AFTER SUB-CONTRACTOR COMPLETES EACH PHASE OF HIS WORK THAT TRASH AND DEBRIS WILL BE REMOVED FROM THE SITE.
- APPROVAL BY THE BUILDING INSPECTOR DOES NOT MEAN APPROVAL OR ALLOWABLE FAILURE TO COMPLY WITH THE PLANS AND SPECIFICATIONS. ANY DESIGN WHICH FAILS TO BE CLEAR OR IS AMBIGUOUS MUST BE REFERRED TO THE ARCHITECT OR ENGINEER FOR INTERPRETATION OR CLARIFICATION.
- ALL EQUIPMENT AND MATERIALS FURNISHED AND INSTALLED UNDER THESE PLANS SHALL BE GUARANTEED BY THE CONTRACTOR FOR A PERIOD OF ONE YEAR FROM THE DATE OF ACCEPTANCE OF THE WORK BY OWNER UNLESS STIPULATED OTHERWISE.
- ALL TRADE NAMES AND BRAND NAMES CONTAINED HEREIN ESTABLISH QUALITY STANDARDS. SUBSTITUTIONS ARE PERMITTED, WITH PRIOR APPROVAL BY THE OWNER'S REPRESENTATIVE. THE CONTRACTOR SHALL SUBMIT FOR THE ARCHITECT'S AND BUILDER'S APPROVAL ALL MATERIALS OR EQUIPMENT WHICH IS CONSIDERED "OR EQUAL" TO THAT SPECIFIED.
- CONSTRUCTION DOCUMENTS IDENTIFIED AS "BID SET" ON ANY OR ALL SHEETS MAY BE SUBJECT TO REVIEW. THIS REVIEW MAY RESULT IN CHANGES WHICH MAY BE MADE TO THE PLANS PRIOR TO THE ISSUANCE OF THE FINAL CONSTRUCTION SET WHICH WILL CONTAIN NO "BID SET" DESIGNATIONS. CONSTRUCTION DOCUMENTS IDENTIFIED AS "BID SET" ARE NOT TO BE CONSTRUED AS BEING THE COMPLETED OR FINAL DRAWINGS AND THEY SHOULD NOT IN ANY WAY BE USED AS SUCH.
- ALL STANDARD NOTES CONTAINED HEREIN ARE TYPICAL UNLESS NOTED OTHERWISE.
- TYPICAL DETAILS AND SPECIFICATIONS ARE MINIMUM REQUIREMENTS TO BE USED WHEN CONDITIONS ARE NOT SHOWN OTHERWISE.
- SPECIFIC NOTES AND DETAILS ON DRAWINGS SHALL TAKE PRECEDENCE OVER GENERAL NOTES AND TYPICAL DETAILS. WHERE NO DETAILS ARE SHOWN CONSTRUCTION SHALL CONFORM TO SIMILAR WORK ON THE PROJECT.
- SEE ARCHITECTURAL, STRUCTURAL, ELECTRICAL, AND MECHANICAL DRAWINGS FOR FITS, TRENCHES, ROOF OPENINGS, DEPRESSIONS, ETC. NOT SHOWN ON THE OTHER DRAWINGS.
- THE CONSTRUCTION DOCUMENTS AND ALL COPIES THEREOF FURNISHED TO CONTRACTOR ARE THE PROPERTY OF THE ARCHITECT AND ARE NOT TO BE USED ON OTHER WORK.

## SITE WORK

- CONTRACTOR SHALL INVESTIGATE SITE DURING CLEARING AND EARTHWORK OPERATIONS FOR UNDESIRED EXCAVATIONS OR BURIED STRUCTURES SUCH AS CESSPOOLS, CISTERNS, FOUNDATIONS, ETC., AND BURIED ARTIFACTS SUCH AS INDIAN OR DINOSAUR BONES. IF ANY SUCH ITEMS ARE FOUND THE ARCHITECT, CIVIL ENGINEER, AND SOILS ENGINEER SHALL BE NOTIFIED IMMEDIATELY.
- CONTRACTOR SHALL TAKE ALL NECESSARY MEASURES TO FULLY PROTECT ADJACENT PROPERTIES.
- REFER TO THE SOILS REPORT AS PREPARED BY THE GEOTECHNICAL ENGINEER.
- REFER TO CIVIL ENGINEER'S CURRENT GRADING AND PLOT PLANS.

## SITE WORK (continued)

- REFER TO THE LANDSCAPE ARCHITECT'S CURRENT GRADING PLAN AND CONSTRUCTION DOCUMENTS.
- ALL FOOTINGS SHALL REST ON FIRM NATURAL SOIL OR APPROVED COMPACTED FILL. REFER TO GEOTECHNICAL REPORT.
- EXCAVATIONS FOR FOOTINGS SHALL BE MADE TO THE WIDTH, LENGTH, AND DEPTH REQUIRED AND FINISHED WITH LEVEL BOTTOMS.
- EXCAVATIONS SHALL BE KEPT FREE OF STANDINGS WATER.
- WHERE EXCAVATIONS ARE MADE TO A DEPTH GREATER THAN INDICATED, SUCH ADDITIONAL DEPTH SHALL BE FILLED WITH CONCRETE AS SPECIFIED FOR FOOTINGS.
- FILL MATERIALS SHALL BE FREE FROM DEBRIS, VEGETABLE MATTER AND OTHER FOREIGN SUBSTANCES.
- ALL FINISH GRADES TO DRAIN AWAY FROM THE BUILDING FOOTINGS.
- THERE SHALL BE NO ON-SITE WATER RETENTION.
- THERE SHALL BE NO DRAINAGE TO ADJACENT PROPERTY.
- FOR ON-SITE CONSTRUCTION, PLANS TO COMPLY WITH NECESSARY INSPECTIONS APPROVED BY THE BUILDING OFFICIAL.
- THE REQUIREMENTS IN THESE NOTES ARE THE MINIMUM THAT SHALL BE MET. REQUIREMENTS OF THE STRUCTURAL DRAWINGS THAT EXCEED THE REQUIREMENTS SHOWN HERE SHALL BE MET.

## CONCRETE

- REFER TO STRUCTURAL ENGINEERING CALCULATIONS AND SOILS REPORTS FOR THE QUALITY AND PERFORMANCE REQUIREMENTS FOR CONCRETE FOUNDATIONS.
- CONCRETE SHALL BE PROPORTIONED TO PROVIDE AN AVERAGE COMPRESSIVE STRENGTH AS PRESCRIBED IN THE N.C.-R, AS WELL AS SATISFY THE DURABILITY CRITERIA OF THE N.C.-R.
- MIXING OF CONCRETE SHALL BE PERFORMED IN ACCORDANCE WITH ACI 318, SECTION 5.8.
- THE DEPOSITING OF CONCRETE SHALL COMPLY WITH THE PROVISIONS ACI 318, SECTION 5.10.
- THE CURING OF CONCRETE SHALL BE IN ACCORDANCE WITH ACI 318, SECTION 5.11.
- ALL FORM WORK SHALL BE DESIGNED, CONSTRUCTED, UTILIZED, AND REMOVED.
- CONDUIT, PIPES AND SLEEVES OF ANY MATERIAL NOT HARMFUL TO CONCRETE AND WITHIN THE LIMITATIONS OF ACI 318, SECTION 6.3, ARE PERMITTED TO BE EMBEDDED IN CONCRETE WITH APPROVAL OF THE REGISTERED DESIGN PROFESSIONAL.
- CONSTRUCTION JOINTS INCLUDING THEIR LOCATION SHALL COMPLY WITH THE PROVISIONS OF ACI 318, SECTION 6.4.
- ALL STEEL REINFORCING OF CONCRETE SHALL BE DONE IN ACCORDANCE WITH THE N.C.-R.
- TOP OF CONCRETE SLABS TO BE A MINIMUM 4" W/ MASONRY VENEER 6" ELSEWHERE (8" HUD.) ABOVE FINISH GRADE.
- FOUNDATION WIDTHS, DEPTHS, AND REINFORCINGS, AS SHOWN ON PLANS, ARE SUPERSEDED BY ANY LOCAL CODES OR ORDINANCES WHICH REQUIRE INCREASES OF THE SAME.
- ALL REINFORCEMENT, CONDUIT, OUTLET BOXES, ANCHORS, HANGERS, SLEEVES, BOLTS OR OTHER EMBEDDED MATERIALS AND ITEMS MUST BE SECURED AND APPROPRIATELY FASTENED IN THEIR PROPER LOCATIONS PRIOR TO THE PLACEMENT OF CONCRETE. SUB-CONTRACTOR SHALL VERIFY INSTALLATION OF HOLD-DOWNS, ANCHOR BOLTS, PA STRAPS, AND OTHER ANCHORAGE MATERIAL AND ITEMS PRIOR TO PLACEMENT OF CONCRETE.
- POST-TENSION SLABS, IF APPLICABLE:
  - POINT AND LINE LOADS FROM STRUCTURE ABOVE TO BE PROVIDED TO POST-TENSION ENGINEER PRIOR TO POST-TENSION DESIGN.
  - ANCHOR BOLTS AND OTHER HARDWARE TO BE SHOWN ON POST-TENSION PLANS TO AVOID MIS-LOCATION OF HARDWARE AND POSSIBLE FIELD FIXES WHICH MAY CUT TENDONS.

## MASONRY

- ALL MASONRY DESIGN SHALL FOLLOW THE REQUIREMENTS OF THE CURRENT ADOPTED CODES.
- ANCHORED MASONRY VENEER SHALL COMPLY WITH THE PROVISIONS OF N.C.-R, AND SECTIONS 6.1 AND 6.2 OF ACI 530/ASCE 5/TMS 402.
- STONE VENEER UNITS NOT EXCEEDING 5 INCHES IN THICKNESS SHALL BE ANCHORED DIRECTLY TO MASONRY, CONCRETE OR TO STUD CONSTRUCTION BY ONE OF THE APPROVED METHODS LISTED IN THE N.C.-R.
- MORTAR FOR USE IN MASONRY CONSTRUCTION SHALL COMPLY WITH ASTM C 270. THE TYPE OF MORTAR SHALL BE IN ACCORDANCE WITH THE N.C.-R AND SHALL MEET THE PROPORTION SPECIFICATIONS OR THE PROPERTY SPECIFICATIONS OF ASTM C 270.
- GROUT SHALL CONSIST OF CEMENTITIOUS MATERIAL AND AGGREGATE IN ACCORDANCE WITH ASTM C 476 AND THE PROPORTION SPECIFICATIONS PER THE N.C.-R.
- AGGREGATES FOR MORTAR AND GROUT SHALL BE NATURAL SAND AND ROCK CONFORMING TO A.S.T.M. C-144-O4 (MASONRY MORTAR) AND C-404-OT (GROUT).
- CEMENT SHALL BE PORTLAND CEMENT CONFORMING TO A.S.T.M. C 150.
- ALL BRICK SHALL CONFORM TO A.S.T.M. C 216, GRADE MN.
- UNLESS SPECIFICALLY SHOWN OTHERWISE ALL BRICK SHALL BE LAID IN A RUNNING BOND PATTERN.
- ANCHORS, TIES AND WIRE FABRIC SHALL CONFORM TO N.C.-R.
- ANCHOR TIES AND WIRE FABRIC FOR USE IN MASONRY WALL CONSTRUCTION SHALL CONFORM TO THE N.C.-R.

## METALS

- REFER TO STRUCTURAL NOTES AND SPECIFICATIONS FOR STRUCTURAL STEEL, METAL AND REINFORCING STEEL SPECIFICATIONS.
- ALL STRUCTURAL STEEL SHALL CONFORM TO AISC/AEC/D.
- ANCHOR RODS SHALL BE SET ACCURATELY TO THE PATTERN AND DIMENSIONS CALLED FOR ON THE PLANS. THE PROTRUSION OF THE THREADED ENDS THROUGH THE CONNECTED MATERIAL SHALL BE SUFFICIENT TO FULLY ENGAGE THE THREADS OF THE NUTS, BUT SHALL NOT BE GREATER THAN THE LENGTH OF THE THREADS ON THE BOLTS.
- FASTENERS FOR PRESERVATIVE-TREATED AND FIRE-RETARDANT-TREATED WOOD SHALL BE OF HOT-DIPPED ZINC COATED GALVANIZED STEEL, STAINLESS STEEL, SILICON BRONZE OR COPPER. VERIFY ACCEPTABLE FASTENERS PER CHEMICALS USED IN PRESURE PRESERVATIVELY TREATED WOOD IN N.C.-R. FASTENINGS FOR WOOD FOUNDATIONS SHALL BE AS REQUIRED IN AF&PA TECHNICAL REPORT NO. 1.

## WOOD & FRAMING

### LUMBER

- THE DESIGN AND CONSTRUCTION OF CONVENTIONAL LIGHT-FRAME WOOD CONSTRUCTION SHALL BE IN ACCORDANCE WITH THE PROVISIONS OF THE N.C.-R.
- CONSTRUCTION PROJECTIONS, OPENINGS AND PENETRATIONS OF EXTERIOR WALLS OF DWELLINGS AND ACCESSORY BUILDINGS SHALL COMPLY WITH TABLE R302.1.
- ALL LUMBER SHALL MEET THE STANDARDS OF QUALITY AS STATED IN THE N.C.-R.
- LUMBER AND PLYWOOD REQUIRED TO BE PRESSURE PRESERVATIVELY TREATED IN ACCORDANCE WITH THE N.C.-R AND SHALL BEAR THE QUALITY MARK OF AN APPROVED INSPECTION AGENCY THAT MAINTAINS CONTINUING SUPERVISION, TESTING AND INSPECTION OVER THE QUALITY OF THE PRODUCT AND THAT HAS BEEN APPROVED BY AN ACCREDITATION BODY THAT COMPLIES WITH THE REQUIREMENTS OF THE AMERICAN LUMBER STANDARD COMMITTEE TREATED WOOD PROGRAM.
- ALL LUMBER SIZES NOTED AND SPECIFIED ON PLANS ARE NOMINAL SIZES UNLESS SPECIFICALLY INDICATED AS NET SIZE.

### GLUE LAMINATED LUMBER

- REFER TO THE STRUCTURAL ENGINEER'S CURRENT NOTES, CALCULATIONS, AND SPECIFICATIONS.
- GLUED LAMINATED TIMBERS SHALL BE MANUFACTURED AND IDENTIFIED AS REQUIRED IN AITC A1901 AND ASTM D 3757.

### PROTECTION AGAINST DECAY & TERMITES

- IN AREAS SUBJECT TO DECAY DAMAGE AS ESTABLISHED BY THE N.C.-R THE FOLLOWING LOCATIONS SHALL REQUIRE THE USE OF NATURALLY DURABLE WOOD OR WOOD THAT IS PRESERVATIVE TREATED IN ACCORDANCE WITH ANFA VI FOR THE SPECIES, PRODUCT, PRESERVATIVE AND END USE. PRESERVATIVES SHALL BE LISTED IN SECTION 4 OF ANFA VI
  - WOOD JOISTS OR THE BOTTOM OF WOOD FLOOR WHEN CLOSER THAN 18 INCHES, OR WOOD GIRDDERS WHEN CLOSER THAN 12 INCHES TO THE EXPOSED GROUND IN CRAWL SPACES OR UNEXCAVATED AREAS LOCATED WITHIN THE PERIPHERY OF THE BUILDING FOUNDATION.
  - ALL EXTERIOR SILLS & PLATES THAT REST ON CONCRETE OR MASONRY EXTERIOR FOUNDATION WALLS.
  - SILLS AND SLEEPERS ON A CONCRETE OR MASONRY UNLESS THE SLAB THAT IS IN DIRECT CONTACT WITH THE GROUND IS SEPARATED FROM THE GROUND BY AN APPROVED IMPERVIOUS MOISTURE BARRIER.
  - THE ENDS OF WOOD GIRDDERS ENTERING EXTERIOR MASONRY OR CONCRETE WALLS HAVING CLEARANCES OF LESS THAN 0.5 INCH ON TOPS, SIDES AND ENDS.
  - WOOD SIDING AND SHEATHING ON THE EXTERIOR OF A BUILDING HAVING A CLEARANCE OF LESS THAN 6 INCHES FROM THE GROUND.
  - WOOD STRUCTURAL MEMBERS SUPPORTING MOISTURE-PERMEABLE FLOORS OR ROOFS THAT ARE EXPOSED TO THE WEATHER, SUCH AS CONCRETE OR MASONRY SLABS, UNLESS SEPARATED FROM SUCH FLOORS OR ROOFS BY AN IMPERVIOUS MOISTURE BARRIER.
  - WOOD FURRING STRIPS OR OTHER WOOD FRAMING MEMBERS ATTACHED DIRECTLY TO THE INTERIOR OF EXTERIOR MASONRY WALLS OR CONCRETE WALLS BELOW GRADE EXCEPT WHERE AN APPROVED VAPOR RETARDER IS APPLIED BETWEEN THE WALL AND THE FURRING STRIPS OR FRAMING MEMBERS.
  - ALL PORTIONS OF A PORCH, SCREEN PORCH OR DECK FROM THE BOTTOM OF THE HEADER DOWN, INCLUDING POSTS, GUARDRAILS, PICKETS, STEPS AND FLOOR STRUCTURE, COVERINGS THAT WOULD PREVENT MOISTURE OR WATER ACCUMULATION ON THE SURFACE OR AT JOINTS BETWEEN MEMBERS ARE ALLOWED.
- IN AREAS SUBJECT TO DAMAGE FROM TERMITES METHODS OF PROTECTION SHALL BE ONE OF THE METHODS LISTED IN THE N.C.-R.
- UNDER-FLOOR AREAS SHALL BE VENTILATED IN ACCORDANCE WITH THE REQUIREMENTS OF THE N.C.-R.

## WOOD & FRAMING (continued)

### SHEATHING

- WOOD STRUCTURAL PANELS SHALL CONFORM TO THE REQUIREMENTS AS SET FORTH IN THE N.C.-R.
- ROOF SHEATHING PANELS SHALL BE LAID WITH FACE GRAIN OR STRENGTH AXIS PERPENDICULAR TO SUPPORTS AND WITH PANEL CONTINUOUS OVER TWO OR MORE SPANS.
- ROOF SHEATHING SHALL BE IN ACCORDANCE WITH THE N.C.-R.
- FLOOR SHEATHING PANELS SHALL BE LAID WITH FACE GRAIN OR STRENGTH AXIS PERPENDICULAR TO SUPPORTS AND WITH PANEL CONTINUOUS OVER TWO OR MORE SPANS.
- STRUCTURAL FLOOR SHEATHING SHALL COMPLY WITH THE PROVISIONS OF THE N.C.-R.
- REFER TO THE STRUCTURAL ENGINEER'S CURRENT SPECIFICATIONS, CALCULATIONS, AND PLANS FOR REQUIRED STRENGTH, GRADE, AND THICKNESS FOR PLYWOOD FLOOR SHEATHING PANELS AND FOR DIAHRAGM NAILING AND ADHESIVE REQUIREMENTS.
- ALL VERTICAL JOINTS OF PANEL SHEATHING SHALL OCCUR OVER, AND BE FASTENED TO, COMMON STUDS. HORIZONTAL JOINTS IN BRACED WALL PANELS SHALL OCCUR OVER, AND BE FASTENED TO, COMMON BLOCKING OF A MINIMUM OF 1 1/2 INCH THICKNESS.
- WHERE APPLICABLE, REFER TO THE SHEAR WALL SCHEDULE FOR REQUIRED STRENGTH, GRADE, AND THICKNESS OF PLYWOOD SHEAR PANELS AND FOR REQUIRED SHEAR WALL NAILING SCHEDULE.
- IN ONE- AND TWO-FAMILY DWELLING CONSTRUCTION USING VINYL OR ALUMINUM AS A SOFFIT MATERIAL, THE SOFFIT MATERIAL SHALL BE SECURELY ATTACHED TO FRAMING MEMBERS AND USE AN UNDERLAYMENT MATERIAL OF EITHER FIRE RETARDANT TREATED WOOD, 23/32 INCH WOOD SHEATHING OR 5/8 INCH GYPSUM BOARD. VENTING REQUIREMENTS APPLY TO BOTH SOFFIT AND UNDERLAYMENT AND SHALL BE PER SECTION R206 OF THE NORTH CAROLINA RESIDENTIAL CODE. WHERE THE PROPERTY LINE IS 10 FEET OR MORE FROM THE BUILDING FACE, THE PROVISIONS OF THIS CODE SECTION DO NOT APPLY.

### FLOOR FRAMING

- ALL FLOOR JOISTS SHALL BE DESIGNED & JOIST WOOD FLOOR TRUSSES. REFER TO MANUFACTURER FOR ALL LAYOUTS AND CALCULATIONS.
- REFER TO THE STRUCTURAL ENGINEER'S CURRENT PLANS & CALCULATIONS FOR SIZE, SPACING, AND ANCHORAGE OF ALL FLOOR JOISTS; SIZE, LOCATION AND ANCHORAGE OF ALL FLOOR BEAMS AND HEADERS; AND ALL RELATED FRAMING ISSUES.

### ROOF FRAMING

- ROOF FRAMING SHALL BE BY PRE-MANUFACTURED ROOF TRUSSES SPACED AT 24 INCHES ON CENTER UNLESS NOTED OTHERWISE.
- WOOD TRUSSES SHALL BE DESIGNED IN ACCORDANCE WITH THE REQUIREMENTS OF THE N.C.-R.
- THE MANUFACTURER SHALL SUPPLY TO THE ARCHITECT AND BUILDER CALCULATIONS AND SHOP DRAWINGS FOR APPROVAL OF DESIGN LOADS, CONFIGURATION (2 OR 3 POINT BEARINGS), VOLUME CEILING OPTIONS, AND SHEAR TRANSFER, PRIOR TO FABRICATION.
- THE BRACINGS OF WOOD TRUSSES SHALL COMPLY TO THEIR APPROPRIATE ENGINEERED DESIGN. PER THE N.C.-R.
- TRUSS MEMBERS SHALL NOT BE CUT, NOTCHED, DRILLED, SPLICED OR OTHERWISE ALTERED IN ANY WAY WITHOUT THE APPROVAL OF A REGISTERED DESIGN PROFESSIONAL. ALTERATIONS RESULTING IN THE ADDITION OF LOAD (E.G. HVAC EQUIPMENT, WATER HEATER) THAT EXCEEDS THE DESIGN LOAD FOR THE TRUSSES SHALL NOT BE PERMITTED WITHOUT WRITTEN VERIFICATION THAT THE TRUSS IS CAPABLE OF SUPPORTING SUCH ADDITIONAL LOADING.
- ALL CALCULATIONS AND SHOP DRAWINGS SHALL BE SIGNED BY A PROFESSIONAL ENGINEER REGISTERED IN THE STATE WHEREIN THE PROJECT IS TO BE BUILT.
- MANUFACTURER IS TO SECURE BUILDING DEPARTMENT APPROVAL OF CALCULATIONS AND SHOP DRAWINGS PRIOR TO FABRICATION.

### WALL FRAMING

- THE SIZE, HEIGHT, AND SPACING OF STUDS SHALL BE IN ACCORDANCE WITH THE N.C.-R.
- STUDS SHALL BE PLACED WITH THEIR WIDE DIMENSION PERPENDICULAR TO THE WALL.
- NOT LESS THAN THREE STUDS SHALL BE INSTALLED AT EACH CORNER OF AN EXTERIOR WALL.
- WOOD STUD WALLS SHALL BE CAPPED WITH A DOUBLE TOP PLATE INSTALLED TO PROVIDE OVERLAPPING AT CORNERS AND INTERSECTIONS WITH BEARING PARTITIONS. END JOINTS IN TOP PLATES SHALL BE OFFSET AT LEAST 24 INCHES. JOINTS NEED NOT OCCUR OVER STUDS. PLATES SHALL BE NOT LESS THAN 2-INCHES NOMINAL THICKNESS AND HAVE A WIDTH AT LEAST EQUAL TO THE WIDTH OF THE STUDS. SEE EXCEPTIONS.
- WHERE JOISTS, TRUSSES OR RAFTERS ARE SPACED MORE THAN 16 INCHES ON CENTER AND THE BEARING STUDS BELOW ARE SPACED 24 INCHES ON CENTER, SUCH MEMBERS SHALL BEAR WITHIN 5 INCHES OF THE STUDS BENEATH. SEE EXCEPTIONS.
- STUDS SHALL HAVE FULL BEARING ON NOMINAL 2 BY OR LARGER PLATE OR SILL HAVING A WIDTH AT LEAST EQUAL TO THE WIDTH OF THE STUDS.
- INTERIOR NONBEARING WALLS SHALL BE PERMITTED TO BE CONSTRUCTED WITH 2-INCH-BY-3-INCH STUDS SPACED 24 INCHES ON CENTER OR, WHEN NOT A PART OF A BRACED WALL LINE, 2-INCH-BY-4-INCH FLAT STUDS SPACED 16 INCHES ON CENTER. INTERIOR NONBEARING WALLS SHALL BE CAPPED WITH AT LEAST A SINGLE TOP PLATE. INTERIOR NONBEARING WALLS SHALL BE FIREBLOCKED IN ACCORDANCE WITH THE N.C.-R.

## WOOD & FRAMING (continued)

- DRILLING AND NOTCHING OF STUDS SHALL BE IN ACCORDANCE WITH THE FOLLOWING:
  - NOTHING, ANY STUD IN AN EXTERIOR WALL OR BEARING PARTITION MAY BE CUT OR NOTCHED TO A DEPTH NOT EXCEEDING 25 PERCENT OF ITS WIDTH. STUDS IN NONBEARING PARTITIONS MAY BE NOTCHED TO A DEPTH NOT TO EXCEED 40 PERCENT OF A SINGLE STUD WIDTH. NOTCHING OF BEARING STUDS SHALL BE ON ONE EDGE ONLY AND NOT TO EXCEED ONE-FOURTH THE HEIGHT OF THE STUD. NOTCHING SHALL NOT OCCUR IN THE BOTTOM OR TOP 6 INCHES OF BEARING STUDS.
  - DRILLING, ANY STUD MAY BE BORED OR DRILLED, PROVIDED THAT THE DIAMETER OF THE RESULTING HOLE IS NO MORE THAN 60 PERCENT OF THE STUD WIDTH. THE EDGE OF THE HOLE IS NO MORE THAN 5/8" INCH TO THE EDGE OF THE STUD, AND THE HOLE SHALL NOT BE CLOSER THAN 6 INCHES FROM AN ADJACENT HOLE OR NOTCH. HOLES NOT EXCEEDING 3/4 INCH DIAMETER CAN BE AS CLOSE AS 1 1/2 INCHES ON CENTER SPACING. STUDS LOCATED IN EXTERIOR WALLS OR BEARING PARTITIONS DRILLED OVER 40 PERCENT AND UP TO 60 PERCENT SHALL ALSO BE DOUBLED WITH NO MORE THAN TWO SUCCESSIVE DOUBLED STUDS BORED.
  - CUTTING AND NOTCHING OF STUDS SHALL BE PERMITTED TO BE INCREASED TO 65 PERCENT OF THE WIDTH OF THE STUD IN EXTERIOR AND INTERIOR WALLS AND BEARING PARTITIONS, PROVIDED THAT ONE OF THE FOLLOWING CONDITIONS ARE MET:
    - THE WALL SECTION IS REINFORCED WITH 1/2-INCH EXTERIOR GRADE PLYWOOD OR EQUIVALENT REINFORCEMENT ON THE NOTCHED SIDE OF THE WALL. PLYWOOD, IF USED, SHALL REACH FROM THE FLOOR TO CEILING AND AT LEAST ONE STUD FURTHER ON EACH SIDE OF THE SECTION THAT HAS BEEN NOTCHED OR CUT.
    - THE EXTERIOR WALLS OF A KITCHEN MAY BE REINFORCED BY PLACING 1/2-INCH PLYWOOD OR EQUIVALENT REINFORCEMENT ON THE NOTCHED SIDE OF THE WALL. PLYWOOD, IF USED, SHALL REACH FROM THE FLOOR TO COUNTER-TOP HEIGHT AND AT LEAST ONE STUD FURTHER ON EACH SIDE OF THE SECTION THAT HAS BEEN NOTCHED OR CUT.
- WHEN PIPING OR DUCTWORK IS PLACED IN OR PARTIALLY IN AN EXTERIOR OR INTERIOR LOAD-BEARING WALL, NECESSITATION CUTTING, DRILLING OR NOTCHING OF THE TOP PLATE IS MORE THAN 50 PERCENT OF ITS WIDTH A GALVANIZED METAL TIE OF NOT LESS THAN 0.054 INCH THICK AND 1 1/2 INCHES WIDE SHALL BE FASTENED TO THE PLATE AT EACH SIDE OF THE OPENING WITH NOT LESS THAN EIGHT 10# NAILS HAVING A MINIMUM LENGTH OF 1 1/2 INCHES (38 MM) AT EACH SIDE OR EQUIVALENT. THE METAL TIE MUST EXTEND A MINIMUM OF 6 INCHES PAST THE OPENING.
- HEADERS SHALL MEET THE REQUIREMENTS OF THE N.C.-R.
- PROVIDE LATERAL BRACINGS PER THE N.C.-R.
- FOUNDATION CRIPPLE WALLS SHALL MEET THE REQUIREMENTS OF THE N.C.-R CODE.
- WOOD STUD WALLS SHALL BE BRACED AS REQUIRED BY THE N.C.-R.
- UNLESS COVERED BY INTERIOR OR EXTERIOR WALL COVERINGS OR SHEATHING MEETING THE MINIMUM REQUIREMENTS OF THIS CODE, ALL STUD PARTITIONS OR WALLS WITH STUDS HAVING A HEIGHT-TO-LEAST THICKNESS RATIO EXCEEDING 50 SHALL HAVE BRIGINGS NOT LESS THAN 2 INCHES IN THICKNESS AND OF THE SAME WIDTH AS THE STUDS FITTED SNUGLY AND NAILED THERETO TO PROVIDE ADEQUATE LATERAL SUPPORT.

### FIRE BLOCKS AND DRAFT STOPS

- FIRE BLOCKING SHALL BE PROVIDED TO CUT OFF ALL CONCEALED DRAFT OPENINGS (BOTH VERTICAL AND HORIZONTAL) AND TO FORM AN EFFECTIVE BARRIER BETWEEN STORIES, AND BETWEEN A TOP STORY AND A ROOF SPACE. FIREBLOCKING SHALL BE PROVIDED IN WOOD-FRAME CONSTRUCTION IN THE LOCATIONS SPECIFIED IN THE N.C.-R.
- FIRE BLOCKING SHALL CONSIST OF 2 INCHES NOMINAL LUMBER OR TWO THICKNESSES OF 1-INCH NOMINAL LUMBER WITH BROKEN LAP JOINTS, OR ONE THICKNESS OF 23/32-INCH WOOD STRUCTURAL PANELS WITH JOINTS BACKED BY 23/32-INCH WOOD STRUCTURAL PANELS OR ONE THICKNESS OF 3/4-INCH PARTICLEBOARD WITH JOINTS BACKED BY 3/4-INCH PARTICLEBOARD, 1/2-INCH GYPSUM BOARD, OR 1/4-INCH CEMENT-BASED MILLBOARD.
- BATTS OR BLANKETS OF MINERAL WOOL OR GLASS FIBER OR OTHER APPROVED MATERIALS INSTALLED IN SUCH A MANNER AS TO BE SECURELY RETAINED IN PLACE SHALL BE PERMITTED AS AN ACCEPTABLE FIRE BLOCK.
- BATTS OR BLANKETS OF MINERAL WOOL OR GLASS FIBER OR OTHER APPROVED NONRIGID MATERIALS SHALL BE PERMITTED FOR COMPLIANCE WITH THE 10 FOOT HORIZONTAL FIREBLOCKING IN WALLS CONSTRUCTED USING PARALLEL ROWS OF STUDS OR STAGGERED STUDS. LOOSE FILL INSULATION MATERIAL SHALL NOT BE USED AS A FIREBLOCK UNLESS SPECIFICALLY TESTED IN THE FORM AND MANNER INTENDED FOR USE TO DEMONSTRATE ITS ABILITY TO REMAIN IN PLACE AND TO RETARD THE SPREAD OF FIRE AND HOT GASSES.
- WHEN THERE IS USABLE SPACE BOTH ABOVE AND BELOW THE CONCEALED SPACE OF A FLOOR/CEILING ASSEMBLY, DRAFTSTOPS SHALL BE INSTALLED SO THAT THE AREA OF THE CONCEALED SPACE DOES NOT EXCEED 1,000 SQUARE FEET. DRAFTSTOPPING SHALL DIVIDE THE CONCEALED SPACE INTO APPROXIMATELY EQUAL AREAS. WHERE THE ASSEMBLY IS ENCLOSED BY A FLOOR MEMBRANE ABOVE AND A CEILING MEMBRANE BELOW, DRAFTSTOPPING SHALL BE PROVIDED IN FLOOR/CEILING ASSEMBLIES UNDER THE FOLLOWING CIRCUMSTANCES:
  - CEILING IS SUSPENDED UNDER THE FLOOR FRAMING.
  - FLOOR FRAMING IS CONSTRUCTED OF TRUSS-TYPE OPEN-WEB OR PERFORATED MEMBERS.

### HANDRAIL AND GUARDRAIL

- GUARDRAIL OF 36" HIGH MIN. SHALL BE PROVIDED WHERE FINISHED GRADE OR FLOOR BELOW RAISED AREA EXCEEDS 30".
- HANDRAIL AT STAIRS SHALL BE PROVIDED WHEN 4 OR MORE STAIR RISERS ARE REQUIRED.



## NORTH CAROLINA 40' SERIES

KB HOME  
NORTH CAROLINA DIVISION  
4506 S. MIAMI BLVD.  
SUITE 180  
DURHAM, NC 27703  
TEL: (919) 768-7980  
FAX: (919) 544-2928

## 2018 NORTH CAROLINA STATE BUILDING CODES

ISSUE DATE: 06/02/15  
PROJECT No.: 1350999-56  
DIVISION MGR.: MCP  
REVISIONS: 05/07/19

- DIVISION REVISION NC18024NCP - 08/24/18 - CTD
- 2018 CODE UPDATE NC18051NCP/ 03/05/19 / CTD
- DIVISION REVISION NC19077NCP - 04/01/19 CTD
- FRAMEWALK REVISIONS NC19033NCP - 05/07/19 - CTD

FOR INTERNAL USE ONLY	
REVISED BY:	
L	_____
M	_____
A	_____
S	_____
B	_____

PLAN:  
**240.2596-R**  
SHEET:  
**GN1**

## SPEC. LEVEL 1 RALEIGH-DURHAM 40' SERIES



# THERMAL & MOISTURE PROTECTION

- PROVIDE ALL FLASHING, COUNTER-FLASHING, BITUMENE, MEMBRANE WATERPROOFING, SHEET METAL CAULKING, SEALANTS, ELASTOMERIC WALKING SURFACES, AND RAIN GUTTERS AND/OR DIVERTERS WHERE REQUIRED, TO MAKE WORK COMPLETELY WATERPROOF.
- "CORROSION RESISTANCE" SHALL MEAN THE ABILITY OF A MATERIAL TO WITHSTAND DETERIORATION OF ITS SURFACE OR ITS PROPERTIES WHEN EXPOSED TO ITS ENVIRONMENT.
- BALCONIES, LANDINGS, EXTERIOR STAIRWAYS, OCCUPIED ROOFS AND SIMILAR SURFACES EXPOSED TO THE WEATHER AND SEALED UNDER-NEATH SHALL BE WATERPROOFED AND SLOPED A MINIMUM OF 1/4 UNIT VERTICAL IN 12 UNITS HORIZONTAL (2% SLOPE) FOR DRAINAGE.
- PROVIDE A MINIMUM 2 INCH DROP FROM FINISHED INTERIOR FLOOR ELEVATION TO THE HIGHEST FLOOR ELEVATION OF ANY ADJOINING DECK OR BALCONY.
- ELASTOMERIC OR MEMBRANE DECK COATINGS SHALL BE INSTALLED PER MANUFACTURER'S SPECIFICATIONS AT DECKS AND BALCONIES. COLOR, FINISH, AND DETAILING SHALL BE APPROVED BY OWNER/BUILDER AND ARCHITECT.
- UNLESS DESIGNED TO DRAIN OVER DECK EDGES, DRAINS AND OVER-FLOWS OF ADEQUATE SIZE SHALL BE INSTALLED AT THE LOW POINTS OF THE DECK OR BALCONY.
- FOUNDATION WALLS WHERE THE OUTSIDE GRADE IS HIGHER THAN THE INSIDE GRADE SHALL BE WATER-PROOFED AND DAMPPROOFED IN ACCORDANCE WITH THE N.C.-R
- PARAPET WALLS SHALL BE PROPERLY COPED WITH NONCOMBUSTIBLE WEATHERROOF MATERIALS OF A WIDTH NO LESS THAN THE THICKNESS OF THE PARAPET WALL. PARAPET COPING SHALL EXTEND 2" MINIMUM DOWN THE FACES OF THE PARAPET.

## FLASHING

- APPROVED CORROSION-RESISTANT FLASHINGS SHALL BE APPLIED SHINGLE-FASHION IN A MANNER TO PREVENT ENTRY OF WATER INTO THE CAVITY OR PENETRATION OF WATER TO THE BUILDING STRUCTURAL FRAMING COMPONENTS. SELF-ADHERED MEMBRANES USED AS FLASHING SHALL COMPLY WITH AIAA 7111. FLUID-APPLIED MEMBRANES USED AS FLASHING IN EXTERIOR WALLS SHALL COMPLY WITH AIAA 7114. THE FLASHING SHALL EXTEND TO THE SURFACE OF THE EXTERIOR WALL FINISH, ALUMINUM FLASHING SHALL NOT BE USED IN CONTACT WITH CEMENTITIOUS MATERIAL, EXCEPT AT COUNTER FLASHING. APPROVED CORROSION-RESISTANT FLASHINGS SHALL BE INSTALLED AT ALL OF THE LOCATIONS STATED IN N.C.-R.
- AT ALL WINDOW AND DOOR OPENINGS USE FORTIFIBER WATER-RESISTIVE BARRIERS, I.C.C. ESR-1027, INSTALLED PER MANUFACTURER'S SPECIFICATIONS, OR APPROVED EQUAL.
- ALL BEAMS, OUTLOOKERS, CORBELS, ETC. PROJECTED THROUGH EXTERIOR WALLS OR PENETRATING EXTERIOR FINISHES SHALL BE FINISHED WITH A MINIMUM 0.019-INCH (NO. 26 SHEET METAL GAGE) CORROSION-RESISTANT METAL AND CAULKED.
- ALL SHEET METAL WORK SHALL BE PERFORMED IN ACCORDANCE WITH THE RECOMMENDATIONS AND STANDARDS OF THE SHEET METAL AND AIR CONDITIONING CONTRACTORS NATIONAL ASSOCIATION (S.M.A.C.N.A.), THE ARCHITECTURAL SHEET METAL MANUAL, AND SEALANT, WATERPROOFING AND RESTORATION INSTITUTES' (S.W.R.I.) GUIDE - "SEALANTS: THE PROFESSIONAL'S GUIDE".
- SHEET METAL SHALL BE STEEL SHEET, HOT-DIPPED TIGHT COATED AND GALVANIZED, CONFORMING TO A.S.T.M. A525 AND SHALL BE A NUMBER 24 SHEET METAL GAGE UNLESS OTHERWISE NOTED IN THESE NOTES, PLANS, OR MANUFACTURER'S SPECIFICATIONS.
- SHEET ALUMINUM SHALL CONFORM WITH FEDERAL SPECIFICATIONS QQ-A-359 AND A.S.T.M. B209 ALLOY 3003.
- FABRICATE SHEET METAL WITH FLAT LOCK SEAMS AND SOLDER WITH TYPE AND FLUX RECOMMENDED BY MANUFACTURER. SEAL ALUMINUM SEAMS WITH EPOXY METAL SEAM CEMENT. WHERE REQUIRED FOR STRENGTH, RIVET SEAMS AND JOINTS.
- SHOP FABRICATE TO THE GREATEST EXTENT POSSIBLE IN ACCORDANCE WITH APPLICABLE STANDARDS TO PROVIDE A PERMANENTLY WATER-PROOF, WEATHER RESISTANT INSTALLATION.
- ASPHALT SHINGLES SHALL HAVE SELF-SEAL STRIPS OR BE INTERLOCKING, AND COMPLY WITH ASTM D 225 OR D 3462.
- BASE AND GAP FLASHING SHALL BE INSTALLED IN ACCORDANCE WITH MANUFACTURER'S INSTALLATION INSTRUCTIONS. BASE FLASHING SHALL BE OF EITHER CORROSION-RESISTANT METAL OF MINIMUM NOMINAL 0.019-INCH THICKNESS OR MINERAL SURFACE METALS OF MINIMUM 7 T POUNDS PER 100 SQUARE FEET. CAP FLASHING SHALL BE CORROSION-RESISTANT METAL OF MINIMUM NOMINAL 0.019-INCH THICKNESS
- VALLEY LININGS SHALL BE INSTALLED IN ACCORDANCE WITH THE MANUFACTURER'S INSTALLATION INSTRUCTIONS BEFORE APPLYING SHINGLES. VALLEY LININGS OF THE FOLLOWING TYPES SHALL BE PERMITTED AS STATED PER THE N.C.-R
- A CRICKET OR SADDLE SHALL BE INSTALLED ON THE RIDGE SIDE OF ANY CHIMNEY OR PENETRATION MORE THAN 30 INCHES WIDE AS MEASURED PERPENDICULAR TO THE SLOPE. CRICKET OR SADDLE COVERINGS SHALL BE SHEET METAL OR OF THE SAME MATERIAL AS THE ROOF COVERING. PROVIDE FLASHING AT THE INTERSECTION OF CRICKET OR SADDLE AND THE CHIMNEY.
- FLASHING AGAINST A VERTICAL SIDEWALL SHALL BE BY THE STEP-FLASHING METHOD PER N.C.-R.
- FLASHING AGAINST A VERTICAL FRONT WALL, AS WELL AS SOIL STACK, VENT PIPE AND CHIMNEY FLASHING, SHALL BE APPLIED ACCORDING TO THE ASPHALT SHINGLE MANUFACTURER'S PRINTED INSTRUCTIONS.
- AT THE JUNCTURE OF ROOF VERTICAL SURFACES, FLASHING AND COUNTERFLASHING SHALL BE PROVIDED IN ACCORDANCE WITH THE N.C.-R AND THE MANUFACTURER'S INSTALLATION INSTRUCTIONS AND, WHERE OF METAL, SHALL NOT BE LESS THAN 0.019 INCH (NO. 26 GALVANIZED SHEET GAGE) CORROSION-RESISTANT METAL
- VALLEY FLASHING FOR CONCRETE TILE ROOFS SHALL BE AS REQUIRED.

## ROOFING MATERIALS

- ROOF COVERINGS SHALL BE APPLIED IN ACCORDANCE WITH THE N.C.-R AND THE MANUFACTURER'S INSTALLATION INSTRUCTIONS. INSTALLATION OF ROOF COVERINGS SHALL COMPLY WITH THE APPLICABLE PROVISIONS OF THE N.C.-R.
- ROOFS AND ROOF COVERINGS SHALL BE OF MATERIALS THAT ARE COMPATIBLE WITH EACH OTHER AND WITH THE BUILDING OR STRUCTURE TO WHICH THE MATERIALS ARE APPLIED.
- ROOF COVERING MATERIALS SHALL CONFORM TO THE APPLICABLE STANDARDS LISTED IN THE N.C.-R IN THE ABSENCE OF APPLICABLE STANDARDS. IF ANY MATERIALS ARE OF QUESTIONABLE SUITABILITY, TESTING BY AN APPROVED TESTING AGENCY SHALL BE REQUIRED BY THE BUILDING OFFICIAL TO DETERMINE THE CHARACTER, QUALITY, AND LIMITATIONS OF APPLICATION OF THE MATERIALS.

# THERMAL & MOISTURE PROTECTION (continued)

- ROOF COVERING MATERIALS SHALL BE DELIVERED IN PACKAGES BEARING THE MANUFACTURER'S IDENTIFYING MARKS AND APPROVED TESTING AGENCY LABELS. WHEN REQUIRED, BULK SHIPMENTS OF MATERIALS SHALL BE ACCOMPANIED BY THE SAME INFORMATION ISSUED IN THE FORM OF A CERTIFICATE OR ON A BILL OF LADING BY THE MANUFACTURER
- COMPOSITION ROOFING SHINGLES SHALL BE OF ASPHALT OR APPROVED RELATED MATERIALS AND MEET THE REQUIREMENTS OF THE N.C.-R
- UNDERLAYMENT FOR ASPHALT SHINGLES SHALL CONFORM TO ASTM D 226 TYPE I, ASTM D 4864 TYPE I, OR ASTM D 6781, SELF-ADHERING POLYMER MODIFIED BITUMEN SHEET SHALL COMPLY WITH ASTM D 1970
- ASPHALT SHINGLES SHALL COMPLY WITH ASTM D 225 OR ASTM D 3462.
- FASTENERS FOR ASPHALT SHINGLES SHALL BE GALVANIZED STEEL, STAINLESS STEEL, ALUMINUM, OR COPPER ROOFING NAILS, MINIMUM 12 GAGE SHANK WITH A MINIMUM 3/8 INCH DIAMETER HEAD, ASTM F 1667, OF A LENGTH TO PENETRATE THROUGH THE ROOFING MATERIALS AND A MINIMUM OF 3/4 INCH INTO THE ROOF FINISHING. FASTENERS OF SHEATHINGS IS LESS THAN 3/4 INCH THICK, THE FASTENERS SHALL PENETRATE THROUGH THE SHEATHING. FASTENERS SHALL COMPLY WITH ASTM F 1667.
- ASPHALT SHINGLES SHALL HAVE THE MINIMUM NUMBER OF FASTENERS REQUIRED BY THE MANUFACTURER. FOR NORMAL APPLICATION, ASPHALT SHINGLES SHALL BE SECURED TO THE ROOF WITH NOT LESS THAN FOUR FASTENERS PER STRIP SHINGLE OR TWO FASTENERS PER INDIVIDUAL SHINGLE PER N.C.-R.
- UNDERLAYMENT FOR ASPHALT SHINGLES SHALL BE APPLIED IN ACCORDANCE WITH THE N.C.-R
- THE INSTALLATION OF GLAY AND CONCRETE TILE SHALL COMPLY WITH THE PROVISIONS OF N.C.-R CLAY ROOF TILE SHALL COMPLY WITH ASTM C 1167.
- CONCRETE AND CLAY TILE SHALL BE INSTALLED ONLY OVER SOLID SHEATHING OR SPACED STRUCTURAL SHEATHING BOARDS.
- CLAY AND CONCRETE ROOF TILE SHALL BE INSTALLED ON ROOF SLOPES OF 2 1/2 UNITS VERTICAL IN 12 UNITS HORIZONTAL (2-1/2:12) OR GREATER. FOR ROOF SLOPES FROM 2 1/2 UNITS VERTICAL IN 12 UNITS HORIZONTAL (2-1/2:12) TO FOUR UNITS VERTICAL IN 12 UNITS HORIZONTAL (4:12), DOUBLE UNDERLAYMENT APPLICATION IS REQUIRED IN ACCORDANCE WITH THE N.C.-R
- UNDERLAYMENT FOR CLAY AND CONCRETE TILE SHALL CONFORM WITH ASTM D 226, TYPE II; ASTM D 2626 TYPE I; OR ASTM D 6380 CLASS M MINERAL SURFACED ROLL ROOFING.
- CONCRETE ROOF TILE SHALL COMPLY WITH ASTM C 1492.
- NAILS SHALL BE CORROSION-RESISTANT AND NOT LESS THAN 11 GAGE, 5/16-INCH HEAD, AND OF SUFFICIENT LENGTH TO PENETRATE THE DECK A MINIMUM OF 3/4-INCH OR THROUGH THE THICKNESS OF THE DECK, WHICHEVER IS LESS. ATTACHING WIRE FOR CLAY OR CONCRETE TILE SHALL NOT BE SMALLER THAN 0.089-INCH. PERIMETER FASTENING AREAS INCLUDE THREE TILE COURSES BUT NOT LESS THAN 36 INCHES FROM EITHER SIDE OF HIPS OR RIDGES AND EDGES OF EAVES AND GABLE RAKES. N.C.-R
- CLAY AND CONCRETE ROOF TILES SHALL BE FASTENED IN ACCORDANCE WITH THE N.C.-R
- TILE SHALL BE APPLIED ACCORDING TO THE MANUFACTURER'S INSTALLATION INSTRUCTIONS, BASED ON CLIMATIC CONDITIONS, ROOF SLOPE, UNDERLAYMENT SYSTEM, AND TYPE OF TILE BEING INSTALLED PER THE N.C.-R
- THE INSTALLATION OF BUILT-UP ROOFS SHALL COMPLY WITH THE N.C.-R
- BUILT-UP ROOFS SHALL HAVE A DESIGN SLOPE OF A MINIMUM OF ONE-FOURTH UNIT VERTICAL IN 12 UNITS HORIZONTAL (2-PERCENT SLOPE) FOR DRAINAGE, EXCEPT FOR GOAL-TAR BUILT-UP ROOFS THAT SHALL HAVE A DESIGN SLOPE OF A MINIMUM ONE-EIGHTH UNIT VERTICAL IN 12 UNITS HORIZONTAL (1-PERCENT SLOPE).
- BUILT-UP ROOF COVERING MATERIALS SHALL COMPLY WITH THE STANDARDS PER THE N.C.-R

## EXTERIOR WALL COVERINGS

- SEE FINISHES IN THESE GENERAL NOTES FOR EXTERIOR PLASTER.
- MATERIALS USED FOR THE CONSTRUCTION OF EXTERIOR WALLS SHALL COMPLY WITH THE PROVISIONS OF THE N.C.-R.
- EXTERIOR WALLS SHALL PROVIDE THE BUILDING WITH A WEATHER-RESISTANT EXTERIOR WALL ENVELOPE. THE EXTERIOR WALL ENVELOPE SHALL BE DESIGNED AND CONSTRUCTED IN A MANNER THAT PREVENTS THE ACCUMULATION OF WATER WITHIN THE WALL ASSEMBLY BY PROVIDING A WATER-RESISTANT BARRIER BEHIND THE EXTERIOR VENEER AS REQUIRED AND A MEANS OF DRAINING WATER THAT ENTERS THE ASSEMBLY TO THE EXTERIOR. PROTECTION AGAINST CONDENSATION IN THE EXTERIOR WALL ASSEMBLY SHALL BE PROVIDED.
- ONE LAYER OF NO. 15 ASPHALT FELT, FREE FROM HOLES AND BREAKS, COMPLYING WITH ASTM D 226 FOR TYPE I FELT OR OTHER APPROVED WATER-RESISTIVE BARRIER SHALL BE APPLIED OVER STUDS OR SHEATHING OF ALL EXTERIOR WALLS. SUCH FELT OR MATERIAL SHALL BE APPLIED HORIZONTALLY, WITH THE UPPER LAYER LAPPED OVER THE LOWER LAYER NOT LESS THAN 2 INCHES, WHERE JOINTS OCCUR, FELT SHALL BE LAPPED NOT LESS THAN 6 INCHES. THE FELT OR OTHER APPROVED MATERIAL SHALL BE CONTINUOUS TO THE TOP OF WALLS AND TERMINATED AT PENETRATIONS AND BUILDING APPENDAGES IN A MANNER TO MEET THE REQUIREMENTS OF THE EXTERIOR WALL ENVELOPE.
- VINYL SIDING CONFORMING TO THE REQUIREMENTS OF THE N.C.-R AND COMPLYING WITH ASTM D 3674 SHALL BE PERMITTED ON EXTERIOR WALLS OF BUILDINGS OF TYPE V CONSTRUCTION LOCATED IN AREAS WHERE THE ULTIMATE WIND SPEED SPECIFIED DOES NOT EXCEED 100 MILES PER HOUR AND THE BUILDING HEIGHT IS LESS THAN 40 FEET IN EXPOSURE C. WHERE CONSTRUCTION IS LOCATED IN AREAS WHERE THE ULTIMATE WIND SPEED EXCEEDS 100 MILES PER HOUR OR BUILDING HEIGHTS ARE IN EXCESS OF 40 FT., DATA INDICATING COMPLIANCE MUST BE SUBMITTED. VINYL SIDING SHALL BE SECURED TO BUILDING TO PROVIDE WEATHER PROTECTION FOR THE EXTERIOR WALLS OF THE BUILDING.
- VINYL SIDING SHALL BE APPLIED OVER SHEATHING OR MATERIALS LISTED IN THE N.C.-R. VINYL SIDING SHALL BE APPLIED TO CONFORM WITH THE WEATHER-RESISTIVE BARRIER REQUIREMENTS VINYL SIDING AND ACCESSORIES SHALL BE INSTALLED IN ACCORDANCE WITH APPROVED MANUFACTURER'S INSTRUCTIONS.
- VINYL SIDING FASTENERS AND ACCESSORIES SHALL MEET THE REQUIREMENTS OF THE N.C.-B
- EXTERIOR WALLS OF WOOD CONSTRUCTION SHALL BE DESIGNED AND CONSTRUCTED IN ACCORDANCE WITH THE N.C.-R

# THERMAL & MOISTURE PROTECTION (continued)

- HARDBOARD SIDING SHALL CONFORM TO THE REQUIREMENTS OF AIA A195.6 AND, WHERE USED STRUCTURALLY, SHALL BE SO IDENTIFIED BY THE LABEL OF AN APPROVED AGENCY.
- WOOD VENEERS ON EXTERIOR WALLS OF BUILDINGS OF TYPES I, II, III, AND IV CONSTRUCTION SHALL BE NOT LESS THAN 1-INCH NOMINAL THICKNESS, 0.438-INCH EXTERIOR HARDBOARD SIDING OR 0.375-INCH EXTERIOR-TYPE WOOD STRUCTURAL PANELS OR PARTICLE-BOARD AND SHALL CONFORM TO THE REQUIREMENTS OF THE N.C.-R
- FIBER-CEMENT LAP SIDING HAVING A MAXIMUM WIDTH OF 12 INCHES SHALL COMPLY WITH THE REQUIREMENTS OF ASTM C1186, TYPE A, MINIMUM GRADE II. LAP SIDING SHALL BE LAPPED A MINIMUM OF 1/4 INCHES (82 MM) AND LAP SIDING NOT HAVING TONGUE-AND-GROOVE END JOINTS SHALL HAVE THE ENDS SEALED WITH CAULKING, INSTALLED WITH AN H-SECTION JOINT COVER, LOCATED OVER A STRIP OF FLASHING OR SHALL BE DESIGNED TO COMPLY WITH N.C.-R. LAP SIDING COURSES MAY BE INSTALLED WITH THE FASTENER HEADS EXPOSED OR CONCEALED, ACCORDING TO N.C.-R OR APPROVED MANUFACTURER'S INSTALLATION INSTRUCTIONS.
- INSULATING MATERIALS, INCLUDING FACINGS, SUCH AS VAPOR RETARDERS OR VAPOR-PERMEABLE MEMBRANES INSTALLED WITHIN FLOOR-CEILING ASSEMBLIES, ROOF-CEILING ASSEMBLIES, WALL-ASSEMBLIES, CRAWL SPACES AND ATTICS SHALL HAVE A FLAME-SPREAD INDEX NOT TO EXCEED 25 TO EXCEED AN ACCOMPANYING SMOKE-DEVELOPED INDEX NOT TO EXCEED 450 WHEN TESTED IN ACCORDANCE WITH ASTM E 84 OR UL T29.
- DUCT INSULATION MATERIALS SHALL CONFORM TO THE FOLLOWING REQUIREMENTS OF THE N.C.-R
- INSULATION AND COVERINGS ON PIPE AND TUBING SHALL HAVE A FLAME-SPREAD INDEX OF NOT MORE THAN 25 AND A SMOKE-DEVELOPED INDEX OF NOT MORE THAN 450. SEE EXCEPTIONS.
- ALL EXPOSED INSULATION MATERIALS INSTALLED ON ATTIC FLOORS SHALL HAVE A CRITICAL RADIANT FLUX OF NOT LESS THAN 0.12 WATT PER SQUARE FOOT. INSULATION FOR CRITICAL RADIANT FLUX SHALL BE MADE IN ACCORDANCE WITH ASTM E 970.
- THE USE OF ABOVE DECK THERMAL INSULATION SHALL BE PERMITTED PROVIDED SUCH INSULATION IS COVERED WITH AN APPROVED ROOF COVERING AND PASSES FM 4450 OR UL 1256 PER N.C.-R.
- CELLULOSE LOOSE-FILL INSULATION SHALL COMPLY WITH CPSC 16 CFR, PARTS 1204 AND 1404. EACH PACKAGE OF SUCH INSULATING MATERIAL SHALL BE CLEARLY LABELED IN ACCORDANCE WITH CPSC 16 CFR, PARTS 1204 AND 1404.
- INSULATION IN FLOOR-CEILING ASSEMBLIES, ROOF-CEILING ASSEMBLIES, WALLS, CRAWL SPACES OR ATTICS SHALL BE EITHER OF THE BLOW-IN CELLULOSE TYPE OR FIBERGLASS BATTS OR BLANKET TYPE PER BUILDER'S SPECIFICATIONS.
- THE ENERGY EFFICIENCY REQUIREMENTS INCLUDING I.E.C.C. BUT NOT LIMITED TO INSULATION "R" VALUES, PERCENTAGE OF GLAZING "U" VALUES, ETC. SHALL BE DETERMINED BY THE ADOPTED STATE AND LOCAL ENERGY CODE REQUIREMENTS. REFER TO MECHANICAL PLANS FOR SPECIFICATIONS.
- THE BUILDING THERMAL ENVELOPE SHALL BE DURABLY SEALED WITH AN AIR BARRIER SYSTEM TO LIMIT INFILTRATION. THE SEALING METHODS BETWEEN DISSIMILAR MATERIALS SHALL ALLOW FOR DIFFERENTIAL EXPANSION AND CONTRACTION. FOR ALL HOMES, WHERE PRESENT, THE FOLLOWING SHALL BE CAULKED, GASKETED, WEATHERSTRIPPED OR OTHERWISE SEALED WITH AN AIR BARRIER MATERIAL OR SOLID MATERIAL CONSISTENT WITH APPENDIX E-2.3 AND E-2.4 OF THE N.C.-R:
  - BLOCKING AND SEALING FLOOR/CEILING SYSTEMS AND UNDER KITCHEN ISLANDS OPEN TO UNCONDITIONED OR EXTERIOR SPACE.
  - CAPPING AND SEALING SHAFTS OR CHASES, INCLUDING FLUE SHAFTS.
  - CAPPING AND SEALING SOFFIT OR DROPPED CEILING AREAS.
- FRAMED CAVITY WALLS. THE EXTERIOR THERMAL ENVELOPE WALL INSULATION SHALL BE INSTALLED IN SUBSTANTIAL CONTACT AND CONTINUOUS ALIGNMENT WITH THE BUILDING AIR BARRIER. INSULATION SHALL BE SUBSTANTIALLY FREE FROM INSTALLATION GAPS, VOIDS, OR COMPRESSION. FOR FRAMED WALLS, THE CAVITY INSULATION SHALL BE ENCLOSED ON ALL SIDES WITH A RIGID MATERIAL OR AN AIR BARRIER MATERIAL. WALL INSULATION SHALL BE ENCLOSED AT THE FOLLOWING LOCATIONS WHEN INSTALLED ON EXTERIOR WALLS PRIOR TO BEING COVERED BY SUBSEQUENT CONSTRUCTION, CONSISTENT WITH APPENDIX E-2.3 AND E-2.4 OF N.C.-R:
  - TUBS
  - SHOWERS
  - STAIRS
  - FIREPLACE UNITS
 ENCLOSURE OF WALL CAVITY INSULATION ALSO APPLIES TO WALLS THAT ADJOIN ATTIC SPACES BY PLACING A RIGID MATERIAL OR AIR BARRIER MATERIAL ON THE ATTIC SIDE.

# DOORS & WINDOWS

- SEE FLOOR PLANS AND ELEVATIONS FOR SIZES AND TYPES OF DOORS AND WINDOWS AND FOR ANY DIVIDED LITE PATTERNS. COLORS SHALL BE APPROVED BY THE BUILDER AND ARCHITECT.
- OPENINGS FROM A PRIVATE GARAGE DIRECTLY INTO A ROOM USED FOR SLEEPING PURPOSES SHALL NOT BE PERMITTED. OTHER OPENINGS BETWEEN THE GARAGE AND RESIDENCE SHALL BE EQUIPPED WITH SOLID WOOD DOORS NOT LESS THAN 1 3/8 INCHES IN THICKNESS, SOLID OR HONEYCOMB CORE STEEL DOORS NOT LESS THAN 1 3/8 INCHES THICK, OR 20-MINUTE FIRE-RATED DOORS.
- NO DOUBLE FRENCH DOORS SHALL BE USED UNLESS THERE IS A SUFFICIENT OVERHANG OR COVERED PATIO COVERING THESE DOORS. NO DOUBLE HOOD FRENCH DOORS SHALL BE USED IN ANY CASE.
- PROVIDE SECURITY HARDWARE FOR ALL DOORS AND WINDOWS IN CONFORMANCE WITH ALL STATE AND LOCAL CODE REQUIREMENTS.
- ALL AUTOMATIC GARAGE DOOR OPENERS REQUIRE THE INCLUSION OF A PHOTOELECTRIC SENSOR, EGRESS SENSOR OR SOME OTHER SAFETY DEVICE FOR REMOTE OPERATION AND AS A SAFETY PRECAUTION TO PREVENT THE DOOR FROM CLOSING WHEN SOMETHING IS BLOCKING THE PATH OF THE DOOR. SEE MANUFACTURER'S INSTALLATION INSTRUCTIONS.
- ALL MANUFACTURED WINDOWS AND SLIDING GLASS DOORS SHALL MEET THE AIR INFILTRATION STANDARDS OF THE CURRENT AMERICAN NATIONAL STANDARDS INSTITUTE A.S.T.M. E283-78 WITH A PRESSURE DIFFERENTIAL OF 1.57 POUNDS PER SQUARE FOOT AND SHALL BE CERTIFIED AND LABELED.
- BASEMENTS, HABITABLE ATTICS AND EVERY SLEEPING ROOM SHALL HAVE AT LEAST ONE OPERABLE EMERGENCY ESCAPE AND RESCUE OPENING
- WHERE EMERGENCY ESCAPE AND RESCUE OPENINGS ARE PROVIDED THEY SHALL HAVE A SILL HEIGHT OF NOT MORE THAN 44 INCHES ABOVE THE FLOOR.
- EMERGENCY ESCAPE AND RESCUE OPENINGS WITH A FINISHED SILL HEIGHT BELOW THE ADJACENT GROUND ELEVATION SHALL BE PROVIDED WITH A WINDOW WELL.

# DOORS & WINDOWS (continued)

- ALL EMERGENCY ESCAPE AND RESCUE OPENINGS SHALL HAVE A MINIMUM NET CLEAR OPENING OF NOT LESS THAN 5.7 SQUARE FEET IN THE CASE OF A GROUND FLOOR LEVEL WINDOW AND NOT LESS THAN 5.7 SQUARE FEET IN THE CASE OF AN UPPER STORY WINDOW.
- ALL EMERGENCY ESCAPE AND RESCUE OPENINGS SHALL HAVE A MINIMUM NET CLEAR OPENING HEIGHT OF 24 INCHES.
- ALL EMERGENCY ESCAPE AND RESCUE OPENINGS SHALL HAVE A MINIMUM NET CLEAR OPENING WIDTH OF 20 INCHES.
- EMERGENCY ESCAPE AND RESCUE OPENINGS SHALL BE OPERATIONAL FROM THE INSIDE OF THE ROOM WITHOUT THE USE OF KEYS, TOOLS OR SPECIAL KNOWLEDGE.
- THE MINIMUM HORIZONTAL AREA OF THE WINDOW WELL SHALL BE 9 SQUARE FEET, WITH A MINIMUM HORIZONTAL PROJECTION AND WIDTH OF 36 INCHES. THE AREA OF THE WINDOW WELL SHALL ALLOW EMERGENCY ESCAPE AND RESCUE OPENING TO BE FULLY OPENED PER THE N.C.-R THE LADDER OR STEPS REQUIRED SHALL BE PERMITTED TO ENCRoACH A MAXIMUM OF 6" INTO THE REQUIRED DIMENSIONS OF THE WINDOW WELL.
- WINDOW WELLS WITH A VERTICAL DEPTH GREATER THAN 44 INCHES SHALL BE EQUIPPED WITH A PERMANENTLY AFFIXED LADDER OR STEPS USABLE WITH THE WINDOW IN THE FULLY OPEN POSITION.
- BARs, GRILLES, COVERS, SCREENS OR SIMILAR DEVICES ARE PERMITTED TO BE PLACED OVER EMERGENCY ESCAPE AND RESCUE OPENINGS, BULKHEAD ENCLOSURES, OR WINDOW WELLS THAT SERVE SUCH OPENINGS, PROVIDED THE MINIMUM NET CLEAR OPENING SIZE COMPLIES WITH THE N.C.-R AND SUCH DEVICES SHALL BE RELEASABLE OR REMOVABLE FROM THE INSIDE WITHOUT THE USE OF A KEY, TOOL, SPECIAL KNOWLEDGE OR FORCE GREATER THAN THAT WHICH IS REQUIRED FOR NORMAL OPERATION OF THE ESCAPE AND RESCUE OPENING.
- ALL INTERIOR EGRESS DOORS AND A MINIMUM OF ONE EXTERIOR EGRESS DOOR SHALL BE READILY OPERABLE FROM THE SIDE FROM WHICH EGRESS IS TO BE MADE WITHOUT THE USE OF A KEY OR SPECIAL KNOWLEDGE OR EFFORT.
- HABITABLE ROOMS SHALL HAVE AN AGGREGATE GLAZING AREA OF NOT LESS THAN 8 PERCENT OF THE FLOOR AREA OF SUCH ROOMS. NATURAL VENTILATION SHALL BE THROUGH WINDOWS, SKYLIGHTS, DOORS, LOUVERS OR OTHER APPROVED OPENINGS TO THE OUTDOOR AIR. SUCH OPENINGS SHALL BE PROVIDED WITH READY ACCESS OR SHALL BE OTHERWISE READILY CONTROLLED BY THE BUILDING OCCUPANTS. THE OPENABLE AREA TO THE OUTDOORS SHALL BE NOT LESS THAN 4 PERCENT OF THE FLOOR AREA BEING VENTILATED.
- BATHROOMS, WATER CLOSET COMPARTMENTS AND OTHER SIMILAR ROOMS SHALL BE PROVIDED WITH AGGREGATE GLAZING AREAS IN WINDOWS OF NOT LESS THAN 3 SQUARE FEET, ONE-HALF OF WHICH MUST BE OPENABLE.
- EXCEPT AS INDICATED, EACH PANE OF GLAZING INSTALLED IN HAZARDOUS LOCATIONS SHALL BE PROVIDED WITH MANUFACTURER'S DESIGNATION SPECIFYING WHO APPLIED THE DESIGNATION DESIGNATING THE TYPE OF GLASS AND THE SAFETY GLAZING STANDARD WITH WHICH IT COMPLIES, WHICH IS VISIBLE IN THE FINAL INSTALLATION. THE DESIGNATION SHALL BE ACID ETCHED, SANDBLASTED, CERAMIC-FIRED, LASER ETCHED, EMBOSSED, OR BE OF A TYPE WHICH ONCE APPLIED CANNOT BE REMOVED WITHOUT BEING DESTROYED.
- INDIVIDUAL GLAZED AREAS, INCLUDING GLASS MIRRORS IN HAZARDOUS LOCATIONS SHALL PASS THE TEST REQUIREMENTS OF CPSC 16 CFR, PART 1201. GLAZING SHALL COMPLY WITH CPSC 16.
- THE FOLLOWING SHALL BE CONSIDERED SPECIFIC HAZARDOUS LOCATIONS FOR THE PURPOSES OF GLAZING:
  - GLAZING IN ALL FIXED AND OPERABLE PANELS OF SWINGS, SLIDING AND BIFOLD DOORS
  - GLAZING IN AN INDIVIDUAL FIXED OR OPERABLE PANEL IN THE SAME PLANE AS A DOOR WHERE THE NEAREST VERTICAL EDGE IS WITHIN 24-INCHES OF THE DOOR IN A CLOSED POSITION AND WHOSE BOTTOM EDGE IS LESS THAN 60 INCHES ABOVE THE FLOOR OR WALKING SURFACE.
  - GLAZING IN AN INDIVIDUAL FIXED OR OPERABLE PANEL THAT MEETS ALL OF THE FOLLOWING CONDITIONS:
    - EXPOSED AREA OF AN INDIVIDUAL PANE LARGER THAN 9 SQUARE FEET.
    - BOTTOM EDGE LESS THAN 18 INCHES ABOVE THE FLOOR.
    - TOP EDGE MORE THAN 36 INCHES ABOVE THE FLOOR.
    - ONE OR MORE WALKING SURFACES WITHIN 36 INCHES, MEASURED HORIZONTALLY AND IN A STRAIGHT LINE, OF THE GLAZING.
  - GLAZING IN GUARDS AND RAILINGS, INCLUDING STRUCTURAL BALUSTER PANELS AND NONSTRUCTURAL INFILL PANELS, REGARDLESS OF AREA OR HEIGHT ABOVE A WALKING SURFACE.
  - GLAZING IN DOORS AND ENCLOSURES FOR HOT TUBS, WHIRLPOOLS, SAUNAS, STEAM ROOMS, BATHROOMS AND SHOWERS. GLAZING ENCLOSES THESE COMPARTMENTS WHERE THE BOTTOM EXPOSED EDGE OF THE GLAZING IS LESS THAN 60 INCHES MEASURED VERTICALLY ABOVE ANY STANDING OR WALKING SURFACE.
  - GLAZING IN WALLS AND FENCES ENCLOSING INDOOR AND OUTDOOR SWIMMING POOLS, HOT TUBS AND SPAS WHERE THE BOTTOM EDGE OF THE GLAZING IS LESS THAN 60 INCHES ABOVE A WALKING SURFACE AND WITHIN 60 INCHES HORIZONTALLY OF THE WATER'S EDGE. THIS SHALL APPLY TO SINGLE GLAZING AND ALL PANES IN MULTIPLE GLAZING.
  - GLAZING ADJACENT TO STAIRWAYS, LANDINGS AND RAMPS WITHIN 36 INCHES HORIZONTALLY OF A WALKING SURFACE WHEN THE EXPOSED SURFACE OF THE GLAZING IS LESS THAN 36 INCHES ABOVE THE PLANE OF THE ADJACENT WALKING SURFACE.
  - GLAZING ADJACENT TO THE LANDING AT THE BOTTOM OF STAIRWAYS WHERE THE GLAZING IS LESS THAN 36 INCHES ABOVE THE LANDING AND WITHIN A 60-INCH HORIZONTAL ARC LESS THAN 180 DEGREES FROM THE BOTTOM TREAD NOSING.
  - HINGED SHOWER DOORS SHALL OPEN OUTWARD.
  - GLAZING SHALL BE IN ACCORDANCE WITH ENERGY COMPLIANCE CALCULATIONS BASED ON A LOCALLY ADOPTED ENERGY CODE, THE MODEL ENERGY CODE OR THE INTERNATIONAL ENERGY CONSERVATION CODE.
  - IN DWELLING UNITS, WHERE THE OPENING OF AN OPERABLE WINDOW IS LOCATED MORE THAN 72 INCHES (829 MM) ABOVE THE FINISHED GRADE OR SURFACE BELOW, THE LOWEST PART OF THE CLEAR OPENING OF THE WINDOW SHALL BE A MINIMUM OF 24 INCHES (610 MM) ABOVE THE FINISHED FLOOR OF THE ROOM IN WHICH THE WINDOW IS LOCATED. OPERABLE SECTIONS OF WINDOWS SHALL NOT PERMIT OPENINGS THAT ALLOW PASSAGE OF A 4 INCH (102 MM) DIAMETER SPHERE WHERE SUCH OPENINGS ARE LOCATED WITHIN 24 INCHES (610 MM) OF THE FINISHED FLOOR.

# FINISHES

## GYPSUM BOARD

- GYPSUM WALLBOARD SHALL BE INSTALLED IN CONFORMANCE WITH THE CURRENT EDITION OF THE NORTH CAROLINA RESIDENTIAL CODE AND ALL STATE AND LOCAL BUILDING CODES. THE MOST STRINGENT REQUIREMENTS SHALL GOVERN.
- MATERIALS. ALL GYPSUM BOARD MATERIALS AND ACCESSORIES SHALL CONFORM TO ASTM C 22, C 475, C 514, C 1002, C 1047, C 1171, C 1178, C 1278, C 1846, OR C 1658 AND SHALL BE INSTALLED IN ACCORDANCE WITH THE PROVISIONS OF THE N.C.-R. ADHESIVES FOR THE INSTALLATION OF GYPSUM BOARD SHALL CONFORM TO ASTM C 857.
- GYPSUM BOARD MATERIALS SHALL CONFORM TO THE APPROPRIATE STANDARDS LISTED IN THE N.C.-R WHERE REQUIRED FOR FIRE PROTECTION, CONFORM TO THE N.C.-R
- INTERIOR GYPSUM BOARD SHALL NOT BE INSTALLED WHERE IT IS DIRECTLY EXPOSED TO THE WEATHER OR TO WATER.
- ALL EDGES AND ENDS OF GYPSUM BOARD SHALL OCCUR ON THE FRAMING MEMBERS EXCEPT THOSE EDGES AND ENDS THAT ARE PERPENDICULAR TO THE FRAMING MEMBERS. EDGES AND ENDS OF GYPSUM BOARD SHALL BE IN MODERATE CONTACT EXCEPT IN CONCEALED SPACES WHERE FIRE-RESISTANCE-RATED CONSTRUCTION, SHEAR RESISTANCE, OR DIAPHRAGM ACTION IS NOT REQUIRED. CONCEALED SPACES WHERE FIRE-RESISTANCE-RATED CONSTRUCTION.
- FASTENERS AT THE TOP AND BOTTOM PLATES OF VERTICAL ASSEMBLIES, OR THE EDGES AND ENDS OF HORIZONTAL ASSEMBLIES PERPENDICULAR TO SUPPORTS, AND AT THE WALL LINE MAY BE OMITTED EXCEPT ON SHEAR-RESISTING ELEMENTS OR FIRE-RESISTIVE ASSEMBLIES. FASTENERS SHALL BE APPLIED IN SUCH A MANNER AS NOT TO FRACTURE THE FACE PAPER WITH THE FASTENER HEAD.
- GYPSUM BOARD USED AS THE BASE OR BACKER FOR ADHESIVE APPLICATION OF CERAMIC TILE OR OTHER REQUIRED NON-ABSORBENT FINISH MATERIAL SHALL CONFORM TO ASTM C 1396, C 1178 OR C1278. USE OF WATER-RESISTANT GYPSUM BACKING BOARD SHALL BE PERMITTED ON CEILING WHERE FRAMING SPACING DOES NOT EXCEED 12 INCHES ON CENTER FOR 1/2-INCH-THICK OR 16 INCHES FOR 5/8-INCH-THICK GYPSUM BOARD. WATER-RESISTANT GYPSUM BOARD SHALL NOT BE INSTALLED OVER A VAPOR RETARDER IN A SHOWER OR TUB COMPARTMENT. CUT OR EXPOSED EDGES, INCLUDING THOSE AT WALL INTERSECTIONS, SHALL BE SEALED AS RECOMMENDED BY THE MANUFACTURER.
- WATER RESISTANT GYPSUM BACKING BOARD SHALL NOT BE USED WHERE THERE WILL BE DIRECT EXPOSURE TO WATER, OR IN AREAS SUBJECT TO CONTINUOUS HIGH HUMIDITY.
- WHEN APPLYING A WATER-BASED TEXTURE MATERIAL, THE MINIMUM GYPSUM BOARD THICKNESS SHALL BE INCREASED FROM 5/8 INCH TO 1/2 INCH FOR 16-INCH ON CENTER FRAMING, AND FROM 1/2 INCH TO 5/8 INCH FOR 24-INCH ON CENTER FRAMING OR 1/2 INCH 5/8-RESISTANT GYPSUM CEILING BOARD SHALL BE USED.

## EXTERIOR LATH

- ALL LATH AND LATH ATTACHMENTS SHALL BE OF CORROSION-RESISTANT MATERIAL.
- BACKING OR A LATH SHALL PROVIDE SUFFICIENT RIGIDITY TO PERMIT PLASTER APPLICATION.
- WHERE LATH ON VERTICAL SURFACES EXTENDS BETWEEN RAFTERS OR OTHER SIMILAR PROJECTING MEMBERS, SOLID BACKING SHALL BE INSTALLED TO PROVIDE SUPPORT FOR LATH AND ATTACHMENTS.
- GYPSUM LATH OR GYPSUM BOARD SHALL NOT BE USED, EXCEPT THAT ON HORIZONTAL SUPPORTS OF CEILINGS OR ROOF SOFFITS IT MAY BE USED AS BACKING FOR METAL LATH OR WIRE FABRIC LATH AND CEMENT PLASTER.
- UNLESS SPECIFIED OTHERWISE, ALL WALL COVERINGS SHALL BE SECURELY FASTENED PER THE N.C.-R OR WITH OTHER APPROVED ALUMINUM, STAINLESS STEEL, ZINC-COATED OR OTHER APPROVED CORROSION-RESISTIVE FASTENERS. WHERE THE BASIC WIND SPEED IS 110 MPH OR HIGHER, THE ATTACHMENT OF WALL COVERINGS SHALL BE DESIGNED TO RESIST THE COMPONENT AND GLADDING LOADS SPECIFIED AND ADJUSTED FOR HEIGHT AND EXPOSURE.
- A MINIMUM 0.019-INCH (NO. 26 GALVANIZED SHEET GAGE) CORROSION-RESISTANT KEEF SCREED OR PLASTIC KEEF SCREED, WITH A MINIMUM VERTICAL ATTACHMENT FLANGE OF 9/2 INCHES SHALL BE PROVIDED AT OR BELOW THE FOUNDATION PLATE LINE ON EXTERIOR STUD WALLS IN ACCORDANCE WITH ASTM C 926. THE KEEF SCREED SHALL BE PLACED A MINIMUM OF 4 INCHES ABOVE THE EARTH OR 2 INCHES ABOVE FLAVED AREA AND SHALL BE OF A TYPE THAT WILL ALLOW TRAPPED WATER TO DRAIN TO THE EXTERIOR OF THE BUILDING. THE WEATHER-RESISTANT BARRIER SHALL LAP THE ATTACHMENT FLANGE, THE EXTERIOR LATH SHALL COVER AND TERMINATE ON THE ATTACHMENT FLANGE OF THE KEEF SCREED.

## EXTERIOR PLASTER

- PLASTERING WITH PORTLAND CEMENT PLASTER SHALL BE NOT LESS THAN THREE COATS WHEN APPLIED OVER METAL LATH OR WIRE LATH AND SHALL BE NOT LESS THAN TWO COATS WHEN APPLIED OVER MASONRY, CONCRETE, PRESSURE-PRESERVATIVE TREATED WOOD OR DECAY-RESISTANT WOOD OR GYPSUM BACKING. IF THE PLASTER SURFACE IS COMPLETELY COVERED BY VENEER OR OTHER FACING MATERIAL OR IS COMPLETELY CONCEALED, PLASTER APPLICATION NEED BE ONLY TWO COATS, PROVIDED THE TOTAL THICKNESS IS AS SET FORTH PER THE N.C.-R
- ON WOOD-FRAME CONSTRUCTION WITH AN ON-GRADE FLOOR SLAB SYSTEM, EXTERIOR PLASTER SHALL BE APPLIED TO COVER, BUT NOT EXTEND BELOW, LATH, PAPER AND SCREED.
- THE PROPORTION OF AGGREGATE TO CEMENTITIOUS MATERIALS SHALL BE AS SET FORTH PER THE N.C.-R
- ONLY APPROVED PLASTICITY AGENTS AND APPROVE AMOUNTS THEREOF MAY BE ADDED TO PORTLAND CEMENT. WHEN PLASTIC CEMENT IS USED, NO ADDITIONAL LIME OR PLASTICIZERS SHALL BE ADDED. HYDRATED LIME OR THE EQUIVALENT AMOUNT OF LIME WATER TO DRAIN TO THE EXTERIOR OF THE BUILDING, OR CEMENT AND LIME PLASTER IN AN AMOUNT NOT TO EXCEED THAT SET FORTH IN ASTM C 926.
- GYPSUM PLASTER SHALL NOT BE USED ON EXTERIOR SURFACES.
- PLASTER COATS SHALL BE PROTECTED FROM FREEZING FOR A PERIOD OF NOT LESS THAN 24 HOURS AFTER SET HAS OCCURRED. PLASTER SHALL BE APPLIED WHEN THE AMBIENT TEMPERATURE IS HIGHER THAN 40 DEGREES F (4 DEGREES C), UNLESS PROVISIONS ARE MADE TO KEEP CEMENT PLASTER WORK ABOVE 40 DEGREES F (4 DEGREES C), PRIOR TO 4 DURING APPLICATION AND 48 HOURS THEREAFTER.
- COLOR AND FINISH TO BE SELECTED AND APPROVED BY OWNER/BUILDER AND ARCHITECT.
- A 1-COAT EXTERIOR PLASTER SYSTEM SUCH AS "MAGNA WALL" (I.C.C. NO. ER-4176), "EXPO FIBERGLASS" (I.C.C. NO. ER-4368), OR APPROVED EQUAL, MAY BE USED IN LIEU OF A 3-COAT EXTERIOR PLASTER SYSTEM.



# NORTH CAROLINA 40' SERIES

KB HOME  
NORTH CAROLINA DIVISION  
4506 S. MIAMI BLVD.  
SUITE 180  
DURHAM, NC 27703  
TEL: (919) 768-7980  
FAX: (919) 544-2928

# 2018 NORTH CAROLINA STATE BUILDING CODES

ISSUE DATE: 06/02/15  
PROJECT No.: 1350999-56  
DIVISION MGR.: MCP  
REVISIONS: 05/07/19

- 1 DIVISION REVISION NC18024NCP - 08/24/18 - CTD
- 2 2018 CODE UPDATE NC19051NCP/ 03/15/19 / CTD
- 3 DIVISION REVISION NC19071NCP- 04/01/19 CTD
- 4 FRAMEWALK REVISIONS NC19033NCP- 05/07/19 - CTD

FOR INTERNAL USE ONLY  
REVISOR BY:  
1 \_\_\_\_\_  
2 \_\_\_\_\_  
3 \_\_\_\_\_  
4 \_\_\_\_\_  
5 \_\_\_\_\_  
6 \_\_\_\_\_

PLAN:  
**240.2596-R**  
SHEET:  
**GN2**

# SPEC. LEVEL 1 RALEIGH-DURHAM 40' SERIES

These designs and drawings are CONFIDENTIAL and the exclusive property of KB Home Corporation and are not to be disclosed without the express permission of KB Home Corporation. They may not be used or duplicated without the express permission of KB Home Corporation. Copyright 2019 © KB Home Corporation. All rights reserved.



# MECHANICAL & PLUMBING

## H.V.A.C.

- ALL MATERIALS AND CONSTRUCTION METHODS SHALL BE IN CONFORMANCE WITH THE NORTH CAROLINA RESIDENTIAL AND MECHANICAL CODE. INSTALLATIONS OF MECHANICAL APPLIANCES, EQUIPMENT AND SYSTEMS NOT ADDRESSED BY THIS CODE SHALL COMPLY WITH THE APPLICABLE PROVISIONS OF THE NORTH CAROLINA RESIDENTIAL AND FUEL GAS CODE.
- CONTRACTOR SHALL DESIGN ENTIRE H.V.A.C. SYSTEM AND SUBMIT DRAWINGS FOR OWNER/BUILDER'S APPROVAL PRIOR TO ORDERING MATERIALS OR EQUIPMENT.
- WHERE AIR CONDITIONING IS AN OPTIONAL FEATURE, HEATING SYSTEMS MUST BE DESIGNED AND DUCT WORK SIZED TO ACCOMMODATE FUTURE AIR CONDITIONING NEEDS.
- WHERE THE PRIMARY HEATING SYSTEM IS A FORCED-AIR FURNACE, AT LEAST ONE THERMOSTAT PER DWELLING UNIT SHALL BE CAPABLE OF CONTROLLING THE HEATING AND COOLING SYSTEM ON A DAILY SCHEDULE TO MAINTAIN DIFFERENT TEMPERATURE SET POINTS AT DIFFERENT TIMES OF THE DAY. THIS THERMOSTAT SHALL HAVE THE CAPABILITY TO SET BACK OR TEMPORARILY OPERATE THE SYSTEM TO MAINTAIN ZONE TEMPERATURES DOWN TO 55 DEG. F (3 C) OR UP TO 65 DEG. F (21 C).
- ALL DUCTWORK SHALL CONFORM TO THE REQUIREMENTS OF THE N.C.-R
- COMBUSTION AIR SHALL BE PROVIDED FOR FORCED AIR UNITS IN ACCORDANCE WITH N.C.-R
- CONTRACTOR TO PROVIDE BOOT IN DUCTWORK WHEN OPTIONAL. "HONEYWELL" OR "CARRIER" ELECTRONIC AIR CLEANER IS PROVIDED.
- DUCTS IN THE GARAGE AND DUCTS PENETRATING THE WALLS OR CEILING SEPARATING THE DWELLING FROM THE GARAGE SHALL BE CONSTRUCTED OF A MINIMUM NO. 26 GAGE SHEET STEEL OR OTHER APPROVED MATERIAL AND SHALL HAVE NO OPENINGS INTO THE GARAGE PER N.C.-R
- EXTERIOR-GRADE INSTALLATIONS. EQUIPMENT AND APPLIANCES INSTALLED ABOVE GRADE LEVEL SHALL BE SUPPORTED ON A SOLID BASE OR APPROVED MATERIAL A MINIMUM OF 2 INCHES THICK.
- UNDER-FLOOR INSTALLATION. SUSPENDED EQUIPMENT SHALL BE A MINIMUM OF 6 INCHES ABOVE THE ADJOINING GRADE.
- CRAWL SPACE SUPPORTS. IN A CRAWL SPACE, A MINIMUM OF 2-INCH THICK SOLID BASE, 2-INCH (51 MM) THICK FORMED CONCRETE, OR STACKED MASONRY UNITS HELD IN PLACE BY MORTAR OR OTHER APPROVED METHOD, THE WATER HEATER SHALL BE SUPPORTED NOT LESS THAN 2 INCHES ABOVE GRADE.
- DRAINAGE. BELOW-GRADE INSTALLATIONS SHALL BE PROVIDED WITH A NATURAL DRAIN OR AN AUTOMATIC LIFT OR PUMP PUMP. FOR PIT REQUIREMENTS REFER TO N.C.-M

## VENTING

- IN LIEU OF REQUIRED EXTERIOR OPENINGS FOR NATURAL VENTILATION IN BATHROOMS CONTAINING A BATHING, SHOWER OR COMBINATION THEREOF, A MECHANICAL VENTILATION SYSTEM MAY BE PROVIDED. THE MINIMUM VENTILATION RATES SHALL BE 50 CFM FOR INTERMITTENT VENTILATION OR 20 CFM FOR CONTINUOUS VENTILATION. VENTILATION AIR FROM THE SPACE SHALL BE EXHAUSTED DIRECTLY TO THE OUTSIDE PER N.C.-R
- EXHAUST DUCTS SHALL TERMINATE OUTSIDE THE BUILDING AND SHALL BE EQUIPPED WITH BACKDRAFT DAMPERS.
- RANGE HOODS SHALL DISCHARGE TO THE OUTDOORS THROUGH A DUCT. THE DUCT SERVING THE HOOD SHALL HAVE A SMOOTH INTERIOR SURFACE. SHALL BE AIR TIGHT, SHALL BE EQUIPPED WITH A BACK-DRAFT DAMPER AND SHALL BE INDEPENDENT OF ALL OTHER EXHAUST SYSTEMS. DUCTS SERVING RANGE HOODS SHALL NOT TERMINATE IN AN ATTIC OR CRAWL SPACE OR AREAS INSIDE THE BUILDING. DUCTS SERVING RANGE HOODS SHALL BE CONSTRUCTED OF GALVANIZED STEEL, STAINLESS STEEL OR COPPER.
- WHERE INSTALLED IN ACCORDANCE WITH THE MANUFACTURER'S INSTALLATION INSTRUCTIONS, AND WHERE MECHANICAL OR NATURAL VENTILATION IS OTHERWISE PROVIDED, LISTED AND LABELED DUCTLESS RANGE HOODS SHALL NOT BE REQUIRED TO DISCHARGE TO THE OUTDOORS PER N.C.-M
- DUCTS FOR DOMESTIC KITCHEN COOKING APPLIANCES EQUIPPED WITH DOWN DRAFT EXHAUST SYSTEMS SHALL BE PERMITTED TO BE CONSTRUCTED OF SCHEDULE 40 PVC PIPE PROVIDED THAT THE INSTALLATION COMPLIES WITH ALL OF THE FOLLOWING PER N.C.-M:
  - THE DUCT SHALL BE INSTALLED UNDER A CONCRETE SLAB FOUNDED ON GRADE.
  - THE UNDER-FLOOR TRENCH IN WHICH THE DUCT IS INSTALLED SHALL BE COMPLETELY BACKFILLED WITH SAND OR GRAVEL.
  - THE PVC DUCT SHALL EXTEND NOT GREATER THAN 1 INCH ABOVE THE INDOOR CONCRETE FLOOR SURFACE.
  - THE PVC DUCT SHALL EXTEND NOT GREATER THAN 1 INCH ABOVE GRADE OUTSIDE THE BUILDING.
  - THE PVC DUCTS SHALL BE SOLVENT CEMENTED.
- EXHAUST HOOD SYSTEMS CAPABLE OF EXHAUSTING IN EXCESS OF 400 CFM SHALL BE PROVIDED WITH MAKEUP AIR AT A RATE APPROXIMATELY EQUAL TO THE EXHAUST AIR RATE THAT IS IN EXCESS OF 400 CUBIC FEET PER MINUTE. SUCH MAKEUP AIR SYSTEMS SHALL BE EQUIPPED WITH A MEANS OF CLOSURE AND SHALL BE AUTOMATICALLY CONTROLLED TO START AND OPERATE SIMULTANEOUSLY WITH THE EXHAUST SYSTEM. DAMPERS SHALL BE ACCESSIBLE FOR INSPECTION, SERVICE, REPAIR AND REPLACEMENT WITHOUT REMOVING PERMANENT CONSTRUCTION
- DOMESTIC WATER HEATERS, UNLESS SPECIFIED OTHERWISE BY THE MANUFACTURER'S INSTALLATION INSTRUCTIONS, SHALL BE VENTED TO THE OUTSIDE AIR BY A TYPE "B" VENT AND COMPLY WITH THE REQUIREMENTS OF THE N.C.-M

## PLUMBING

- A POTABLE WATER SUPPLY SYSTEM SHALL BE DESIGNED, INSTALLED AND MAINTAINED IN SUCH A MANNER SO AS TO PREVENT CONTAMINATION FROM NONPOTABLE LIQUIDS, SOLIDS OR GASES BEING INTRODUCED INTO THE POTABLE WATER SUPPLY THROUGH CROSS-CONNECTIONS OR ANY OTHER PIPING CONNECTIONS TO THE SYSTEM. BACKFLOW PRE-VENTER APPLICATIONS SHALL CONFORM TO N.C.-P.
- THE SUPPLY LINES OR FITTINGS FOR EVERY PLUMBING FIXTURE SHALL BE INSTALLED SO AS TO PREVENT BACKFLOW. PLUMBING FIXTURE FITTINGS SHALL PROVIDE BACKFLOW PROTECTION IN ACCORDANCE WITH ASME A112.18.1.

# MECHANICAL & PLUMBING (continued)

## PLUMBING (continued)

- ALL DEVICES, APPURTENANCES, APPLIANCES AND APPARATUS INTENDED TO SERVE SOME SPECIAL FUNCTION, SUCH AS STERILIZATION, DISTILLATION, PROCESSING, COOLING, OR STORAGE OF ICE OR FOODS, AND THAT CONNECT TO THE WATER SUPPLY SYSTEM, SHALL BE PROVIDED WITH PROTECTION AGAINST BACKFLOW AND CONTAMINATION OF THE WATER SUPPLY SYSTEM. WATER PUMPS, FILTERS, SOFTENERS, TANKS AND ALL OTHER APPLIANCES AND DEVICES THAT HANDLE OR TREAT POTABLE WATER SHALL BE PROTECTED AGAINST CONTAMINATION.
- WATER SERVICE PIPING SHALL BE PROTECTED IN ACCORDANCE WITH N.C.-P SECTIONS AND EXCEPTIONS)
- FIXTURE FITTINGS, FAUCETS AND DIVERTERS SHALL BE CONNECTED TO THE WATER DISTRIBUTION SYSTEM SO THAT HOT WATER CORRESPONDS TO THE LEFT SIDE OF THE FITTINGS.
- DIVERTERS FOR SINK FAUCETS WITH A SECONDARY OUTLET CONSISTING OF A FLEXIBLE HOSE AND SPRAY ASSEMBLY SHALL CONFORM TO ASTM A112.18.1 IN ADDITION TO THE REQUIREMENTS IN N.C.-P
- THE INSTALLATION OF A WATER SERVICE OR WATER DISTRIBUTION PIPE SHALL BE PROHIBITED IN SOIL AND GROUND WATER THAT IS CONTAMINATED. GROUND WATER CONDITIONS SHALL BE REQUIRED TO ASCERTAIN THE ACCEPTABILITY OF THE WATER SERVICE OR WATER DISTRIBUTION PIPING MATERIAL FOR THE SPECIFIC INSTALLATION. WHERE DETRIMENTAL CONDITIONS EXIST, APPROVED ALTERNATIVE MATERIALS OR ROUTING SHALL BE REQUIRED.
- WATER DISTRIBUTION PIPE SHALL CONFORM TO NSF 61 AND SHALL CONFORM TO ONE OF THE STANDARDS LISTED IN N.C.-PLUMBING. ALL WATER DISTRIBUTION PIPE AND TUBING SHALL HAVE A MINIMUM PRESSURE RATING OF 100 PSI AT 180 DEGREES F.
- PIPE PASSING THROUGH CONCRETE OR GINDER WALLS AND FLOORS OR OTHER CORROSIVE MATERIAL SHALL BE PROTECTED AGAINST EXTERNAL CORROSION BY A PROTECTIVE SHEATHING OR WRAPPING OR OTHER MEANS THAT WILL WITHSTAND ANY REACTION FROM THE LIME AND ACID OF CONCRETE, GINDER OR OTHER CORROSIVE MATERIAL. SHEATHING OR WRAPPING SHALL ALLOW FOR EXPANSION AND CONTRACTION OF PIPING TO PREVENT ANY RUBBING ACTION. MINIMUM WALL THICKNESS OF MATERIAL SHALL BE 0.025-INCH.
- PIPES PASSING UNDER OR THROUGH WALLS SHALL BE PROTECTED FROM PHYSICAL DAMAGE PER N.C.-R.
- PIPING SHALL BE INSTALLED SO AS TO PREVENT DETRIMENTAL STRAINS AND STRESSES IN THE PIPE. PROVISIONS SHALL BE MADE TO PROTECT PIPING FROM DAMAGE RESULTING FROM EXPANSION, CONTRACTION AND STRUCTURAL SETTLEMENT. PIPING SHALL BE INSTALLED TO AVOID STRUCTURAL STRESSES OR STRAINS WITHIN BUILDING COMPONENTS.
- WATER PIPES INSTALLED IN A WALL EXPOSED TO THE EXTERIOR SHALL BE LOCATED ON THE HEATED SIDE OF THE WALL INSULATION. IN OTHER CASES, WATER, SOIL AND WASTE PIPES SHALL NOT BE INSTALLED OUTSIDE OF A BUILDING, IN UNCONDITIONED ATTICS, UNCONDITIONED UTILITY ROOMS OR IN ANY OTHER PLACE SUBJECTED TO FREEZING TEMPERATURES UNLESS ADEQUATE PROVISION IS MADE TO PROTECT SUCH PIPES FROM FREEZING BY A MINIMUM OF R-6.5 INSULATION DETERMINED AT 75 DEG. F IN ACCORDANCE WITH ASTM C117 OR HEAT OR BOTH.
- EXTERIOR WATER SUPPLY SYSTEM PIPING SHALL BE INSTALLED NOT LESS THAN 6 INCHES BELOW THE FROST LINE AND NOT LESS THAN 12 INCHES BELOW GRADE.
- BUILDING SEWER PIPE SHALL CONFORM TO ONE OF THE STANDARDS LISTED IN N.C.-R.
- BUILDING SEWER PIPE FITTINGS SHALL BE APPROVED FOR INSTALLATION WITH THE PIPING MATERIAL. INSTALLED AND SHALL CONFORM TO THE RESPECTIVE PIPE STANDARDS OR ONE OF THE STANDARDS LISTED IN N.C.-P.
- WHERE WASTE LINE DROPS OCCUR IN A LOCATION WHERE THE SOUND OF A FLUSHED TOILET MAY BE UNDESIRABLE, SUCH AS IN WALLS OR PARTITIONS ADJACENT TO EATING ROOMS, USE CAST IRON PIPING OR SIMILAR APPROVED HARD OR DENSE PIPING TO MITIGATE SOUND.
- CLEANOUTS ON BUILDING SEWERS SHALL BE LOCATED AS SET FORTH IN N.C.-R.
- THE MAXIMUM WATER CONSUMPTION FLOW RATES AND QUANTITIES FOR ALL PLUMBING FIXTURES SHALL BE IN ACCORDANCE WITH N.C.-R.
- INDIVIDUAL SHOWER AND TUB/SHOWER COMBINATION VALVES SHALL BE EQUIPPED WITH CONTROL VALVES OF THE PRESSURE-BALANCE, THERMOSTATIC-MIXING OR COMBINATION PRESSURE-BALANCE/THERMOSTATIC-MIXING VALVE TYPES WITH A HIGH LIMIT STOP IN ACCORDANCE WITH ASSE 1016/ ASME A112.10.16/CSA B125.16. AND SHALL BE INSTALLED AND ADJUSTED PER MANUFACTURER'S INSTRUCTIONS.
- GAS AND ELECTRIC WATER HEATERS HAVING AN IGNITION SOURCE SHALL BE ELEVATED SUCH THAT THE SOURCE OF IGNITION IS NOT LESS THAN 18 INCHES ABOVE THE GARAGE FLOOR. REFER TO N.C.-R FOR EXCEPTION.
- WATER HEATERS, (USING SOLID, LIQUID OR GAS FUEL) WITH THE EXCEPTION OF THOSE HAVING DIRECT VENT SYSTEMS, SHALL NOT BE INSTALLED IN BATHROOMS AND BEDROOMS OR IN A CLOSET WITH ACCESS ONLY THROUGH A BEDROOM OR BATHROOM. HOWEVER, WATER HEATERS OF THE AUTOMATIC STORAGE TYPE MAY BE INSTALLED AS REPLACEMENT IN A BATHROOM, WHEN APPROVED BY THE PLUMBING OFFICIAL. PROVIDED THEY ARE VENTED AND SUPPLIED WITH ADEQUATE COMBUSTION AIR.
- IN SEISMIC DESIGN CATEGORIES D0, D1 AND D2 AND TOWNHOUSES IN SEISMIC DESIGN CATEGORY C, WATER HEATERS SHALL BE ANCHORED OR STRAPPED IN THE UPPER ONE-THIRD AND IN THE LOWER ONE-THIRD OF THE APPLIANCE TO RESIST A HORIZONTAL FORCE EQUAL TO ONE-THIRD OF THE OPERATING WEIGHT OF THE WATER HEATER, ACTING IN ANY HORIZONTAL DIRECTION, OR IN ACCORDANCE WITH THE APPLIANCE MANUFACTURER'S RECOMMENDATIONS.
- APPLIANCES LOCATED IN A GARAGE OR CARPORT SHALL BE PROTECTED FROM IMPACT BY A MOVING VEHICLE.
- WHERE WATER HEATERS OR HOT WATER STORAGE TANKS ARE INSTALLED IN REMOTE LOCATIONS SUCH AS SUSPENDED CEILING, ATTICS, ABOVE OCCUPIED SPACES, OR UNVENTILATED CRAWL SPACES, A LOCATION WHERE WATER LEAKAGE FROM THE TANK WILL CAUSE DAMAGE TO PRIMARY STRUCTURAL MEMBERS, THE TANK OR WATER HEATER SHALL BE INSTALLED IN A GALVANIZED STEEL PAN HAVING A MINIMUM THICKNESS OF 24 GAGE, OR OTHER PANS APPROVED FOR SUCH USE.
- WHERE CLOTHES WASHING MACHINES ARE LOCATED ON WOOD FRAMED FLOORS WHERE LEAKAGE WOULD CAUSE DAMAGE, A GALVANIZED STEEL PAN HAVING A MINIMUM THICKNESS OF 24 GAGE, OR OTHER PANS APPROVED FOR SUCH USE SHALL BE PROVIDED.

# MECHANICAL & PLUMBING (continued)

## PLUMBING (continued)

- APPLIANCES AND EQUIPMENT USED FOR HEATING WATER OR STORING HOT WATER SHALL BE PROTECTED BY A SEPARATE PRESSURE-RELIEF VALVE AND A SEPARATE TEMPERATURE-RELIEF VALVE OR A COMBINATION PRESSURE-AND-TEMPERATURE RELIEF VALVE. RELIEF VALVES SHALL HAVE A MINIMUM RATED CAPACITY FOR THE EQUIPMENT SERVED AND SHALL CONFORM TO ANSI Z21.22. THE RELIEF VALVE SHALL NOT BE USED AS A MEANS OF CONTROLLING THERMAL EXPANSION.
- THE WATER SUPPLY TO A DISHWASHER SHALL BE PROTECTED AGAINST BACKFLOW BY AN AIR GAP COMPLYING WITH ASME A112.13 OR A112.12 THAT IS INSTALLED INTEGRALLY WITHIN THE MACHINE OR A BACKFLOW PREVENTER IN ACCORDANCE WITH THE NC-R.
- SINK AND DISHWASHER. THE COMBINED DISCHARGE FROM A DISHWASHER AND/AND ONE- OR TWO-COMPARTMENT SINK, WITH OR WITHOUT A FOOD-WASTE DISPOSER, SHALL BE SERVED BY A TRAP OF NOT LESS THAN 1/2 INCHES (38 MM) IN OUTSIDE DIAMETER. THE DISHWASHER DISCHARGE PIPE OR TUBING SHALL RISE TO THE UNDERSIDE OF THE COUNTER AND SHALL BE SECURELY FASTENED TO THE UNDERSIDE OF THE SINK RIM OR COUNTER BEFORE CONNECTING TO THE HEADS OF THE FOOD-WASTE DISPOSER OR TO A WYE FITTING IN THE SINK TAILPIECE.

## FIREPLACES

- FACTORY-BUILT FIREPLACES SHALL BE LISTED AND LABELED AND SHALL BE INSTALLED IN ACCORDANCE WITH THE CONDITIONS OF THE LISTING. FACTORY-BUILT FIREPLACES SHALL BE TESTED IN ACCORDANCE WITH UL 121.
- FIREPLACES ARE TO BE PROVIDED WITH AN EXTERIOR AIR SUPPLY
- ALL MATERIALS AND APPLIANCES, INSTALLATION AND CONSTRUCTION METHODS SHALL COMPLY WITH THE NATIONAL ELECTRICAL CODE OR CURRENT SAE REQUIREMENTS.
- ALL ELECTRICAL SYSTEMS, CIRCUITS, FIXTURES AND EQUIPMENT SHALL BE GROUNDED IN A MANNER COMPLYING WITH ARTICLE 250 OF THE NATIONAL ELECTRICAL CODE.
- ALL WIRING SHALL BE SO INSTALLED THAT, WHEN COMPLETED, THE SYSTEM WILL BE FREE FROM SHORT CIRCUITS AND FROM GROUNDS OTHER THAN AS REQUIRED OR PERMITTED IN N.E.C. ARTICLE 250.
- ELECTRIC EQUIPMENT SHALL BE INSTALLED IN A NEAT AND WORK-MANLIKE MANNER.
- ALL 125-VOLT, SINGLE-PHASE, 15- AND 20-AMPERE RECEPTACLES INSTALLED IN THE LOCATIONS SPECIFIED BELOW SHALL HAVE GROUND-FAULT CIRCUIT-INTERRUPTER PROTECTION FOR PERSONNEL. THE GROUND-FAULT CIRCUIT-INTERRUPTER SHALL BE INSTALLED IN A READILY ACCESSIBLE LOCATION.
  - BATHROOMS.
  - GARAGES AND ALSO ACCESSORY BUILDINGS THAT HAVE A FLOOR LOCATED AT OR BELOW GRADE LEVEL NOT INTENDED AS HABITABLE ROOMS AND LIMITED TO STORAGE AREAS, WORK AREAS, AND AREAS OF SIMILAR USE.
  - OUTDOORS.
  - CRAWL SPACES. WHERE THE CRAWL SPACE IS AT OR BELOW GRADE LEVEL.
  - UNFINISHED PORTIONS OR AREAS OF THE BASEMENT NOT INTENDED AS HABITABLE ROOMS.
  - KITCHENS. WHERE THE RECEPTACLES ARE INSTALLED TO SERVE THE COUNTERTOP SURFACES.
  - SINKS. WHERE RECEPTACLES ARE INSTALLED WITHIN 6 FT FROM THE TOP INSIDE EDGE OF THE BOWL OF THE SINK.
  - BOAT HOUSES.
- BATHTUBS OR SHOWER STALLS - WHERE RECEPTACLES ARE INSTALLED WITHIN 6' OF THE OUTSIDE EDGE OF THE BATHTUB OR SHOWER STALL.
- LAUNDRY AREAS

- DISHWASHER - GFCI PROTECTION IS NOT REQUIRED FOR OUTLETS THAT SUPPLY DISHWASHERS INSTALLED IN DWELLING UNIT LOCATIONS.
- CRAWL SPACE LIGHTING OUTLETS. GFCI PROTECTION SHALL BE PROVIDED FOR LIGHTING OUTLETS NOT EXCEEDING 120 VOLTS INSTALLED IN CRAWL SPACES.
- APPLIANCE RECEPTACLE OUTLETS INSTALLED IN A DWELLING UNIT FOR SPECIFIC APPLIANCES, SUCH AS LAUNDRY EQUIPMENT, SHALL BE INSTALLED WITHIN 6 FEET OF THE INTENDED LOCATION OF THE APPLIANCE.
- IN EVERY KITCHEN, FAMILY ROOM, DINING ROOM, LIVING ROOM, PARLOR, LIBRARY, DEN, SUNROOM, BEDROOM, RECREATION ROOM, OR SIMILAR ROOM OR AREA OF DWELLING UNITS, RECEPTACLE OUTLETS SHALL BE INSTALLED SO THAT NO POINT ALONG THE FLOOR LINE IN ANY WALL SPACE IS MORE THAN 6 FEET, MEASURED HORIZONTALLY, FROM AN OUTLET IN THAT SPACE, INCLUDING ANY WALL SPACE 2 FEET OR MORE IN WIDTH (INCLUDING SPACE MEASURED AROUND CORNERS) AND UNBROKEN ALONG THE FLOOR LINE BY DOORWAYS AND SIMILAR OPENINGS, FIREPLACES, AND FIXED CABINETS, AND THE WALL SPACE OCCUPIED BY FIXED PANELS IN EXTERIOR WALLS, BUT EXCLUDING SLIDING PANELS IN EXTERIOR WALLS. THE WALL SPACE AFFORDED BY FIXED ROOM DIVIDERS, SUCH AS FREESTANDING BAR-TYPE COUNTERS OR RAILINGS, SHALL BE INCLUDED IN THE 6 FOOT MEASUREMENT.

- IN THE KITCHEN, PANTRY, BREAKFAST ROOM, DINING ROOM, OR SIMILAR AREA OF A DWELLING UNIT, THE TWO OR MORE 20-AMPERE SMALL-APPLIANCE BRANCH CIRCUITS REQUIRED SHALL SERVE ALL WALL- AND FLOOR-RECEPTACLE OUTLETS, ALL COUNTERTOP OUTLETS, AND RECEPTACLE OUTLETS FOR REFRIGERATION EQUIPMENT. THE TWO OR MORE SMALL-APPLIANCE BRANCH CIRCUITS SHALL HAVE NO OTHER OUTLETS.
- IN KITCHENS, PANTRIES, BREAKFAST ROOMS, DINING ROOMS AND SIMILAR AREAS OF DWELLING UNITS, RECEPTACLE OUTLETS FOR COUNTER SPACES SHALL BE INSTALLED IN ACCORDANCE WITH THE FOLLOWING:
  - A RECEPTACLE OUTLET SHALL BE INSTALLED AT EACH WALL COUNTER SPACE 12 INCHES OR WIDER. RECEPTACLE OUTLETS SHALL BE INSTALLED SO THAT NO POINT ALONG THE WALL LINE IS MORE THAN 12 INCHES MEASURED HORIZONTALLY FROM A RECEPTACLE OUTLET IN THAT SPACE.

# ELECTRICAL (continued)

- AT LEAST ONE RECEPTACLE OUTLET SHALL BE INSTALLED AT EACH ISLAND COUNTER SPACE WITH A LONG DIMENSION OF 24 INCHES OR GREATER AND A SHORT DIMENSION OF 12 INCHES OR GREATER.
- AT LEAST ONE RECEPTACLE OUTLET SHALL BE INSTALLED AT EACH PENINSULAR COUNTER SPACE WITH A LONG DIMENSION OF 24 INCHES OR GREATER AND A SHORT DIMENSION OF 12 INCHES OR GREATER. A PENINSULAR COUNTERTOP IS MEASURED FROM CONNECTING PERPENDICULAR WALL.
- COUNTERTOP SPACES SEPARATED BY RANGE TOPS, REFRIGERATORS, OR SINKS SHALL BE CONSIDERED AS SEPARATE COUNTERTOP SPACES IN APPLYING THE REQUIREMENTS OF (1), (2), AND (3) ABOVE. IF A RANGE, COUNTER-MOUNTED COOKING UNIT, OR SINK IS INSTALLED IN AN ISLAND OR PENINSULAR COUNTERTOP AND THE DEPTH OF THE COUNTER BEHIND THE ITEM IS LESS THAN 12 INCHES, IT WILL BE CONSIDERED TO DIVIDE THE COUNTERTOP SPACE INTO TWO SEPARATE COUNTERTOP SPACES. EACH COUNTERTOP SPACE SHALL COMPLY WITH APPLICABLE REQUIREMENTS.
- RECEPTACLE OUTLETS SHALL BE LOCATED NOT MORE THAN 20 INCHES ABOVE THE COUNTERTOP. RECEPTACLE OUTLETS RENDERED NOT READILY ACCESSIBLE BY APPLIANCES FASTENED IN PLACE, APPLIANCE GARAGES, SINKS, OR RANGETOPS AS COVERED IN 4) ABOVE, OR APPLIANCES OCCUPYING DEDICATED SPACE SHALL NOT BE CONSIDERED AS THESE REQUIRED OUTLETS.
- AT LEAST ONE WALL RECEPTACLE OUTLET SHALL BE INSTALLED IN BATHROOMS WITHIN 3 FEET OF THE OUTSIDE EDGE OF EACH BASIN. THE RECEPTACLE OUTLET SHALL BE LOCATED IN WALL OR PARTITION THAT IS ADJACENT TO THE BASIN OR BASIN COUNTERTOP, OR INSTALLED ON THE SIDE OR FACE OF THE BASIN CABINET NOT MORE THAN 12" BELOW THE COUNTERTOP.
- IN DWELLINGS UNITS, AT LEAST ONE RECEPTACLE OUTLET SHALL BE INSTALLED IN AREAS DESIGNATED FOR THE INSTALLATION OF LAUNDRY EQUIPMENT.
- IN EACH ATTACHED GARAGE AND IN EACH DETACHED GARAGE WITH ELECTRIC POWER, THE BRANCH CIRCUIT SUPPLYING THIS RECEPTACLE(S) SHALL NOT SUPPLY OUTLETS OUTSIDE OF THE GARAGE. AT LEAST ONE RECEPTACLE OUTLET SHALL BE INSTALLED IN EACH VEHICLE BAY.
- CABLE-OR RACEWAY-TYPE WIRING METHODS INSTALLED IN A GROOVE, TO BE COVERED BY WALLBOARD, SIDING, PANELING, CARPETING, OR SIMILAR MATERIAL SHALL BE PROTECTED BY 1/8 INCH THICK STEEL PLATE, SLEEVE, OR EQUIVALENT OR BY NOT LESS THAN 1/4 INCH FREE SPACE FOR THE FULL LENGTH OF THE GROOVE IN WHICH THE CABLE OR RACEWAY IS INSTALLED.
- RECEPTACLES IN DAMP OR WET LOCATIONS.
  - A RECEPTACLE INSTALLED OUTDOORS IN A LOCATION PROTECTED FROM WEATHER OR IN OTHER DAMP LOCATIONS SHALL HAVE AN ENCLOSURE FOR THE RECEPTACLE THAT IS WEATHERPROOF WHEN THE RECEPTACLE IS COVERED. (ATTACHMENT PLUG CAP NOT INSERTED AND RECEPTACLE COVERS CLOSED.)
  - ALL 15- AND 20- AMPERE, 125- AND 250-VOLT RECEPTACLES INSTALLED IN A WET LOCATION SHALL HAVE AN ENCLOSURE THAT IS WEATHER PROOF WHETHER OR NOT THE ATTACHMENT PLUG CAP IS INSERTED. A BOX HOOK SHALL BE INSTALLED IN THE ENCLOSURE. SHALL BE LISTED AND SHALL BE IDENTIFIED AS "EXTRA DUTY". ALL 15- AND 20- AMPERE, 125- AND 250-VOLT NONLOCKING RECEPTACLES SHALL BE LISTED WEATHER RESISTANT TYPE.
- LIGHTING EQUIPMENT. NOT LESS THAN 75 PERCENT OF THE PERMANENTLY INSTALLED LIGHTING FIXTURES SHALL CONTAIN ONLY HIGH-EFFICACY LAMPS.
- LIGHT FIXTURES WITHIN CLOTHES CLOSETS SHALL BE INSTALLED IN ACCORDANCE WITH N.E.C.
- ALL 120-VOLT, SINGLE PHASE, 15- AND 20-AMPERE BRANCH CIRCUITS SUPPLYING OUTLETS OR DEVICES INSTALLED IN DWELLING UNIT FAMILY ROOMS, DINING ROOMS, LIVING ROOMS, PARLORS, LIBRARIES, DENS, BEDROOMS, SUNROOMS, RECREATION ROOMS, CLOSETS, HALLWAYS, OR SIMILAR ROOMS OR AREAS SHALL BE PROTECTED BY AN ARC-FAULT CIRCUIT INTERRUPTER (AFCI). COMBINATION-TYPE, INSTALLED TO PROVIDE PROTECTION OF THE BRANCH CIRCUIT, THE ARC-FAULT CIRCUIT INTERRUPTER SHALL BE INSTALLED IN A READILY ACCESSIBLE LOCATION.
- BUILDINGS SHALL BE PROVIDED WITH APPROVED ADDRESS IDENTIFICATION. THE ADDRESS IDENTIFICATION SHALL BE LEGIBLE AND IDENTIFIED IN A POSITION THAT IS VISIBLE FROM THE STREET OR ROAD FRONTING THE PROPERTY.
- TAMPER-RESISTANT RECEPTACLES IN DWELLING UNITS IN ALL AREAS. ALL NON-LOCKING TYPE 125-VOLT 15-AND 20-AMPERE RECEPTACLES SHALL BE LISTED TAMPER-RESISTANT RECEPTACLES. EXCEPTIONS LISTED BELOW:
  - RECEPTACLES LOCATED MORE THAN 5 1/2' ABOVE THE FLOOR.
  - RECEPTACLES THAT ARE PART OF A LUMINAIRE OR APPLIANCE.
  - A SINGLE RECEPTACLE OR A DUPLEX RECEPTACLE FOR TWO APPLIANCES LOCATED WITHIN DEDICATED SPACE FOR EACH APPLIANCE THAT, IN NORMAL USE, IS NOT EASILY MOVED FROM ONE PLACE TO ANOTHER, AND THAT IS CORD-AND-PLUG CONNECTED.
  - NON-GROUNDING RECEPTACLES USED FOR REPLACEMENTS.
- DIMMER-CONTROLLED RECEPTACLES. A RECEPTACLE SUPPLYING LIGHTING LOADS SHALL NOT BE CONNECTED TO A DIMMER UNLESS THE TYPE/TYPE/COMBINATION IS A NONSTANDARD CONFIGURATION LISTED THAT IS SPECIFICALLY LISTED AND IDENTIFIED FOR EACH SUCH UNIQUE COMBINATION.
- SMOKE DETECTORS
  - SMOKE DETECTORS SHALL BE INSTALLED IN ACCORDANCE WITH THE APPROVED MANUFACTURER'S INSTRUCTIONS AND NC-R R314
  - ALL SMOKE ALARMS SHALL BE LISTED IN ACCORDANCE WITH UL 217 AND INSTALLED IN ACCORDANCE WITH THE PROVISIONS OF THIS CODE AND THE HOUSEHOLD FIRE WARNING EQUIPMENT PROVISIONS OF NFPA 72. HOUSEHOLD FIRE ALARM SYSTEMS INSTALLED IN ACCORDANCE WITH NFPA 72 THAT INCLUDE SMOKE ALARMS, OR A COMBINATION OF SMOKE DETECTOR AND AUDIBLE NOTIFICATION DEVICE INSTALLED AS REQUIRED BY THE NC-R R314.3 FOR SMOKE ALARMS, SHALL BE PERMITTED. THE HOUSEHOLD FIRE ALARM SYSTEM SHALL PROVIDE THE SAME LEVEL OF SMOKE DETECTION AND ALARM AS REQUIRED BY THE NC-R FOR SMOKE ALARMS. IN THE EVENT THE FIRE ALARM PANEL IS REMOVED OR THE SYSTEM IS NOT CONNECTED TO A CENTRAL STATION.
  - REQUIRED SMOKE DETECTORS SHALL BE LOCATED IN ACCORDANCE WITH THE NC-R R314.3

# ELECTRICAL (continued)

## CARBON MONOXIDE ALARMS

- CARBON MONOXIDE ALARMS IN DWELLING UNITS SHALL BE INSTALLED OUTSIDE OF EACH SEPARATE SLEEPING AREA IN THE IMMEDIATE VICINITY OF THE BEDROOMS. WHERE A FUEL-BURNING APPLIANCE IS LOCATED WITHIN A BEDROOM OR ITS ATTACHED BATHROOM, A CARBON MONOXIDE ALARM SHALL BE INSTALLED WITHIN THE BEDROOM.
- SINGLE STATION CARBON MONOXIDE ALARMS SHALL BE LISTED AS COMPLYING WITH UL 2084 AND SHALL BE INSTALLED IN ACCORDANCE WITH THE NC-R R315 AND THE MANUFACTURER'S INSTALLATION INSTRUCTIONS.
- COMBINATION CARBON MONOXIDE AND SMOKE ALARMS SHALL BE PERMITTED TO BE USED IN LIEU OF INDIVIDUAL CARBON MONOXIDE OR SMOKE ALARMS.

## DRYER VENT

- THE DRYER DUCT IS REQUIRED TO IDENTIFY THE LENGTH IN ACCORDANCE WITH SECTION M1502.4.5



## NORTH CAROLINA 40' SERIES

KB HOME  
NORTH CAROLINA DIVISION  
4506 S. MIAMI BLVD.  
SUITE 180  
DURHAM, NC 27703  
TEL: (919) 768-7980  
FAX: (919) 544-2928

## 2018 NORTH CAROLINA STATE BUILDING CODES

ISSUE DATE: 06/02/15  
PROJECT No.: 1350999:56  
DIVISION MGR.: MCP  
REVISIONS: 05/07/19

- 1 DIVISION REVISIONS NC18024NCP - 08/24/18 - CTD
- 2 2018 CODE UPDATE NC19051NCP/ 03/15/19 / CTD
- 3 DIVISION REVISION NC19071NCP- 04/01/19 CTD
- 4 FRAMEWORK REVISIONS NC19033NCP- 05/07/19 - CTD

FOR INTERNAL USE ONLY	
REVISION BY:	
1	
2	
3	
4	

PLAN:  
**240.2596-R**  
SHEET:  
**GN3**

## SPEC. LEVEL 1 RALEIGH-DURHAM 40' SERIES

These designs and drawings are CONFIDENTIAL and the exclusive property of KB Home Corporation, and are not to be disclosed without the express permission of KB Home Corporation. They may not be used or duplicated without the express permission of KB Home Corporation. Copyright 2019 © KB Home Corporation. All rights reserved.





INTERIOR KEY

SQUARE FOOTAGE		
PLAN 240.2596-R		
FIRST FLOOR AREA	1158	SQ. FT.
SECOND FLOOR AREA	1415	SQ. FT.
TOTAL AREA	2573	SQ. FT.
GARAGE AREA		
PORCH AREA(S)		
PATIO AREA(S)		
DECK AREA(S)		
SUNROOM AREA		
PLATE NOTES		
8'-1" PLATE NOTES		
9'-1" PLATE NOTES		
STAIR DATA NOTES		
GENERAL PLAN NOTES		

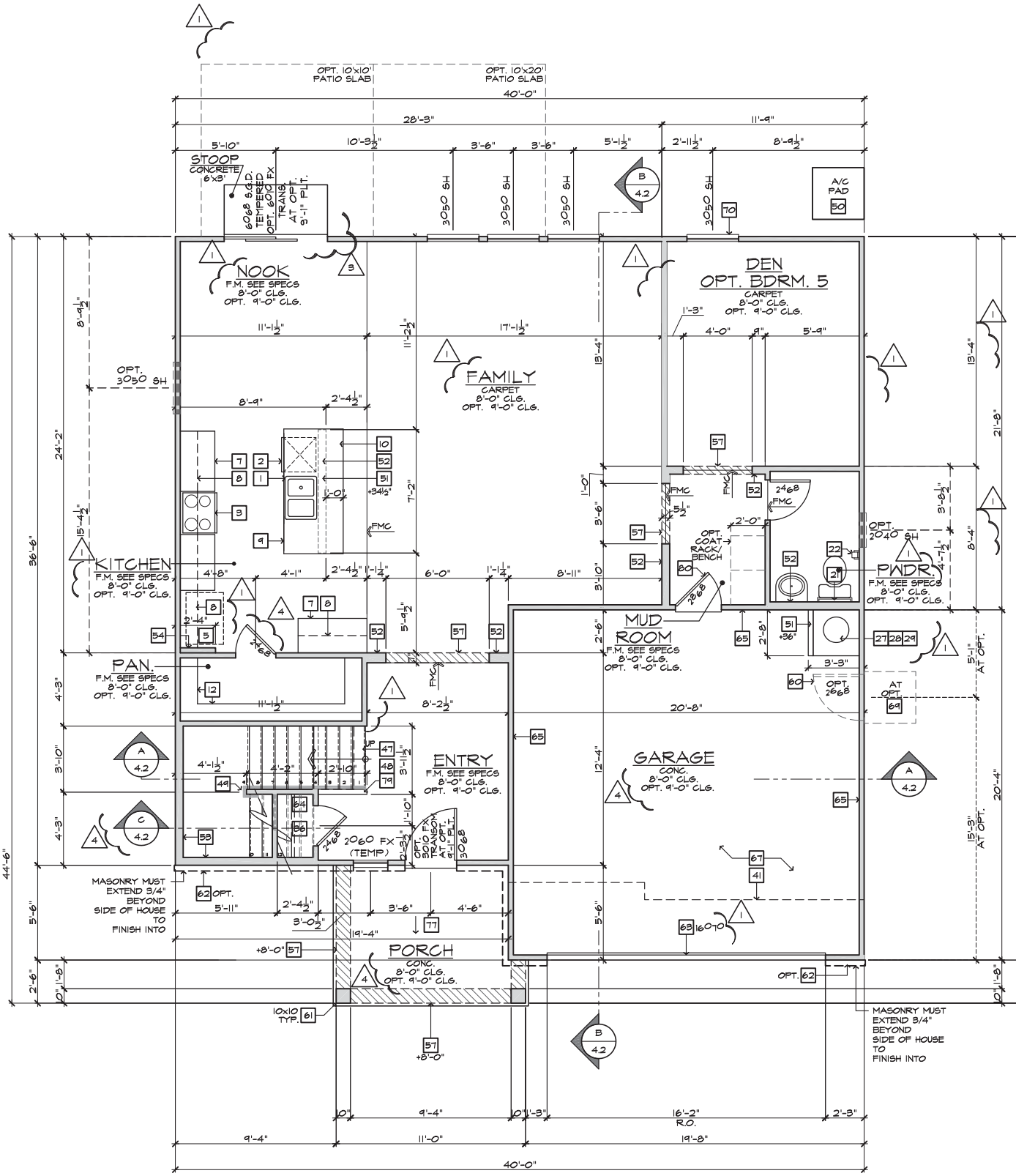

FIRST FLOOR PLAN 'A'  
SCALE 1/4"=1'-0" (22"X34") - 1/8"=1'-0" (11"X17")  
BASIC PLAN

- FLOOR PLAN NOTES**
- NOTE: NOT ALL KEY NOTES APPLY.
- SINK - GARBAGE DISPOSAL OPTIONAL - VERIFY DIMENSIONS WITH MANUFACTURERS SPECS
  - DISHWASHER - PROVIDE AIR GAP - VERIFY SPACINGS & DIMENSIONS PER MANUFACTURERS' SPECS
  - SLIDE-IN RANGE/OVEN COMBINATION W/ BUILT-IN NON-VENTED HOOD W/LIGHT & FAN - VERIFY WITH MANUFACTURERS' SPECS
  - 30" COOKTOP W/ BUILT-IN VENTED HOOD W/ LIGHT & FAN - VERIFY WITH MANUF'S SPECS
  - 34" CLEAR REFRIGERATOR SPACE W/ OPTIONAL CABINETS ABOVE - OPT. PLUMBING FOR ICEMAKER (RECESSED IN WALL)
  - COMBINATION DOUBLE OVEN OR OVEN/MICROWAVE OVEN OR OVEN - VERIFY DIMENSIONS WITH MANUFACTURERS' SPECS
  - BASE CABINETS - REFER TO INTERIOR ELEVATIONS
  - UPPER CABINETS - REFER TO INTERIOR ELEVATIONS
  - ISLAND CABINET - REFER TO INTERIOR ELEVATIONS
  - MIN. 12" BAR TOP/ BREAKFAST BAR
  - DESK AREA - REFER TO INTERIOR ELEVATIONS
  - BUILT-IN PANTRY (15" DEEP OR U.O.)
  - SINK CABINET(S) - REFER TO INTERIOR ELEVATIONS
  - SINK CABINET W/ EXTENDED VANITY & KNEE SPACE BELOW - REFER TO INTERIOR ELEVATIONS
  - OPT. SINK - REFER TO INTERIOR ELEVATIONS.
  - KNEE SPACE - REFER TO INTERIOR ELEVATIONS
  - PRE-FAB. TUB/SHOWER COMBO W/ FIBERGLASS MAINSCOT TO T2 - VERIFY DIMENSIONS W/ MANUF'S SPECS
  - OVAL TUB - VERIFY DIMENSIONS WITH MANUF'S SPECS.
  - PRE-FAB. SHOWER PAN W/ 30" MIN. CLR. INSIDE & MAINSCOT TO T2 - VERIFY DIMENSIONS W/ MANUF'S SPECS
  - SHATTERPROOF (TEMPERED) GLASS SHOWER ENCLOSURE.
  - TOWEL BAR - PROVIDE 2x SOLID BLK'S IN WALL
  - TOILET PAPER HOLDER - PROVIDE 2x SOLID BLK'S IN WALL
  - RECESSED, MIRRORED MEDICINE CABINET
  - WASHER & DRYER - PROVIDE WATER & WASTE FOR WASHER - RECESS WASHER CONTROL VALVES IN WALL - VENT DRYER TO OUTSIDE AIR - PROVIDE "SMITTY PAN" W/ DRAIN BELOW WASHER AT 2ND FLOOR LAUNDRY LOCATION ACCOMMODATE APPLIANCES TO BE LOCATED WASHER AT LEFT AND DRYER AT RIGHT.
  - 12" SHELF PER SPECS
  - OPT. LAUNDRY SINK - REFER TO INTERIOR ELEV'S
  - WATER HEATER LOCATION - FOR GAS - LOCATE ON 10" HIGH PLATFORM - FOR INTERIOR LOCATION - PROVIDE PAN & DRAIN. (REFER TO DETAILS)
  - WATER HEATER 'B' VENT TO OUTSIDE AIR
  - MAIN LINE SHUT-OFF VALVE AND TEMP. & PRESSURE RELIEF VALVE
  - FAUJ. LOCATION (REFER TO DETAIL SHEETS)
  - FAUJ. 'B' VENT TO OUTSIDE AIR
  - LISTED FACTORY-BUILT GAS FIRED DEC. APPLIANCE (REF. 80/AD4) - INSTALL PER MFR. SPECS
  - HEARTH TO BE INSTALLED PER FACTORY-BUILT FIREPLACE LISTING
  - GAS APPLIANCE 'B' VENT FROM BELOW
  - LINEN PER SPECS (15" DEEP OR U.O.)
  - COAT CLOSET W/ SHELF & POLE (REFER TO DETAIL SHEETS)
  - WARDROBE W/ SHELF & POLE (REFER TO DETAIL SHEETS)
  - 22"x30" MIN. ATTIC ACCESS (REFER TO DETAIL SHEETS) W/ 25"x54" PULL DOWN LADDER R.O. ATTIC ACCESS TO BE PROTECTED
  - LINE OF WALL BELOW
  - DUCT CHASE
  - LINE OF FLOOR ABOVE
  - LINE OF FLOOR BELOW
  - LINE OF OPTIONAL TRAY CEILING (REFER TO DETAIL SHEETS)
  - LINE OF HIP AT OPTIONAL VOLUME CEILING
  - LINE OF RIDGE AT OPTIONAL VOLUME CEILING
  - CEILING BREAK
  - STAIR TREADS & RISERS - MIN. 10" TREAD & MAX. 7 3/4" RISER - (REFER TO DETAIL SHEETS)
  - MIN. 36" HIGH GUARDRAIL (REFER TO DETAIL SHEETS)
  - 34" TO 38" HIGH HANDRAIL (REFER TO DETAIL SHEETS)
  - A/C PAD LOCATION
  - LOW WALL - REFER TO PLAN FOR HEIGHT
  - 2x6 STUD WALL
  - 2x6 BALLOON FRAMED WALL PER STRUCTURAL
  - DBL. 2x4 WALL PER PLAN
  - INTERIOR SHELF-SEE PLAN FOR HT. (REFER TO DETAIL SHEETS)
  - MEDIA NICHE
  - FLAT SOFFIT - REFER TO PLATE NOTES / ELEV. FOR H&T.
  - ARCHED SOFFIT - REFER TO PLATE NOTES / ELEV. FOR H&T.
  - WINDOW SEAT
  - OPT. DOOR/ WINDOW
  - PRE-MANUFACTURED DECORATIVE COLUMN (SIZE, SEE ELEV.) PLYON OR EQ. SURROUNDING STRUCTURAL POST.
  - BRICK / STONE VENEER - REFER TO ELEVATIONS VENEER TO COMPLY WITH THE N.G.-R.
  - SECTIONAL GARAGE DOOR PER SPECS
  - MIN. 1/2" GYP. BD. ON CEILING & WALLS @ USEABLE SPACE UNDER STAIR.
  - GARAGE SHALL BE SEPARATED FROM THE RESIDENCE AND ITS ATTIC AREA BY NOT LESS THAN 1/2" GYP. BD. @ GARAGE SIDE WALLS & 5/8" UNDER 'LIVING AREA U.O.
  - 3" DIAM. CONCRETE FILLED PIPE BOLLARD 36" HIGH WITH MIN. 12" EMBEDED INTO CONCRETE (NOT REQUIRED AT ELECTRIC WATER HEATERS OR FOR APPLIANCES LOCATED OUT OF THE VEHICLE'S NORMAL TRAVEL PATH).
  - 5/8" TYPE-X GYP. IN GARAGE BETWEEN CEILING & FLOOR ABV.
  - P.T. POST W/ VINYL WRAP
  - CONCRETE STPOOP, 36"x36" STANDARD SLOPE 1/4" PER FT. MIN.
  - EGRESS WINDOW
  - PROVIDE ADDITIONAL RISER(S) AT OPTIONAL PLATE HT.
  - MDP TOP
  - PLUMBING DROP FROM ABOVE
  - ADJUST OPENING AT OPTION TO FIT THE DOOR SIZE SHOWN
  - WINDOW LEDGE HEIGHT & WIDTH OF OPENING TO EXTEND 6" BEYOND WINDOW(S) ON ALL SIDES U.O.
  - SITE-BUILT COLUMN - SEE ELEVATION FOR TYPE
  - CONCRETE SLAB. SLOPE 1/4" PER FT. MIN. SEE PLAN FOR SIZE.
  - LOUVERED DOOR
  - SLOPING LOW WALL 36" ABOVE ADJACENT TREADS
  - 20 MIN. FIRE-RATED DOOR



**NORTH CAROLINA 40' SERIES**  
KB HOME  
NORTH CAROLINA DIVISION  
4506 S. MIAMI BLVD.  
SUITE 180  
DURHAM, NC 27703  
TEL: (919) 768-7980  
FAX: (919) 544-2928

**2018 NORTH CAROLINA STATE BUILDING CODES**

ISSUE DATE: 06/02/15  
PROJECT No.: 1350999:56  
DIVISION MGR.: MCP  
REVISIONS: 05/07/19

- 1 DIVISION REVISIONS - NC1804NCP - 08/24/18 - CTD
- 2 2018 CODE UPDATE - NC1905NCP/ 03/15/19 / CTD
- 3 DIVISION REVISION - NC1907NCP - 04/01/19 CTD
- 4 FRAMEWALK REVISIONS - NC1903NCP - 05/07/19 - CTD

FOR INTERNAL USE ONLY	
REVISION BY:	
1	
2	
3	
4	

PLAN:  
**240.2596-R**  
SHEET:  
**1.1**

**SPEC. LEVEL 1**  
**RALEIGH-DURHAM 40' SERIES**

These designs and drawings are CONFIDENTIAL and the exclusive property of KB Home Corporation and are not to be disclosed without the express permission of KB Home Corporation. Copyright 2019 © KB Home Corporation. All rights reserved.





**NORTH CAROLINA  
40' SERIES**

KB HOME  
NORTH CAROLINA DIVISION  
4506 S. MIAMI BLVD.  
SUITE 180  
DURHAM, NC 27703  
TEL: (919) 768-7980  
FAX: (919) 544-2928

**2018 NORTH  
CAROLINA STATE  
BUILDING  
CODES**

ISSUE DATE: 06/02/15  
PROJECT No.: 1350999:56  
DIVISION MGR.: MCP  
REVISIONS: 05/07/19

- 1 DIVISION REVISIONS - NCI824NCP - 08/24/18 - CTD
- 2 2018 CODE UPDATE - NCI915NCP/ 03/15/19 / CTD
- 3 DIVISION REVISION - NCI907NCP - 04/01/19 CTD
- 4 FRAMEWALK REVISIONS - NCI933NCP - 05/07/19 - CTD

FOR INTERNAL USE ONLY	
REVISION BY:	
1	
2	
3	
4	

PLAN:  
**240.2596-R**  
SHEET:  
**1.2**

**SPEC. LEVEL 1  
RALEIGH-DURHAM  
40' SERIES**

**FLOOR PLAN NOTES**

- NOTE: NOT ALL KEY NOTES APPLY.**
- SINK - GARBAGE DISPOSAL OPTIONAL - VERIFY DIMENSIONS WITH MANUFACTURERS SPECS
  - DISHWASHER - PROVIDE AIR GAP - VERIFY SPACING & DIMENSIONS PER MANUFACTURERS SPECS
  - SLIDE-IN RANGE/OVEN COMBINATION W/ BUILT-IN NON-VENTED HOOD W/LIGHT & FAN - VERIFY WITH MANUFACTURERS SPECS
  - 30" COOKTOP W/ BUILT-IN VENTED HOOD W/ LIGHT & FAN - VERIFY WITH MANUFERS SPECS
  - 34" CLEAR REFRIGERATOR SPACE W/ OPTIONAL CABINETS ABOVE - OPT. PLUMBING FOR ICEMAKER (RECESSED IN WALL)
  - COMBINATION DOUBLE OVEN OR OVEN/MICROWAVE OVEN OR OVEN - VERIFY DIMENSIONS WITH MANUFACTURERS SPECS
  - BASE CABINETS - REFER TO INTERIOR ELEVATIONS
  - UPPER CABINETS - REFER TO INTERIOR ELEVATIONS
  - ISLAND CABINET - REFER TO INTERIOR ELEVATIONS
  - MIN. 12" BAR TOP/ BREAKFAST BAR
  - DESK AREA - REFER TO INTERIOR ELEVATIONS
  - BUILT-IN PANTRY (15" DEEP OR U.N.O.)
  - SINK CABINET(S) - REFER TO INTERIOR ELEVATIONS
  - SINK CABINET W/ EXTENDED VANITY & KNEE SPACE BELOW - REFER TO INTERIOR ELEVATIONS
  - OPT. SINK - REFER TO INTERIOR ELEVATIONS.
  - KNEE SPACE - REFER TO INTERIOR ELEVATIONS
  - PRE-FAB. TUB/SHOWER COMBO W/ FIBERGLASS WAINSCOT TO T2 - VERIFY DIMENSIONS W/ MANUFERS SPECS
  - OVAL TUB - VERIFY DIMENSIONS WITH MANUFERS SPECS.
  - PRE-FAB. SHOWER PAN W/ 30" MIN. CLR. INSIDE & WAINSCOT TO T2 - VERIFY DIMENSIONS W/ MANUFERS SPECS
  - SHATTERPROOF (TEMPERED) GLASS SHOWER ENCLOSURE.
  - TOWEL BAR - PROVIDE 2x SOLID BLK'S IN WALL
  - TOILET PAPER HOLDER - PROVIDE 2x SOLID BLK'S IN WALL
  - RECESSED, MIRRORED MEDICINE CABINET
  - WASHER & DRYER - PROVIDE WATER & WASTE FOR WASHER - RECESS WASHER CONTROL VALVES IN WALL - VENT DRYER TO OUTSIDE AIR - PROVIDE "SMITTY PAN" W/ DRAIN BELOW WASHER AT 2ND DOOR LOCATION
  - ACCOMMODATE APPLIANCES TO BE LOCATED WASHER AT LEFT AND DRYER AT RIGHT.
  - 12" SHELF PER SPECS
  - OPT. LAUNDRY SINK - REFER TO INTERIOR ELEV'S
  - WATER HEATER LOCATION - FOR GAS - LOCATE ON 10' HIGH PLATFORM - FOR INTERIOR LOCATION - PROVIDE PAN & DRAIN. (REFER TO DETAILS)
  - WATER HEATER 'B' VENT TO OUTSIDE AIR
  - MAIN LINE SHUT-OFF VALVE AND TEMP. & PRESSURE RELIEF VALVE
  - FAUJ. LOCATION (REFER TO DETAIL SHEETS)
  - FAUJ. 'B' VENT TO OUTSIDE AIR
  - LISTED FACTORY-BUILT GAS FIRED DEC. APPLIANCE (REF. 80/AD4) - INSTALL PER MFR. SPECS
  - HEARTH TO BE INSTALLED PER FACTORY-BUILT FIREPLACE LISTING
  - GAS APPLIANCE 'B' VENT FROM BELOW
  - LINEN PER SPECS (15" DEEP OR U.N.O.)
  - COAT CLOSET W/ SHELF & POLE (REFER TO DETAIL SHEETS)
  - WARDROBE W/ SHELF & POLE (REFER TO DETAIL SHEETS)
  - 22"x30" MIN. ATTIC ACCESS (REFER TO DETAIL SHEETS) W/ 25"x54" FULL DOWN LADDER R.O. ATTIC ACCESS TO BE PROTECTED
  - LINE OF WALL BELOW
  - DUCT CHASE
  - LINE OF FLOOR ABOVE
  - LINE OF FLOOR BELOW
  - LINE OF OPTIONAL TRAY CEILING (REFER TO DETAIL SHEETS)
  - LINE OF HIP AT OPTIONAL VOLUME CEILING
  - LINE OF RIDGE AT OPTIONAL VOLUME CEILING
  - CEILING BREAK
  - STAIR TREADS & RISERS: - MIN. 10" TREAD & MAX. 7 3/4" RISER - (REFER TO DETAIL SHEETS)
  - MIN. 36" HIGH GUARDRAIL (REFER TO DETAIL SHEETS)
  - 34" TO 38" HIGH HANDRAIL (REFER TO DETAIL SHEETS)
  - A/C PAD LOCATION
  - LOW WALL - REFER TO PLAN FOR HEIGHT
  - 2x6 STUD WALL
  - 2x6 BALLOON FRAMED WALL PER STRUCTURAL
  - DBL. 2x4 WALL PER PLAN
  - INTERIOR SHELF-SEE PLAN FOR HT. (REFER TO DETAIL SHEETS)
  - MEDIA NICHE
  - FLAT SOFFIT - REFER TO PLATE NOTES / ELEV. FOR H&T.
  - ARCHED SOFFIT - REFER TO PLATE NOTES / ELEV. FOR H&T.
  - WINDOW SEAT
  - OPT. DOOR/ WINDOW
  - PRE-MANUFACTURED DECORATIVE COLUMN (SIZE, SEE ELEV.) PYPON OR EQ. SURROUNDING STRUCTURAL POST.
  - BRICK / STONE VENEER - REFER TO ELEVATIONS VENEER TO COMPLY WITH THE N.G.-R.
  - SECTIONAL GARAGE DOOR PER SPECS
  - MIN. 1/2" GYP. BD. ON CEILING & WALLS @ USEABLE SPACE UNDER STAIR.
  - GARAGE SHALL BE SEPARATED FROM THE RESIDENCE AND ITS ATTIC AREA BY NOT LESS THAN 1/2" GYP. BD. @ GARAGE SIDE WALLS & 5/8" UNDER 'LIVING AREA U.N.O.
  - 3" DIAM. CONCRETE FILLED PIPE BOLLARD 36" HIGH WITH MIN. 12" EMBEDMENT INTO CONCRETE (NOT REQUIRED AT ELECTRIC WATER HEATERS OR FOR APPLIANCES LOCATED OUT OF THE VEHICLE'S NORMAL TRAVEL PATH).
  - 5/8" TYPE-X GYP. IN GARAGE BETWEEN CEILING & FLOOR ABV.
  - P.T. POST W/ VINYL WRAP
  - CONCRETE STPOOF, 36"x36" STANDARD SLOPE 1/4" PER FT. MIN.
  - EGRESS WINDOW
  - PROVIDE ADDITIONAL RISER(S) AT OPTIONAL PLATE HT.
  - MDP TOP
  - PLUMBING DROP FROM ABOVE
  - ADJUST OPENINGS AT OPTION TO FIT THE DOOR SIZE SHOWN
  - WINDOW LEDGE HEIGHT & WIDTH OF OPENING TO EXTEND 6" BEYOND WINDOW(S) ON ALL SIDES U.N.O.
  - SITE-BUILT COLUMN - SEE ELEVATION FOR TYPE
  - CONCRETE SLAB. SLOPE 1/4" PER FT. MIN. SEE PLAN FOR SIZE.
  - LOUVERED DOOR
  - SLOPING LOW WALL 38" ABOVE ADJACENT TREADS
  - 20 MIN. FIRE-RATED DOOR

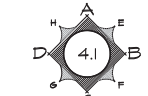
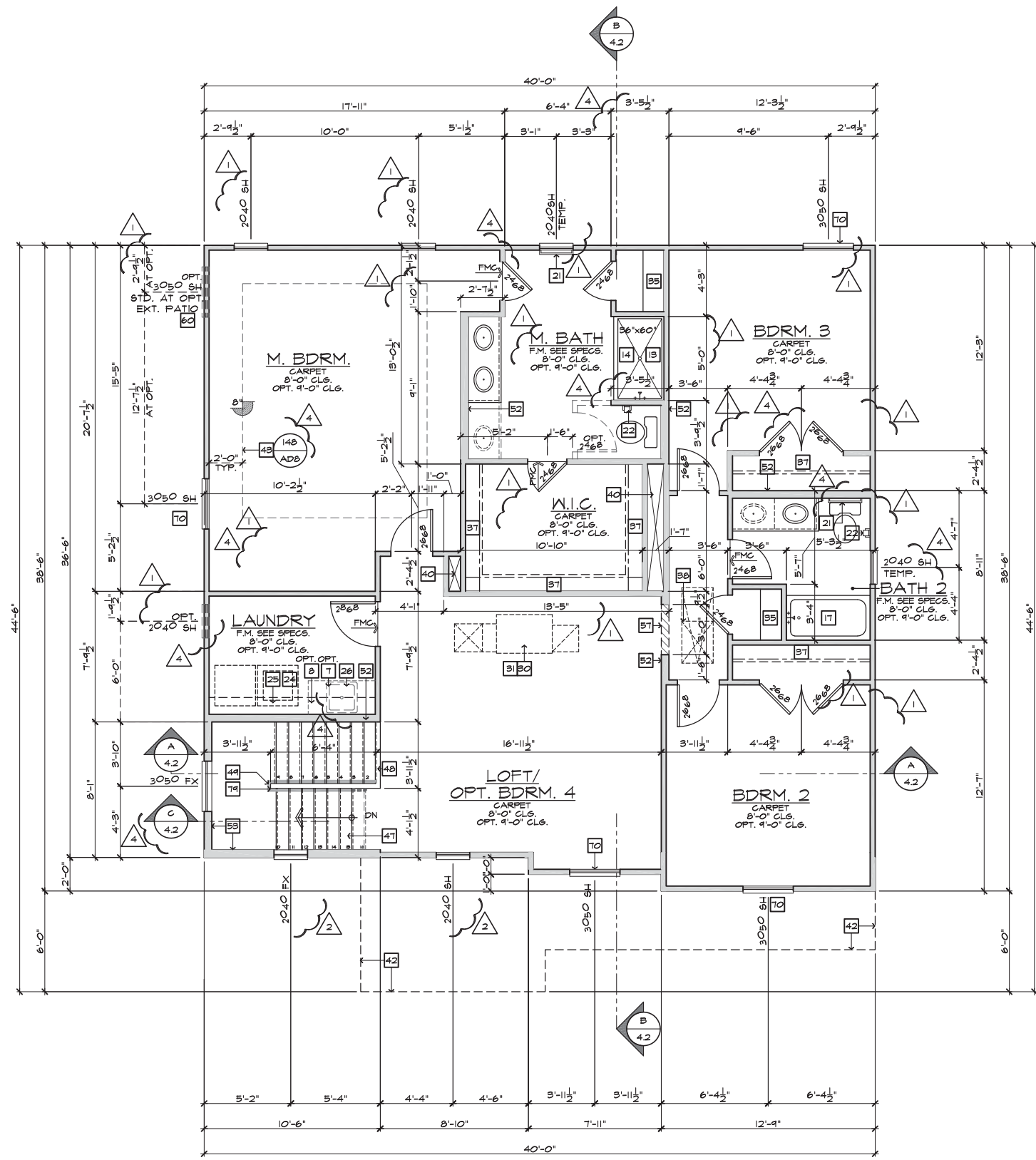

**INTERIOR KEY**

**PLATE NOTES**

- 8'-1" PLATE NOTES**
- WINDOW HEADER HEIGHT: 8'-8" U.N.O.
  - 2ND FLOOR WINDOW HDR. HEIGHT: 7'-0" U.N.O.
  - ENTRY DOOR HEIGHT: 6'-8" U.N.O.
  - SLIDING GLASS DOOR HEIGHT: 6'-8" (TEMP.)
  - INTERIOR SOFFIT HEIGHT: 7'-4" U.N.O.
  - INTERIOR DOOR HEIGHT: 6'-8" U.N.O.

- 9'-1" PLATE NOTES**
- WINDOW HEADER HEIGHT 1st OR 2nd: 7'-8" U.N.O.
  - 4010 WINDOW OVER TUB HDR. H&T.: 8'-4" U.N.O.
  - ENTRY DOOR HEIGHT: 6'-8" U.N.O.
  - SLIDING GLASS DOOR HEIGHT: 6'-8" (TEMP.)
  - INTERIOR SOFFIT HEIGHT: 8'-0" U.N.O.
  - TRAY CEILING: 7/4" DROP U.N.O.
  - INTERIOR DOOR HEIGHT: 6'-8" U.N.O.

- STAIR DATA NOTES**
- FIRST FLOOR WITH 6" PLATE HEIGHT:**  
14" DEEP T.J.I. FLOOR JOISTS WITH 3/4" T&G DECKING.  
14 TREADS AT 10" EACH  
15 RISERS AT 7-11/16" EACH
- FIRST FLOOR WITH 9" PLATE HEIGHT:**  
14" DEEP T.J.I. FLOOR JOISTS WITH 3/4" T&G DECKING.  
15 TREADS AT 10" EACH  
16 RISERS AT 7-3/4" EACH

**GENERAL PLAN NOTES**

- ALL CEILING HEIGHTS PER SECTION AND ELEVATION PLATE HEIGHTS, U.N.O.
- ALL INTERIOR DOORS TO BE HOLLOW CORE 1 3/8" THICK, U.N.O. (REFER TO PLAN FOR SIZE).
- ALL GARAGE SERVICE DOORS TO BE HOLLOW CORE EXTERIOR GRADE (REFER TO PLAN FOR SIZE).
- ALL HOUSE TO GARAGE DOORS TO BE 20-MINUTE FIRE-RATED (REFER TO PLAN FOR SIZE).
- ALL ENTRY DOORS AND EXTERIOR FRENCH DOORS TO BE SOLID CORE 1 3/4" THICK (REFER TO PLAN FOR SIZE).
- ALL FLOOR MATERIAL CHANGES TO OCCUR AT CENTER OF DOOR JAMBS, U.N.O.

**SECOND FLOOR PLAN 'A'**

SCALE 1/4"=1'-0" (22"x34") - 1/8"=1'-0" (11"x17")

BASIC PLAN

These designs and drawings are CONFIDENTIAL and are not to be disclosed without the express permission of KB Home Corporation. Copyright 2019 © KB Home Corporation. All rights reserved.





**NORTH CAROLINA  
40' SERIES**

KB HOME  
NORTH CAROLINA DIVISION

4506 S. MIAMI BLVD.  
SUITE 180  
DURHAM, NC 27703  
TEL: (919) 768-7980  
FAX: (919) 544-2928

**2018 NORTH  
CAROLINA STATE  
BUILDING  
CODES**

ISSUE DATE: 06/02/15  
PROJECT No.: 1350999:56  
DIVISION MGR.: MCP  
REVISIONS: 05/07/19

- 1 DIVISION REVISIONS  
NC18024NCP - 08/24/18 - CTD
- 2 2018 CODE UPDATE  
NC19015NCP/ 03/15/19 / CTD
- 3 DIVISION REVISION  
NC19017NCP- 04/01/19 CTD
- 4 FRAMEWALK REVISIONS  
NC19033NCP- 05/07/19 - CTD

FOR INTERNAL USE ONLY	
REVISION NO.	DATE
1	
2	
3	
4	

PLAN:  
**240.2596-R**

SHEET:  
**1.5**

**SPEC. LEVEL 1**

**RALEIGH-DURHAM  
40' SERIES**

**FLOOR PLAN NOTES**

- NOTE: NOT ALL KEY NOTES APPLY.**
1. SINK - GARBAGE DISPOSAL OPTIONAL - VERIFY DIMENSIONS WITH MANUFACTURERS SPECS
  2. DISHWASHER - PROVIDE AIR GAP - VERIFY SPACING & DIMENSIONS PER MANUFACTURERS' SPECS
  3. SLIDE-IN RANGE/OVEN COMBINATION W/ BUILT-IN NON-VENTED HOOD W/LIGHT & FAN. - VERIFY WITH MANUFACTURERS' SPECS
  4. 30" COOKTOP W/ BUILT-IN VENTED HOOD W/ LIGHT & FAN VERIFY WITH MANUFERS' SPECS
  5. 34" CLEAR REFRIGERATOR SPACE W/ OPTIONAL CABINETS ABOVE - OPT. PLUMBING FOR ICEMAKER (RECESSED IN WALL)
  6. COMBINATION DOUBLE OVEN OR OVEN/MICROWAVE OVEN OR OVEN VERIFY DIMENSIONS WITH MANUFACTURERS' SPECS
  7. BASE CABINETS - REFER TO INTERIOR ELEVATIONS
  8. UPPER CABINETS - REFER TO INTERIOR ELEVATIONS
  9. ISLAND CABINET - REFER TO INTERIOR ELEVATIONS
  10. MIN. 12" BAR TOP/ BREAKFAST BAR
  11. DESK AREA - REFER TO INTERIOR ELEVATIONS
  12. BUILT-IN PANTRY (15" DEEP OR U.N.O.)
  13. SINK CABINET(S) - REFER TO INTERIOR ELEVATIONS
  14. SINK CABINET W/ EXTENDED VANITY & KNEE SPACE BELOW - REFER TO INTERIOR ELEVATIONS
  15. OPT. SINK - REFER TO INTERIOR ELEVATIONS.
  16. KNEE SPACE - REFER TO INTERIOR ELEVATIONS
  17. PRE-FAB. TUB/SHOWER COMBO W/ FIBERGLASS MAINSCOT TO T2' - VERIFY DIMENSIONS W/ MANUF'S SPECS
  18. OVAL TUB - VERIFY DIMENSIONS WITH MANUF'S SPECS.
  19. PRE-FAB. SHOWER PAN W/ 30" MIN. CLR. INSIDE & MAINSCOT TO T2' - VERIFY DIMENSIONS W/ MANUF'S SPECS
  20. SHATTERPROOF (TEMPERED) GLASS SHOWER ENCLOSURE.
  21. TOWEL BAR - PROVIDE 2x SOLID BLK'S IN WALL
  22. TOILET PAPER HOLDER - PROVIDE 2x SOLID BLK'S IN WALL
  23. RECESSED, MIRRORRED MEDICINE CABINET
  24. WASHER & DRYER. - PROVIDE WATER & WASTE FOR WASHER - RECESS WASHER CONTROL VALVES IN WALL - VENT DRYER TO OUTSIDE AIR. - PROVIDE "SMITTY PAN" W/ DRAIN BELOW WASHER AT 2ND FLOOR LAUNDRY LOCATION ACCOMMODATE APPLIANCES TO BE LOCATED WASHER AT LEFT AND DRYER AT RIGHT.
  25. 12" SHELF PER SPECS
  26. OPT. LAUNDRY SINK - REFER TO INTERIOR ELEV'S
  27. WATER HEATER LOCATION: - FOR GAS - LOCATE ON 10" HIGH PLATFORM - FOR INTERIOR LOCATION - PROVIDE PAN & DRAIN. (REFER TO DETAILS)
  28. WATER HEATER 'B' VENT TO OUTSIDE AIR
  29. MAIN LINE SHUT-OFF VALVE AND TEMP. & PRESSURE RELIEF VALVE
  30. F.A.U. LOCATION (REFER TO DETAIL SHEETS)
  31. F.A.U. 'B' VENT TO OUTSIDE AIR
  32. LISTED FACTORY-BUILT GAS FIRED DEC. APPLIANCE (REF. 80/AD4) - INSTALL PER MFR. SPECS
  33. HEARTH TO BE INSTALLED PER FACTORY-BUILT FIREPLACE LISTING
  34. GAS APPLIANCE 'B' VENT FROM BELOW
  35. LINEN PER SPECS (15" DEEP OR U.N.O.)
  36. COAT CLOSET W/ SHELF & POLE (REFER TO DETAIL SHEETS)
  37. WARDROBE W/ SHELF & POLE (REFER TO DETAIL SHEETS)
  38. 22"x30" MIN. ATTIC ACCESS (REFER TO DETAIL SHEETS) W/ 25"x54" FULL DOWN LADDER R.O. ATTIC ACCESS TO BE PROTECTED
  39. LINE OF WALL BELOW
  40. DUCT CHASE
  41. LINE OF FLOOR ABOVE
  42. LINE OF FLOOR BELOW
  43. LINE OF OPTIONAL TRAY CEILING (REFER TO DETAIL SHEETS)
  44. LINE OF HIP AT OPTIONAL VOLUME CEILING
  45. LINE OF RIDGE AT OPTIONAL VOLUME CEILING
  46. CEILING BREAK
  47. STAIR TREADS & RISERS. - MIN. 10" TREAD & MAX. 7 3/4" RISER - (REFER TO DETAIL SHEETS)
  48. MIN. 36" HIGH GUARDRAIL (REFER TO DETAIL SHEETS)
  49. 34" TO 38" HIGH HANDRAIL (REFER TO DETAIL SHEETS)
  50. A/G PAD LOCATION
  51. LOW WALL - REFER TO PLAN FOR HEIGHT
  52. 2x6 STUD WALL
  53. 2x6 BALLOON FRAMED WALL PER STRUCTURAL
  54. DBL. 2x4 WALL PER PLAN
  55. INTERIOR SHELF-SEE PLAN FOR HT. (REFER TO DETAIL SHEETS)
  56. MEDIA NICHE
  57. FLAT SOFFIT - REFER TO PLATE NOTES / ELEV. FOR H6T.
  58. ARCHED SOFFIT - REFER TO PLATE NOTES / ELEV. FOR H6T.
  59. WINDOW SEAT
  60. OPT. DOOR/ WINDOW
  61. PRE-MANUFACTURED DECORATIVE COLUMN (SIZE, SEE ELEV.) PYPON OR EQ. SURROUNDING STRUCTURAL POST.
  62. BRICK / STONE VENEER - REFER TO ELEVATIONS VENEER TO COMPLY WITH THE N.G.-R
  63. SECTIONAL GARAGE DOOR PER SPECS
  64. MIN. 1/2" GYP. BD. ON CEILING & WALLS @ USEABLE SPACE UNDER STAIR.
  65. GARAGE SHALL BE SEPARATED FROM THE RESIDENCE AND ITS ATTIC AREA BY NOT LESS THAT 1/2" GYP. BD. @ GARAGE SIDE WALLS & 5/8" UNDER LIVING AREA U.N.O.
  66. 3" DIAM. CONCRETE FILLED PIPE BOLLARD 36" HIGH WITH MIN. 12" EMBEDMENT INTO CONCRETE (NOT REQUIRED AT ELECTRIC WATER HEATERS OR FOR APPLIANCES LOCATED OUT OF THE VEHICLE'S NORMAL TRAVEL PATH).
  67. 5/8" TYPE-X GYP. IN GARAGE BETWEEN CEILING & FLOOR ABV.
  68. P.T. POST W/ VINYL WRAP
  69. CONCRETE STPOOF. 36"x36" STANDARD SLOPE 1/4" PER FT. MIN.
  70. EGRESS WINDOW
  71. PROVIDE ADDITIONAL RISER(S) AT OPTIONAL PLATE HT.
  72. MDF TOP
  73. PLUMBING DROP FROM ABOVE
  74. ADJUST OPENING AT OPTION TO FIT THE DOOR SIZE SHOWN
  75. WINDOW LEAD. HEIGHT & WIDTH OF OPENING TO EXTEND 6" BEYOND WINDOW(S) ON ALL SIDES U.N.O.
  76. SITE-BUILT COLUMN - SEE ELEVATION FOR TYPE
  77. CONCRETE SLAB. SLOPE 1/4" PER FT. MIN. SEE PLAN FOR SIZE.
  78. LOUVERED DOOR
  79. SLOPING LOW WALL 38" ABOVE ADJACENT TREADS
  80. 20 MIN. FIRE-RATED DOOR

**NOTE:**  
REFER TO BASIC FLOOR PLAN FOR INFORMATION NOT SHOWN HERE

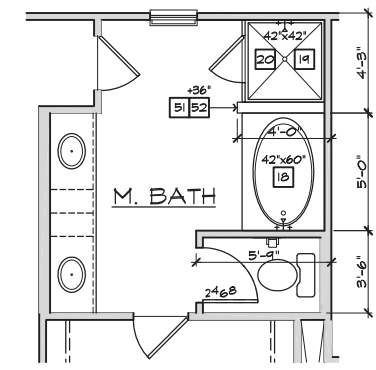

**SUPER M. BATH**  
AT M. BATH

These designs and drawings are CONFIDENTIAL and the exclusive property of KB Home Corporation and are not to be disclosed without the express permission of KB Home Corporation. Copyright 2019 © KB Home Corporation. All rights reserved.





- SLAB PLAN NOTES**
- NOTE: NOT ALL KEY NOTES APPLY.
1. CONCRETE PATIO/PORCH SLAB PER STRUCTURAL- SLOPE 1/4" PER FT. MIN.
  2. CONCRETE GARAGE SLAB PER STRUCTURAL- SLOPE 1/8" PER 1'-0" MIN. TOWARD DOOR OPENING.
  3. CONCRETE FOUNDATION PER STRUCTURAL.
  4. CONCRETE STOOP; 36"x36" STANDARD SLOPE 1/4" PER FT. MIN.
  5. CONCRETE DRIVEWAY SLOPE 1/4" PER FT. MIN. AWAY FROM GARAGE DOOR OPENING.
  6. PROVIDE ELECTRICAL CONDUIT UNDER SLAB AT ISLAND. VERIFY LOCATION.
  7. 5" BRICK LEDGE FOR MASONRY VENEER.
  8. 3" DIAMETER CONCRETE FILLED PIPE BOLLARD 36" HIGH WITH MIN. 12" EMBEDMENT INTO CONCRETE.
  9. REFER TO CIVIL DRAWINGS FOR ALL FINISH SURFACE ELEVATIONS.
  10. VERIFY ALL PLUMBING STUB DIMENSIONS SHOWN HERE PRIOR TO POUR OF SLAB.
  11. 4" MIN. Ø 1/4" MAX. TO HARD SURFACE.
  12. A/C PAD. VERIFY LOCATION.
  13. 36" WIDE WALKWAY- SLOPE 1/4" PER FT. MIN.

**NORTH CAROLINA 40' SERIES**

KB HOME  
NORTH CAROLINA DIVISION

4506 S. MIAMI BLVD.  
SUITE 180  
DURHAM, NC 27703  
TEL: (919) 768-7980  
FAX: (919) 544-2928

**2018 NORTH CAROLINA STATE BUILDING CODES**

ISSUE DATE: 06/02/15  
PROJECT No.: 1350999:56  
DIVISION MGR.: MCP  
REVISIONS: 05/07/19

- 1 DIVISION REVISIONS NC18024NCP - 08/24/18 - CTD
- 2 2018 CODE UPDATE NC1905NCP/ 03/15/19 / CTD
- 3 DIVISION REVISION NC1907NCP- 04/01/19 CTD
- 4 FRAMEWORK REVISIONS NC19033NCP- 05/07/19 - CTD

FOR INTERNAL USE ONLY

REVISION NO.	DATE	BY	DESCRIPTION

PLAN: 240.2596-R  
SHEET: 2.1

SPEC. LEVEL 1  
RALEIGH-DURHAM 40' SERIES

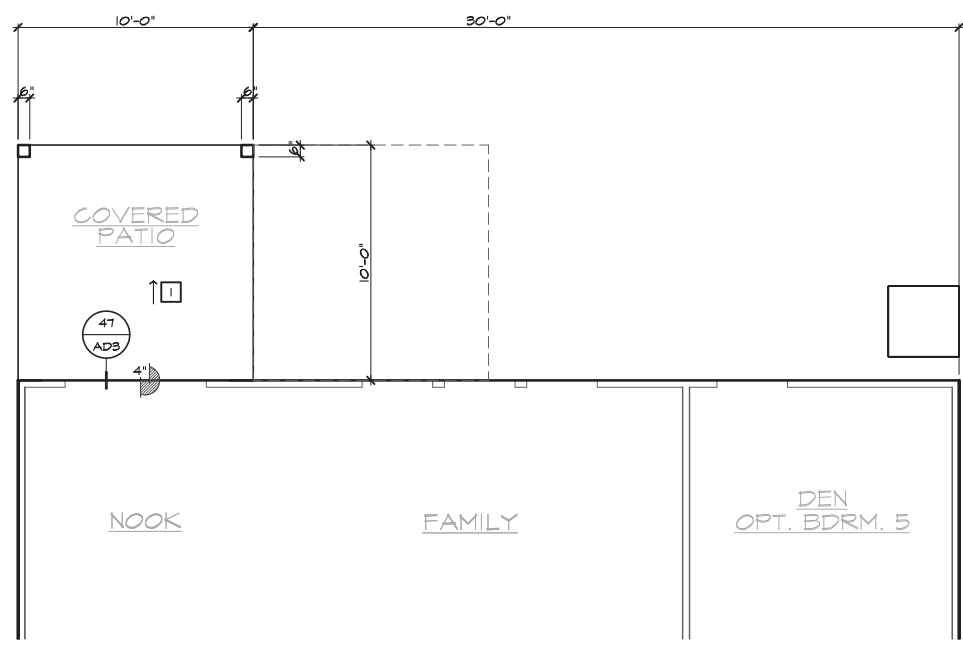

10'x10' COVERED PATIO

SLAB INTERFACE PLAN OPTIONS  
SCALE 1/4"=1'-0" (22'x34') - 1/8"=1'-0" (11'x17') BASIC PLAN AT SLAB-ON-GRADE

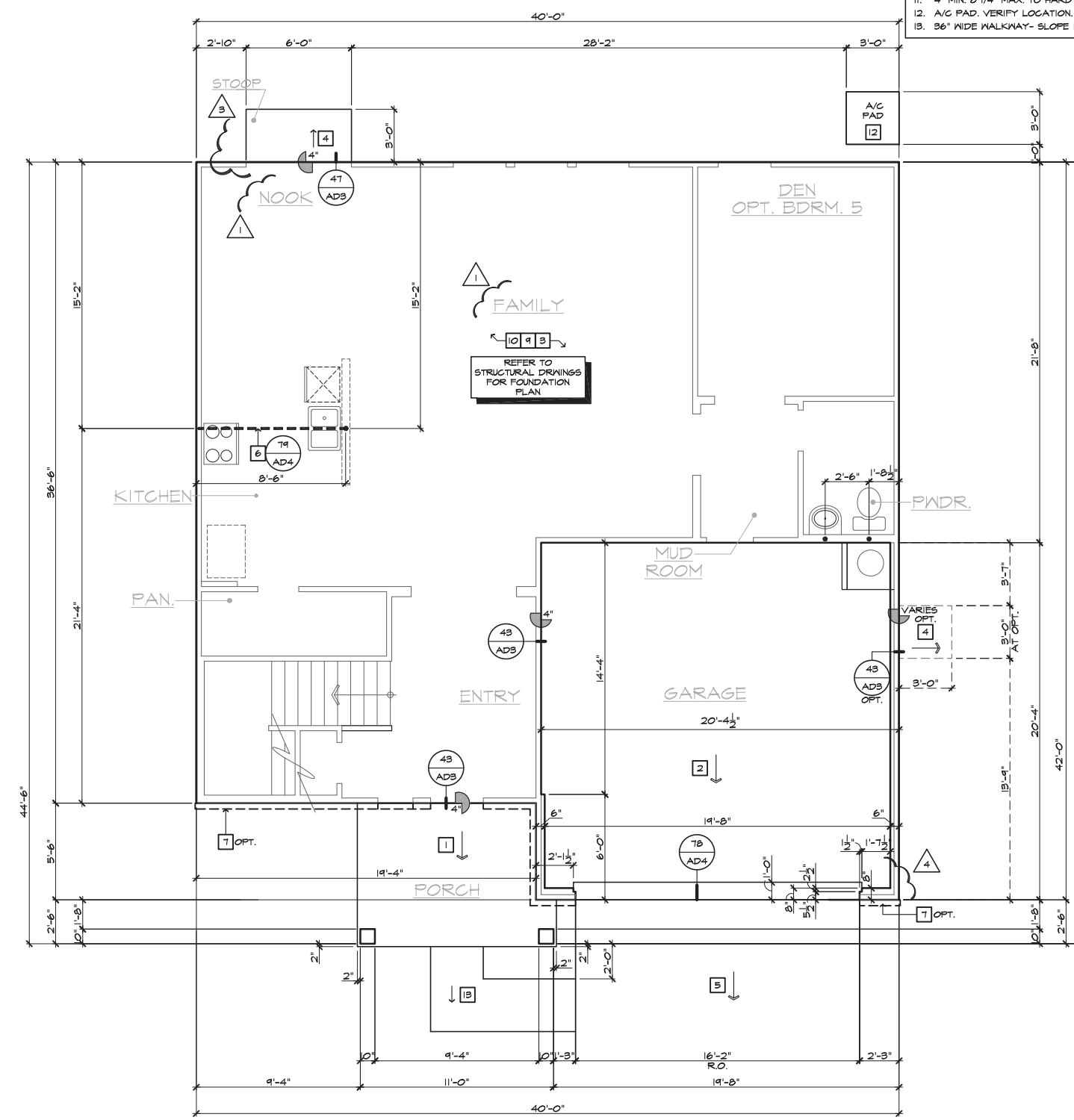

SLAB INTERFACE PLAN 'A'  
SCALE 1/4"=1'-0" (22'x34') - 1/8"=1'-0" (11'x17') BASIC PLAN AT SLAB-ON-GRADE

These designs and drawings are CONFIDENTIAL and the exclusive property of KB Home Corporation and are not to be disclosed without the express permission of KB Home Corporation. Copyright 2019 © KB Home Corporation. All rights reserved.





#	SLAB PLAN NOTES
NOTE: NOT ALL KEY NOTES APPLY.	
1.	CONCRETE PATIO/PORCH SLAB PER STRUCTURAL- SLOPE 1/4" PER FT. MIN.
2.	CONCRETE GARAGE SLAB PER STRUCTURAL- SLOPE 1/8" PER 1'-0" MIN. TOWARD DOOR OPENING.
3.	CONCRETE FOUNDATION PER STRUCTURAL.
4.	CONCRETE STOOP, 36"X36" STANDARD SLOPE 1/4" PER FT. MIN.
5.	CONCRETE DRIVEWAY SLOPE 1/4" PER FT. MIN. AWAY FROM GARAGE DOOR OPENING.
6.	PROVIDE ELECTRICAL CONDUIT UNDER SLAB AT ISLAND. VERIFY LOCATION.
7.	5" BRICK LEDGE FOR MASONRY VENEER.
8.	3" DIAMETER CONCRETE FILLED PIPE BOLLARD 36" HIGH WITH MIN. 12" EMBEDMENT INTO CONCRETE.
9.	REFER TO CIVIL DRAWINGS FOR ALL FINISH SURFACE ELEVATIONS.
10.	VERIFY ALL PLUMBING STUB DIMENSIONS SHOWN HERE PRIOR TO POUR OF SLAB.
11.	4" MIN. Ø 1/4" MAX. TO HARD SURFACE.
12.	A/C PAD. VERIFY LOCATION.
13.	36" WIDE WALKWAY- SLOPE 1/4" PER FT. MIN.

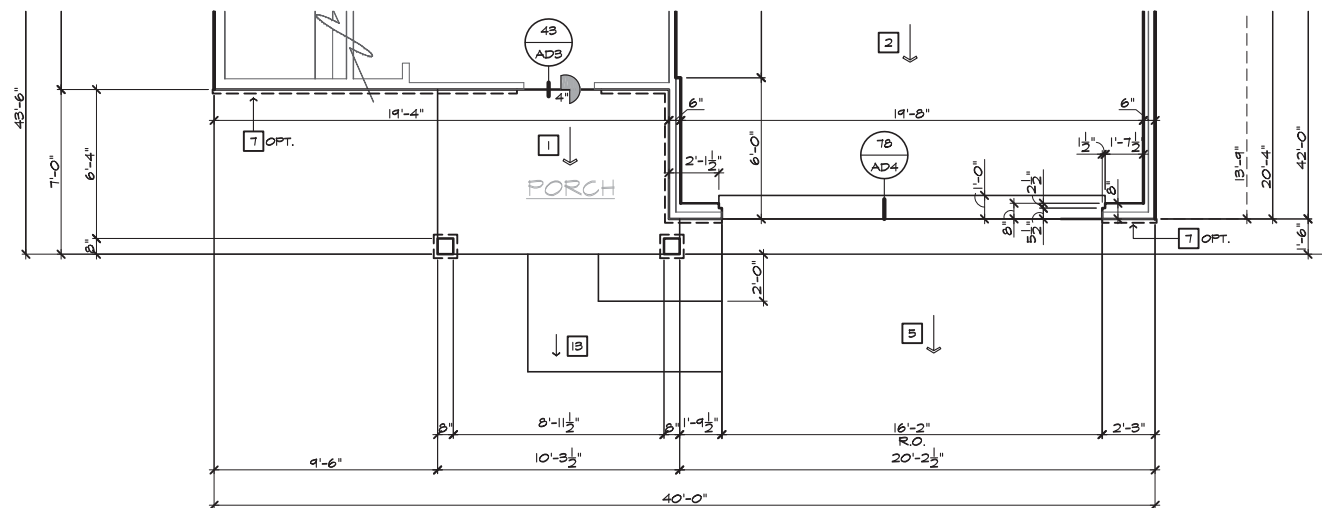

**PARTIAL SLAB INTERFACE PLAN 'C'**

SCALE 1/4"=1'-0" (22"X34") - 1/8"=1'-0" (11"X17")

BASIC PLAN AT SLAB-ON-GRADE

**NORTH CAROLINA  
40' SERIES**

KB HOME  
NORTH CAROLINA DIVISION

4506 S. MIAMI BLVD.  
SUITE 180  
DURHAM, NC 27703  
TEL: (919) 768-7980  
FAX: (919) 544-2928

**2018 NORTH  
CAROLINA STATE  
BUILDING  
CODES**

ISSUE DATE: 06/02/15  
PROJECT No.: 1350999:56  
DIVISION MGR.: MCP  
REVISIONS: 05/07/19

- 1 DIVISION REVISIONS  
NC18024NCP - 08/24/18 - CTD
- 2 2018 CODE UPDATE  
NC19015NCP/ 03/15/19 / CTD
- 3 DIVISION REVISION  
NC19017NCP- 04/01/19 CTD
- 4 FRAMEWALK REVISIONS  
NC19033NCP- 05/07/19 - CTD

FOR INTERNAL USE ONLY	
REVISIONED BY:	
1.	_____
2.	_____
3.	_____
4.	_____
5.	_____
6.	_____

PLAN:  
**240.2596-R**  
SHEET:  
**2.2**

**SPEC. LEVEL 1  
RALEIGH-DURHAM  
40' SERIES**

These designs and drawings are CONFIDENTIAL and the exclusive property of KB Home Corporation and are not to be disclosed without the express permission of KB Home Corporation. Copyright 2019 © KB Home Corporation. All rights reserved.



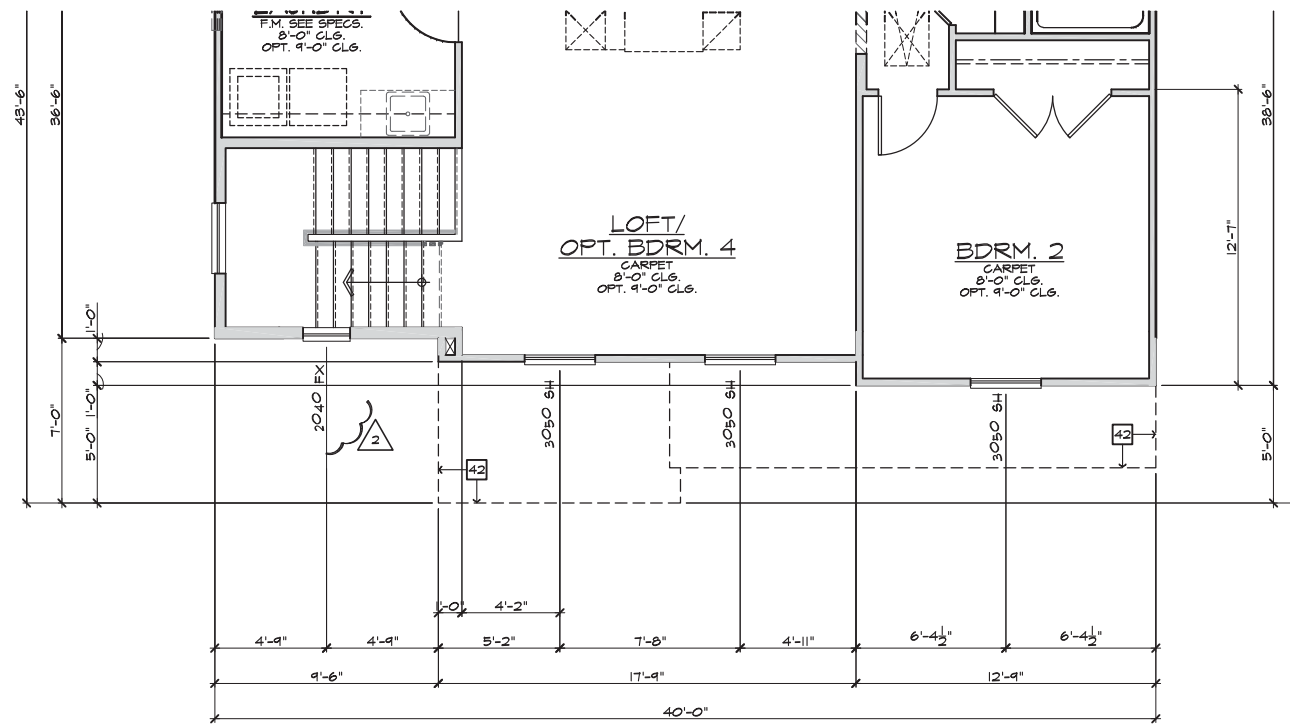

PARTIAL SECOND FLOOR PLAN 'C'

SCALE 1/4"=1'-0" (22'x34") - 1/8"=1'-0" (11'x17")

BASIC PLAN

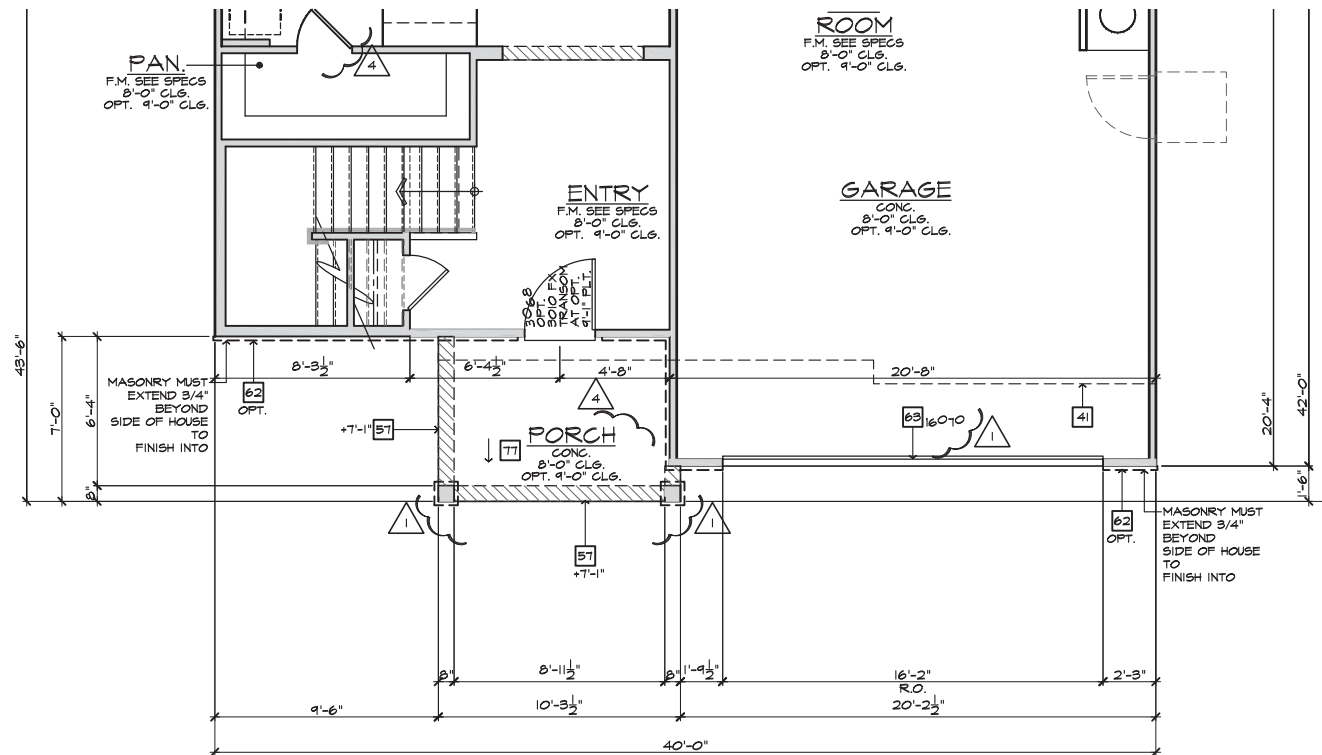

PARTIAL FIRST FLOOR PLAN 'C'

SCALE 1/4"=1'-0" (22'x34") - 1/8"=1'-0" (11'x17")

BASIC PLAN

#	PARTIAL PLAN NOTES
27.	NOTE: NOT ALL KEY NOTES APPLY. WATER HEATER LOCATION - FOR GAS - LOCATE ON 18" HIGH PLATFORM - FOR INTERIOR LOCATION - PROVIDE PAN & DRAIN (REFER TO DETAILS)
28.	WATER HEATER 'B' VENT TO OUTSIDE AIR
29.	MAIN LINE SHUT-OFF VALVE AND TEMP. & PRESSURE RELIEF VALVE
39.	LINE OF WALL BELOW
41.	LINE OF FLOOR ABOVE
42.	LINE OF FLOOR BELOW
48.	MIN. 36" HIGH GUARDRAIL (REFER TO DETAIL SHEETS)
50.	A/C PAD LOCATION
51.	LOW WALL - REFER TO PLAN FOR HEIGHT
52.	2x6 STUD WALL
54.	DBL. 2x4 WALL PER PLAN
55.	INTERIOR SHELF - REFER TO PLAN FOR HEIGHT
57.	FLAT SOFFIT
58.	ARCHED SOFFIT
60.	OPT. DOOR/ WINDOW
61.	PRE-MANUFACTURED DECORATIVE COLUMN (SIZE, SEE ELEV.) FYPON OR EQ. SURROUNDING STRUCTURAL POST.
62.	BRICK / STONE VENEER - REFER TO ELEVATIONS
63.	SECTIONAL GARAGE DOOR PER SPECS
66.	3" DIAM. CONCRETE FILLED PIPE BOLLARD 36" HIGH WITH MIN. 12" EMBEDMENT INTO CONCRETE. (NOT REQUIRED AT ELECTRIC WATER HEATERS OR FOR APPLIANCES LOCATED OUT OF THE VEHICLE'S NORMAL TRAVEL PATH).
68.	FT. POST W/ VINYL WRAP.
70.	ESRESS WINDOW
75.	WINDOW LEDGE, HEIGHT & WIDTH OF OPENING TO EXTEND 6" BEYOND WINDOW(S) ON ALL SIDES U.N.O.
76.	SITE-BUILT COLUMN - SEE ELEVATION FOR TYPE
77.	CONCRETE SLAB, SLOPE 1/4" PER FT. MIN. SEE PLAN FOR SIZE



**NORTH CAROLINA  
40' SERIES**

KB HOME  
NORTH CAROLINA DIVISION  
4506 S. MIAMI BLVD.  
SUITE 180  
DURHAM, NC 27703  
TEL: (919) 768-7980  
FAX: (919) 544-2928

**2018 NORTH  
CAROLINA STATE  
BUILDING  
CODES**

ISSUE DATE: 06/02/15  
PROJECT No.: 1350999:56  
DIVISION MGR.: MCP  
REVISIONS: 05/07/19

- 1 DIVISION REVISIONS  
NC18024NCP - 08/24/18 - CTD
- 2 2018 CODE UPDATE  
NC19015NCP/ 03/15/19 / CTD
- 3 DIVISION REVISION  
NC19077NCP - 04/01/19 CTD
- 4 FRAMEWALL REVISIONS  
NC19033NCP - 05/07/19 - CTD

FOR INTERNAL USE ONLY	
REVISION BY:	
1.	
2.	
3.	
4.	
5.	
6.	

PLAN:  
**240.2596-R**  
SHEET:  
**3.C1**

**SPEC. LEVEL 1  
RALEIGH-DURHAM  
40' SERIES**

NOTE:  
REFER TO BASIC FLOOR PLAN FOR INFORMATION NOT SHOWN HERE

These designs and drawings are CONFIDENTIAL and the exclusive property of KB Home Corporation and are not to be disclosed without the express permission of KB Home Corporation. Copyright 2019 © KB Home Corporation, all rights reserved.



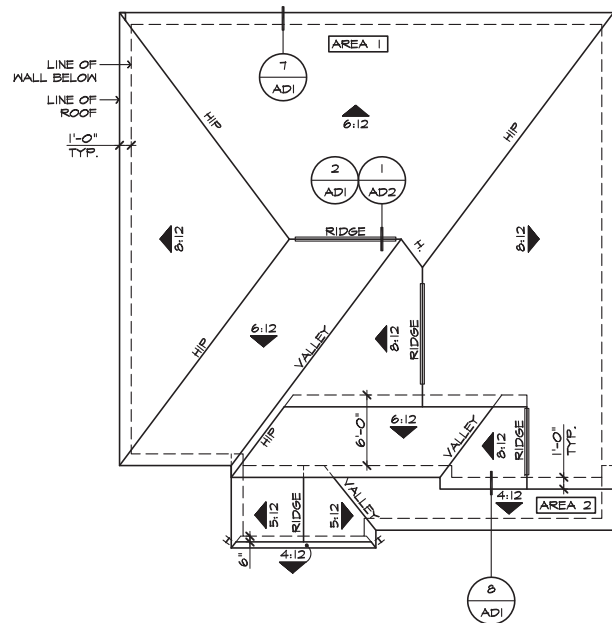

**ROOF PLAN 'C'**

SCALE 1/8"=1'-0" (22'x34') - 1/16"=1'-0" (11'x17')



**REAR ELEVATION 'C'**

SCALE 1/4"=1'-0" (22'x34') - 1/8"=1'-0" (11'x17')

**ELEVATION NOTES**

- NOTE: NOT ALL KEY NOTES APPLY.**
1. ROOF MATERIAL - REFER TO ROOF NOTES
  2. 2X FASCIA/BARGE BOARD WITH FASCIA GAP
  3. G.I. FLASHING
  4. G.I. FLASHING & SADDLE/CRICKET
  5. G.I. DRIP SCREED
  6. 24"x24" CHIMNEY
  7. DECORATIVE VENT
  8. DECORATIVE CORBEL
  9. DECORATIVE SHUTTERS
  10. PEDIMENT, SEE ELEVATION FOR TYPE
  11. RECESSED ELEMENT
  12. DECORATIVE TRIM FYPHON OR EQ. SEE ELEVATION FOR TYPE
  13. TRIM - SEE ELEVATION FOR SIZE
  14. SYNTHETIC MATERIAL
  15. PRE-MANUFACTURED DECORATIVE COLUMN (SIZE, SEE ELEV.) FYPHON OR EQ. SURROUNDING STRUCTURAL POST.
  16. SITE-BUILT COLUMN - SEE ELEVATION FOR TYPE
  17. SHAKE SIDING
  18. STONE VENEER PER SPECS
  19. BRICK/MASONRY VENEER PER SPECS
  20. BUILT UP BRICK COLUMN
  21. SOLDIER COURSE
  22. ROWLOCK COURSE
  23. FRIEZE BOARD
  24. SIDING W/ 4" CORNER TRIM PER SPECS
  25. P.T. POST W/ WRAP - SEE STRUCTURAL FOR SIZE
  26. PRE-FAB DECORATIVE TRIM
  27. LIGHT WEIGHT PRECAST STONE TRIM
  28. RAILINGS (36" U.N.O.)
  29. VINYL WRAP
  30. DECORATIVE WINDOW/DOOR TRIM - FYPHON OR EQ. SEE ELEVATION FOR SIZE.
  31. BRACKET OR KICKER - FYPHON OR EQ.
  32. ENTRY DOOR
  33. CONCRETE STOOP/ PORCH - SEE SLAB INTERFACE PLAN.
  34. SECTIONAL GARAGE DOOR PER SPECS
  35. ALUMINUM WRAP
  36. OPTIONAL DOOR/WINDOW - REFER TO PLAN OPTIONS
  37. OPTIONAL STANDING SEAM METAL ROOF
  38. KEYSTONE
  39. SOLDIER CROWN
  40. JACK SOLDIER COURSE
  41. WATER TABLE
  42. ATRIUM DOOR
  43. PILASTER - SEE ELEVATION FOR TYPE

**ROOF PLAN NOTES 'C'**

**INDICATES ROOF SLOPE AND DIRECTION, U.N.O.**

6:12

**ROOF MATERIAL: COMPOSITION SHINGLE**

12" (INCHES) TYPICAL ROOF OVERHANG AT RAKE, U.N.O.

12" (INCHES) TYPICAL ROOF OVERHANG AT EAVE, U.N.O.

LOCATE EAVE/ RAFTER VENTS EQUALLY BALANCED AROUND HOUSE EXCEPT ABOVE SHEARWALL PANELS.

**ATTIC VENT CALCULATIONS**

PROVIDE 1 SQ. IN. OF VENTILATION PER 300 SQ. IN. OF ATTIC SPACE. \* PROVIDE THAT AT LEAST 50% & NO MORE THAN 50% OF THE REQ. VENTILATING AREA IS PROVIDED BY VENTILATORS LOCATED IN THE UPPER PORTION OF THE ATTIC. (HIGH VENTING) AT 3'-0" ABOVE EAVE VENT WITH THE BALANCE BEING PROVIDED BY EAVE VENTS. (LOW VENTING) (2018 N.C.-R 806.2)

\* CALCULATION BY 1/150, HIGH/LOW VENTING NOT REQUIRED.

APPROXIMATE RIDGE VENT LOCATIONS SHOWN. ACTUAL LOCATIONS TO BE DETERMINED IN THE FIELD.

AREA	VENTILATION REQUIRED:	ATTIC AREA	VENTILATION PROVIDED:
AREA 1	VENTILATION REQUIRED:	ATTIC AREA = 1503 SQ. FT. / 300 = 5.01 SQ. FT.	21 LINEAR FEET RIDGE VENT AT 10 SQ. IN. PER FOOT = 970 SQ. IN.
		X 144 = 721.44 SQ. IN.	TOTAL HIGH = 721 SQ. IN.
	LOW		73 LINEAR FEET EAVE VENT AT 5 SQ. IN. PER FOOT = 965 SQ. IN.
			TOTAL LOW = 743 SQ. IN.
			TOTAL = 743 SQ. IN.
AREA 2	VENTILATION REQUIRED:	ATTIC AREA = 140 SQ. FT. / 150 = 0.93 SQ. FT.	27 LINEAR FEET EAVE VENT AT 5 SQ. IN. PER FOOT = 135 SQ. IN.
		X 144 = 134.94 SQ. IN.	TOTAL = 135 SQ. IN.
	LOW		



**NORTH CAROLINA 40' SERIES**

KB HOME  
NORTH CAROLINA DIVISION  
4506 S. MIAMI BLVD.  
SUITE 180  
DURHAM, NC 27703  
TEL: (919) 768-7980  
FAX: (919) 544-2928

**2018 NORTH CAROLINA STATE BUILDING CODES**

ISSUE DATE: 06/02/15  
PROJECT No.: 1350999:56  
DIVISION MGR.: MCP  
REVISIONS: 05/07/19

- 1 DIVISION REVISIONS NC18024NCP - 08/24/18 - CTD
- 2 2018 CODE UPDATE NC1915NCP/ 03/15/19 / CTD
- 3 DIVISION REVISION NC1907NCP- 04/01/19 CTD
- 4 FRAMEWALK REVISIONS NC19033NCP- 05/07/19 - CTD

FOR INTERNAL USE ONLY

REVIEWED BY:

1. \_\_\_\_\_

2. \_\_\_\_\_

3. \_\_\_\_\_

4. \_\_\_\_\_

5. \_\_\_\_\_

6. \_\_\_\_\_

PLAN:  
**240.2596-R**

SHEET:  
**3.C2**

**SPEC. LEVEL 1  
RALEIGH-DURHAM  
40' SERIES**

These designs and drawings are CONFIDENTIAL and the exclusive property of KB Home Corporation and are not to be disclosed without the express permission of KB Home Corporation. Copyright 2019 © KB Home Corporation. All rights reserved.



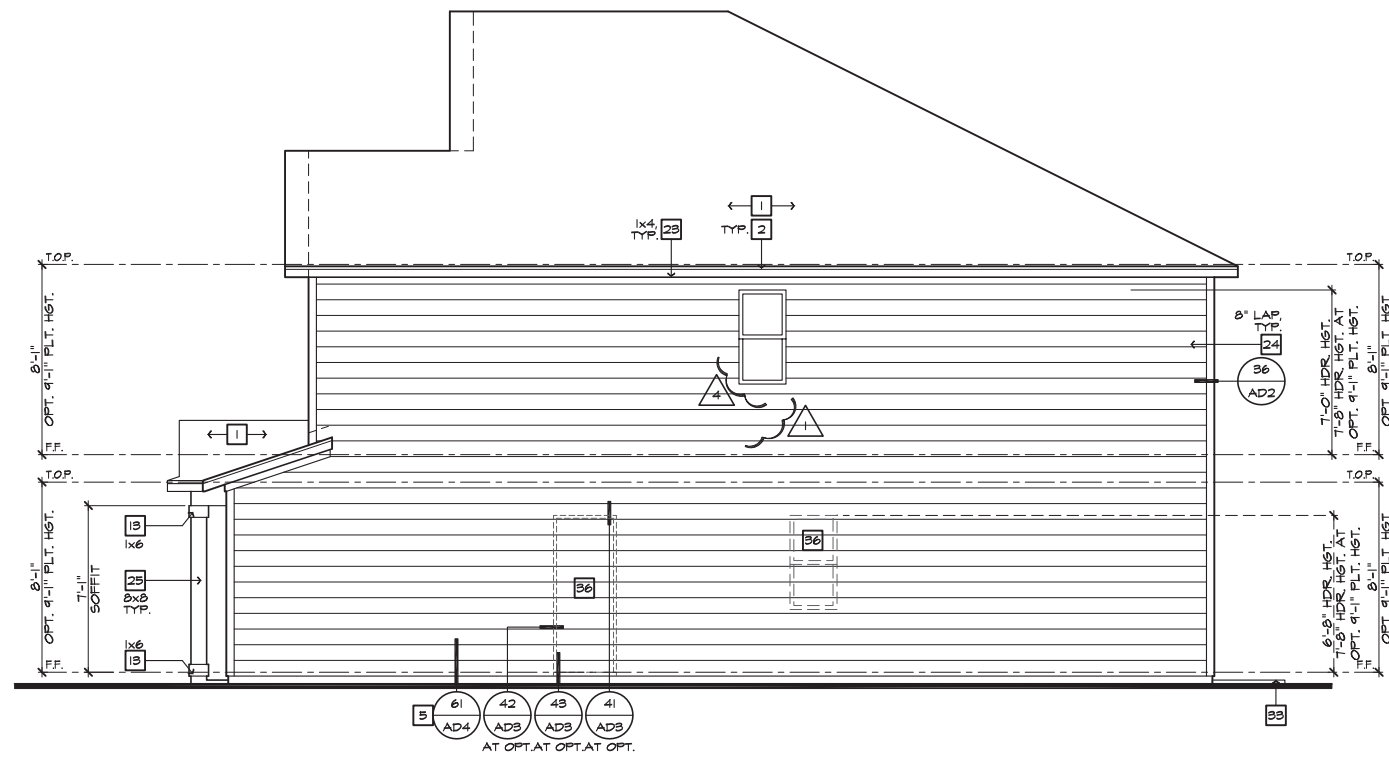

**RIGHT ELEVATION 'C'**  
SCALE 1/4"=1'-0" (22'x34') - 1/8"=1'-0" (11'x17')

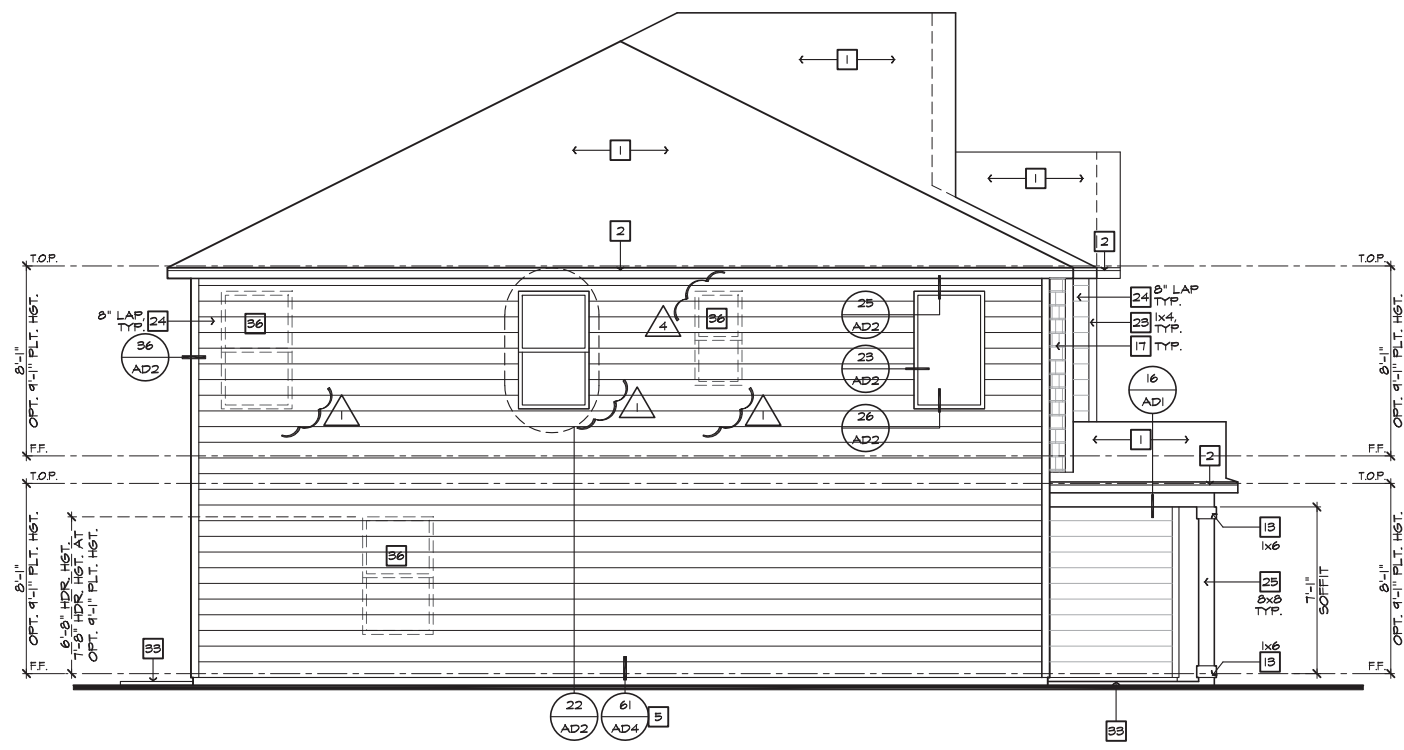

**LEFT ELEVATION 'C'**  
SCALE 1/4"=1'-0" (22'x34') - 1/8"=1'-0" (11'x17')

#	ELEVATION NOTES
<b>NOTE: NOT ALL KEY NOTES APPLY.</b>	
1.	ROOF MATERIAL - REFER TO ROOF NOTES
2.	2X FASCIA/BARGE BOARD WITH FASCIA GAP
3.	G.I. FLASHING
4.	G.I. FLASHING & SADDLE/CRICKET
5.	G.I. DRIP SCREED
6.	24"x24" CHIMNEY
7.	DECORATIVE VENT
8.	DECORATIVE CORBEL
9.	DECORATIVE SHUTTERS
10.	PEDIMENT, SEE ELEVATION FOR TYPE
11.	RECESSED ELEMENT
12.	DECORATIVE TRIM FYPON OR EQ. SEE ELEVATION FOR TYPE
13.	TRIM - SEE ELEVATION FOR SIZE
14.	SYNTHETIC MATERIAL
15.	PRE-MANUFACTURED DECORATIVE COLUMN (SIZE, SEE ELEV.) FYPON OR EQ. SURROUNDING STRUCTURAL POST.
16.	SITE-BUILT COLUMN - SEE ELEVATION FOR TYPE
17.	SHAKE SIDING
18.	STONE VENEER PER SPECS
19.	BRICK/MASONRY VENEER PER SPECS
20.	BUILT UP BRICK COLUMN
21.	SOLDIER COURSE
22.	ROWLOCK COURSE
23.	FRIEZE BOARD
24.	SIDING W/ 4" CORNER TRIM PER SPECS
25.	P.T. POST W/ WRAP - SEE STRUCTURAL FOR SIZE
26.	PRE-FAB DECORATIVE TRIM
27.	LIGHT WEIGHT PRECAST STONE TRIM
28.	RAILINGS (48" U.N.O.)
29.	VINYL WRAP
30.	DECORATIVE WINDOW/DOOR TRIM - FYPON OR EQ. SEE ELEVATION FOR SIZE.
31.	BRACKET OR KICKER - FYPON OR EQ.
32.	ENTRY DOOR
33.	CONCRETE STOOP/ PORCH - SEE SLAB INTERFACE PLAN.
34.	SECTIONAL GARAGE DOOR PER SPECS
35.	ALUMINUM WRAP
36.	OPTIONAL DOOR/WINDOW - REFER TO PLAN OPTIONS
37.	OPTIONAL STANDING SEAM METAL ROOF
38.	KEYSTONE
39.	SOLDIER CROWN
40.	JACK SOLDIER COURSE
41.	WATER TABLE
42.	ATRIUM DOOR
43.	PILASTER - SEE ELEVATION FOR TYPE



**NORTH CAROLINA  
40' SERIES**

KB HOME  
NORTH CAROLINA DIVISION  
4506 S. MIAMI BLVD.  
SUITE 180  
DURHAM, NC 27703  
TEL: (919) 768-7980  
FAX: (919) 544-2928

**2018 NORTH  
CAROLINA STATE  
BUILDING  
CODES**

ISSUE DATE: 06/02/15  
PROJECT No.: 1350999:56  
DIVISION MGR.: MCP  
REVISIONS: 05/07/19

- 1. DIVISION REVISIONS NC18024NCP - 02/24/18 - CTD
- 2. 2018 CODE UPDATE NC1905NCP/ 03/15/19 / CTD
- 3. DIVISION REVISION NC1907NCP- 04/01/19 CTD
- 4. FRAMEWORK REVISIONS NC19033NCP- 05/07/19 - CTD

FOR INTERNAL USE ONLY	
REVISION NO.	BY

PLAN:  
**240.2596-R**  
SHEET:  
**3.C3**

**SPEC. LEVEL 1  
RALEIGH-DURHAM  
40' SERIES**

These designs and drawings are CONFIDENTIAL and the exclusive property of KB Home Corporation and are not to be disclosed without the express permission of KB Home Corporation. Copyright 2019 © KB Home Corporation. All rights reserved.





**NORTH CAROLINA  
40' SERIES**

KB HOME  
NORTH CAROLINA DIVISION  
4518 S. MIAMI BLVD.  
SUITE 180  
DURHAM, NC 27703  
TEL: (919) 768-7988  
FAX: (919) 472-0582

**2018 NORTH  
CAROLINA STATE  
BUILDING  
CODES**

ISSUE DATE: 06/02/15  
PROJECT No.: 1350999:56  
DIVISION MGR.: MCP  
REVISIONS: 05/07/19

- 1 DIVISION REVISIONS  
NC18024NCP - 08/24/18 - CTD
- 2 2018 CODE UPDATE  
NC19015NCP/ 03/15/19 / CTD
- 3 DIVISION REVISION  
NC19017NCP- 04/01/19 CTD
- 4 FRAMEWALK REVISIONS  
NC19033NCP- 05/07/19 - CTD
- 5 DIVISION REVISIONS  
NC20012NCP- 01/29/20 - KBA

FOR INTERNAL USE ONLY	
REVISION NO.	DATE
1.	
2.	
3.	
4.	
5.	
6.	

PLAN:  
**240.2596-R**  
SHEET:  
**3.C8**

**SPEC. LEVEL 1  
RALEIGH-DURHAM  
40' SERIES**

#	ELEVATION NOTES
<b>NOTE: NOT ALL KEY NOTES APPLY.</b>	
1.	ROOF MATERIAL - REFER TO ROOF NOTES
2.	2X FASCIA/BARGE BOARD WITH FASCIA CAP
3.	G.I. FLASHING
4.	G.I. FLASHING & SADDLE/CRICKET
5.	G.I. DRIP SCREED
6.	24"x24" CHIMNEY
7.	DECORATIVE VENT
8.	DECORATIVE CORBEL
9.	DECORATIVE SHUTTERS
10.	PEDIMENT, SEE ELEVATION FOR TYPE
11.	RECESSED ELEMENT
12.	DECORATIVE TRIM FYPON OR EQ. SEE ELEVATION FOR TYPE
13.	TRIM PER SPEC- SEE ELEVATION FOR SIZE
14.	SYNTHETIC MATERIAL
15.	PRE-MANUFACTURED DECORATIVE COLUMN (SIZE, SEE ELEV.) FYPON OR EQ. SURROUNDING STRUCTURAL POST.
16.	SITE-BUILT COLUMN - SEE ELEVATION FOR TYPE
17.	SHAKE SIDING
18.	STONE VENEER PER SPECS
19.	BRICK/MASONRY VENEER PER SPECS
20.	BUILT UP BRICK COLUMN
21.	SOLDIER COURSE
22.	ROWLOCK COURSE
23.	FRIEZE BOARD
24.	SIDING W/ 4" CORNER TRIM PER SPECS
25.	P.T. POST W/ WRAP - SEE STRUCTURAL FOR SIZE
26.	PRE-FAB DECORATIVE TRIM
27.	LIGHT WEIGHT PREGCAST STONE TRIM
28.	P.T. LUMBER RAILINGS (436" U.N.O.)
29.	WRAP
30.	DECORATIVE WINDOW/DOOR TRIM - FYPON OR EQ. SEE ELEVATION FOR SIZE.
31.	BRACKET OR KICKER - FYPON OR EQ.
32.	ENTRY DOOR
33.	CONCRETE STOOP/ PORCH - SEE SLAB INTERFACE PLAN.
34.	SECTIONAL GARAGE DOOR PER SPECS
35.	ALUMINUM WRAP
36.	OPTIONAL DOOR/WINDOW - REFER TO PLAN OPTIONS
37.	OPTIONAL STANDING SEAM METAL ROOF
38.	KEYSTONE
39.	SOLDIER CROWN
40.	JACK SOLDIER COURSE
41.	WATER TABLE
42.	ATRIUM DOOR
43.	PILASTER - SEE ELEVATION FOR TYPE

#	PARTIAL PLAN NOTES
<b>NOTE: NOT ALL KEY NOTES APPLY.</b>	
27.	WATER HEATER LOCATION - FOR GAS - LOCATE ON 18" HIGH PLATFORM - FOR INTERIOR LOCATION - PROVIDE PAN & DRAIN (REFER TO DETAILS)
28.	WATER HEATER 'B' VENT TO OUTSIDE AIR
29.	MAIN LINE SHUT-OFF VALVE AND TEMP. & PRESSURE RELIEF VALVE
34.	LINE OF WALL BELOW
41.	LINE OF FLOOR ABOVE
42.	LINE OF FLOOR BELOW
43.	MIN. 36" HIGH GUARDRAIL (REFER TO DETAIL SHEETS)
50.	A/C PAD LOCATION
51.	LOW WALL - REFER TO PLAN FOR HEIGHT
52.	2x6 STUD WALL
54.	DEL. 2x4 WALL PER PLAN
55.	INTERIOR SHELF - REFER TO PLAN FOR HEIGHT
57.	FLAT SOFFIT
58.	ARCHED SOFFIT
60.	OPT. DOOR/ WINDOW
61.	PRE-MANUFACTURED DECORATIVE COLUMN (SIZE, SEE ELEV.) FYPON OR EQ. SURROUNDING STRUCTURAL POST.
62.	BRICK / STONE VENEER - REFER TO ELEVATIONS
63.	SECTIONAL GARAGE DOOR PER SPECS
66.	3" DIAM. CONCRETE FILLED PIPE BOLLARD 36" HIGH WITH MIN. 12" EMBEDMENT INTO CONCRETE (NOT REQUIRED AT ELECTRIC WATER HEATERS OR FOR APPLIANCES LOCATED OUT OF THE VEHICLE'S NORMAL TRAVEL PATH).
68.	P.T. POST W/ WRAP.
70.	EGRESS WINDOW
75.	WINDOW LEDGE, HEIGHT & WIDTH OF OPENING TO EXTEND 6" BEYOND WINDOWS) ON ALL SIDES U.N.O.
76.	SITE-BUILT COLUMN - SEE ELEVATION FOR TYPE
77.	CONCRETE SLAB, SLOPE 1/4" PER FT. MIN. SEE PLAN FOR SIZE



LEFT ELEVATION 'C'  
W/ OPTIONAL MASONRY  
AT OPTIONAL 9'-1" PLT. HGT.  
SCALE 1/4"=1'-0" (22'X34") - 1/8"=1'-0" (11'X17")

FRONT ELEVATION 'C'  
W/ OPTIONAL MASONRY  
AT OPTIONAL 9'-1" PLT. HGT.  
SCALE 1/4"=1'-0" (22'X34") - 1/8"=1'-0" (11'X17")

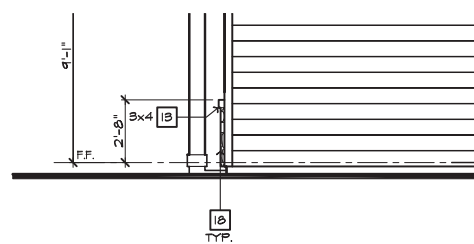

RIGHT ELEVATION 'C'  
W/ OPTIONAL MASONRY  
AT OPTIONAL 9'-1" PLT. HGT.  
SCALE 1/4"=1'-0" (22'X34") - 1/8"=1'-0" (11'X17")

**NOTE:**  
REFER TO BASIC FLOOR PLAN FOR INFORMATION NOT SHOWN HERE

These designs and drawings are CONFIDENTIAL and the exclusive property of KB Home Corporation and are not to be disclosed without the express permission of KB Home Corporation. Copyright 2014 © KB Home Corporation. All rights reserved.



**NORTH CAROLINA  
40' SERIES**

KB HOME  
NORTH CAROLINA DIVISION  
4506 S. MIAMI BLVD.  
SUITE 180  
DURHAM, NC 27703  
TEL: (919) 768-7980  
FAX: (919) 544-2928

**2018 NORTH  
CAROLINA STATE  
BUILDING  
CODES**

ISSUE DATE: 06/02/15  
PROJECT No.: 1350999:56  
DIVISION MGR.: MCP  
REVISIONS: 05/07/19

- 1 DIVISION REVISIONS  
NC19024NCP - 08/24/18 - CTD
- 2 2018 CODE UPDATE  
NC19015NCP/ 03/15/19 / CTD
- 3 DIVISION REVISION  
NC19017NCP - 04/01/19 CTD
- 4 FRAMEWORK REVISIONS  
NC19033NCP - 05/07/19 - CTD

FOR INTERNAL USE ONLY	
REVIEWED BY:	
1.	
2.	
3.	
4.	
5.	
6.	

PLAN:  
**240.2596-R**  
SHEET:  
**4.1**

**SPEC. LEVEL 1  
RALEIGH-DURHAM  
40' SERIES**

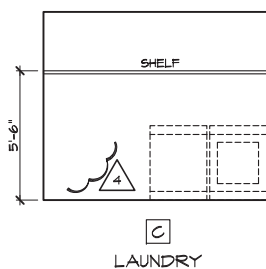
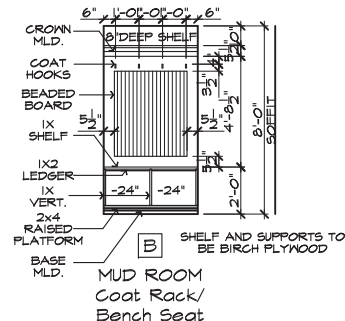
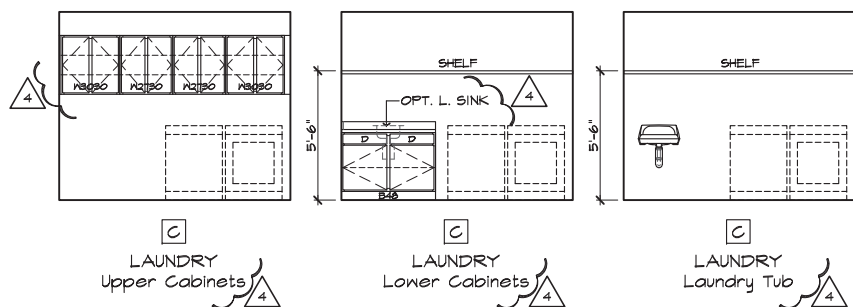

**INTERIOR ELEVATIONS**

**INTERIOR ELEVATIONS**

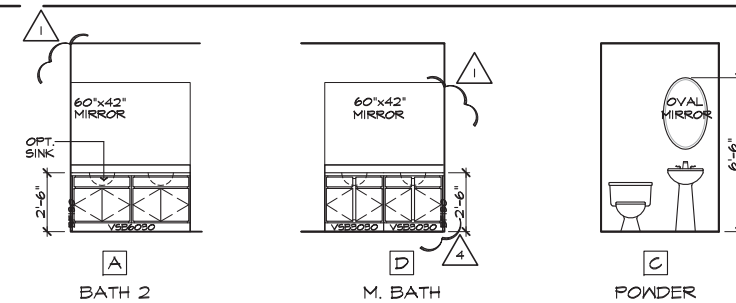
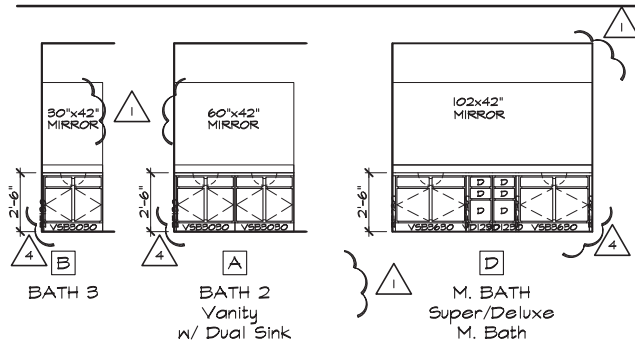

**BATH ELEVATIONS**

**BATH ELEVATIONS**

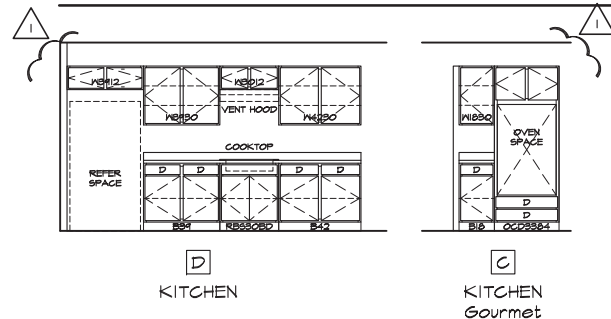

**KITCHEN ELEVATIONS**

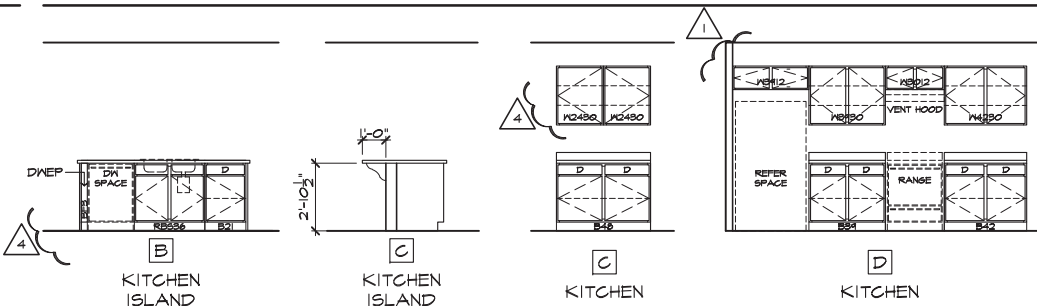

**KITCHEN ELEVATIONS**

**OPTIONAL INTERIOR ELEVATIONS**

**INTERIOR ELEVATIONS**

SCALE: 1/4"=1'-0" (22'x34") - 1/8"=1'-0" (11'x17")

SCALE: 1/4"=1'-0" (22'x34") - 1/8"=1'-0" (11'x17")

These designs and drawings are CONFIDENTIAL and the exclusive property of KB Home Corporation and are not to be disclosed without the express permission of KB Home Corporation. Copyright 2019 © KB Home Corporation, all rights reserved.





- # SECTION NOTES**
- NOTE: NOT ALL KEY NOTES APPLY.
1. ROOF MATERIAL - REFER TO ROOF NOTES
  2. ROOF PITCH - REFER TO ROOF NOTES
  3. PRE-MANUFACTURED WOOD ROOF TRUSS SYSTEM - SEE STRUCTURAL & TRUSS CALCS
  4. ROOF SHEATHING PER STRUCTURAL
  5. 2X FASCI/A/BARGE BOARD
  6. CONT. SOFFITED EAVE W/ VENTING
  7. 6:1 FLASHING - ROOF TO WALL
  8. EXTERIOR FINISH PER ELEVATIONS
  9. FLOOR FRAMING PER STRUCTURAL
  10. FLOOR SHEATHING PER STRUCTURAL
  11. HEADER PER STRUCTURAL
  12. FLUSH BEAM PER STRUCTURAL
  13. DROPPED BEAM PER STRUCTURAL
  14. FLAT/ ARCHED SOFFIT PER PLAN
  15. 2X4 STUD WALL
  16. 2X6 STUD WALL
  17. 2X6 BALLOON FRAMED WALL PER STRUCTURAL
  18. DBL. 2X4 WALL PER PLAN
  19. 2X CRIPPLES @ 16" O.C.
  20. 2X PRESSURE TREATED SILL PLATE
  21. 2X SOLE PLATE
  22. DBL. 2X TOP PLATE @ EXTERIOR & BEARING WALLS
  23. 1X OVER 2X TOP PLATE @ INTERIOR & NON-BEARING WALLS
  24. INSULATION MATERIAL PER ENERGY CALCULATIONS
  25. MIN. 36" HIGH GUARD - SEE PLAN FOR HEIGHT
  26. LOU' WALL - SEE PLAN FOR HEIGHT
  27. STAIR TREADS AND RISERS PER PLAN: - MIN. 10" TREAD & MAX. 7 3/4" RISER
  28. INTERIOR FINISH - MIN. 1/2" GYP. BD. @ WALLS & SAG RESISTANT OR 5/8" DRYWALL @ CEILING
  29. MIN. 1/2" GYP. BD. ON CEILING & WALLS @ USEABLE SPACE UNDER STAIRS.
  30. GARAGE SHALL BE SEPARATED FROM THE RESIDENCE AND ITS ATTIC AREA BY NOT LESS THAN 1/2" GYP. BD. @ GARAGE SIDE WALLS & 5/8" UNDER LIVING AREA U.N.O.
  31. MATERIAL TO UNDERSIDE OF ROOF SHEATHING
  32. INTERIOR SHELF - MIN. 1/2" GYP. BD. OVER 3/8" PLY WD.
  33. CONCRETE PATIO/ PORCH SLAB PER STRUCTURAL - SLOPE 1/4" PER FT. MIN.
  34. CONCRETE GARAGE SLAB PER STRUCTURAL - SLOPE 2" MIN.
  35. CONCRETE FOUNDATION PER STRUCTURAL
  36. LINE OF OPTIONAL TRAY CEILING/ STEP CEILING
  37. LINE OF OPTIONAL VOLUME CEILING
  38. PROFILE OF OPTIONAL COVERED PATIO
  39. EXTERIOR SOFFIT MATERIAL - REFER TO ELEVATIONS.
  40. 8" BLOCK WALL
  41. 5/8" TYPE-X DRYWALL @ GARAGE CEILING
  42. WHEN THERE IS USABLE SPACE ABOVE AND BELOW THE CONCEALED SPACE OF A FLOOR-CEILING ASSEMBLY IN A SINGLE-FAMILY DWELLING, DRAFT STOPS SHALL BE INSTALLED SO THAT THE AREA OF THE CONCEALED SPACE DOES NOT EXCEED 1000 SQUARE FEET. DRAFTSTOPPING SHALL DIVIDE THE CONCEALED SPACE INTO APPROXIMATELY EQUAL AREAS.

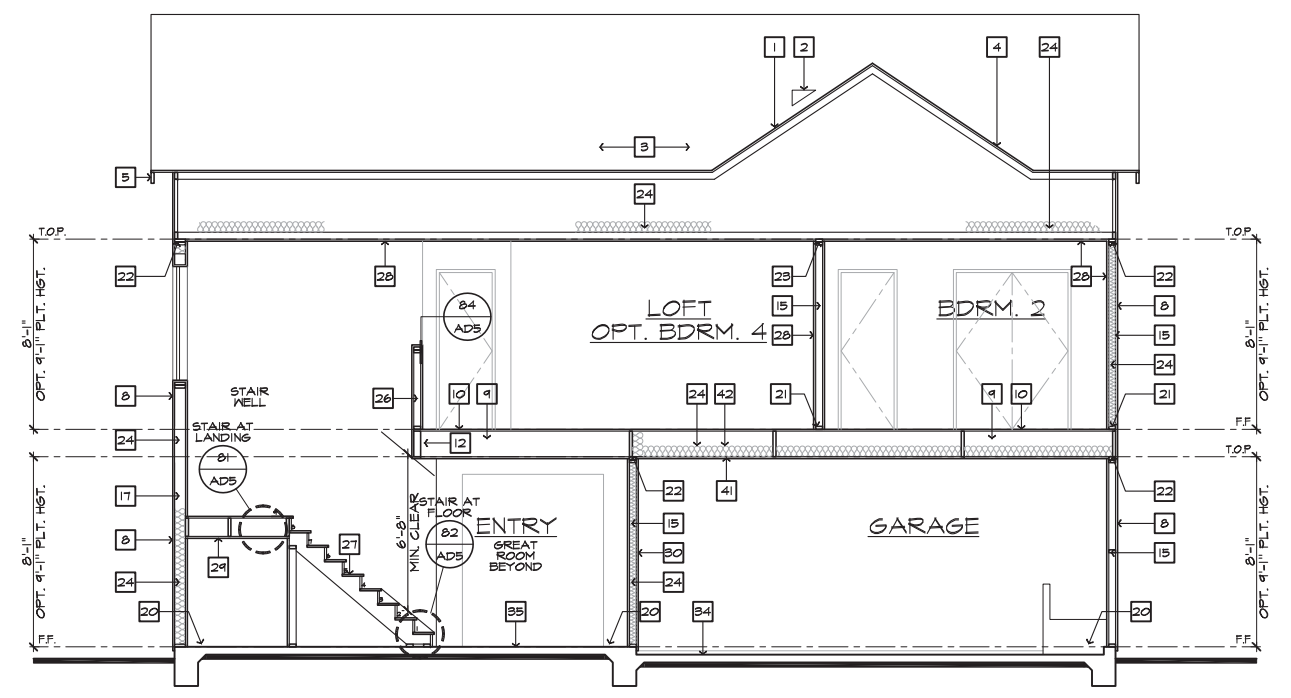

**SECTION "A"**  
SCALE 1/4"=1'-0" (22"X34") - 1/8"=1'-0" (11"X17")

AT SLAB-ON-GRADE

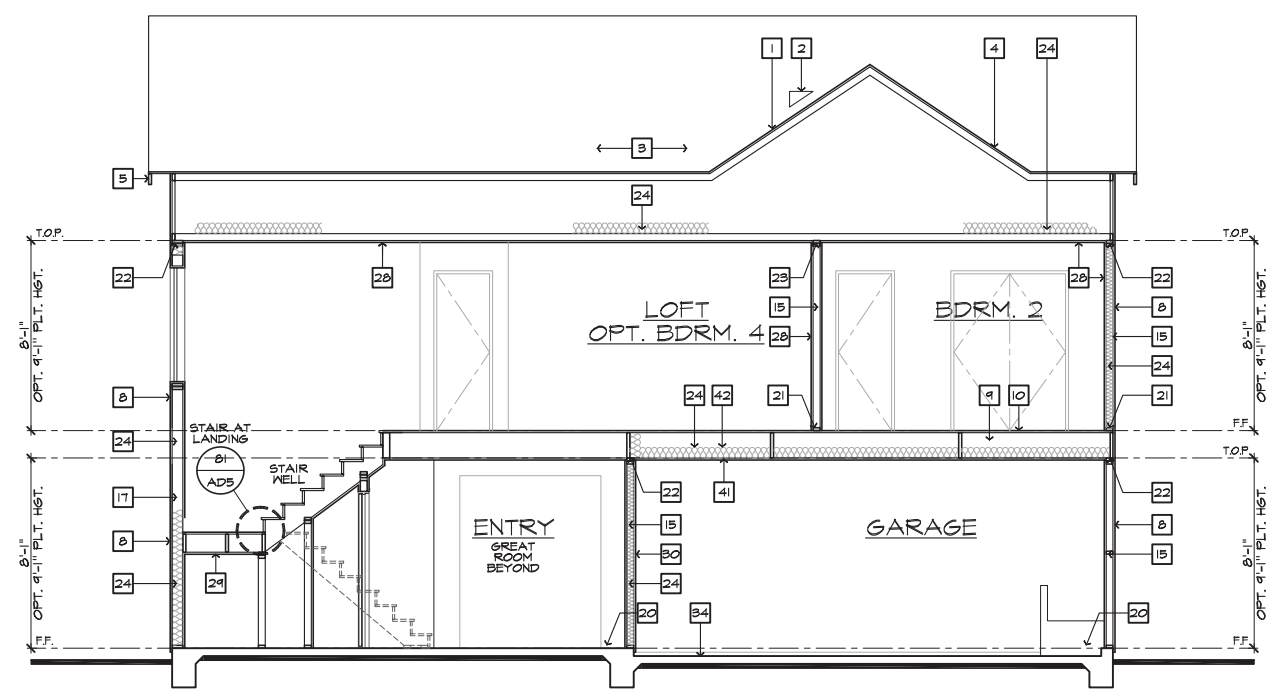

**SECTION "C"**  
SCALE 1/4"=1'-0" (22"X34") - 1/8"=1'-0" (11"X17")

AT SLAB-ON-GRADE

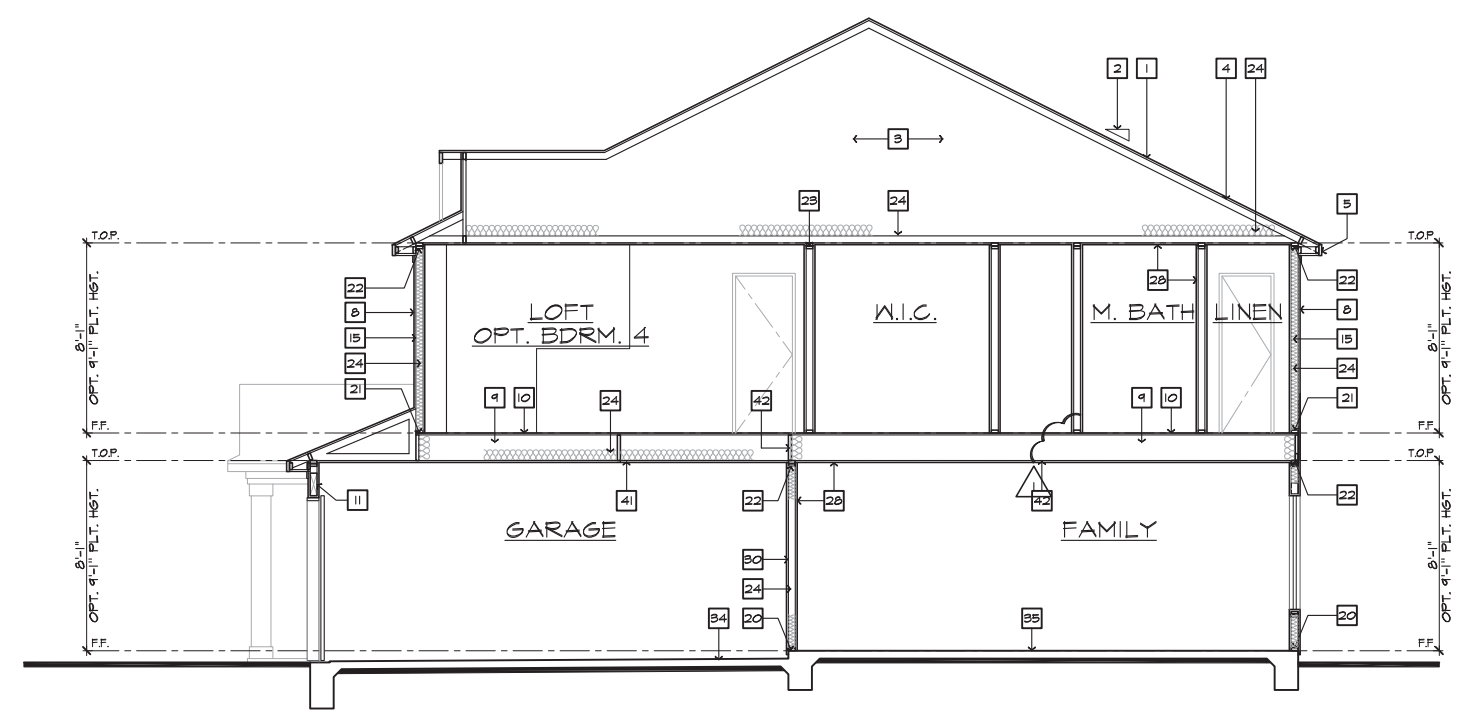

**SECTION "B"**  
SCALE 1/4"=1'-0" (22"X34") - 1/8"=1'-0" (11"X17")

AT SLAB-ON-GRADE

**NORTH CAROLINA  
40' SERIES**

KB HOME  
NORTH CAROLINA DIVISION  
4506 S. MIAMI BLVD.  
SUITE 180  
DURHAM, NC 27703  
TEL: (919) 768-7980  
FAX: (919) 544-2928

**2018 NORTH  
CAROLINA STATE  
BUILDING  
CODES**

ISSUE DATE: 06/02/15  
PROJECT No.: 1350999:56  
DIVISION MGR.: MCP  
REVISIONS: 05/07/19

- 1 DIVISION REVISIONS  
NC18054NCP - 08/24/18 - CTD
- 2 2018 CODE UPDATE  
NC19015NCP/ 03/15/19 / CTD
- 3 DIVISION REVISION  
NC19017NCP- 04/01/19 CTD
- 4 FRAMEWORK REVISIONS  
NC19033NCP- 05/07/19 - CTD

FOR INTERNAL USE ONLY

REVISION NO.	DATE	BY	DESCRIPTION

PLAN:  
**240.2596-R**  
SHEET:  
**4.2**

**SPEC. LEVEL 1  
RALEIGH-DURHAM  
40' SERIES**

These designs and drawings are CONFIDENTIAL and the exclusive property of KB Home Corporation and are not to be disclosed without the express permission of KB Home Corporation. Copyright 2019 © KB Home Corporation, all rights reserved.



**NORTH CAROLINA  
40' SERIES**

KB HOME  
NORTH CAROLINA DIVISION  
4506 S. MIAMI BLVD.  
SUITE 180  
DURHAM, NC 27703  
TEL: (919) 768-7980  
FAX: (919) 544-2928

**2018 NORTH  
CAROLINA STATE  
BUILDING  
CODES**

ISSUE DATE: 06/02/15  
PROJECT No.: 1350999:56  
DIVISION MGR.: MCP  
REVISIONS: 05/07/19

- 1 DIVISION REVISIONS  
NC18024NCF - 08/24/18 - CTD
- 2 2018 CODE UPDATE  
NC19015NCF / 03/15/19 / CTD
- 3 DIVISION REVISION  
NC19017NCF - 04/01/19 CTD
- 4 FRAMEWALL REVISIONS  
NC19033NCF - 05/07/19 - CTD

FOR INTERNAL USE ONLY	
REVISION BY:	
1.	
2.	
3.	
4.	
5.	
6.	

PLAN:  
**240.2596-R**  
SHEET:  
**5.1**

**SPEC. LEVEL 1  
RALEIGH-DURHAM  
40' SERIES**

**UTILITY LEGEND** 2018.16.01.2017.NEG

- ⊕ 120V DUPLEX CONVENIENCE RECEPTACLE  
ARC FAULT(AFCI) AND TAMPER RESISTANT(TR)  
12" ABV. FIN. FLR. TYPICAL UNO.
- ⊕ W/ GFI 120V (TR) RECEPTACLE W/ GFI CIRCUIT  
W/ WATER RESISTANT HOUSING
- ⊕ 6FI 120V (TR) RECEPTACLE W/ GFI CIRCUIT
- ⊕ FUSED DISCONNECT
- 120V (AFCI & TR) RECESSED FLOOR  
RECEPTACLE W/ COVER
- ⊕ 120V (AFCI & TR) DUPLEX CONVENIENCE RECEPTACLE  
SWITCH CONTROLLED, 1/2 HOT
- ⊕ 220 v 220V SINGLE CONVENIENCE RECEPTACLE  
HEIGHT NOTED AS PER PLAN
- ⊕ 2 TWO-POLE LIGHT SWITCH AT 42" ABV. FIN. FLR.  
8" ABOVE COUNTER UNO.
- ⊕ 3 THREE-POLE LIGHT SWITCH
- ⊕ 4 FOUR-POLE LIGHT SWITCH
- ⊕ W.P. WALL MOUNTED LIGHT FIXTURE  
W/ WATER RESISTANT HOUSING
- ⊕ WALL MOUNTED INCANDESCENT  
LIGHT FIXTURE
- ⊕ WALL MOUNTED FLUORESCENT  
LIGHT FIXTURE
- ⊕ CEILING MOUNTED INCANDESCENT  
LIGHT FIXTURE
- ⊕ CEILING MOUNTED FLUORESCENT  
LIGHT FIXTURE
- ⊕ HANGINGS INCANDESCENT  
LIGHT FIXTURE
- ⊕ RECESSED INCANDESCENT DIRECTIONAL  
LIGHT FIXTURE (EYE BALL)
- ⊕ RECESSED INCANDESCENT LIGHT FIXTURE  
LIGHTING - TRAVERSE II LED FIXTURE - PER  
SPECS
- ⊕ W.P. RECESSED INCANDESCENT LIGHT FIXTURE  
W/ WATER RESISTANT HOUSING
- ⊕ RECESSED FLUORESCENT LIGHT FIXTURE
- ⊕ RECESSED EXHAUST FAN
- ⊕ RECESSED EXHAUST FAN/ INCANDESCENT  
LIGHT COMBINATION
- ⊕ RECESSED EXHAUST FAN/ FLUORESCENT  
LIGHT COMBINATION
- ⊕ INCANDESCENT WALL SCONCE
- ⊕ ILLUMINATED ADDRESS SIGN - VISIBLE  
FROM STREET

24"x48" FLUORESCENT LIGHT  
BOX (CEILING MOUNTED)

12"x48" FLUORESCENT LIGHT  
BOX (CEILING MOUNTED)

- ⊕ OPTIONAL PRE-WIRED CEILING FAN  
AND SWITCH - LOCATED IN CENTER OF ROOM UNO.
- ⊕ CEILING MOUNTED JUNCTION BOX
- ⊕ WALL MOUNTED JUNCTION BOX
- ⊕ DOOR CHIME
- ⊕ CATV RECEPTACLE
- ⊕ PUSH BUTTON
- ⊕ PHONE OUTLET
- ⊕ SERVICE BOX
- ⊕ HOSE BIB
- ⊕ HOSE BIB W/ S.O.V.
- ⊕ WATER STUB FOR ICE MAKER
- ⊕ APPROVED CEILING MOUNTED  
SMOKE DETECTOR TO BE HARD WIRED  
WITH BATTERY BACK-UP AND INTERCONNECTED
- ⊕ APPROVED CARBON MONOXIDE ALARM/ SMOKE DET.
- ⊕ THERMOSTAT (VERIFY LOCATION W/ HVAC PLAN)
- ⊕ GAS TAP
- ⊕ GAS KEY - FIREPLACE GAS VALVES SHALL BE  
LOCATED OUTSIDE OF REQUIRED HEARTH AREA,  
BUT NO MORE THAN 48" FROM GAS OUTLET

SWITCHING FOR  
ROOMS W/ CLS. FAN  
OPTIONS

24" MIN. SEPARATION  
OF ELECTRICAL BOXES  
AS SHOWN BELOW

⊕ DWELLING

2'-0" MIN.

⊕ GARAGE

**NOTES**

- MECHANICAL, ELECTRICAL AND PLUMBING SYSTEMS ARE SHOWN FOR INTENT ONLY. THESE SYSTEMS SHALL BE ENGINEERED BY OTHERS. THE CONTRACTOR SHALL BE RESPONSIBLE FOR PROPER INSTALLATION AND PLACEMENT. ALL HEIGHTS SHOWN ARE TO CENTERLINE OF FIXTURE.
- PROVIDE SWITCH, LIGHT, 120V (AFCI & TR) DUPLEX RECEPTACLE & FUEL GAS STUB OR 220V RECEPTACLE IN ATTIC FOR F.A.U. - PER COMMUNITY SPECIFICATIONS.
- SMOKE DETECTORS IN ROOMS WITH VOLUME CEILING TO BE LOCATED AT HIGHEST POINT OF CEILING
- 20 FOOT #4 REBAR FOR UFER GROUND AND ADDITIONAL COLD WATER GROUND. REFER TO SLAB INTERFACE PLAN FOR LOCATION.
- 200 AMP ELECTRICAL PANEL (DEFAULT). ELECTRICAL PLAN CHECK PERMIT REQUIRED IF LOAD EXCEED 400 AMPS.

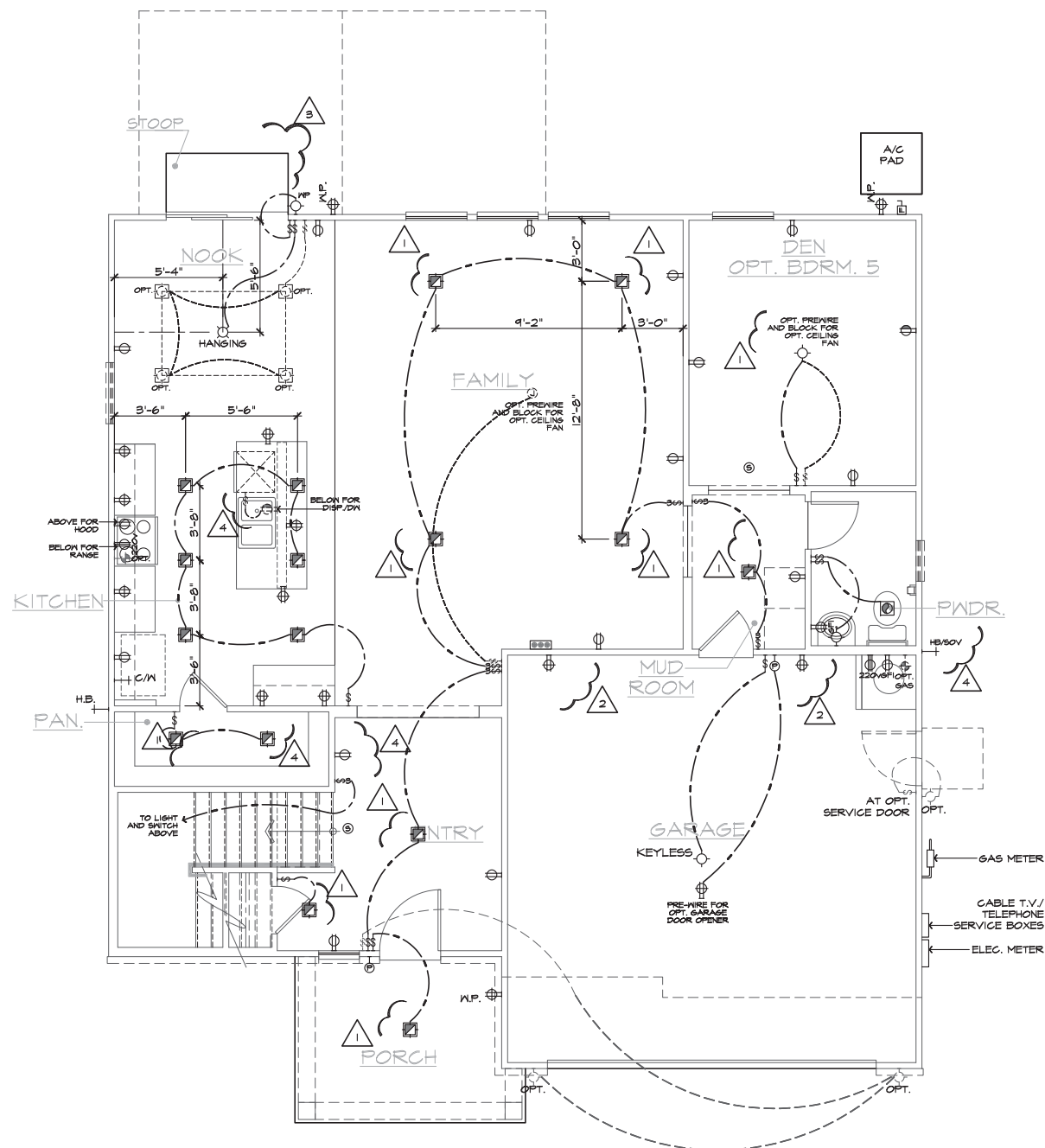

**FIRST FLOOR UTILITY PLAN**  
SCALE 1/4"=1'-0" (22'x34') - 1/8"=1'-0" (11'x17')

BASIC PLAN

These designs and drawings are CONFIDENTIAL and the exclusive property of KB Home Corporation and are not to be disclosed without the express permission of KB Home Corporation. Copyright 2019 © KB Home Corporation. All rights reserved.





**NORTH CAROLINA  
40' SERIES**

KB HOME  
NORTH CAROLINA DIVISION  
4506 S. MIAMI BLVD.  
SUITE 180  
DURHAM, NC 27703  
TEL: (919) 768-7980  
FAX: (919) 544-2928

**2018 NORTH  
CAROLINA STATE  
BUILDING  
CODES**

ISSUE DATE: 06/02/15  
PROJECT No.: 1350999:56  
DIVISION MGR.: MCP  
REVISIONS: 05/07/19

- 1 DIVISION REVISIONS  
NC18024NCP - 02/24/18 - CTD
- 2 2018 CODE UPDATE  
NC19015NCP/ 03/15/19 / CTD
- 3 DIVISION REVISION  
NC19017NCP - 04/01/19 CTD
- 4 FRAMERWALL REVISIONS  
NC19033NCP - 05/07/19 - CTD

FOR INTERNAL USE ONLY	
REVISION BY:	
1.	
2.	
3.	
4.	
5.	
6.	

PLAN:  
**240.2596-R**  
SHEET:  
**5.2**

**SPEC. LEVEL 1  
RALEIGH-DURHAM  
40' SERIES**

**UTILITY LEGEND**

- ⊕ 120V DUPLEX CONVENIENCE RECEPTACLE  
ARC FAULT(AFCI) AND TAMPER RESISTANT(TR)  
12" ABV. FIN. FLR. TYPICAL UNO.
- ⊕ W/ GFI 120V (TR) RECEPTACLE W/ GFI CIRCUIT  
W/ WATER RESISTANT HOUSING
- ⊕ 6FI 120V (TR) RECEPTACLE W/ GFI CIRCUIT
- ⊕ FUSED DISCONNECT
- 120V (AFCI & TR) RECESSED FLOOR  
RECEPTACLE W/ COVER
- ⊕ 120V (AFCI & TR) DUPLEX CONVENIENCE RECEPTACLE  
SWITCH CONTROLLED, 1/2 HOT
- ⊕ 220 v 220V SINGLE CONVENIENCE RECEPTACLE  
HEIGHT NOTED AS PER PLAN
- ⊕ 2 TWO-POLE LIGHT SWITCH AT 42" ABV. FIN. FLR.  
8" ABOVE COUNTER UNO.
- ⊕ 3 THREE-POLE LIGHT SWITCH
- ⊕ 4 FOUR-POLE LIGHT SWITCH
- ⊕ W.P. WALL MOUNTED LIGHT FIXTURE  
W/ WATER RESISTANT HOUSING
- ⊕ WALL MOUNTED INCANDESCENT  
LIGHT FIXTURE
- ⊕ WALL MOUNTED FLUORESCENT  
LIGHT FIXTURE
- ⊕ CEILING MOUNTED INCANDESCENT  
LIGHT FIXTURE
- ⊕ CEILING MOUNTED FLUORESCENT  
LIGHT FIXTURE
- ⊕ HANGINGS INCANDESCENT  
LIGHT FIXTURE
- ⊕ RECESSED INCANDESCENT DIRECTIONAL  
LIGHT FIXTURE (EYE BALL)
- ⊕ RECESSED INCANDESCENT LIGHT FIXTURE  
LIGHTING - TRAVERSE II LED FIXTURE - PER  
SPECS
- ⊕ W.P. RECESSED INCANDESCENT LIGHT FIXTURE  
W/ WATER RESISTANT HOUSING
- ⊕ RECESSED FLUORESCENT LIGHT FIXTURE
- ⊕ RECESSED EXHAUST FAN
- ⊕ RECESSED EXHAUST FAN/ INCANDESCENT  
LIGHT COMBINATION
- ⊕ RECESSED EXHAUST FAN/ FLUORESCENT  
LIGHT COMBINATION
- ⊕ INCANDESCENT WALL SCONCE
- ⊕ ILLUMINATED ADDRESS SIGN - VISIBLE  
FROM STREET
- ⊕ 24"x48" FLUORESCENT LIGHT  
BOX (CEILING MOUNTED)
- ⊕ 12"x48" FLUORESCENT LIGHT  
BOX (CEILING MOUNTED)
- ⊕ OPTIONAL PRE-WIRED CEILING FAN  
AND SWITCH - LOCATED IN CENTER OF ROOM UNO.
- ⊕ CEILING MOUNTED JUNCTION BOX
- ⊕ WALL MOUNTED JUNCTION BOX
- ⊕ DOOR CHIME
- ⊕ CATV RECEPTACLE
- ⊕ PUSH BUTTON
- ⊕ PHONE OUTLET
- ⊕ SERVICE BOX
- ⊕ HOSE BIB
- ⊕ HOSE BIB W/ S.O.V.
- ⊕ WATER STUB FOR ICE MAKER
- ⊕ APPROVED CEILING MOUNTED  
SMOKE DETECTOR TO BE HARD WIRED  
WITH BATTERY BACK-UP AND INTERCONNECTED
- ⊕ APPROVED CARBON MONOXIDE ALARM/ SMOKE DET.
- ⊕ THERMOSTAT (VERIFY LOCATION W/ HVAC PLAN)
- ⊕ GAS TAP
- ⊕ GAS KEY - FIREPLACE GAS VALVES SHALL BE  
LOCATED OUTSIDE OF REQUIRED HEARTH AREA,  
BUT NO MORE THAN 48" FROM GAS OUTLET

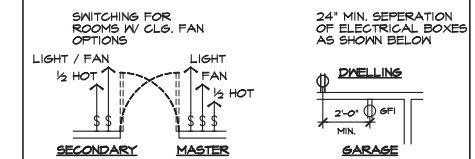

- NOTES**
- MECHANICAL, ELECTRICAL AND PLUMBING SYSTEMS ARE SHOWN FOR INTENT ONLY. THESE SYSTEMS SHALL BE ENGINEERED BY OTHERS. THE CONTRACTOR SHALL BE RESPONSIBLE FOR PROPER INSTALLATION AND PLACEMENT. ALL HEIGHTS SHOWN ARE TO CENTERLINE OF FIXTURE.
  - PROVIDE SWITCH, LIGHT, 120V (AFCI & TR) DUPLEX RECEPTACLE & FUEL GAS STUB OR 220V RECEPTACLE IN ATTIC FOR F.A.U. - PER COMMUNITY SPECIFICATIONS.
  - SMOKE DETECTORS IN ROOMS WITH VOLUME CEILING TO BE LOCATED AT HIGHEST POINT OF CEILING
  - 20 FOOT #4 REBAR FOR UFER GROUND AND ADDITIONAL COLD WATER GROUND. REFER TO SLAB INTERFACE PLAN FOR LOCATION.
  - 200 AMP ELECTRICAL PANEL (DEFAULT). ELECTRICAL PLAN CHECK PERMIT REQUIRED IF LOAD EXCEED 400 AMPS.

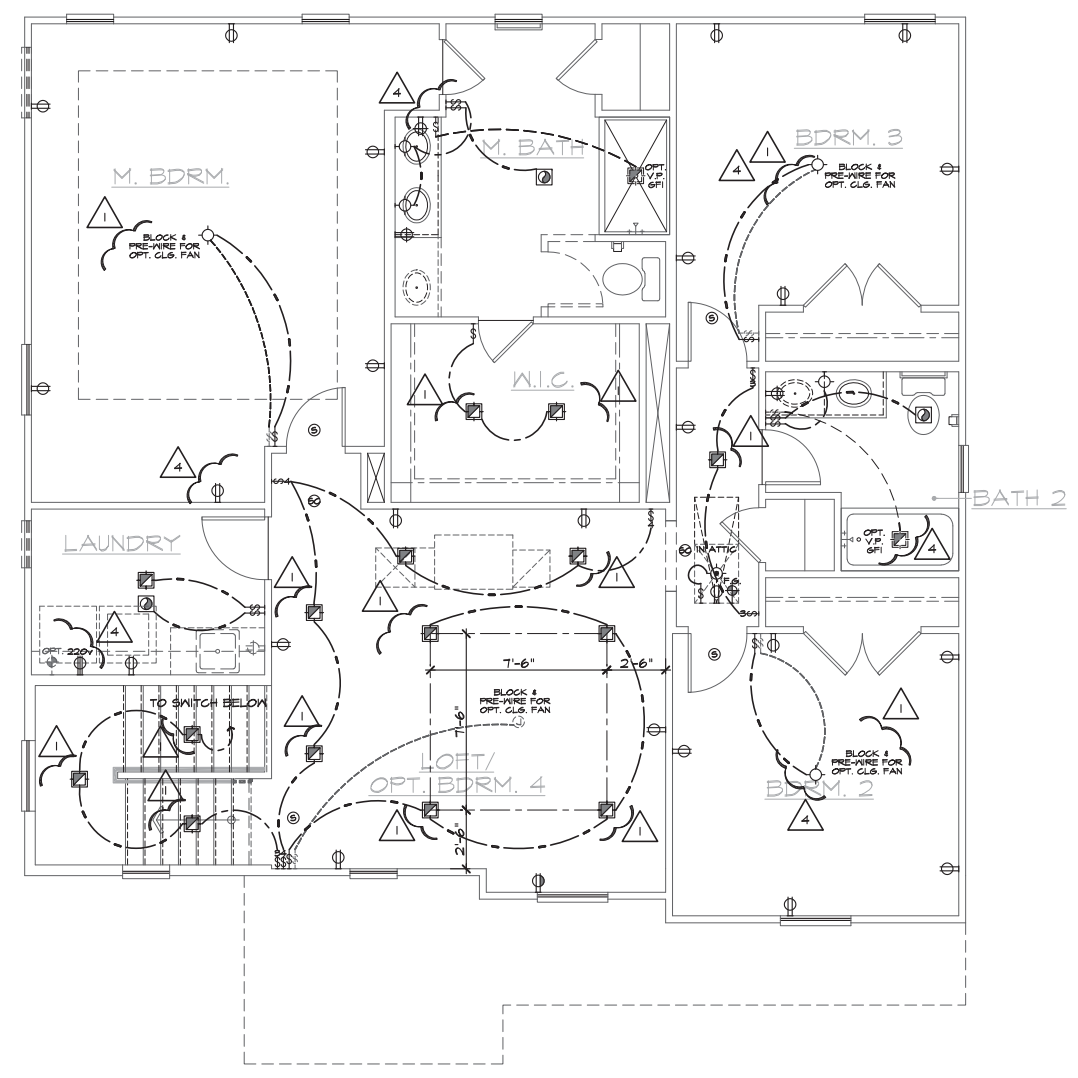

**SECOND FLOOR UTILITY PLAN**  
SCALE 1/4"=1'-0" (22"x34") - 1/8"=1'-0" (11"x17") BASIC PLAN

These designs and drawings are CONFIDENTIAL, and the exclusive property of KB Home Corporation, and are not to be disclosed without the express permission of KB Home Corporation. Copyright 2019 © KB Home Corporation. All rights reserved.



# NORTH CAROLINA 40' SERIES

KB HOME  
NORTH CAROLINA DIVISION  
4506 S. MIAMI BLVD.  
SUITE 180  
DURHAM, NC 27703  
TEL: (919) 768-7980  
FAX: (919) 544-2928

# 2018 NORTH CAROLINA STATE BUILDING CODES

ISSUE DATE: 06/02/15  
PROJECT No.: 1350999:56  
DIVISION MGR.: MCP  
REVISIONS: 05/07/19

- 1 DIVISION REVISIONS  
NC18024NCP - 02/24/18 - CTD
- 2 2018 CODE UPDATE  
NC19015NCP/ 03/15/19 / CTD
- 3 DIVISION REVISION  
NC19017NCP- 04/01/19 CTD
- 4 FRAMEWALK REVISIONS  
NC19033NCP- 05/07/19 - CTD

FOR INTERNAL USE ONLY	
REVISION NO.	DATE
1.	
2.	
3.	
4.	
5.	
6.	

PLAN:  
**240.2596-R**  
SHEET:  
**53**

# SPEC. LEVEL 1 RALEIGH-DURHAM 40' SERIES

UTILITY LEGEND	
	120V DUPLEX CONVENIENCE RECEPTACLE
	ARC FAULT (AFCI) AND TAMPER RESISTANT (TR) 12" ABV. FIN. FLR. TYPICAL U.N.O.
	120V (TR) RECEPTACLE W/ GFI CIRCUIT W/ WATER RESISTANT HOUSING
	120V (TR) RECEPTACLE W/ GFI CIRCUIT
	FUSED DISCONNECT
	120V (AFCI) & (TR) RECESSED FLOOR RECEPTACLE W/ COVER
	120V (AFCI) & (TR) DUPLEX CONVENIENCE RECEPTACLE SWITCH CONTROLLED, 1/2 HOT
	220V SINGLE CONVENIENCE RECEPTACLE HEIGHT NOTED AS PER PLAN
	TWO-POLE LIGHT SWITCH AT 42" ABV. FIN. FLR. 8" ABOVE COUNTER U.N.O.
	THREE-POLE LIGHT SWITCH
	FOUR-POLE LIGHT SWITCH
	WALL MOUNTED LIGHT FIXTURE W/ WATER RESISTANT HOUSING
	WALL MOUNTED INCANDESCENT LIGHT FIXTURE
	WALL MOUNTED FLUORESCENT LIGHT FIXTURE
	CEILING MOUNTED INCANDESCENT LIGHT FIXTURE
	CEILING MOUNTED FLUORESCENT LIGHT FIXTURE
	HANGING INCANDESCENT LIGHT FIXTURE
	RECESSED INCANDESCENT DIRECTIONAL LIGHT FIXTURE (EYE BALL)
	RECESSED INCANDESCENT LIGHT FIXTURE
	LIGHTING - TRAVERSE II LED FIXTURE - PER SPECS
	RECESSED INCANDESCENT LIGHT FIXTURE W/ WATER RESISTANT HOUSING
	RECESSED FLUORESCENT LIGHT FIXTURE
	RECESSED EXHAUST FAN
	RECESSED EXHAUST FAN/ INCANDESCENT LIGHT COMBINATION
	RECESSED EXHAUST FAN/ FLUORESCENT LIGHT COMBINATION
	INCANDESCENT WALL SCONCE
	ILLUMINATED ADDRESS SIGN - VISIBLE FROM STREET
	24"x48" FLUORESCENT LIGHT BOX (CEILING MOUNTED)
	12"x48" FLUORESCENT LIGHT BOX (CEILING MOUNTED)
	OPTIONAL PRE-WIRED CEILING FAN AND SWITCH - LOCATED IN CENTER OF ROOM U.N.O.
	CEILING MOUNTED JUNCTION BOX
	WALL MOUNTED JUNCTION BOX
	DOOR CHIME
	CATV RECEPTACLE
	PUSH BUTTON
	PHONE OUTLET
	SERVICE BOX
	HOSE BIB
	HOSE BIB W/ S.O.V.
	WATER STUB FOR ICE MAKER
	APPROVED CEILING MOUNTED SMOKE DETECTOR TO BE HARD WIRED WITH BATTERY BACK-UP AND INTERCONNECTED
	APPROVED CARBON MONOXIDE ALARM/ SMOKE DET.
	THERMOSTAT (VERIFY LOCATION W/ HVAC PLAN)
	GAS TAP
	GAS KEY - FIREPLACE GAS VALVES SHALL BE LOCATED OUTSIDE OF REQUIRED HEARTH AREA, BUT NO MORE THAN 48" FROM GAS OUTLET
	SWITCHING FOR ROOMS W/ CLG. FAN OPTIONS
	24" MIN. SEPARATION OF ELECTRICAL BOXES AS SHOWN BELOW

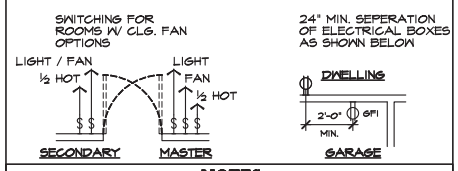
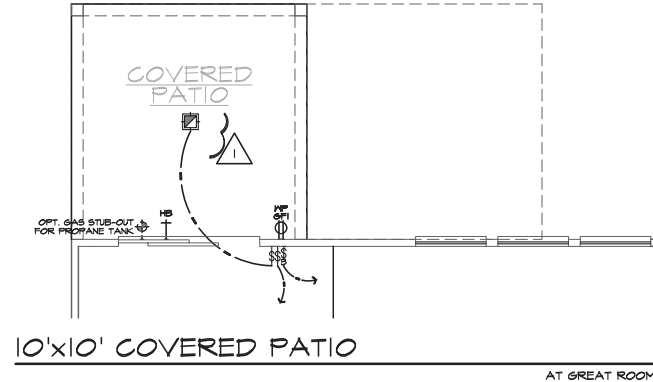

- ### NOTES
- MECHANICAL, ELECTRICAL AND PLUMBING SYSTEMS ARE SHOWN FOR INTENT ONLY. THESE SYSTEMS SHALL BE ENGINEERED BY OTHERS. THE CONTRACTOR SHALL BE RESPONSIBLE FOR PROPER INSTALLATION AND PLACEMENT. ALL HEIGHTS SHOWN ARE TO CENTERLINE OF FIXTURE.
  - PROVIDE SWITCH, LIGHT, 120V (AFCI & TR) DUPLEX RECEPTACLE & FUEL GAS STUB OR 220V RECEPTACLE IN ATTIC FOR F.A.U. - PER COMMUNITY SPECIFICATIONS.
  - SMOKE DETECTORS IN ROOMS WITH VOLUME CEILING TO BE LOCATED AT HIGHEST POINT OF CEILING
  - 20 FOOT #4 REBAR FOR UFER GROUND AND ADDITIONAL COLD WATER GROUND. REFER TO SLAB INTERFACE PLAN FOR LOCATION.
  - 200 AMP ELECTRICAL PANEL (DEFAULT). ELECTRICAL PLAN CHECK PERMIT REQUIRED IF LOAD EXCEED 400 AMPS.

These designs and drawings are CONFIDENTIAL, and the exclusive property of KB Home Corporation and are not to be disclosed without the express permission of KB Home Corporation. Copyright 2019 © KB Home Corporation, all rights reserved.





**NORTH CAROLINA  
40' SERIES**

KB HOME  
NORTH CAROLINA DIVISION  
4506 S. MIAMI BLVD.  
SUITE 180  
DURHAM, NC 27703  
TEL: (919) 768-7980  
FAX: (919) 544-2928

**2018 NORTH  
CAROLINA STATE  
BUILDING  
CODES**

ISSUE DATE: 06/02/15  
PROJECT No.: 1350999:56  
DIVISION MGR.: MCP  
REVISIONS: 05/07/19

- 1 DIVISION REVISIONS  
NC18024NCF - 06/24/18 - CTD
- 2 2018 CODE UPDATE  
NC19015NCF / 03/15/19 / CTD
- 3 DIVISION REVISION  
NC19017NCF - 04/01/19 CTD
- 4 FRAMEWORK REVISIONS  
NC19033NCF - 05/07/19 - CTD

FOR INTERNAL USE ONLY	
REVISION NO.	DATE
1.	
2.	
3.	
4.	
5.	
6.	

PLAN:  
**240.2596-R**  
SHEET:  
**5.4**

**SPEC. LEVEL 1  
RALEIGH-DURHAM  
40' SERIES**

**UTILITY LEGEND**

- ⊕ 120V DUPLEX CONVENIENCE RECEPTACLE  
ARC FAULT(AFCI) AND TAMPER RESISTANT(TR)  
12" ABV. FIN. FLR. TYPICAL UNO.
- ⊕ W P 6PFI 120V (TR) RECEPTACLE W/ 6PFI CIRCUIT  
W/ WATER RESISTANT HOUSING
- ⊕ 6PFI 120V (TR) RECEPTACLE W/ 6PFI CIRCUIT
- ⊕ FUSED DISCONNECT
- 120V (AFCI & TR) RECESSED FLOOR  
RECEPTACLE W/ COVER
- ⊕ 120V (AFCI & TR) DUPLEX CONVENIENCE RECEPTACLE  
SWITCH CONTROLLED, 1/2 HOT
- ⊕ 220 v 220V SINGLE CONVENIENCE RECEPTACLE  
HEIGHT NOTED AS PER PLAN
- ⊕ 3 TWO-POLE LIGHT SWITCH AT 42" ABV. FIN. FLR.  
8" ABOVE COUNTER UNO.
- ⊕ 3 THREE-POLE LIGHT SWITCH
- ⊕ 4 FOUR-POLE LIGHT SWITCH
- ⊕ W.P. WALL MOUNTED LIGHT FIXTURE  
W/ WATER RESISTANT HOUSING
- ⊕ WALL MOUNTED INCANDESCENT  
LIGHT FIXTURE
- ⊕ WALL MOUNTED FLUORESCENT  
LIGHT FIXTURE
- ⊕ CEILING MOUNTED INCANDESCENT  
LIGHT FIXTURE
- ⊕ CEILING MOUNTED FLUORESCENT  
LIGHT FIXTURE
- ⊕ HANGINGS INCANDESCENT  
LIGHT FIXTURE
- ⊕ RECESSED INCANDESCENT DIRECTIONAL  
LIGHT FIXTURE (EYE BALL)
- ⊕ RECESSED INCANDESCENT LIGHT FIXTURE  
LIGHTING - TRAVERSE II LED FIXTURE - PER  
SPECS
- ⊕ W.P. RECESSED INCANDESCENT LIGHT FIXTURE  
W/ WATER RESISTANT HOUSING
- ⊕ RECESSED FLUORESCENT LIGHT FIXTURE
- ⊕ RECESSED EXHAUST FAN
- ⊕ RECESSED EXHAUST FAN/ INCANDESCENT  
LIGHT COMBINATION
- ⊕ RECESSED EXHAUST FAN/ FLUORESCENT  
LIGHT COMBINATION
- ⊕ INCANDESCENT WALL SCONCE
- ⊕ ILLUMINATED ADDRESS SIGN - VISIBLE  
FROM STREET
- ⊕ 24"x48" FLUORESCENT LIGHT  
BOX (CEILING MOUNTED)
- ⊕ 12"x48" FLUORESCENT LIGHT  
BOX (CEILING MOUNTED)
- ⊕ OPTIONAL PRE-WIRED CEILING FAN  
AND SWITCH - LOCATED IN CENTER OF ROOM UNO.
- ⊕ CEILING MOUNTED JUNCTION BOX
- ⊕ WALL MOUNTED JUNCTION BOX
- ⊕ DOOR CHIME
- ⊕ CATV RECEPTACLE
- ⊕ PUSH BUTTON
- ⊕ PHONE OUTLET
- ⊕ SERVICE BOX
- ⊕ HOSE BIB
- ⊕ HOSE BIB W/ S.O.V.
- ⊕ WATER STUB FOR ICE MAKER
- ⊕ APPROVED CEILING MOUNTED  
SMOKE DETECTOR TO BE HARD WIRED  
WITH BATTERY BACK-UP AND INTERCONNECTED
- ⊕ APPROVED CARBON MONOXIDE ALARM/ SMOKE DET.
- ⊕ THERMOSTAT (VERIFY LOCATION W/ HVAC PLAN)
- ⊕ GAS TAP
- ⊕ GAS KEY - FIREPLACE GAS VALVES SHALL BE  
LOCATED OUTSIDE OF REQUIRED HEARTH AREA,  
BUT NO MORE THAN 48" FROM GAS OUTLET

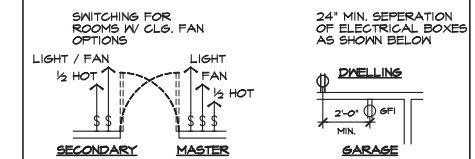

- NOTES**
- MECHANICAL, ELECTRICAL AND PLUMBING SYSTEMS ARE SHOWN FOR INTENT ONLY. THESE SYSTEMS SHALL BE ENGINEERED BY OTHERS. THE CONTRACTOR SHALL BE RESPONSIBLE FOR PROPER INSTALLATION AND PLACEMENT. ALL HEIGHTS SHOWN ARE TO CENTERLINE OF FIXTURE.
  - PROVIDE SWITCH, LIGHT, 120V (AFCI & TR) DUPLEX RECEPTACLE & FUEL GAS STUB OR 220V RECEPTACLE IN ATTIC FOR F.A.U. - PER COMMUNITY SPECIFICATIONS.
  - SMOKE DETECTORS IN ROOMS WITH VOLUME CEILING TO BE LOCATED AT HIGHEST POINT OF CEILING
  - 20 FOOT #4 REBAR FOR UFER GROUND AND ADDITIONAL COLD WATER GROUND. REFER TO SLAB INTERFACE PLAN FOR LOCATION.
  - 200 AMP ELECTRICAL PANEL (DEFAULT). ELECTRICAL PLAN CHECK PERMIT REQUIRED IF LOAD EXCEED 400 AMPS.

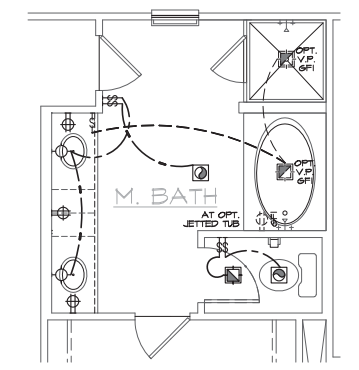

**SUPER M. BATH**  
AT M. BATH

These designs and drawings are CONFIDENTIAL and the exclusive property of KB Home Corporation and are not to be disclosed without the express permission of KB Home Corporation. Copyright 2019 © KB Home Corporation. All rights reserved.



**NORTH CAROLINA  
40' SERIES**

KB HOME  
NORTH CAROLINA DIVISION  
4506 S. MIAMI BLVD.  
SUITE 180  
DURHAM, NC 27703  
TEL: (919) 768-7980  
FAX: (919) 544-2928

**2018 NORTH  
CAROLINA STATE  
BUILDING  
CODES**

ISSUE DATE: 06/02/15  
PROJECT No.: 1350999:56  
DIVISION MGR.: MCP  
REVISIONS: 05/07/19

- 1 DIVISION REVISIONS NC18024NCP - 08/24/18 - CTD
- 2 2018 CODE UPDATE NC19015NCP/ 03/15/19 / CTD
- 3 DIVISION REVISION NC19017NCP- 04/01/19 CTD
- 4 FRAMEWORK REVISIONS NC19033NCP- 05/07/19 - CTD

FOR INTERNAL USE ONLY	
REVISION BY:	
1.	
2.	
3.	
4.	
5.	
6.	

PLAN:  
**240.2596-R**  
SHEET:  
**8.1**

**SPEC. LEVEL 1  
RALEIGH-DURHAM  
40' SERIES**

- # ELEVATION NOTES**
- NOTE: NOT ALL KEY NOTES APPLY.
- ROOF MATERIAL - REFER TO ROOF NOTES
  - 2X FASCIA/BARGE BOARD WITH FASCIA CAP
  - 6:12 FLASHING
  - 6:12 FLASHING & SADDLE/CRICKET
  - 6:12 DRIP SCREED
  - 24"x24" CHIMNEY
  - DECORATIVE VENT
  - DECORATIVE CORBEL
  - DECORATIVE SHUTTERS
  - PEDIMENT, SEE ELEVATION FOR TYPE
  - RECESSED ELEMENT
  - DECORATIVE TRIM FYPON OR EQ. SEE ELEVATION FOR TYPE
  - TRIM - SEE ELEVATION FOR SIZE
  - SYNTHETIC MATERIAL
  - PRE-MANUFACTURED DECORATIVE COLUMN (SIZE, SEE ELEV.) FYPON OR EQ. SURROUNDING STRUCTURAL POST.
  - SITE-BUILT COLUMN - SEE ELEVATION FOR TYPE
  - SHAKE SIDING
  - STONE VENEER PER SPECS
  - BRICK/MASONRY VENEER PER SPECS
  - BUILT UP BRICK COLUMN
  - SOLDIER COURSE
  - ROWLOCK COURSE
  - FRIEZE BOARD
  - SIDING W/ 4" CORNER TRIM PER SPECS
  - P.T. POST W/ WRAP - SEE STRUCTURAL FOR SIZE
  - PRE-FAB DECORATIVE TRIM
  - LIGHT WEIGHT PRECAST STONE TRIM
  - RAILINGS (48" U.N.O.)
  - VINYL WRAP
  - DECORATIVE WINDOW/DOOR TRIM - FYPON OR EQ. SEE ELEVATION FOR SIZE.
  - BRACKET OR KICKER - FYPON OR EQ.
  - ENTRY DOOR
  - CONCRETE STOOP/ PORCH - SEE SLAB INTERFACE PLAN.
  - SECTIONAL GARAGE DOOR PER SPECS
  - ALUMINUM WRAP
  - OPTIONAL DOOR/WINDOW - REFER TO PLAN OPTIONS
  - OPTIONAL STANDING SEAM METAL ROOF
  - KEYSTONE
  - SOLDIER CROWN
  - JACK SOLDIER COURSE
  - WATER TABLE
  - ATRIM DOOR
  - PILASTER - SEE ELEVATION FOR TYPE

- # PARTIAL PLAN NOTES**
- NOTE: NOT ALL KEY NOTES APPLY.
- WATER HEATER LOCATION - FOR GAS - LOCATE ON 18" HIGH PLATFORM - FOR INTERIOR LOCATION - PROVIDE PAN & DRAIN (REFER TO DETAILS)
  - WATER HEATER 'B' VENT TO OUTSIDE AIR
  - MAIN LINE SHUT-OFF VALVE AND TEMP. & PRESSURE RELIEF VALVE
  - LINE OF WALL BELOW
  - LINE OF FLOOR ABOVE
  - LINE OF FLOOR BELOW
  - MIN. 36" HIGH GUARDRAIL (REFER TO DETAIL SHEETS)
  - A/C PAD LOCATION
  - LOW WALL - REFER TO PLAN FOR HEIGHT
  - 2x6 STUD WALL
  - DEL. 2x4 WALL PER PLAN
  - INTERIOR SHELF - REFER TO PLAN FOR HEIGHT
  - FLAT SOFFIT
  - ARCHED SOFFIT
  - OPT. DOOR/ WINDOW
  - PRE-MANUFACTURED DECORATIVE COLUMN (SIZE, SEE ELEV.) FYPON OR EQ. SURROUNDING STRUCTURAL POST.
  - BRICK / STONE VENEER - REFER TO ELEVATIONS
  - SECTIONAL GARAGE DOOR PER SPECS
  - 3" DIA. CONCRETE FILLED PIPE BOLLARD 36" HIGH WITH MIN. 12" EMBEDMENT INTO CONCRETE (NOT REQUIRED AT ELECTRIC WATER HEATERS OR FOR APPLIANCES LOCATED OUT OF THE VEHICLE'S NORMAL TRAVEL PATH).
  - P.T. POST W/ VINYL WRAP.
  - EGRESS WINDOW
  - WINDOW LEDGE, HEIGHT & WIDTH OF OPENING TO EXTEND 6" BEYOND WINDOW(S) ON ALL SIDES U.N.O.
  - SITE-BUILT COLUMN - SEE ELEVATION FOR TYPE
  - CONCRETE SLAB, SLOPE 1/4" PER FT. MIN. SEE PLAN FOR SIZE

- ROOF PLAN NOTES**
- INDICATES ROOF SLOPE AND DIRECTION, U.N.O.
- 6:12
- ROOF MATERIAL: COMPOSITION SHINGLE
- 12" (INCHES) TYPICAL ROOF OVERHANGS AT RAKE, U.N.O.
- 12" (INCHES) TYPICAL ROOF OVERHANGS AT EAVE, U.N.O.
- LOCATE EAVE/ RAFTER VENTS EQUALLY BALANCED AROUND HOUSE EXCEPT ABOVE SHEARWALL PANELS.

- ATTIC VENT CALCULATIONS**
- PROVIDE 1 SQ. IN. OF VENTILATION PER 500 SQ. IN. OF ATTIC SPACE. PROVIDE THAT AT LEAST 50% & NO MORE THAN 80% OF THE REQ. VENTILATING AREA IS PROVIDED BY VENTILATORS LOCATED IN THE UPPER PORTION OF THE ATTIC. (HIGH VENTING) AT 5'-0" ABOVE EAVE VENT WITH THE BALANCE BEING PROVIDED BY EAVE VENTS (LOW VENTING) (2018 NC-R 806.2)
- \* CALCULATION BY 1/150, HIGH/LOW VENTING NOT REQUIRED.
- APPROXIMATE RIDGE VENT LOCATIONS SHOWN. ACTUAL LOCATIONS TO BE DETERMINED IN THE FIELD.
- | AREA 3 / OPTIONAL 10x10 COVERED PATIO                  |                                    |
|--|------------------------------------|
| VENTILATION REQUIRED:                                  | * 100 SQ. FT. / 150 = 0.67 SQ. FT. |
| ATTIC AREA   | X 144 = 46.40 SQ. IN.              |
| VENTILATION PROVIDED:                                  |                                    |
| ( 7 ) LIN. FEET OF RIDGE VENT AT (18 SQ. IN./FOOT)     | = 126 SQ. IN.                      |
| ( 20 ) LIN. FEET OF VENTILATED SOFFIT (5 SQ. IN./FOOT) | = 100 SQ. IN.                      |
| TOTAL VENTILATION PROVIDED:                            | 226 SQ. IN.                        |

- NOTE: REFER TO BASIC ELEVATIONS FOR INFORMATION NOT SHOWN HERE
- NOTE: REFER TO BASIC ROOF PLAN FOR INFORMATION NOT SHOWN HERE
- NOTE: REFER TO BASIC FLOOR PLAN FOR INFORMATION NOT SHOWN HERE

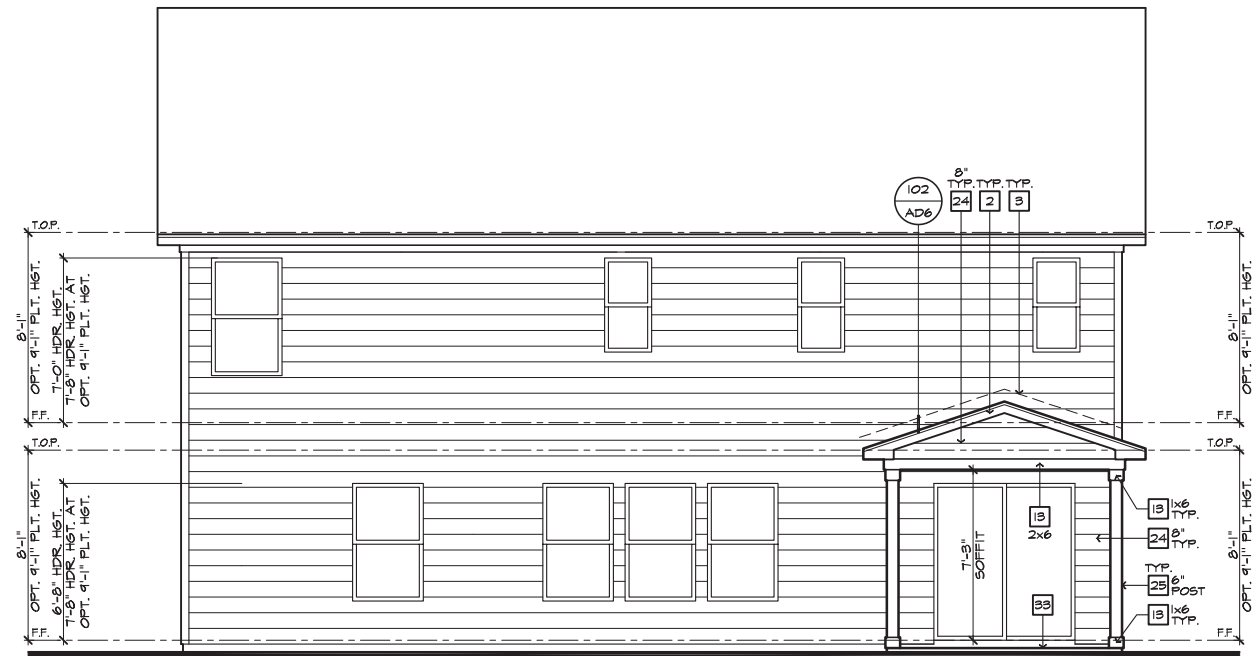

**REAR ELEVATION**

SCALE 1/4"=1'-0" (22"X34") - 1/8"=1'-0" (11"X17")

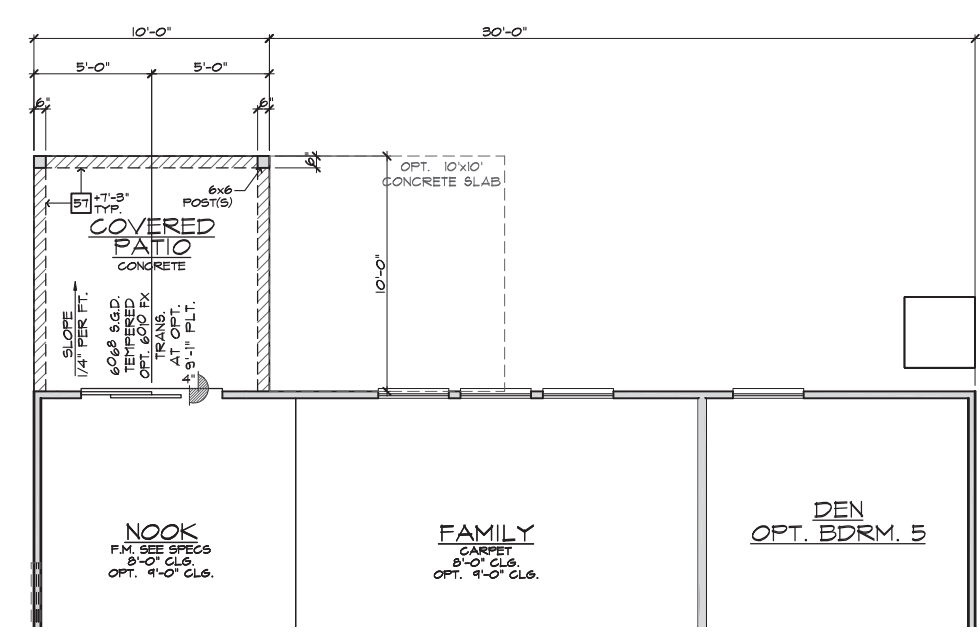

**PARTIAL FLOOR PLAN**

SCALE 1/4"=1'-0" (22"X34") - 1/8"=1'-0" (11"X17")

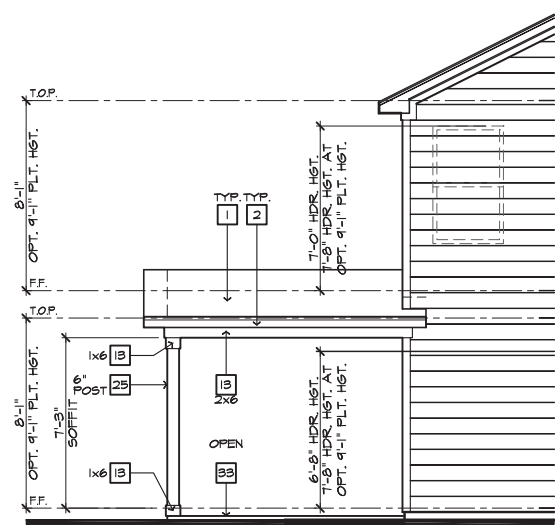

**PARTIAL LEFT ELEVATION**

SCALE 1/4"=1'-0" (22"X34") - 1/8"=1'-0" (11"X17")

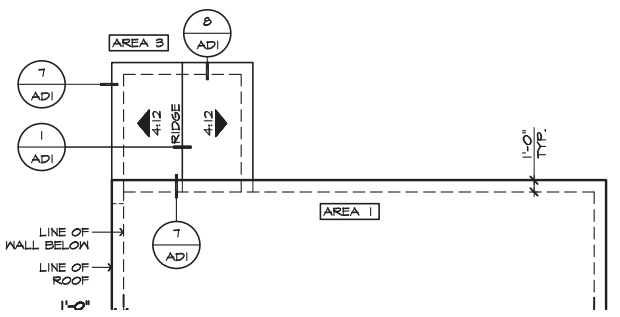

**PARTIAL ROOF PLAN**

SCALE 1/8"=1'-0" (22"X34") - 1/16"=1'-0" (11"X17")

**10'X10' COVERED PATIO**

These designs and drawings are CONFIDENTIAL and the exclusive property of KB Home Corporation and are not to be disclosed without the express permission of KB Home Corporation. Copyright 2019 © KB Home Corporation, all rights reserved.



All I-Joist and Versa-Lam Beams  
Must be Installed per The  
Boise Cascade Installation Guide!

KB Homes  
2596 Elev C  
Lot 7 Mason Pointe

Revisions: BY:

08-25-18

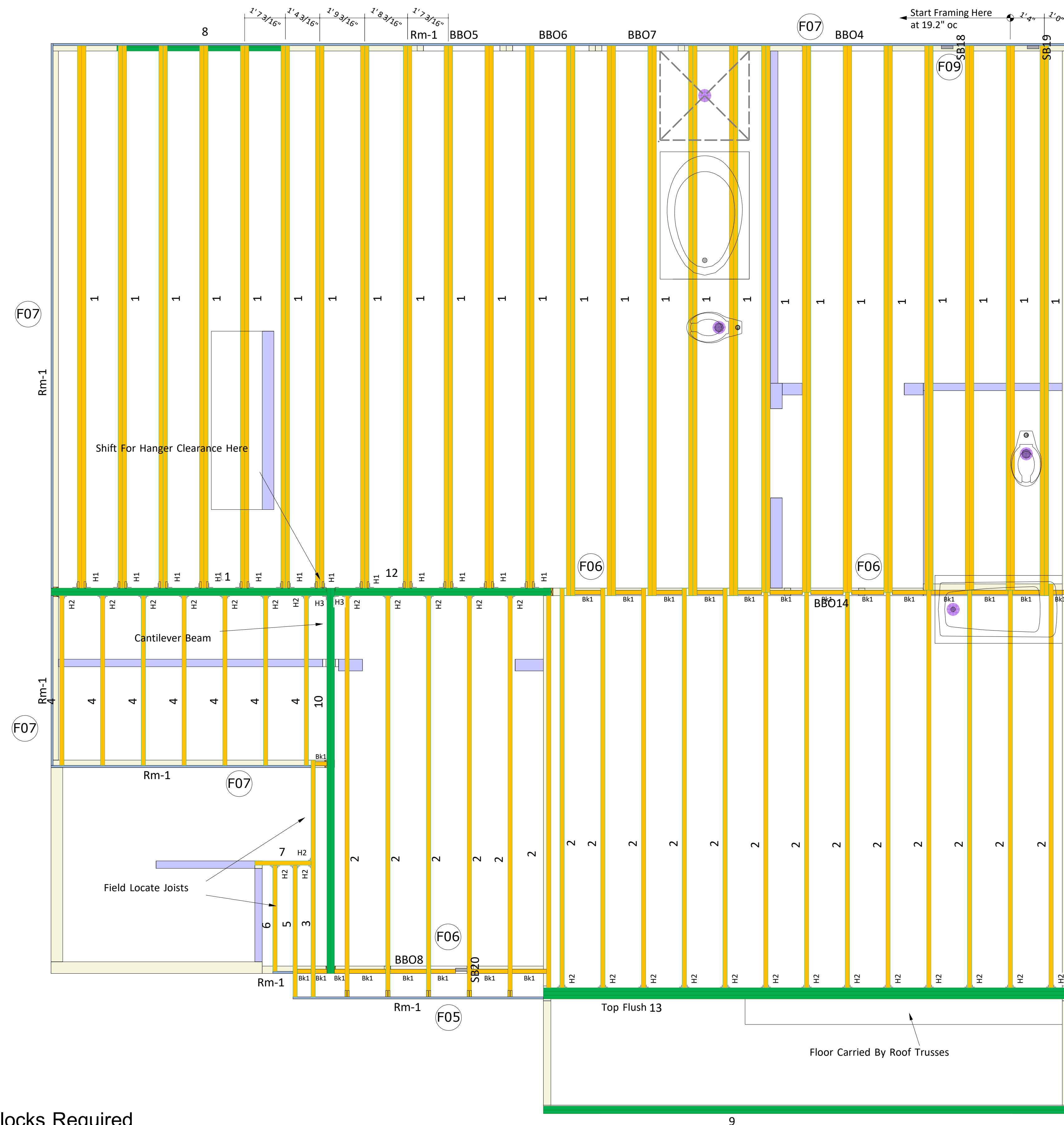

Products				
PlotID	Net Qty	Product	Length	Plies
1	50	14" BCI® 5000s-1.8	22' 0"	2
2	19	14" BCI® 5000s-1.8	16' 0"	1
3	1	14" BCI® 5000s-1.8	10' 0"	1
4	7	14" BCI® 5000s-1.8	7' 0"	1
5	1	14" BCI® 5000s-1.8	6' 0"	1
6	1	14" BCI® 5000s-1.8	5' 0"	1
7	1	14" BCI® 5000s-1.8	3' 0"	1
8	2	1-3/4" x 9-1/4" VERSA-LAM® 2.0 3100 SP	8' 0"	2
9	2	1-3/4" x 11-7/8" VERSA-LAM® 2.0 3100 SP	22' 0"	2
10	2	1-3/4" x 14" VERSA-LAM® 2.0 3100 SP	16' 0"	2
11	2	1-3/4" x 14" VERSA-LAM® 2.0 3100 SP	12' 0"	2
12	2	1-3/4" x 14" VERSA-LAM® 2.0 3100 SP	10' 0"	2
13	3	1-3/4" x 24" VERSA-LAM® 2.0 3100 SP	22' 0"	3
Rm-1	11	1" x 14" BC RIM BOARD OSB	12' 0"	1
Bk1	12	14" BCI® 5000s-1.8	2' 0"	1

Connector Summary			
PlotID	Qty	Manuf	Product
H1	12	Simpson	HU4.12/11
H2	28	Simpson	IUS2.06/14
H3	2	Simpson	HUCQ412-SDS
BN-6*	32		6" bolt, nut & 2 washers*

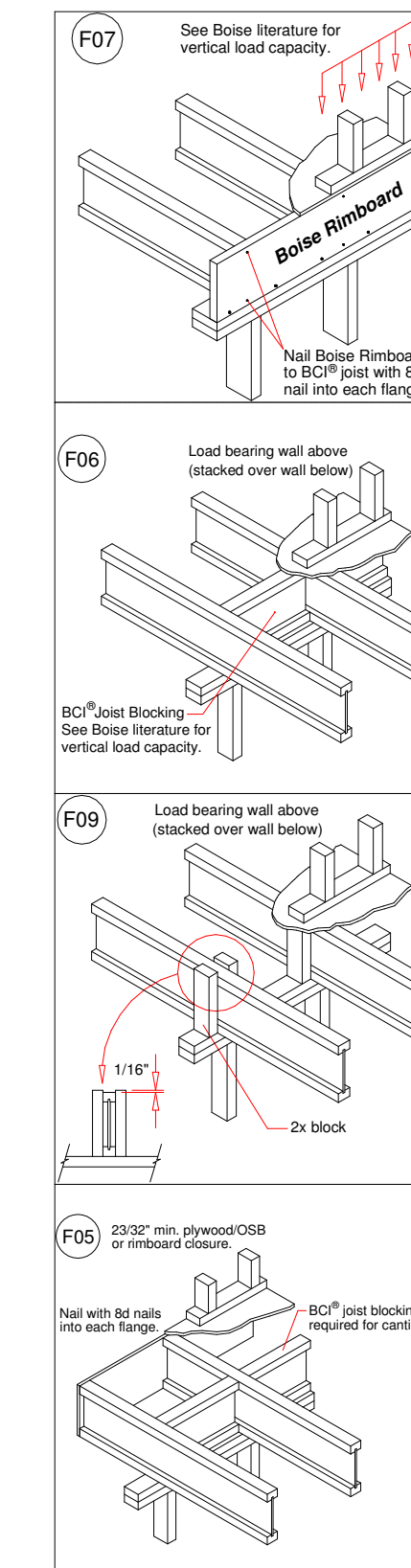

SALES PRESENTATION DRAWING  
No structural or dimensional check has been made of this design drawings of the building, therefore, the user is to check all applicable dimensions, quantities, loadings, load paths, etc. This drawing has not been checked by Boise Engineering.

KB Homes  
2596 Elev C  
Lot 7 Mason Pointe  
84 Lumber EWP

Squash Blocks Required Under The Ends Of All LVL And Point Loads For Load Transfer - See Details

ALL DIMENSIONS AND CONDITIONS TO BE REVIEWED AND APPROVED BY BOTH THE CONTRACTOR AND THE ENGINEER OF RECORD PRIOR TO INSTALLATION

### Second Floor Layout







NOTE: ALL CHAPTERS, SECTIONS, TABLES, AND FIGURES CITED WITHOUT A PUBLICATION TITLE ARE FROM THE APPLICABLE RESIDENTIAL CODE (SEE TITLE SHEET).

**GENERAL**

1. IT IS THE CONTRACTOR'S RESPONSIBILITY TO VERIFY ALL DIMENSIONS PRIOR TO CONSTRUCTION. FURTHERMORE, CONTRACTOR IS ULTIMATELY RESPONSIBLE FOR CONSTRUCTION MEANS, METHODS, AND SAFETY ON SITE. NOTIFY JDS CONSULTING & DESIGN, PLLC IMMEDIATELY IF DISCREPANCIES ON PLAN EXIST.

2. BRACED-WALL DESIGN IS BASED ON SECTION R602.10 - WALL BRACING. PRIMARY PRESCRIPTIVE METHOD TO BE CS-WSP. SEE WALL BRACING PLANS AND DETAILS FOR ADDITIONAL INFORMATION.

ALL NON-PRESCRIPTIVE SOLUTIONS ARE BASED ON GUIDELINES ESTABLISHED IN THE AMERICAN SOCIETY OF CIVIL ENGINEERS PUBLICATION ASCE 7 AND THE NATIONAL DESIGN SPECIFICATION FOR WOOD CONSTRUCTION - SPECIAL DESIGN PROVISIONS FOR WIND AND SEISMIC.

3. SEISMIC DESIGN SHALL BE PER SECTION R301.2.2 - SEISMIC PROVISIONS, INCLUDING ASSOCIATED TABLES AND FIGURES, BASED ON LOCAL SEISMIC DESIGN CATEGORY.

**DESIGN LOADS**

ASSUMED SOIL BEARING-CAPACITY 2,000 PSF

	LIVE LOAD
ULTIMATE DESIGN WIND SPEED	115 MPH, EXPOSURE B
GROUND SNOW	15 PSF
ROOF	20 PSF

RESIDENTIAL CODE TABLE R301.5	LIVE LOAD (PSF)
DWELLING UNITS	40
SLEEPING ROOMS	30
ATTICS WITH STORAGE	20
ATTICS WITHOUT STORAGE	10
STAIRS	40
DECKS	40
EXTERIOR BALCONIES	60
PASSENGER VEHICLE GARAGES	50
FIRE ESCAPES	40
GUARDS AND HANDRAILS	200 (pounds, concentrated)

COMPONENT AND CLADDING LOADS, INCLUDING THOSE FOR DOORS AND WINDOWS, SHALL BE DERIVED FROM TABLES R301.2(2) AND R301.2(3) FOR A BUILDING WITH A MEAN ROOF HEIGHT OF 35 FEET, LOCATED IN EXPOSURE B.

**ABBREVIATIONS**

ABV	ABOVE	KS	KING STUD COLUMN
AFF	ABOVE FINISHED FLOOR	LVL	LAMINATED VENEER LUMBER
ALT	ALTERNATE	MAX	MAXIMUM
BRG	BEARING	MECH	MECHANICAL
BSMT	BASEMENT	MFR	MANUFACTURER
CANT	CANTILEVER	MIN	MINIMUM
CJ	CEILING JOIST	NTS	NOT TO SCALE
CLG	CEILING	OA	OVERALL
CMU	CONCRETE MASONRY UNIT	OC	ON CENTER
CO	CASED OPENING	PT	PRESSURE TREATED
COL	COLUMN	R	RISER
CONC	CONCRETE	REF	REFRIGERATOR
CONT	CONTINUOUS	RFG	ROOFING
D	CLOTHES DRYER	RO	ROUGH OPENING
DBL	DOUBLE	RS	ROOF SUPPORT
DIAM	DIAMETER	SC	STUD COLUMN
DJ	DOUBLE JOIST	SF	SQUARE FOOT (FEET)
DN	DOWN	SH	SHELF / SHELVES
DP	DEEP	SHTG	SHEATHING
DR	DOUBLE RAFTER	SHW	SHOWER
DSP	DOUBLE STUD POCKET	SIM	SIMILAR
EA	EACH	SJ	SINGLE JOIST
EE	EACH END	SP	STUD POCKET
EQ	EQUAL	SPEC'D	SPECIFIED
EX	EXTERIOR	SQ	SQUARE
FAU	FORCED-AIR UNIT	T	TREAD
FDN	FOUNDATION	TEMP	TEMPERED GLASS
FF	FINISHED FLOOR	THK	THICK(NESS)
FLR	FLOOR(ING)	TJ	TRIPLE JOIST
FP	FIREPLACE	TOC	TOP OF CURB / CONCRETE
FTG	FOOTING	TR	TRIPLE RAFTER
HB	HOSE BIBB	TYP	TYPICAL
HDR	HEADER	UNO	UNLESS NOTED OTHERWISE
HGR	HANGER	W	CLOTHES WASHER
JS	JACK STUD COLUMN	WH	WATER HEATER
		WWF	WELDED WIRE FABRIC
		XJ	EXTRA JOIST

**MATERIALS**

1. INTERIOR / TRIMMED FRAMING LUMBER SHALL BE #2 SPRUCE PINE FIR (SPF) WITH THE FOLLOWING DESIGN PROPERTIES (#2 SOUTHERN YELLOW PINE MAY BE SUBSTITUTED):

$F_b = 875 \text{ PSI}$   $F_v = 70 \text{ PSI}$   $E = 1.4E6 \text{ PSI}$

2. FRAMING LUMBER EXPOSED TO WEATHER OR IN CONTACT WITH THE GROUND, CONCRETE, OR MASONRY SHALL BE PRESSURE TREATED #2 SOUTHERN YELLOW PINE (SYP) WITH THE FOLLOWING DESIGN PROPERTIES:

$F_b = 975 \text{ PSI}$   $F_v = 95 \text{ PSI}$   $E = 1.6E6 \text{ PSI}$

3. LVL STRUCTURAL MEMBERS TO BE LAMINATED VENEER LUMBER WITH THE FOLLOWING MINIMUM DESIGN PROPERTIES:

$F_b = 2600 \text{ PSI}$   $F_v = 285 \text{ PSI}$   $E = 1.9E6 \text{ PSI}$

4. PSL STRUCTURAL MEMBERS TO BE PARALLEL STRAND LUMBER WITH THE FOLLOWING MINIMUM DESIGN PROPERTIES:

$F_b = 2900 \text{ PSI}$   $F_v = 290 \text{ PSI}$   $E = 2.0E6 \text{ PSI}$

5. LSL STRUCTURAL MEMBERS TO BE LAMINATED STRAND LUMBER WITH THE FOLLOWING MINIMUM DESIGN PROPERTIES:

$F_b = 2250 \text{ PSI}$   $F_v = 400 \text{ PSI}$   $E = 1.55E6 \text{ PSI}$

6. STRUCTURAL STEEL WIDE-FLANGE BEAMS SHALL CONFORM TO ASTM A992.  $F_y = 50 \text{ KSI}$

7. REBAR SHALL BE DEFORMED STEEL CONFORMING TO ASTM A615, GRADE 60.

8. POURED CONCRETE COMPRESSIVE STRENGTH TO BE A MINIMUM 3,000 PSI AT 28 DAYS. MATERIALS USED TO PRODUCE CONCRETE SHALL COMPLY WITH THE APPLICABLE STANDARDS LISTED IN AMERICAN CONCRETE INSTITUTE STANDARD ACI 318 OR ASTM C1157.

9. CONCRETE SUBJECT TO MODERATE OR SEVERE WEATHERING PROBABILITY PER TABLE R301.2(1) SHALL BE AIR-ENTRAINED WHEN REQUIRED BY TABLE R402.2.

10. CONCRETE MASONRY UNITS (CMU) SHALL CONFORM TO AMERICAN CONCRETE INSTITUTE PUBLICATION 530: BUILDING CODE REQUIREMENTS AND SPECIFICATIONS FOR MASONRY STRUCTURES AND COMPANION COMMENTARIES AND THE MASONRY SOCIETY PUBLICATION TMS 402/602: BUILDING CODE REQUIREMENTS AND SPECIFICATIONS FOR MASONRY STRUCTURES.

11. MORTAR SHALL COMPLY WITH ASTM INTERNATIONAL STANDARD C270.

12. INDICATED MODEL NUMBERS FOR ALL METAL HANGERS, STRAPS, FRAMING CONNECTORS, AND HOLD-DOWNS ARE SIMPSON STRONG-TIE BRAND. EQUIVALENT USP BRAND PRODUCTS ARE ACCEPTABLE.

13. REFER TO I-JOIST EQUIVALENCE CHART ON I-JOIST DETAIL SHEET FOR SUBSTITUTION OF MANUFACTURER SERIES.

**FOUNDATION**

1. MINIMUM ALLOWABLE SOIL BEARING CAPACITY IS ASSUMED TO BE 2,000 PSF. IT IS THE CONTRACTOR'S RESPONSIBILITY TO VERIFY SOIL BEARING CAPACITY IF UNSATISFACTORY CONDITIONS EXIST.

2. CONCRETE FOUNDATION WALLS TO BE SELECTED AND CONSTRUCTED PER SECTION R404 OR AMERICAN CONCRETE INSTITUTE STANDARD ACI 318.

3. MASONRY FOUNDATION WALLS TO BE SELECTED AND CONSTRUCTED PER SECTION R404 AND/OR AMERICAN CONCRETE INSTITUTE PUBLICATION 530: BUILDING CODE REQUIREMENTS AND SPECIFICATIONS FOR MASONRY STRUCTURES AND COMPANION COMMENTARIES AND/OR THE MASONRY SOCIETY PUBLICATION TMS 402/602: BUILDING CODE REQUIREMENTS AND SPECIFICATIONS FOR MASONRY STRUCTURES.

4. CONCRETE WALL HORIZONTAL REINFORCEMENT TO BE PER TABLE R404.1.2(1) OR AS NOTED OR DETAILED. CONCRETE WALL VERTICAL REINFORCEMENT TO BE PER TABLES R404.1.2(3 AND 4) OR AS NOTED OR DETAILED. ALL CONCRETE WALLS SHALL COMPLY WITH APPLICABLE PROVISIONS OF CHAPTER 6.

- A. TABLES ASSUME THAT WALLS HAVE PERMANENT LATERAL SUPPORT AT THE TOP AND BOTTOM.
- B. FOUNDATION DRAINS ARE ASSUMED AT ALL WALLS PER SECTION R405.

5. PLAIN-MASONRY WALL DESIGN TO BE PER TABLE R404.1.1(1) OR AS NOTED OR DETAILED. MASONRY WALLS WITH VERTICAL REINFORCEMENT TO BE PER TABLES R404.1.1 (2 THROUGH 4) OR AS NOTED OR DETAILED. ALL MASONRY WALLS SHALL COMPLY WITH APPLICABLE PROVISIONS OF CHAPTER 6.

- A. TABLES ASSUME THAT WALLS HAVE PERMANENT LATERAL SUPPORT AT THE TOP AND BOTTOM.
- B. WALL REINFORCING SHALL BE PLACED ACCORDING TO FOOTNOTE (c) OF THE TABLES (REINFORCING IS NOT CENTERED IN WALL).
- C. FOUNDATION DRAINS ARE ASSUMED AT ALL WALLS PER SECTION R405.

6. WOOD SILL PLATES TO BE ANCHORED TO THE FOUNDATION WITH 1/2" DIAMETER ANCHOR BOLTS WITH MINIMUM 7" EMBEDMENT, SPACED A MAXIMUM OF 6'-0" OC AND WITHIN 12" FROM THE ENDS OF EACH PLATE SECTION. INSTALL MINIMUM (2) ANCHOR BOLTS PER SECTION. SEE SECTION R403.1.6 FOR SPECIFIC CONDITIONS.

7. THE UNSUPPORTED HEIGHT OF SOLID MASONRY PIERS SHALL NOT EXCEED TEN TIMES THEIR LEAST DIMENSION. UNFILLED, HOLLOW PIERS MAY BE USED IF THE UNSUPPORTED HEIGHT IS NOT MORE THAN FOUR TIMES THEIR LEAST DIMENSION.

8. CENTERS OF PIERS TO BEAR IN THE MIDDLE THIRD OF THE FOOTINGS, AND GIRDERS SHALL CENTER IN THE MIDDLE THIRD OF THE PIERS.

9. ALL FOOTINGS TO HAVE MINIMUM 2" PROJECTION ON EACH SIDE OF FOUNDATION WALLS (SEE DETAILS).

10. ALL REBAR NOTED IN CONCRETE TO HAVE AT LEAST 2" COVER FROM EDGE OF CONCRETE TO EDGE OF REBAR.

11. FRAMING TO BE FLUSH WITH FOUNDATION WALLS.

12. WITH CLASS 1 SOILS, VAPOR BARRIER AND CRUSHED STONE MAY BE OMITTED.

**FRAMING**

1. ALL BEARING HEADERS TO BE (2) 2x6 SUPPORTED W/ MIN (1) JACK STUD AND (1) KING STUD EACH END, UNO.

2. ALL NON-BEARING HEADERS TO BE (2) 2x4, UNO.

3. NON-BEARING INTERIOR WALLS NOT MORE THAN 10' NOMINAL HEIGHT AND NOT SHOWN AS BRACED WALLS MAY BE FRAMED WITH 2x4 STUDS @ 24" OC.

4. SOLID BLOCKING TO BE PROVIDED AT ALL POINT LOADS THROUGH FLOOR LEVELS TO THE FOUNDATION OR TO OTHER STRUCTURAL COMPONENTS.

5. ALL BEAMS SPECIFIED ARE MINIMUM SIZES ONLY. LARGER MEMBERS MAY SUBSTITUTED AS NEEDED FOR EASE OF CONSTRUCTION.

6. ALL EXTERIOR WALLS TO BE FULLY SHEATHED WITH 7/16" OSB.

7. PORCH / PATIO COLUMNS TO BE 4x4 MINIMUM PRESSURE-TREATED LUMBER.

- A. ATTACH PORCH COLUMNS TO SLAB / FDN WALL USING ABA, ABU, ABW, OR CPT SIMPSON POST BASES TO FIT COLUMN SIZES NOTED ON PLAN -OR- ANY OTHER COLUMN CONNECTION WITH 500# UPLIFT CAPACITY.
- B. ATTACH PORCH COLUMNS TO PORCH BEAMS USING AC OR BC SIMPSON POST CAPS TO FIT COLUMN SIZES NOTED ON PLAN -OR- ANY OTHER COLUMN CONNECTION WITH 500# UPLIFT CAPACITY.
- C. TRIM OUT COLUMN(S) AND BEAM(S) PER BUILDER AND DETAILS.

8. ALL ENGINEERED WOOD PRODUCTS (LVL, PSL, LSL, ETC.) SHALL BE INSTALLED WITH CONNECTIONS PER MANUFACTURER SPECIFICATIONS.

9. ENGINEERED WOOD FLOOR SYSTEMS AND ROOF TRUSS SYSTEMS:

- A. SHOP DRAWINGS FOR THE SYSTEMS SHALL BE PROVIDED TO THE ENGINEER OF RECORD FOR REVIEW AND COORDINATION BEFORE CONSTRUCTION.
- B. TRUSS PROFILES SHALL BE SEALED BY THE TRUSS MANUFACTURER.
- C. INSTALLATION OF THE SYSTEMS SHALL BE PER MANUFACTURER'S INSTRUCTIONS.
- D. TRUSS LAYOUT AND PLACEMENT BY MANUFACTURER TO COINCIDE WITH THE SUPPORT LOCATIONS SHOWN IN THESE DRAWINGS.

10. ALL BEAMS TO BE CONTINUOUSLY SUPPORTED Laterally AND SHALL BEAR FULL WIDTH ON THE SUPPORTING WALLS OR COLUMNS INDICATED, WITH A MINIMUM OF THREE STUDS, UNO.

11. ALL STEEL BEAMS TO BE SUPPORTED AT EACH END WITH A MIN BEARING LENGTH OF 3 1/2" AND FULL FLANGE WIDTH. BEAMS MUST BE ATTACHED AT EACH END WITH A MINIMUM OF FOUR 16d NAILS OR TWO 1/2" x 4" LAG SCREWS, UNO.

12. STEEL FLITCH BEAMS TO BE BOLTED TOGETHER USING (2) ROWS OF 1/2" DIAMETER BOLTS (ASTM 307) WITH WASHERS PLACED UNDER THE THREADED END OF THE BOLT. BOLTS TO BE SPACED AT 24" OC (MAX) AND STAGGERED TOP AND BOTTOM OF BEAM (2" EDGE DISTANCE), WITH TWO BOLTS TO BE LOCATED AT 6" FROM EACH END OF FLITCH BEAM.

13. WHEN A 4-PLY LVL BEAM IS USED, ATTACH WITH (1) 1/2" DIAMETER BOLT, 12" OC, STAGGERED TOP AND BOTTOM, 1 1/2" MIN FROM ENDS. ALTERNATE EQUIVALENT ATTACHMENT METHOD MAY BE USED, SUCH AS SDS, SDW, OR TRUSSLOK SCREWS (SEE MANUFACTURER SPECIFICATIONS).

14. FOR STUD COLUMNS OF 4-OR-MORE STUDS, INSTALL SIMPSON STRONG-TIE CS16 STRAPS ACROSS STUDS @ 30" OC, 6" MAX FROM PLATES, ON INSIDE FACE OF COLUMN (EXTERIOR WALL), ON BOTH FACES OF COLUMN (INTERIOR WALL).

15. FLOOR JOISTS ADJACENT AND PARALLEL TO THE EXTERIOR FOUNDATION WALL SHALL BE PROVIDED WITH FULL-DEPTH SOLID BLOCKING, NOT LESS THAN TWO (2) INCHES NOMINAL IN THICKNESS, PLACED PERPENDICULAR TO THE JOIST AT SPACING NOT MORE THAN FOUR (4) FEET. THE BLOCKING SHALL BE NAILED TO THE FLOOR SHEATHING, THE SILL PLATE, THE JOIST, AND THE EXTERIOR RIM JOIST / BOARD.

16. BRACED WALL PANELS SHALL BE FASTENED TO MEET THE UPLIFT-RESISTANCE REQUIREMENTS IN CHAPTERS 6 AND 8 OF THE APPLICABLE CODE (SEE TITLE SHEET). REQUIREMENTS OF THE STRUCTURAL DRAWINGS THAT EXCEED THE CODE MINIMUM SHALL BE MET.



KB HOME  
NORTH CAROLINA DIVISION  
4518 S. MIAMI BLVD.  
SUITE 180  
DURHAM, NC 27703  
TEL: (919) 768-7988  
FAX: (919) 472-0582

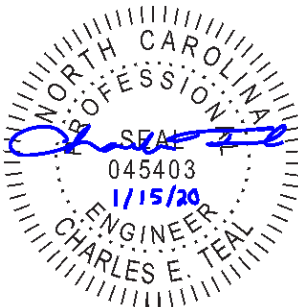

P-0961



PROJECT NO.: 20900080  
DATE: 01/15/2020

PLAN:  
240.2596

**GENERAL NOTES**

**GN1.0**

These designs and drawings are CONFIDENTIAL, and the enclosure property of KB Home Corporation and are not to be disclosed without the express permission of KB Home Corporation. Copyright 2018 © KB Home Corporation. All rights reserved. They may not be used or replicated without the express permission of KB Home Corporation.

FASTENER SCHEDULE		
CONNECTION	3" x 0.131" NAIL	3" x 0.120" NAIL
JOIST TO SILL PLATE	(4) TOE NAILS	(4) TOE NAILS
SOLE PLATE TO JOIST / BLOCKING	NAILS @ 8" OC (typical) (4) PER 16" SPACE (at braced panels)	NAILS @ 8" OC (typical) (4) PER 16" SPACE (at braced panels)
STUD TO SOLE PLATE	(4) TOE NAILS	(4) TOE NAILS
TOP OR SOLE PLATE TO STUD	(3) FACE NAILS	(4) FACE NAILS
RIM JOIST OR BAND JOIST TO TOP PLATE OR SILL PLATE	TOE NAILS @ 6" OC	TOE NAILS @ 4" OC
BLOCKING BETWEEN JOISTS TO TOP PLATE OR SILL PLATE	(4) TOE NAILS	(4) TOE NAILS
DOUBLE STUD	NAILS @ 8" OC	NAILS @ 8" OC
DOUBLE TOP PLATES	NAILS @ 12" OC	NAILS @ 12" OC
DOUBLE TOP PLATES LAP (24" MIN LAP LENGTH)	(12) NAILS IN LAPPED AREA, EA SIDE OF JOINT	(12) NAILS IN LAPPED AREA, EA SIDE OF JOINT
TOP PLATE LAP AT CORNERS AND INTERSECTING WALLS	(3) FACE NAILS	(3) FACE NAILS
OPEN-WEB TRUSS BOTTOM CHORD TO TOP PLATES OR SILL PLATE (PARALLEL TO WALL)	NAILS @ 6" OC	NAILS @ 4" OC
BOTTOM CHORD OF TRUSS TO TOP PLATES OR SILL PLATE (PERPENDICULAR TO WALL)	(3) TOE NAILS	(3) TOE NAILS

SEE TABLE R602.3(1) FOR ADDITIONAL STRUCTURAL-MEMBER FASTENING REQUIREMENTS.

DETAILS AND NOTES ON DRAWINGS GOVERN.

**BALLOON WALL FRAMING SCHEDULE**  
(USE THESE STANDARDS UNLESS NOTED OTHERWISE ON THE FRAMING PLAN SHEETS)

FRAMING MEMBER SIZE	MAX HEIGHT (PLATE TO PLATE) 115 MPH ULTIMATE DESIGN WIND SPEED
2x4 @ 16" OC	10'-0"
2x4 @ 12" OC	12'-0"
2x6 @ 16" OC	15'-0"
2x6 @ 12" OC	17'-9"
2x8 @ 16" OC	19'-0"
2x8 @ 12" OC	22'-0"
(2) 2x4 @ 16" OC	14'-6"
(2) 2x4 @ 12" OC	17'-0"
(2) 2x6 @ 16" OC	21'-6"
(2) 2x6 @ 12" OC	25'-0"
(2) 2x8 @ 16" OC	27'-0"
(2) 2x8 @ 12" OC	31'-0"

- ALL HEIGHTS ARE MEASURED SUBFLOOR TO TOP OF WALL PLATE.
- WHEN SPLIT-FRAMED WALLS ARE USED FOR HEIGHTS OVER 12', THE CONTRACTOR SHALL ADD 6' MINIMUM OF CS16 COIL STRAPPING (FULLY NAILED), CENTERED OVER THE WALL BREAK.
- FINGER-JOINTED MEMBERS MAY BE USED FOR CONTINUOUS HEIGHTS WHERE TRADITIONALLY MILLED LUMBER LENGTHS ARE LIMITED.
- FOR GREATER WIND SPEED, SEE ENGINEERED SOLUTION FOR CONDITION IN DRAWINGS.

**ROOF SYSTEMS**

**TRUSSED ROOF - STRUCTURAL NOTES**

- PROVIDE CONTINUOUS BLOCKING THROUGH STRUCTURE FOR ALL POINT LOADS.
-  DENOTES OVER-FRAMED AREA
- MINIMUM 7/16" OSB ROOF SHEATHING
- TRUSS LAYOUT AND PLACEMENT BY MANUFACTURER TO COINCIDE WITH THE SUPPORT LOCATIONS SHOWN. TRUSS PROFILES SHALL BE SEALED BY THE TRUSS MANUFACTURER. TRUSS PLANS TO BE COORDINATED WITH THE SEALED STRUCTURAL DRAWINGS. INSTALLATION SHALL BE IN ACCORDANCE WITH THE MANUFACTURER'S INSTRUCTIONS.
- MANUFACTURER TO PROVIDE REQUIRED UPLIFT CONNECTION.
- PROVIDE H2.5A (MINIMUM) OR EQUIVALENT AT EACH TRUSS-TO-TOP PLATE CONNECTION AT OVER-FRAMED AREAS, UNLESS NOTED OTHERWISE.
- UPLIFT CONNECTION TO BE CARRIED THROUGH TO FLOOR SYSTEM.

**STICK-FRAMED ROOF - STRUCTURAL NOTES**

- PROVIDE 2x4 COLLAR TIES AT 48" OC AT UPPER THIRD OF RAFTERS, UNLESS NOTED OTHERWISE.
- FUR RIDGES FOR FULL RAFTER CONTACT.
- PROVIDE CONTINUOUS BLOCKING THROUGH STRUCTURE FOR ALL POINT LOADS.
-  DENOTES OVER-FRAMED AREA
- MINIMUM 7/16" OSB ROOF SHEATHING
- PROVIDE 2x4 RAFTER TIES AT 16" OC AT 45° BETWEEN RAFTERS AND CEILING JOISTS. USE (4) 16d NAILS AT EACH CONNECTION. RAFTER TIES MAY BE SPACED AT 48" OC AT LOCATIONS WHERE NO KNEE WALLS ARE INSTALLED.
- PROVIDE H2.5A (MINIMUM) OR EQUIVALENT AT EACH RAFTER-TO-TOP PLATE CONNECTION AT OVER-FRAMED AREAS, UNLESS NOTED OTHERWISE.
- UPLIFT CONNECTION TO BE CARRIED THROUGH TO FLOOR SYSTEM.

BRICK VENEER LINTEL SCHEDULE		
SPAN	STEEL ANGLE SIZE	END BEARING LENGTH
UP TO 42"	L3-1/2"x3-1/2"x1/4"	8" (MIN. @ EACH END)
UP TO 72"	L6"x4"x5/16" (LLV)	8" (MIN. @ EACH END)
OVER 72"	L6"x4"x5/16" (LLV) ATTACH LINTEL w/ 1/2" THRU BOLT @ 12" OC, 3" FROM EACH END	

\* FOR QUEEN BRICK: LINTELS AT THIS CONDITION MAY BE 5"x3-1/2"x5/16"

NOTE: BRICK LINTELS AT SLOPED AREAS TO BE 4"x3-1/2"x1/4" STEEL ANGLE WITH 16D NAILS IN 3/16" HOLES IN 4" ANGLE LEG AT 12" OC TO TRIPLE RAFTER. WHEN THE SLOPE EXCEEDS 4:12 A MINIMUM OF 3"x3"x1/4" PLATES SHALL BE WELDED AT 24" OC ALONG THE STEEL ANGLE.



KB HOME  
NORTH CAROLINA DIVISION  
4518 S. MIAMI BLVD.  
SUITE 180  
DURHAM, NC 27703  
TEL: (919) 768-7988  
FAX: (919) 472-0582

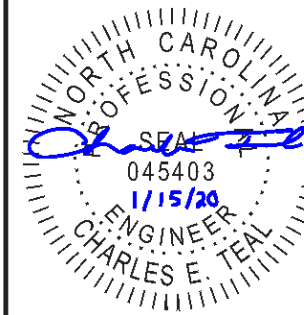

P-0961



PROJECT NO.: 20900080  
DATE: 01/15/2020

PLAN:  
240.2596

GENERAL NOTES

**GN1.1**

These designs and drawings are CONFIDENTIAL and the enclosure property of KB Home Corporation and are not to be disclosed without the express permission of KB Home Corporation. Copyright 2018 © KB Home Corporation. All rights reserved.



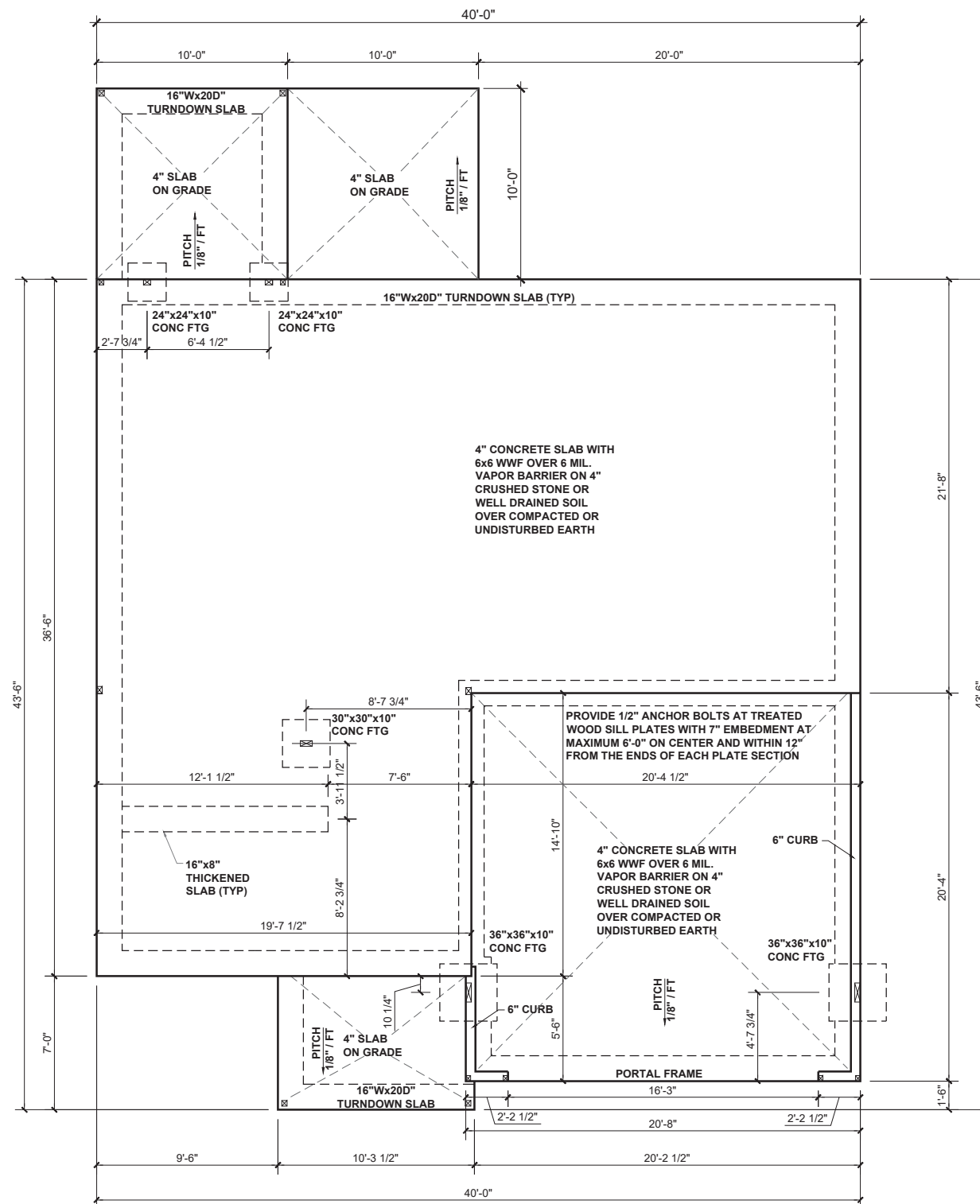

**SLAB FOUNDATION PLAN - 'C'**  
SCALE: 1/8" = 1'-0"

**BEAM & POINT LOAD LEGEND**

	INTERIOR LOAD BEARING WALL
	ROOF RAFTER / TRUSS SUPPORT
	DOUBLE RAFTER / DOUBLE JOIST
	STRUCTURAL BEAM / GIRDER
	WINDOW / DOOR HEADER
	POINT LOAD TRANSFER
	POINT LOAD FROM ABOVE BEARING ON BEAM / GIRDER

(1) #5 REBAR @ CENTER OFF ALL PERIMETER AND INTERNAL LOAD BEARING FOOTINGS. (2" C.C. MIN)



KB HOME  
NORTH CAROLINA DIVISION  
4518 S. MIAMI BLVD.  
SUITE 180  
DURHAM, NC 27703  
TEL: (919) 768-7988  
FAX: (919) 472-0582

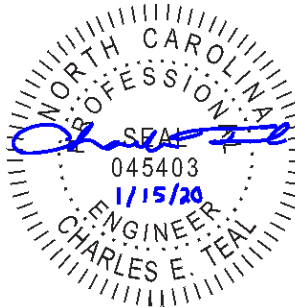

P-0961

**JDS**  
CONSULTING & DESIGN

JDS CONSULTING & DESIGN, PLLC  
8600 'D' JERSEY CT, RALEIGH, NC 27617  
919.480.1075

INFO@JDSDESIGNONLINE.COM  
WWW.JDSDESIGNONLINE.COM

PROJECT NO.: 20900080  
DATE: 01/15/2020

PLAN:  
**240.2596**

SLAB  
FOUNDATION PLAN  
**S.10C**

These designs and drawings are CONFIDENTIAL and the exclusive property of KB Home Corporation and are not to be disclosed without the express permission of KB Home Corporation. Copyright 2019 © KB Home Corporation. All rights reserved.



BEAM & POINT LOAD LEGEND	
	INTERIOR LOAD BEARING WALL
	ROOF RAFTER / TRUSS SUPPORT
	DOUBLE RAFTER / DOUBLE JOIST
	STRUCTURAL BEAM / GIRDER
	WINDOW / DOOR HEADER
	POINT LOAD TRANSFER
	POINT LOAD FROM ABOVE BEARING ON BEAM / GIRDER

- STRUCTURAL FRAMING NOTES - (SEE GENERAL NOTES SHEET FOR ADDITIONAL REQUIREMENTS.)**
- ALL FRAMING TO BE #2 SPF MINIMUM.
  - ALL BEARING HEADERS TO BE (2) 2x6 SUPPORTED w/ MIN (1) JACK AND (1) KING EACH END, UNO.
  - EXTERIOR WALL OPENINGS OVER 3' TO HAVE MULTIPLE KING STUDS AS NOTED ON PLAN.
  - ALL NON-BEARING HEADERS TO BE (2) 2x4 (1) J / (1) K, UNO.
  - PROVIDE CONTINUOUS BLOCKING THROUGH STRUCTURE FOR ALL POINT LOADS.
  - ALL HANGERS AND CONNECTORS SPECIFIED ARE TO BE SIMPSON STRONG-TIE OR EQUIVALENT.
  - ALL BEAMS SPECIFIED ARE MINIMUM SIZES ONLY. LARGER MEMBERS MAY SUBSTITUTED AS NEEDED FOR EASE OF CONSTRUCTION. MINIMUM BEAM SUPPORT IS (1) 2x4 STUD.
  - ALL EXTERIOR WALLS TO BE FULLY SHEATHED WITH 7/16" OSB.
  - FRONT PORCH COLUMNS TO BE MIN 4x4 PT ATTACHED AT TOP AND BOTTOM USING SIMPSON (OR EQUIV) COLUMN BASE OR SST A24 BRACKETS. TRIM OUT PER BUILDER.
  - PORCH COLUMNS TO BE MIN 4x4 PT ATTACHED AT BOTTOM USING SIMPSON (OR EQUIV) ABA44 AND AT TOP USING CS 16 STRAPPING (12" MIN) TO PORCH HEADER / BAND.
  - WHEN A 4-PLY LVL IS USED, ATTACH WITH (1) 1/2" Ø BOLT 12" OC STAGGERED, TOP AND BOTTOM, 1-1/2" MIN FROM ENDS. ALTERNATE ATTACHMENT EQUIVALENT METHOD MAY BE USED, SUCH AS SDW OR TRUSSLOK SCREWS (SEE MANUFACTURER'S SPECIFICATIONS).
  - FOR STUD COLUMNS OF 4 OR MORE, INSTALL SST CS16 STRAPS @ 30" OC, 6" MAX FROM PLATES, ON INSIDE FACE OF COLUMN (EXTERIOR WALL), ON BOTH FACES OF COLUMN (INTERIOR WALL).

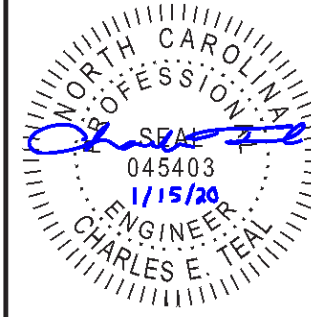

P-0961

JDS CONSULTING & DESIGN, PLLC  
8600 'D' JERSEY CT, RALEIGH, NC 27617  
919.480.1075

INFO@JDSDESIGNONLINE.COM  
WWW.JDSDESIGNONLINE.COM

PROJECT NO.: 20900080  
DATE: 01/15/2020

PLAN: 240.2596

FIRST FLOOR  
CEILING FRAMING PLAN  
**S1.0C**

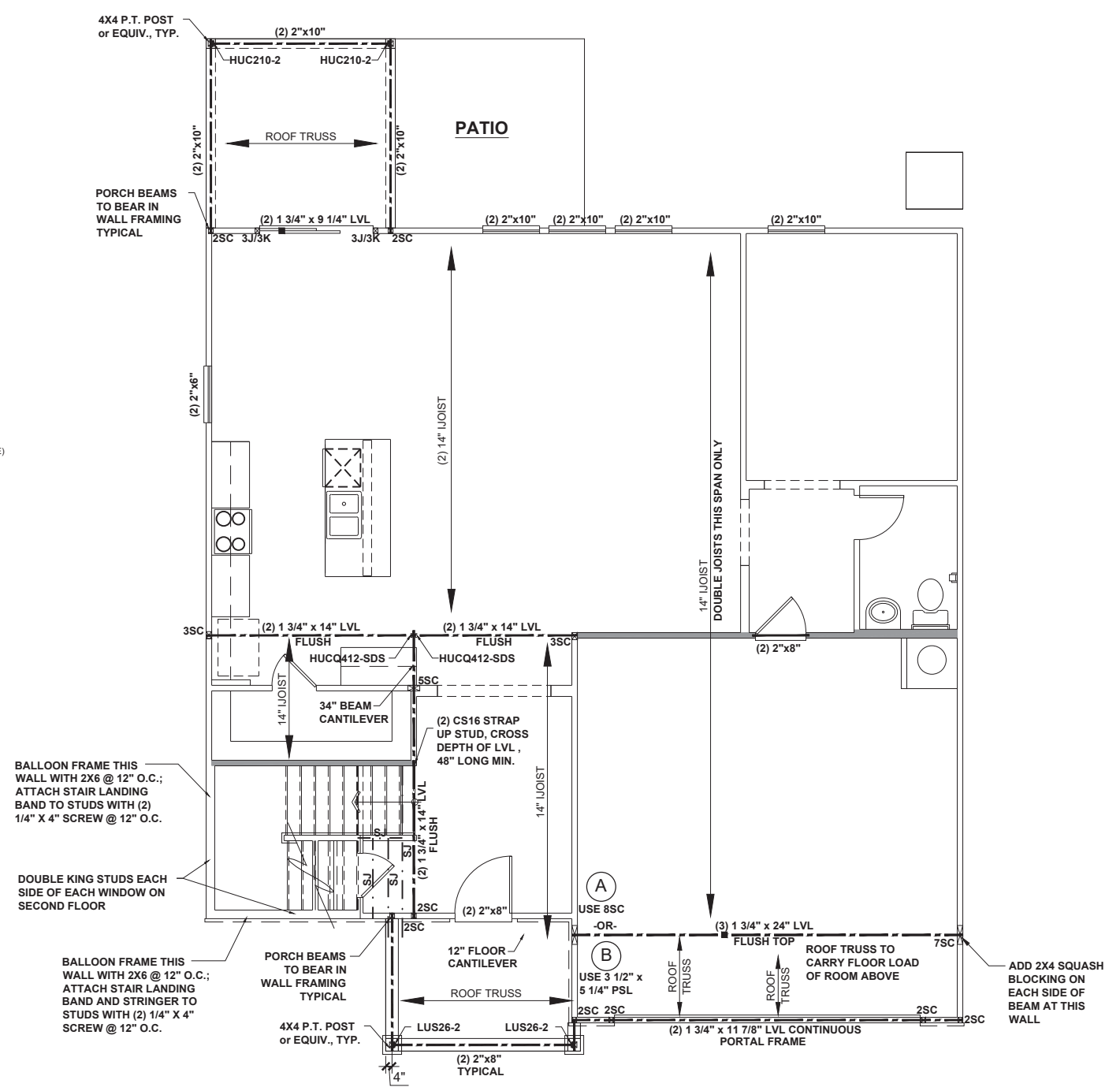
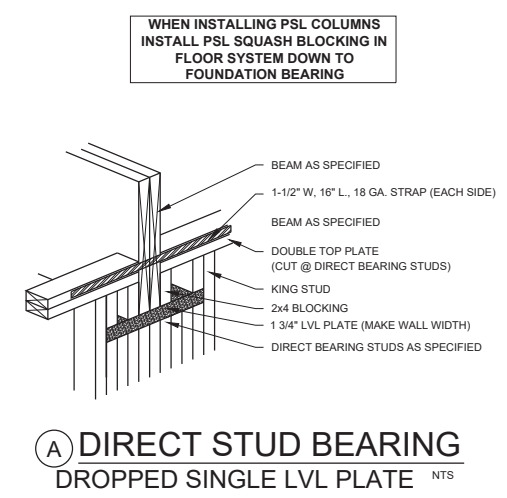

**FIRST FLOOR CEILING FRAMING PLAN - 'C'**  
SCALE: 1/8"=1'-0"

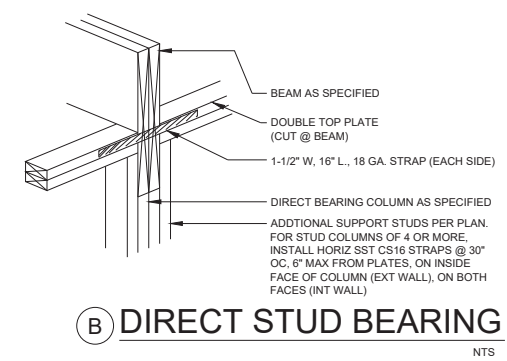

These designs and drawings are CONFIDENTIAL, and the contents are the property of KB Home Corporation and are not to be disclosed without the express permission of KB Home Corporation. Copyright 2018 © KB Home Corporation, all rights reserved.



**BEAM & POINT LOAD LEGEND**

	INTERIOR LOAD BEARING WALL
	ROOF RAFTER / TRUSS SUPPORT
	DOUBLE RAFTER / DOUBLE JOIST
	STRUCTURAL BEAM / GIRDER
	WINDOW / DOOR HEADER
	POINT LOAD TRANSFER
	POINT LOAD FROM ABOVE BEARING ON BEAM / GIRDER

- STRUCTURAL FRAMING NOTES - (SEE GENERAL NOTES SHEET FOR ADDITIONAL REQUIREMENTS.)**
- ALL FRAMING TO BE #2 SPF MINIMUM.
  - ALL BEARING HEADERS TO BE (2) 2x6 SUPPORTED w/ MIN (1) JACK AND (1) KING EACH END, UNO.
  - EXTERIOR WALL OPENINGS OVER 3' TO HAVE MULTIPLE KING STUDS AS NOTED ON PLAN.
  - ALL NON-BEARING HEADERS TO BE (2) 2x4 (1) J / (1) K, UNO.
  - PROVIDE CONTINUOUS BLOCKING THROUGH STRUCTURE FOR ALL POINT LOADS.
  - ALL HANGERS AND CONNECTORS SPECIFIED ARE TO BE SIMPSON STRONG-TIE OR EQUIVALENT.
  - ALL BEAMS SPECIFIED ARE MINIMUM SIZES ONLY. LARGER MEMBERS MAY SUBSTITUTED AS NEEDED FOR EASE OF CONSTRUCTION. MINIMUM BEAM SUPPORT IS (1) 2x4 STUD.
  - ALL EXTERIOR WALLS TO BE FULLY SHEATHED WITH 7/16" OSB.
  - FRONT PORCH COLUMNS TO BE MIN 4x4 PT ATTACHED AT TOP AND BOTTOM USING SIMPSON (OR EQUIV) COLUMN BASE OR SST A24 BRACKETS. TRIM OUT PER BUILDER.
  - PORCH COLUMNS TO BE MIN 4x4 PT ATTACHED AT BOTTOM USING SIMPSON (OR EQUIV) ABA44 AND AT TOP USING CS 16 STRAPPING (12" MIN) TO PORCH HEADER / BAND.
  - WHEN A 4-PLY LVL IS USED, ATTACH WITH (1) 1/2" Ø BOLT 12" OC STAGGERED, TOP AND BOTTOM, 1-1/2" MIN FROM ENDS. ALTERNATE ATTACHMENT EQUIVALENT METHOD MAY BE USED, SUCH AS SDW OR TRUSSLOK SCREWS (SEE MANUFACTURER'S SPECIFICATIONS).
  - FOR STUD COLUMNS OF 4 OR MORE, INSTALL SST CS16 STRAPS @ 30" OC, 6" MAX FROM PLATES, ON INSIDE FACE OF COLUMN (EXTERIOR WALL), ON BOTH FACES OF COLUMN (INTERIOR WALL).

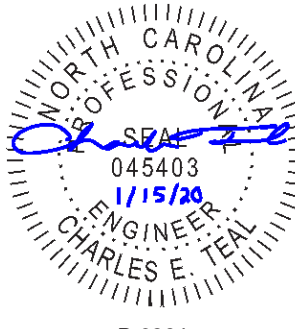

P-0961

**JDS**  
CONSULTING & DESIGN

JDS CONSULTING & DESIGN, PLLC  
8600 'D' JERSEY CT, RALEIGH, NC 27617  
919.480.1075

INFO@JDSDESIGNONLINE.COM  
WWW.JDSDESIGNONLINE.COM

PROJECT NO.: 20900080  
DATE: 01/15/2020

PLAN:  
240.2596

SECOND FLOOR  
CEILING FRAMING PLAN

**S2.0C**

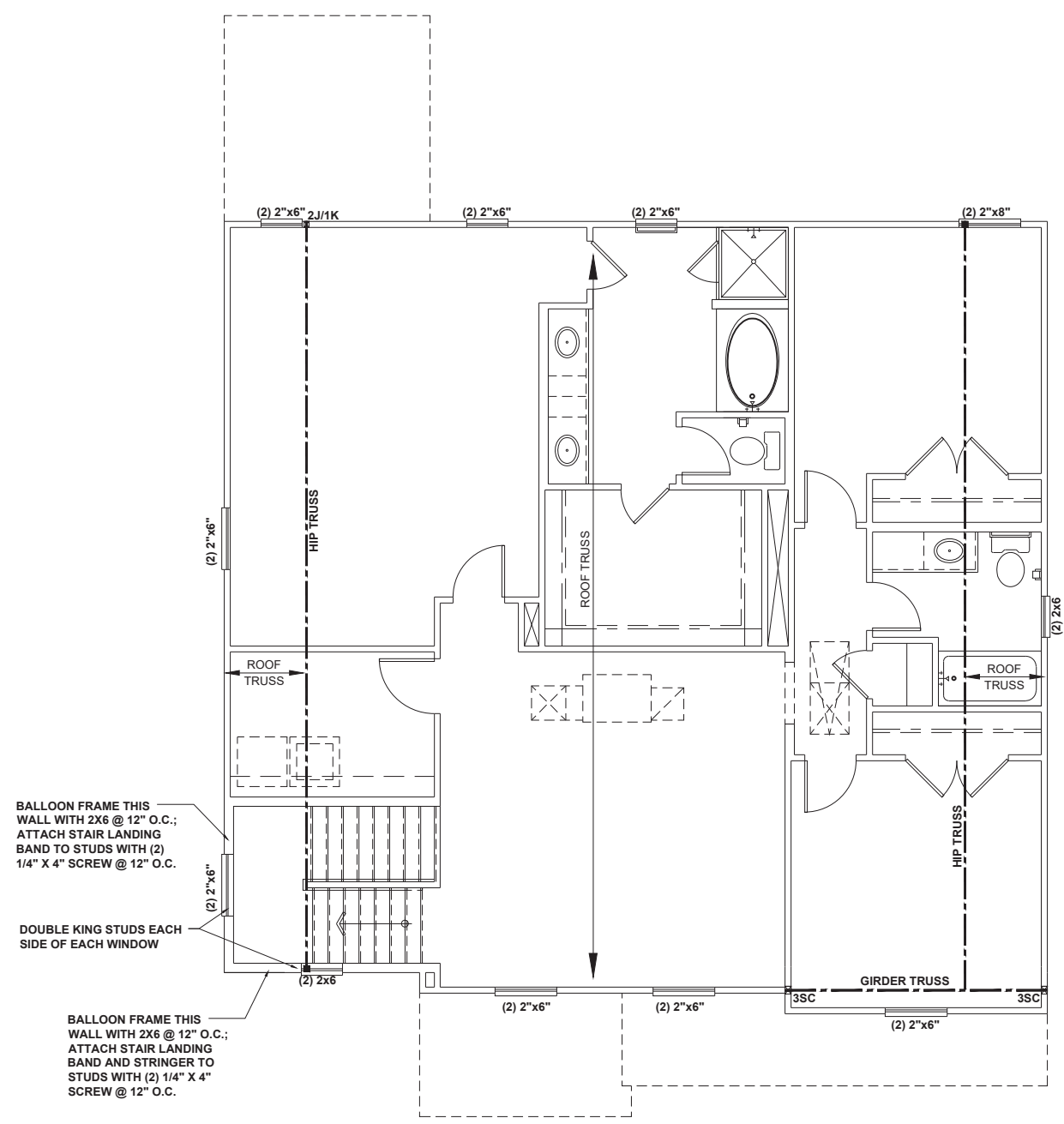

### SECOND FLOOR CEILING FRAMING PLAN - 'C'

SCALE: 1/8" = 1'-0"

These designs and drawings are CONFIDENTIAL, and the contents are the property of KB Home Corporation. They may not be used or replicated without the express permission of KB Home Corporation. Copyright 2018 © KB Home Corporation. All rights reserved.



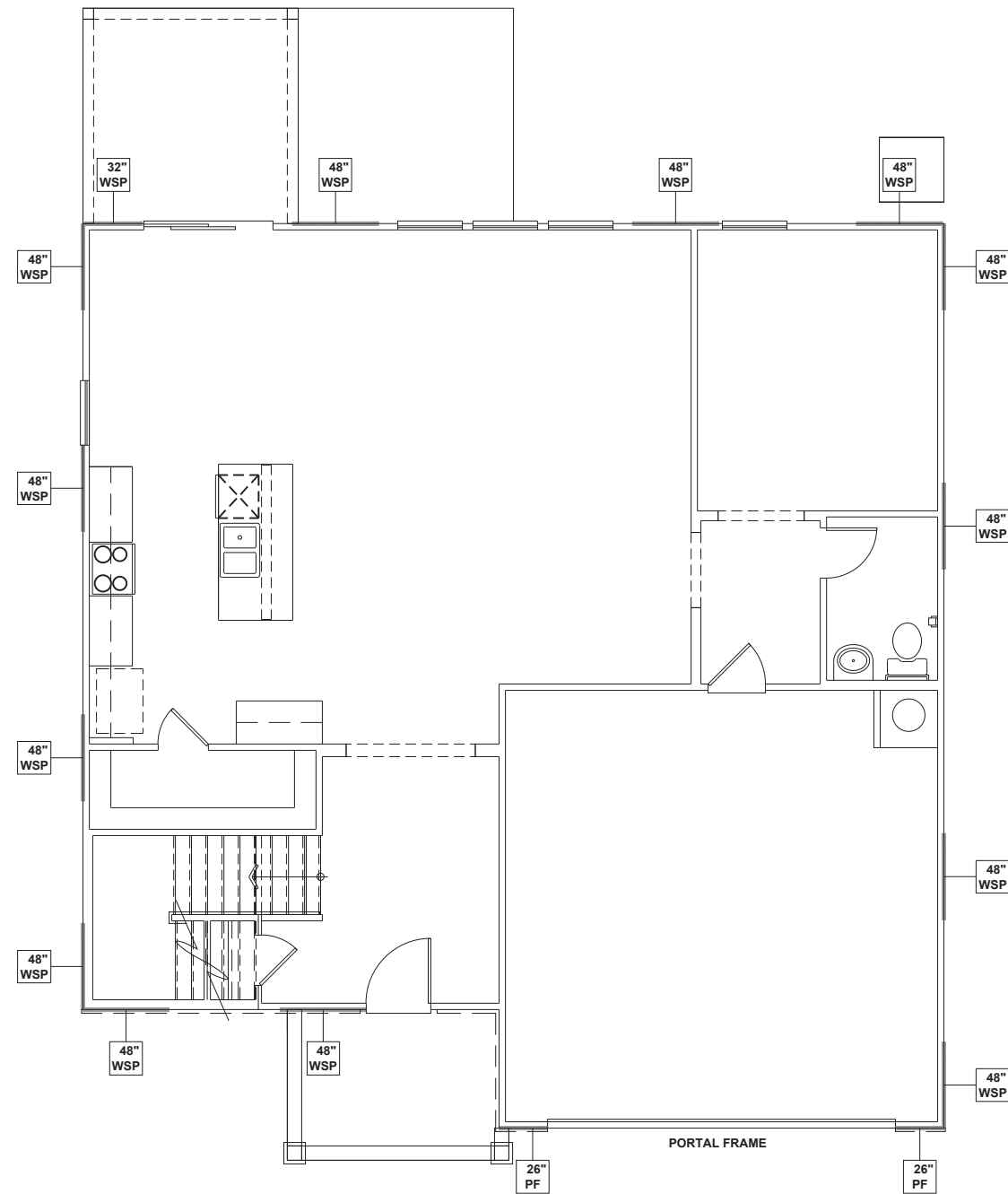

**FIRST FLOOR WALL BRACING PLAN - 'C'**

SCALE: 1/8"=1'-0"

**WALL BRACING REQUIREMENTS**

- MINIMUM PANEL WIDTH IS 24"
- FIGURES BASED ON THE CONTINUOUS SHEATHING METHOD USING THE RECTANGLE CIRCUMSCRIBED AROUND THE FLOOR PLAN OR PORTION OF THE FLOOR PLAN. IF NO RECTANGLE IS NOTED, THE STRUCTURE HAS BEEN FIGURED ALL WITHIN ONE RECTANGLE.
- PANELS MAY SHIFT UP TO 36" EITHER DIRECTION FOR EASE OF CONSTRUCTION (NAILING & BLOCK REQUIREMENTS STILL APPLY).
- FOR ADDITIONAL WALL BRACING INFORMATION, REFER TO WALL BRACING DETAIL SHEET(S).
- SCHEMATIC BELOW INDICATES HOW SIDES OF RECTANGLE ARE TO BE INTERPRETED IN BRACING CHART WHEN APPLIED TO STRUCTURE:

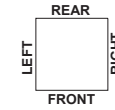

- ◆ CS16 STRAP FROM STUD, CROSS HEADER, TO WALL TOP PLATE, 36" LONG MINIMUM
- ▶ SIMPSON MSTA15 HOLD DOWN CAPACITY OF 970 POUNDS PER ANCHOR WITH (12) 10d NAILS. STRAP TO BE LOCATED AT EDGE OF BRACED WALL PANEL. (CS16 STRAPPING MAY BE SUBSTITUTED w/ SIMILAR LENGTH AND NAILING PATTERN.) USE HTT4 FOR ATTACHMENT TO CONCRETE.

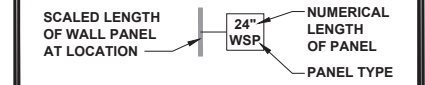

**WALL BRACING: RECTANGLE 1**

SIDE	REQUIRED LENGTH	PROVIDED LENGTH
FRONT	12.0 FT.	16.6 FT.
RIGHT	12.0 FT.	16.0 FT.
REAR	12.0 FT.	14.6 FT.
LEFT	12.0 FT.	16.0 FT.



KB HOME  
NORTH CAROLINA DIVISION  
4518 S. MIAMI BLVD.  
SUITE 180  
DURHAM, NC 27703  
TEL: (919) 768-7988  
FAX: (919) 472-0582

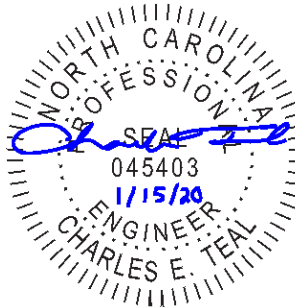

P-0961

JDS CONSULTING & DESIGN, PLLC  
8600 'D' JERSEY CT, RALEIGH, NC 27617  
919.480.1075  
INFO@JDSDESIGNONLINE.COM  
WWW.JDSDESIGNONLINE.COM

PROJECT NO.: 20900080  
DATE: 01/15/2020

PLAN:  
**240.2596**

FIRST FLOOR  
WALL BRACING PLAN  
**S4.0C**

These designs and drawings are CONFIDENTIAL, and the enclosure property of KB Home Corporation and are not to be disclosed without the express permission of KB Home Corporation. Copyright 2019 © KB Home Corporation. All rights reserved.

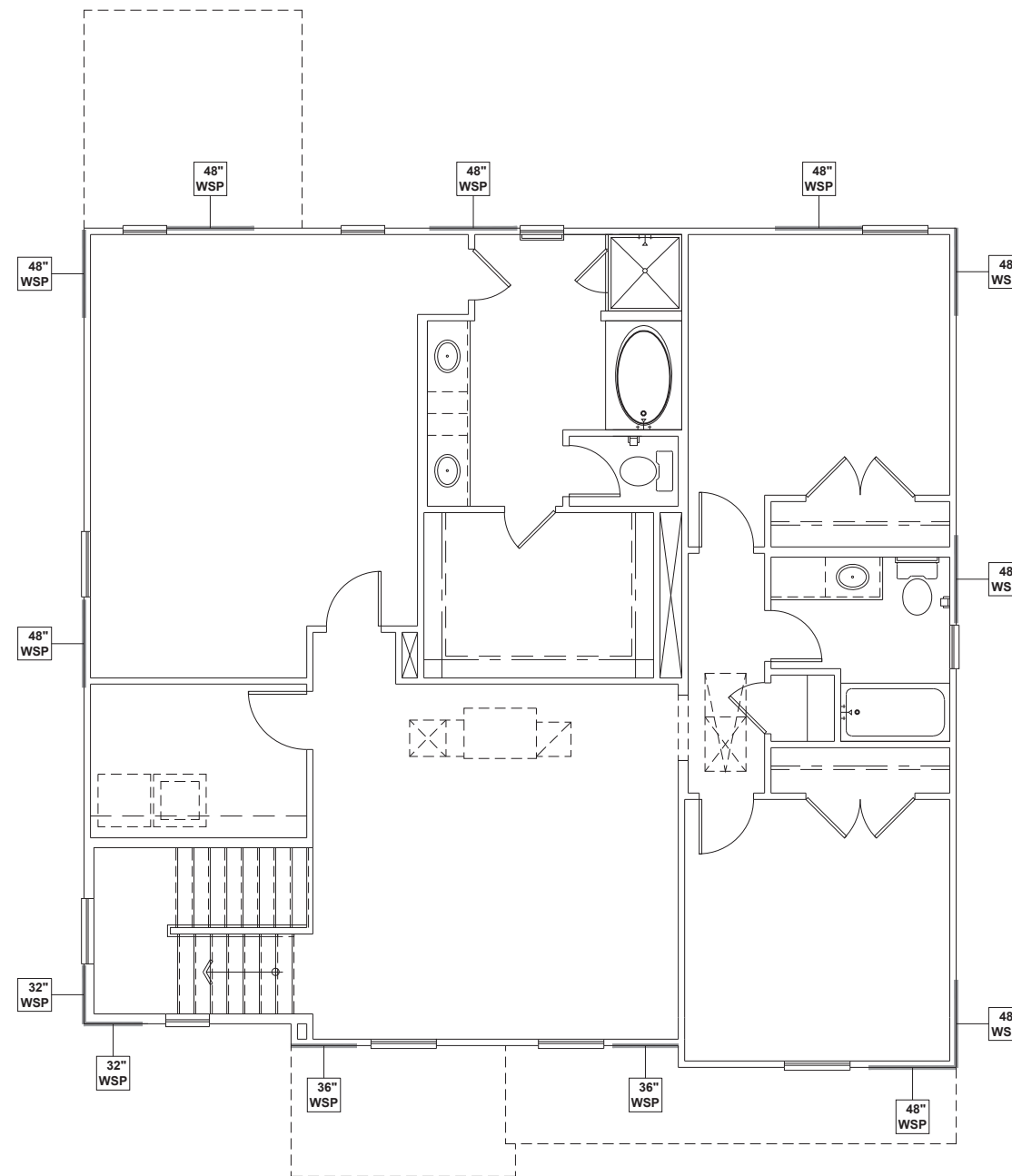

**SECOND FLOOR WALL BRACING PLAN - 'C'**

SCALE: 1/8" = 1'-0"

**WALL BRACING REQUIREMENTS**

- MINIMUM PANEL WIDTH IS 24"
- FIGURES BASED ON THE CONTINUOUS SHEATHING METHOD USING THE RECTANGLE CIRCUMSCRIBED AROUND THE FLOOR PLAN OR PORTION OF THE FLOOR PLAN. IF NO RECTANGLE IS NOTED, THE STRUCTURE HAS BEEN FIGURED ALL WITHIN ONE RECTANGLE.
- PANELS MAY SHIFT UP TO 36" EITHER DIRECTION FOR EASE OF CONSTRUCTION (NAILING & BLOCK REQUIREMENTS STILL APPLY).
- FOR ADDITIONAL WALL BRACING INFORMATION, REFER TO WALL BRACING DETAIL SHEET(S).
- SCHEMATIC BELOW INDICATES HOW SIDES OF RECTANGLE ARE TO BE INTERPRETED IN BRACING CHART WHEN APPLIED TO STRUCTURE:

- ◆ CS16 STRAP FROM STUD, CROSS HEADER, TO WALL TOP PLATE, 36" LONG MINIMUM
- ▶ SIMPSON MSTA15 HOLD DOWN CAPACITY OF 970 POUNDS PER ANCHOR WITH (12) 10d NAILS. STRAP TO BE LOCATED AT EDGE OF BRACED WALL PANEL. (CS16 STRAPPING MAY BE SUBSTITUTED w/ SIMILAR LENGTH AND NAILING PATTERN.) USE HTT4 FOR ATTACHMENT TO CONCRETE.

**WALL BRACING: RECTANGLE 1**

SIDE	REQUIRED LENGTH	PROVIDED LENGTH
FRONT	6.0 FT.	12.6 FT.
RIGHT	6.0 FT.	12.0 FT.
REAR	6.0 FT.	12.0 FT.
LEFT	6.0 FT.	14.6 FT.



KB HOME  
NORTH CAROLINA DIVISION  
4518 S. MIAMI BLVD.  
SUITE 180  
DURHAM, NC 27703  
TEL: (919) 768-7988  
FAX: (919) 472-0582

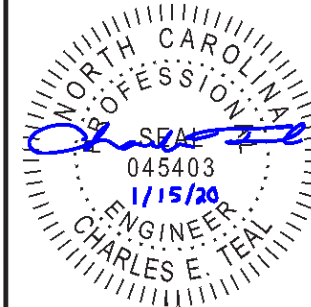

P-0961

**JDS**  
CONSULTING & DESIGN

JDS CONSULTING & DESIGN, PLLC  
8600 'D' JERSEY CT, RALEIGH, NC 27617  
919.480.1075

INFO@JDSDESIGNONLINE.COM  
WWW.JDSDESIGNONLINE.COM

PROJECT NO.: 20900080  
DATE: 01/15/2020

PLAN:  
**240.2596**

SECOND FLOOR  
WALL BRACING PLAN  
**S5.0C**

These designs and drawings are CONFIDENTIAL, and the enclosure property of KB Home Corporation and are not to be disclosed without the express permission of KB Home Corporation. Copyright 2019 © KB Home Corporation. All rights reserved.

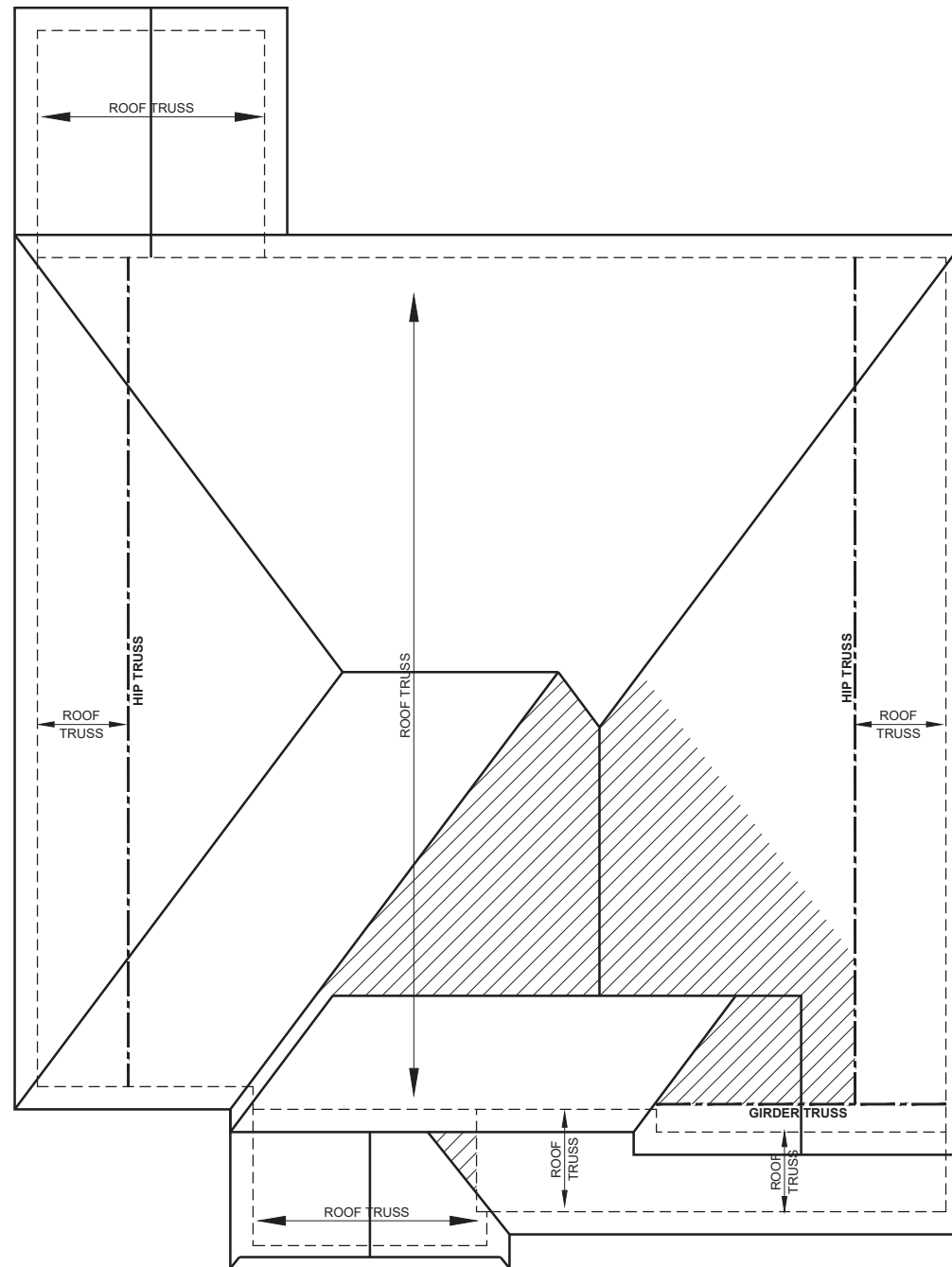

**ROOF FRAMING PLAN - 'C'**

SCALE: 1/8"=1'-0"

**BEAM & POINT LOAD LEGEND**

	INTERIOR LOAD BEARING WALL
	ROOF RAFTER / TRUSS SUPPORT
	DOUBLE RAFTER / DOUBLE JOIST
	STRUCTURAL BEAM / GIRDER
	WINDOW / DOOR HEADER
	POINT LOAD TRANSFER
	POINT LOAD FROM ABOVE BEARING ON BEAM / GIRDER

- TRUSSED ROOF - STRUCTURAL NOTES**
1. PROVIDE CONTINUOUS BLOCKING THROUGH STRUCTURE FOR ALL POINT LOADS.
  2. DENOTES OVER-FRAMED AREA
  3. MINIMUM 7/16" OSB ROOF SHEATHING
  4. TRUSS LAYOUT AND PLACEMENT BY MANUFACTURER TO COINCIDE WITH THE SUPPORT LOCATIONS SHOWN. TRUSS PROFILES SHALL BE SEALED BY THE TRUSS MANUFACTURER. TRUSS PLANS TO BE COORDINATED WITH THE SEALED STRUCTURAL DRAWINGS. INSTALLATION SHALL BE IN ACCORDANCE WITH THE MANUFACTURER'S INSTRUCTIONS.
  5. MANUFACTURER TO PROVIDE REQUIRED UPLIFT CONNECTION.
  6. PROVIDE H2.5A (MINIMUM) OR EQUIVALENT AT EACH TRUSS-TO-TOP PLATE CONNECTION AT OVER-FRAMED AREAS, UNLESS NOTED OTHERWISE.
  7. UPLIFT CONNECTION TO BE CARRIED THROUGH TO FLOOR SYSTEM.

**TRUSS UPLIFT CONNECTORS: EXPOSURE B, 115 MPH, ANY PITCH, 24" O.C. MAX ROOF TRUSS SPACING**

TRUSSES SHALL BE ATTACHED TO SUPPORT WALL FOR UPLIFT RESISTANCE. CONTINUOUS OSB WALL SHEATHING BELOW PROVIDES CONTINUOUS UPLIFT RESISTANCE TO FOUNDATION. ALL TRUSSES SUPPORTED BY INTERMEDIATE SUPPORT WALLS, KNEEWALLS, OR BEAMS SHALL BE ATTACHED TO SUPPORTING MEMBER PER SCHEDULE:

ROOF SPAN IS MEASURED HORIZONTALLY BETWEEN FURTHEST SUPPORT POINTS.

<b>ROOF PLAN UP TO 28'</b>	<b>CONNECTOR</b> NAILING PER TABLE 602.3(1) NCRBC 2018 EDITION
<b>OVER 28'</b>	(1) SIMPSON H2.5A HURRICANE CLIP TO DBL TOP PLATE OR BEAM  OR (1) SIMPSON H3 CLIP TO SINGLE 2x4 PLATE



KB HOME  
NORTH CAROLINA DIVISION  
4518 S. MIAMI BLVD.  
SUITE 180  
DURHAM, NC 27703  
TEL: (919) 768-7988  
FAX: (919) 472-0582

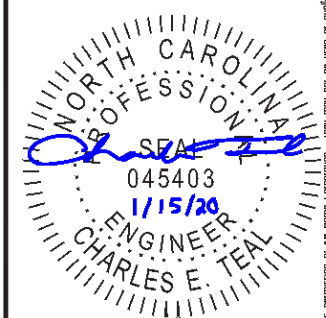

P-0961

**JDS**  
CONSULTING & DESIGN

JDS CONSULTING & DESIGN, PLLC  
8600 'D' JERSEY CT, RALEIGH, NC 27617  
919.480.1075

INFO@JDSDESIGNONLINE.COM  
WWW.JDSDESIGNONLINE.COM

PROJECT NO.: 20900080  
DATE: 01/15/2020

PLAN:  
**240.2596**

ROOF FRAMING PLAN  
**S7.0C**

These designs and drawings are CONFIDENTIAL, and the enclosure property of KB Home Corporation and are not to be disclosed without the express permission of KB Home Corporation. Copyright 2019 © KB Home Corporation, all rights reserved.



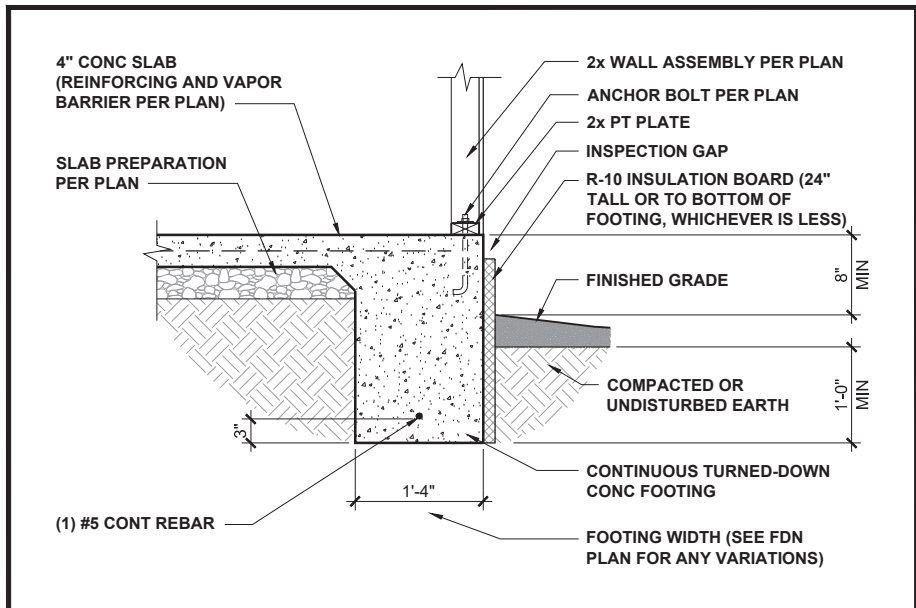

**TURNED-DOWN CONC SLAB FOOTING** 1/2" = 1'-0" **1**

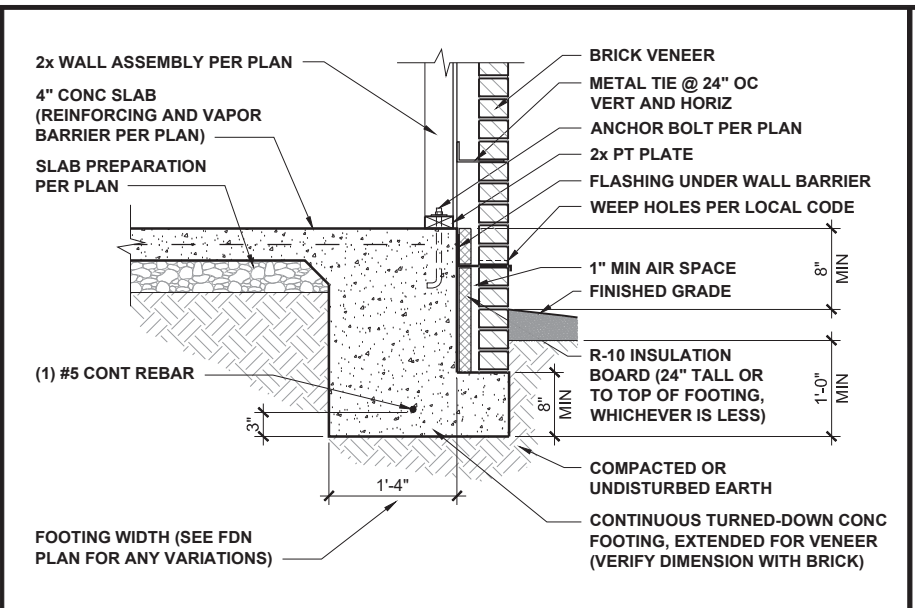

**TURNED-DOWN FOOTING w/ BRICK** 1/2" = 1'-0" **2**

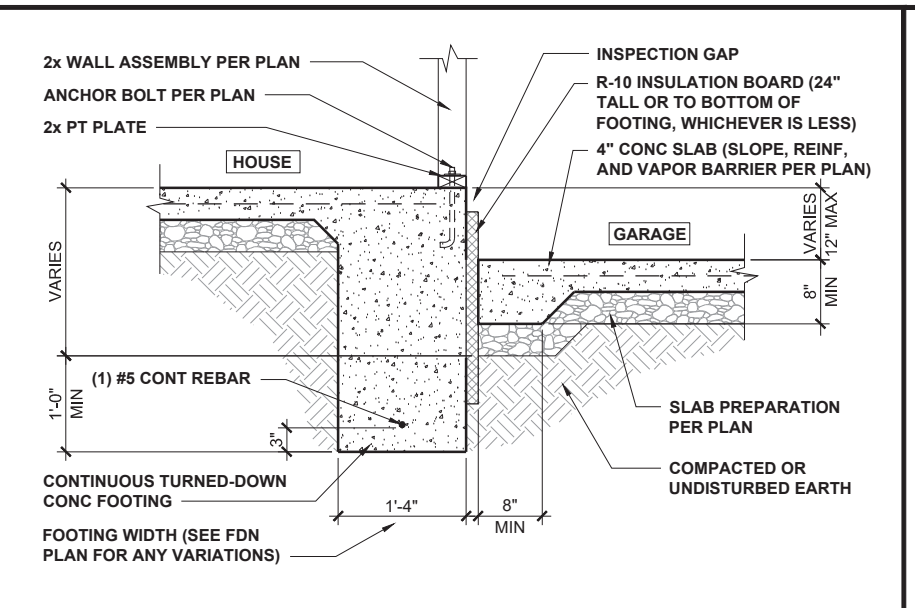

**HOUSE / GARAGE FOOTING** 1/2" = 1'-0" **3**

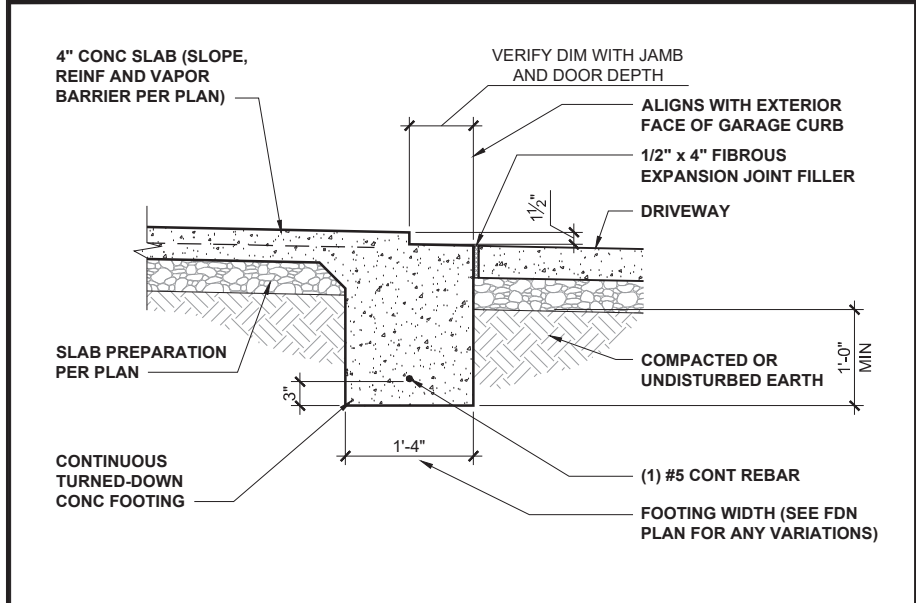

**GARAGE DOORWAY FOOTING** 1/2" = 1'-0" **4**

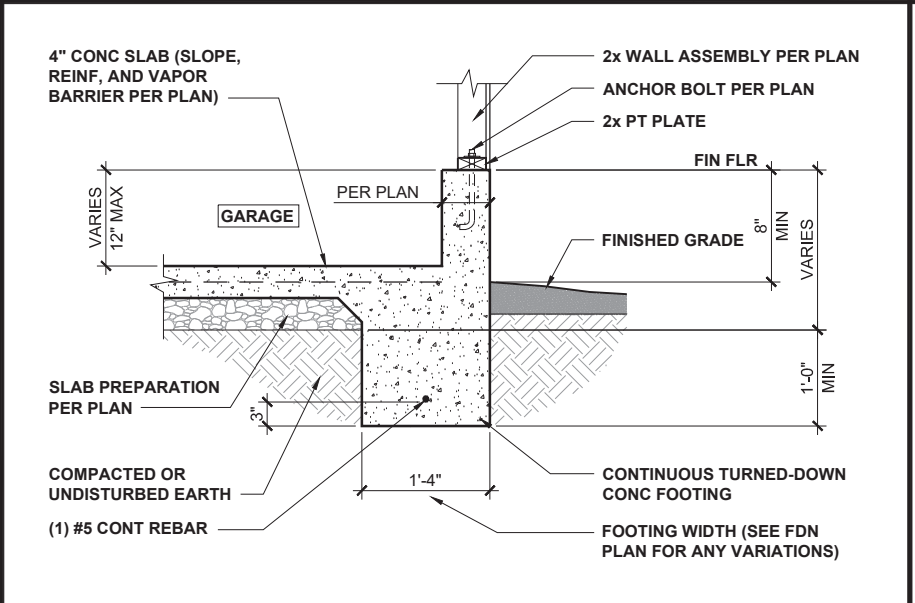

**GARAGE FOUNDATION** 1/2" = 1'-0" **5**

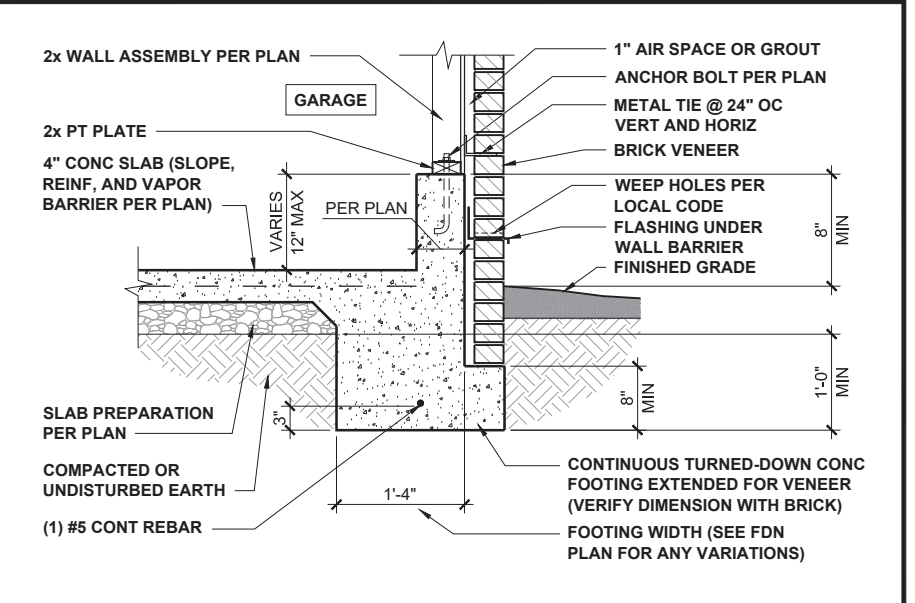

**GARAGE FOUNDATION WITH BRICK** 1/2" = 1'-0" **6**

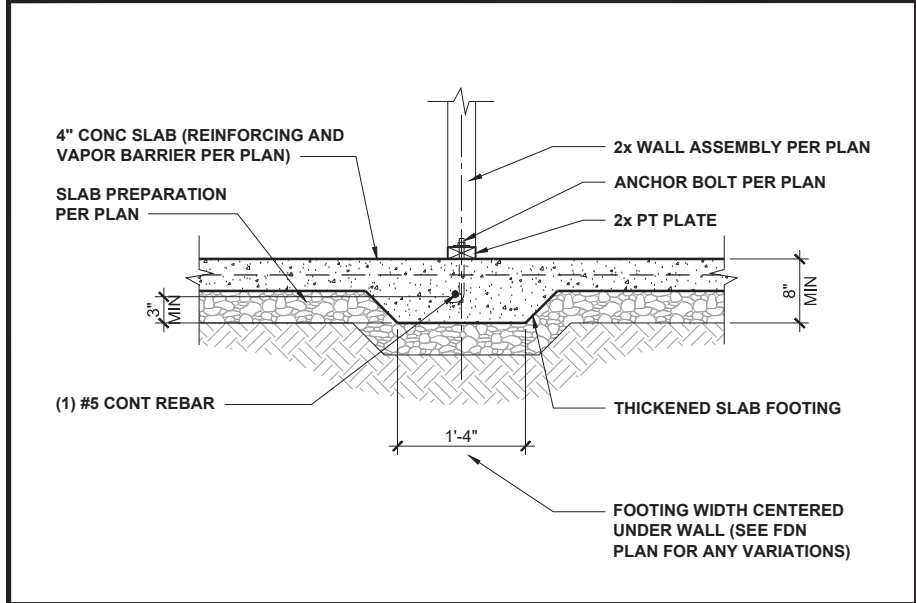

**INTERIOR FOOTING** 1/2" = 1'-0" **7**

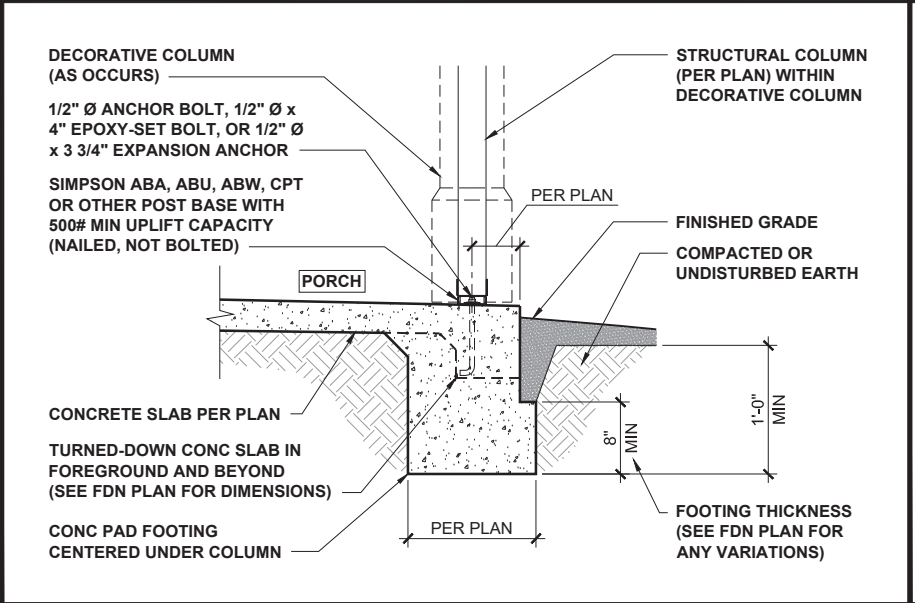

**PORCH COLUMN FOUNDATION** 1/2" = 1'-0" **8**

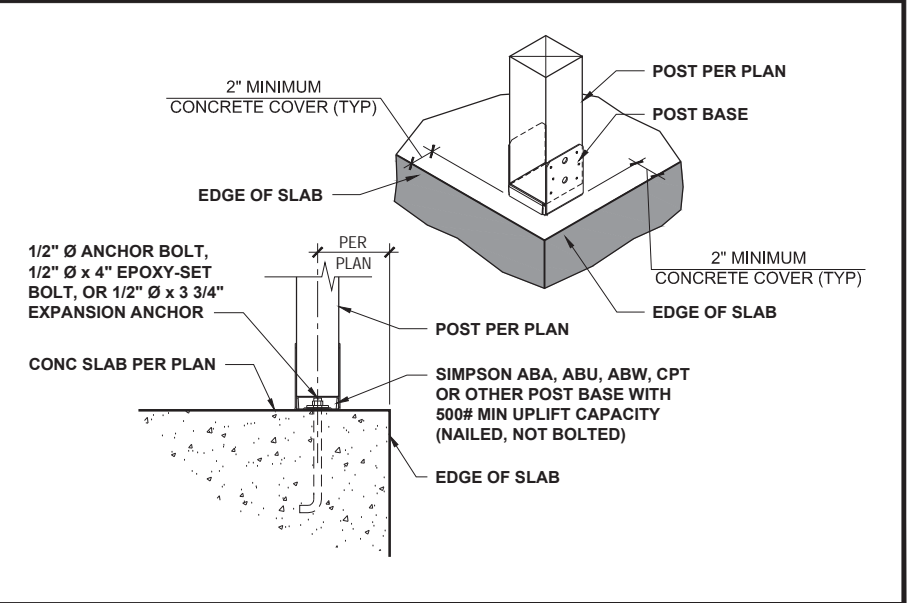

**PORCH COLUMN** 3/4" = 1'-0" **9**



KB HOME  
NORTH CAROLINA DIVISION  
4518 S. MIAMI BLVD.  
SUITE 180  
DURHAM, NC 27703  
TEL: (919) 768-7988  
FAX: (919) 472-0582

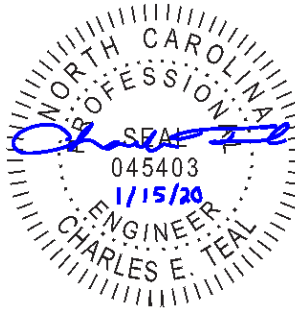

P-0961

JDS CONSULTING & DESIGN, PLLC  
8600 'D' JERSEY CT, RALEIGH, NC 27617  
919.480.1075  
INFO@JDSDESIGNONLINE.COM  
WWW.JDSDESIGNONLINE.COM

PROJECT NO.: 20900080  
DATE: 01/15/2020

PLAN:  
**240.2596**

TURNED-DOWN SLAB  
FOUNDATION DETAILS

**D1.0**

These designs and drawings are CONFIDENTIAL and the exclusive property of KB Home Corporation and are not to be disclosed without the express permission of KB Home Corporation. Copyright 2018 © KB Home Corporation. All rights reserved.

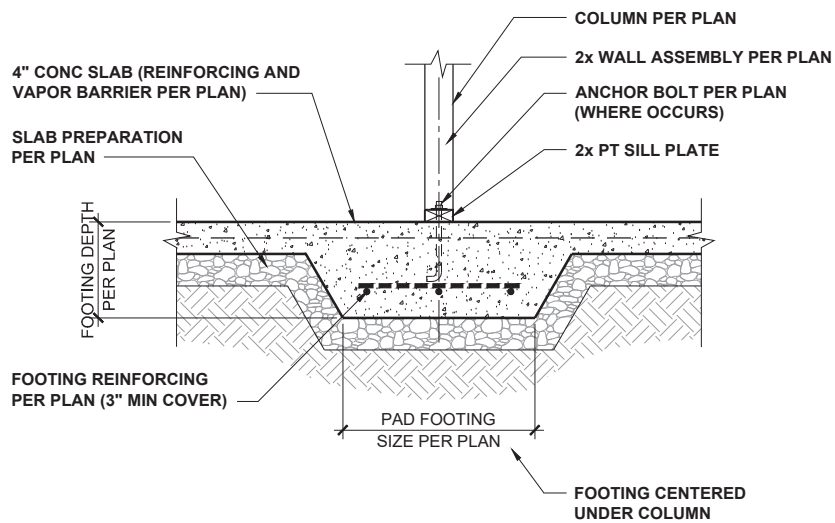

INT POINT-LOAD FOOTING SECTION 1/2" = 1'-0" **1**

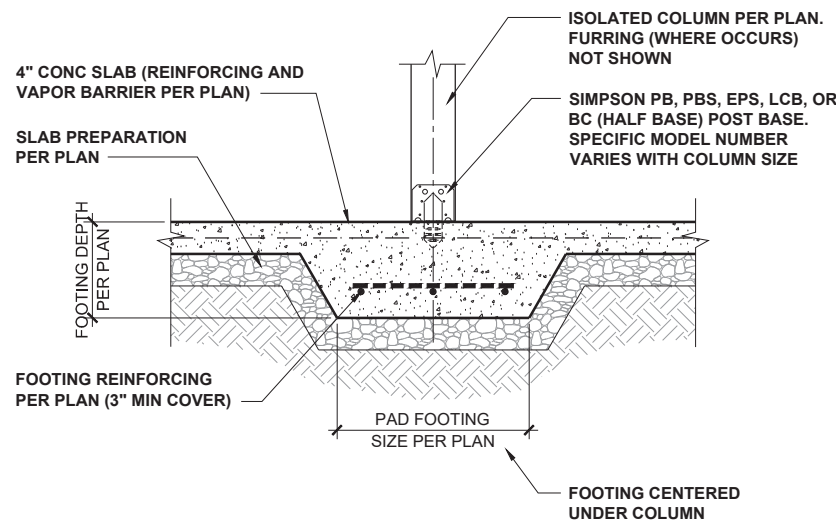

ISOLATED COLUMN FOOTING 1/2" = 1'-0" **2**

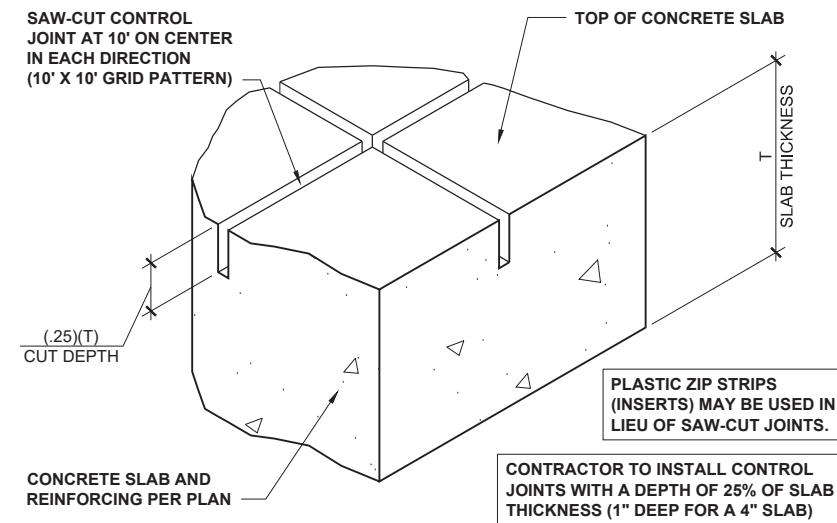

CONCRETE SLAB CONTROL JOINTS 3" = 1'-0" **3**

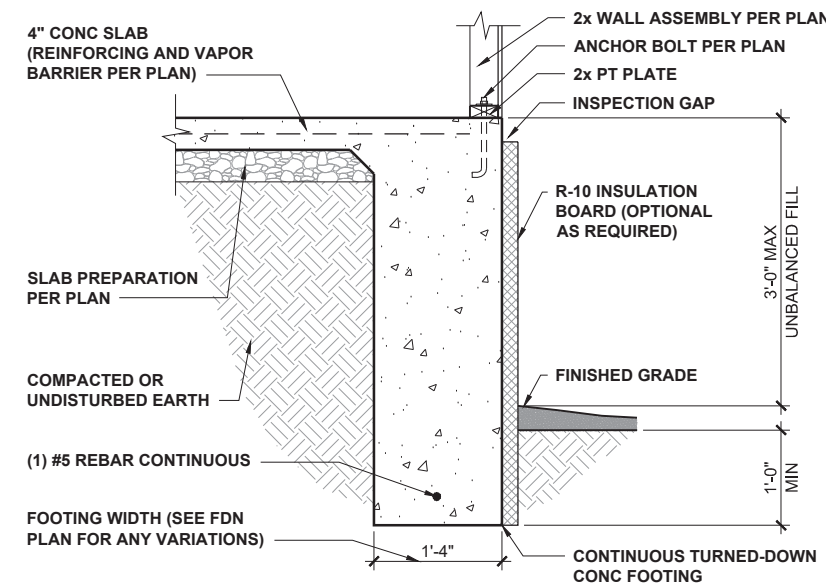

3' EXTENDED TURNED DOWN FOOTING 1/2" = 1'-0" **4**

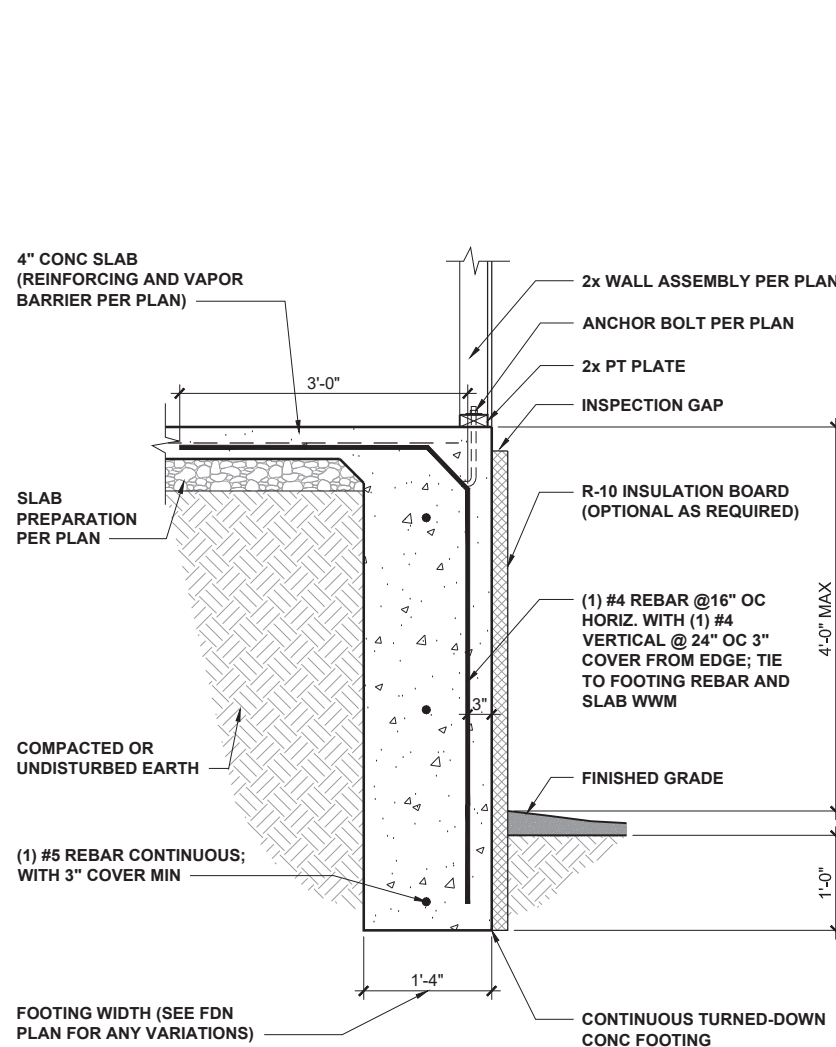

4' EXTENDED RETAINED FOOTING 1/2" = 1'-0" **6**

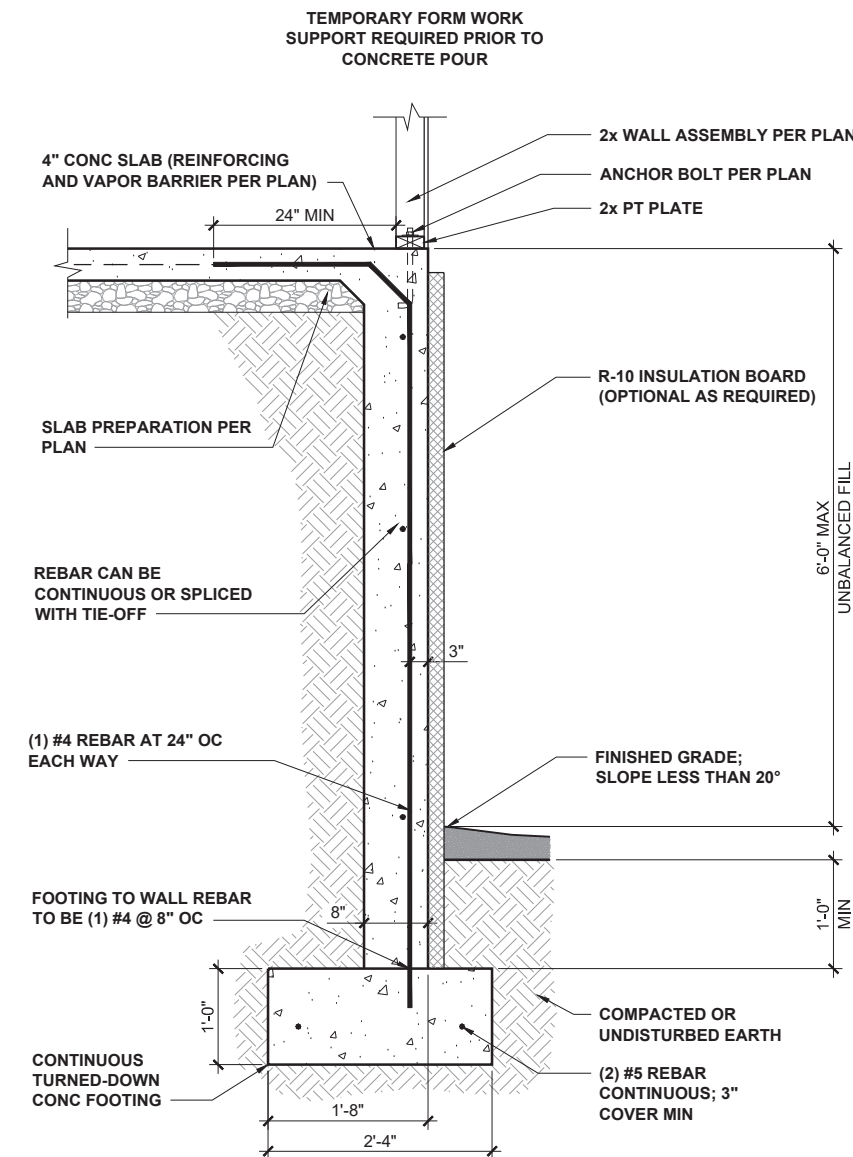

6' EXTENDED REINFORCED FOOTING 1/2" = 1'-0" **7**

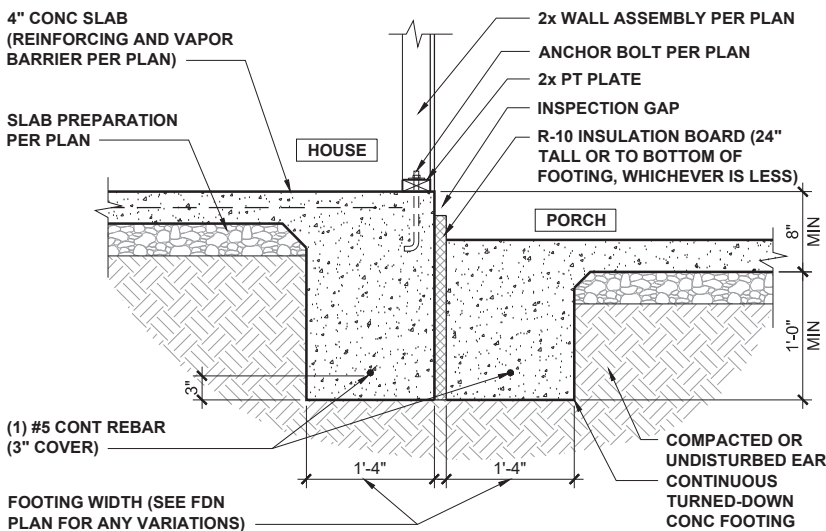

FOOTING AT HOUSE/PORCH 1/2" = 1'-0" **5**



KB HOME  
NORTH CAROLINA DIVISION  
4518 S. MIAMI BLVD.  
SUITE 180  
DURHAM, NC 27703  
TEL: (919) 768-7988  
FAX: (919) 472-0582

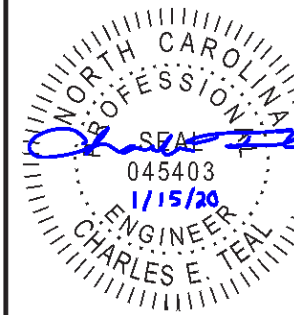

P-0961



JDS CONSULTING & DESIGN, PLLC  
8600 'D' JERSEY CT, RALEIGH, NC 27617  
919.480.1075

INFO@JDSDESIGNONLINE.COM  
WWW.JDSDESIGNONLINE.COM

PROJECT NO.: 20900080  
DATE: 01/15/2020

PLAN:  
**240.2596**

TURNED-DOWN SLAB  
FOUNDATION DETAILS

**D2.0**

These designs and drawings are CONFIDENTIAL, and the contents are the property of KB Home Corporation and are not to be disclosed without the express permission of KB Home Corporation. Copyright 2018 © KB Home Corporation. All rights reserved.



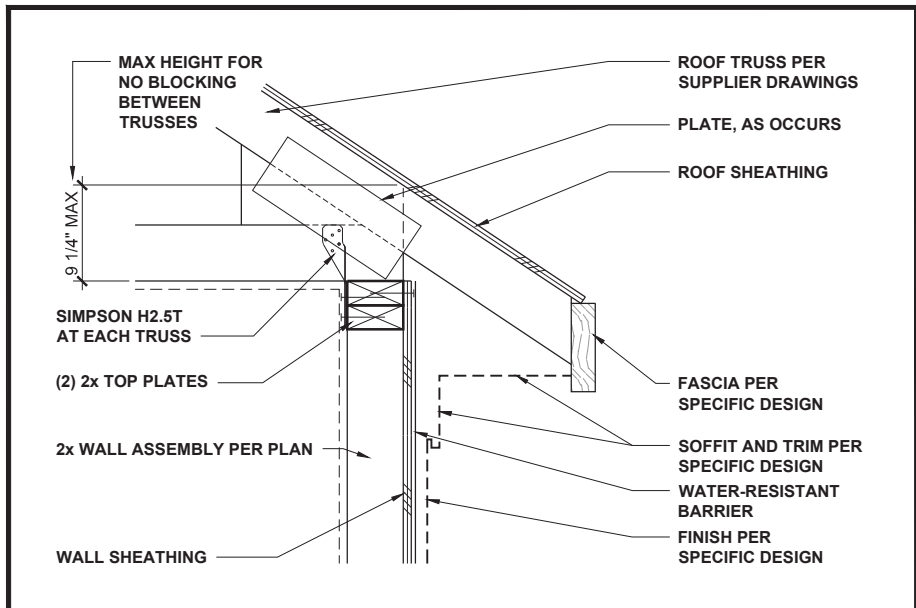

**LOW-HEEL TRUSS AT WALL** 1" = 1'-0" **1**

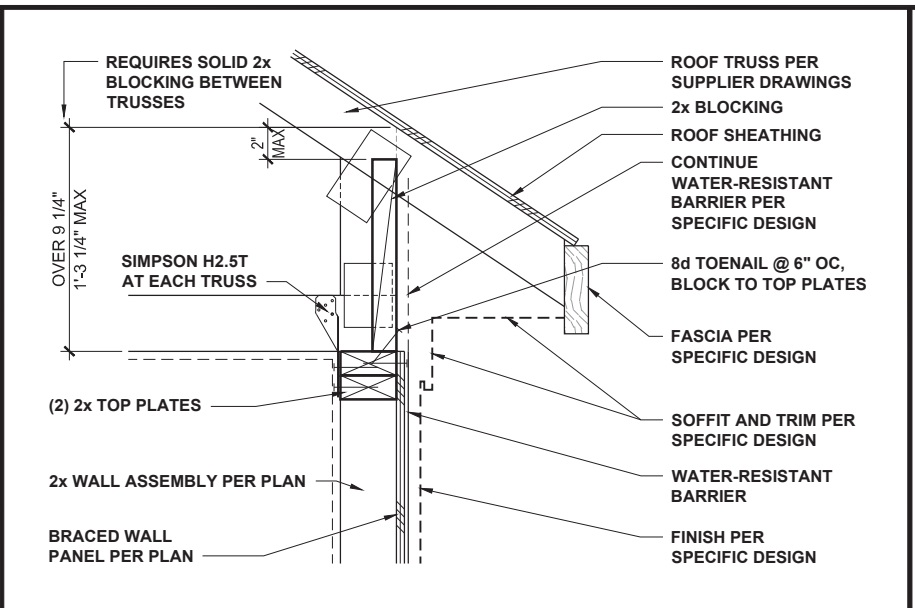

**TYPICAL TRUSS AT BRACED WALL** 1" = 1'-0" **2**

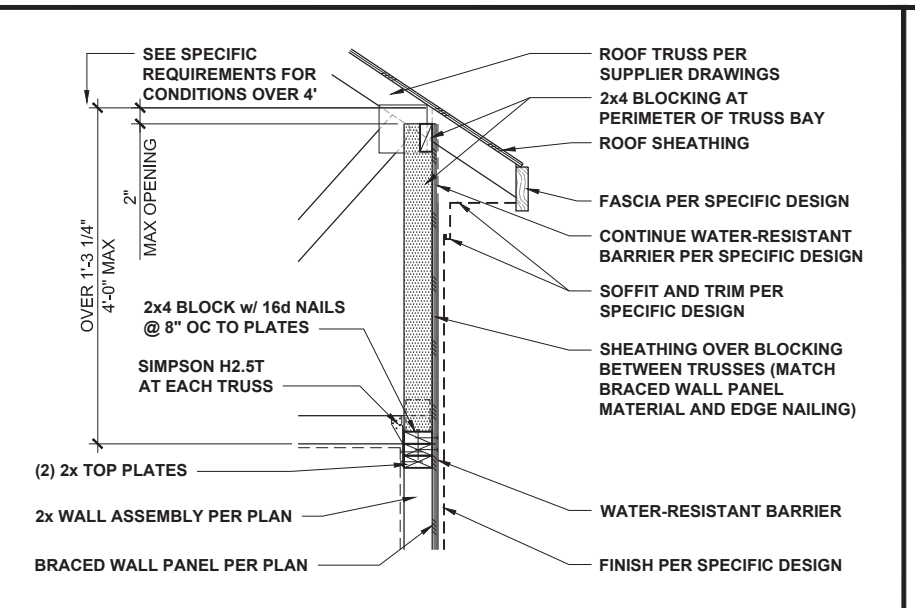

**HIGH-HEEL TRUSS AT BRACED WALL** 1/2" = 1'-0" **3**

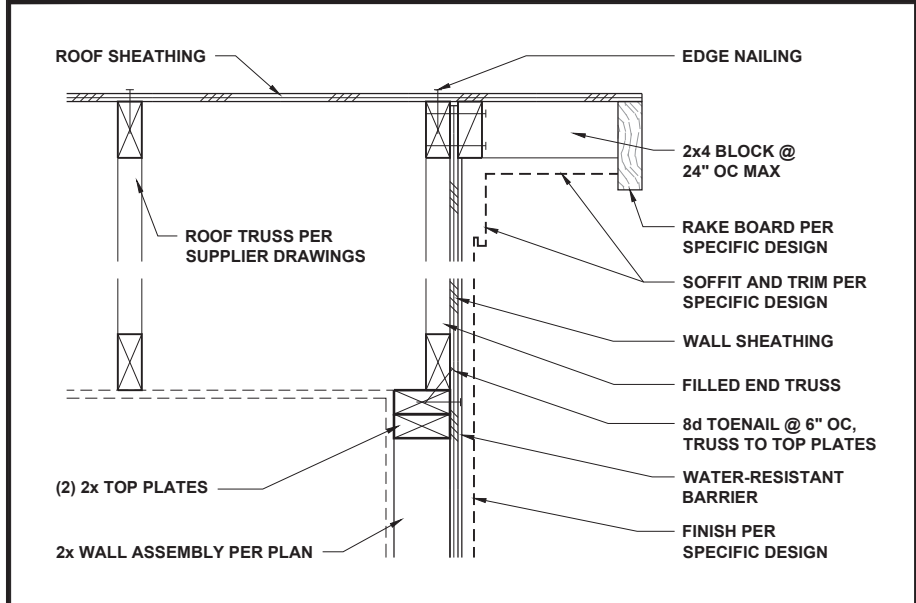

**END TRUSS AT WALL** 1" = 1'-0" **4**

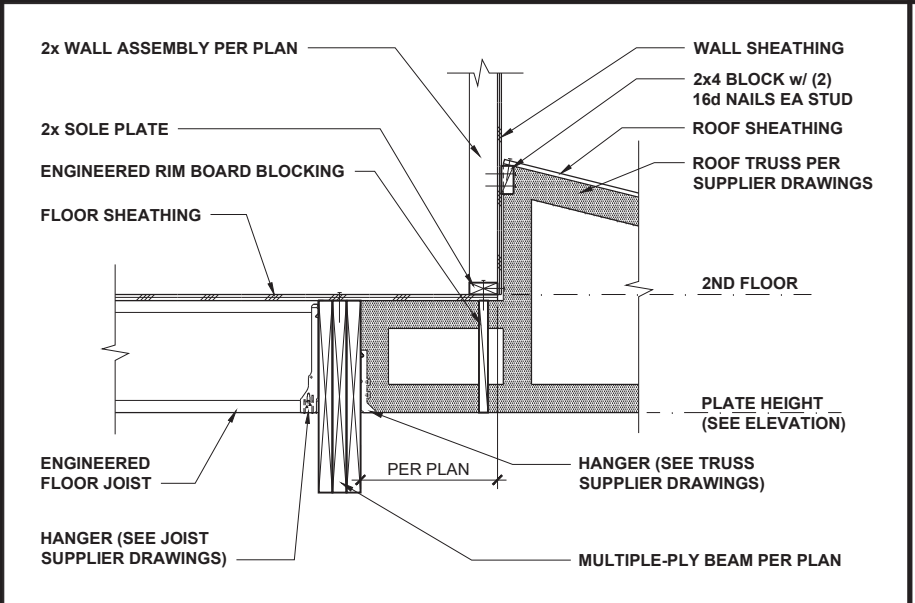

**TRUSS AT BEAM AND WALL** 1/2" = 1'-0" **5**

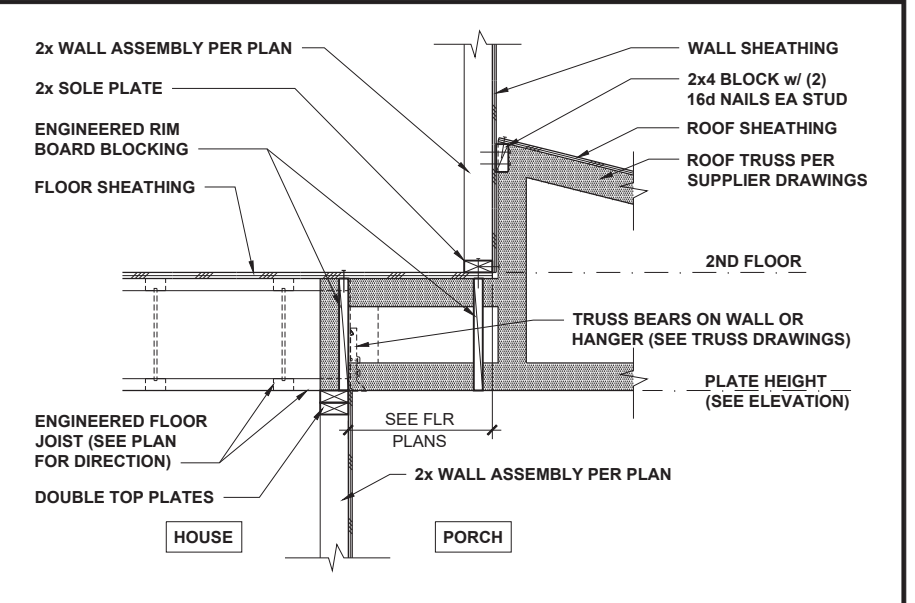

**TRUSS AT FLOOR AND WALL** 1/2" = 1'-0" **6**

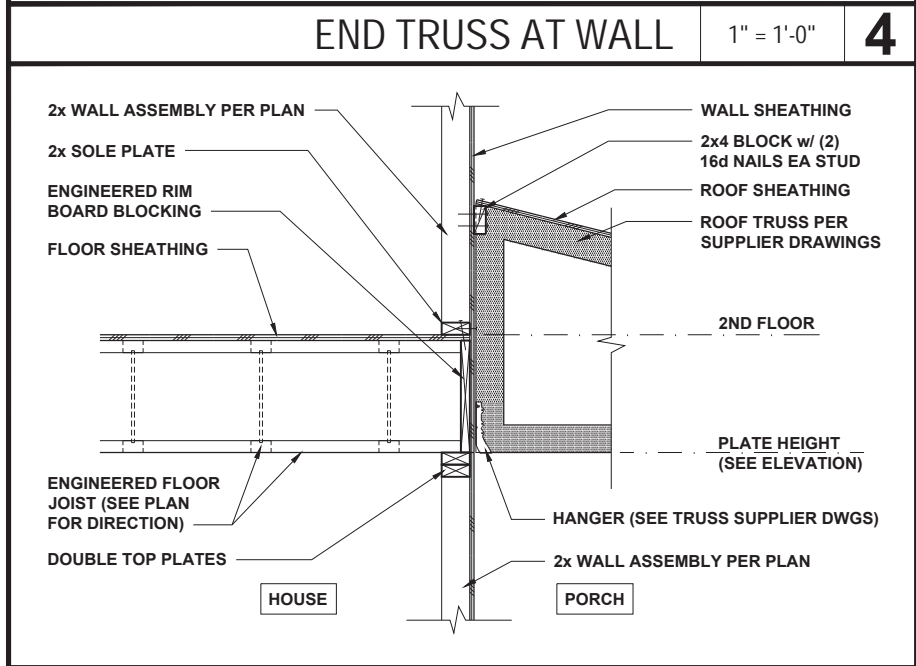

**TRUSS AT FLOOR AND WALL** 1/2" = 1'-0" **7**

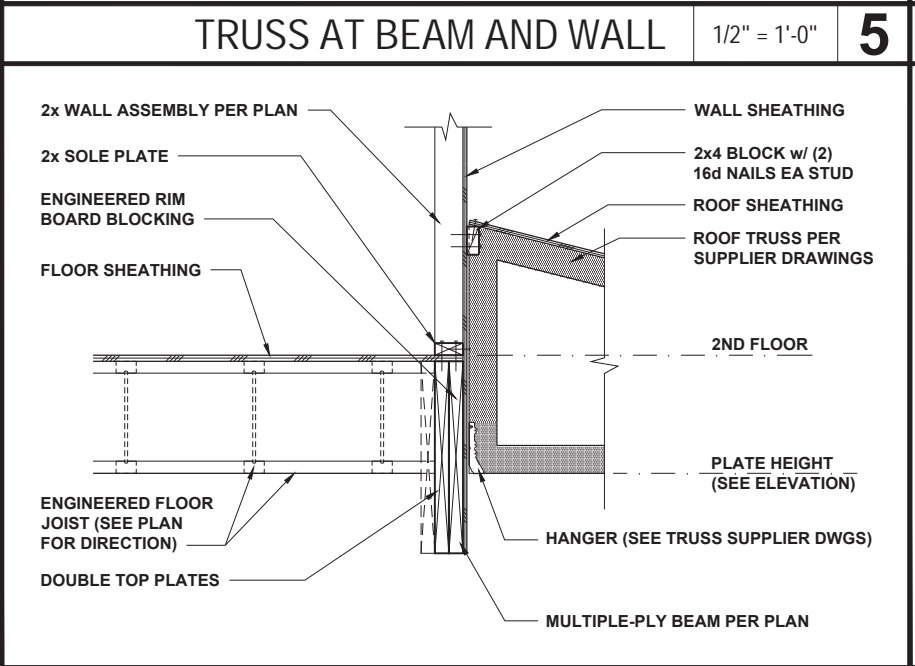

**TRUSS AT BEAM AND WALL** 1/2" = 1'-0" **8**

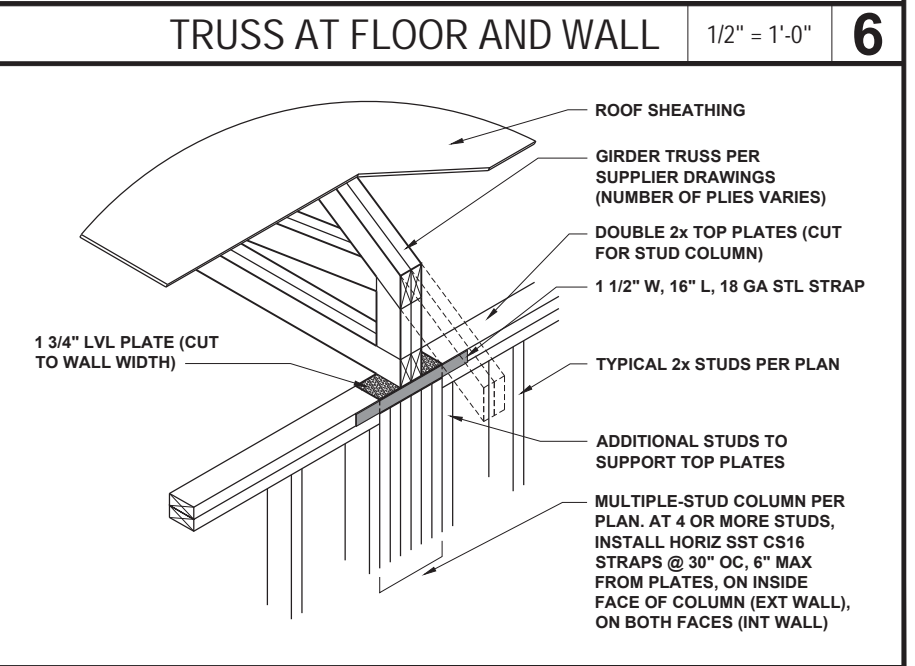

**GIRDER TRUSS AT WALL** 1/2" = 1'-0" **9**



KB HOME  
NORTH CAROLINA DIVISION  
4518 S. MIAMI BLVD.  
SUITE 180  
DURHAM, NC 27703  
TEL: (919) 768-7988  
FAX: (919) 472-0582

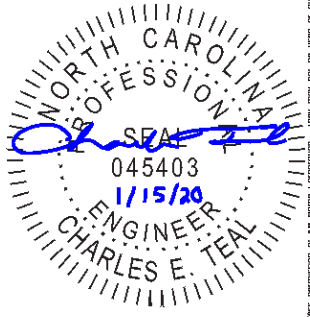

P-0961



PROJECT NO.: 20900080  
DATE: 01/15/2020

PLAN:  
**240.2596**

ROOF TRUSS  
FRAMING DETAILS  
**D4.0**

These designs and drawings are CONFIDENTIAL, and the contents are the property of KB Home Corporation and are not to be disclosed without the express permission of KB Home Corporation. Copyright 2018 © KB Home Corporation. All rights reserved.





KB HOME  
NORTH CAROLINA DIVISION  
4518 S. MIAMI BLVD.  
SUITE 180  
DURHAM, NC 27703  
TEL: (919) 768-7988  
FAX: (919) 472-0582



P-0961



JDS CONSULTING & DESIGN, PLLC  
8600 'D' JERSEY CT. RALEIGH, NC 27617  
919.480.1075  
INFO@JDSDESIGNONLINE.COM  
WWW.JDSDESIGNONLINE.COM

PROJECT NO.: 20900080  
DATE: 01/15/2020

PLAN:  
240.2596

WALL BRACING DETAILS

D8.0

These designs and drawings are CONFIDENTIAL, and the enclosure property of KB Home Corporation and are not to be disclosed without the express permission of KB Home Corporation. Copyright 2018 © KB Home Corporation. All rights reserved. They may not be used or replicated without the express permission of KB Home Corporation.

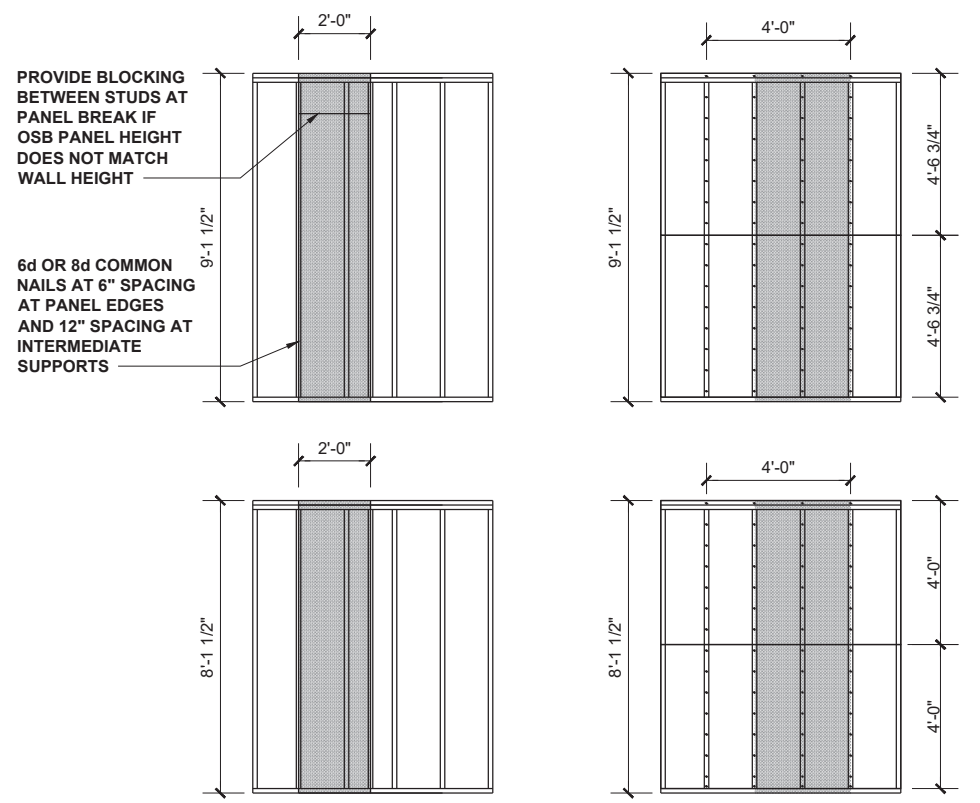
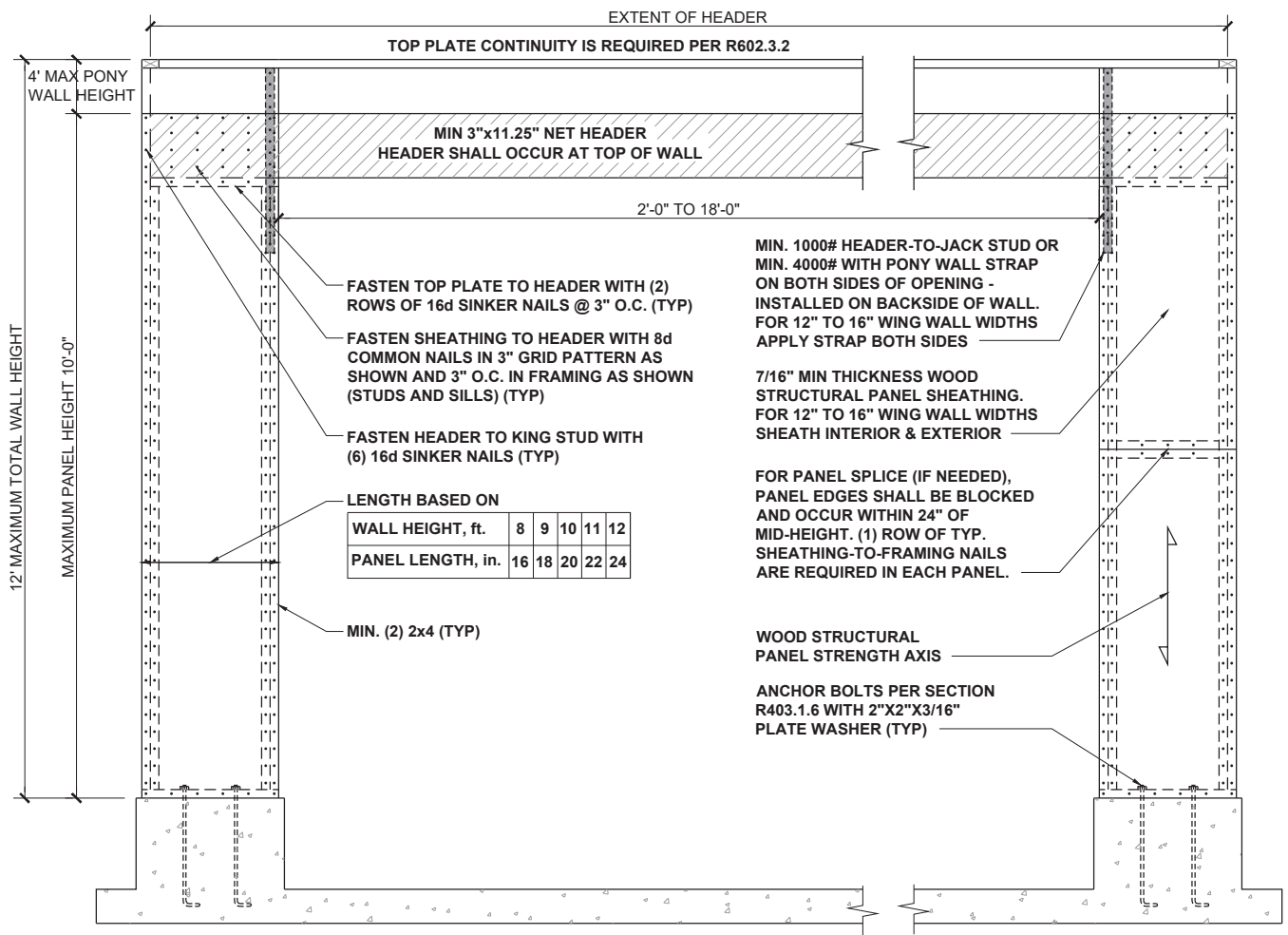

**CS-WSP - WOOD STRUCTURAL PANEL (CONTINUOUSLY SHEATHED)**

BRACED WALL PANEL 7/16" MIN. OSB SHEATHING ON ONE SIDE OF WALL. MINIMUM PANEL LENGTH 24".

**GB - GYPSUM BOARD**

BRACED WALL PANEL 1/2" GYPSUM BOARD NAILED TO STUDS AT 7" O.C. USING 5d COOLER NAILS OR #6 SCREWS. MINIMUM PANEL LENGTH 48" WHEN APPLIED TO BOTH SIDES OF WALL AND 96" WHEN APPLIED TO ONE SIDE OF WALL.

**HIGH-SPEED WIND ZONES**

FOR LOCATIONS OF 130 MPH OR MORE ULTIMATE DESIGN WIND SPEED (110 MPH OR MORE BASIC WIND SPEED IN VIRGINIA AND GEORGIA), WALLS SHALL BE BRACED PER THE LATEST ADOPTED EDITION OF THE AMERICAN SOCIETY OF CIVIL ENGINEERS PUBLICATION ASCE 7 OR STANDARD FOR RESIDENTIAL CONSTRUCTION IN HIGH-WIND REGIONS (ICC 600).

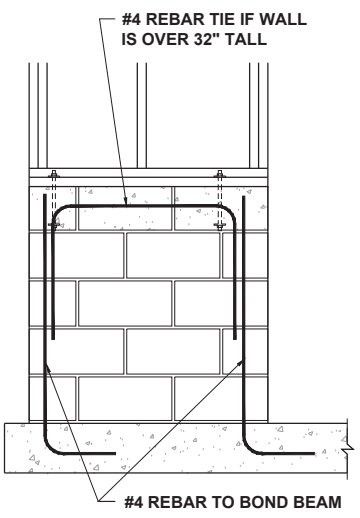

**GARAGE WING WALL AT CRAWL**  
SEE R602.10 - MASONRY STEM WALL SUPPORTING BRACED WALL PANELS FIGURES

**METHOD PF: PORTAL FRAME PANEL CONSTRUCTION** 3/8" = 1'-0" **1**

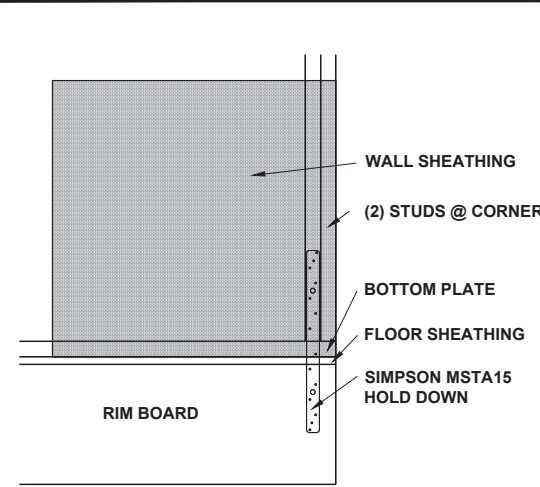

SIMPSON MSTA15 HOLD DOWN CAPACITY OF 970 POUNDS PER ANCHOR WITH (12) 10d NAILS. STRAP TO BE LOCATED AT EDGE OF BRACED WALL PANEL.

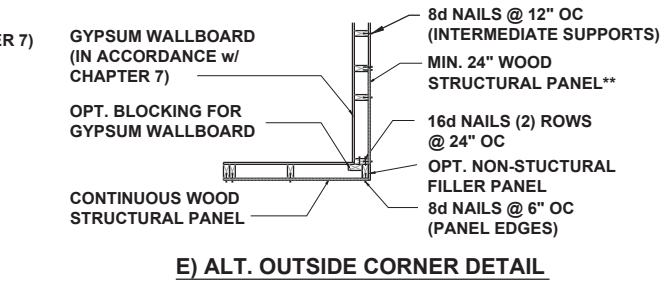
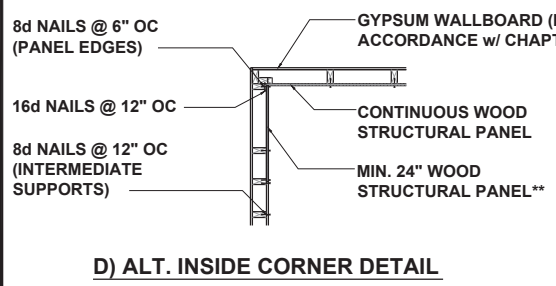
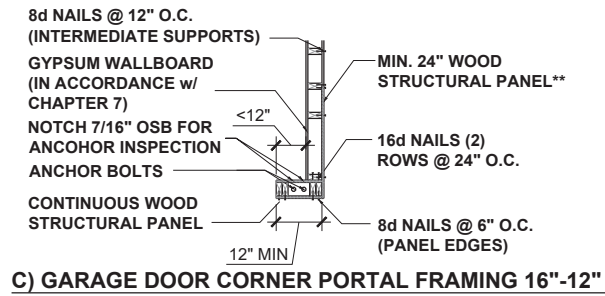
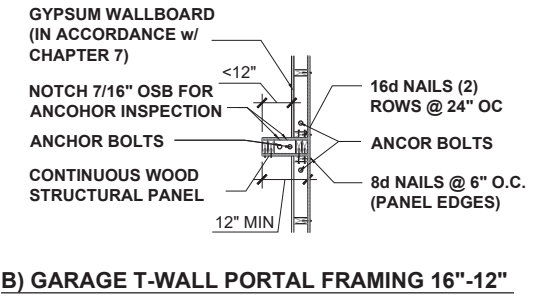
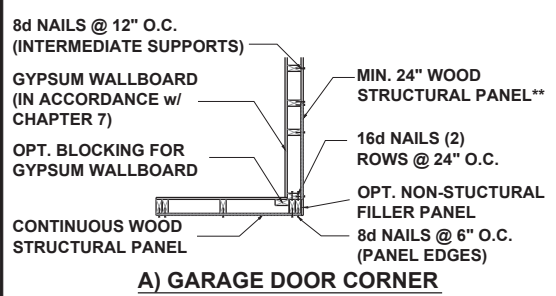

\*\* IN LIEU OF THE CORNER RETURN, A HOLD-DOWN DEVICE WITH A MINIMUM UPLIFT DESIGN VALUE OF 800# SHALL BE FASTENED TO THE CORNER STUD AND TO THE FOUNDATION OR FRAMING BELOW.

**BRACED WALL HOLD-DOWN** NTS **3**

**CORNER FRAMING FOR CONTINUOUS SHEATHING** 1/4" = 1'-0" **4**

# JOIST DETAILS

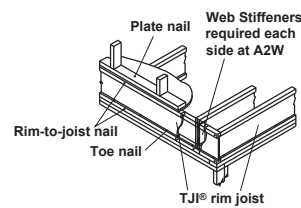

**A2 A2W** Must have 1 3/4" minimum joist bearing at ends. Attach rim joist per A3 detail.

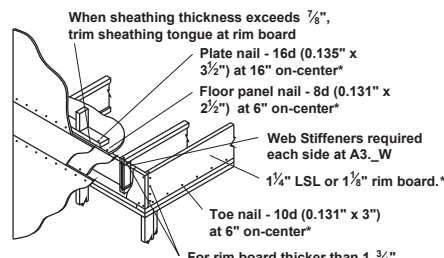

**A3 A3W** For rim board thicker than 1 3/4" - Attach Joist to rim board with one 10d (0.128"x3") nail. Top nail from joist into rim board. - Connect corner with four 10d (0.128"x3") nails. Toe nail from side of parallel closure into rim board

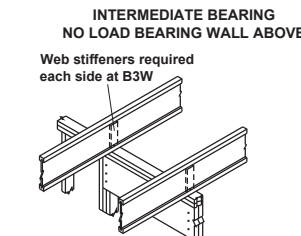

**B3 B3W** Blocking panels may be required with shear walls above or below (See detail B1)

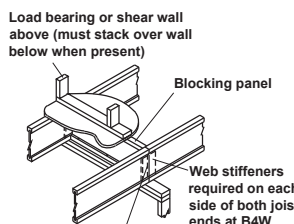

**B4 B4W** End of joists at centerline of support

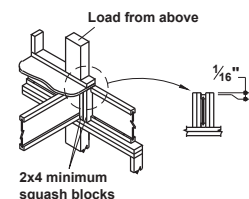

**CS** Use 2x4 minimum squash blocks to transfer load around joist

## FASTENING of FLOOR PANELS

Guidelines for Closest On-Center Spacing per Row

Nail Size	I-JOIST *		Rim Board	1 1/2" LSL or wider	LVL	PSL
	110, 210, and 230 EQ.	360 and 560 EQ.	1 1/4" LSL			
8d (0.131" x 2 1/2")	4"	3"	4"	3"	3"	3"
10d (0.148" x 3")	4"	4"	4"	4"	4"	4"
16d (0.162" x 3 1/2")	6"	6"	6" (2)	6" (2)	8"	6"

- (1) One row of fasteners permitted (two at abutting panel edges) for diaphragms. Stagger nails when using 4" on-center spacing and maintain 3/8" joist and panel edge distance. For other applications, multiple rows of fasteners are permitted if the rows are offset at least 1/2" and staggered.
- (2) Can be reduced to 4" on-center if nail penetration into the narrow edge is no more than 1 3/8" (to avoid splitting).
- Recommended nailing is 12" on-center in field and 6" on-center along panel edge. Fastening requirements on engineered drawings supersede recommendations listed above.

- Recommended use of a non-polyurethane subfloor adhesive on all contact points between panels and floor framing.
- Nailing rows must be offset at least 1/2" and staggered.
- 14 ga. staples may be substituted for 8d (0.113" x 2 1/2") nails if minimum penetration of 1" into the joist or rim board is achieved.
- Maximum spacing of nails is 18" on-center for joists.

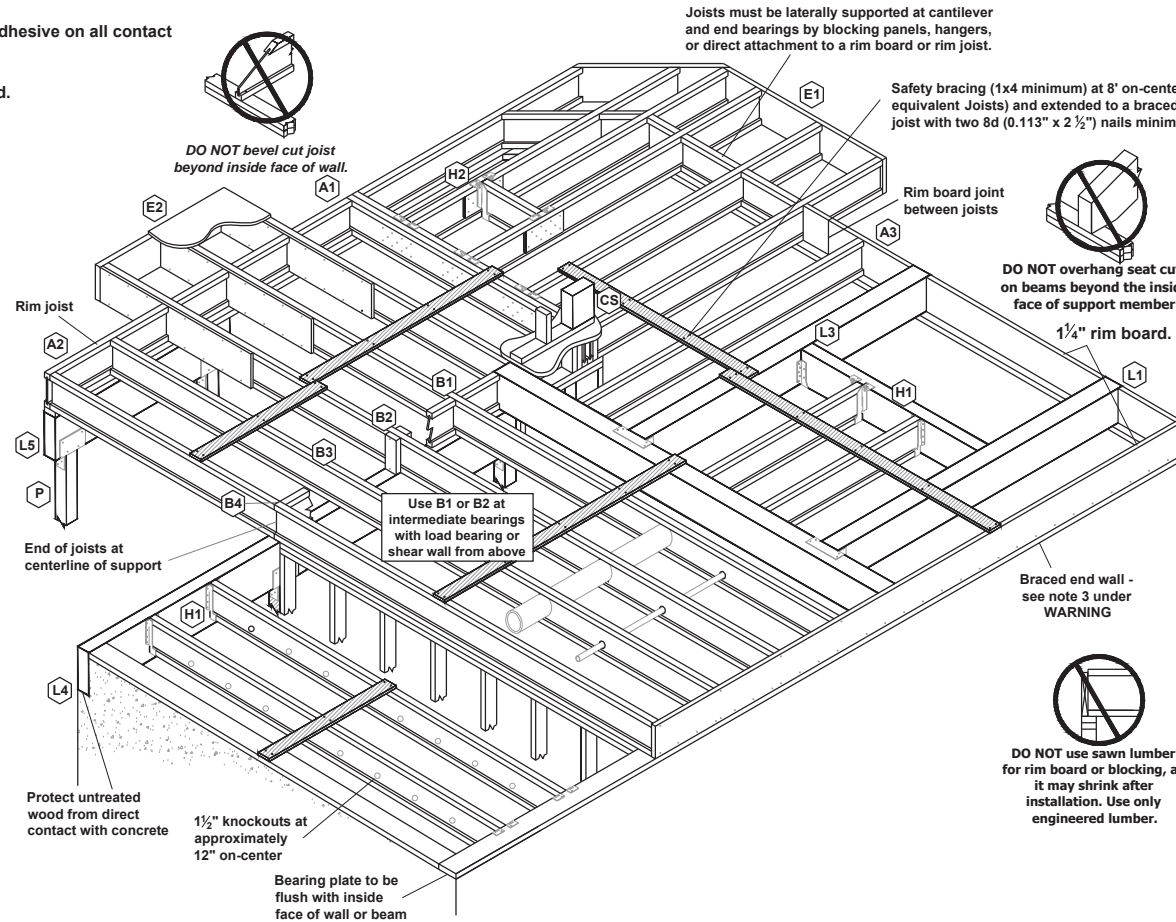

## FILLER and BACKER BLOCK SIZES

\* SEE I-JOIST EQUIVALENCE CHART

I-Joists	110 EQ. *		210 EQ. *		230 or 360 EQ. *			560 EQ. *		
	9 1/2" or 11 1/4"	14"	9 1/2" or 11 1/4"	14" or 16"	9 1/2" or 11 1/4"	14" or 16"	18" or 20"	11 1/8" or 14" or 16" or 18" or 20"	Two 2x6	Two 2x8
Filler Block (1) (Detail H2)	2x6	2x8	2x6 + 3/8" sheathing	2x8 + 3/8" sheathing	2x6 + 1/2" sheathing	2x8 + 1/2" sheathing	2x12 + 1/2" sheathing	Two 2x6	Two 2x8	Two 2x12
Cantilever Filler (Detail E4)	4'-0" long	6'-0" long	2x6 + 3/8" sheathing 4'-0" long	2x10 + 3/8" sheathing 6'-0" long	2x6 + 1/2" sheathing 4'-0" long	2x10 + 1/2" sheathing 6'-0" long	Not applicable	Not applicable		
Backer Block (1) (Detail F1 or H2)	5/8" or 3/4"	3/4" or 7/8"	1" Net			2x6			2x8	2x12

(1) If necessary, increase filler and backer block height for face mount hangers and maintain 1/8" gap at top of joist; see detail W. Filler and backer block lengths should accommodate required nailing without splitting (12" minimum for backer blocks and 24" minimum for filler blocks).

Joists must be laterally supported at cantilever and end bearings by blocking panels, hangers, or direct attachment to a rim board or rim joist.

Safety bracing (1x4 minimum) at 8' on-center (6' on-center for 110 or equivalent Joists) and extended to a braced end wall. Fasten at each joist with two 8d (0.113" x 2 1/2") nails minimum (see WARNING).

# BEAM and COLUMN DETAILS

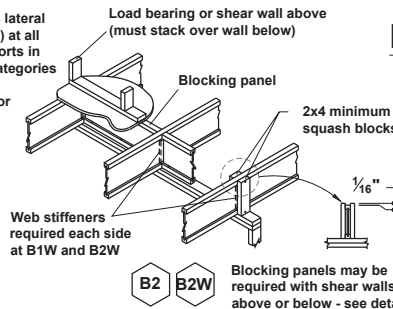

**B1 B1W** Blocking panels may be required with shear walls above or below - see detail B1

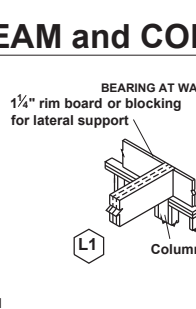

**L1** Column

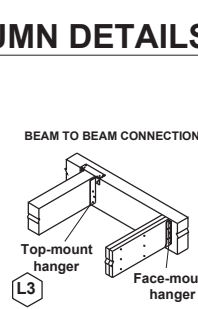

**L3** Top-mount hanger Face-mount hanger

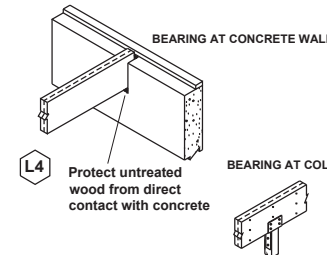

**L4** Protect untreated wood from direct contact with concrete

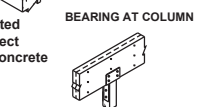

**L5** Verify column capacity and beam bearing length.

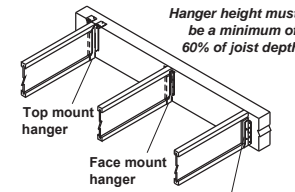

**H1** Web stiffeners required if sides of hanger do not laterally support at least 3/8" of joist top flange

# INSTALLATION TIPS

- Subfloor adhesive will improve floor performance, but may not be required.
- Squash blocks and blocking panels carry stacked vertical loads (details B1 and B2). Packing out the web of a joist (with web stiffeners) is not a substitute for squash blocks or blocking panels.
- When joists are doubled at non-load bearing parallel partitions, space joists apart the width of the wall for plumbing or HVAC.
- Additional joist at plumbing drop (see detail).

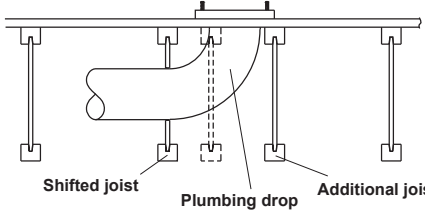

## \* I-JOIST EQUIVALENCY CHART

Depth	EQUIVALENT IN SPAN AND SPACING		
	Mfrt & Series	Mfrt & Series	Mfrt & Series
9 1/4"	TJI - 110	BCI 4500	
	TJI - 210	BCI 5000	EverEdge 20
	TJI - 230	BCI 6000	BCI 6500
11 1/8"	TJI - 110	BCI 4500	
	TJI - 210	BCI 5000	EverEdge 20
	TJI - 230	BCI 6000	BCI 6500
14"	TJI - 360	BCI 60'S	EverEdge 30
	TJI - 560	BCI 90'S	EverEdge 50/60
	TJI - 110	BCI 4500	
16"	TJI - 210	BCI 5000	
	TJI - 230	BCI 6000	EverEdge 20
	TJI - 360	BCI 60'S	EverEdge 30
	TJI - 560	BCI 90'S	EverEdge 50/60

## JOIST NAILING REQUIREMENTS at BEARING

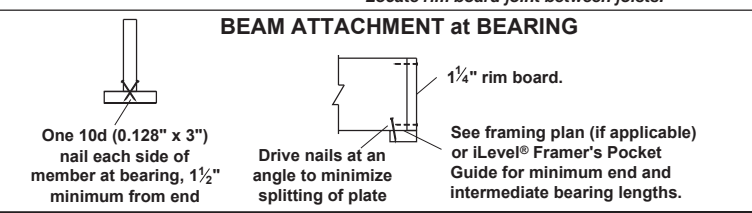
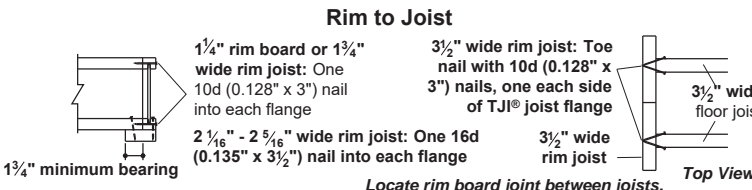
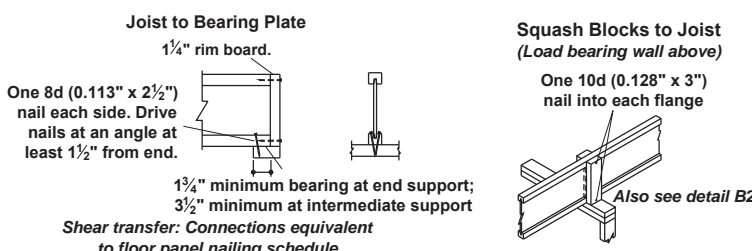

KB HOME  
NORTH CAROLINA DIVISION  
4518 S. MIAMI BLVD.  
SUITE 180  
DURHAM, NC 27703  
TEL: (919) 768-7988  
FAX: (919) 472-0582

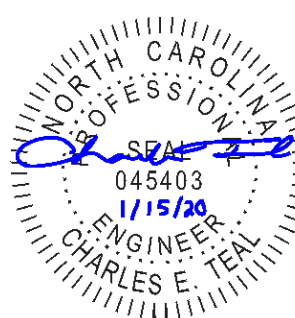

P-0961

JDS CONSULTING & DESIGN, PLLC  
8600 'D' JERSEY CT. RALEIGH, NC 27617  
919.480.1075  
INFO@JDSDESIGNONLINE.COM  
WWW.JDSDESIGNONLINE.COM

PROJECT NO.: 20900080  
DATE: 01/15/2020

PLAN:  
240.2596

ENGINEERED JOIST  
DETAILS  
**D9.0**

These designs and drawings are CONFIDENTIAL, and the enclosure property of KB Home Corporation and are not to be disclosed without the express permission of KB Home Corporation. Copyright 2018 © KB Home Corporation. All rights reserved. They may not be used or replicated without the express permission of KB Home Corporation.