



NORTH CAROLINA 40' SERIES PLAN 240.2596

LOT 44 MASON POINTE - ELEVATION B

SHEET INDEX

PLAN #240.2596

TS TITLE SHEET
6N1 GENERAL NOTES
6N2 GENERAL NOTES
6N3 GENERAL NOTES

1.1 FIRST FLOOR PLAN
1.2 SECOND FLOOR PLAN
1.3 FIRST FLOOR PLAN W/ CRAWL SPACE
1.4 FIRST FLOOR PLAN OPTIONS
1.5 SECOND FLOOR PLAN OPTIONS

2.1 SLAB INTERFACE PLAN 'A'
2.2 PARTIAL SLAB INTERFACE PLAN 'B', 'C', & 'D'
2.3 CRAWL SPACE FOUNDATION PLAN 'A'
2.4 PARTIAL CRAWL SPACE FOUNDATION PLAN 'B', 'C', & 'D'
2.5 SLAB INTERFACE PLAN OPTIONS

3.A1 ROOF PLAN, FRONT & REAR ELEVATIONS 'A'
3.A2 LEFT & RIGHT ELEVATIONS 'A'
3.A3 PARTIAL FIRST FLOOR PLAN, FRONT & RIGHT ELEVATIONS 'A' AT CRAWL SPACE
3.A4 PARTIAL FRONT & RIGHT ELEVATIONS AT CONCRETE PORCH
3.A5 FRONT ELEVATIONS 'A' AT OPTIONAL 9'-1" PLATE HEIGHT
3.A6 PARTIAL RIGHT, LEFT, AND FRONT ELEVATION 'A' W/ MASONRY OPT #1 AND #2

3.B1 PARTIAL FIRST & SECOND FLOOR PLANS 'B'
3.B2 ROOF PLAN, FRONT & REAR ELEVATIONS 'B'
3.B3 LEFT & RIGHT ELEVATIONS 'B'
3.B4 PARTIAL FIRST FLOOR PLAN, FRONT & RIGHT ELEVATIONS 'B' AT CRAWL SPACE
3.B5 PARTIAL FRONT & RIGHT ELEVATIONS AT CONCRETE PORCH
3.B6 FRONT ELEVATIONS 'B' AT OPTIONAL 9'-1" PLATE HEIGHT
3.B7 PARTIAL FLOOR PLAN, ROOF, FRONT ELEVATION, PARTIAL RIGHT ELEVATION 'B' AT EXTENDED PORCH OPTION
3.B8 PARTIAL RIGHT, LEFT, AND FRONT ELEVATION 'B' W/ STONE

3.C1 PARTIAL FIRST & SECOND FLOOR PLANS 'C'
3.C2 ROOF PLAN, FRONT & REAR ELEVATIONS 'C'
3.C3 LEFT & RIGHT ELEVATIONS 'C'
3.C4 PARTIAL FIRST FLOOR PLAN, FRONT & RIGHT ELEVATIONS 'C' AT CRAWL SPACE
3.C5 PARTIAL FRONT & RIGHT ELEVATIONS AT CONCRETE PORCH
3.C6 FRONT ELEVATIONS 'C' AT OPTIONAL 9'-1" PLATE HEIGHT
3.C7 PARTIAL FLOOR PLAN, ROOF, FRONT ELEVATION, PARTIAL RIGHT ELEVATION 'C' AT EXTENDED PORCH OPTION
3.C8 PARTIAL RIGHT, LEFT, AND FRONT ELEVATION 'C' W/ STONE OPT #1 AND #2
3.C9 PARTIAL RIGHT, LEFT, AND FRONT ELEVATION 'C' W/ STONE OPT #1 AND #2 AT EXTENDED PORCH OPTION

3.D1 PARTIAL FIRST & SECOND FLOOR PLANS 'D'
3.D2 ROOF PLAN, FRONT & REAR ELEVATIONS 'D'
3.D3 LEFT & RIGHT ELEVATIONS 'D'
3.D4 PARTIAL FIRST FLOOR PLAN, FRONT & RIGHT ELEVATIONS 'D' AT CRAWL SPACE
3.D5 PARTIAL FRONT & RIGHT ELEVATIONS W/ OPTIONAL MASONRY AT CONCRETE PORCH
3.D6 FRONT ELEVATIONS 'D' AT OPTIONAL 9'-1" PLATE HEIGHT
3.D7 PARTIAL RIGHT, LEFT, AND FRONT ELEVATION 'D' W/ STONE OPT #1 AND #2

4.1 INTERIOR ELEVATIONS
4.2 SECTIONS
4.3 SECTIONS AT CRAWL SPACE

5.1 FIRST FLOOR UTILITY PLAN
5.2 SECOND FLOOR UTILITY PLAN
5.3 FIRST FLOOR UTILITY PLAN OPTIONS
5.4 SECOND FLOOR UTILITY PLAN OPTIONS

7.1 PARTIAL FLOOR PLANS & ELEVATIONS W/ OPT. 12'X12' DECK AT CRAWL SPACE
7.2 PARTIAL FLOOR PLANS & ELEVATIONS W/ OPT. 12'X24' DECK AT CRAWL SPACE
7.3 PARTIAL FLOOR PLANS & ELEVATIONS W/ OPT. 12'X12' SCREENED-IN DECK AT CRAWL SPACE

7.4 PARTIAL FLOOR PLANS & ELEVATIONS W/ OPT. 12'X24' SCREENED-IN DECK AT CRAWL SPACE
7.5 PARTIAL FLOOR PLANS & ELEVATIONS W/ OPT. SUNROOM AT SLAB INTERFACE
7.6 PARTIAL FLOOR PLANS & ELEVATIONS W/ OPT. SUNROOM AT CRAWL SPACE

8.1 PARTIAL FLOOR PLAN, ROOF & ELEVATIONS W/ OPT. COVERED PATIO
8.2 PARTIAL FLOOR PLAN, ROOF & ELEVATIONS W/ OPT. EXTENDED COVERED PATIO
8.3 PARTIAL FLOOR PLAN, ROOF & ELEVATIONS W/ OPT. SCREENED-IN COVERED PATIO
8.4 PARTIAL FLOOR PLAN, ROOF & ELEVATIONS W/ OPT. SCREENED-IN EXTENDED COVERED PATIO

AD1 ARCHITECTURAL DETAILS
AD2 ARCHITECTURAL DETAILS
AD3 ARCHITECTURAL DETAILS
AD4 ARCHITECTURAL DETAILS
AD5 ARCHITECTURAL DETAILS
AD6 ARCHITECTURAL DETAILS
AD7 ARCHITECTURAL DETAILS
AD8 ARCHITECTURAL DETAILS

ABBREVIATIONS

ABV.	ABOVE	G.F.I.	GROUND-FAULT	R.O.	ROUGH OPENING
A/C	AIR CONDITIONING	CIRCUIT	CIRCUIT INTERRUPTER	S & P	SHELF AND POLE
ADJ.	ADJUSTABLE	G.I.	GALVANIZED IRON	S.C.	SOLID CORE
ALT	ALTERNATE	GL.	GLASS	S.D.	SMOKE DETECTOR
AMP.	AMPERAGE	GYP. BD.	GYP. BOARD	SEC.	SECTION
BD.	BOARD	H.C.	HOLLOW CORE	S.H.	SINGLE HUNG
CL.	CENTER LINE	HDR.	HEADER	SHT.	SHEET
CAB.	CABINET	HGT. / HT.	HEIGHT	SHTG.	SHEATHING
CLS.	CEILING	H.H.	HEADER HEIGHT	SHWR.	SHOWER
CLR.	CLEAR	H.H.	HORIZONTAL	SIM.	SIMILAR
CONC.	CONCRETE	HS	HORIZONTAL SLIDER	SL.	SLIDING
CPT.	CARPET	I.L.O.	IN LIEU OF	SL. GL.	SLIDING GLASS
C.T.	CERAMIC TILE	INSUL.	INSULATION	STD.	STANDARD
D.	DRYER	INT.	INTERIOR	S.V.	SHEET VINYL
DBL.	DOUBLE	LAM.	LAMINATED	TEMP.	TEMPERED GLASS
D.S.	DUAL GLAZED	LAV.	LAVATORY	THK.	THICK
DIA.	DIAMETER	LUM.	LUMINOUS	T.O.C.	TOP OF CURB
DIM.	DIMENSION	M.C.	MEDICINE CABINET	T.O.P.	TOP OF PLATE
DISP.	DISPOSAL	MFR.	MANUFACTURER	T.O.S.	TOP OF SLAB
D.L.	DIVIDED LIGHT	MIN.	MINIMUM	TYP.	TYPICAL
DP.	DEEP	MTD.	MOUNTED	U.N.O.	UNLESS NOTED OTHERWISE
DR.	DOOR	MTL.	METAL	V.P.	VAPOR PROOF
D.S.	DOWNSPOUT	N.I.C.	NOT IN CONTRACT	V.P.	VAPOR PROOF
DTL.	DETAIL	N.T.S.	NOT TO SCALE	W.	WITH
D.W.	DISHWASHER	O/	OVER	W/	WOOD
EA.	EACH	O.C.	ON CENTER	W.D.	WINDOW
ELEV.	ELEVATION	OPT.	OPTIONAL	W.D.W.	WINDOW
EQ.	EQUAL	O.S.A.	OUTSIDE AIR	W/H	WATER HEATER
EXH.	EXHAUST	EQ.	EQUIPMENT	W.I.	WROUGHT IRON
EXT.	EXTERIOR	P.B.	PUSH BUTTON	W.P.	WEATHER PROOF
FAU	FORCED AIR UNIT	PH.	PHONE		
F.G./FX.	FIXED GLASS	PLT.	PLATE		
F.G.	FUEL GAS	PLYWD.	PLYWOOD		
FIN.	FINISH	PR.	PAIR		
FLR.	FLOOR	P.T.D.F.	PRESSURE TREATED DOUGLAS FIR		
FLR. LINE	FLOOR LINE	R.	RISER		
FLUOR.	FLUORESCENT	RAD.	RADIUS		
FR. DR.	FRENCH DOOR	R.A.S.	RETURN AIR GRILL		
F.M.C.	FLOOR MATERIAL CHANGE	REF.	REFRIGERATOR		
FTS.	FOOTING	RE/S	RE-SAWN		
GA.	GAUGE	REV.	REVERSE		
GAR. DISP.	GARBAGE DISPOSAL	RM.	ROOM		

ARCH. SYMBOLS

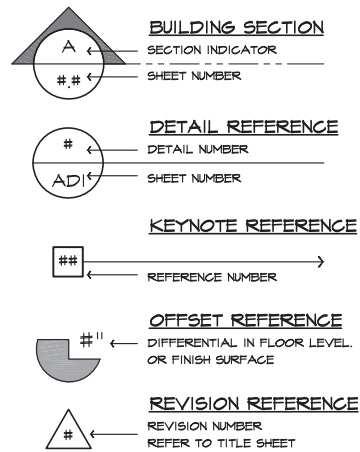

SCALE NOTE

IF BOX IS 1" SQ. THEN SCALE IS 1/4" = 1'-0"
IF BOX IS 1/2" SQ. THEN SCALE IS 1/8" = 1'-0"

CONSULTANTS

OWNER :
KB HOME
NORTH CAROLINA DIVISION
4506 S. MIAMI BLVD., SUITE 180
DURHAM, NC 27703
TEL: (919) 768-7980
FAX: (919) 544-2928

ARCHITECT
KB HOME
5250 PACIFIC CONCOURSE DRIVE, SUITE 330
LOS ANGELES, CA 90045
TEL: (424) 244-8100
FAX: (310) 241-2671

SQUARE FOOTAGE

PLAN 240.2596			
FIRST FLOOR AREA	1158	SQ. FT.	
SECOND FLOOR AREA	1415	SQ. FT.	
TOTAL AREA	2573	SQ. FT.	
GARAGE AREA	416	SQ. FT.	
PORCH AREA(S)			
ELEVATION 'A'	88	SQ. FT.	
ELEVATION 'B'	84	SQ. FT.	
ELEVATION 'C'	62	SQ. FT.	
ELEVATION 'D'	136	SQ. FT.	
PATIO AREA(S)			
10'X10' COVERED	100	SQ. FT.	
10'X26'-11" COVERED	266	SQ. FT.	
DECK AREA(S)			
OPEN 12'X12'	144	SQ. FT.	
OPEN 12'X24'	288	SQ. FT.	
SCREENED-IN 12'X12'	144	SQ. FT.	
SCREENED-IN 12'X24'	288	SQ. FT.	
SUNROOM AREA			
12'X12'	144	SQ. FT.	

CODE INFORMATION

APPLICABLE CODES:
2018 NORTH CAROLINA STATE BUILDING CODE, RESIDENTIAL CODE, INCLUDING REFERENCED CODES AND STANDARDS

CODE ABBREVIATIONS	
N.C.-R.	NORTH CAROLINA RESIDENTIAL CODE
N.C.-B.	NORTH CAROLINA BUILDING CODE
N.C.-M.	NORTH CAROLINA MECHANICAL CODE
N.C.-P.	NORTH CAROLINA PLUMBING CODE
N.C.-F.	NORTH CAROLINA FUEL GAS CODE
N.C.-E.	NORTH CAROLINA ELECTRICAL CODE
N.C.-E.C.	NORTH CAROLINA ENERGY CODE
N.E.C.	NATIONAL ELECTRICAL CODE
I.C.B.O.	INTERNATIONAL CONFERENCE OF BUILDING OFFICIALS
A.S.T.M.	AMERICAN SOCIETY FOR TESTING MATERIALS
N.F.P.A.	NATIONAL FIRE PROTECTION ASSOCIATION
ANSI.	AMERICAN NATIONAL STANDARDS INSTITUTE
I.E.C.C.	INTERNATIONAL ENERGY CONSERVATION CODE
I.C.C.	INTERNATIONAL CODE COUNCIL UNDERWRITERS LABORATORIES, INC.
UL.	

PROJECT DESCRIPTION:
2 STORY SINGLE FAMILY DETACHED RESIDENTIAL PLAN W/ 4 ELEVATIONS

OCCUPANCY:
R3

CONSTRUCTION TYPE:
V - B

REVISION LIST

DELTA	DATE	SHEETS REVISED	LOG NUMBER
1	08/13/18	T.S, 1.1 - 1.5, 2.1, 2.3, 2.4, 2.5, 3.A1 - 3.D6, 4.1 - 5.4	NC18024NCP
2	08/15/19	T.S, 6.N1, 6.N2, 6.N3, 3.A1, 3.B1, 3.B2, 3.B7, 3.C1, 3.C2, 3.C6, 3.D2, 5.1	
		7.3 - 7.6, 8.1 - 8.4	NC18024NCP



NORTH CAROLINA 40' SERIES

KB HOME
NORTH CAROLINA DIVISION
4506 S. MIAMI BLVD.
SUITE 180
DURHAM, NC 27703
TEL: (919) 768-7980
FAX: (919) 544-2928

2018 NORTH CAROLINA STATE BUILDING CODES

ISSUE DATE: 05/28/15
PROJECT No.: 1350999:56
DIVISION MGR.: DCS
REVISIONS: 03/15/19

1 DIVISION REVISIONS
NC18024NCP / 02/13/18 / CTD

2 2018 CODE UPDATE
NC19015NCP / 03/15/19 / CTD

FOR INTERNAL USE ONLY	
REVISION BY:	
1.	
2.	
3.	
4.	
5.	
6.	

PLAN:
240.2596
SHEET:
TS

SPEC. LEVEL 1 RALEIGH-DURHAM 40' SERIES

These designs and drawings are CONFIDENTIAL and the exclusive property of KB Home Corporation and are not to be disclosed without the express permission of KB Home Corporation. Copyright 2019 © KB Home Corporation, all rights reserved.

GENERAL REQUIREMENTS

- THE WORD "CONTRACTOR" AS USED HEREIN SHALL MEAN THE GENERAL CONTRACTOR, SUBCONTRACTORS AND ALL PERSONS DIRECTLY OR INDIRECTLY EMPLOYED BY ANY OF THEM.
- CONTRACTOR SHALL PERFORM THE WORK IN ACCORDANCE WITH THE FOLLOWING APPLICABLE CODE REQUIREMENTS:
 - ALL LAWS, STATUTES, THE MOST RECENT BUILDING CODES, ORDINANCES, RULES, REGULATIONS, AND LAWFUL ORDERS OF ALL PUBLIC AUTHORITIES HAVING JURISDICTION OVER OWNER, CONTRACTOR, ANY SUBCONTRACTOR, THE PROJECT, THE PROJECT SITE, THE WORK, OR THE PROSECUTION OF THE WORK.
 - THE FEDERAL OCCUPATIONAL SAFETY AND HEALTH ACT AND ALL OTHER APPLICABLE CODE REQUIREMENTS RELATING TO SAFETY.
 - THE FAIR HOUSING AMENDMENTS ACT, THE AMERICANS WITH DISABILITIES ACT, AND ALL OTHER APPLICABLE CODE REQUIREMENTS RELATING THERETO.
- CONTRACTOR SHALL CAREFULLY STUDY AND REVIEW THE CONSTRUCTION DOCUMENTS AND INFORMATION FURNISHED BY OWNER, AND PROMPTLY REPORT IN WRITING TO OWNER'S REPRESENTATIVE ANY ERRORS, INCONSISTENCIES, OR OMISSIONS IN THE CONSTRUCTION DOCUMENTS OR INCONSISTENCIES WITH APPLICABLE CODE REQUIREMENTS OBSERVED BY THE CONTRACTOR.
- IF CONTRACTOR PERFORMS WORK WHICH HE KNOWS OR SHOULD KNOW IS CONTRARY TO APPLICABLE CODE REQUIREMENTS, WITHOUT THE AGREEMENT OF OWNER, CONTRACTOR SHALL BE RESPONSIBLE FOR SUCH WORK AND SHALL BEAR THE RESULTANT LOSSES, INCLUDING, WITHOUT LIMITATION, THE COSTS OF CORRECTING DEFECTIVE WORK.
- CONTRACTOR SHALL PROVIDE CERTIFICATES OF INSURANCE ACCEPTABLE TO OWNER PRIOR TO COMMENCEMENT OF WORK.
- CONTRACTOR SHALL TAKE FIELD MEASUREMENTS, VERIFY FIELD CONDITIONS, AND CAREFULLY COMPARE WITH THE CONSTRUCTION DOCUMENTS SUCH FIELD MEASUREMENTS, CONDITIONS, AND OTHER INFORMATION KNOWN TO CONTRACTOR BEFORE COMMENCING THE WORK. ERRORS, INCONSISTENCIES, OR OMISSIONS DISCOVERED AT ANY TIME SHALL BE PROMPTLY REPORTED IN WRITING TO THE OWNER.
- CONTRACTOR SHALL PROMPTLY NOTIFY OWNER'S REPRESENTATIVE IF CONTRACTOR BECOMES AWARE DURING THE PERFORMANCE OF THE WORK THAT THE CONSTRUCTION DOCUMENTS ARE NOT IN COMPLIANCE WITH APPLICABLE CODE REQUIREMENTS.
- BY SUBMITTAL OF BID, CONTRACTOR WARRANTS TO OWNER THAT ALL MATERIALS AND WORK TO BE FURNISHED ARE NEW UNLESS NOTED OTHERWISE AND ALL WORK WILL BE OF GOOD QUALITY AND FREE FROM FAULTS AND DEFECTS.
- SUB-CONTRACTORS SHALL INSURE THAT ALL WORK IS DONE IN A PROFESSIONAL MANNER BY SKILLED MECHANICS AND SHALL REPLACE ANY MATERIALS OR ITEMS DAMAGED BY SUB-CONTRACTORS PERFORMANCE. SUB-CONTRACTORS AND SUPPLIERS ARE HEREBY NOTIFIED THAT THEY ARE TO CONFER AND COOPERATE FULLY WITH EACH OTHER DURING THE COURSE OF CONSTRUCTION TO DETERMINE THE EXACT EXTENT AND OVERLAP OF EACH OTHER'S WORK AND TO SUCCESSFULLY COMPLETE THE EXECUTION OF THE WORK. ALL SUB-CONTRACTOR WORKMANSHIP SHALL BE OF QUALITY TO PASS INSPECTIONS BY LOCAL AUTHORITIES, LENDING INSTITUTIONS, ARCHITECT OR BUILDER. ANY ONE OR ALL OF THE ABOVE MENTIONED INSPECTORS MAY INSPECT WORKMANSHIP AT ANY TIME, AND CORRECTIONS NEEDED TO ENHANCE THE QUALITY OF BUILDING WILL BE DONE IMMEDIATELY. EACH SUB-CONTRACTOR UNLESS SPECIFICALLY EXEMPTED BY THE TERMS OF HIS/HERS SUB-CONTRACT AGREEMENT, SHALL BE RESPONSIBLE FOR CLEANING UP AND REMOVING FROM THE JOB SITE ALL TRASH AND DEBRIS NOT LEFT BY OTHER SUB-CONTRACTORS. BUILDER WILL DETERMINE HOW SOON AFTER SUB-CONTRACTOR COMPLETES EACH PHASE OF HIS WORK THAT TRASH AND DEBRIS WILL BE REMOVED FROM THE SITE.
- APPROVAL BY THE BUILDING INSPECTOR DOES NOT MEAN APPROVAL OR ALLOWABLE FAILURE TO COMPLY WITH THE PLANS AND SPECIFICATIONS. ANY DESIGN WHICH FAILS TO BE CLEAR OR IS AMBIGUOUS MUST BE REFERRED TO THE ARCHITECT OR ENGINEER FOR INTERPRETATION OR CLARIFICATION.
- ALL EQUIPMENT AND MATERIALS FURNISHED AND INSTALLED UNDER THESE PLANS SHALL BE GUARANTEED BY THE CONTRACTOR FOR A PERIOD OF ONE YEAR FROM THE DATE OF ACCEPTANCE OF THE WORK BY OWNER UNLESS STIPULATED OTHERWISE.
- ALL TRADE NAMES AND BRAND NAMES CONTAINED HEREIN ESTABLISH QUALITY STANDARDS. SUBSTITUTIONS ARE PERMITTED, WITH PRIOR APPROVAL BY THE OWNER'S REPRESENTATIVE. THE CONTRACTOR SHALL SUBMIT FOR THE ARCHITECT'S AND BUILDER'S APPROVAL ALL MATERIALS OR EQUIPMENT WHICH IS CONSIDERED "OR EQUAL" TO THAT SPECIFIED.
- CONSTRUCTION DOCUMENTS IDENTIFIED AS "BID SET" ON ANY OR ALL SHEETS MAY BE SUBJECT TO REVIEW. THIS REVIEW MAY RESULT IN CHANGES WHICH MAY BE MADE TO THE PLANS PRIOR TO THE ISSUANCE OF THE FINAL CONSTRUCTION SET WHICH WILL CONTAIN NO "BID SET" DESIGNATIONS. CONSTRUCTION DOCUMENTS IDENTIFIED AS "BID SET" ARE NOT TO BE CONSTRUED AS BEING THE COMPLETED OR FINAL DRAWINGS AND THEY SHOULD NOT IN ANY WAY BE USED AS SUCH.
- ALL STANDARD NOTES CONTAINED HEREIN ARE TYPICAL UNLESS NOTED OTHERWISE.
- TYPICAL DETAILS AND SPECIFICATIONS ARE MINIMUM REQUIREMENTS TO BE USED WHEN CONDITIONS ARE NOT SHOWN OTHERWISE.
- SPECIFIC NOTES AND DETAILS ON DRAWINGS SHALL TAKE PRECEDENCE OVER GENERAL NOTES AND TYPICAL DETAILS. WHERE NO DETAILS ARE SHOWN CONSTRUCTION SHALL CONFORM TO SIMILAR WORK ON THE PROJECT.
- SEE ARCHITECTURAL, STRUCTURAL, ELECTRICAL, AND MECHANICAL DRAWINGS FOR FITS, TRENCHES, ROOF OPENINGS, DEPRESSIONS, ETC. NOT SHOWN ON THE OTHER DRAWINGS.
- THE CONSTRUCTION DOCUMENTS AND ALL COPIES THEREOF FURNISHED TO CONTRACTOR ARE THE PROPERTY OF THE ARCHITECT AND ARE NOT TO BE USED ON OTHER WORK.

SITE WORK

- CONTRACTOR SHALL INVESTIGATE SITE DURING CLEARING AND EXISTING OPERATIONS FOR EXCAVATIONS OR BURIED STRUCTURES SUCH AS CESSPOOLS, CISTERNS, FOUNDATIONS, ETC., AND BURIED ARTIFACTS SUCH AS INDIAN OR DINOSAUR BONES. IF ANY SUCH ITEMS ARE FOUND THE ARCHITECT, CIVIL ENGINEER, AND SOILS ENGINEER SHALL BE NOTIFIED IMMEDIATELY.
- CONTRACTOR SHALL TAKE ALL NECESSARY MEASURES TO FULLY PROTECT ADJACENT PROPERTIES.
- REFER TO THE SOILS REPORT AS PREPARED BY THE GEOTECHNICAL ENGINEER.
- REFER TO CIVIL ENGINEER'S CURRENT GRADING AND PLOT PLANS.

SITE WORK (continued)

- REFER TO THE LANDSCAPE ARCHITECT'S CURRENT GRADING PLAN AND CONSTRUCTION DOCUMENTS.
- ALL FOOTINGS SHALL REST ON FIRM NATURAL SOIL OR APPROVED COMPACTED FILL. REFER TO GEOTECHNICAL REPORT.
- EXCAVATIONS FOR FOOTINGS SHALL BE MADE TO THE WIDTH, LENGTH, AND DEPTH REQUIRED AND FINISHED WITH LEVEL BOTTOMS.
- EXCAVATIONS SHALL BE KEPT FREE OF STANDINGS WATER.
- WHERE EXCAVATIONS ARE MADE TO A DEPTH GREATER THAN INDICATED, SUCH ADDITIONAL DEPTH SHALL BE FILLED WITH CONCRETE AS SPECIFIED FOR FOOTINGS.
- FILL MATERIALS SHALL BE FREE FROM DEBRIS, VEGETABLE MATTER AND OTHER FOREIGN SUBSTANCES.
- ALL FINISH GRADES TO DRAIN AWAY FROM THE BUILDING FOOTINGS.
- THERE SHALL BE NO ON-SITE WATER RETENTION.
- THIS SHALL BE NO DRAINAGE TO ADJACENT PROPERTY.
- FOR ONSITE CONSTRUCTION, PLANS TO COMPLY WITH NECESSARY INSPECTIONS APPROVED BY THE BUILDING OFFICIAL.

THE REQUIREMENTS IN THESE NOTES ARE THE MINIMUM THAT SHALL BE MET. REQUIREMENTS OF THE STRUCTURAL DRAWINGS THAT EXCEED THE REQUIREMENTS SHOWN HERE SHALL BE MET.

CONCRETE

- REFER TO STRUCTURAL ENGINEERING CALCULATIONS AND SOILS REPORTS FOR THE PERFORMANCE REQUIREMENTS FOR CONCRETE FOUNDATIONS.
- CONCRETE SHALL BE PROPORTIONED TO PROVIDE AN AVERAGE COMPRESSIVE STRENGTH AS PRESCRIBED IN THE N.C.-R, AS WELL AS SATISFY THE DURABILITY CRITERIA OF THE N.C.-R
- MIXING OF CONCRETE SHALL BE PERFORMED IN ACCORDANCE WITH ACI 318, SECTION 5.8.
- THE DEPOSITING OF CONCRETE SHALL COMPLY WITH THE PROVISIONS ACI 318, SECTION 5.10.
- THE CURING OF CONCRETE SHALL BE IN ACCORDANCE WITH ACI 318, SECTION 5.11.
- ALL FORM WORK SHALL BE DESIGNED, CONSTRUCTED, UTILIZED, AND REMOVED.
- CONDUIT, PIPES AND SLEEVES OF ANY MATERIAL NOT HARMFUL TO CONCRETE AND WITHIN THE LIMITATIONS OF ACI 318, SECTION 6.3, ARE PERMITTED TO BE EMBEDDED IN CONCRETE WITH APPROVAL OF THE REGISTERED DESIGN PROFESSIONAL.
- CONSTRUCTION JOINTS INCLUDING THEIR LOCATION SHALL COMPLY WITH THE PROVISIONS OF ACI 318, SECTION 6.4.
- ALL STEEL REINFORCING OF CONCRETE SHALL BE DONE IN ACCORDANCE WITH THE N.C.-R
- TOP OF CONCRETE SLABS TO BE A MINIMUM 4" W/ MASONRY VENEER 6" ELSEWHERE (8" HUD.) ABOVE FINISH GRADE.
- FOUNDATION WIDTHS, DEPTHS, AND REINFORCINGS, AS SHOWN ON PLANS, ARE SUPERSEDED BY ANY LOCAL CODES OR ORDINANCES WHICH REQUIRE INCREASES OF THE SAME.
- ALL REINFORCEMENT, CONDUIT, OUTLET BOXES, ANCHORS, HANGERS, SLEEVES, BOLTS OR OTHER EMBEDDED MATERIALS AND ITEMS MUST BE SECURED AND APPROPRIATELY FASTENED IN THEIR PROPER LOCATIONS PRIOR TO THE PLACEMENT OF CONCRETE. SUB-CONTRACTOR SHALL VERIFY INSTALLATION OF HOLD-DOWNS, ANCHOR BOLTS, PA STRAPS, AND OTHER ANCHORAGE MATERIAL AND ITEMS PRIOR TO PLACEMENT OF CONCRETE.
- POST-TENSION SLABS, IF APPLICABLE:
 - POINT AND LINE LOADS FROM STRUCTURE ABOVE TO BE PROVIDED TO POST-TENSION ENGINEER PRIOR TO POST-TENSION DESIGN.
 - ANCHOR BOLTS AND OTHER HARDWARE TO BE SHOWN ON POST-TENSION PLANS TO AVOID MIS-LOCATION OF HARDWARE AND POSSIBLE FIELD FIXES WHICH MAY CUT TENDONS.

MASONRY

- ALL MASONRY DESIGN SHALL FOLLOW THE REQUIREMENTS OF THE CURRENT ADOPTED CODES.
- ANCHORED MASONRY VENEER SHALL COMPLY WITH THE PROVISIONS OF N.C.-R, N.C.-R AND SECTIONS 6.1 AND 6.2 OF ACI 530/ASCE 5/TMS 402.
- STONE VENEER UNITS NOT EXCEEDING 5 INCHES IN THICKNESS SHALL BE ANCHORED DIRECTLY TO MASONRY, CONCRETE OR TO STUD CONSTRUCTION BY ONE OF THE APPROVED METHODS LISTED IN THE N.C.-R
- MORTAR FOR USE IN MASONRY CONSTRUCTION SHALL COMPLY WITH ASTM C 270. THE TYPE OF MORTAR SHALL BE IN ACCORDANCE WITH THE N.C.-R AND SHALL MEET THE PROPORTION SPECIFICATIONS OR THE PROPERTY SPECIFICATIONS OF ASTM C 270
- GROUT SHALL CONSIST OF CEMENTITIOUS MATERIAL AND AGGREGATE IN ACCORDANCE WITH ASTM C 476 AND THE PROPORTION SPECIFICATIONS PER THE N.C.-R
- AGGREGATES FOR MORTAR AND GROUT SHALL BE NATURAL SAND AND ROCK CONFORMING TO A.S.T.M. C-144-O4 (MASONRY MORTAR) AND C-404-07 (GROUT).
- CEMENT SHALL BE PORTLAND CEMENT CONFORMING TO A.S.T.M. C 150.
- ALL BRICK SHALL CONFORM TO A.S.T.M. C 216, GRADE MN.
- UNLESS SPECIFICALLY SHOWN OTHERWISE ALL BRICK SHALL BE LAID IN A RUNNING BOND PATTERN.
- ANCHORS, TIES AND WIRE FABRIC SHALL CONFORM TO N.C.-R
- ANCHOR TIES AND WIRE FABRIC FOR USE IN MASONRY WALL CONSTRUCTION SHALL CONFORM TO THE N.C.-R

METALS

- REFER TO STRUCTURAL NOTES AND SPECIFICATIONS FOR STRUCTURAL STEEL, METAL AND REINFORCING STEEL SPECIFICATIONS.
- ALL STRUCTURAL STEEL SHALL CONFORM TO AISC/A660
- ANCHOR RODS SHALL BE SET ACCURATELY TO THE PATTERN AND DIMENSIONS CALLED FOR ON THE PLANS. THE PROTRUSION OF THE THREADED ENDS THROUGH THE CONNECTED MATERIAL SHALL BE SUFFICIENT TO FULLY ENGAGE THE THREADS OF THE NUTS, BUT SHALL NOT BE GREATER THAN THE LENGTH OF THE THREADS ON THE BOLTS
- FASTENERS FOR PRESERVATIVE-TREATED AND FIRE-RETARDANT-TREATED WOOD SHALL BE OF HOT-DIPPED ZINC COATED GALVANIZED STEEL, STAINLESS STEEL, SILICON BRONZE OR COPPER. VERIFY ACCEPTABLE FASTENERS PER CHEMICALS USED IN PRESURE PRESERVATIVELY TREATED WOOD W/ N.C.-R. FASTENINGS FOR WOOD FOUNDATIONS SHALL BE AS REQUIRED IN AF&PA TECHNICAL REPORT NO. 7.

WOOD & FRAMING

LUMBER

- THE DESIGN AND CONSTRUCTION OF CONVENTIONAL LIGHT-FRAME WOOD CONSTRUCTION SHALL BE IN ACCORDANCE WITH THE PROVISIONS OF THE N.C.-R
- CONSTRUCTION PROJECTIONS, OPENINGS AND PENETRATIONS OF EXTERIOR WALLS OF DWELLINGS AND ACCESSORY BUILDINGS SHALL COMPLY WITH TABLE R502.1.
- ALL LUMBER SHALL MEET THE STANDARDS OF QUALITY AS STATED IN THE N.C.-R
- LUMBER AND PLYWOOD REQUIRED TO BE PRESSURE PRESERVATIVELY TREATED IN ACCORDANCE WITH THE N.C.-R AND SHALL BEAR THE QUALITY MARK OF AN APPROVED INSPECTION AGENCY THAT MAINTAINS CONTINUING SUPERVISION, TESTING AND INSPECTION OVER THE QUALITY OF THE PRODUCT AND THAT HAS BEEN APPROVED BY AN ACCREDITATION BODY THAT COMPLIES WITH THE REQUIREMENTS OF THE AMERICAN LUMBER STANDARD COMMITTEE TREATED WOOD PROGRAM.
- ALL LUMBER SIZES NOTED AND SPECIFIED ON PLANS ARE NOMINAL SIZES UNLESS SPECIFICALLY INDICATED AS NET SIZE.

GLUE LAMINATED LUMBER

- REFER TO THE STRUCTURAL ENGINEER'S CURRENT NOTES, CALCULATIONS, AND SPECIFICATIONS.
- GLUED LAMINATED TIMBERS SHALL BE MANUFACTURED AND IDENTIFIED AS REQUIRED IN AITC A1901 AND ASTM D 3737.

PROTECTION AGAINST DECAY & TERMITES

- IN AREAS SUBJECT TO DECAY DAMAGE AS ESTABLISHED BY THE N.C.-R THE FOLLOWING LOCATIONS SHALL REQUIRE THE USE OF NATURALLY DURABLE WOOD OR WOOD THAT IS PRESERVATIVE TREATED IN ACCORDANCE WITH AFWPA UI FOR THE SPECIES, PRODUCT, PRESERVATIVE AND END USE. PRESERVATIVES SHALL BE LISTED IN SECTION 4 OF AFWPA UI
 - WOOD JOISTS OR THE BOTTOM OF WOOD FLOOR WHEN CLOSER THAN 18 INCHES, OR WOOD GIRDER WHEN CLOSER THAN 12 INCHES TO THE EXPOSED GROUND IN CRAWL SPACES OR UNEXCAVATED AREAS LOCATED WITHIN THE PERIPHERY OF THE BUILDING FOUNDATION.
 - ALL EXTERIOR SILLS & PLATES THAT REST ON CONCRETE OR MASONRY EXTERIOR FOUNDATION WALLS.
 - SILLS AND SLEEPERS ON A CONCRETE OR MASONRY SLAB, UNLESS THE SLAB THAT IS IN DIRECT CONTACT WITH THE GROUND IS SEPARATED FROM THE GROUND BY AN APPROVED IMPERVIOUS MOISTURE BARRIER.
 - THE ENDS OF WOOD GIRDER ENTERING EXTERIOR MASONRY OR CONCRETE WALLS HAVING CLEARANCES OF LESS THAN 0.5 INCH ON TOPS, SIDES AND ENDS.
 - WOOD SIDING AND SHEATHING ON THE EXTERIOR OF A BUILDING HAVING A CLEARANCE OF LESS THAN 6 INCHES FROM THE GROUND.
 - WOOD STRUCTURAL MEMBERS SUPPORTING MOISTURE-PERMEABLE FLOORS OR ROOFS THAT ARE EXPOSED TO THE WEATHER, SUCH AS CONCRETE OR MASONRY SLABS, UNLESS SEPARATED FROM SUCH FLOORS OR ROOFS BY AN IMPERVIOUS MOISTURE BARRIER.
 - WOOD FURRING STRIPS OR OTHER WOOD FRAMING MEMBERS ATTACHED DIRECTLY TO THE INTERIOR OF EXTERIOR MASONRY WALLS OR CONCRETE WALLS BELOW GRADE EXCEPT WHERE AN APPROVED VAPOR RETARDER IS APPLIED BETWEEN THE WALL AND THE FURRING STRIPS OR FURRING MEMBERS.
 - ALL PORTIONS OF A PORCH, SCREEN PORCH OR DECK FROM THE BOTTOM OF THE HEADER DOWN, INCLUDING POSTS, GUARDRAILS, PICKETS, STEPS AND FLOOR STRUCTURE, COVERINGS THAT WOULD PREVENT MOISTURE OR WATER ACCUMULATION ON THE SURFACE OR AT JOINTS BETWEEN MEMBERS ARE ALLOWED.
- IN AREAS SUBJECT TO DAMAGE FROM TERMITES METHODS OF PROTECTION SHALL BE ONE OF THE METHODS LISTED IN THE N.C.-R
- UNDER-FLOOR AREAS SHALL BE VENTILATED IN ACCORDANCE WITH THE REQUIREMENTS OF THE N.C.-R

WOOD & FRAMING (continued)

SHEATHING

- WOOD STRUCTURAL PANELS SHALL CONFORM TO THE REQUIREMENTS AS SET FORTH IN THE N.C.-R
- ROOF SHEATHING PANELS SHALL BE LAID WITH FACE GRAIN OR STRENGTH AXIS PERPENDICULAR TO SUPPORTS AND WITH PANEL CONTINUOUS OVER TWO OR MORE SPANS.
- ROOF SHEATHING SHALL BE IN ACCORDANCE WITH THE N.C.-R
- FLOOR SHEATHING PANELS SHALL BE LAID WITH FACE GRAIN OR STRENGTH AXIS PERPENDICULAR TO SUPPORTS AND WITH PANEL CONTINUOUS OVER TWO OR MORE SPANS.
- STRUCTURAL FLOOR SHEATHING SHALL COMPLY WITH THE PROVISIONS OF THE N.C.-R
- REFER TO THE STRUCTURAL ENGINEER'S CURRENT SPECIFICATIONS, CALCULATIONS, AND PLANS FOR REQUIRED STRENGTH, GRADE, AND THICKNESS FOR PLYWOOD FLOOR SHEATHING PANELS AND FOR DIAPHRAGM NAILING AND ADHESIVE REQUIREMENTS.
- ALL VERTICAL JOINTS OF PANEL SHEATHING SHALL OCCUR OVER, AND BE FASTENED TO, COMMON STUDS. HORIZONTAL JOINTS IN BRACED WALL PANELS SHALL OCCUR OVER, AND BE FASTENED TO, COMMON BLOCKING OF A MINIMUM OF 1 1/2 INCH THICKNESS.
- WHERE APPLICABLE, REFER TO THE SHEAR WALL SCHEDULE FOR REQUIRED STRENGTH, GRADE, AND THICKNESS OF PLYWOOD SHEAR PANELS AND FOR REQUIRED SHEAR WALL NAILING SCHEDULE.
- IN ONE- AND TWO-FAMILY DWELLING CONSTRUCTION USING VINYL OR ALUMINUM AS A SOFFIT MATERIAL, THE SOFFIT MATERIAL SHALL BE SECURELY ATTACHED TO FRAMING MEMBERS AND USE AN UNDERLAYMENT MATERIAL OF EITHER FIRE RETARDANT TREATED WOOD, 23/32 INCH WOOD SHEATHING OR 5/8 INCH GYPSUM BOARD. VENTING REQUIREMENTS APPLY TO BOTH SOFFIT AND UNDERLAYMENT AND SHALL BE PER SECTION R206 OF THE NORTH CAROLINA RESIDENTIAL CODE. WHERE THE PROPERTY LINE IS 10 FEET OR MORE FROM THE BUILDING FACE, THE PROVISIONS OF THIS CODE SECTION DO NOT APPLY.

FLOOR FRAMING

- ALL FLOOR JOISTS SHALL BE DESIGNED & JOIST WOOD FLOOR TRUSSES. REFER TO MANUFACTURER FOR ALL LAYOUTS AND CALCULATIONS.
- REFER TO THE STRUCTURAL ENGINEER'S CURRENT PLANS & CALCULATIONS FOR SIZE, SPACING, AND ANCHORAGE OF ALL FLOOR JOISTS; SIZE, LOCATION AND ANCHORAGE OF ALL FLOOR BEAMS AND HEADERS; AND ALL RELATED FRAMING ISSUES.

ROOF FRAMING

- ROOF FRAMING SHALL BE BY PRE-MANUFACTURED ROOF TRUSSES SPACED AT 24 INCHES ON CENTER UNLESS NOTED OTHERWISE.
- WOOD TRUSSES SHALL BE DESIGNED IN ACCORDANCE WITH THE REQUIREMENTS OF THE N.C.-R
- THE MANUFACTURER SHALL SUPPLY TO THE ARCHITECT AND BUILDER CALCULATIONS AND SHOP DRAWINGS FOR APPROVAL OF DESIGN LOADS, CONFIGURATION (2 OR 3 POINT BEARINGS), VOLUME CEILING OPTIONS, AND SHEAR TRANSFER, PRIOR TO FABRICATION.
- THE BRACINGS OF WOOD TRUSSES SHALL COMPLY TO THEIR APPROPRIATE ENGINEERED DESIGN, PER THE N.C.-R
- TRUSS MEMBERS SHALL NOT BE CUT, NOTCHED, DRILLED, SPLICED OR OTHERWISE ALTERED IN ANY WAY WITHOUT THE APPROVAL OF A REGISTERED DESIGN PROFESSIONAL. ALTERATIONS RESULTING IN THE ADDITION OF LOAD (E.G. HVAC EQUIPMENT, WATER HEATER) THAT EXCEEDS THE DESIGN LOAD FOR THE TRUSSES SHALL NOT BE PERMITTED WITHOUT WRITTEN VERIFICATION THAT THE TRUSS IS CAPABLE OF SUPPORTING SUCH ADDITIONAL LOADING.
- ALL CALCULATIONS AND SHOP DRAWINGS SHALL BE SIGNED BY A PROFESSIONAL ENGINEER REGISTERED IN THE STATE WHEREIN THE PROJECT IS TO BE BUILT.
- MANUFACTURER IS TO SECURE BUILDING DEPARTMENT APPROVAL OF CALCULATIONS AND SHOP DRAWINGS PRIOR TO FABRICATION.

WALL FRAMING

- THE SIZE, HEIGHT, AND SPACING OF STUDS SHALL BE IN ACCORDANCE WITH THE N.C.-R
- STUDS SHALL BE PLACED WITH THEIR WIDE DIMENSION PERPENDICULAR TO THE WALL.
- NOT LESS THAN THREE STUDS SHALL BE INSTALLED AT EACH CORNER OF AN EXTERIOR WALL.
- WOOD STUD WALLS SHALL BE GAPPED WITH A DOUBLE TOP PLATE INSTALLED TO PROVIDE OVERLAPPING AT CORNERS AND INTERSECTIONS WITH BEARING PARTITIONS. END JOINTS IN TOP PLATES SHALL BE OFFSET AT LEAST 24 INCHES. JOINTS NEED NOT OCCUR OVER STUDS. PLATES SHALL BE NOT LESS THAN 2-INCHES NOMINAL THICKNESS AND HAVE A WIDTH AT LEAST EQUAL TO THE WIDTH OF THE STUDS. SEE EXCEPTIONS.
- WHERE JOISTS, TRUSSES OR RAFTERS ARE SPACED MORE THAN 16 INCHES ON CENTER AND THE BEARING STUDS BELOW ARE SPACED 24 INCHES ON CENTER, SUCH MEMBERS SHALL BEAR WITHIN 5 INCHES OF THE STUDS BENEATH. SEE EXCEPTIONS.
- STUDS SHALL HAVE FULL BEARING ON NOMINAL 2 BY OR LARGER PLATE OR SILL HAVING A WIDTH AT LEAST EQUAL TO THE WIDTH OF THE STUDS.
- INTERIOR NONBEARING WALLS SHALL BE PERMITTED TO BE CONSTRUCTED WITH 2-INCH-BY-3-INCH STUDS SPACED 24 INCHES ON CENTER OR, WHEN NOT A PART OF A BRACED WALL LINE, 2-INCH-BY-4-INCH FLAT STUDS SPACED 16 INCHES ON CENTER. INTERIOR NONBEARING WALLS SHALL BE GAPPED WITH AT LEAST A SINGLE TOP PLATE. INTERIOR NONBEARING WALLS SHALL BE FIREBLOCKED IN ACCORDANCE WITH THE N.C.-R

WOOD & FRAMING (continued)

- DRILLING AND NOTCHING OF STUDS SHALL BE IN ACCORDANCE WITH THE FOLLOWING:
 - NOTHING, ANY STUD IN AN EXTERIOR WALL OR BEARING PARTITION MAY BE CUT OR NOTCHED TO A DEPTH NOT EXCEEDING 25 PERCENT OF ITS WIDTH. STUDS IN NONBEARING PARTITIONS MAY BE NOTCHED TO A DEPTH NOT TO EXCEED 40 PERCENT OF A SINGLE STUD WIDTH. NOTCHING OF BEARING STUDS SHALL BE ON ONE EDGE ONLY AND NOT TO EXCEED ONE-FOURTH THE HEIGHT OF THE STUD. NOTCHING SHALL NOT OCCUR IN THE BOTTOM OR TOP 6 INCHES OF BEARING STUDS.
 - DRILLING, ANY STUD MAY BE BORED OR DRILLED, PROVIDED THAT THE DIAMETER OF THE RESULTING HOLE IS NO MORE THAN 60 PERCENT OF THE STUD WIDTH. THE EDGE OF THE HOLE IS NO MORE THAN 5/8" INCH TO THE EDGE OF THE STUD, AND THE HOLE SHALL NOT BE CLOSER THAN 6 INCHES FROM AN ADJACENT HOLE OR NOTCH. HOLES NOT EXCEEDING 3/4 INCH DIAMETER CAN BE AS CLOSE AS 1 1/2 INCHES ON CENTER SPACING. STUDS LOCATED IN EXTERIOR WALLS OR BEARING PARTITIONS DRILLED OVER 40 PERCENT AND UP TO 60 PERCENT SHALL ALSO BE DOUBLED WITH NO MORE THAN TWO SUCCESSIVE DOUBLED STUDS BORED.
- WHEN PIPING OR DUCTWORK IS PLACED IN OR PARTIALLY IN AN EXTERIOR OR INTERIOR LOAD-BEARING WALL, NECESSITATING CUTTING, DRILLING OR NOTCHING OF THE TOP PLATE BE MORE THAN 50 PERCENT OF ITS WIDTH A GALVANIZED METAL TIE OF NOT LESS THAN 0.084 INCH THICK AND 1 1/2 INCHES WIDE SHALL BE FASTENED ACROSS AND TO THE PLATE AT EACH SIDE OF THE OPENING WITH NOT LESS THAN EIGHT 10# NAILS HAVING A MINIMUM LENGTH OF 11/2 INCHES (38 MM) AT EACH SIDE OR EQUIVALENT. THE METAL TIE MUST EXTEND A MINIMUM OF 6 INCHES PAST THE OPENING.
- HEADERS SHALL MEET THE REQUIREMENTS OF THE N.C.-R
- PROVIDE LATERAL BRACING PER THE N.C.-R
- FOUNDATION CRIPPLE WALLS SHALL MEET THE REQUIREMENTS OF THE N.C.-R CODE
- WOOD STUD WALLS SHALL BE BRACED AS REQUIRED BY THE N.C.-R
- UNLESS COVERED BY INTERIOR OR EXTERIOR WALL COVERINGS OR SHEATHING MEETING THE MINIMUM REQUIREMENTS OF THIS CODE, ALL STUD PARTITIONS OR WALLS WITH STUDS HAVING A HEIGHT-TO-LEAST THICKNESS RATIO EXCEEDING 50 SHALL HAVE BRIDGING NOT LESS THAN 2 INCHES IN THICKNESS AND OF THE SAME WIDTH AS THE STUDS FITTED SNUGLY AND NAILED THERETO TO PROVIDE ADEQUATE LATERAL SUPPORT.

FIRE BLOCKS AND DRAFT STOPS

- FIRE BLOCKING SHALL BE PROVIDED TO CUT OFF ALL CONCEALED DRAFT OPENINGS (BOTH VERTICAL AND HORIZONTAL) AND TO FORM AN EFFECTIVE BARRIER BETWEEN STORIES, AND BETWEEN A TOP STORY AND A ROOF SPACE. FIREBLOCKING SHALL BE PROVIDED IN WOOD-FRAME CONSTRUCTION IN THE LOCATIONS SPECIFIED IN THE N.C.-R
- FIRE BLOCKING SHALL CONSIST OF 2 INCHES NOMINAL LUMBER, OR TWO THICKNESSES OF 1-INCH NOMINAL LUMBER WITH BROKEN LAP JOINTS, OR ONE THICKNESS OF 23/32-INCH WOOD STRUCTURAL PANELS WITH JOINTS BACKED BY 23/32-INCH WOOD STRUCTURAL PANELS OR ONE THICKNESS OF 3/4-INCH PARTICLEBOARD WITH JOINTS BACKED BY 3/4-INCH PARTICLEBOARD, 1/2-INCH GYPSUM BOARD, OR 1/4-INCH CEMENT-BASED MILLBOARD.
- BATTS OR BLANKETS OF MINERAL WOOL OR GLASS FIBER OR OTHER APPROVED MATERIALS INSTALLED IN SUCH A MANNER AS TO BE SECURELY RETAINED IN PLACE SHALL BE PERMITTED AS AN ACCEPTABLE FIRE BLOCK.
- BATTS OR BLANKETS OF MINERAL OR GLASS FIBER OR OTHER APPROVED NON-RIGID MATERIALS SHALL BE PERMITTED FOR COMPLIANCE WITH THE 10 FOOT HORIZONTAL FIREBLOCKING IN WALLS CONSTRUCTED USING PARALLEL ROWS OF STUDS OR STAGGERED STUDS. LOOSE FILL INSULATION MATERIAL SHALL NOT BE USED AS A FIREBLOCK UNLESS SPECIFICALLY TESTED IN THE FORM AND MANNER INTENDED FOR USE TO DEMONSTRATE ITS ABILITY TO REMAIN IN PLACE AND TO RETARD THE SPREAD OF FIRE AND HOT GASSES.
- WHEN THERE IS USABLE SPACE BOTH ABOVE AND BELOW THE CONCEALED SPACE OF A FLOOR/CEILING ASSEMBLY, DRAFTSTOPS SHALL BE INSTALLED SO THAT THE AREA OF THE CONCEALED SPACE DOES NOT EXCEED 1000 SQUARE FEET. DRAFTSTOPPING SHALL DIVIDE THE CONCEALED SPACE INTO APPROXIMATELY EQUAL AREAS WHERE THE ASSEMBLY IS ENCLOSED BY A FLOOR MEMBRANE ABOVE AND A CEILING MEMBRANE BELOW. DRAFTSTOPPING SHALL BE PROVIDED IN FLOOR/CEILING ASSEMBLIES UNDER THE FOLLOWING CIRCUMSTANCES:
 - CEILING IS SUSPENDED UNDER THE FLOOR FRAMING.
 - FLOOR FRAMING IS CONSTRUCTED OF TRUSS-TYPE OPEN-VEEB OR PERFORATED MEMBERS.

HANDRAIL AND GUARDRAIL

- GUARDRAIL OF 36" HIGH MIN. SHALL BE PROVIDED WHERE FINISHED GRADE OR FLOOR BELOW RAISED AREA EXCEEDS 30".
- HANDRAIL AT STAIRS SHALL BE PROVIDED WHEN 4 OR MORE STAIR RISERS ARE REQUIRED.



NORTH CAROLINA 40' SERIES

KB HOME
NORTH CAROLINA DIVISION
4506 S. MIAMI BLVD.
SUITE 180
DURHAM, NC 27703
TEL: (919) 768-7980
FAX: (919) 544-2928

2018 NORTH CAROLINA STATE BUILDING CODES

ISSUE DATE: 05/28/15
PROJECT No.: 1350999:56
DIVISION MGR.: DCS
REVISIONS: 03/15/15

1 DIVISION REVISIONS NC18054NCF - 02/15/15 - CTD
2 2018 CODE UPDATE NC18055NCF/ 03/15/15 / CTD

FOR INTERNAL USE ONLY
REVISIONS BY:
1
2
3
4
5
6

PLAN:
240.2596
SHEET:
GN1

SPEC. LEVEL 1
RALEIGH-DURHAM 40' SERIES

MECHANICAL & PLUMBING

H.V.A.C.

- ALL MATERIALS AND CONSTRUCTION METHODS SHALL BE IN CONFORMANCE WITH THE NORTH CAROLINA MECHANICAL CODE. INSTALLATIONS OF MECHANICAL APPLIANCES, EQUIPMENT AND SYSTEMS NOT ADDRESSED BY THIS CODE SHALL COMPLY WITH THE APPLICABLE PROVISIONS OF THE NORTH CAROLINA FUEL GAS CODE.
- CONTRACTOR SHALL DESIGN ENTIRE H.V.A.C. SYSTEM AND SUBMIT DRAWINGS FOR OWNER/BUILDER'S APPROVAL PRIOR TO ORDERING MATERIALS OR EQUIPMENT.
- WHERE AIR CONDITIONING IS AN OPTIONAL FEATURE, HEATING SYSTEMS MUST BE DESIGNED AND DUCT WORK SIZED TO ACCOMMODATE FUTURE AIR CONDITIONING NEEDS.
- WHERE THE PRIMARY HEATING SYSTEM IS A FORCED-AIR FURNACE, AT LEAST ONE THERMOSTAT PER DWELLING UNIT SHALL BE CAPABLE OF CONTROLLING THE HEATING AND COOLING SYSTEM ON A DAILY SCHEDULE TO MAINTAIN DIFFERENT TEMPERATURE SET POINTS AT DIFFERENT TIMES OF THE DAY. THE THERMOSTAT SHALL BE CAPABLE OF SETTING UP TO SET BACK OR TEMPORARILY OPERATE THE SYSTEM TO MAINTAIN ZONE TEMPERATURES DOWN TO 55½F (13¼C) OR UP TO 65½F (24¼C).
- ALL DUCTWORK SHALL CONFORM TO THE REQUIREMENTS OF THE N.C.-M
- COMBUSTION AIR SHALL BE PROVIDED FOR FORCED AIR UNITS IN ACCORDANCE WITH N.C.-M
- CONTRACTOR TO PROVIDE BOOT IN DUCTWORK WHEN OPTIONAL "HONEYWELL" OR "CARRIER" ELECTRONIC AIR CLEANER IS PROVIDED.
- DUCTS IN THE GARAGE AND DUCTS PENETRATING THE WALLS OR CEILINGS SEPARATING THE DWELLING FROM THE GARAGE SHALL BE CONSTRUCTED OF A MINIMUM NO. 26 GAGE SHEET STEEL OR OTHER APPROVED MATERIAL AND SHALL HAVE NO OPENINGS INTO THE GARAGE PER N.C.-R
- EXTERIOR-GRADE INSTALLATIONS. EQUIPMENT AND APPLIANCES INSTALLED ABOVE GRADE LEVEL SHALL BE SUPPORTED ON A SOLID BASE OR APPROVED MATERIAL. A MINIMUM OF 2 INCHES THICK.
- UNDER-FLOOR INSTALLATION. SUSPENDED EQUIPMENT SHALL BE A MINIMUM OF 6 INCHES ABOVE THE ADJOINING GRADE.
- CRAWL SPACE SUPPORTS. IN A CRAWL SPACE, A MINIMUM OF 2-INCH THICK SOLID BASE, 2-INCH (51 MM) THICK FORMED CONCRETE, OR STACKED MASONRY UNITS HELD IN PLACE BY MORTAR OR OTHER APPROVED METHOD.
- DRAINAGE. BELOW-GRADE INSTALLATIONS SHALL BE PROVIDED WITH A NATURAL DRAIN OR AN AUTOMATIC LIFT OR SUMP PUMP. FOR FIT REQUIREMENTS REFER TO N.C.-M

VENTING

- IN LIEU OF REQUIRED EXTERIOR OPENINGS FOR NATURAL VENTILATION IN BATHROOMS CONTAINING A BATH, SHOWER OR COMBINATION THEREOF, A MECHANICAL VENTILATION SYSTEM MAY BE PROVIDED. THE MINIMUM VENTILATION RATES SHALL BE 50 CFM FOR INTERMITTENT VENTILATION OR 20 CFM FOR CONTINUOUS VENTILATION. VENTILATION AIR FROM THE SPACE SHALL BE EXHAUSTED DIRECTLY TO THE OUTSIDE PER N.C.-R
- EXHAUST DUCTS SHALL TERMINATE OUTSIDE THE BUILDING AND SHALL BE EQUIPPED WITH BACKDRAFT DAMPERS.
- WHERE DOMESTIC RANGE HOODS AND DOMESTIC APPLIANCES EQUIPPED WITH DOWNDRAFT EXHAUST ARE LOCATED WITHIN DWELLING UNITS, SUCH HOODS AND APPLIANCES SHALL DISCHARGE TO THE OUTDOORS THROUGH SHEET METAL DUCTS CONSTRUCTED OF GALVANIZED STEEL, STAINLESS STEEL, ALUMINUM OR COPPER. SUCH DUCTS SHALL HAVE SMOOTH INNER WALLS AND SHALL BE AIR TIGHT AND EQUIPPED WITH A BACKDRAFT DAMPER.
- WHERE INSTALLED IN ACCORDANCE WITH THE MANUFACTURER'S INSTALLATION INSTRUCTIONS, AND WHERE MECHANICAL OR NATURAL VENTILATION IS OTHERWISE PROVIDED, LISTED AND LABELED DUCTLESS RANGE HOODS SHALL NOT BE REQUIRED TO DISCHARGE TO THE OUTDOORS PER N.C.-M
- DUCTS FOR DOMESTIC KITCHEN COOKING APPLIANCES EQUIPPED WITH DOWN DRAFT EXHAUST SYSTEMS SHALL BE PERMITTED TO BE CONSTRUCTED OF SCHEDULE 40 PVC PIPE PROVIDED THAT THE INSTALLATION COMPLIES WITH ALL OF THE FOLLOWING PER N.C.-M:
 - THE DUCT SHALL BE INSTALLED UNDER A CONCRETE SLAB POURED ON GRADE.
 - THE UNDERFLOOR TRENCH IN WHICH THE DUCT IS INSTALLED SHALL BE COMPLETELY BACKFILLED WITH SAND OR GRAVEL.
 - THE PVC DUCT SHALL EXTEND NOT GREATER THAN 2 INCH ABOVE THE INDOOR CONCRETE FLOOR SURFACE.
 - THE PVC DUCT SHALL EXTEND NOT GREATER THAN 2 INCH ABOVE GRADE OUTSIDE THE BUILDING.
 - THE PVC DUCTS SHALL BE SOLVENT CEMENTED.
- EXHAUST HOOD SYSTEMS CAPABLE OF EXHAUSTING IN EXCESS OF 400 CFM SHALL BE PROVIDED WITH MAKEUP AIR AT A RATE APPROXIMATELY EQUAL TO THE EXHAUST AIR RATE. SUCH MAKEUP AIR SYSTEMS SHALL BE EQUIPPED WITH A MEANS OF CLOSURE AND SHALL BE AUTOMATICALLY CONTROLLED TO START AND OPERATE SIMULTANEOUSLY WITH THE EXHAUST SYSTEM.
- DOMESTIC WATER HEATERS, UNLESS SPECIFIED OTHERWISE BY THE MANUFACTURER'S INSTALLATION INSTRUCTIONS, SHALL BE VENTED TO THE OUTSIDE AIR BY A TYPE "B" VENT AND COMPLY WITH THE REQUIREMENTS OF THE N.C.-M

PLUMBING

- A POTABLE WATER SUPPLY SYSTEM SHALL BE DESIGNED, INSTALLED AND MAINTAINED IN SUCH A MANNER SO AS TO PREVENT CONTAMINATION FROM NONPOTABLE LIQUIDS, SOLIDS OR GASES BEING INTRODUCED INTO THE POTABLE WATER SUPPLY THROUGH CROSS-CONNECTIONS OR ANY OTHER PIPING CONNECTIONS TO THE SYSTEM. BACKFLOW PRE-VENTER APPLICATIONS SHALL CONFORM TO N.C.-P.
- THE SUPPLY LINES OR FITTINGS FOR EVERY PLUMBING FIXTURE SHALL BE INSTALLED SO AS TO PREVENT BACKFLOW. PLUMBING FIXTURE FITTINGS SHALL PROVIDE BACKFLOW PROTECTION IN ACCORDANCE WITH ASME A112.18.1.

PLUMBING (continued)

- ALL DEVICES, AFFURTENANCES, APPLIANCES AND APPARATUS INTENDED TO SERVE SOME SPECIAL FUNCTION, SUCH AS STERILIZATION, DISTILLATION, PROCESSING, COOLING, OR STORAGE OF ICE OR FOODS, AND THAT CONNECT TO THE WATER SUPPLY SYSTEM, SHALL BE PROVIDED WITH PROTECTION AGAINST BACKFLOW AND CONTAMINATION OF THE WATER SUPPLY SYSTEM. WATER PUMPS, FILTERS, SOFTENERS, TANKS AND ALL OTHER APPLIANCES AND DEVICES THAT HANDLE OR TREAT POTABLE WATER SHALL BE PROTECTED AGAINST CONTAMINATION.
- WATER SERVICE PIPING SHALL BE PROTECTED IN ACCORDANCE WITH N.C.-P SECTIONS AND EXCEPTIONS)
- FIXTURE FITTINGS, FAUCETS AND DIVERTERS SHALL BE CONNECTED TO THE WATER DISTRIBUTION SYSTEM SO THAT HOT WATER CORRESPONDS TO THE LEFT SIDE OF THE FITTINGS.
- DIVERTERS FOR SINK FAUCETS WITH A SECONDARY OUTLET CONSISTING OF A FLEXIBLE HOSE AND SPRAY ASSEMBLY SHALL CONFORM TO ASSE 1025 IN ADDITION TO THE REQUIREMENTS IN N.C.-P
- THE INSTALLATION OF A WATER SERVICE OR WATER DISTRIBUTION PIPE SHALL BE PROHIBITED IN SOIL AND GROUND WATER THAT IS CONTAMINATED. GROUND WATER CONDITIONS SHALL BE REQUIRED TO ASCERTAIN THE ACCEPTABILITY OF THE WATER SERVICE OR WATER DISTRIBUTION PIPING MATERIAL FOR THE SPECIFIC INSTALLATION, WHERE DETRIMENTAL CONDITIONS EXIST, APPROVED ALTERNATIVE MATERIALS OR ROUTING SHALL BE REQUIRED.
- WATER DISTRIBUTION PIPE SHALL CONFORM TO NSF 61 AND SHALL CONFORM TO ONE OF THE STANDARDS LISTED IN N.C.-PLUMBING. ALL WATER DISTRIBUTION PIPE AND TUBING SHALL HAVE A MINIMUM PRESSURE RATING OF 100 PSI AT 180 DEGREES F.
- PIPE PASSING THROUGH CONCRETE OR CINDER WALLS AND FLOORS OR OTHER CORROSIVE MATERIAL SHALL BE PROTECTED AGAINST EXTERNAL CORROSION BY A PROTECTIVE SHEATHING OR WRAPPING OR OTHER MEANS THAT WILL WITHSTAND ANY REACTION FROM THE LINE AND ACID OF CONCRETE, CINDER OR OTHER CORROSIVE MATERIAL. SHEATHING OR WRAPPING SHALL ALLOW FOR EXPANSION AND CONTRACTION OF PIPING TO PREVENT ANY RUBBING ACTION. MINIMUM WALL THICKNESS OF MATERIAL SHALL BE 0.025-INCH.
- PIPES PASSING UNDER OR THROUGH WALLS SHALL BE PROTECTED FROM BREAKAGE.
- PIPING IN A PLUMBING SYSTEM SHALL BE INSTALLED SO AS TO PREVENT STRAINS AND STRESSES THAT EXCEED THE STRUCTURAL STRENGTH OF THE PIPE. WHERE NECESSARY, PROVISIONS SHALL BE MADE TO PROTECT PIPING FROM DAMAGE RESULTING FROM EXPANSION, CONTRACTION AND STRUCTURAL SETTLEMENT.
- THE TOP OF WATER PIPES, INSTALLED BELOW GRADE OUTSIDE THE BUILDING, SHALL BE BELOW THE FROST LINE OR A MINIMUM OF 12 INCHES BELOW FINISHED GRADE, WHICHEVER IS GREATER. WATER PIPES INSTALLED IN A WALL EXPOSED TO THE EXTERIOR SHALL BE LOCATED ON THE HEATED SIDE OF THE WALL INSULATION. WATER PIPING INSTALLED IN AN UNCONDITIONED ATTIC OR UNCONDITIONED UTILITY ROOM SHALL BE INSULATED WITH AN INSULATION HAVING A MINIMUM R-FACTOR OF 6.5 DETERMINED AT 75 DEGREES F IN ACCORDANCE WITH ASTM C 177. SEE NOTE IN N.C.-P FOR ADDITIONAL REQUIREMENTS.
- BUILDING SEWER PIPE SHALL CONFORM TO ONE OF THE STANDARDS LISTED IN N.C.-P.
- BUILDING SEWER PIPE FITTINGS SHALL BE APPROVED FOR INSTALLATION WITH THE PIPING MATERIAL INSTALLED AND SHALL CONFORM TO THE RESPECTIVE PIPE STANDARDS OR ONE OF THE STANDARDS LISTED IN N.C.-P.
- WHERE WASTE LINE DROPS OCCUR IN A LOCATION WHERE THE SOUND OF A FLUSHED TOILET MAY BE UNDESIRABLE, SUCH AS IN WALLS OR PARTITIONS ADJACENT TO EATING ROOMS, USE CAST IRON PIPING OR SIMILAR APPROVED HARD OR DENSE PIPING TO MITIGATE SOUND.
- CLEANOUTS ON BUILDING SEWERS SHALL BE LOCATED AS SET FORTH IN N.C.-P.
- THE MAXIMUM WATER CONSUMPTION FLOW RATES AND QUANTITIES FOR ALL PLUMBING FIXTURES SHALL BE IN ACCORDANCE WITH N.C.-P.
- INDIVIDUAL SHOWER AND TUB-SHOWER COMBINATION VALVES SHALL BE BALANCED-PRESSURE, THERMOSTATIC OR COMBINATION BALANCED-PRESSURE/THERMOSTATIC VALVES THAT CONFORM TO THE REQUIREMENTS OF ASSE 1016 OR ASME A112.18.1/CSA B125.1 AND SHALL BE INSTALLED AT THE POINT OF USE.
- WATER HEATERS HAVING AN IGNITION SOURCE SHALL BE ELEVATED SUCH THAT THE SOURCE OF IGNITION IS NOT LESS THAN 18 INCHES ABOVE THE GARAGE FLOOR. REFER TO N.C.-P FOR EXCEPTION.
- WATER HEATERS, (USING SOLID, LIQUID OR GAS FUEL) WITH THE EXCEPTION OF THOSE HAVING DIRECT VENT SYSTEMS, SHALL NOT BE INSTALLED IN BATHROOMS AND BEDROOMS OR IN A CLOSET WITH ACCESS ONLY THROUGH A BEDROOM OR BATHROOM; HOWEVER, WATER HEATERS OF THE AUTOMATIC STORAGE TYPE MAY BE INSTALLED AS REPLACEMENT IN A BATHROOM WHEN APPROVED BY THE PLUMBING OFFICIAL, PROVIDED THEY ARE VENTED AND SUPPLIED WITH ADEQUATE COMBUSTION AIR.
- IN SEISMIC DESIGN CATEGORIES D1 AND D2, WATER HEATERS SHALL BE ANCHORED OR STRAPPED TO RESIST HORIZONTAL DISPLACEMENT DUE TO EARTHQUAKE MOTION. STRAPPING SHALL BE AT POINTS WITHIN THE UPPER ONE-THIRD AND LOWER ONE-THIRD OF THE APPLIANCE'S VERTICAL DIMENSIONS. AT THE LOWER POINT, THE STRAPPING SHALL MAINTAIN A MINIMUM DISTANCE OF 4 INCHES ABOVE THE CONTROLS.
- APPLIANCES LOCATED IN A GARAGE OR CARPORT SHALL BE PROTECTED FROM IMPACT BY A MOVING VEHICLE.
- WHERE WATER HEATERS OR HOT WATER STORAGE TANKS ARE INSTALLED IN REMOTE LOCATIONS SUCH AS SUSPENDED CEILING, ATTICS, ABOVE OCCUPIED SPACES, OR UNVENTILATED CRAWL SPACES, THE TANK OR WATER HEATER SHALL BE INSTALLED IN A GALVANIZED STEEL PAN HAVING A MINIMUM THICKNESS OF 24 GAGE, OR OTHER PANS APPROVED FOR SUCH USE.
- WHERE CLOTHES WASHING MACHINES ARE LOCATED ON WOOD FRAMED FLOORS WHERE LEAKAGE WOULD CAUSE DAMAGE, A GALVANIZED STEEL PAN HAVING A MINIMUM THICKNESS OF 24 GAGE, OR OTHER PANS APPROVED FOR SUCH USE SHALL BE PROVIDED.
- ALL STORAGE WATER HEATERS OPERATING ABOVE ATMOSPHERIC PRESSURE SHALL BE PROVIDED WITH AN APPROVED, SELF-CLOSING (LEVERED) PRESSURE RELIEF VALVE AND TEMPERATURE RELIEF VALVE OR COMBINATION THEREOF. THE RELIEF VALVE SHALL CONFORM TO ANSI Z21.22. THE RELIEF VALVE SHALL NOT BE USED AS A MEANS OF CONTROLLING THERMAL EXPANSION.

MECHANICAL & PLUMBING (continued)

- DOMESTIC DISH WASHING MACHINES SHALL DISCHARGE INDIRECTLY THROUGH AN AIR GAP OR AIR BREAK INTO A STANDPIPE OR WASTE RECEPTOR IN ACCORDANCE WITH N.C.-P, OR DISCHARGE INTO A WYE-BRANCH FITTING ON THE TAILPIECE OF THE KITCHEN SINK OR THE DISHWASHER CONNECTION OF A FOOD WASTE GRINDER. THE WASTE LINE OF A DOMESTIC DISH WASHING MACHINE DISCHARGING INTO A KITCHEN SINK TAILPIECE OR FOOD WASTE GRINDER SHALL CONNECT TO A DECK MOUNTED AIR GAP OR THE WASTE LINE SHALL RISE AND BE SECURELY FASTENED TO THE UNDERSIDE OF THE SINK RIM OR COUNTER.

FIREPLACES

- FACTORY-BUILT FIREPLACES SHALL BE LISTED AND LABELED AND SHALL BE INSTALLED IN ACCORDANCE WITH THE CONDITIONS OF THE LISTING. FACTORY-BUILT FIREPLACES SHALL BE TESTED IN ACCORDANCE WITH UL 127.
- FIREPLACES ARE TO BE PROVIDED WITH AN EXTERIOR AIR SUPPLY

ELECTRICAL

- ALL MATERIALS AND APPLIANCES, INSTALLATION AND CONSTRUCTION METHODS SHALL COMPLY WITH THE NATIONAL ELECTRICAL CODE OR CURRENT SAE REQUIREMENTS.
- ALL ELECTRICAL SYSTEMS, CIRCUITS, FIXTURES AND EQUIPMENT SHALL BE GROUNDED IN A MANNER COMPLYING WITH ARTICLE 250 OF THE NATIONAL ELECTRICAL CODE.
- ALL WIRING SHALL BE SO INSTALLED THAT, WHEN COMPLETED, THE SYSTEM WILL BE FREE FROM SHORT CIRCUITS AND FROM GROUNDS OTHER THAN AS REQUIRED OR PERMITTED IN N.E.C. ARTICLE 250.
- ELECTRIC EQUIPMENT SHALL BE INSTALLED IN A NEAT AND WORK-MANLIKE MANNER.
- ALL 125-VOLT, SINGLE-PHASE, 15- AND 20-AMPERE RECEPTACLES INSTALLED IN THE LOCATIONS SPECIFIED BELOW SHALL HAVE GROUND-FAULT CIRCUIT-INTERRUPTER PROTECTION FOR PERSONNEL.
 - BATHROOMS.
 - GARAGES AND ALSO ACCESSORY BUILDINGS THAT HAVE A FLOOR LOCATED AT OR BELOW GRADE LEVEL NOT INTENDED AS HABITABLE ROOMS AND LIMITED TO STORAGE AREAS, WORK AREAS, AND AREAS OF SIMILAR USE.
 - OUTDOORS.
 - CRAWL SPACES. WHERE THE CRAWL SPACE IS AT OR BELOW GRADE LEVEL.
 - UNFINISHED BASEMENTS DEFINED AS PORTIONS OR AREAS OF THE BASEMENT NOT INTENDED AS HABITABLE ROOMS AND LIMITED TO STORAGE AREAS, WORK AREAS, AND THE LIKE.
 - KITCHENS. WHERE THE RECEPTACLES ARE INSTALLED TO SERVICE THE COUNTERTOP SURFACES.
 - SINKS. WHERE SINKS ARE LOCATED IN AREAS OTHER THAN KITCHENS AND RECEPTACLES ARE INSTALLED WITHIN 6' OF THE OUTSIDE EDGE OF THE SINK.
 - BOAT HOUSES.
- APPLIANCE RECEPTACLE OUTLETS INSTALLED IN A DWELLING UNIT FOR SINKS, REST ROOMS, BATHS, AND COUNTERTOP OUTLETS AND BE INSTALLED WITHIN 6 FEET OF THE INTENDED LOCATION OF THE APPLIANCE.
- IN EVERY KITCHEN, FAMILY ROOM, DINING ROOM, LIVING ROOM, PARLOR, LIBRARY, DEN, SUNROOM, BEDROOM, RECREATION ROOM, OR SIMILAR ROOM OR AREA OF DWELLINGS UNITS, RECEPTACLE OUTLETS SHALL BE INSTALLED SO THAT NO POINT ALONG THE FLOOR LINE IN ANY WALL SPACE IS MORE THAN 6 FEET, MEASURED HORIZONTALLY, FROM AN OUTLET IN THAT SPACE, INCLUDING ANY WALL SPACE 2 FEET OR MORE IN WIDTH (INCLUDING SPACE BETWEEN MEASURED AROUND CORNERS) AND UNBROKEN ALONG THE FLOOR LINE BY DOORWAYS AND SIMILAR OPENINGS, FIREPLACES, AND FIXED CABINETS, AND THE WALL SPACE OCCUPIED BY FIXED PANELS IN EXTERIOR WALLS, BUT EXCLUDING SLIDING PANELS IN EXTERIOR WALLS. THE WALL SPACE AFFORDED BY FIXED ROOM DIVIDERS, SUCH AS FREESTANDING BAR-TYPE COUNTERS OR RAILINGS, SHALL BE INCLUDED IN THE 6 FOOT MEASUREMENT.
- IN THE KITCHEN, PANTRY, BREAKFAST ROOM, DINING ROOM, OR SIMILAR AREA OF A DWELLING UNIT, THE TWO OR MORE 20-AMPERE SMALL-APPLIANCE BRANCH CIRCUITS REQUIRED SHALL SERVE ALL WALL AND FLOOR RECEPTACLE OUTLETS, ALL COUNTERTOP OUTLETS AND RECEPTACLE OUTLETS FOR REFRIGERATION EQUIPMENT, THE TWO OR MORE SMALL-APPLIANCE BRANCH CIRCUITS SHALL HAVE NO OTHER OUTLETS.
- IN KITCHENS, PANTRIES, BREAKFAST ROOMS, DINING ROOMS AND SIMILAR AREAS OF DWELLING UNITS, RECEPTACLE OUTLETS FOR COUNTER SPACES SHALL BE INSTALLED IN ACCORDANCE WITH THE FOLLOWING:
 - A RECEPTACLE OUTLET SHALL BE INSTALLED AT EACH WALL COUNTER SPACE 12 INCHES OR WIDER. RECEPTACLE OUTLETS SHALL BE INSTALLED SO THAT NO POINT ALONG THE WALL LINE IS MORE THAN 24 INCHES MEASURED HORIZONTALLY FROM A RECEPTACLE OUTLET IN THAT SPACE.
 - AT LEAST ONE RECEPTACLE OUTLET SHALL BE INSTALLED AT EACH ISLAND COUNTER SPACE WITH A LONG DIMENSION OF 24 INCHES OR GREATER AND A SHORT DIMENSION OF 12 INCHES OR GREATER.
 - AT LEAST ONE RECEPTACLE OUTLET SHALL BE INSTALLED AT EACH PENINSULAR COUNTER SPACE WITH A LONG DIMENSION OF 24 INCHES OR GREATER AND A SHORT DIMENSION OF 12 INCHES OR GREATER. A PENINSULAR COUNTERTOP IS MEASURED FROM CONNECTING EDGE.
 - COUNTERTOP SPACES SEPARATED BY RANGE TOPS, REFRIGERATORS, OR SINKS SHALL BE CONSIDERED AS SEPARATE COUNTERTOP SPACES IN APPLYING THE REQUIREMENTS OF (1), (2), AND (3) ABOVE. IF A RANGE, COUNTER-MOUNTED COOKING UNIT, OR SINK IS INSTALLED IN AN ISLAND OR PENINSULAR COUNTERTOP AND THE DEPTH OF THE COUNTER BEHIND THE ITEM IS LESS THAN 12 INCHES, IT WILL BE CONSIDERED TO DIVIDE THE COUNTERTOP SPACE INTO TWO SEPARATE COUNTERTOP SPACES. EACH COUNTERTOP SPACE SHALL COMPLY WITH APPLICABLE REQUIREMENTS.
 - RECEPTACLE OUTLETS SHALL BE LOCATED NOT MORE THAN 20 INCHES ABOVE THE COUNTERTOP. RECEPTACLE OUTLETS RENDERED NOT READILY ACCESSIBLE BY APPLIANCES FASTENED IN PLACE, APPLIANCE GARAGES, SINKS, OR RANSETOPS AS COVERED IN 4) ABOVE, OR APPLIANCES OCCUPYING DEDICATED SPACE SHALL NOT BE CONSIDERED AS THESE REQUIRED OUTLETS.

ELECTRICAL (continued)

ELECTRICAL (continued)

- AT LEAST ONE WALL RECEPTACLE OUTLET SHALL BE INSTALLED IN BATHROOMS WITHIN 3 FEET OF THE OUTSIDE EDGE OF EACH BASIN. THE RECEPTACLE OUTLET SHALL BE LOCATED IN WALL OR PARTITION THAT IS ADJACENT TO THE BASIN OR BASIN COUNTERTOP OR INSTALLED ON THE SIDE OR FACE OF THE BASIN CABINET NOT MORE THAN 12" BELOW THE COUNTERTOP.
- IN DWELLING UNITS, AT LEAST ONE RECEPTACLE OUTLET SHALL BE INSTALLED FOR THE LAUNDRY.
- CABLE- OR RACEWAY-TYPE WIRING METHODS INSTALLED IN A GROOVE, TO BE COVERED BY WALLBOARD, SIDING, PANELINGS, CARPETING, OR SIMILAR FINISH, SHALL BE PROTECTED BY 1/16 INCH THICK STEEL PLATE, SLEEVE, OR EQUIVALENT OR BY NOT LESS THAN 1-1/4 INCH FREE SPACE FOR THE FULL LENGTH OF THE GROOVE IN WHICH THE CABLE OR RACEWAY IS INSTALLED.
- RECEPTACLES IN DAMP OR WET LOCATIONS.
 - A RECEPTACLE INSTALLED OUTDOORS IN A LOCATION PROTECTED FROM WEATHER OR IN OTHER DAMP LOCATIONS SHALL HAVE AN ENCLOSURE FOR THE RECEPTACLE THAT IS WEATHERPROOF WHEN THE RECEPTACLE IS COVERED. (ATTACHMENT PLUG CAP NOT INSERTED AND RECEPTACLE COVERS CLOSED.)
 - ALL 15- AND 20- AMPERE, 125- AND 250-VOLT RECEPTACLES INSTALLED IN A WET LOCATION SHALL HAVE AN ENCLOSURE THAT IS WEATHER PROOF WHETHER OR NOT THE ATTACHMENT PLUG CAP IS INSERTED. ALL 15- AND 20- AMPERE, 125- AND 250-VOLT NONLOCKING RECEPTACLES SHALL BE LISTED WEATHER RESISTANT TYPE.
- LIGHTING EQUIPMENT. A MINIMUM OF 75 PERCENT OF THE LAMPS IN PERMANENTLY INSTALLED LIGHTING FIXTURES SHALL BE HIGH-EFFICACY LAMPS
- LIGHT FIXTURES WITHIN CLOTHES CLOSETS SHALL BE INSTALLED IN ACCORDANCE WITH N.E.C.
- ALL 120-VOLT, SINGLE PHASE, 15- AND 20-AMPERE BRANCH CIRCUITS SUPPLYING OUTLETS INSTALLED IN DWELLING UNIT FAMILY ROOMS, DINING ROOMS, PARLORS, LIBRARIES, DEN, BEDROOMS, SUNROOMS, RECREATION ROOMS, CLOSETS, HALLWAYS, OR SIMILAR ROOMS OR AREAS SHALL BE PROTECTED BY AN ARC-FAULT CIRCUIT INTERRUPTER(S), COMBINATION-TYPE, INSTALLED TO PROVIDE PROTECTION OF THE BRANCH CIRCUIT.
- APPROVED NUMBERS OR ADDRESSES ARE TO BE PROVIDED FOR ALL NEW BUILDINGS IN SUCH A POSITION AS TO BE PLAINLY VISIBLE AND LEGIBLE FROM THE STREET OR ROAD FRONTING THE PROPERTY.
- TAMPER-RESISTANT RECEPTACLES IN DWELLING UNITS IN ALL AREAS. ALL NON-LOCKING TYPE 125-VOLT 15-AND 20-AMPERE RECEPTACLES SHALL BE LISTED TAMPER-RESISTANT RECEPTACLES. EXCEPTIONS LISTED BELOW:
 - RECEPTACLES LOCATED MORE THAN 5½' ABOVE THE FLOOR.
 - RECEPTACLES THAT ARE PART OF A LUMINAIRE OR APPLIANCE.
 - A SINGLE RECEPTACLE OR A DUPLEX RECEPTACLE FOR TWO APPLIANCES LOCATED WITHIN DEDICATED SPACE FOR EACH APPLIANCE THAT, IN NORMAL USE, IS NOT EASILY MOVED FROM ONE PLACE TO ANOTHER, AND THAT IS GROUND-AND-PLUS CONNECTED.
 - NON-GROUNDING RECEPTACLES USED FOR REPLACEMENTS.
- ALL NON-LOCKING TYPE 125-VOLT 15-AND 20-AMPERE RECEPTACLES LOCATED IN GUEST ROOMS AND GUEST SUITES SHALL BE LISTED TAMPER-RESISTANT RECEPTACLES.

SMOKE DETECTORS

- ALL SMOKE ALARMS SHALL BE LISTED IN ACCORDANCE WITH UL 217 AND INSTALLED IN ACCORDANCE WITH THE PROVISIONS OF THIS CODE AND THE HOUSEHOLD FIRE MARKING EQUIPMENT PROVISIONS OF NFPA 72.
- HOUSEHOLD FIRE ALARM SYSTEMS INSTALLED IN ACCORDANCE WITH NFPA 72 THAT INCLUDE SMOKE ALARMS, OR A COMBINATION OF SMOKE DETECTOR AND AUDIBLE NOTIFICATION DEVICE INSTALLED AS REQUIRED BY THE NC-R FOR SMOKE ALARMS, SHALL BE PERMITTED. THE HOUSEHOLD FIRE ALARM SYSTEM SHALL PROVIDE THE SAME LEVEL OF SMOKE DETECTION AND ALARM AS REQUIRED BY THE NC-R FOR SMOKE ALARMS, WHERE A HOUSEHOLD FIRE WARNING SYSTEM IS INSTALLED USING A COMBINATION OF SMOKE DETECTOR AND AUDIBLE NOTIFICATION DEVICE(S), IT SHALL BECOME A PERMANENT FEATURE OF THE OCCUPANCY AND OWNED BY THE HOMEOWNER. THE SYSTEM SHALL BE MONITORED BY AN APPROVED SUPERVISING STATION AND BE MAINTAINED IN ACCORDANCE WITH NFPA72.

CARBON MONOXIDE ALARMS

- IN NEW CONSTRUCTION, DWELLING UNITS SHALL BE PROVIDED WITH AN APPROVED CARBON MONOXIDE ALARM INSTALLED OUTSIDE OF EACH SEPARATE SLEEPING AREA IN THE IMMEDIATE VICINITY OF THE BEDROOM(S) AS DIRECTED BY THE ALARM MANUFACTURER.
- THE REQUIRED CARBON MONOXIDE ALARMS SHALL BE AUDIBLE IN ALL BEDROOMS OVER BACKGROUND NOISE LEVELS WITH ALL INTERVENING DOORS CLOSED. SINGLE STATION CARBON MONOXIDE ALARMS SHALL BE LISTED AS COMPLYING WITH UL 2054 AND SHALL BE INSTALLED IN ACCORDANCE WITH THIS CODE AND THE MANUFACTURER'S INSTALLATION INSTRUCTIONS.



NORTH CAROLINA 40' SERIES

KB HOME
NORTH CAROLINA DIVISION
4506 S. MIAMI BLVD.
SUITE 180
DURHAM, NC 27703
TEL: (919) 768-7980
FAX: (919) 544-2928

2018 NORTH CAROLINA STATE BUILDING CODES

ISSUE DATE: 05/28/15
PROJECT No.: 1350999-5C
DIVISION MGR.: DCS
REVISIONS: 03/15/19

1 DIVISION REVISIONS
NC18054NCP - 08/13/18 - CTD

2 2018 CODE UPDATE
NC19051NCP/ 03/15/19 / CTD

FOR INTERNAL USE ONLY

REVIEWED BY:

L _____

A _____

B _____

S _____

PLAN:
240.2596
SHEET:
GN3

SPEC. LEVEL 1 RALEIGH-DURHAM 40' SERIES

These designs and drawings are CONFIDENTIAL and the exclusive property of KB Home Corporation and are not to be disclosed without the express permission of KB Home Corporation. Copyright 2019 © KB Home Corporation. All rights reserved.



**NORTH CAROLINA
40' SERIES**

KB HOME
NORTH CAROLINA DIVISION
4506 S. MIAMI BLVD.
SUITE 180
DURHAM, NC 27703
TEL: (919) 768-7980
FAX: (919) 544-2928

**2018 NORTH
CAROLINA STATE
BUILDING
CODES**

ISSUE DATE: 05/28/15
PROJECT No.: 1350999-5C
DIVISION MGR.: DCS
REVISIONS: 03/15/19

1 DIVISION REVISIONS
NC18054NCP - 08/15/18 - CTD
2 2018 CODE UPDATE
NC18055NCP / 03/15/19 - CTD

NO.	REVISION	DATE
1	FOR INTERNAL USE ONLY	
2		
3		
4		
5		
6		

PLAN:
240.2596
SHEET:
1.1

**SPEC. LEVEL 1
RALEIGH-DURHAM
40' SERIES**

- # FLOOR PLAN NOTES**
- NOTE: NOT ALL KEY NOTES APPLY.
- SINK - GARBAGE DISPOSAL OPTIONAL - VERIFY DIMENSIONS WITH MANUFACTURERS SPECS
 - DISHWASHER - PROVIDE AIR GAP - VERIFY SPACINGS & DIMENSIONS PER MANUFACTURERS' SPECS
 - SLIDE-IN RANGE/OVEN COMBINATION W/ BUILT-IN NON-VENTED HOOD W/LIGHT & FAN - VERIFY WITH MANUFACTURERS' SPECS
 - 30" COOKTOP W/ BUILT-IN VENTED HOOD W/ LIGHT & FAN - VERIFY WITH MANUFACTURERS' SPECS
 - 34" CLEAR REFRIGERATOR SPACE W/ OPTIONAL CABINETS ABOVE - OPT. PLUMBING FOR ICEMAKER (RECESSED IN WALL)
 - COMBINATION DOUBLE OVEN OR OVEN/MICROWAVE OVEN OR OVEN - VERIFY DIMENSIONS WITH MANUFACTURERS' SPECS
 - BASE CABINETS - REFER TO INTERIOR ELEVATIONS
 - UPPER CABINETS - REFER TO INTERIOR ELEVATIONS
 - ISLAND CABINET - REFER TO INTERIOR ELEVATIONS
 - MIN. 12" BAR TOP/ BREAKFAST BAR
 - DESK AREA - REFER TO INTERIOR ELEVATIONS
 - BUILT-IN PANTRY (15" DEEP OR U.N.O.)
 - SINK CABINET(S) - REFER TO INTERIOR ELEVATIONS
 - SINK CABINET W/ EXTENDED VANITY & KNEE SPACE BELOW - REFER TO INTERIOR ELEVATIONS
 - OPT. SINK - REFER TO INTERIOR ELEVATIONS.
 - KNEE SPACE - REFER TO INTERIOR ELEVATIONS
 - PRE-FAB. TUB/SHOWER COMBO W/ FIBERGLASS WAINSCOT TO T2 - VERIFY DIMENSIONS W/ MANUF'S SPECS
 - OVAL TUB - VERIFY DIMENSIONS WITH MANUF'S SPECS.
 - PRE-FAB. SHOWER PAN W/ 30" MIN. CLR. INSIDE & WAINSCOT TO T2 - VERIFY DIMENSIONS W/ MANUF'S SPECS
 - SHATTERPROOF (TEMPERED) GLASS SHOWER ENCLOSURE.
 - TOWEL BAR - PROVIDE 2x SOLID BLK'S IN WALL
 - TOILET PAPER HOLDER - PROVIDE 2x SOLID BLK'S IN WALL
 - RECESSED, MIRRORED MEDICINE CABINET
 - WASHER & DRYER - PROVIDE WATER & WASTE FOR WASHER - RECESS WASHER CONTROL VALVES IN WALL - VENT DRYER TO OUTSIDE AIR - PROVIDE "SMITTY PAN" W/ DRAIN BELOW WASHER AT 2ND FLOOR LAUNDRY LOCATION
 - ACCOMMODATE APPLIANCES TO BE LOCATED WASHER AT LEFT AND DRYER AT RIGHT.
 - 12" SHELF PER SPECS
 - OPT. LAUNDRY SINK - REFER TO INTERIOR ELEV'S
 - WATER HEATER LOCATION - FOR GAS - LOCATE ON 10" HIGH PLATFORM - FOR INTERIOR LOCATION - PROVIDE PAN & DRAIN. (REFER TO DETAILS)
 - WATER HEATER 'B' VENT TO OUTSIDE AIR
 - MAIN LINE SHUT-OFF VALVE AND TEMP. & PRESSURE RELIEF VALVE
 - FAUJ. LOCATION (REFER TO DETAIL SHEETS)
 - FAUJ. 'B' VENT TO OUTSIDE AIR
 - LISTED FACTORY-BUILT GAS FIRED DEC. APPLIANCE (REF. 80/AD4) - INSTALL PER MFR. SPECS
 - HEARTH TO BE INSTALLED PER FACTORY-BUILT FIREPLACE LISTING
 - GAS APPLIANCE 'B' VENT FROM BELOW
 - LINEN PER SPECS (15" DEEP OR U.N.O.)
 - COAT CLOSET W/ SHELF & POLE (REFER TO DETAIL SHEETS)
 - WARDROBE W/ SHELF & POLE (REFER TO DETAIL SHEETS)
 - 22"x30" MIN. ATTIC ACCESS (REFER TO DETAIL SHEETS) W/ 25"x54" PULL DOWN LADDER R.O. ATTIC ACCESS TO BE PROTECTED
 - LINE OF WALL BELOW
 - DUCT CHASE
 - LINE OF FLOOR ABOVE
 - LINE OF FLOOR BELOW
 - LINE OF OPTIONAL TRAY CEILING (REFER TO DETAIL SHEETS)
 - LINE OF HIP AT OPTIONAL VOLUME CEILING
 - LINE OF RIDGE AT OPTIONAL VOLUME CEILING
 - CEILING BREAK
 - STAIR TREADS & RISERS - MIN. 10" TREAD & MAX. 7 3/4" RISER - (REFER TO DETAIL SHEETS)
 - MIN. 36" HIGH GUARDRAIL (REFER TO DETAIL SHEETS)
 - 34" TO 38" HIGH HANDRAIL (REFER TO DETAIL SHEETS)
 - A/C PAD LOCATION
 - LOW WALL - REFER TO PLAN FOR HEIGHT
 - 2x6 STUD WALL
 - 2x6 BALLOON FRAMED WALL PER STRUCTURAL
 - DBL. 2x4 WALL PER PLAN
 - INTERIOR SHELF-SEE PLAN FOR HT. (REFER TO DETAIL SHEETS)
 - FLAT SOFFIT - REFER TO PLATE NOTES / ELEV. FOR H&T.
 - ARCHED SOFFIT - REFER TO PLATE NOTES / ELEV. FOR H&T.
 - WINDOW SEAT
 - OPT. DOOR/ WINDOW
 - PRE-MANUFACTURED DECORATIVE COLUMN (SIZE, SEE ELEV.) PLYON OR EQ. SURROUNDING STRUCTURAL POST.
 - BRICK / STONE VENEER - REFER TO ELEVATIONS VENEER TO COMPLY WITH THE N.G.-R.
 - SECTIONAL GARAGE DOOR PER SPECS
 - MIN. 1/2" GYP. BD. ON CEILING & WALLS @ USEABLE SPACE UNDER STAIR.
 - GARAGE SHALL BE SEPARATED FROM THE RESIDENCE AND ITS ATTIC AREA BY NOT LESS THAN 1/2" GYP. BD. @ GARAGE SIDE WALLS & 5/8" UNDER 'LIVING AREA U.N.O.
 - 3" DIAM. CONCRETE FILLED PIPE BOLLARD 36" HIGH WITH MIN. 12" EMBEDED INTO CONCRETE
 - (NOT REQUIRED AT ELECTRIC WATER HEATERS OR FOR APPLIANCES LOCATED OUT OF THE VEHICLE'S NORMAL TRAVEL PATH.)
 - 5/8" TYPE-X DRYWALL IN GARAGE CEILING
 - P.T. POST W/ VINYL WRAP
 - CONCRETE STPOOF, 36"x36" STANDARD SLOPE 1/4" PER FT. MIN.
 - EGRESS WINDOW
 - PROVIDE ADDITIONAL RISER(S) AT OPTIONAL PLATE HT.
 - MDP TOP
 - PLUMBING DROP FROM ABOVE
 - ADJUST OPENINGS AT OPTION TO FIT THE DOOR SIZE SHOWN
 - WINDOW LEDGE HEIGHT & WIDTH OF OPENING TO EXTEND 6" BEYOND WINDOW(S) ON ALL SIDES U.N.O.
 - SITE-BUILT COLUMN - SEE ELEVATION FOR TYPE
 - CONCRETE SLAB. SLOPE 1/4" PER FT. MIN. SEE PLAN FOR SIZE.
 - LOUVERED DOOR
 - SLOPING LOW WALL 38" ABOVE ADJACENT TREADS
 - 20 MIN. FIRE-RATED DOOR W/ SELF CLOSER

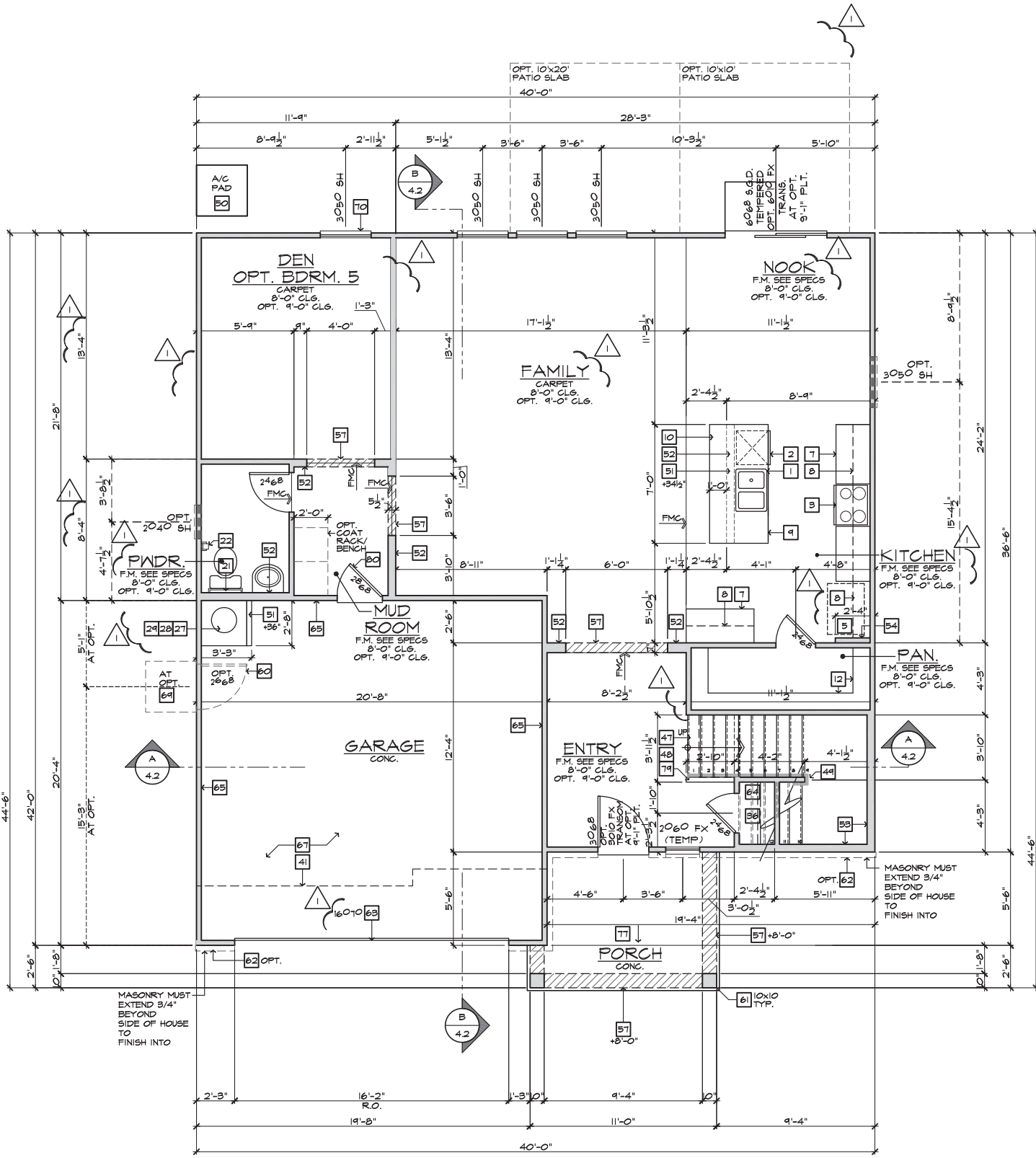

SQUARE FOOTAGE	
PLAN 240.2596	
FIRST FLOOR AREA	1158 SQ. FT.
SECOND FLOOR AREA	1415 SQ. FT.
TOTAL AREA	2573 SQ. FT.
GARAGE AREA	416 SQ. FT.
PORCH AREA(S)	
ELEVATION 'A'	83 SQ. FT.
ELEVATION 'B'	84 SQ. FT.
ELEVATION 'C'	62 SQ. FT.
ELEVATION 'D'	136 SQ. FT.
PATIO AREA(S)	
10'x10' COVERED	100 SQ. FT.
10'x26'-11" COVERED	266 SQ. FT.
DECK AREA(S)	
OPEN 12'x12'	144 SQ. FT.
OPEN 12'x24'	288 SQ. FT.
SCREENED-IN 12'x12'	144 SQ. FT.
SCREENED-IN 12'x24'	288 SQ. FT.
SUNROOM AREA	
12'x12'	144 SQ. FT.

PLATE NOTES	
8'-1" PLATE NOTES	
WINDOW HEADER HEIGHT:	8'-8" U.N.O.
2ND FLOOR WINDOW HDR. HEIGHT:	7'-0" U.N.O.
ENTRY DOOR HEIGHT:	6'-8" U.N.O.
SLIDING GLASS DOOR HEIGHT:	6'-8" (TEMP.)
INTERIOR SOFFIT HEIGHT:	7'-4" U.N.O.
INTERIOR DOOR HEIGHT:	6'-8" U.N.O.
9'-1" PLATE NOTES	
WINDOW HEADER HEIGHT 1st OR 2nd:	7'-8" U.N.O.
4010 WINDOW OVER TUB HDR. HGT.:	8'-4" U.N.O.
SLIDING GLASS DOOR HEIGHT:	6'-8" U.N.O.
INTERIOR SOFFIT HEIGHT:	8'-0" U.N.O.
TRAY CEILING:	7 1/4" DROP U.N.O.
INTERIOR DOOR HEIGHT:	6'-8" U.N.O.
STAIR DATA NOTES	
FIRST FLOOR WITH 8'-6" PLATE HEIGHT:	
14" DEEP T.J.I. FLOOR JOISTS WITH 3/4" T&G DECKING.	
14 TREADS AT 10" EACH	
15 RISERS AT 7-1/16" EACH	
FIRST FLOOR WITH 9'-6" PLATE HEIGHT:	
14" DEEP T.J.I. FLOOR JOISTS WITH 3/4" T&G DECKING.	
15 TREADS AT 10" EACH	
16 RISERS AT 7-3/4" EACH	
GENERAL PLAN NOTES	
ALL CEILING HEIGHTS PER SECTION AND ELEVATION PLATE HEIGHTS, U.N.O.	
ALL INTERIOR DOORS TO BE HOLLOW CORE 1 3/8" THICK, U.N.O. (REFER TO PLAN FOR SIZE).	
ALL GARAGE SERVICE DOORS TO BE HOLLOW CORE EXTERIOR GRADE (REFER TO PLAN FOR SIZE).	
ALL HOUSE TO GARAGE DOORS TO BE 20-MINUTE FIRE-RATED (REFER TO PLAN FOR SIZE).	
ALL ENTRY DOORS AND EXTERIOR FRENCH DOORS TO BE SOLID CORE 1 3/4" THICK (REFER TO PLAN FOR SIZE).	
ALL FLOOR MATERIAL CHANGES TO OCCUR AT CENTER OF DOOR JAMBS, U.N.O.	

FIRST FLOOR PLAN 'A'
SCALE 1/4"=1'-0" (22"x34") - 1/8"=1'-0" (11"x17")
BASIC PLAN

These designs and drawings are CONFIDENTIAL and the exclusive property of KB Home Corporation and are not to be disclosed without the express permission of KB Home Corporation. Copyright 2019 © KB Home Corporation. All rights reserved.



**NORTH CAROLINA
40' SERIES**

KB HOME
NORTH CAROLINA DIVISION
4506 S. MIAMI BLVD.
SUITE 180
DURHAM, NC 27703
TEL: (919) 768-7980
FAX: (919) 544-2928

**2018 NORTH
CAROLINA STATE
BUILDING
CODES**

ISSUE DATE: 05/28/15
PROJECT No.: 1350999-56
DIVISION MGR.: DCS
REVISIONS: 03/15/19

1 DIVISION REVISIONS
NC18054NCP - 08/15/18 - CTD
2 2018 CODE UPDATE
NC18054NCP / 03/15/19 / CTD

FOR INTERNAL USE ONLY	
REVISION BY:	
1.	
2.	
3.	
4.	
5.	
6.	

PLAN:
240.2596
SHEET:
1.2

**SPEC. LEVEL 1
RALEIGH-DURHAM
40' SERIES**

- # FLOOR PLAN NOTES**
- NOTE: NOT ALL KEY NOTES APPLY.
- SINK - GARBAGE DISPOSAL OPTIONAL - VERIFY DIMENSIONS WITH MANUFACTURERS SPECS
 - DISHWASHER - PROVIDE AIR GAP - VERIFY SPACINGS & DIMENSIONS PER MANUFACTURERS' SPECS
 - SLIDE-IN RANGE/OVEN COMBINATION W/ BUILT-IN NON-VENTED HOOD W/LIGHT & FAN - VERIFY WITH MANUFACTURERS' SPECS
 - 30" COOKTOP W/ BUILT-IN VENTED HOOD W/ LIGHT & FAN - VERIFY WITH MANUFRS' SPECS
 - 34" CLEAR REFRIGERATOR SPACE W/ OPTIONAL CABINETS ABOVE - OPT. PLUMBING FOR ICEMAKER (RECESSED IN WALL)
 - COMBINATION DOUBLE OVEN OR OVEN/MICROWAVE OVEN OR OVEN - VERIFY DIMENSIONS WITH MANUFACTURERS' SPECS
 - BASE CABINETS - REFER TO INTERIOR ELEVATIONS
 - UPPER CABINETS - REFER TO INTERIOR ELEVATIONS
 - ISLAND CABINET - REFER TO INTERIOR ELEVATIONS
 - MIN. 12" BAR TOP/ BREAKFAST BAR
 - DESK AREA - REFER TO INTERIOR ELEVATIONS
 - BUILT-IN PANTRY (15" DEEP OR U.N.O.)
 - SINK CABINET(S) - REFER TO INTERIOR ELEVATIONS
 - SINK CABINET W/ EXTENDED VANITY & KNEE SPACE BELOW - REFER TO INTERIOR ELEVATIONS
 - OPT. SINK - REFER TO INTERIOR ELEVATIONS.
 - KNEE SPACE - REFER TO INTERIOR ELEVATIONS
 - PRE-FAB. TUB/SHOWER COMBO W/ FIBERGLASS WAINSCOT TO T2 - VERIFY DIMENSIONS W/ MANUF'S SPECS
 - OVAL TUB - VERIFY DIMENSIONS WITH MANUF'S SPECS.
 - PRE-FAB. SHOWER PAN W/ 30" MIN. CLR. INSIDE & WAINSCOT TO T2 - VERIFY DIMENSIONS W/ MANUF'S SPECS
 - SHATTERPROOF (TEMPERED) GLASS SHOWER ENCLOSURE.
 - TOWEL BAR - PROVIDE 2x SOLID BLK'S IN WALL
 - TOILET PAPER HOLDER - PROVIDE 2x SOLID BLK'S IN WALL
 - RECESSED, MIRRORED MEDICINE CABINET
 - WASHER & DRYER - PROVIDE WATER & WASTE FOR WASHER - RECESS WASHER CONTROL VALVES IN WALL - VENT DRYER TO OUTSIDE AIR - PROVIDE "SMITTY PAN" W/ DRAIN BELOW WASHER AT 2ND FLOOR LAUNDRY LOCATION ACCOMMODATE APPLIANCES TO BE LOCATED WASHER AT LEFT AND DRYER AT RIGHT.
 - 12" SHELF PER SPECS
 - OPT. LAUNDRY SINK - REFER TO INTERIOR ELEV'S
 - WATER HEATER LOCATION - FOR GAS - LOCATE ON 10' HIGH PLATFORM - FOR INTERIOR LOCATION - PROVIDE PAN & DRAIN. (REFER TO DETAILS)
 - WATER HEATER 'B' VENT TO OUTSIDE AIR
 - MAIN LINE SHUT-OFF VALVE AND TEMP. & PRESSURE RELIEF VALVE
 - FA.U. LOCATION (REFER TO DETAIL SHEETS)
 - FA.U. 'B' VENT TO OUTSIDE AIR
 - LISTED FACTORY-BUILT GAS FIRED DEC. APPLIANCE (REF. 80/AD4) - INSTALL PER MFR. SPECS
 - HEARTH TO BE INSTALLED PER FACTORY-BUILT FIREPLACE LISTING
 - GAS APPLIANCE 'B' VENT FROM BELOW
 - LINEN PER SPECS (15" DEEP OR U.N.O.)
 - COAT CLOSET W/ SHELF & POLE (REFER TO DETAIL SHEETS)
 - WARDROBE W/ SHELF & POLE (REFER TO DETAIL SHEETS)
 - 22"x30" MIN. ATTIC ACCESS (REFER TO DETAIL SHEETS) W/ 25"x54" PULL DOWN LADDER R.O. ATTIC ACCESS TO BE PROTECTED
 - LINE OF WALL BELOW
 - DUCT CHASE
 - LINE OF FLOOR ABOVE
 - LINE OF FLOOR BELOW
 - LINE OF OPTIONAL TRAY CEILING (REFER TO DETAIL SHEETS)
 - LINE OF HIP AT OPTIONAL VOLUME CEILING
 - LINE OF RIDGE AT OPTIONAL VOLUME CEILING
 - CEILING BREAK
 - STAIR TREADS & RISERS - MIN. 10" TREAD & MAX. 7 3/4" RISER - (REFER TO DETAIL SHEETS)
 - MIN. 36" HIGH GUARDRAIL (REFER TO DETAIL SHEETS)
 - 34" TO 38" HIGH HANDRAIL (REFER TO DETAIL SHEETS)
 - A/G PAD LOCATION
 - LOW WALL - REFER TO PLAN FOR HEIGHT
 - 2x6 STUD WALL
 - 2x6 BALLOON FRAMED WALL PER STRUCTURAL
 - DBL. 2x4 WALL PER PLAN
 - INTERIOR SHELF-SEE PLAN FOR HT. (REFER TO DETAIL SHEETS)
 - MEDIA NICHE
 - FLAT SOFFIT - REFER TO PLATE NOTES / ELEV. FOR H6T.
 - ARCHED SOFFIT - REFER TO PLATE NOTES / ELEV. FOR H6T.
 - WINDOW SEAT
 - OPT. DOOR/ WINDOW
 - PRE-MANUFACTURED DECORATIVE COLUMN (SIZE, SEE ELEV.) PYPON OR EQ. SURROUNDING STRUCTURAL POST.
 - BRICK / STONE VENEER - REFER TO ELEVATIONS VENEER TO COMPLY WITH THE N.G.-R.
 - SECTIONAL GARAGE DOOR PER SPECS
 - MIN. 1/2" GYP. BD. ON CEILING & WALLS @ USEABLE SPACE UNDER STAIR.
 - GARAGE SHALL BE SEPARATED FROM THE RESIDENCE AND ITS ATTIC AREA BY NOT LESS THAN 1/2" GYP. BD. @ GARAGE SIDE WALLS & 5/8" UNDER 'LIVING AREA U.N.O.
 - 3" DIAM. CONCRETE FILLED PIPE BOLLARD 36" HIGH WITH MIN. 12" EMBEDMENT INTO CONCRETE (NOT REQUIRED AT ELECTRIC WATER HEATERS OR FOR APPLIANCES LOCATED OUT OF THE VEHICLE'S NORMAL TRAVEL PATH).
 - 5/8" TYPE-X DRYWALL IN GARAGE CEILING
 - P.T. POST W/ VINYL WRAP
 - CONCRETE STUOP. 36"x36" STANDARD SLOPE 1/4" PER FT. MIN.
 - EGRESS WINDOW
 - PROVIDE ADDITIONAL RISER(S) AT OPTIONAL PLATE HT.
 - MDP TOP
 - PLUMBING DROP FROM ABOVE
 - ADJUST OPENING AT OPTION TO FIT THE DOOR SIZE SHOWN
 - WINDOW LEADGE HEIGHT & WIDTH OF OPENING TO EXTEND 6" BEYOND WINDOW(S) ON ALL SIDES U.N.O.
 - SITE-BUILT COLUMN - SEE ELEVATION FOR TYPE
 - CONCRETE SLAB. SLOPE 1/4" PER FT. MIN. SEE PLAN FOR SIZE.
 - LOUVERED DOOR
 - SLOPING LOW WALL 36" ABOVE ADJACENT TREADS
 - 20 MIN. FIRE-RATED DOOR W/ SELF CLOSER

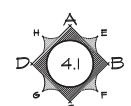
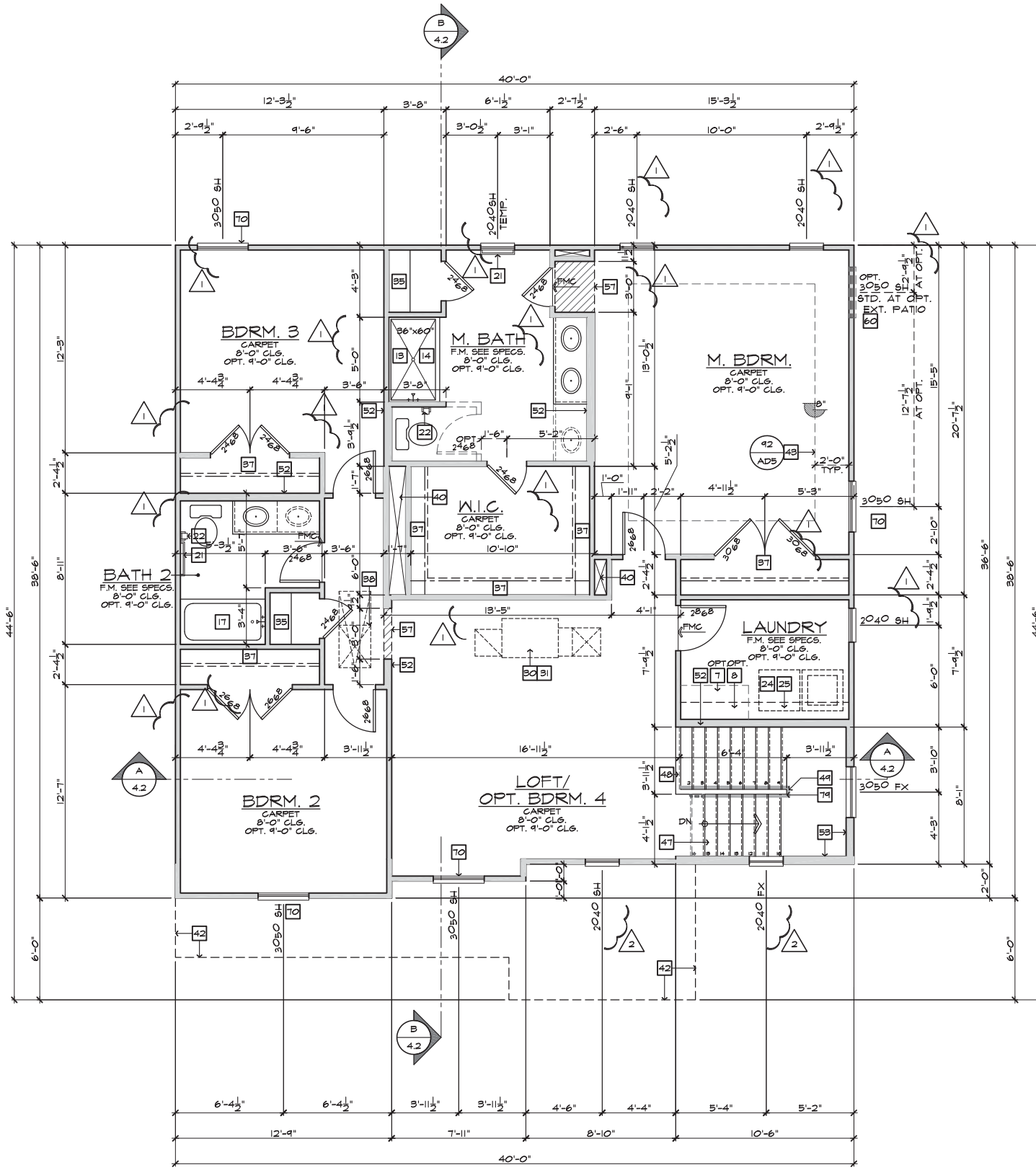

INTERIOR KEY

PLATE NOTES

8'-1" PLATE NOTES

- WINDOW HEADER HEIGHT: 6'-8" U.N.O.
- 2ND FLOOR WINDOW HDR. HEIGHT: 7'-0" U.N.O.
- ENTRY DOOR HEIGHT: 6'-8" U.N.O.
- SLIDING GLASS DOOR HEIGHT: 6'-8" (TEMP.)
- INTERIOR SOFFIT HEIGHT: 7'-4" U.N.O.
- INTERIOR DOOR HEIGHT: 6'-8" U.N.O.

9'-1" PLATE NOTES

- WINDOW HEADER HEIGHT 1st OR 2nd: 7'-8" U.N.O.
- 4010 WINDOW OVER TUB HDR. HGT.: 8'-4" U.N.O.
- ENTRY DOOR HEIGHT: 6'-8" U.N.O.
- SLIDING GLASS DOOR HEIGHT: 6'-8" (TEMP.)
- INTERIOR SOFFIT HEIGHT: 8'-0" U.N.O.
- TRAY CEILING: 7/8" DROP U.N.O.
- INTERIOR DOOR HEIGHT: 6'-8" U.N.O.

STAIR DATA NOTES

FIRST FLOOR WITH 8'-0" PLATE HEIGHT:
14" DEEP T.J.I. FLOOR JOISTS WITH 3/4" T&G DECKING.
14 TREADS AT 10" EACH
15 RISERS AT 7-7/16" EACH

FIRST FLOOR WITH 9'-0" PLATE HEIGHT:
14" DEEP T.J.I. FLOOR JOISTS WITH 3/4" T&G DECKING.
15 TREADS AT 10" EACH
16 RISERS AT 7-3/4" EACH

GENERAL PLAN NOTES

ALL CEILING HEIGHTS PER SECTION AND ELEVATION PLATE HEIGHTS, U.N.O.
ALL INTERIOR DOORS TO BE HOLLOW CORE 1 3/8" THICK, U.N.O. (REFER TO PLAN FOR SIZE).
ALL GARAGE SERVICE DOORS TO BE HOLLOW CORE EXTERIOR GRADE (REFER TO PLAN FOR SIZE).
ALL HOUSE TO GARAGE DOORS TO BE 20-MINUTE FIRE-RATED (REFER TO PLAN FOR SIZE).
ALL ENTRY DOORS AND EXTERIOR FRENCH DOORS TO BE SOLID CORE 1 3/4" THICK (REFER TO PLAN FOR SIZE).
ALL FLOOR MATERIAL CHANGES TO OCCUR AT CENTER OF DOOR JAMBS, U.N.O.

SECOND FLOOR PLAN 'A'

SCALE 1/4"=1'-0" (22"x34") - 1/8"=1'-0" (11"x17")

BASIC PLAN

These designs and drawings are CONFIDENTIAL and the exclusive property of KB Home Corporation and are not to be disclosed without the express permission of KB Home Corporation. Copyright 2019 © KB Home Corporation. All rights reserved.



**NORTH CAROLINA
40' SERIES**

KB HOME
NORTH CAROLINA DIVISION

4506 S. MIAMI BLVD.
SUITE 180
DURHAM, NC 27703
TEL: (919) 768-7980
FAX: (919) 544-2928

**2018 NORTH
CAROLINA STATE
BUILDING
CODES**

ISSUE DATE: 05/28/15
PROJECT No.: 1350999:56
DIVISION MGR.: DCS
REVISIONS: 03/15/19

1 DIVISION REVISIONS
NC18054NCP - 08/15/18 - CTD

2 2018 CODE UPDATE
NC19051NCP/ 03/15/19 - CTD

FOR INTERNAL USE ONLY	
REVIEWED BY:	
1.	
2.	
3.	
4.	
5.	
6.	

PLAN:
240.2596

SHEET:
1.4

**SPEC. LEVEL 1
RALEIGH-DURHAM
40' SERIES**

FLOOR PLAN NOTES

- NOTE: NOT ALL KEY NOTES APPLY.**
- SINK - GARBAGE DISPOSAL OPTIONAL - VERIFY DIMENSIONS WITH MANUFACTURERS SPECS
 - DISHWASHER - PROVIDE AIR GAP - VERIFY SPACINGS & DIMENSIONS PER MANUFACTURERS' SPECS
 - SLIDE-IN RANGE/OVEN COMBINATION W/ BUILT-IN NON-VENTED HOOD W/LIGHT & FAN. - VERIFY WITH MANUFACTURERS' SPECS
 - 30" COOKTOP W/ BUILT-IN VENTED HOOD W/ LIGHT & FAN VERIFY WITH MANUF'S SPECS
 - 34" CLEAR REFRIGERATOR SPACE W/ OPTIONAL CABINETS ABOVE - OPT. PLUMBING FOR ICEMAKER (RECESSED IN WALL)
 - COMBINATION DOUBLE OVEN OR OVEN/MICROWAVE OVEN OR OVEN VERIFY DIMENSIONS WITH MANUFACTURERS' SPECS
 - BASE CABINETS - REFER TO INTERIOR ELEVATIONS
 - UPPER CABINETS - REFER TO INTERIOR ELEVATIONS
 - ISLAND CABINET - REFER TO INTERIOR ELEVATIONS
 - MIN. 12" BAR TOP/ BREAKFAST BAR
 - DESK AREA - REFER TO INTERIOR ELEVATIONS
 - BUILT-IN PANTRY (15" DEEP OR U.N.O.)
 - SINK CABINET(S) - REFER TO INTERIOR ELEVATIONS
 - SINK CABINET W/ EXTENDED VANITY & KNEE SPACE BELOW - REFER TO INTERIOR ELEVATIONS
 - OPT. SINK - REFER TO INTERIOR ELEVATIONS.
 - KNEE SPACE - REFER TO INTERIOR ELEVATIONS
 - PRE-FAB. TUB/SHOWER COMBO W/ FIBERGLASS WAINSCOT TO T2 - VERIFY DIMENSIONS W/ MANUF'S SPECS
 - OVAL TUB - VERIFY DIMENSIONS WITH MANUF'S SPECS.
 - PRE-FAB. SHOWER PAN W/ 30" MIN. CLR. INSIDE & WAINSCOT TO T2 - VERIFY DIMENSIONS W/ MANUF'S SPECS
 - SHATTERPROOF (TEMPERED) GLASS SHOWER ENCLOSURE.
 - TOWEL BAR - PROVIDE 2x SOLID BLK'S IN WALL
 - TOILET PAPER HOLDER - PROVIDE 2x SOLID BLK'S IN WALL
 - RECESSED, MIRRORRED MEDICINE CABINET
 - WASHER & DRYER. - PROVIDE WATER & WASTE FOR WASHER - RECESS WASHER CONTROL VALVES IN WALL - VENT DRYER TO OUTSIDE AIR. - PROVIDE "SMITTY PAN" W/ DRAIN BELOW WASHER AT 2ND FLOOR LAUNDRY LOCATION ACCOMMODATE APPLIANCES TO BE LOCATED WASHER AT LEFT AND DRYER AT RIGHT.
 - 12" SHELF PER SPECS
 - OPT. LAUNDRY SINK - REFER TO INTERIOR ELEV'S
 - WATER HEATER LOCATION: - FOR GAS - LOCATE ON 10" HIGH PLATFORM - FOR INTERIOR LOCATION - PROVIDE PAN & DRAIN. (REFER TO DETAILS)
 - WATER HEATER 'B' VENT TO OUTSIDE AIR
 - MAIN LINE SHUT-OFF VALVE AND TEMP. & PRESSURE RELIEF VALVE
 - F.A.U. LOCATION (REFER TO DETAIL SHEETS)
 - F.A.U. 'B' VENT TO OUTSIDE AIR
 - LISTED FACTORY-BUILT GAS FIRED DEC. APPLIANCE (REF. 80/AD4) - INSTALL PER MFR. SPECS
 - HEARTH TO BE INSTALLED PER FACTORY-BUILT FIREPLACE LISTING
 - GAS APPLIANCE 'B' VENT FROM BELOW
 - LINEN PER SPECS (15" DEEP OR U.N.O.)
 - COAT CLOSET W/ SHELF & POLE (REFER TO DETAIL SHEETS)
 - WARDROBE W/ SHELF & POLE (REFER TO DETAIL SHEETS)
 - 22"x30" MIN. ATTIC ACCESS (REFER TO DETAIL SHEETS) W/ 25"x54" FULL DOWN LADDER R.O. ATTIC ACCESS TO BE PROTECTED
 - LINE OF WALL BELOW
 - DUCT CHASE
 - LINE OF FLOOR ABOVE
 - LINE OF FLOOR BELOW
 - LINE OF OPTIONAL TRAY CEILING (REFER TO DETAIL SHEETS)
 - LINE OF HIP AT OPTIONAL VOLUME CEILING
 - LINE OF RIDGE AT OPTIONAL VOLUME CEILING
 - CEILING BREAK
 - STAIR TREADS & RISERS. - MIN. 10" TREAD & MAX. 7 3/4" RISER - (REFER TO DETAIL SHEETS)
 - MIN. 36" HIGH GUARDRAIL (REFER TO DETAIL SHEETS)
 - 34" TO 38" HIGH HANDRAIL (REFER TO DETAIL SHEETS)
 - A/G PAD LOCATION
 - LOW WALL - REFER TO PLAN FOR HEIGHT
 - 2x6 STUD WALL
 - 2x6 BALLOON FRAMED WALL PER STRUCTURAL
 - DBL. 2x4 WALL PER PLAN
 - INTERIOR SHELF-SEE PLAN FOR HT. (REFER TO DETAIL SHEETS)
 - MEDIA NICHE
 - FLAT SOFFIT - REFER TO PLATE NOTES / ELEV. FOR H6T.
 - ARCHED SOFFIT - REFER TO PLATE NOTES / ELEV. FOR H6T.
 - WINDOW SEAT
 - OPT. DOOR/ WINDOW
 - PRE-MANUFACTURED DECORATIVE COLUMN (SIZE, SEE ELEV.) PYPON OR EQ. SURROUNDING STRUCTURAL POST.
 - BRICK / STONE VENEER - REFER TO ELEVATIONS VENEER TO COMPLY WITH THE N.G.-R.
 - SECTIONAL GARAGE DOOR PER SPECS
 - MIN. 1/2" GYP. BD. ON CEILING & WALLS @ USEABLE SPACE UNDER STAIR.
 - GARAGE SHALL BE SEPARATED FROM THE RESIDENCE AND ITS ATTIC AREA BY NOT LESS THAT 1/2" GYP. BD. @ GARAGE SIDE WALLS & 5/8" UNDER LIVING AREA U.N.O.
 - 3" DIAM. CONCRETE FILLED PIPE BOLLARD 36" HIGH WITH MIN. 12" EMBEDMENT INTO CONCRETE (NOT REQUIRED AT ELECTRIC WATER HEATERS OR FOR APPLIANCES LOCATED OUT OF THE VEHICLE'S NORMAL TRAVEL PATH).
 - 5/8" TYPE-X DRYWALL IN GARAGE CEILING
 - P.T. POST W/ VINYL WRAP
 - CONCRETE STOOD. 36"x36" STANDARD SLOPE 1/4" PER FT. MIN.
 - EGRESS WINDOW
 - PROVIDE ADDITIONAL RISER(S) AT OPTIONAL PLATE HT.
 - MDF TOP
 - PLUMBING DROP FROM ABOVE
 - ADJUST OPENING AT OPTION TO FIT THE DOOR SIZE SHOWN
 - WINDOW LEAD. HEIGHT & WIDTH OF OPENING TO EXTEND 6" BEYOND WINDOW(S) ON ALL SIDES U.N.O.
 - SITE-BUILT COLUMN - SEE ELEVATION FOR TYPE
 - CONCRETE SLAB. SLOPE 1/4" PER FT. MIN. SEE PLAN FOR SIZE.
 - LOUVERED DOOR
 - SLOPING LOW WALL 38" ABOVE ADJACENT TREADS
 - 20 MIN. FIRE-RATED DOOR W/ SELF CLOSER

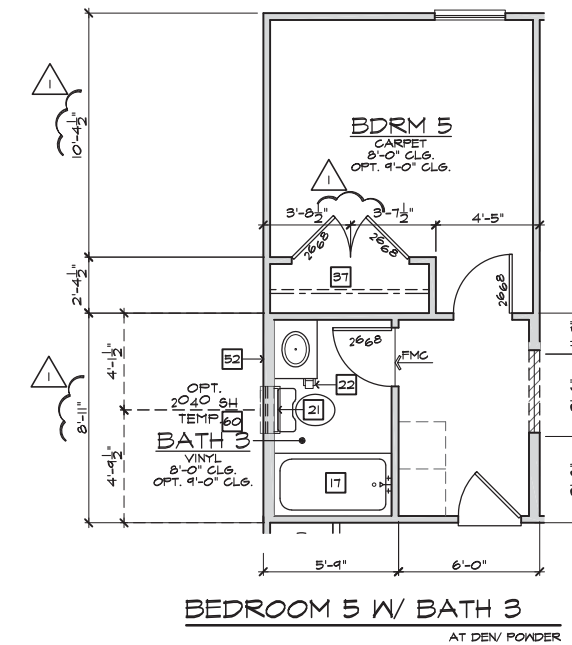

BEDROOM 5 W/ BATH 3
AT DEV POWDER

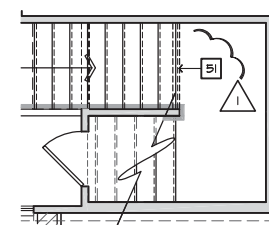

STORAGE
AT COAT CLOSET

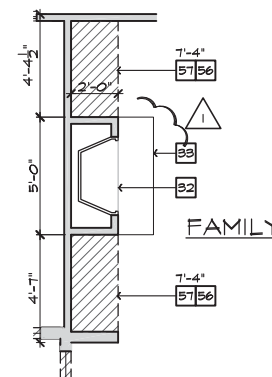

FIREPLACE
AT FAMILY

FIRST FLOOR PLAN OPTIONS

SCALE 1/4"=1'-0" (22"X34") - 1/8"=1'-0" (11"X17")

BASIC PLAN

These designs and drawings are CONFIDENTIAL and the exclusive property of KB Home Corporation and are not to be disclosed without the express permission of KB Home Corporation. Copyright 2019 © KB Home Corporation. All rights reserved.



**NORTH CAROLINA
40' SERIES**

KB HOME
NORTH CAROLINA DIVISION
4506 S. MIAMI BLVD.
SUITE 180
DURHAM, NC 27703
TEL: (919) 768-7980
FAX: (919) 544-2928

**2018 NORTH
CAROLINA STATE
BUILDING
CODES**

ISSUE DATE: 05/28/15
PROJECT No.: 1350999:56
DIVISION MGR.: DCS
REVISIONS: 03/15/19

- 1 DIVISION REVISIONS
NC18054NCP - 08/15/18 - CTD
- 2 2018 CODE UPDATE
NC19051NCP/ 03/15/19 - CTD

FOR INTERNAL USE ONLY	
REVISION BY:	
1.	
2.	
3.	
4.	
5.	
6.	

PLAN:
240.2596
SHEET:
1.5

**SPEC. LEVEL 1
RALEIGH-DURHAM
40' SERIES**

FLOOR PLAN NOTES

- NOTE:** NOT ALL KEY NOTES APPLY.
1. SINK - GARBAGE DISPOSAL OPTIONAL - VERIFY DIMENSIONS WITH MANUFACTURERS SPECS
 2. DISHWASHER - PROVIDE AIR GAP - VERIFY SPACING & DIMENSIONS PER MANUFACTURERS' SPECS
 3. SLIDE-IN RANGE/OVEN COMBINATION W/ BUILT-IN NON-VENTED HOOD W/LIGHT & FAN. - VERIFY WITH MANUFACTURERS' SPECS
 4. 30" COOKTOP W/ BUILT-IN VENTED HOOD W/ LIGHT & FAN VERIFY WITH MANUFERS' SPECS
 5. 34" CLEAR REFRIGERATOR SPACE W/ OPTIONAL CABINETS ABOVE - OPT. PLUMBING FOR ICEMAKER (RECESSED IN WALL)
 6. COMBINATION DOUBLE OVEN OR OVEN/MICROWAVE OVEN OR OVEN VERIFY DIMENSIONS WITH MANUFACTURERS' SPECS
 7. BASE CABINETS - REFER TO INTERIOR ELEVATIONS
 8. UPPER CABINETS - REFER TO INTERIOR ELEVATIONS
 9. ISLAND CABINET - REFER TO INTERIOR ELEVATIONS
 10. MIN. 12" BAR TOP/ BREAKFAST BAR
 11. DESK AREA - REFER TO INTERIOR ELEVATIONS
 12. BUILT-IN PANTRY (15" DEEP OR U.N.O.)
 13. SINK CABINET(S) - REFER TO INTERIOR ELEVATIONS
 14. SINK CABINET W/ EXTENDED VANITY & KNEE SPACE BELOW - REFER TO INTERIOR ELEVATIONS
 15. OPT. SINK - REFER TO INTERIOR ELEVATIONS.
 16. KNEE SPACE - REFER TO INTERIOR ELEVATIONS
 17. PRE-FAB. TUB/SHOWER COMBO W/ FIBERGLASS MAINSCOT TO T2' - VERIFY DIMENSIONS W/ MANUF'S SPECS
 18. OVAL TUB - VERIFY DIMENSIONS WITH MANUF'S SPECS.
 19. PRE-FAB. SHOWER PAN W/ 30" MIN. CLR. INSIDE & MAINSCOT TO T2' - VERIFY DIMENSIONS W/ MANUF'S SPECS
 20. SHATTERPROOF (TEMPERED) GLASS SHOWER ENCLOSURE.
 21. TOWEL BAR - PROVIDE 2x SOLID BLK'S IN WALL
 22. TOILET PAPER HOLDER - PROVIDE 2x SOLID BLK'S IN WALL
 23. RECESSED, MIRRORRED MEDICINE CABINET
 24. WASHER & DRYER. - PROVIDE WATER & WASTE FOR WASHER - RECESS WASHER CONTROL VALVES IN WALL - VENT DRYER TO OUTSIDE AIR. - PROVIDE "SMITTY PAN" W/ DRAIN BELOW WASHER AT 2ND FLOOR LAUNDRY LOCATION ACCOMMODATE APPLIANCES TO BE LOCATED WASHER AT LEFT AND DRYER AT RIGHT.
 25. 12" SHELF PER SPECS
 26. OPT. LAUNDRY SINK - REFER TO INTERIOR ELEV'S
 27. WATER HEATER LOCATION: - FOR GAS - LOCATE ON 10" HIGH PLATFORM - FOR INTERIOR LOCATION - PROVIDE PAN & DRAIN. (REFER TO DETAILS)
 28. WATER HEATER 'B' VENT TO OUTSIDE AIR
 29. MAIN LINE SHUT-OFF VALVE AND TEMP. & PRESSURE RELIEF VALVE
 30. F.A.U. LOCATION (REFER TO DETAIL SHEETS)
 31. F.A.U. 'B' VENT TO OUTSIDE AIR
 32. LISTED FACTORY-BUILT GAS FIRED DEC. APPLIANCE (REF. 80/AD4) - INSTALL PER MFR. SPECS
 33. HEARTH TO BE INSTALLED PER FACTORY-BUILT FIREPLACE LISTING
 34. GAS APPLIANCE 'B' VENT FROM BELOW
 35. LINEN PER SPECS (15" DEEP OR U.N.O.)
 36. COAT CLOSET W/ SHELF & POLE (REFER TO DETAIL SHEETS)
 37. WARDROBE W/ SHELF & POLE (REFER TO DETAIL SHEETS)
 38. 22"x30" MIN. ATTIC ACCESS (REFER TO DETAIL SHEETS) W/ 25"x54" PULL DOWN LADDER R.O. ATTIC ACCESS TO BE PROTECTED
 39. LINE OF WALL BELOW
 40. DUCT CHASE
 41. LINE OF FLOOR ABOVE
 42. LINE OF FLOOR BELOW
 43. LINE OF OPTIONAL TRAY CEILING (REFER TO DETAIL SHEETS)
 44. LINE OF HIP AT OPTIONAL VOLUME CEILING
 45. LINE OF RIDGE AT OPTIONAL VOLUME CEILING
 46. CEILING BREAK
 47. STAIR TREADS & RISERS. - MIN. 10" TREAD & MAX. 7 3/4" RISER - (REFER TO DETAIL SHEETS)
 48. MIN. 36" HIGH GUARDRAIL (REFER TO DETAIL SHEETS)
 49. 34" TO 38" HIGH HANDRAIL (REFER TO DETAIL SHEETS)
 50. A/C PAD LOCATION
 51. LOW WALL - REFER TO PLAN FOR HEIGHT
 52. 2x6 STUD WALL
 53. 2x6 BALLOON FRAMED WALL PER STRUCTURAL
 54. DBL. 2x4 WALL PER PLAN
 55. INTERIOR SHELF-SEE PLAN FOR HT. (REFER TO DETAIL SHEETS)
 56. MEDIA NICHE
 57. FLAT SOFFIT - REFER TO PLATE NOTES / ELEV. FOR H6T.
 58. ARCHED SOFFIT - REFER TO PLATE NOTES / ELEV. FOR H6T.
 59. WINDOW SEAT
 60. OPT. DOOR/ WINDOW
 61. PRE-MANUFACTURED DECORATIVE COLUMN (SIZE, SEE ELEV.) PYPON OR EQ. SURROUNDING STRUCTURAL POST.
 62. BRICK / STONE VENEER - REFER TO ELEVATIONS VENEER TO COMPLY WITH THE N.G.-R
 63. SECTIONAL GARAGE DOOR PER SPECS
 64. MIN. 1/2" GYP. BD. ON CEILING & WALLS @ USEABLE SPACE UNDER STAIR.
 65. GARAGE SHALL BE SEPARATED FROM THE RESIDENCE AND ITS ATTIC AREA BY NOT LESS THAT 1/2" GYP. BD. @ GARAGE SIDE WALLS & 5/8" UNDER LIVING AREA U.N.O.
 66. 3" DIAM. CONCRETE FILLED PIPE BOLLARD 36" HIGH WITH MIN. 12" EMBEDMENT INTO CONCRETE (NOT REQUIRED AT ELECTRIC WATER HEATERS OR FOR APPLIANCES LOCATED OUT OF THE VEHICLE'S NORMAL TRAVEL PATH).
 67. 5/8" TYPE-X DRYWALL IN GARAGE CEILING
 68. P.T. POST W/ VINYL WRAP
 69. CONCRETE STOOD. 36"x36" STANDARD SLOPE 1/4" PER FT. MIN.
 70. EGRESS WINDOW
 71. PROVIDE ADDITIONAL RISER(S) AT OPTIONAL PLATE HT.
 72. MDF TOP
 73. PLUMBING DROP FROM ABOVE
 74. ADJUST OPENING AT OPTION TO FIT THE DOOR SIZE SHOWN
 75. WINDOW LEASE. HEIGHT & WIDTH OF OPENING TO EXTEND 6" BEYOND WINDOW(S) ON ALL SIDES U.N.O.
 76. SITE-BUILT COLUMN - SEE ELEVATION FOR TYPE
 77. CONCRETE SLAB. SLOPE 1/4" PER FT. MIN. SEE PLAN FOR SIZE.
 78. LOUVERED DOOR
 79. SLOPING LOW WALL 38" ABOVE ADJACENT TREADS
 80. 20 MIN. FIRE-RATED DOOR W/ SELF CLOSER

NOTE: REFER TO BASIC FLOOR PLAN FOR INFORMATION NOT SHOWN HERE

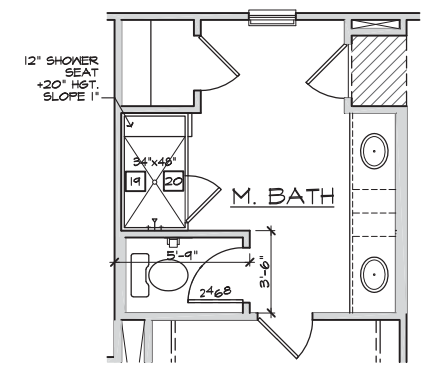

1 DELUXE M. BATH
AT M. BATH

These designs and drawings are CONFIDENTIAL and the exclusive property of KB Home Corporation and are not to be disclosed without the express permission of KB Home Corporation. Copyright 2019 © KB Home Corporation. All rights reserved.

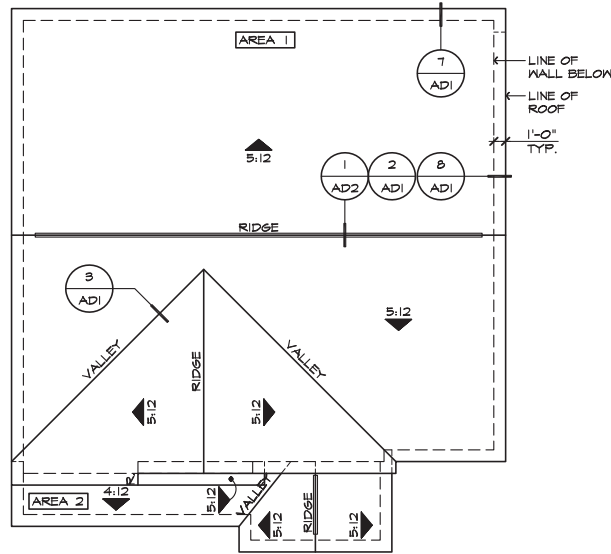

ROOF PLAN 'B'

SCALE 1/8"=1'-0" (22"X34") - 1/16"=1'-0" (11"X17")

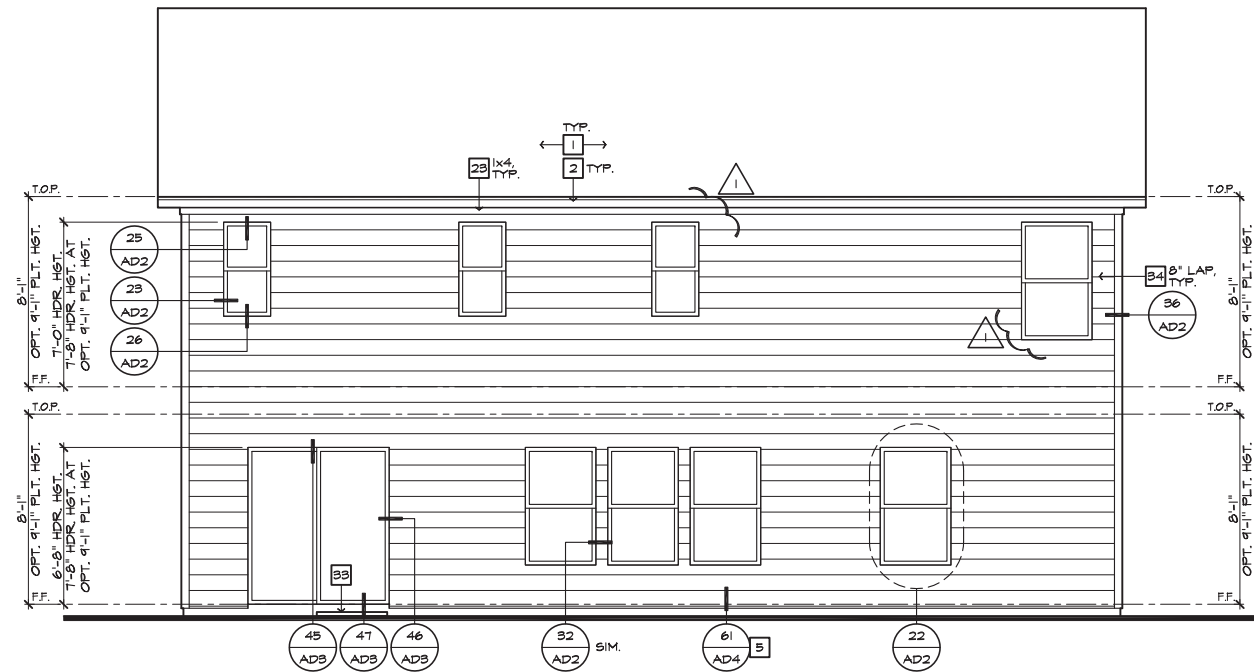

REAR ELEVATION 'B'

SCALE 1/4"=1'-0" (22"X34") - 1/8"=1'-0" (11"X17")

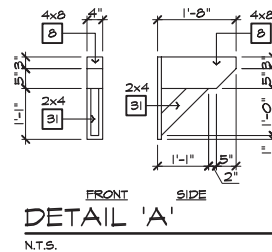

DETAIL 'A'

N.T.S.

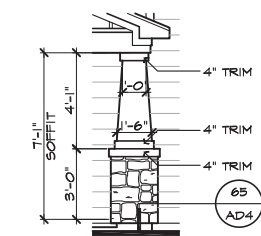

DETAIL 'B'

N.T.S.

ELEVATION NOTES

- NOTE: NOT ALL KEY NOTES APPLY.**
1. ROOF MATERIAL - REFER TO ROOF NOTES
 2. 2X FASCIA/BARGE BOARD WITH FASCIA GAP
 3. G.I. FLASHING
 4. G.I. FLASHING & SADDLE/CRICKET
 5. G.I. DRIP SCREED
 6. 24"x24" CHIMNEY
 7. DECORATIVE VENT
 8. DECORATIVE CORBEL
 9. DECORATIVE SHUTTERS
 10. PEDIMENT, SEE ELEVATION FOR TYPE
 11. RECESSED ELEMENT
 12. DECORATIVE TRIM FYPON OR EQ. SEE ELEVATION FOR TYPE
 13. TRIM - SEE ELEVATION FOR SIZE
 14. SYNTHETIC MATERIAL
 15. PRE-MANUFACTURED DECORATIVE COLUMN (SIZE, SEE ELEV.) FYPON OR EQ. SURROUNDING STRUCTURAL POST.
 16. SITE-BUILT COLUMN - SEE ELEVATION FOR TYPE
 17. SHAKE SIDING
 18. STONE VENEER PER SPECS
 19. BRICK/MASONRY VENEER PER SPECS
 20. BUILT UP BRICK COLUMN
 21. SOLDIER COURSE
 22. ROWLOCK COURSE
 23. FRIEZE BOARD
 24. SIDING W/ 4" CORNER TRIM PER SPECS
 25. P.T. POST W/ WRAP - SEE STRUCTURAL FOR SIZE
 26. PRE-FAB DECORATIVE TRIM
 27. LIGHT WEIGHT PRECAST STONE TRIM
 28. RAILINGS (36" U.N.O.)
 29. VINYL WRAP
 30. DECORATIVE WINDOW/DOOR TRIM - FYPON OR EQ. SEE ELEVATION FOR SIZE.
 31. BRACKET OR KICKER - FYPON OR EQ.
 32. ENTRY DOOR
 33. CONCRETE STOOP/ PORCH - SEE SLAB INTERFACE PLAN.
 34. SECTIONAL GARAGE DOOR PER SPECS
 35. ALUMINUM WRAP
 36. OPTIONAL DOOR/WINDOW - REFER TO PLAN OPTIONS
 37. OPTIONAL STANDING SEAM METAL ROOF
 38. KEYSTONE
 39. SOLDIER CROWN
 40. JACK SOLDIER COURSE
 41. WATER TABLE
 42. ATRIUM DOOR
 43. PILASTER - SEE ELEVATION FOR TYPE

ROOF PLAN NOTES 'B'

5:12 INDICATES ROOF SLOPE AND DIRECTION, U.N.O.

ROOF MATERIAL: COMPOSITION SHINGLE
 12" (INCHES) TYPICAL ROOF OVERHANG AT RAKE, U.N.O.
 12" (INCHES) TYPICAL ROOF OVERHANGS AT EAVE, U.N.O.
 LOCATE EAVE/ RAFTER VENTS EQUALLY BALANCED AROUND HOUSE EXCEPT ABOVE SHEARWALL PANELS.

ATTIC VENT CALCULATIONS

PROVIDE 1 SQ. IN. OF VENTILATION PER 300 SQ. IN. OF ATTIC SPACE. * PROVIDE THAT AT LEAST 50% & NO MORE THAN 50% OF THE REQ. VENTILATING AREA IS PROVIDED BY VENTILATORS LOCATED IN THE UPPER PORTION OF THE ATTIC. (HIGH VENTING) AT 3'-0" ABOVE EAVE VENT WITH THE BALANCE BEING PROVIDED BY EAVE VENTS. (LOW VENTING) (2018 N.C.-R 806.2)
 * CALCULATION BY 1/150, HIGH/LOW VENTING NOT REQUIRED.
 APPROXIMATE RIDGE VENT LOCATIONS SHOWN.
 ACTUAL LOCATIONS TO BE DETERMINED IN THE FIELD.

[AREA 1]		
VENTILATION REQUIRED:		
ATTIC AREA = 1510 SQ. FT. / 300 =	5.03 SQ. FT.	
X 144 =	724.8 SQ. IN.	
VENTILATION PROVIDED:		
HIGH		
36 LINEAR FEET RIDGE VENT AT 10 SQ. IN. PER FOOT=	684 SQ. IN.	
LOW		
46 LINEAR FEET EAVE VENT AT 5 SQ. IN. PER FOOT=	240 SQ. IN.	
TOTAL=	924 SQ. IN.	

[AREA 2]		
VENTILATION REQUIRED:		
ATTIC AREA = 101 SQ. FT. / 300 =	0.33 SQ. FT.	
X 144 =	48.41 SQ. IN.	
VENTILATION PROVIDED:		
HIGH		
5 LINEAR FEET RIDGE VENT AT 10 SQ. IN. PER FOOT=	90 SQ. IN.	
LOW		
30 LINEAR FEET EAVE VENT AT 5 SQ. IN. PER FOOT=	150 SQ. IN.	
TOTAL=	250 SQ. IN.	



NORTH CAROLINA 40' SERIES

KB HOME
 NORTH CAROLINA DIVISION
 4506 S. MIAMI BLVD.
 SUITE 180
 DURHAM, NC 27703
 TEL: (919) 768-7980
 FAX: (919) 544-2928

2018 NORTH CAROLINA STATE BUILDING CODES

ISSUE DATE: 05/28/15
 PROJECT No.: 1350999:56
 DIVISION MGR.: DCS
 REVISIONS: 03/15/19

1 DIVISION REVISIONS
 NC1824NCP - 06/13/18 - CTD

2 2018 CODE UPDATE
 NC1915NCP / 03/15/19 / CTD

FOR INTERNAL USE ONLY

REVISION BY:	DATE:

PLAN:
240.2596
 SHEET:
3.B2

**SPEC. LEVEL 1
 RALEIGH-DURHAM
 40' SERIES**

These designs and drawings are CONFIDENTIAL and the exclusive property of KB Home Corporation and are not to be disclosed without the express permission of KB Home Corporation. Copyright 2019 © KB Home Corporation. All rights reserved.



**NORTH CAROLINA
40' SERIES**

KB HOME
NORTH CAROLINA DIVISION
4506 S. MIAMI BLVD.
SUITE 180
DURHAM, NC 27703
TEL: (919) 768-7980
FAX: (919) 544-2928

**2018 NORTH
CAROLINA STATE
BUILDING
CODES**

ISSUE DATE: 05/28/15
PROJECT No.: 1350999:56
DIVISION MGR.: DCS
REVISIONS: 03/15/19

- 1 DIVISION REVISIONS
NC1824NCP - 06/13/18 - CTD
- 2 2018 CODE UPDATE
NC19015NCP / 03/15/19 / CTD

FOR INTERNAL USE ONLY	
REVISION BY:	
1.	
2.	
3.	
4.	
5.	
6.	

PLAN:
240.2596
SHEET:
3.B5

**SPEC. LEVEL 1
RALEIGH-DURHAM
40' SERIES**

- # ELEVATION NOTES**
- NOTE:** NOT ALL KEY NOTES APPLY.
1. ROOF MATERIAL - REFER TO ROOF NOTES
 2. 2X FASCIA/BARGE BOARD WITH FASCIA GAP
 3. G.I. FLASHING
 4. G.I. FLASHING & SADDLE/CRICKET
 5. G.I. DRIP SCREED
 6. 24"x24" CHIMNEY
 7. DECORATIVE VENT
 8. DECORATIVE CORBEL
 9. DECORATIVE SHUTTERS
 10. PEDIMENT, SEE ELEVATION FOR TYPE
 11. RECESSED ELEMENT
 12. DECORATIVE TRIM FYPON OR EQ. SEE ELEVATION FOR TYPE
 13. TRIM - SEE ELEVATION FOR SIZE
 14. SYNTHETIC MATERIAL
 15. PRE-MANUFACTURED DECORATIVE COLUMN (SIZE, SEE ELEV.) FYPON OR EQ. SURROUNDING STRUCTURAL POST.
 16. SITE-BUILT COLUMN - SEE ELEVATION FOR TYPE
 17. SHAKE SIDING
 18. STONE VENEER PER SPECS
 19. BRICK/MASONRY VENEER PER SPECS
 20. BUILT UP BRICK COLUMN
 21. SOLDIER COURSE
 22. ROWLOCK COURSE
 23. FRIEZE BOARD
 24. SIDING W/ 4" CORNER TRIM PER SPECS
 25. P.T. POST W/ WRAP - SEE STRUCTURAL FOR SIZE
 26. PRE-FAB DECORATIVE TRIM
 27. LIGHT WEIGHT PRECAST STONE TRIM
 28. RAILINGS (36" U.N.O.)
 29. VINYL WRAP
 30. DECORATIVE WINDOW/DOOR TRIM - FYPON OR EQ. SEE ELEVATION FOR SIZE.
 31. BRACKET OR KICKER - FYPON OR EQ.
 32. ENTRY DOOR
 33. CONCRETE STOOP/ PORCH - SEE SLAB INTERFACE PLAN.
 34. SECTIONAL GARAGE DOOR PER SPECS
 35. ALUMINUM WRAP
 36. OPTIONAL DOOR/WINDOW - REFER TO PLAN OPTIONS
 37. OPTIONAL STANDING SEAM METAL ROOF
 38. KEYSTONE
 39. SOLDIER CROWN
 40. JACK SOLDIER COURSE
 41. WATER TABLE
 42. ATRIUM DOOR
 43. PILLASTER - SEE ELEVATION FOR TYPE

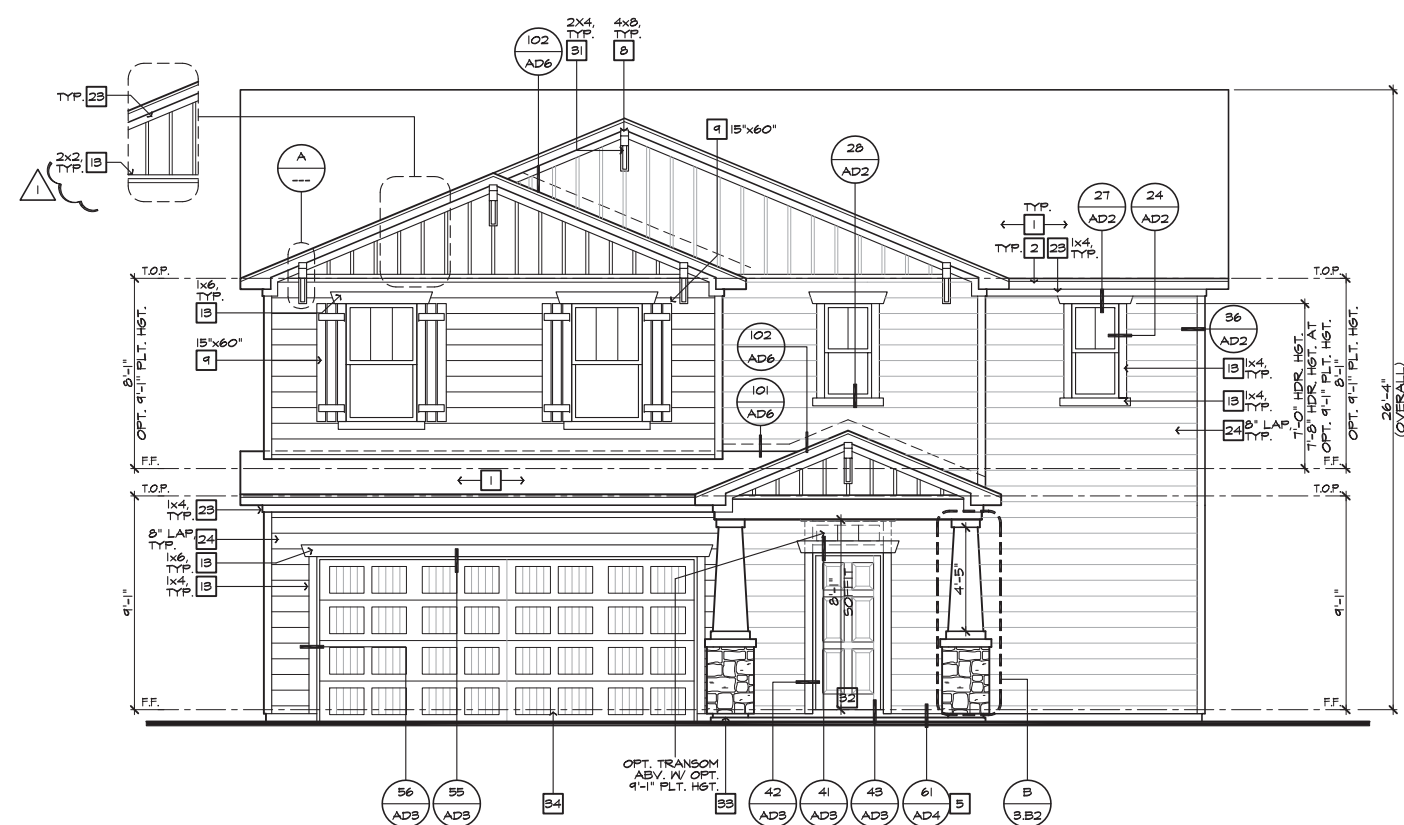

**FRONT ELEVATION 'B'
AT OPTIONAL 9'-1" FLT. HGT.**
SCALE 1/4"=1'-0" (22"X34") - 1/8"=1'-0" (11"X17")

These designs and drawings are CONFIDENTIAL and the exclusive property of KB Home Corporation and are not to be disclosed without the express permission of KB Home Corporation. Copyright 2019 © KB Home Corporation. All rights reserved.



**NORTH CAROLINA
40' SERIES**

KB HOME
NORTH CAROLINA DIVISION

4506 S. MIAMI BLVD.
SUITE 180
DURHAM, NC 27703
TEL: (919) 768-7980
FAX: (919) 544-2928

**2018 NORTH
CAROLINA STATE
BUILDING
CODES**

ISSUE DATE: 05/28/15
PROJECT No.: 1350999:56
DIVISION MGR.: DCS
REVISIONS: 03/15/19

- 1 DIVISION REVISIONS
NC18054NCP - 08/15/18 - CTD
- 2 2018 CODE UPDATE
NC19051NCP/ 03/15/19 / CTD

FOR INTERNAL USE ONLY	
REVIEWED BY:	
1.	
2.	
3.	
4.	
5.	
6.	

PLAN:
240.2596
SHEET:
4.1

**SPEC. LEVEL 1
RALEIGH-DURHAM
40' SERIES**

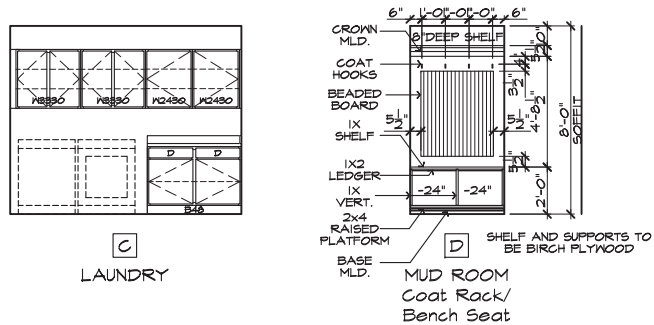

INTERIOR ELEVATIONS

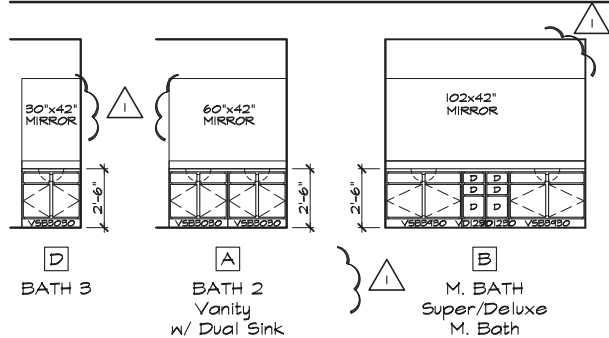

BATH ELEVATIONS

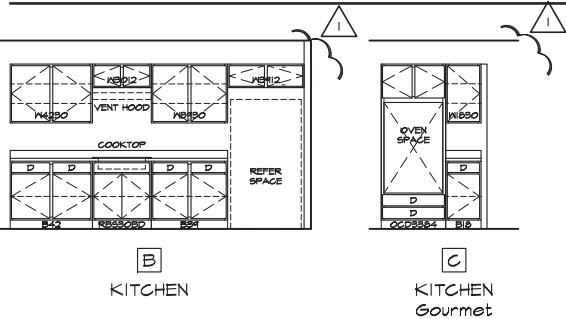

KITCHEN ELEVATIONS

OPTIONAL INTERIOR ELEVATIONS

SCALE: 1/4\"/>

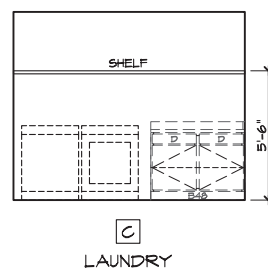

INTERIOR ELEVATIONS

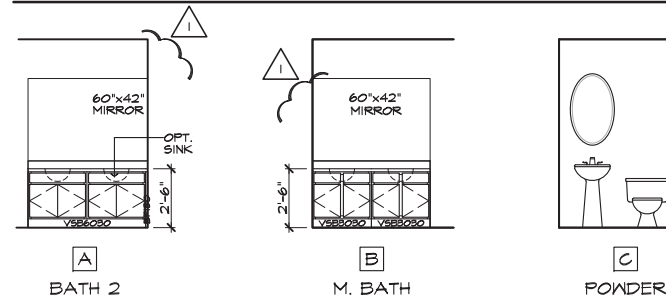

BATH ELEVATIONS

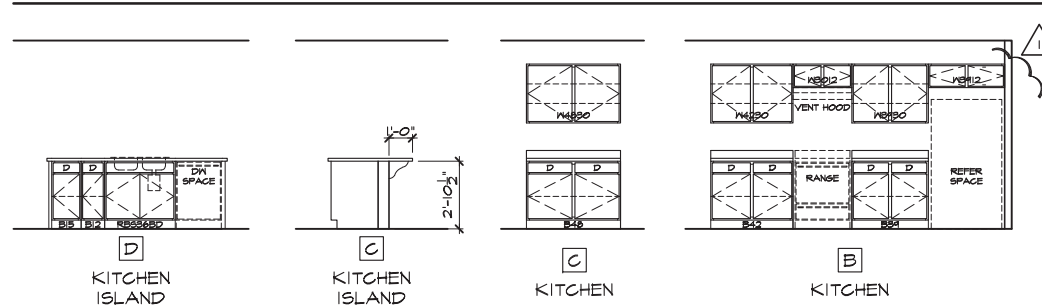

KITCHEN ELEVATIONS

INTERIOR ELEVATIONS

SCALE: 1/4\"/>

These designs and drawings are CONFIDENTIAL and the exclusive property of KB Home Corporation and are not to be disclosed without the express permission of KB Home Corporation. Copyright 2019 © KB Home Corporation, all rights reserved.



#	SECTION NOTES
NOTE: NOT ALL KEY NOTES APPLY.	
1.	ROOF MATERIAL - REFER TO ROOF NOTES
2.	ROOF PITCH - REFER TO ROOF NOTES
3.	PRE-MANUFACTURED WOOD ROOF TRUSS SYSTEM - SEE STRUCTURAL & TRUSS CALCS
4.	ROOF SHEATHING PER STRUCTURAL
5.	2x FASCIA/BARGE BOARD
6.	CONT. SOFFITED EAVE W/ VENTING
7.	G.I. FLASHING - ROOF TO WALL
8.	EXTERIOR FINISH PER ELEVATIONS
9.	FLOOR FRAMING PER STRUCTURAL
10.	FLOOR SHEATHING PER STRUCTURAL
11.	HEADER PER STRUCTURAL
12.	FLUSH BEAM PER STRUCTURAL
13.	DROPPED BEAM PER STRUCTURAL
14.	FLAT/ ARCHED SOFFIT PER PLAN
15.	2x4 STUD WALL
16.	2x6 STUD WALL
17.	2x6 BALLOON FRAMED WALL PER STRUCTURAL
18.	DBL. 2x4 WALL PER PLAN
19.	2x CRIPPLES @ 16" O.C.
20.	2x PRESSURE TREATED SILL PLATE
21.	2x SOLE PLATE
22.	DBL. 2x TOP PLATE @ EXTERIOR & BEARING WALLS
23.	1x OVER 2x TOP PLATE @ INTERIOR & NON-BEARING WALLS
24.	INSULATION MATERIAL PER ENERGY CALCULATIONS
25.	MIN. 36" HIGH GUARD - SEE PLAN FOR HEIGHT
26.	LOW WALL - SEE PLAN FOR HEIGHT
27.	STAIR TREADS AND RISERS PER PLAN. - MIN. 10" TREAD & MAX. 7 5/8" RISER
28.	INTERIOR FINISH - MIN. 1/2" GYP. BD. @ WALLS & SAG RESISTANT OR 5/8" DRYWALL @ CEILING
29.	MIN. 1/2" GYP. BD. ON CEILING & WALLS @ USEABLE SPACE UNDER STAIRS.
30.	GARAGE SHALL BE SEPARATED FROM THE RESIDENCE AND ITS ATTIC AREA BY NOT LESS THAN 1/2" GYP. BD. @ GARAGE SIDE WALLS & 5/8" UNDER LIVING AREA UNO.
31.	MATERIAL TO UNDERSIDE OF ROOF SHEATHING
32.	INTERIOR SHELF - MIN. 1/2" GYP. BD. OVER 3/8" PLY HD.
33.	CONCRETE PATIO/ PORCH SLAB PER STRUCTURAL - SLOPE 1/4" PER FT. MIN.
34.	CONCRETE GARAGE SLAB PER STRUCTURAL - SLOPE 2" MIN.
35.	CONCRETE FOUNDATION PER STRUCTURAL
36.	LINE OF OPTIONAL TRAY CEILING/ STEP CEILING
37.	LINE OF OPTIONAL VOLUME CEILING
38.	PROFILE OF OPTIONAL COVERED PATIO
39.	EXTERIOR SOFFIT MATERIAL - REFER TO ELEVATIONS.
40.	8" BLOCK WALL
41.	5/8" TYPE-X DRYWALL @ GARAGE CEILING
42.	WHEN THERE IS USABLE SPACE ABOVE AND BELOW THE CONCEALED SPACE OF A FLOOR-CEILING ASSEMBLY IN A SINGLE-FAMILY DWELLING, DRAFT STOPS SHALL BE INSTALLED SO THAT THE AREA OF THE CONCEALED SPACE DOES NOT EXCEED 1000 SQUARE FEET. DRAFTSTOPPINGS SHALL DIVIDE THE CONCEALED SPACE INTO APPROXIMATELY EQUAL AREAS.

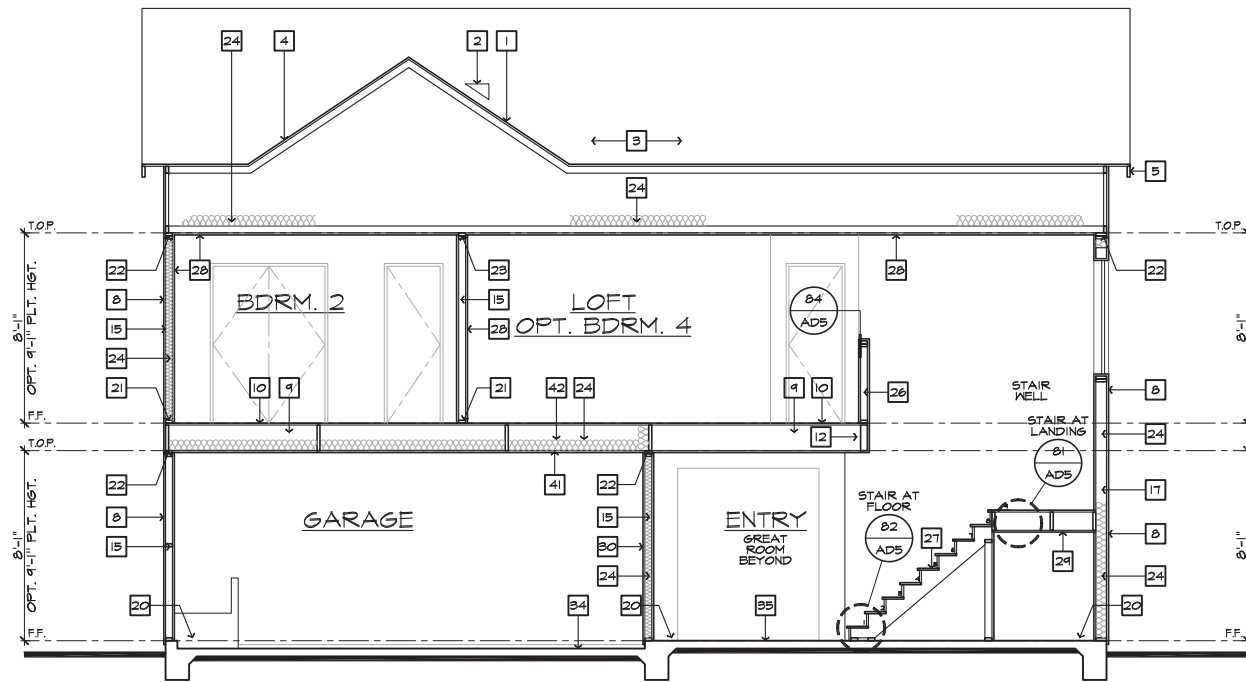

SECTION "A"

SCALE 1/4"=1'-0" (22"X34") - 1/8"=1'-0" (11"X17")

AT SLAB-ON-GRADE

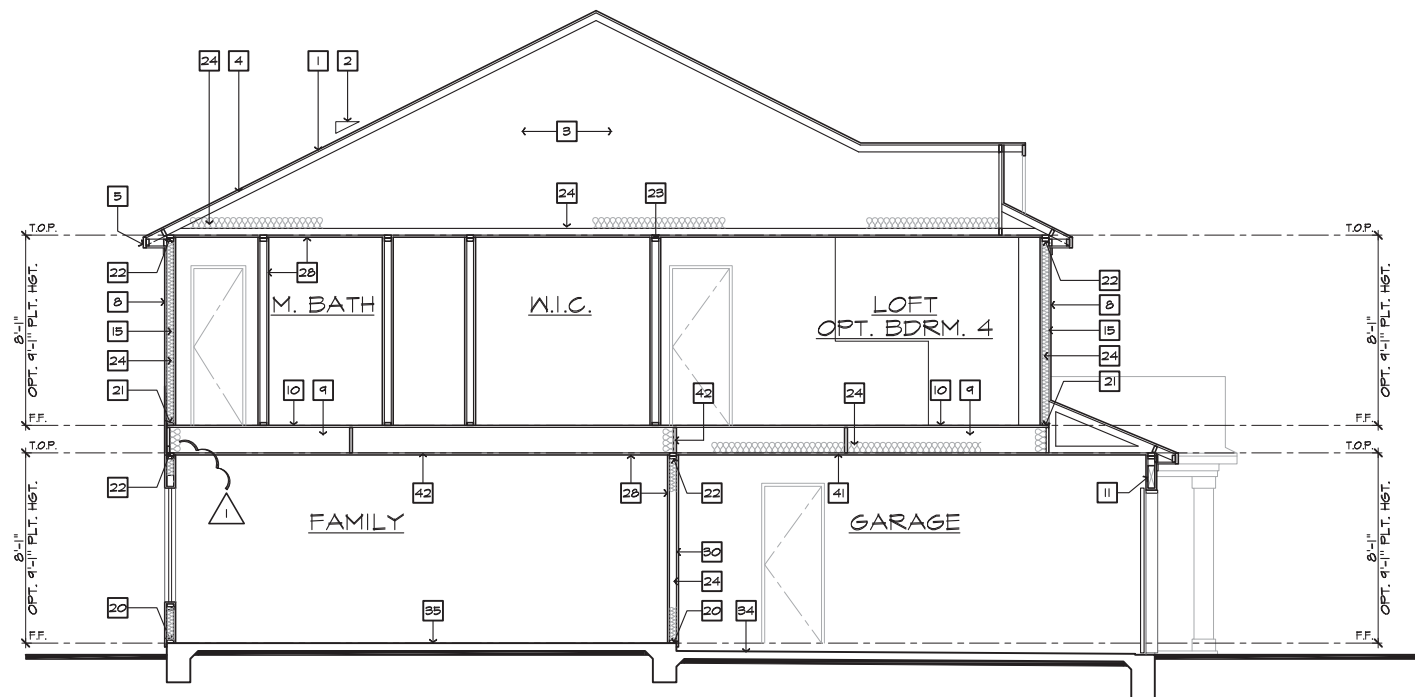

SECTION "B"

SCALE 1/4"=1'-0" (22"X34") - 1/8"=1'-0" (11"X17")

AT SLAB-ON-GRADE

**NORTH CAROLINA
40' SERIES**

KB HOME
NORTH CAROLINA DIVISION

4506 S. MIAMI BLVD.
SUITE 180
DURHAM, NC 27703
TEL: (919) 768-7980
FAX: (919) 544-2928

**2018 NORTH
CAROLINA STATE
BUILDING
CODES**

ISSUE DATE: 05/28/15
PROJECT No.: 1350999:56
DIVISION MGR.: DCS
REVISIONS: 03/15/19

- 1 DIVISION REVISIONS
NC18054NCP / 08/15/18 - CTD
- 2 2018 CODE UPDATE
NC19051NCP/ 03/15/19 / CTD

FOR INTERNAL USE ONLY	
REVISION BY:	
1.	
2.	
3.	
4.	
5.	
6.	

PLAN:
240.2596
SHEET:
4.2

**SPEC. LEVEL 1
RALEIGH-DURHAM
40' SERIES**



NORTH CAROLINA 40' SERIES

KB HOME
NORTH CAROLINA DIVISION
4506 S. MIAMI BLVD.
SUITE 180
DURHAM, NC 27703
TEL: (919) 768-7980
FAX: (919) 544-2928

2018 NORTH CAROLINA STATE BUILDING CODES

ISSUE DATE: 05/28/15
PROJECT No.: 1350999:56
DIVISION MGR.: DCS
REVISIONS: 03/15/19

- 1 DIVISION REVISIONS
NC19052NCP - 08/15/18 - CTD
- 2 2018 CODE UPDATE
NC19051NCP/ 03/15/19 - CTD

FOR INTERNAL USE ONLY	
REVIEWED BY:	
1.	
2.	
3.	
4.	
5.	
6.	

PLAN:
240.2596
SHEET:
5.1

SPEC. LEVEL 1 RALEIGH-DURHAM 40' SERIES

UTILITY LEGEND

	120V DUPLEX CONVENIENCE RECEPTACLE WITH AFCI (TR) AND TAMPER RESISTANT (TR) 12" ABV. FIN. FLR. TYPICAL UNO.
	120V (TR) RECEPTACLE W/ GFI CIRCUIT W/ WATER RESISTANT HOUSING
	120V (TR) RECEPTACLE W/ GFI CIRCUIT
	120V (TR) RECEPTACLE W/ GFI CIRCUIT AND AFCI CIRCUIT
	FUSED DISCONNECT
	120V (AFCI & TR) RECESSED FLOOR RECEPTACLE W/ COVER
	120V (AFCI & TR) DUPLEX CONVENIENCE RECEPTACLE SWITCH CONTROLLED, 1/2 HOT
	220V SINGLE CONVENIENCE RECEPTACLE HEIGHT NOTED AS PER PLAN
	TWO-POLE LIGHT SWITCH AT 42" ABV. FIN. FLR. 8" ABOVE COUNTER UNO.
	THREE-POLE LIGHT SWITCH
	FOUR-POLE LIGHT SWITCH
	W.P. WALL MOUNTED LIGHT FIXTURE W/ WATER RESISTANT HOUSING
	WALL MOUNTED INCANDESCENT LIGHT FIXTURE
	WALL MOUNTED FLUORESCENT LIGHT FIXTURE
	CEILING MOUNTED INCANDESCENT LIGHT FIXTURE
	CEILING MOUNTED FLUORESCENT LIGHT FIXTURE
	HANGING INCANDESCENT LIGHT FIXTURE
	RECESSED INCANDESCENT DIRECTIONAL LIGHT FIXTURE (EYE BALL)
	RECESSED INCANDESCENT LIGHT FIXTURE
	W.P. RECESSED INCANDESCENT LIGHT FIXTURE W/ WATER RESISTANT HOUSING
	RECESSED FLUORESCENT LIGHT FIXTURE
	RECESSED EXHAUST FAN
	RECESSED EXHAUST FAN/ INCANDESCENT LIGHT COMBINATION
	RECESSED EXHAUST FAN/ FLUORESCENT LIGHT COMBINATION
	INCANDESCENT WALL SCONCE
	ILLUMINATED ADDRESS SIGN - VISIBLE FROM STREET
	24"x48" FLUORESCENT LIGHT BOX (CEILING MOUNTED)
	12"x48" FLUORESCENT LIGHT BOX (CEILING MOUNTED)
	OPTIONAL PRE-WIRED CEILING FAN AND SWITCH - LOCATED IN CENTER OF ROOM UNO.
	CEILING MOUNTED JUNCTION BOX
	WALL MOUNTED JUNCTION BOX
	DOOR CHIME
	CATV RECEPTACLE
	PUSH BUTTON
	PHONE OUTLET
	SERVICE BOX
	HOSE BIB
	HOSE BIB W/ S.O.V.
	WATER STUB FOR ICE MAKER
	APPROVED CEILING MOUNTED SMOKE DETECTOR TO BE HARD WIRED WITH BATTERY BACK-UP AND INTERCONNECTED
	APPROVED CARBON MONOXIDE ALARM/ SMOKE DET.
	THERMOSTAT (VERIFY LOCATION W/ HVAC PLAN)
	GAS TAP
	GAS KEY - FIREPLACE GAS VALVES SHALL BE LOCATED OUTSIDE OF REQUIRED HEARTH AREA, BUT NO MORE THAN 48" FROM GAS OUTLET
	SWITCHING FOR ROOMS W/ CLG. FAN OPTIONS
	24" MIN. SEPARATION OF ELECTRICAL BOXES AS SHOWN BELOW
	DWELLING

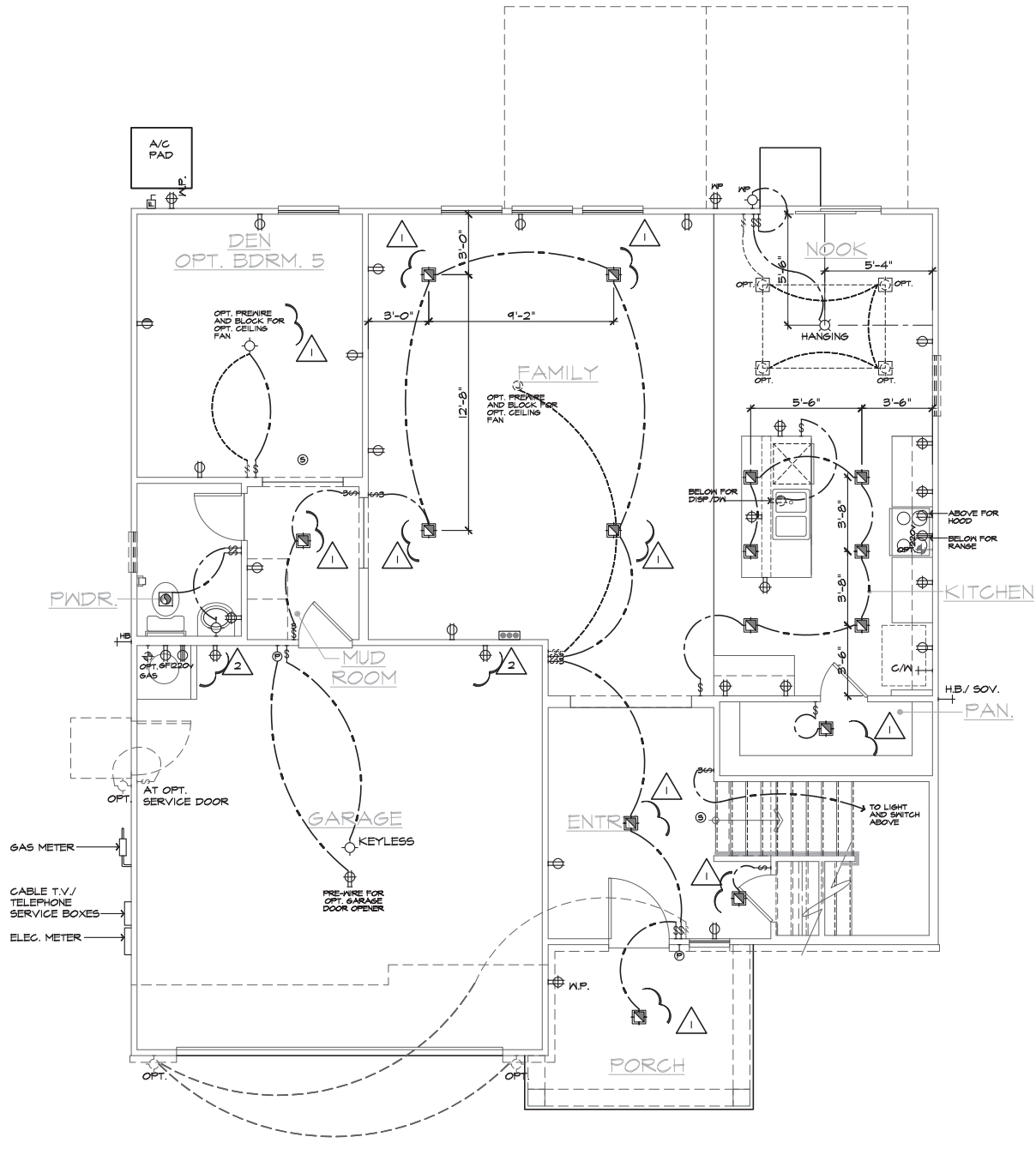

FIRST FLOOR UTILITY PLAN
SCALE 1/4"=1'-0" (22"X34") - 1/8"=1'-0" (11"X17")

BASIC PLAN

- ### NOTES
- MECHANICAL, ELECTRICAL AND PLUMBING SYSTEMS ARE SHOWN FOR INTENT ONLY. THESE SYSTEMS SHALL BE ENGINEERED BY OTHERS. THE CONTRACTOR SHALL BE RESPONSIBLE FOR PROPER INSTALLATION AND PLACEMENT. ALL HEIGHTS SHOWN ARE TO CENTERLINE OF FIXTURE.
 - PROVIDE SWITCH, LIGHT, 120V (AFCI & TR) DUPLEX RECEPTACLE & FUEL GAS STUB OR 220V RECEPTACLE IN ATTIC FOR F.A.U. - PER COMMUNITY SPECIFICATIONS.
 - SMOKE DETECTORS IN ROOMS WITH VOLUME CEILING TO BE LOCATED AT HIGHEST POINT OF CEILING.
 - 20 FOOT #4 REBAR FOR UFER GROUND AND ADDITIONAL GROUND WATER GROUND. REFER TO SLAB INTERFACE PLAN FOR LOCATION.
 - 200 AMP ELECTRICAL PANEL (DEFAULT). ELECTRICAL PLAN CHECK PERMIT REQUIRED IF LOAD EXCEED 400 AMPS.

These designs and drawings are CONFIDENTIAL and the exclusive property of KB Home Corporation and are not to be disclosed without the express permission of KB Home Corporation. Copyright 2019 © KB Home Corporation. All rights reserved.



**NORTH CAROLINA
40' SERIES**

KB HOME
NORTH CAROLINA DIVISION
4506 S. MIAMI BLVD.
SUITE 180
DURHAM, NC 27703
TEL: (919) 768-7980
FAX: (919) 544-2928

**2018 NORTH
CAROLINA STATE
BUILDING
CODES**

ISSUE DATE: 05/28/15
PROJECT No.: 1350999:56
DIVISION MGR.: DCS
REVISIONS: 03/15/19

- 1 DIVISION REVISIONS
NC18052NCP - 08/15/18 - CTD
- 2 2018 CODE UPDATE
NC19051NCP / 03/15/19 / CTD

FOR INTERNAL USE ONLY	
REVISION BY:	
1.	
2.	
3.	
4.	
5.	
6.	

PLAN:
240.2596
SHEET:
5.2

**SPEC. LEVEL 1
RALEIGH-DURHAM
40' SERIES**

UTILITY LEGEND

- ⊕ 120V DUPLEX CONVENIENCE RECEPTACLE
ARC FAULT(AFCI) AND TAMPER RESISTANT(TR)
12" ABV. FIN. FLR. TYPICAL UNO.
- ⊕ W/P 120V (TR) RECEPTACLE W/ GFI CIRCUIT
W/ WATER RESISTANT HOUSING
- ⊕ GFI 120V (TR) RECEPTACLE W/ GFI CIRCUIT
- ⊕ 120V (TR) RECEPTACLE W/ GFI CIRCUIT AND AFCI CIRCUIT
- ⊕ FUSED DISCONNECT
- 120V (AFCI & TR) RECESSED FLOOR
RECEPTACLE W/ COVER
- ⊕ 120V (AFCI & TR) DUPLEX CONVENIENCE RECEPTACLE
SWITCH CONTROLLED, 1/2 HOT
- ⊕ 220 v 220V SINGLE CONVENIENCE RECEPTACLE
HEIGHT NOTED AS PER PLAN
- ⊕ TWO-POLE LIGHT SWITCH AT 42" ABV. FIN. FLR.
8" ABOVE COUNTER UNO.
- ⊕ 3 THREE-POLE LIGHT SWITCH
- ⊕ 4 FOUR-POLE LIGHT SWITCH
- ⊕ W/P WALL MOUNTED LIGHT FIXTURE
W/ WATER RESISTANT HOUSING
- ⊕ WALL MOUNTED INCANDESCENT
LIGHT FIXTURE
- ⊕ WALL MOUNTED FLUORESCENT
LIGHT FIXTURE
- ⊕ CEILING MOUNTED INCANDESCENT
LIGHT FIXTURE
- ⊕ CEILING MOUNTED FLUORESCENT
LIGHT FIXTURE
- ⊕ HANGING INCANDESCENT
LIGHT FIXTURE
- ⊕ RECESSED INCANDESCENT DIRECTIONAL
LIGHT FIXTURE (EYE BALL)
- ⊕ RECESSED INCANDESCENT LIGHT FIXTURE
- ⊕ W/P RECESSED INCANDESCENT LIGHT FIXTURE
W/ WATER RESISTANT HOUSING
- ⊕ RECESSED FLUORESCENT LIGHT FIXTURE
- ⊕ RECESSED EXHAUST FAN
- ⊕ RECESSED EXHAUST FAN/ INCANDESCENT
LIGHT COMBINATION
- ⊕ RECESSED EXHAUST FAN/ FLUORESCENT
LIGHT COMBINATION
- ⊕ INCANDESCENT WALL SCONCE
- ⊕ ILLUMINATED ADDRESS SIGN - VISIBLE
FROM STREET
- ⊕ 24"x48" FLUORESCENT LIGHT
BOX (CEILING MOUNTED)
- ⊕ 12"x48" FLUORESCENT LIGHT
BOX (CEILING MOUNTED)
- ⊕ OPTIONAL PRE-WIRED CEILING FAN
AND SWITCH - LOCATED IN CENTER OF ROOM UNO.
- ⊕ CEILING MOUNTED JUNCTION BOX
- ⊕ WALL MOUNTED JUNCTION BOX
- ⊕ DOOR CHIME
- ⊕ CATV RECEPTACLE
- ⊕ PUSH BUTTON
- ⊕ PHONE OUTLET
- ⊕ SERVICE BOX
- ⊕ HOSE BIB
- ⊕ HOSE BIB W/ S.O.V.
- ⊕ WATER STUB FOR ICE MAKER
- ⊕ APPROVED CEILING MOUNTED
SMOKE DETECTOR TO BE HARD WIRED
WITH BATTERY BACK-UP AND INTERCONNECTED
- ⊕ APPROVED CARBON MONOXIDE ALARM/ SMOKE DET.
- ⊕ THERMOSTAT (VERIFY LOCATION W/ HVAC PLAN)
- ⊕ GAS TAP
- ⊕ GAS KEY - FIREPLACE GAS VALVES SHALL BE
LOCATED OUTSIDE OF REQUIRED HEARTH AREA,
BUT NO MORE THAN 48" FROM GAS OUTLET
- ⊕ SWITCHING FOR
ROOMS W/ CLG. FAN
OPTIONS
- ⊕ 24" MIN. SEPARATION
OF ELECTRICAL BOXES
AS SHOWN BELOW

NOTES

1. MECHANICAL, ELECTRICAL AND PLUMBING SYSTEMS ARE SHOWN FOR INTENT ONLY. THESE SYSTEMS SHALL BE ENGINEERED BY OTHERS. THE CONTRACTOR SHALL BE RESPONSIBLE FOR PROPER INSTALLATION AND PLACEMENT. ALL HEIGHTS SHOWN ARE TO CENTERLINE OF FIXTURE.
2. PROVIDE SWITCH, LIGHT, 120V (AFCI & TR) DUPLEX RECEPTACLE & FUEL GAS STUB OR 220V RECEPTACLE IN ATTIC FOR F.A.U. - PER COMMUNITY SPECIFICATIONS.
3. SMOKE DETECTORS IN ROOMS WITH VOLUME CEILING TO BE LOCATED AT HIGHEST POINT OF CEILING.
4. 20 FOOT #4 REBAR FOR UFER GROUND AND ADDITIONAL GILD WATER GROUND. REFER TO SLAB INTERFACE PLAN FOR LOCATION.
5. 200 AMP ELECTRICAL PANEL (DEFAULT). ELECTRICAL PLAN CHECK PERMIT REQUIRED IF LOAD EXCEED 400 AMPS.

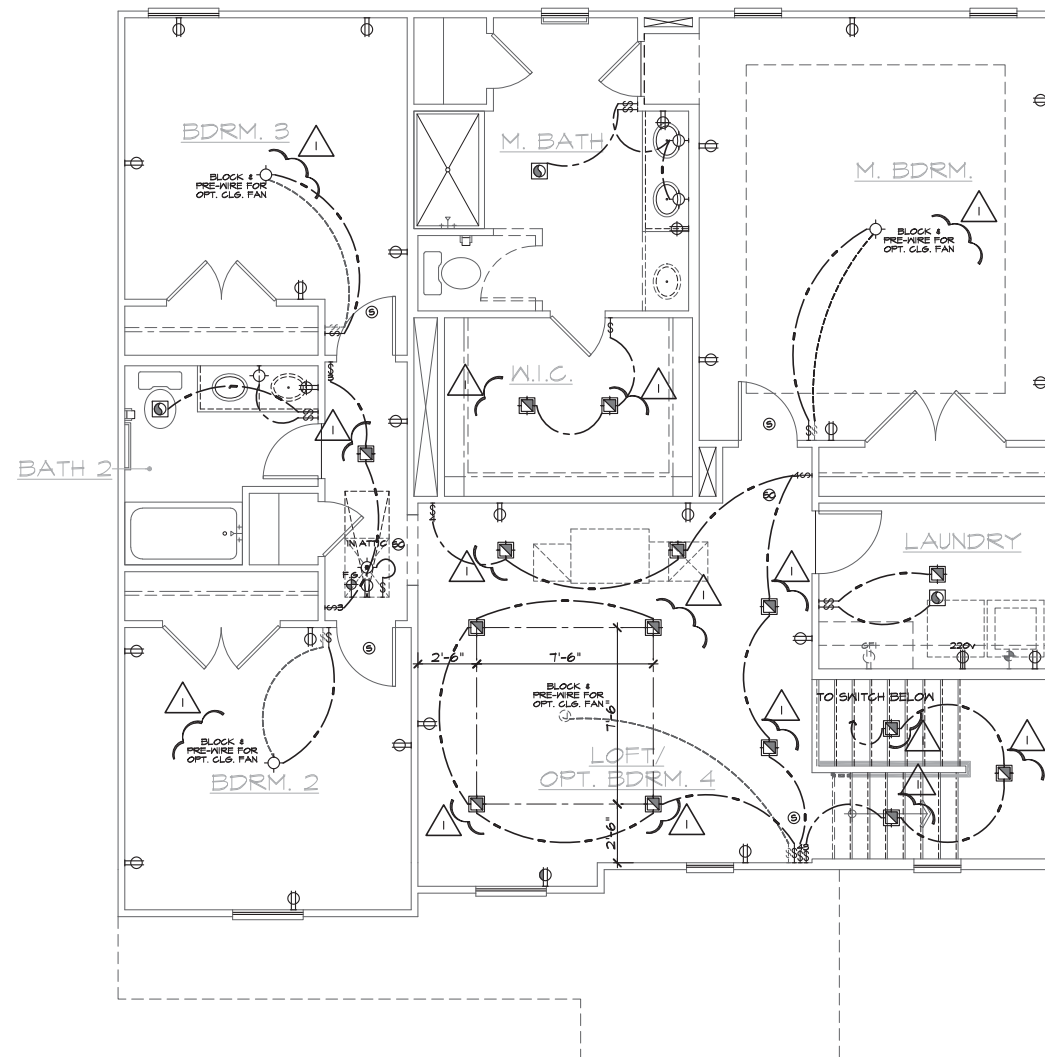

SECOND FLOOR UTILITY PLAN
SCALE 1/4"=1'-0" (22"X34") - 1/8"=1'-0" (11"X17")

BASIC PLAN

These designs and drawings are CONFIDENTIAL and the exclusive property of KB Home Corporation and are not to be disclosed without the express permission of KB Home Corporation. Copyright 2019 © KB Home Corporation. All rights reserved.



**NORTH CAROLINA
40' SERIES**

KB HOME
NORTH CAROLINA DIVISION
4506 S. MIAMI BLVD.
SUITE 180
DURHAM, NC 27703
TEL: (919) 768-7980
FAX: (919) 544-2928

**2018 NORTH
CAROLINA STATE
BUILDING
CODES**

ISSUE DATE: 05/28/15
PROJECT No.: 1350999-56
DIVISION MGR.: DCS
REVISIONS: 03/15/19

- 1 DIVISION REVISIONS
NC18024NCP - 08/15/18 - CTD
- 2 2018 CODE UPDATE
NC19151NCP / 03/15/19 / CTD

FOR INTERNAL USE ONLY	
REVISION BY:	
1	
2	
3	
4	
5	
6	

PLAN:
240.2596
SHEET:
5.3

**SPEC. LEVEL 1
RALEIGH-DURHAM
40' SERIES**

UTILITY LEGEND	
	120V DUPLEX CONVENIENCE RECEPTACLE ARC FAULT (AFCI) AND TAMPER RESISTANT (TR) 12" ABV. FIN. FLR. TYPICAL U.N.O.
	120V (TR) RECEPTACLE W/ GFI CIRCUIT W/ WATER RESISTANT HOUSING
	120V (TR) RECEPTACLE W/ GFI CIRCUIT
	120V (TR) RECEPTACLE W/ GFI CIRCUIT AND AFCI CIRCUIT
	FUSED DISCONNECT
	120V (AFCI & TR) RECESSED FLOOR RECEPTACLE W/ COVER
	120V (AFCI & TR) DUPLEX CONVENIENCE RECEPTACLE SWITCH CONTROLLED, 1/2 HOT
	220V SINGLE CONVENIENCE RECEPTACLE HEIGHT NOTED AS PER PLAN
	TWO-POLE LIGHT SWITCH AT 42" ABV. FIN. FLR. 8" ABOVE COUNTER U.N.O.
	THREE-POLE LIGHT SWITCH
	FOUR-POLE LIGHT SWITCH
	W.P. WALL MOUNTED LIGHT FIXTURE W/ WATER RESISTANT HOUSING
	WALL MOUNTED INCANDESCENT LIGHT FIXTURE
	WALL MOUNTED FLUORESCENT LIGHT FIXTURE
	CEILING MOUNTED INCANDESCENT LIGHT FIXTURE
	CEILING MOUNTED FLUORESCENT LIGHT FIXTURE
	HANGING INCANDESCENT LIGHT FIXTURE
	RECESSED INCANDESCENT DIRECTIONAL LIGHT FIXTURE (EYE BALL)
	RECESSED INCANDESCENT LIGHT FIXTURE
	W.P. RECESSED INCANDESCENT LIGHT FIXTURE W/ WATER RESISTANT HOUSING
	RECESSED FLUORESCENT LIGHT FIXTURE
	RECESSED EXHAUST FAN
	RECESSED EXHAUST FAN/ INCANDESCENT LIGHT COMBINATION
	RECESSED EXHAUST FAN/ FLUORESCENT LIGHT COMBINATION
	INCANDESCENT WALL SCONCE
	ILLUMINATED ADDRESS SIGN - VISIBLE FROM STREET
	24"x48" FLUORESCENT LIGHT BOX (CEILING MOUNTED)
	12"x48" FLUORESCENT LIGHT BOX (CEILING MOUNTED)
	OPTIONAL PRE-WIRED CEILING FAN AND SWITCH - LOCATED IN CENTER OF ROOM U.N.O.
	CEILING MOUNTED JUNCTION BOX
	WALL MOUNTED JUNCTION BOX
	DOOR CHIME
	CATV RECEPTACLE
	PUSH BUTTON
	PHONE OUTLET
	SERVICE BOX
	HOSE BIB
	HOSE BIB W/ S.O.V.
	WATER STUB FOR ICE MAKER
	APPROVED CEILING MOUNTED SMOKE DETECTOR TO BE HARD WIRED WITH BATTERY BACK-UP AND INTERCONNECTED
	APPROVED CARBON MONOXIDE ALARM/ SMOKE DET.
	THERMOSTAT (VERIFY LOCATION W/ HVAC PLAN)
	GAS TAP
	GAS KEY - FIREPLACE GAS VALVES SHALL BE LOCATED OUTSIDE OF REQUIRED HEARTH AREA, BUT NO MORE THAN 48" FROM GAS OUTLET

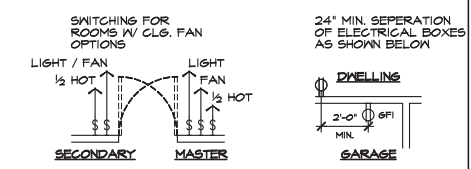

- NOTES**
- MECHANICAL, ELECTRICAL AND PLUMBING SYSTEMS ARE SHOWN FOR INTENT ONLY. THESE SYSTEMS SHALL BE ENGINEERED BY OTHERS. THE CONTRACTOR SHALL BE RESPONSIBLE FOR PROPER INSTALLATION AND PLACEMENT. ALL HEIGHTS SHOWN ARE TO CENTERLINE OF FIXTURE.
 - PROVIDE SWITCH, LIGHT, 120V (AFCI & TR) DUPLEX RECEPTACLE & FUEL GAS STUB OR 220V RECEPTACLE IN ATTIC FOR F.A.U. - PER COMMUNITY SPECIFICATIONS.
 - SMOKE DETECTORS IN ROOMS WITH VOLUME CEILING TO BE LOCATED AT HIGHEST POINT OF CEILING
 - 20 FOOT #4 REBAR FOR UFER GROUND AND ADDITIONAL COLD WATER GROUND. REFER TO SLAB INTERFACE PLAN FOR LOCATION.
 - 200 AMP ELECTRICAL PANEL (DEFAULT). ELECTRICAL PLAN CHECK PERMIT REQUIRED IF LOAD EXCEED 400 AMPS.

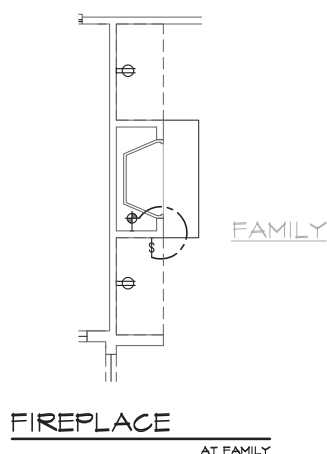
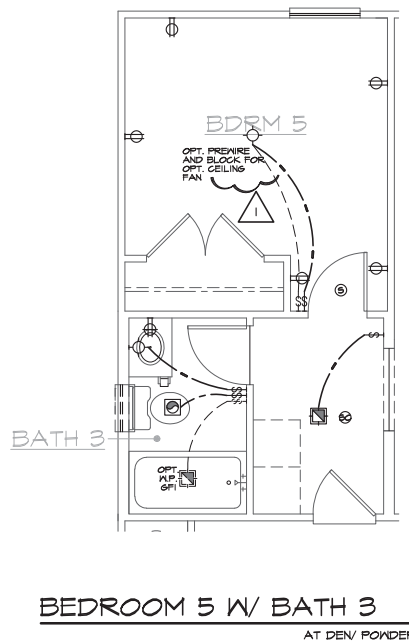
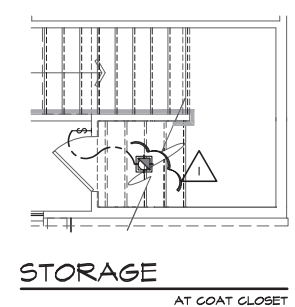
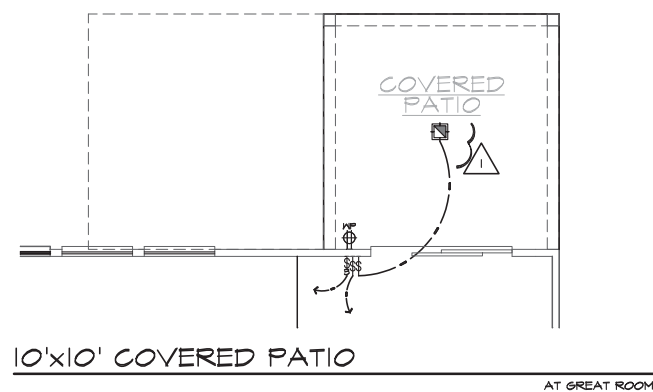

These designs and drawings are CONFIDENTIAL and the exclusive property of KB Home Corporation and are not to be disclosed without the express permission of KB Home Corporation. Copyright 2019 © KB Home Corporation, all rights reserved.



**NORTH CAROLINA
40' SERIES**

KB HOME
NORTH CAROLINA DIVISION
4506 S. MIAMI BLVD.
SUITE 180
DURHAM, NC 27703
TEL: (919) 768-7980
FAX: (919) 544-2928

**2018 NORTH
CAROLINA STATE
BUILDING
CODES**

ISSUE DATE: 05/28/15
PROJECT No.: 1350999:56
DIVISION MGR.: DCS
REVISIONS: 03/15/19

- 1 DIVISION REVISIONS
NC130524NCP - 08/15/18 - CTD
- 2 2018 CODE UPDATE
NC190515NCP/ 03/15/19 / CTD

FOR INTERNAL USE ONLY	
REVIEWED BY:	
1.	
2.	
3.	
4.	
5.	
6.	

PLAN:
240.2596
SHEET:
5.4

**SPEC. LEVEL 1
RALEIGH-DURHAM
40' SERIES**

208.16.8

UTILITY LEGEND

- ⊕ 120V DUPLEX CONVENIENCE RECEPTACLE
ARC FAULT(AFCI) AND TAMPER RESISTANT(TR)
12" ABV. FIN. FLR. TYPICAL U.N.O.
- ⊕ W/P 120V (TR) RECEPTACLE W/ GFI CIRCUIT
W/ WATER RESISTANT HOUSING
- ⊕ 6FI 120V (TR) RECEPTACLE W/ GFI CIRCUIT
- ⊕ 120V (TR) RECEPTACLE W/ GFI CIRCUIT AND AFCI CIRCUIT
- ⊕ FUSED DISCONNECT
- 120V (AFCI & TR) RECESSED FLOOR
RECEPTACLE W/ COVER
- ⊕ 120V (AFCI & TR) DUPLEX CONVENIENCE RECEPTACLE
SWITCH CONTROLLED, 1/2 HOT
- ⊕ 220 v 220V SINGLE CONVENIENCE RECEPTACLE
HEIGHT NOTED AS PER PLAN
- ⊕ 2 TWO-POLE LIGHT SWITCH AT 42" ABV. FIN. FLR.
8" ABOVE COUNTER U.N.O.
- ⊕ 3 THREE-POLE LIGHT SWITCH
- ⊕ 4 FOUR-POLE LIGHT SWITCH
- ⊕ W/P WALL MOUNTED LIGHT FIXTURE
W/ WATER RESISTANT HOUSING
- ⊕ WALL MOUNTED INCANDESCENT
LIGHT FIXTURE
- ⊕ WALL MOUNTED FLUORESCENT
LIGHT FIXTURE
- ⊕ CEILING MOUNTED INCANDESCENT
LIGHT FIXTURE
- ⊕ CEILING MOUNTED FLUORESCENT
LIGHT FIXTURE
- ⊕ HANGING INCANDESCENT
LIGHT FIXTURE
- ⊕ RECESSED INCANDESCENT DIRECTIONAL
LIGHT FIXTURE (EYE BALL)
- ⊕ RECESSED INCANDESCENT LIGHT FIXTURE
- ⊕ W/P RECESSED INCANDESCENT LIGHT FIXTURE
W/ WATER RESISTANT HOUSING
- ⊕ RECESSED FLUORESCENT LIGHT FIXTURE
- ⊕ RECESSED EXHAUST FAN
- ⊕ RECESSED EXHAUST FAN/ INCANDESCENT
LIGHT COMBINATION
- ⊕ RECESSED EXHAUST FAN/ FLUORESCENT
LIGHT COMBINATION
- ⊕ INCANDESCENT WALL SCONCE
-] ILLUMINATED ADDRESS SIGN - VISIBLE
FROM STREET

24"x48" FLUORESCENT LIGHT
BOX (CEILING MOUNTED)

12"x48" FLUORESCENT LIGHT
BOX (CEILING MOUNTED)

- ⊕ OPTIONAL PRE-WIRED CEILING FAN
AND SWITCH - LOCATED IN CENTER OF ROOM U.N.O.
- ⊕ CEILING MOUNTED JUNCTION BOX
- ⊕ WALL MOUNTED JUNCTION BOX
- ⊕ DOOR CHIME
- ⊕ CATV RECEPTACLE
- ⊕ PUSH BUTTON
- ⊕ PHONE OUTLET
-] SERVICE BOX
- ⊕ HOSE BIB
- ⊕ HOSE BIB W/ S.O.V.
- ⊕ WATER STUB FOR ICE MAKER
- ⊕ APPROVED CEILING MOUNTED
SMOKE DETECTOR TO BE HARD WIRED
WITH BATTERY BACK-UP AND INTERCONNECTED
- ⊕ APPROVED CARBON MONOXIDE ALARM/ SMOKE DET.
- ⊕ THERMOSTAT (VERIFY LOCATION W/ HVAC PLAN)
- ⊕ GAS TAP
- ⊕ GAS KEY - FIREPLACE GAS VALVES SHALL BE
LOCATED OUTSIDE OF REQUIRED HEARTH AREA,
BUT NO MORE THAN 48" FROM GAS OUTLET

SWITCHING FOR
ROOMS W/ CLG. FAN
OPTIONS

24" MIN. SEPARATION
OF ELECTRICAL BOXES
AS SHOWN BELOW

⊕ DWELLING

2'-0" MIN.

⊕ GFI

MIN.

⊕ GARAGE

NOTES

1. MECHANICAL, ELECTRICAL AND PLUMBING SYSTEMS ARE SHOWN FOR INTENT ONLY. THESE SYSTEMS SHALL BE ENGINEERED BY OTHERS. THE CONTRACTOR SHALL BE RESPONSIBLE FOR PROPER INSTALLATION AND PLACEMENT. ALL HEIGHTS SHOWN ARE TO CENTERLINE OF FIXTURE.
2. PROVIDE SWITCH, LIGHT, 120V (AFCI & TR) DUPLEX RECEPTACLE & FUEL GAS STUB OR 220V RECEPTACLE IN ATTIC FOR F.A.U. - PER COMMUNITY SPECIFICATIONS.
3. SMOKE DETECTORS IN ROOMS WITH VOLUME CEILING TO BE LOCATED AT HIGHEST POINT OF CEILING.
4. 20 FOOT #4 REBAR FOR UFER GROUND AND ADDITIONAL COLD WATER GROUND. REFER TO SLAB INTERFACE PLAN FOR LOCATION.
5. 200 AMP ELECTRICAL PANEL (DEFAULT). ELECTRICAL PLAN CHECK PERMIT REQUIRED IF LOAD EXCEED 400 AMPS.

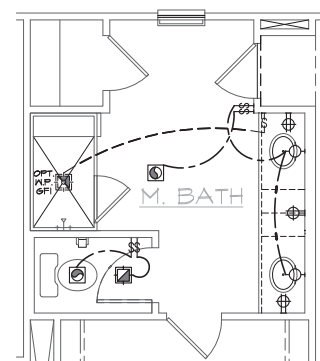

DELUXE M. BATH
AT M. BATH

These designs and drawings are CONFIDENTIAL and the exclusive property of KB Home Corporation and are not to be disclosed without the express permission of KB Home Corporation. Copyright 2019 © KB Home Corporation. All rights reserved.



**NORTH CAROLINA
40' SERIES**

KB HOME
NORTH CAROLINA DIVISION
4506 S. MIAMI BLVD.
SUITE 180
DURHAM, NC 27703
TEL: (919) 768-7980
FAX: (919) 544-2928

**2018 NORTH
CAROLINA STATE
BUILDING
CODES**

ISSUE DATE: 05/28/15
PROJECT No.: 1350999:56
DIVISION MGR.: DCS
REVISIONS: 03/15/19

1 DIVISION REVISIONS
NC19054NCP - 08/15/18 - CTD
2 2018 CODE UPDATE
NC19051NCP/ 03/15/19 / CTD

FOR INTERNAL USE ONLY	
REVIEWED BY:	
1.	
2.	
3.	
4.	
5.	

PLAN:
240.2596
SHEET:
8.3

**SPEC. LEVEL 1
RALEIGH-DURHAM
40' SERIES**

ELEVATION NOTES

- NOTE: NOT ALL KEY NOTES APPLY.
1. ROOF MATERIAL - REFER TO ROOF NOTES
 2. 2X FASCIA/BARGE BOARD WITH FASCIA CAP
 3. 6:12 FLASHING
 4. 6:12 FLASHING & SADDLE/CRICKET
 5. 6:12 DRIP SCREED
 6. 24"x24" CHIMNEY
 7. DECORATIVE VENT
 8. DECORATIVE CORBEL
 9. DECORATIVE SHUTTERS
 10. PEDIMENT, SEE ELEVATION FOR TYPE
 11. RECESSED ELEMENT
 12. DECORATIVE TRIM FYPON OR EQ. SEE ELEVATION FOR TYPE
 13. TRIM - SEE ELEVATION FOR SIZE
 14. SYNTHETIC MATERIAL
 15. PRE-MANUFACTURED DECORATIVE COLUMN (SIZE, SEE ELEV.) FYPON OR EQ. SURROUNDING STRUCTURAL POST.
 16. SITE-BUILT COLUMN - SEE ELEVATION FOR TYPE
 17. SHAKE SIDING
 18. STONE VENEER PER SPECS
 19. BRICK/MASONRY VENEER PER SPECS
 20. BUILT UP BRICK COLUMN
 21. SOLDIER COURSE
 22. ROWLOCK COURSE
 23. FRIEZE BOARD
 24. SIDING W/ 4" CORNER TRIM PER SPECS
 25. P.T. POST W/ WRAP - SEE STRUCTURAL FOR SIZE
 26. PRE-FAB DECORATIVE TRIM
 27. LIGHT WEIGHT PRECAST STONE TRIM
 28. RAILINGS (48" U.N.O.)
 29. VINYL WRAP
 30. DECORATIVE WINDOW/DOOR TRIM - FYPON OR EQ. SEE ELEVATION FOR SIZE.
 31. BRACKET OR KICKER - FYPON OR EQ.
 32. ENTRY DOOR
 33. CONCRETE STOOP/ PORCH - SEE SLAB INTERFACE PLAN.
 34. SECTIONAL GARAGE DOOR PER SPECS
 35. ALUMINUM WRAP
 36. OPTIONAL DOOR/WINDOW - REFER TO PLAN OPTIONS
 37. OPTIONAL STANDING SEAM METAL ROOF
 38. KEYSTONE
 39. SOLDIER CROWN
 40. JACK SOLDIER COURSE
 41. WATER TABLE
 42. ATRIUM DOOR
 43. PILLASTER - SEE ELEVATION FOR TYPE

PARTIAL PLAN NOTES

- NOTE: NOT ALL KEY NOTES APPLY.
27. WATER HEATER LOCATION - FOR GAS - LOCATE ON 18" HIGH PLATFORM - FOR INTERIOR LOCATION - PROVIDE PAN & DRAIN (REFER TO DETAILS)
 28. WATER HEATER VENT TO OUTSIDE AIR
 29. MAIN LINE SHUT-OFF VALVE AND TEMP. & PRESSURE RELIEF VALVE
 39. LINE OF WALL BELOW
 41. LINE OF FLOOR ABOVE
 42. LINE OF FLOOR BELOW
 43. MIN. 36" HIGH GUARDRAIL (REFER TO DETAIL SHEETS)
 50. A/C PAD LOCATION
 51. LOW WALL - REFER TO PLAN FOR HEIGHT
 52. 2x6 STUD WALL
 54. DEL. 2x4 WALL PER PLAN
 55. INTERIOR SHELF - REFER TO PLAN FOR HEIGHT
 57. FLAT SOFFIT
 58. ARCHED SOFFIT
 60. OPT. DOOR/ WINDOW
 61. PRE-MANUFACTURED DECORATIVE COLUMN (SIZE, SEE ELEV.) FYPON OR EQ. SURROUNDING STRUCTURAL POST.
 62. BRICK / STONE VENEER - REFER TO ELEVATIONS
 63. SECTIONAL GARAGE DOOR PER SPECS
 66. 3" DIA. CONCRETE FILLED PIPE BOLLARD 36" HIGH WITH MIN. 12" EMBEDMENT INTO CONCRETE (NOT REQUIRED AT ELECTRIC WATER HEATERS OR FOR APPLIANCES LOCATED OUT OF THE VEHICLE'S NORMAL TRAVEL PATH).
 68. P.T. POST W/ VINYL WRAP.
 70. EGRESS WINDOW
 75. WINDOW LEDGE, HEIGHT & WIDTH OF OPENING TO EXTEND 6" BEYOND WINDOW(S) ON ALL SIDES U.N.O.
 76. SITE-BUILT COLUMN - SEE ELEVATION FOR TYPE
 77. CONCRETE SLAB, SLOPE 1/4" PER FT. MIN. SEE PLAN FOR SIZE

ROOF PLAN NOTES

6:12 INDICATES ROOF SLOPE AND DIRECTION, U.N.O.
ROOF MATERIAL: COMPOSITION SHINGLE
12" (INCHES) TYPICAL ROOF OVERHANGS AT RAKE, U.N.O.
12" (INCHES) TYPICAL ROOF OVERHANGS AT EAVE, U.N.O.
LOCATE EAVE/ RAFTER VENTS EQUALLY BALANCED AROUND HOUSE EXCEPT ABOVE SHEARWALL PANELS.

ATTIC VENT CALCULATIONS

PROVIDE 1 SQ. IN. OF VENTILATION PER 500 SQ. IN. OF ATTIC SPACE. PROVIDE THAT AT LEAST 50% & NO MORE THAN 80% OF THE REQ. VENTILATING AREA IS PROVIDED BY VENTILATORS LOCATED IN THE UPPER PORTION OF THE ATTIC. (HIGH VENTING) AT 5'-0" ABOVE EAVE VENT WITH THE BALANCE BEING PROVIDED BY EAVE VENTS (LOW VENTING) (2018 NC-R 806.2)
* CALCULATION BY 1/50, HIGH/LOW VENTING NOT REQUIRED.
APPROXIMATE RIDGE VENT LOCATIONS SHOWN. ACTUAL LOCATIONS TO BE DETERMINED IN THE FIELD.

AREA 3 / OPTIONAL 10'X10' COVERED PATIO	
VENTILATION REQUIRED:	* 100 SQ. FT. / 50 = 0.67 SQ. FT. ATTIC AREA X 144 = 46.40 SQ. IN.
VENTILATION PROVIDED:	(7) LIN. FEET OF RIDGE VENT AT (18 SQ. IN./FOOT) = 126 SQ. IN. (20) LIN. FEET OF VENTILATED SOFFIT (5 SQ. IN./FOOT) = 100 SQ. IN.
TOTAL VENTILATION PROVIDED:	226 SQ. IN.

NOTE: REFER TO BASIC ELEVATIONS FOR INFORMATION NOT SHOWN HERE
NOTE: REFER TO BASIC ROOF PLAN FOR INFORMATION NOT SHOWN HERE
NOTE: REFER TO BASIC FLOOR PLAN FOR INFORMATION NOT SHOWN HERE

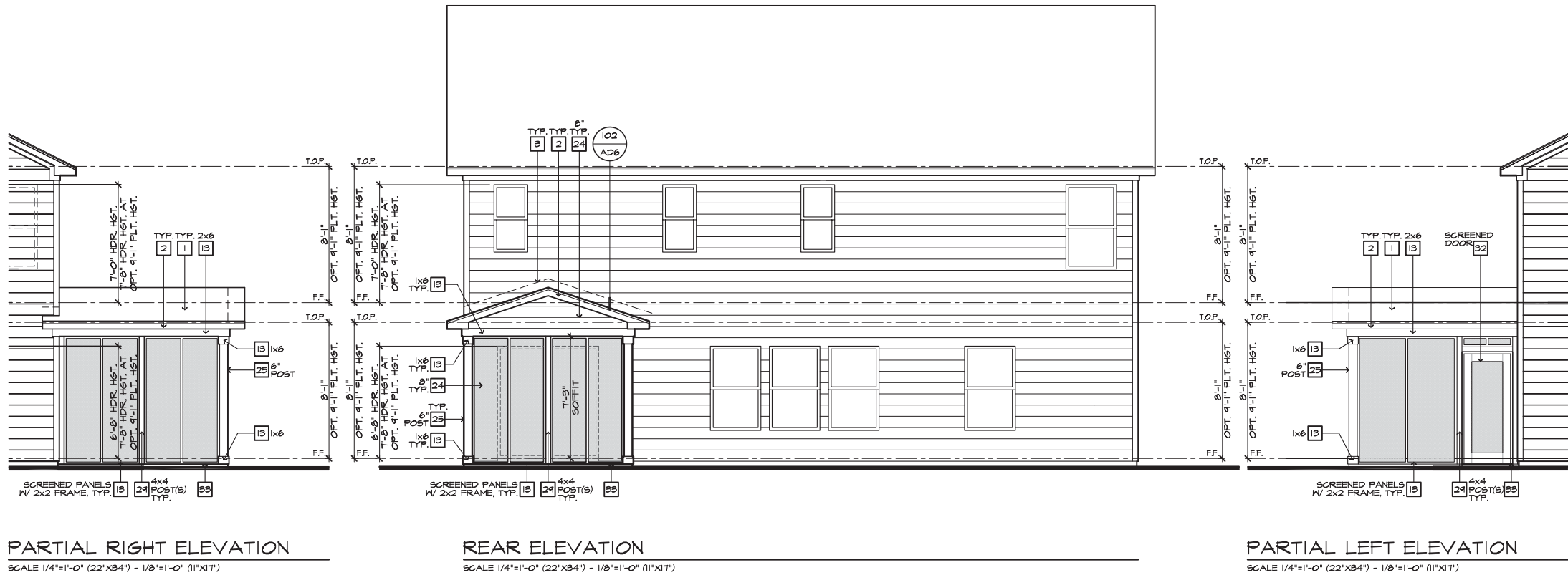

PARTIAL RIGHT ELEVATION
SCALE 1/4"=1'-0" (22'X34') - 1/8"=1'-0" (11'X17')

REAR ELEVATION
SCALE 1/4"=1'-0" (22'X34') - 1/8"=1'-0" (11'X17')

PARTIAL LEFT ELEVATION
SCALE 1/4"=1'-0" (22'X34') - 1/8"=1'-0" (11'X17')

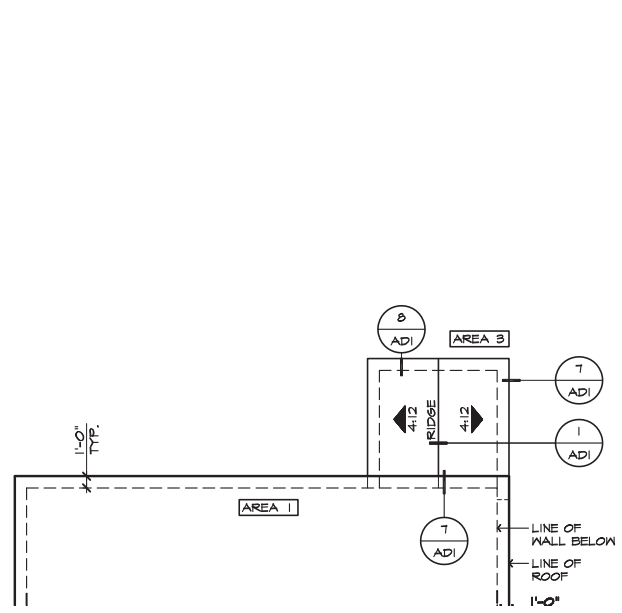

PARTIAL ROOF PLAN
SCALE 1/8"=1'-0" (22'X34') - 1/16"=1'-0" (11'X17')

10'X10' SCREENED-IN COVERED PATIO

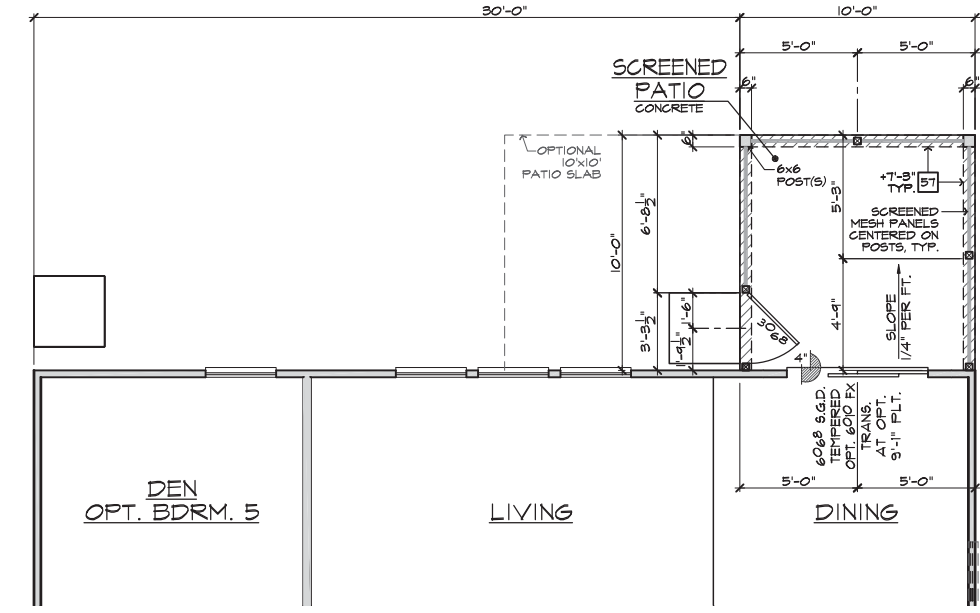

PARTIAL FLOOR PLAN
SCALE 1/4"=1'-0" (22'X34') - 1/8"=1'-0" (11'X17')

These designs and drawings are CONFIDENTIAL and the exclusive property of KB Home Corporation and are not to be disclosed without the express permission of KB Home Corporation. Copyright 2019 © KB Home Corporation, all rights reserved.

NOTE: ALL CHAPTERS, SECTIONS, TABLES, AND FIGURES CITED WITHOUT A PUBLICATION TITLE ARE FROM THE APPLICABLE RESIDENTIAL CODE (SEE TITLE SHEET).

GENERAL

1. IT IS THE CONTRACTOR'S RESPONSIBILITY TO VERIFY ALL DIMENSIONS PRIOR TO CONSTRUCTION. FURTHERMORE, CONTRACTOR IS ULTIMATELY RESPONSIBLE FOR CONSTRUCTION MEANS, METHODS, AND SAFETY ON SITE. NOTIFY JDS CONSULTING & DESIGN, PLLC IMMEDIATELY IF DISCREPANCIES ON PLAN EXIST.

2. BRACED-WALL DESIGN IS BASED ON SECTION R602.10 - WALL BRACING. PRIMARY PRESCRIPTIVE METHOD TO BE CS-WSP. SEE WALL BRACING PLANS AND DETAILS FOR ADDITIONAL INFORMATION.

ALL NON-PRESCRIPTIVE SOLUTIONS ARE BASED ON GUIDELINES ESTABLISHED IN THE AMERICAN SOCIETY OF CIVIL ENGINEERS PUBLICATION ASCE 7 AND THE NATIONAL DESIGN SPECIFICATION FOR WOOD CONSTRUCTION - SPECIAL DESIGN PROVISIONS FOR WIND AND SEISMIC.

3. SEISMIC DESIGN SHALL BE PER SECTION R301.2.2 - SEISMIC PROVISIONS, INCLUDING ASSOCIATED TABLES AND FIGURES, BASED ON LOCAL SEISMIC DESIGN CATEGORY.

DESIGN LOADS

ASSUMED SOIL BEARING-CAPACITY	2,000 PSF
	LIVE LOAD
ULTIMATE DESIGN WIND SPEED	115 MPH, EXPOSURE B
GROUND SNOW	15 PSF
ROOF	20 PSF
<u>RESIDENTIAL CODE TABLE R301.5</u>	<u>LIVE LOAD (PSF)</u>
DWELLING UNITS	40
SLEEPING ROOMS	30
ATTICS WITH STORAGE	20
ATTICS WITHOUT STORAGE	10
STAIRS	40
DECKS	40
EXTERIOR BALCONIES	60
PASSENGER VEHICLE GARAGES	50
FIRE ESCAPES	40
GUARDS AND HANDRAILS	200 (pounds, concentrated)

COMPONENT AND CLADDING LOADS, INCLUDING THOSE FOR DOORS AND WINDOWS, SHALL BE DERIVED FROM TABLES R301.2(2) AND R301.2(3) FOR A BUILDING WITH A MEAN ROOF HEIGHT OF 35 FEET, LOCATED IN EXPOSURE B.

ABBREVIATIONS

ABV	ABOVE	KS	KING STUD COLUMN
AFF	ABOVE FINISHED FLOOR	LVL	LAMINATED VENEER LUMBER
ALT	ALTERNATE	MAX	MAXIMUM
BRG	BEARING	MECH	MECHANICAL
BSMT	BASEMENT	MFR	MANUFACTURER
CANT	CANTILEVER	MIN	MINIMUM
CJ	CEILING JOIST	NTS	NOT TO SCALE
CLG	CEILING	OA	OVERALL
CMU	CONCRETE MASONRY UNIT	OC	ON CENTER
CO	CASED OPENING	PT	PRESSURE TREATED
COL	COLUMN	R	RISER
CONC	CONCRETE	REF	REFRIGERATOR
CONT	CONTINUOUS	RFG	ROOFING
D	CLOTHES DRYER	RO	ROUGH OPENING
DBL	DOUBLE	RS	ROOF SUPPORT
DIAM	DIAMETER	SC	STUD COLUMN
DJ	DOUBLE JOIST	SF	SQUARE FOOT (FEET)
DN	DOWN	SH	SHELF / SHELVES
DP	DEEP	SHTG	SHEATHING
DR	DOUBLE RAFTER	SHW	SHOWER
DSP	DOUBLE STUD POCKET	SIM	SIMILAR
EA	EACH	SJ	SINGLE JOIST
EE	EACH END	SP	STUD POCKET
EQ	EQUAL	SPEC'D	SPECIFIED
EX	EXTERIOR	SQ	SQUARE
FAU	FORCED-AIR UNIT	T	TREAD
FDN	FOUNDATION	TEMP	TEMPERED GLASS
FF	FINISHED FLOOR	THK	THICK(NESS)
FLR	FLOOR(ING)	TJ	TRIPLE JOIST
FP	FIREPLACE	TOC	TOP OF CURB / CONCRETE
FTG	FOOTING	TR	TRIPLE RAFTER
HB	HOSE BIBB	TYP	TYPICAL
HDR	HEADER	UNO	UNLESS NOTED OTHERWISE
HGR	HANGER	W	CLOTHES WASHER
JS	JACK STUD COLUMN	WH	WATER HEATER
		WWF	WELDED WIRE FABRIC
		XJ	EXTRA JOIST

MATERIALS

1. INTERIOR / TRIMMED FRAMING LUMBER SHALL BE #2 SPRUCE PINE FIR (SPF) WITH THE FOLLOWING DESIGN PROPERTIES (#2 SOUTHERN YELLOW PINE MAY BE SUBSTITUTED):

Fb = 875 PSI Fv = 70 PSI E = 1.4E6 PSI

2. FRAMING LUMBER EXPOSED TO WEATHER OR IN CONTACT WITH THE GROUND, CONCRETE, OR MASONRY SHALL BE PRESSURE TREATED #2 SOUTHERN YELLOW PINE (SYP) WITH THE FOLLOWING DESIGN PROPERTIES:

Fb = 975 PSI Fv = 95 PSI E = 1.6E6 PSI

3. LVL STRUCTURAL MEMBERS TO BE LAMINATED VENEER LUMBER WITH THE FOLLOWING MINIMUM DESIGN PROPERTIES:

Fb = 2600 PSI Fv = 285 PSI E = 1.9E6 PSI

4. PSL STRUCTURAL MEMBERS TO BE PARALLEL STRAND LUMBER WITH THE FOLLOWING MINIMUM DESIGN PROPERTIES:

Fb = 2900 PSI Fv = 290 PSI E = 2.0E6 PSI

5. LSL STRUCTURAL MEMBERS TO BE LAMINATED STRAND LUMBER WITH THE FOLLOWING MINIMUM DESIGN PROPERTIES:

Fb = 2250 PSI Fv = 400 PSI E = 1.55E6 PSI

6. STRUCTURAL STEEL WIDE-FLANGE BEAMS SHALL CONFORM TO ASTM A992. Fy = 50 KSI

7. REBAR SHALL BE DEFORMED STEEL CONFORMING TO ASTM A615, GRADE 60.

8. POURED CONCRETE COMPRESSIVE STRENGTH TO BE A MINIMUM 3,000 PSI AT 28 DAYS. MATERIALS USED TO PRODUCE CONCRETE SHALL COMPLY WITH THE APPLICABLE STANDARDS LISTED IN AMERICAN CONCRETE INSTITUTE STANDARD ACI 318 OR ASTM C1157.

9. CONCRETE SUBJECT TO MODERATE OR SEVERE WEATHERING PROBABILITY PER TABLE R301.2(1) SHALL BE AIR-ENTRAINED WHEN REQUIRED BY TABLE R402.2.

10. CONCRETE MASONRY UNITS (CMU) SHALL CONFORM TO AMERICAN CONCRETE INSTITUTE PUBLICATION 530: BUILDING CODE REQUIREMENTS AND SPECIFICATIONS FOR MASONRY STRUCTURES AND COMPANION COMMENTARIES AND THE MASONRY SOCIETY PUBLICATION TMS 402/602: BUILDING CODE REQUIREMENTS AND SPECIFICATIONS FOR MASONRY STRUCTURES.

11. MORTAR SHALL COMPLY WITH ASTM INTERNATIONAL STANDARD C270.

12. INDICATED MODEL NUMBERS FOR ALL METAL HANGERS, STRAPS, FRAMING CONNECTORS, AND HOLD-DOWNS ARE SIMPSON STRONG-TIE BRAND. EQUIVALENT USP BRAND PRODUCTS ARE ACCEPTABLE.

13. REFER TO I-JOIST EQUIVALENCE CHART ON I-JOIST DETAIL SHEET FOR SUBSTITUTION OF MANUFACTURER SERIES.

FOUNDATION

1. MINIMUM ALLOWABLE SOIL BEARING CAPACITY IS ASSUMED TO BE 2,000 PSF. IT IS THE CONTRACTOR'S RESPONSIBILITY TO VERIFY SOIL BEARING CAPACITY IF UNSATISFACTORY CONDITIONS EXIST.

2. CONCRETE FOUNDATION WALLS TO BE SELECTED AND CONSTRUCTED PER SECTION R404 OR AMERICAN CONCRETE INSTITUTE STANDARD ACI 318.

3. MASONRY FOUNDATION WALLS TO BE SELECTED AND CONSTRUCTED PER SECTION R404 AND/OR AMERICAN CONCRETE INSTITUTE PUBLICATION 530: BUILDING CODE REQUIREMENTS AND SPECIFICATIONS FOR MASONRY STRUCTURES AND COMPANION COMMENTARIES AND/OR THE MASONRY SOCIETY PUBLICATION TMS 402/602: BUILDING CODE REQUIREMENTS AND SPECIFICATIONS FOR MASONRY STRUCTURES.

4. CONCRETE WALL HORIZONTAL REINFORCEMENT TO BE PER TABLE R404.1.2(1) OR AS NOTED OR DETAILED. CONCRETE WALL VERTICAL REINFORCEMENT TO BE PER TABLES R404.1.2(3 AND 4) OR AS NOTED OR DETAILED. ALL CONCRETE WALLS SHALL COMPLY WITH APPLICABLE PROVISIONS OF CHAPTER 6.

- A. TABLES ASSUME THAT WALLS HAVE PERMANENT LATERAL SUPPORT AT THE TOP AND BOTTOM.
- B. FOUNDATION DRAINS ARE ASSUMED AT ALL WALLS PER SECTION R405.

5. PLAIN-MASONRY WALL DESIGN TO BE PER TABLE R404.1.1(1) OR AS NOTED OR DETAILED. MASONRY WALLS WITH VERTICAL REINFORCEMENT TO BE PER TABLES R404.1.1 (2 THROUGH 4) OR AS NOTED OR DETAILED. ALL MASONRY WALLS SHALL COMPLY WITH APPLICABLE PROVISIONS OF CHAPTER 6.

- A. TABLES ASSUME THAT WALLS HAVE PERMANENT LATERAL SUPPORT AT THE TOP AND BOTTOM.
- B. WALL REINFORCING SHALL BE PLACED ACCORDING TO FOOTNOTE (c) OF THE TABLES (REINFORCING IS NOT CENTERED IN WALL).
- C. FOUNDATION DRAINS ARE ASSUMED AT ALL WALLS PER SECTION R405.

6. WOOD SILL PLATES TO BE ANCHORED TO THE FOUNDATION WITH 1/2" DIAMETER ANCHOR BOLTS WITH MINIMUM 7" EMBEDMENT, SPACED A MAXIMUM OF 6'-0" OC AND WITHIN 12" FROM THE ENDS OF EACH PLATE SECTION. INSTALL MINIMUM (2) ANCHOR BOLTS PER SECTION. SEE SECTION R403.1.6 FOR SPECIFIC CONDITIONS.

7. THE UNSUPPORTED HEIGHT OF SOLID MASONRY PIERS SHALL NOT EXCEED TEN TIMES THEIR LEAST DIMENSION. UNFILLED, HOLLOW PIERS MAY BE USED IF THE UNSUPPORTED HEIGHT IS NOT MORE THAN FOUR TIMES THEIR LEAST DIMENSION.

8. CENTERS OF PIERS TO BEAR IN THE MIDDLE THIRD OF THE FOOTINGS, AND GIRDEES SHALL CENTER IN THE MIDDLE THIRD OF THE PIERS.

9. ALL FOOTINGS TO HAVE MINIMUM 2" PROJECTION ON EACH SIDE OF FOUNDATION WALLS (SEE DETAILS).

10. ALL REBAR NOTED IN CONCRETE TO HAVE AT LEAST 2" COVER FROM EDGE OF CONCRETE TO EDGE OF REBAR.

11. FRAMING TO BE FLUSH WITH FOUNDATION WALLS.

12. WITH CLASS 1 SOILS, VAPOR BARRIER AND CRUSHED STONE MAY BE OMITTED.

FRAMING

1. ALL BEARING HEADERS TO BE (2) 2x6 SUPPORTED W/ MIN (1) JACK STUD AND (1) KING STUD EACH END, UNO.

2. ALL NON-BEARING HEADERS TO BE (2) 2x4, UNO.

3. NON-BEARING INTERIOR WALLS NOT MORE THAN 10' NOMINAL HEIGHT AND NOT SHOWN AS BRACED WALLS MAY BE FRAMED WITH 2x4 STUDS @ 24" OC.

4. SOLID BLOCKING TO BE PROVIDED AT ALL POINT LOADS THROUGH FLOOR LEVELS TO THE FOUNDATION OR TO OTHER STRUCTURAL COMPONENTS.

5. ALL BEAMS SPECIFIED ARE MINIMUM SIZES ONLY. LARGER MEMBERS MAY SUBSTITUTED AS NEEDED FOR EASE OF CONSTRUCTION.

6. ALL EXTERIOR WALLS TO BE FULLY SHEATHED WITH 7/16" OSB.

7. PORCH / PATIO COLUMNS TO BE 4x4 MINIMUM PRESSURE-TREATED LUMBER.

- A. ATTACH PORCH COLUMNS TO SLAB / FDN WALL USING ABA, ABU, ABW, OR CPT SIMPSON POST BASES TO FIT COLUMN SIZES NOTED ON PLAN -OR- ANY OTHER COLUMN CONNECTION WITH 500# UPLIFT CAPACITY.
- B. ATTACH PORCH COLUMNS TO PORCH BEAMS USING AC OR BC SIMPSON POST CAPS TO FIT COLUMN SIZES NOTED ON PLAN -OR- ANY OTHER COLUMN CONNECTION WITH 500# UPLIFT CAPACITY.
- C. TRIM OUT COLUMN(S) AND BEAM(S) PER BUILDER AND DETAILS.

7. ALL ENGINEERED WOOD PRODUCTS (LVL, PSL, LSL, ETC.) SHALL BE INSTALLED WITH CONNECTIONS PER MANUFACTURER SPECIFICATIONS.

8. ENGINEERED WOOD FLOOR SYSTEMS AND ROOF TRUSS SYSTEMS:

- A. SHOP DRAWINGS FOR THE SYSTEMS SHALL BE PROVIDED TO THE ENGINEER OF RECORD FOR REVIEW AND COORDINATION BEFORE CONSTRUCTION.
- B. TRUSS PROFILES SHALL BE SEALED BY THE TRUSS MANUFACTURER.
- C. INSTALLATION OF THE SYSTEMS SHALL BE PER MANUFACTURER'S INSTRUCTIONS.
- D. TRUSS LAYOUT AND PLACEMENT BY MANUFACTURER TO COINCIDE WITH THE SUPPORT LOCATIONS SHOWN IN THESE DRAWINGS.

9. ALL BEAMS TO BE CONTINUOUSLY SUPPORTED Laterally AND SHALL BEAR FULL WIDTH ON THE SUPPORTING WALLS OR COLUMNS INDICATED, WITH A MINIMUM OF THREE STUDS, UNO.

10. ALL STEEL BEAMS TO BE SUPPORTED AT EACH END WITH A MIN BEARING LENGTH OF 3 1/2" AND FULL FLANGE WIDTH. BEAMS MUST BE ATTACHED AT EACH END WITH A MINIMUM OF FOUR 16d NAILS OR TWO 1/2" x 4" LAG SCREWS, UNO.

11. STEEL FLITCH BEAMS TO BE BOLTED TOGETHER USING (2) ROWS OF 1/2" DIAMETER BOLTS (ASTM 307) WITH WASHERS PLACED UNDER THE THREADED END OF THE BOLT. BOLTS TO BE SPACED AT 24" OC (MAX) AND STAGGERED TOP AND BOTTOM OF BEAM (2" EDGE DISTANCE), WITH TWO BOLTS TO BE LOCATED AT 6" FROM EACH END OF FLITCH BEAM.

12. WHEN A 4-PLY LVL BEAM IS USED, ATTACH WITH (1) 1/2" DIAMETER BOLT, 12" OC, STAGGERED TOP AND BOTTOM, 1 1/2" MIN FROM ENDS. ALTERNATE EQUIVALENT ATTACHMENT METHOD MAY BE USED, SUCH AS SDS, SDW, OR TRUSSLOK SCREWS (SEE MANUFACTURER SPECIFICATIONS).

13. FOR STUD COLUMNS OF 4-OR-MORE STUDS, INSTALL SIMPSON STRONG-TIE CS16 STRAPS ACROSS STUDS @ 30" OC, 6" MAX FROM PLATES, ON INSIDE FACE OF COLUMN (EXTERIOR WALL), ON BOTH FACES OF COLUMN (INTERIOR WALL).

14. FLOOR JOISTS ADJACENT AND PARALLEL TO THE EXTERIOR FOUNDATION WALL SHALL BE PROVIDED WITH FULL-DEPTH SOLID BLOCKING, NOT LESS THAN TWO (2) INCHES NOMINAL IN THICKNESS, PLACED PERPENDICULAR TO THE JOIST AT SPACING NOT MORE THAN FOUR (4) FEET. THE BLOCKING SHALL BE NAILED TO THE FLOOR SHEATHING, THE SILL PLATE, THE JOIST, AND THE EXTERIOR RIM JOIST / BOARD.

15. BRACED WALL PANELS SHALL BE FASTENED TO MEET THE UPLIFT-RESISTANCE REQUIREMENTS IN CHAPTERS 6 AND 8 OF THE APPLICABLE CODE (SEE TITLE SHEET). REQUIREMENTS OF THE STRUCTURAL DRAWINGS THAT EXCEED THE CODE MINIMUM SHALL BE MET.



KB HOME
NORTH CAROLINA DIVISION
4518 S. MIAMI BLVD.
SUITE 180
DURHAM, NC 27703
TEL: (919) 768-7988
FAX: (919) 472-0582



PROJECT NO.: 19900409
DATE: 3/21/2019

PLAN:
240.2596

GENERAL NOTES

GN1.0

These designs and drawings are CONFIDENTIAL and the exclusive property of KB Home Corporation and are not to be disclosed without the express permission of KB Home Corporation. They may not be used or duplicated without the express permission of KB Home Corporation. Copyright 2019 © KB Home Corporation. All rights reserved.

FASTENER SCHEDULE		
CONNECTION	3" x 0.131" NAIL	3" x 0.120" NAIL
JOIST TO SILL PLATE	(4) TOE NAILS	(4) TOE NAILS
SOLE PLATE TO JOIST / BLOCKING	NAILS @ 8" OC (typical) (4) PER 16" SPACE (at braced panels)	NAILS @ 8" OC (typical) (4) PER 16" SPACE (at braced panels)
STUD TO SOLE PLATE	(4) TOE NAILS	(4) TOE NAILS
TOP OR SOLE PLATE TO STUD	(3) FACE NAILS	(4) FACE NAILS
RIM JOIST OR BAND JOIST TO TOP PLATE OR SILL PLATE	TOE NAILS @ 6" OC	TOE NAILS @ 4" OC
BLOCKING BETWEEN JOISTS TO TOP PLATE OR SILL PLATE	(4) TOE NAILS	(4) TOE NAILS
DOUBLE STUD	NAILS @ 8" OC	NAILS @ 8" OC
DOUBLE TOP PLATES	NAILS @ 12" OC	NAILS @ 12" OC
DOUBLE TOP PLATES LAP (24" MIN LAP LENGTH)	(12) NAILS IN LAPPED AREA, EA SIDE OF JOINT	(12) NAILS IN LAPPED AREA, EA SIDE OF JOINT
TOP PLATE LAP AT CORNERS AND INTERSECTING WALLS	(3) FACE NAILS	(3) FACE NAILS
OPEN-WEB TRUSS BOTTOM CHORD TO TOP PLATES OR SILL PLATE (PARALLEL TO WALL)	NAILS @ 6" OC	NAILS @ 4" OC
BOTTOM CHORD OF TRUSS TO TOP PLATES OR SILL PLATE (PERPENDICULAR TO WALL)	(3) TOE NAILS	(3) TOE NAILS

SEE TABLE R602.3(1) FOR ADDITIONAL STRUCTURAL-MEMBER FASTENING REQUIREMENTS.

DETAILS AND NOTES ON DRAWINGS GOVERN.

BALLOON WALL FRAMING SCHEDULE
(USE THESE STANDARDS UNLESS NOTED OTHERWISE ON THE FRAMING PLAN SHEETS)

FRAMING MEMBER SIZE	MAX HEIGHT (PLATE TO PLATE) 115 MPH ULTIMATE DESIGN WIND SPEED
2x4 @ 16" OC	10'-0"
2x4 @ 12" OC	12'-0"
2x6 @ 16" OC	15'-0"
2x6 @ 12" OC	17'-9"
2x8 @ 16" OC	19'-0"
2x8 @ 12" OC	22'-0"
(2) 2x4 @ 16" OC	14'-6"
(2) 2x4 @ 12" OC	17'-0"
(2) 2x6 @ 16" OC	21'-6"
(2) 2x6 @ 12" OC	25'-0"
(2) 2x8 @ 16" OC	27'-0"
(2) 2x8 @ 12" OC	31'-0"

- ALL HEIGHTS ARE MEASURED SUBFLOOR TO TOP OF WALL PLATE.
- WHEN SPLIT-FRAMED WALLS ARE USED FOR HEIGHTS OVER 12', THE CONTRACTOR SHALL ADD 6' MINIMUM OF CS16 COIL STRAPPING (FULLY NAILED), CENTERED OVER THE WALL BREAK.
- FINGER-JOINTED MEMBERS MAY BE USED FOR CONTINUOUS HEIGHTS WHERE TRADITIONALLY MILLED LUMBER LENGTHS ARE LIMITED.
- FOR GREATER WIND SPEED, SEE ENGINEERED SOLUTION FOR CONDITION IN DRAWINGS.

ROOF SYSTEMS

TRUSSED ROOF - STRUCTURAL NOTES

- PROVIDE CONTINUOUS BLOCKING THROUGH STRUCTURE FOR ALL POINT LOADS.
-  DENOTES OVER-FRAMED AREA
- MINIMUM 7/16" OSB ROOF SHEATHING
- TRUSS LAYOUT AND PLACEMENT BY MANUFACTURER TO COINCIDE WITH THE SUPPORT LOCATIONS SHOWN. TRUSS PROFILES SHALL BE SEALED BY THE TRUSS MANUFACTURER. TRUSS PLANS TO BE COORDINATED WITH THE SEALED STRUCTURAL DRAWINGS. INSTALLATION SHALL BE IN ACCORDANCE WITH THE MANUFACTURER'S INSTRUCTIONS.
- MANUFACTURER TO PROVIDE REQUIRED UPLIFT CONNECTION.
- PROVIDE H2.5A (MINIMUM) OR EQUIVALENT AT EACH TRUSS-TO-TOP PLATE CONNECTION AT OVER-FRAMED AREAS, UNLESS NOTED OTHERWISE.
- UPLIFT CONNECTION TO BE CARRIED THROUGH TO FLOOR SYSTEM.

STICK-FRAMED ROOF - STRUCTURAL NOTES

- PROVIDE 2x4 COLLAR TIES AT 48" OC AT UPPER THIRD OF RAFTERS, UNLESS NOTED OTHERWISE.
- FUR RIDGES FOR FULL RAFTER CONTACT.
- PROVIDE CONTINUOUS BLOCKING THROUGH STRUCTURE FOR ALL POINT LOADS.
-  DENOTES OVER-FRAMED AREA
- MINIMUM 7/16" OSB ROOF SHEATHING
- PROVIDE 2x4 RAFTER TIES AT 16" OC AT 45° BETWEEN RAFTERS AND CEILING JOISTS. USE (4) 16d NAILS AT EACH CONNECTION. RAFTER TIES MAY BE SPACED AT 48" OC AT LOCATIONS WHERE NO KNEE WALLS ARE INSTALLED.
- PROVIDE H2.5A (MINIMUM) OR EQUIVALENT AT EACH RAFTER-TO-TOP PLATE CONNECTION AT OVER-FRAMED AREAS, UNLESS NOTED OTHERWISE.
- UPLIFT CONNECTION TO BE CARRIED THROUGH TO FLOOR SYSTEM.

BRICK VENEER LINTEL SCHEDULE		
SPAN	STEEL ANGLE SIZE	END BEARING LENGTH
UP TO 42"	L3-1/2"x3-1/2"x1/4"	8" (MIN. @ EACH END)
UP TO 72"	L6"x4"x5/16" (LLV)	8" (MIN. @ EACH END)
OVER 72"	L6"x4"x5/16" (LLV) ATTACH LINTEL w/ 1/2" THRU BOLT @ 12" OC, 3" FROM EACH END	

* FOR QUEEN BRICK: LINTELS AT THIS CONDITION MAY BE 5"x3-1/2"x5/16"

NOTE: BRICK LINTELS AT SLOPED AREAS TO BE 4"x3-1/2"x1/4" STEEL ANGLE WITH 16D NAILS IN 3/16" HOLES IN 4" ANGLE LEG AT 12" OC TO TRIPLE RAFTER. WHEN THE SLOPE EXCEEDS 4:12 A MINIMUM OF 3"x3"x1/4" PLATES SHALL BE WELDED AT 24" OC ALONG THE STEEL ANGLE.



KB HOME
NORTH CAROLINA DIVISION

4518 S. MIAMI BLVD.
SUITE 180
DURHAM, NC 27703
TEL: (919) 768-7988
FAX: (919) 472-0582

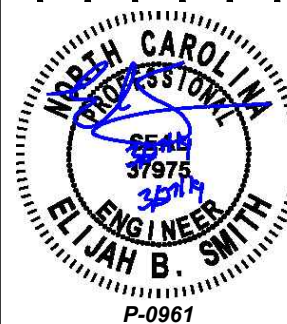

JDS
CONSULTING & DESIGN

JDS CONSULTING & DESIGN, PLLC
8600 D JERSEY CT, RALEIGH, NC 27617
919.480.1075

INFO@JDSDESIGNONLINE.COM
WWW.JDSDESIGNONLINE.COM

PROJECT NO.: 19900409
DATE: 3/21/2019

PLAN:
240.2596

GENERAL NOTES

GN1.1

These designs and drawings are CONFIDENTIAL and the exclusive property of KB Home Corporation and are not to be disclosed without the express permission of KB Home Corporation. They may not be used or duplicated without the express permission of KB Home Corporation. Copyright © 2019 KB Home Corporation. All rights reserved.

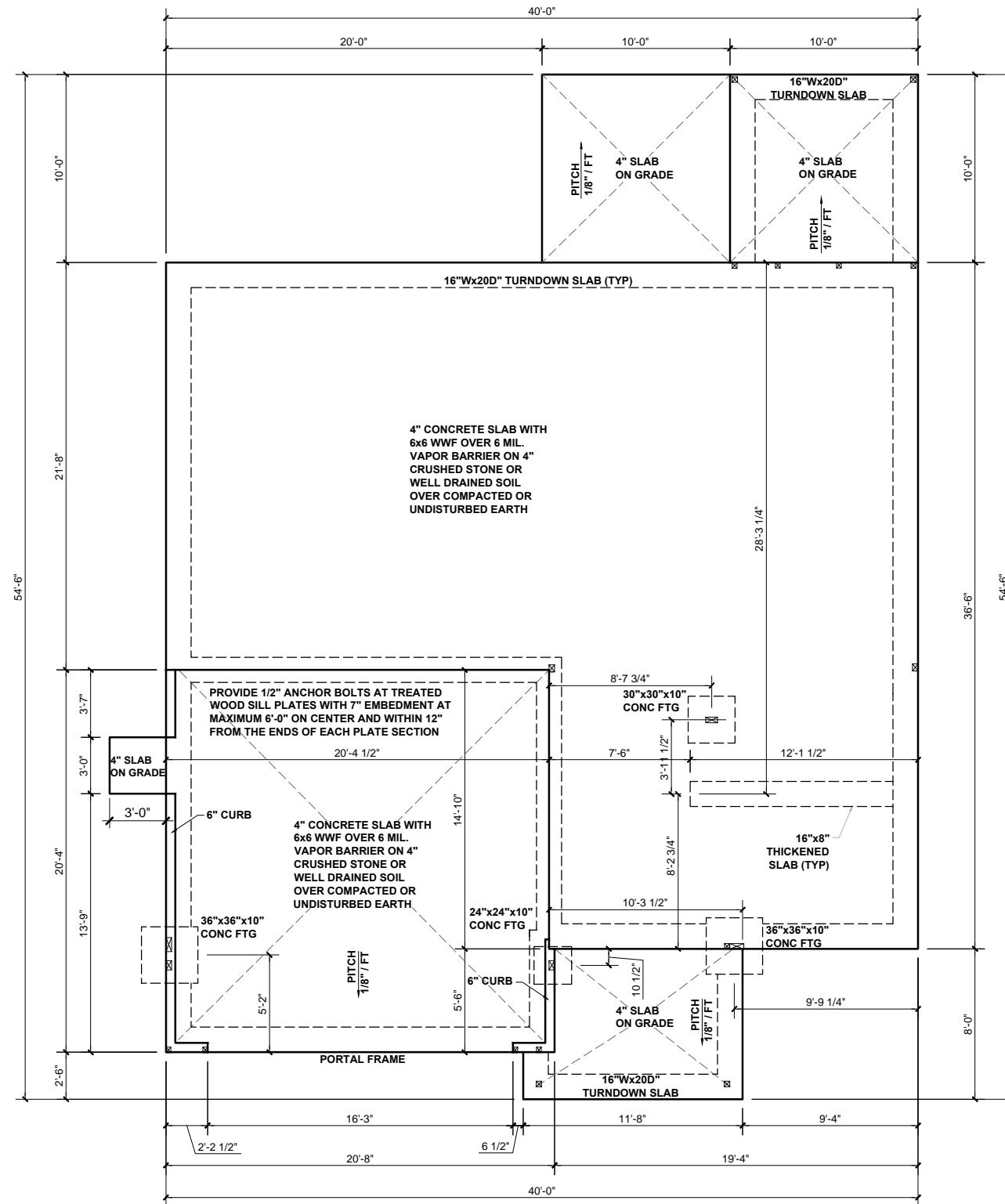

BEAM & POINT LOAD LEGEND	
	INTERIOR LOAD BEARING WALL
	ROOF RAFTER / TRUSS SUPPORT
	DOUBLE RAFTER / DOUBLE JOIST
	STRUCTURAL BEAM / GIRDER
	WINDOW / DOOR HEADER
	POINT LOAD TRANSFER
	POINT LOAD FROM ABOVE BEARING ON BEAM / GIRDER

(1) #5 REBAR @ CENTER OFF ALL PERIMETER AND INTERNAL LOAD BEARING FOOTINGS. (2" C.C. MIN)



KB HOME
NORTH CAROLINA DIVISION
4518 S. MIAMI BLVD.
SUITE 180
DURHAM, NC 27703
TEL: (919) 768-7988
FAX: (919) 472-0582



JDS
CONSULTING & DESIGN
JDS CONSULTING & DESIGN, PLLC
8600 D JERSEY CT, RALEIGH, NC 27617
919.480.1075
INFO@JDSDESIGNONLINE.COM
WWW.JDSDESIGNONLINE.COM

PROJECT NO.: 19900409
DATE: 3/21/2019

PLAN:
240.2596

SLAB
FOUNDATION PLAN
S.10B

SLAB FOUNDATION PLAN - 'B'
SCALE: 1/8" = 1'-0"

These designs and drawings are CONFIDENTIAL and the exclusive property of KB Home Corporation and are not to be disclosed without the express permission of KB Home Corporation. Copyright © 2019 © KB Home Corporation. All rights reserved.



BEAM & POINT LOAD LEGEND	
	INTERIOR LOAD BEARING WALL
	ROOF RAFTER / TRUSS SUPPORT
	DOUBLE RAFTER / DOUBLE JOIST
	STRUCTURAL BEAM / GIRDER
	WINDOW / DOOR HEADER
	POINT LOAD TRANSFER
	POINT LOAD FROM ABOVE BEARING ON BEAM / GIRDER

- STRUCTURAL FRAMING NOTES - (SEE GENERAL NOTES SHEET FOR ADDITIONAL REQUIREMENTS.)**
- ALL FRAMING TO BE #2 SPF MINIMUM.
 - ALL BEARING HEADERS TO BE (2) 2x6 SUPPORTED w/ MIN (1) JACK AND (1) KING EACH END, UNO.
 - EXTERIOR WALL OPENINGS OVER 3' TO HAVE MULTIPLE KING STUDS AS NOTED ON PLAN.
 - ALL NON-BEARING HEADERS TO BE (2) 2x4 (1) J / (1) K, UNO.
 - PROVIDE CONTINUOUS BLOCKING THROUGH STRUCTURE FOR ALL POINT LOADS.
 - ALL HANGERS AND CONNECTORS SPECIFIED ARE TO BE SIMPSON STRONG-TIE OR EQUIVALENT.
 - ALL BEAMS SPECIFIED ARE MINIMUM SIZES ONLY. LARGER MEMBERS MAY SUBSTITUTED AS NEEDED FOR EASE OF CONSTRUCTION. MINIMUM BEAM SUPPORT IS (1) 2x4 STUD.
 - ALL EXTERIOR WALLS TO BE FULLY SHEATHED WITH 7/16" OSB.
 - FRONT PORCH COLUMNS TO BE MIN 4x4 PT ATTACHED AT TOP AND BOTTOM USING SIMPSON (OR EQUIV) COLUMN BASE OR SST A24 BRACKETS. TRIM OUT PER BUILDER.
 - PORCH COLUMNS TO BE MIN 4x4 PT ATTACHED AT BOTTOM USING SIMPSON (OR EQUIV) ABA44 AND AT TOP USING CS 16 STRAPPING (12" MIN) TO PORCH HEADER / BAND.
 - WHEN A 4-PLY LVL IS USED, ATTACH WITH (1) 1/2" Ø BOLT 12" OC STAGGERED, TOP AND BOTTOM. 1-1/2" MIN FROM ENDS. ALTERNATE ATTACHMENT EQUIVALENT METHOD MAY BE USED, SUCH AS SDW OR TRUSSLOK SCREWS (SEE MANUFACTURER'S SPECIFICATIONS).
 - FOR STUD COLUMNS OF 4 OR MORE, INSTALL SST CS16 STRAPS @ 30" OC, 6" MAX FROM PLATES, ON INSIDE FACE OF COLUMN (EXTERIOR WALL), ON BOTH FACES OF COLUMN (INTERIOR WALL).



I-JOIST SPACING NOT TO EXCEED 19.2" OC IN LOCATIONS WITH TILE FINISH FLOOR

ALL FLUSH BEAMS TO BE DIRECTLY SUPPORTED BY (2) 2X STUDS UNLESS OTHERWISE NOTED. STUD COLUMNS TO BE SUPPORTED BY SOLID BLOCKING TO FOUNDATION OR TO BEARING COMPONENT BELOW.

JDS
CONSULTING & DESIGN

JDS CONSULTING & DESIGN, PLLC
8600 D JERSEY CT, RALEIGH, NC 27617
919.480.1075

INFO@JDSDESIGNONLINE.COM
WWW.JDSDESIGNONLINE.COM

PROJECT NO.: 19900409
DATE: 3/21/2019

PLAN:
240.2596

SECOND FLOOR
CEILING FRAMING PLAN
S2.0B

These designs and drawings are CONFIDENTIAL and the exclusive property of KB Home Corporation and are not to be disclosed without the express permission of KB Home Corporation. Copyright © 2019 KB Home Corporation. All rights reserved.

WHEN INSTALLING PSL COLUMNS
INSTALL PSL SQUASH BLOCKING IN
FLOOR SYSTEM DOWN TO
FOUNDATION BEARING

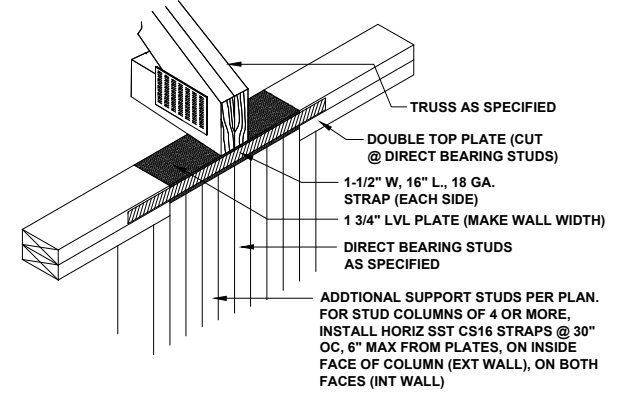

A DIRECT BEARING
TRUSS, SINGLE LVL PLATE
NTS

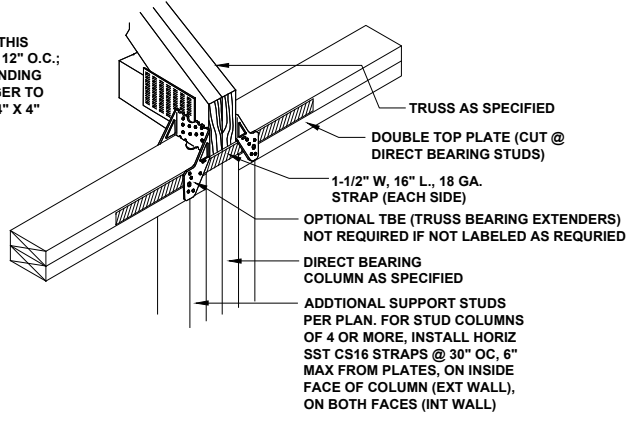
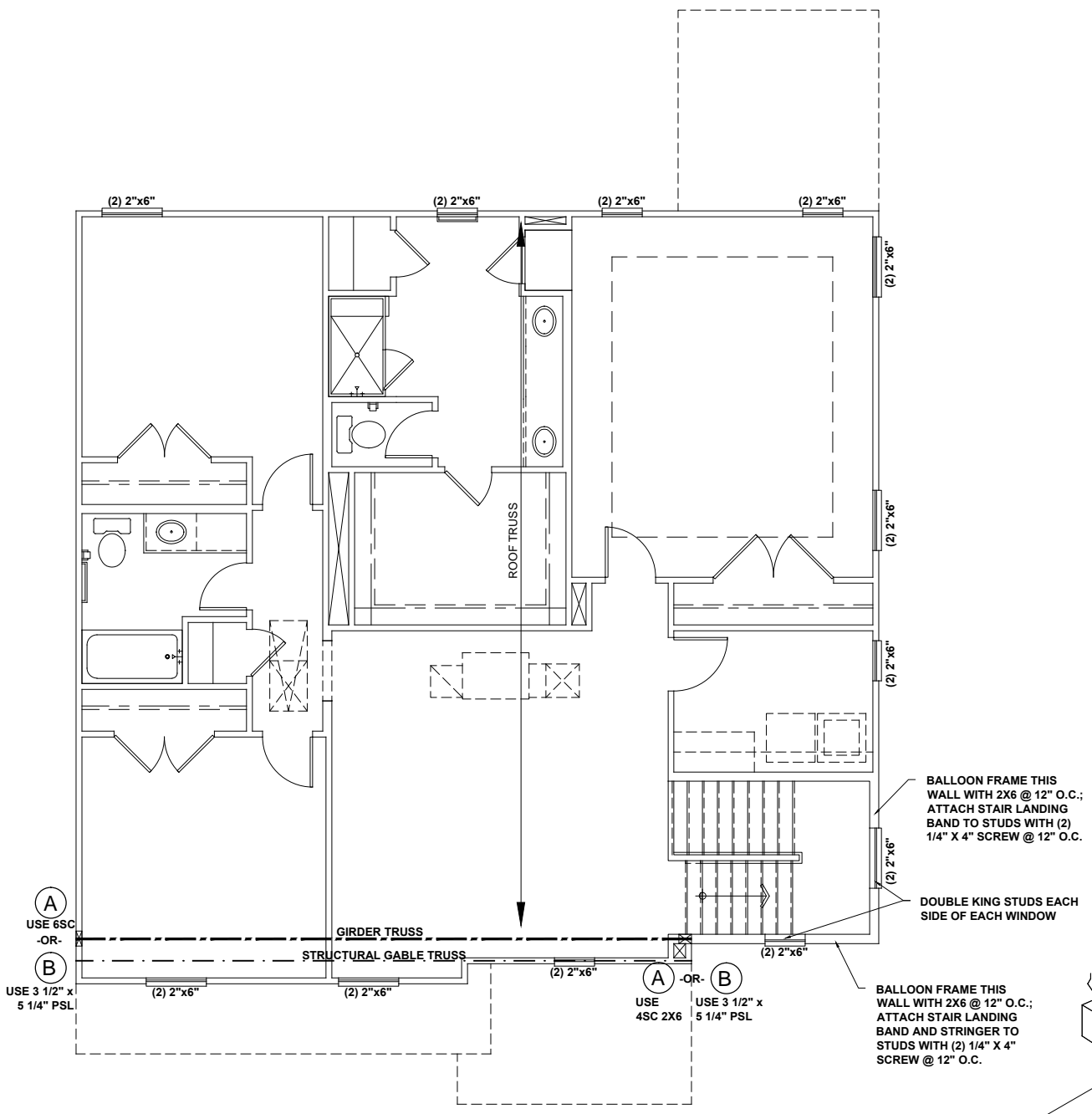

B DIRECT BEARING
TRUSS
NTS

SECOND FLOOR CEILING FRAMING PLAN - 'B'
SCALE: 1/8" = 1'-0"

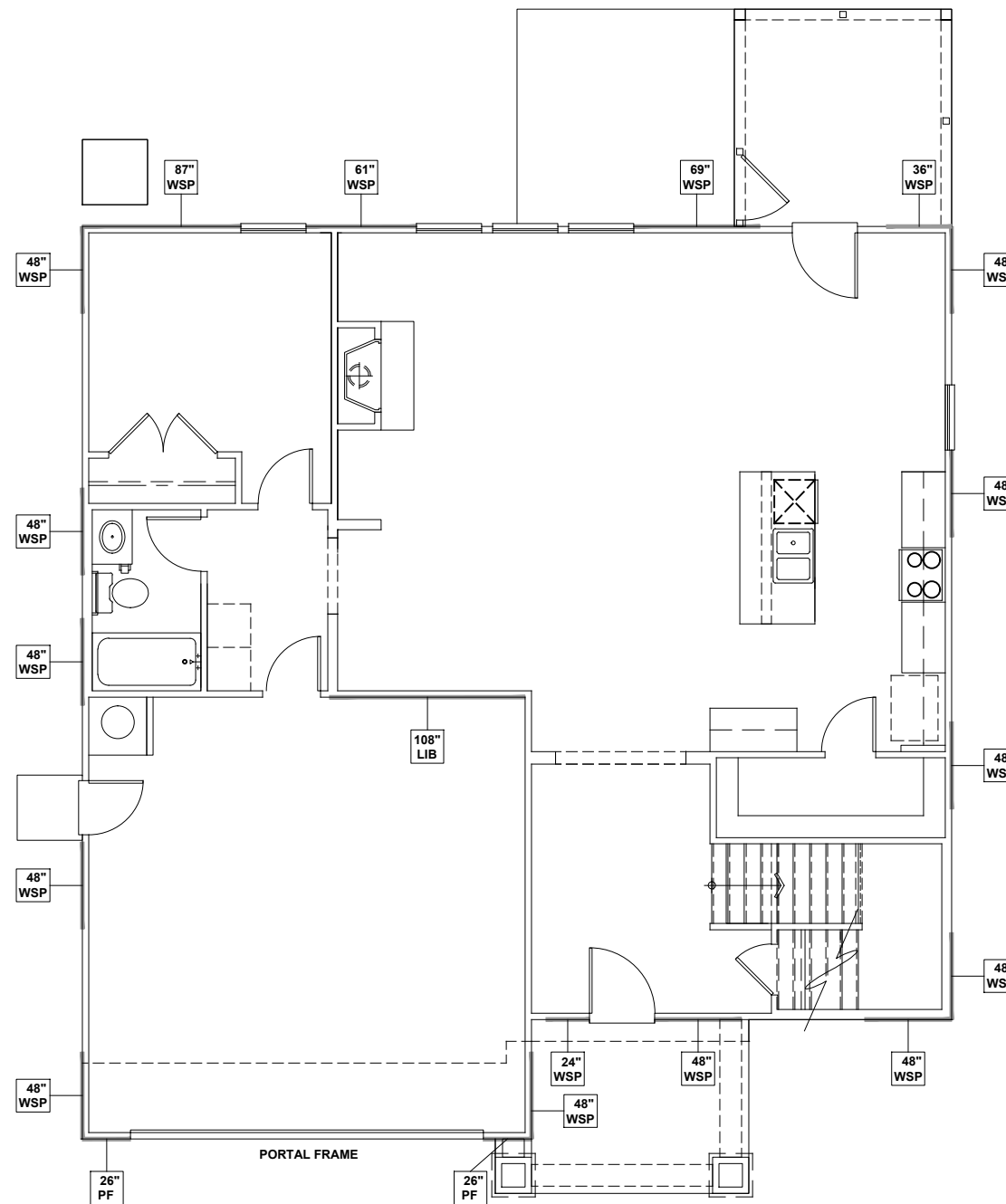

FIRST FLOOR WALL BRACING PLAN - 'B'
 SCALE: 1/8"=1'-0"

WALL BRACING REQUIREMENTS

- MINIMUM PANEL WIDTH IS 24"
- FIGURES BASED ON THE CONTINUOUS SHEATHING METHOD USING THE RECTANGLE CIRCUMSCRIBED AROUND THE FLOOR PLAN OR PORTION OF THE FLOOR PLAN. IF NO RECTANGLE IS NOTED, THE STRUCTURE HAS BEEN FIGURED ALL WITHIN ONE RECTANGLE.
- PANELS MAY SHIFT UP TO 36" EITHER DIRECTION FOR EASE OF CONSTRUCTION (NAILING & BLOCK REQUIREMENTS STILL APPLY).
- FOR ADDITIONAL WALL BRACING INFORMATION, REFER TO WALL BRACING DETAIL SHEET(S).
- SCHEMATIC BELOW INDICATES HOW SIDES OF RECTANGLE ARE TO BE INTERPRETED IN BRACING CHART WHEN APPLIED TO STRUCTURE:

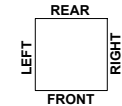

- ◆ CS16 STRAP FROM STUD, CROSS HEADER, TO WALL TOP PLATE, 36" LONG MINIMUM
- ▶ SIMPSON MSTA15 HOLD DOWN CAPACITY OF 970 POUNDS PER ANCHOR WITH (12) 10d NAILS. STRAP TO BE LOCATED AT EDGE OF BRACED WALL PANEL. (CS16 STRAPPING MAY BE SUBSTITUTED w/ SIMILAR LENGTH AND NAILING PATTERN.) USE HTT4 FOR ATTACHMENT TO CONCRETE.

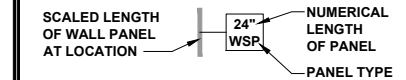

WALL BRACING NOTE:

WALLS WITH REQUIRED LENGTH LISTED AS "N/A" DO NOT MEET THE REQUIREMENTS OF PRESCRIPTIVE WALL BRACING FOUND IN THE NCRC. THESE WALLS HAVE BEEN ENGINEERED BASED ON DESIGN GUIDELINES ESTABLISHED IN ASCE-07 AND THE NDS: WIND & SEISMIC PROVISIONS SUPPLEMENT.

WALL BRACING: RECTANGLE 1

SIDE	REQUIRED LENGTH	PROVIDED LENGTH
FRONT	17.0 FT.	18.75 FT.
LEFT	17.0 FT.	20.0 FT.
REAR	17.0 FT.	21.08 FT.
RIGHT	17.0 FT.	20.0 FT.

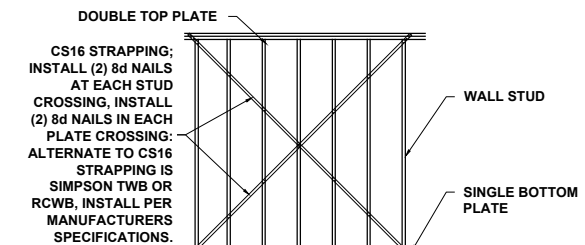

CS16 STRAPPING: INSTALL (2) 8d NAILS AT EACH STUD CROSSING, INSTALL (2) 8d NAILS IN EACH PLATE CROSSING: ALTERNATE TO CS16 STRAPPING IS SIMPSON TWB OR RCWB, INSTALL PER MANUFACTURERS SPECIFICATIONS.

**CROSS BRACED LIB
 CS16 STRAPPING METHOD**

SCALE: 1/4" = 1'-0" STRAP ANGLES TO BE NO MORE THAN 60° AND NO LESS THAN 40°



KB HOME
 NORTH CAROLINA DIVISION
 4518 S. MIAMI BLVD.
 SUITE 180
 DURHAM, NC 27703
 TEL: (919) 768-7988
 FAX: (919) 472-0582

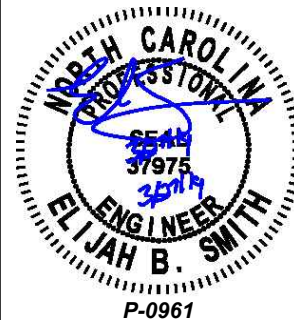

JDS CONSULTING & DESIGN, PLLC
 8600 D' JERSEY CT, RALEIGH, NC 27617
 919.480.1075

INFO@JDSDESIGNONLINE.COM
 WWW.JDSDESIGNONLINE.COM

PROJECT NO.: 19900409
 DATE: 3/21/2019

PLAN:
 240.2596

FIRST FLOOR
 WALL BRACING PLAN

S4.0B

These designs and drawings are CONFIDENTIAL and the exclusive property of KB Home Corporation and are not to be disclosed without the express permission of KB Home Corporation. They may not be used or duplicated without the express permission of KB Home Corporation. Copyright © 2019 © KB Home Corporation, all rights reserved.

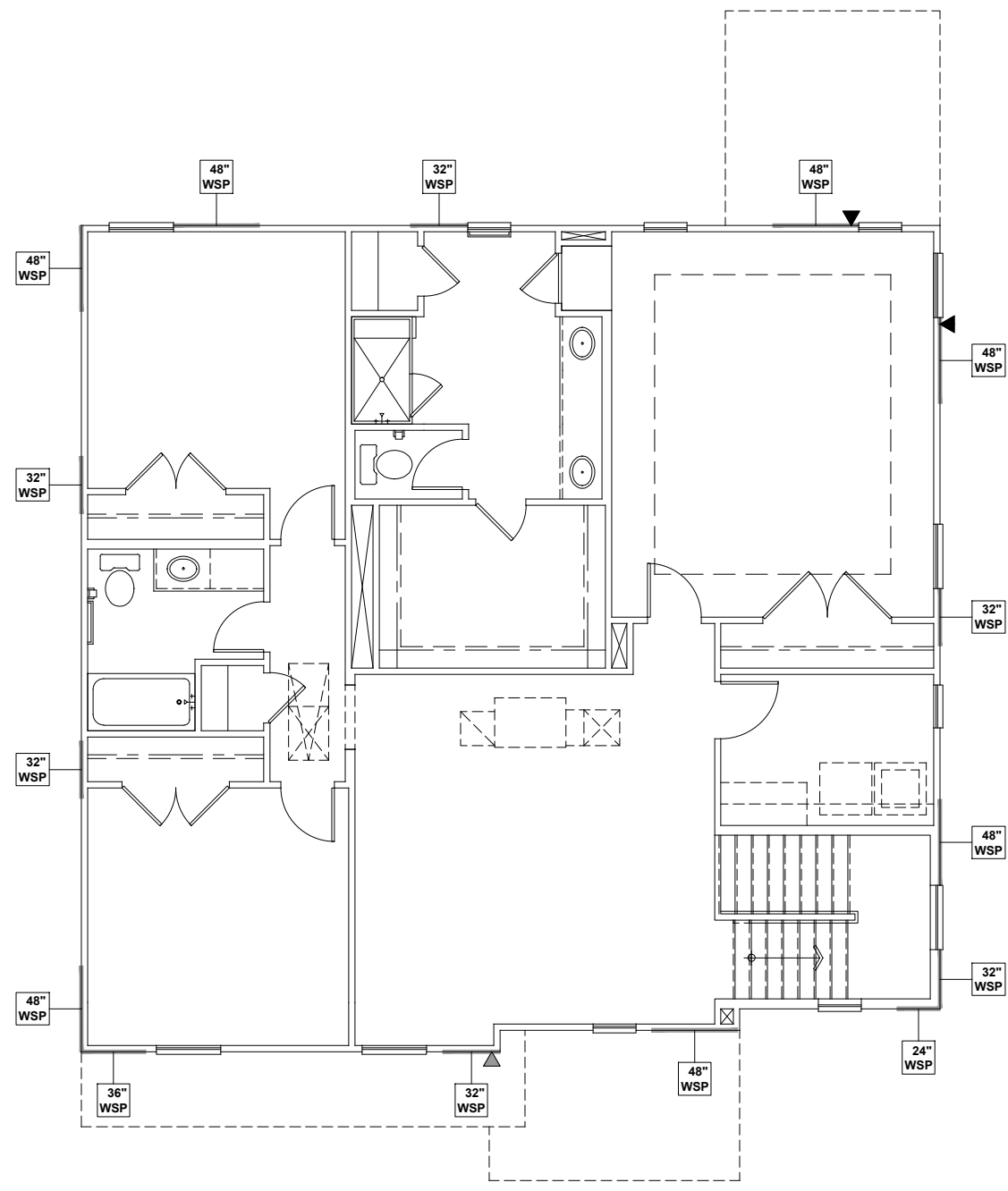

SECOND FLOOR WALL BRACING PLAN - 'B'
 SCALE: 1/8" = 1'-0"

WALL BRACING REQUIREMENTS

- MINIMUM PANEL WIDTH IS 24"
- FIGURES BASED ON THE CONTINUOUS SHEATHING METHOD USING THE RECTANGLE CIRCUMSCRIBED AROUND THE FLOOR PLAN OR PORTION OF THE FLOOR PLAN. IF NO RECTANGLE IS NOTED, THE STRUCTURE HAS BEEN FIGURED ALL WITHIN ONE RECTANGLE.
- PANELS MAY SHIFT UP TO 36" EITHER DIRECTION FOR EASE OF CONSTRUCTION (NAILING & BLOCK REQUIREMENTS STILL APPLY).
- FOR ADDITIONAL WALL BRACING INFORMATION, REFER TO WALL BRACING DETAIL SHEET(S).
- SCHEMATIC BELOW INDICATES HOW SIDES OF RECTANGLE ARE TO BE INTERPRETED IN BRACING CHART WHEN APPLIED TO STRUCTURE:

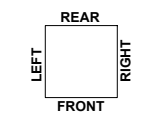

- ◆ CS16 STRAP FROM STUD, CROSS HEADER, TO WALL TOP PLATE, 36" LONG MINIMUM
- ▶ SIMPSON MSTA15 HOLD DOWN CAPACITY OF 970 POUNDS PER ANCHOR WITH (12) 10d NAILS. STRAP TO BE LOCATED AT EDGE OF BRACED WALL PANEL. (CS16 STRAPPING MAY BE SUBSTITUTED w/ SIMILAR LENGTH AND NAILING PATTERN.) USE HTT4 FOR ATTACHMENT TO CONCRETE.

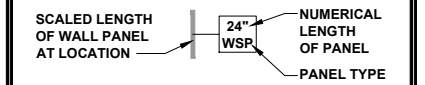

WALL BRACING NOTE:

WALLS WITH REQUIRED LENGTH LISTED AS "N/A" DO NOT MEET THE REQUIREMENTS OF PRESCRIPTIVE WALL BRACING FOUND IN THE NCRC. THESE WALLS HAVE BEEN ENGINEERED BASED ON DESIGN GUIDELINES ESTABLISHED IN ASCE-07 AND THE NDS: WIND & SEISMIC PROVISIONS SUPPLEMENT.

WALL BRACING: RECTANGLE 1

SIDE	REQUIRED LENGTH	PROVIDED LENGTH
FRONT	9.0 FT.	11.66 FT.
LEFT	9.0 FT.	13.33 FT.
REAR	9.0 FT.	10.66 FT.
RIGHT	9.0 FT.	13.33 FT.



KB HOME
 NORTH CAROLINA DIVISION
 4518 S. MIAMI BLVD.
 SUITE 180
 DURHAM, NC 27703
 TEL: (919) 768-7988
 FAX: (919) 472-0582

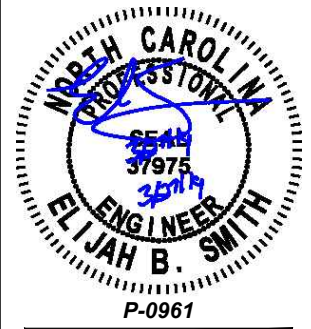

JDS
 CONSULTING & DESIGN
 JDS CONSULTING & DESIGN, PLLC
 8600 D' JERSEY CT, RALEIGH, NC 27617
 919.480.1075
 INFO@JDSDESIGNONLINE.COM
 WWW.JDSDESIGNONLINE.COM

PROJECT NO.: 19900409
 DATE: 3/21/2019

PLAN:
240.2596

SECOND FLOOR
 WALL BRACING PLAN
S5.0B

These designs and drawings are CONFIDENTIAL and the exclusive property of KB Home Corporation and are not to be disclosed without the express permission of KB Home Corporation. Copyright © 2019 © KB Home Corporation. All rights reserved.

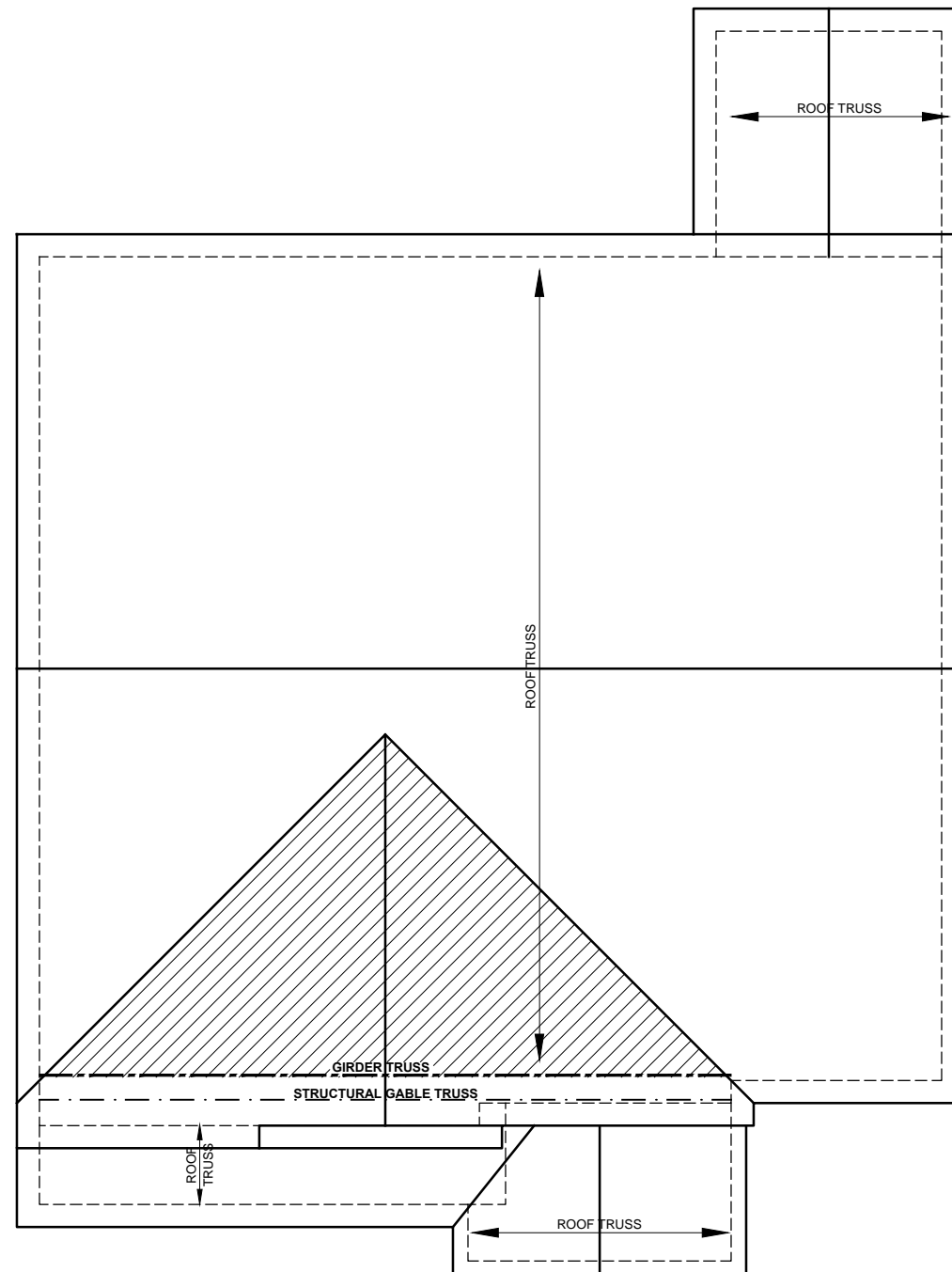

ROOF FRAMING PLAN - 'B'
SCALE: 1/8"=1'-0"

BEAM & POINT LOAD LEGEND

	INTERIOR LOAD BEARING WALL
	ROOF RAFTER / TRUSS SUPPORT
	DOUBLE RAFTER / DOUBLE JOIST
	STRUCTURAL BEAM / GIRDER
	WINDOW / DOOR HEADER
	POINT LOAD TRANSFER
	POINT LOAD FROM ABOVE BEARING ON BEAM / GIRDER

- TRUSSED ROOF - STRUCTURAL NOTES**
1. PROVIDE CONTINUOUS BLOCKING THROUGH STRUCTURE FOR ALL POINT LOADS.
 2. DENOTES OVER-FRAMED AREA
 3. MINIMUM 7/16" OSB ROOF SHEATHING
 4. TRUSS LAYOUT AND PLACEMENT BY MANUFACTURER TO COINCIDE WITH THE SUPPORT LOCATIONS SHOWN. TRUSS PROFILES SHALL BE SEALED BY THE TRUSS MANUFACTURER. TRUSS PLANS TO BE COORDINATED WITH THE SEALED STRUCTURAL DRAWINGS. INSTALLATION SHALL BE IN ACCORDANCE WITH THE MANUFACTURER'S INSTRUCTIONS.
 5. MANUFACTURER TO PROVIDE REQUIRED UPLIFT CONNECTION.
 6. PROVIDE H2.5A (MINIMUM) OR EQUIVALENT AT EACH TRUSS-TO-TOP PLATE CONNECTION AT OVER-FRAMED AREAS, UNLESS NOTED OTHERWISE.
 7. UPLIFT CONNECTION TO BE CARRIED THROUGH TO FLOOR SYSTEM.

ATTIC VENTILATION

THE TOTAL NET-FREE VENTILATION AREA SHALL NOT BE LESS THAN 1/150 OF THE AREA OF THE ATTIC SPACE TO BE VENTILATED. THE TOTAL VENTILATION MAY BE REDUCED TO 1/300 PROVIDED AT LEAST 50% BUT NOT MORE THAN 80% OF THE REQUIRED VENTILATION BE LOCATED IN THE UPPER PORTION OF THE AREA TO BE VENTILATED, OR AT LEAST 3' ABOVE THE SOFFIT VENTILATION INTAKE.

1943	SQUARE FEET OF TOTAL ATTIC / 150 =
12.95	SQUARE FEET OF NET-FREE VENTILATION REQUIRED



KB HOME
NORTH CAROLINA DIVISION
4518 S. MIAMI BLVD.
SUITE 180
DURHAM, NC 27703
TEL: (919) 768-7988
FAX: (919) 472-0582

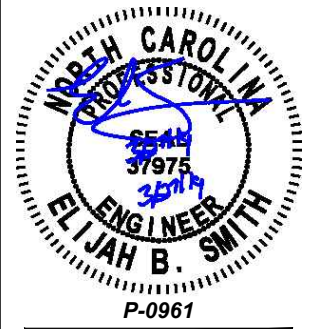

JDS
CONSULTING & DESIGN

JDS CONSULTING & DESIGN, PLLC
8600 D' JERSEY CT, RALEIGH, NC 27617
919.480.1075

INFO@JDSDESIGNONLINE.COM
WWW.JDSDESIGNONLINE.COM

PROJECT NO.: 19900409
DATE: 3/21/2019

PLAN:
240.2596

ROOF FRAMING PLAN
S7.0B

These designs and drawings are CONFIDENTIAL and the exclusive property of KB Home Corporation and are not to be disclosed without the express permission of KB Home Corporation. Copyright © 2019 KB Home Corporation. All rights reserved.

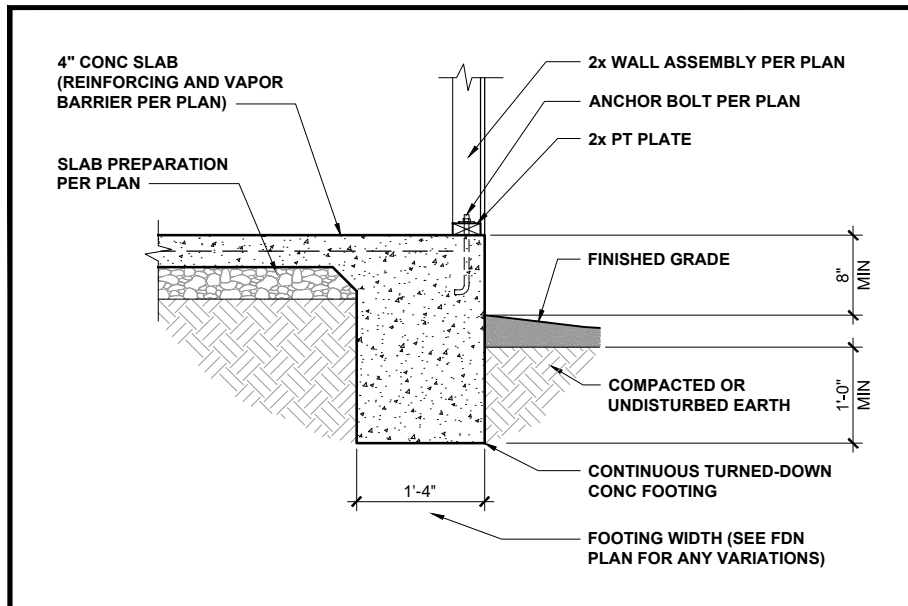

TURNED-DOWN CONC SLAB FOOTING 1/2" = 1'-0" **1**

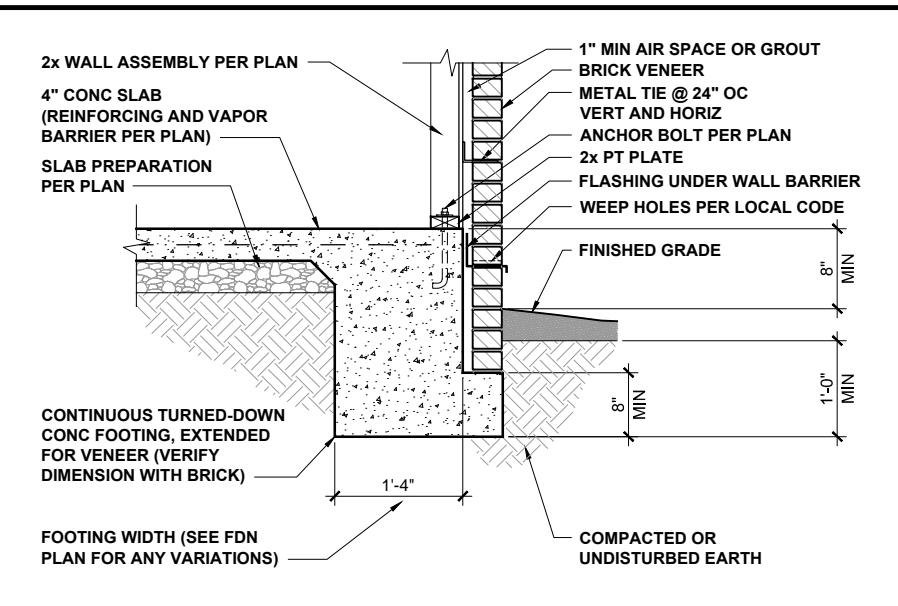

TURNED-DOWN FOOTING w/ BRICK 1/2" = 1'-0" **2**

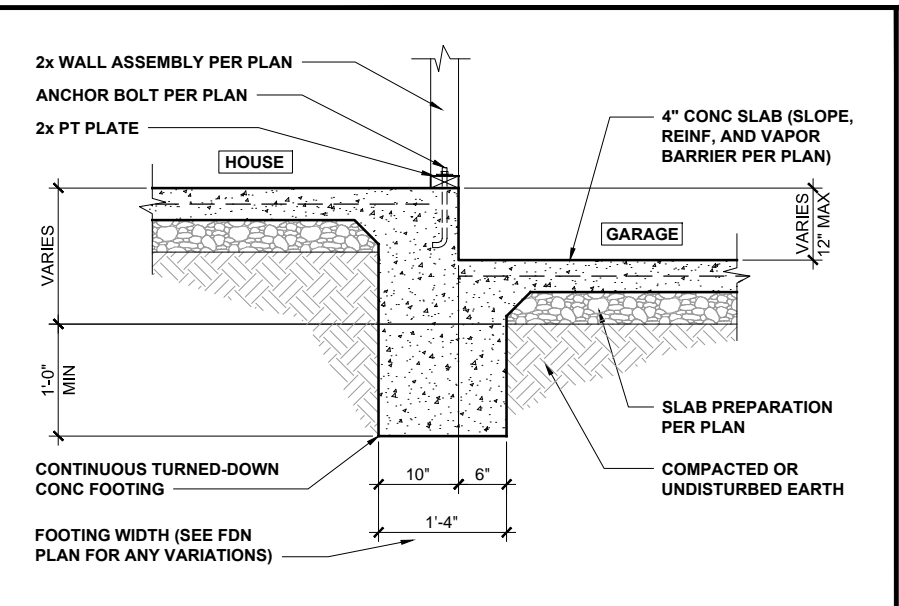

HOUSE / GARAGE FOOTING 1/2" = 1'-0" **3**

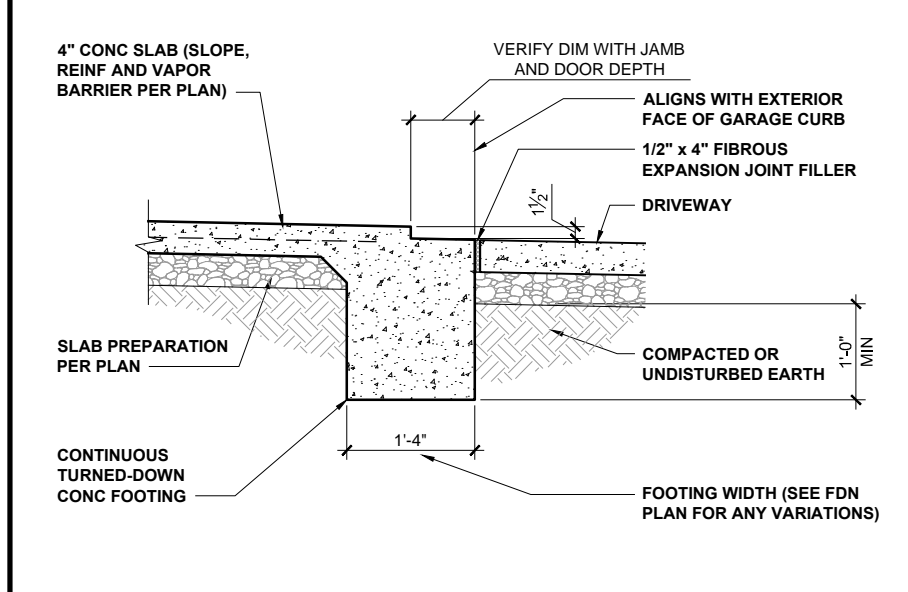

GARAGE DOORWAY FOOTING 1/2" = 1'-0" **4**

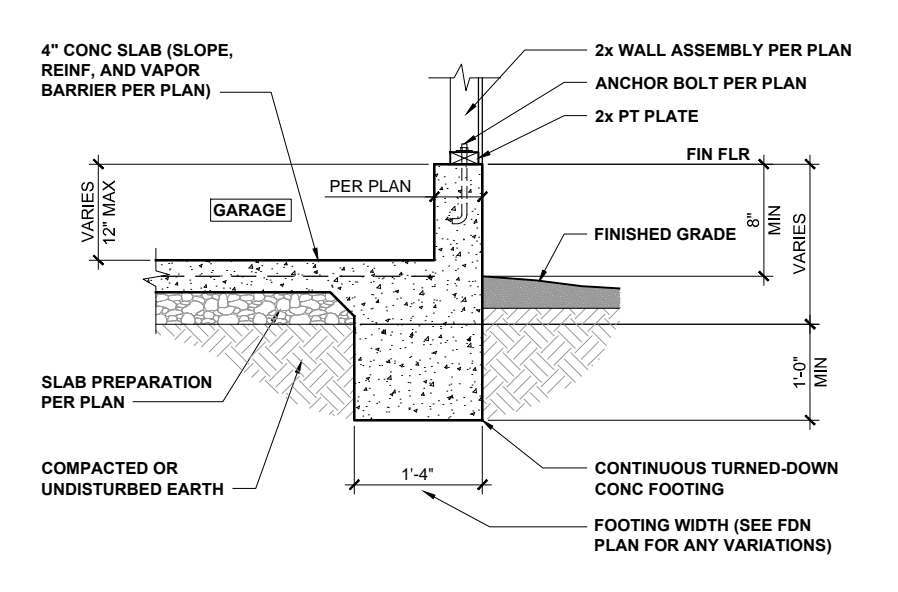

GARAGE FOUNDATION 1/2" = 1'-0" **5**

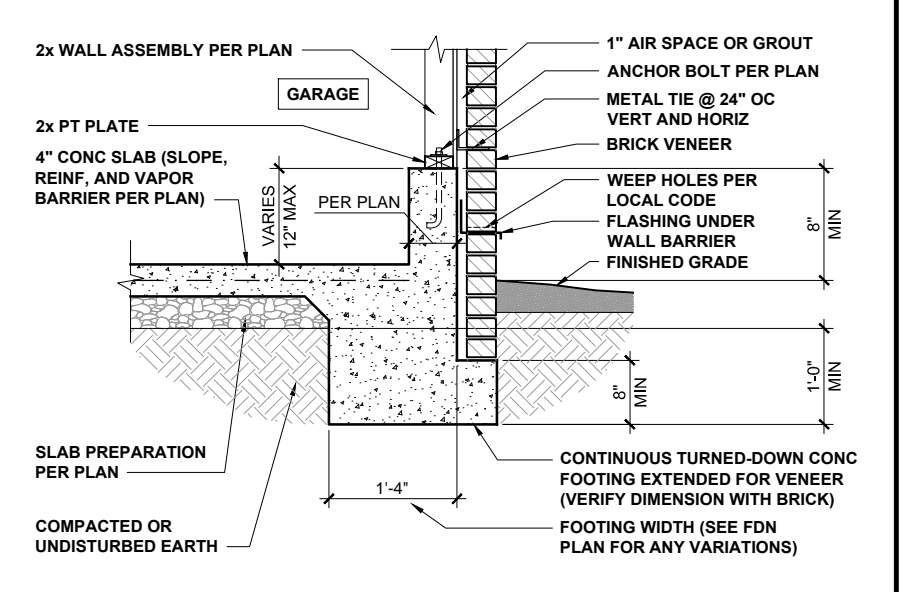

GARAGE FOUNDATION WITH BRICK 1/2" = 1'-0" **6**

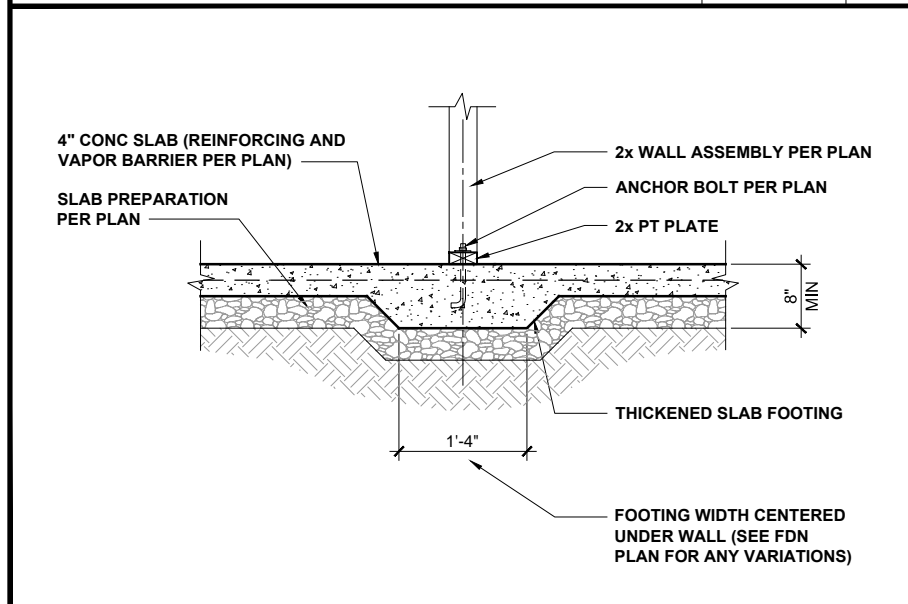

INTERIOR FOOTING 1/2" = 1'-0" **7**

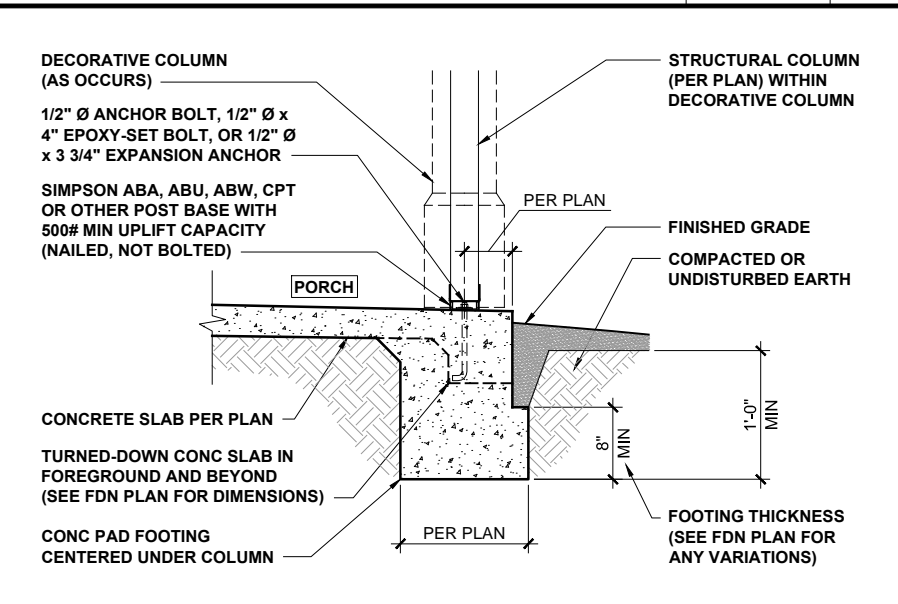

PORCH COLUMN FOUNDATION 1/2" = 1'-0" **8**

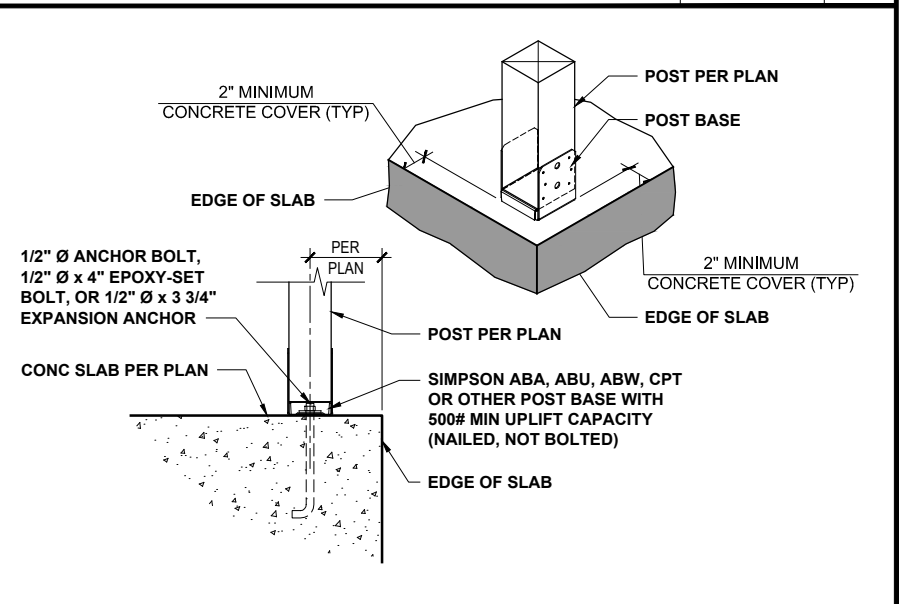

PORCH COLUMN 3/4" = 1'-0" **9**



KB HOME
NORTH CAROLINA DIVISION
4518 S. MIAMI BLVD.
SUITE 180
DURHAM, NC 27703
TEL: (919) 768-7988
FAX: (919) 472-0582

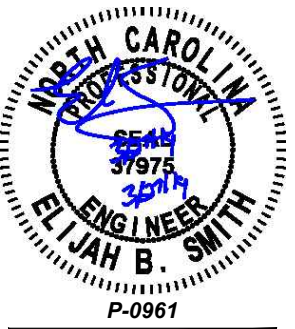

PROJECT NO.: 19900409
DATE: 3/21/2019

PLAN:
240.2596

TURNED-DOWN SLAB
FOUNDATION DETAILS

D1.0

These designs and drawings are CONFIDENTIAL and the exclusive property of KB Home Corporation and are not to be disclosed without the express permission of KB Home Corporation. Copyright © 2019 KB Home Corporation. All rights reserved.

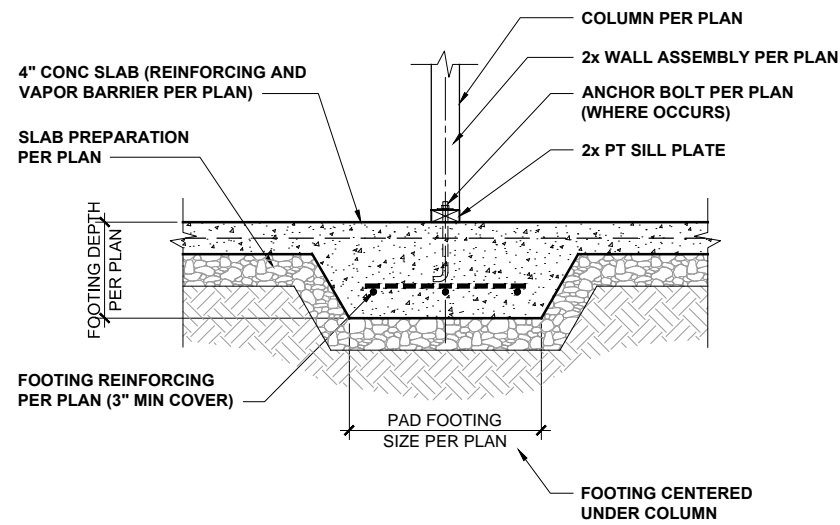

INT POINT-LOAD FOOTING SECTION

1/2" = 1'-0"

1

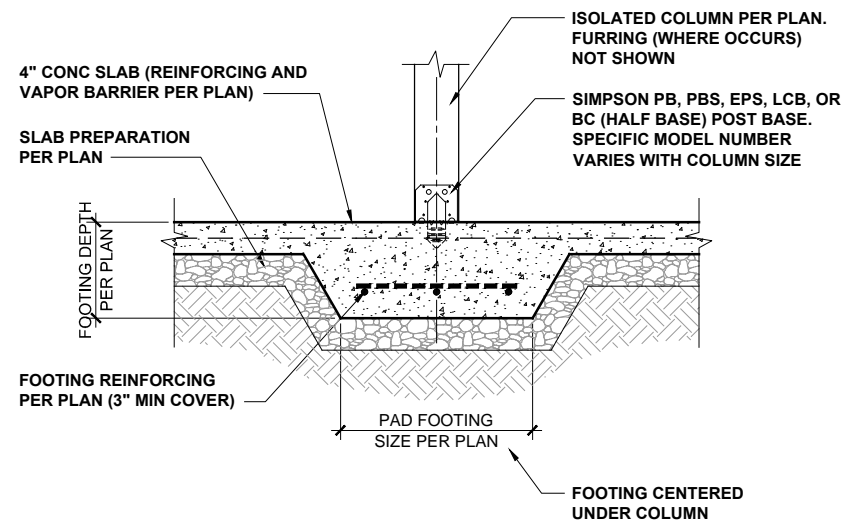

ISOLATED COLUMN FOOTING

1/2" = 1'-0"

2

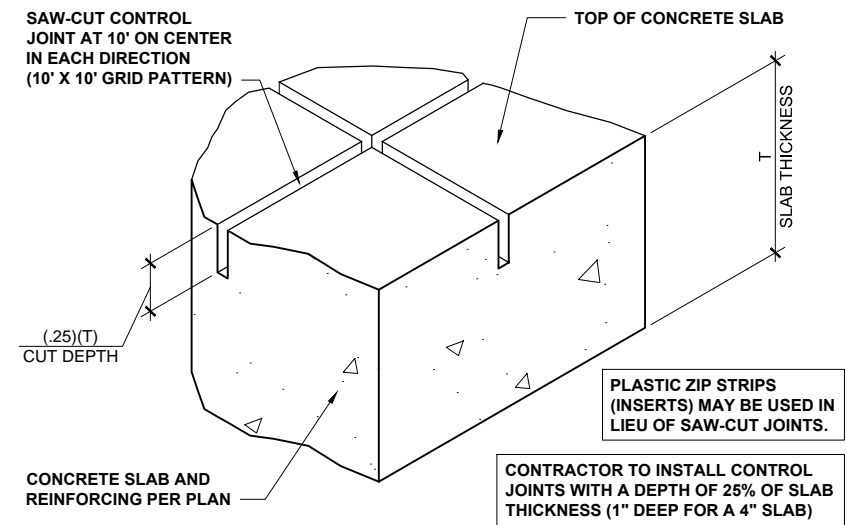

CONCRETE SLAB CONTROL JOINTS

3" = 1'-0"

3



KB HOME
NORTH CAROLINA DIVISION
4518 S. MIAMI BLVD.
SUITE 180
DURHAM, NC 27703
TEL: (919) 768-7988
FAX: (919) 472-0582



JDS CONSULTING & DESIGN, PLLC
8600 D JERSEY CT, RALEIGH, NC 27617
919.480.1075
INFO@JDSDESIGNONLINE.COM
WWW.JDSDESIGNONLINE.COM

PROJECT NO.: 19900409
DATE: 3/21/2019

PLAN:
240.2596

TURNED-DOWN SLAB
FOUNDATION DETAILS

D2.0

These designs and drawings are CONFIDENTIAL and the exclusive property of KB Home Corporation and are not to be disclosed without the express permission of KB Home Corporation. They may not be used or duplicated without the express permission of KB Home Corporation. Copyright © 2019 KB Home Corporation. All rights reserved.

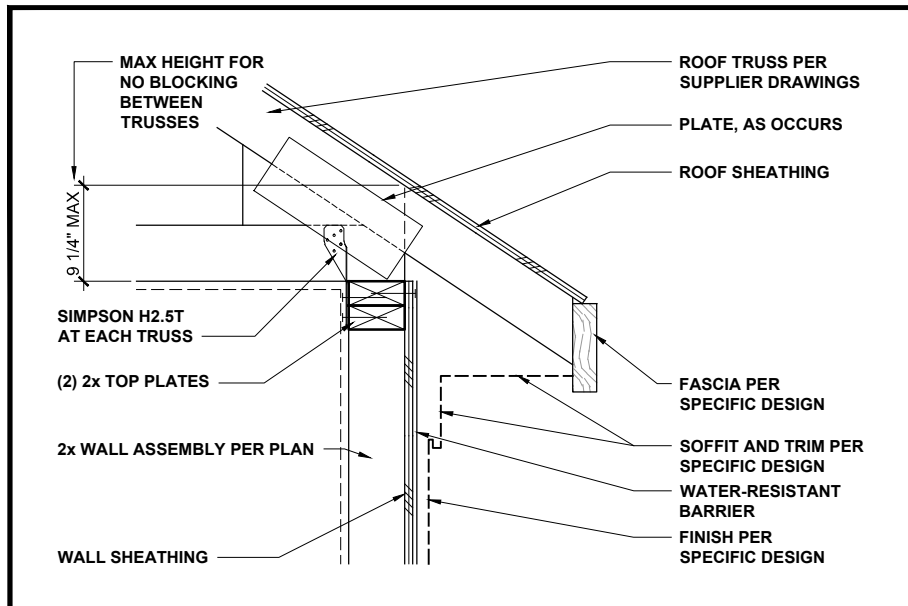

LOW-HEEL TRUSS AT WALL 1" = 1'-0" **1**

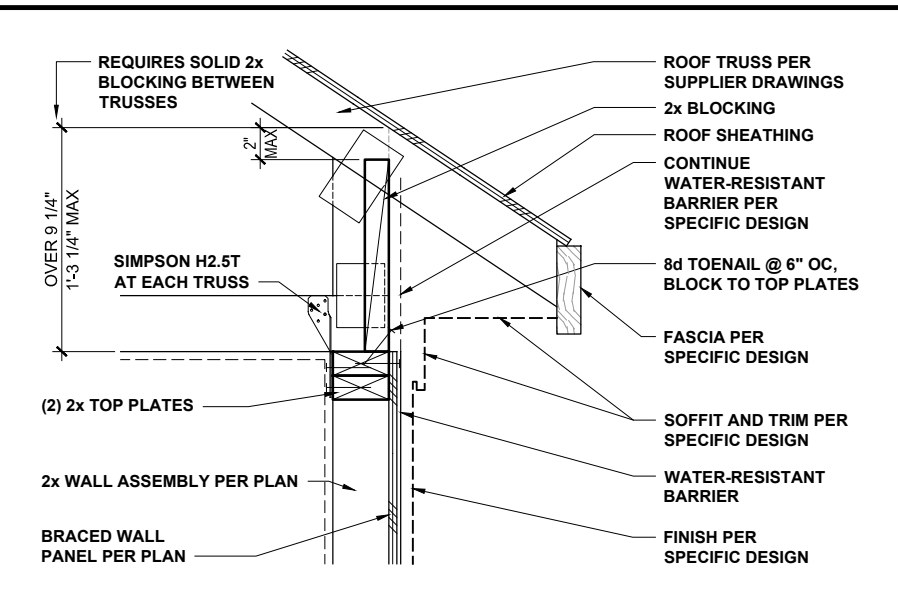

TYPICAL TRUSS AT BRACED WALL 1" = 1'-0" **2**

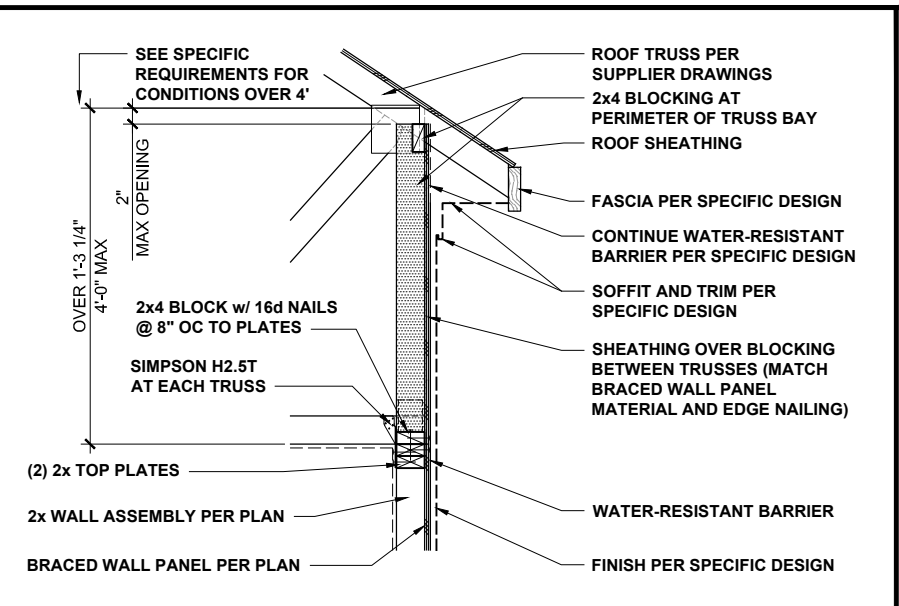

HIGH-HEEL TRUSS AT BRACED WALL 1/2" = 1'-0" **3**

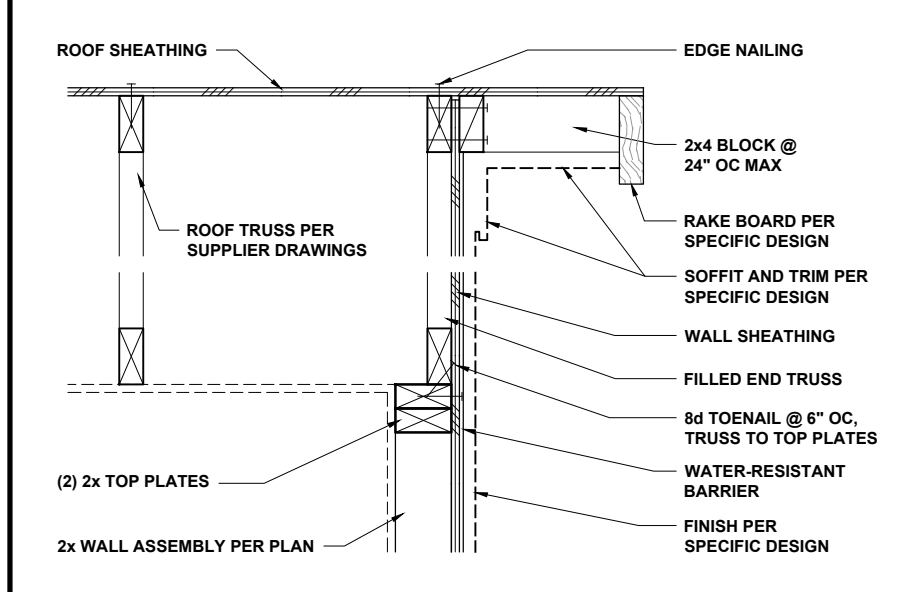

END TRUSS AT WALL 1" = 1'-0" **4**

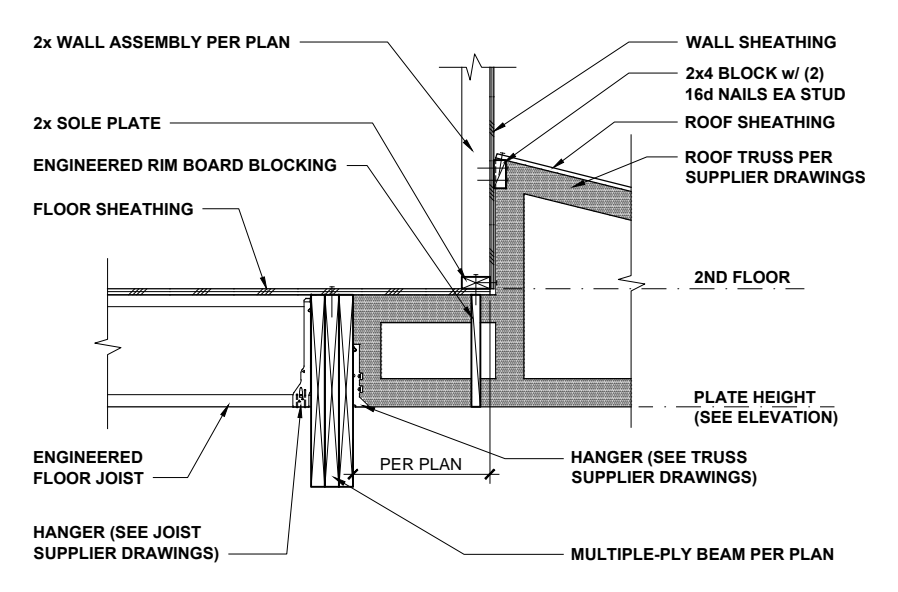

TRUSS AT BEAM AND WALL 1/2" = 1'-0" **5**

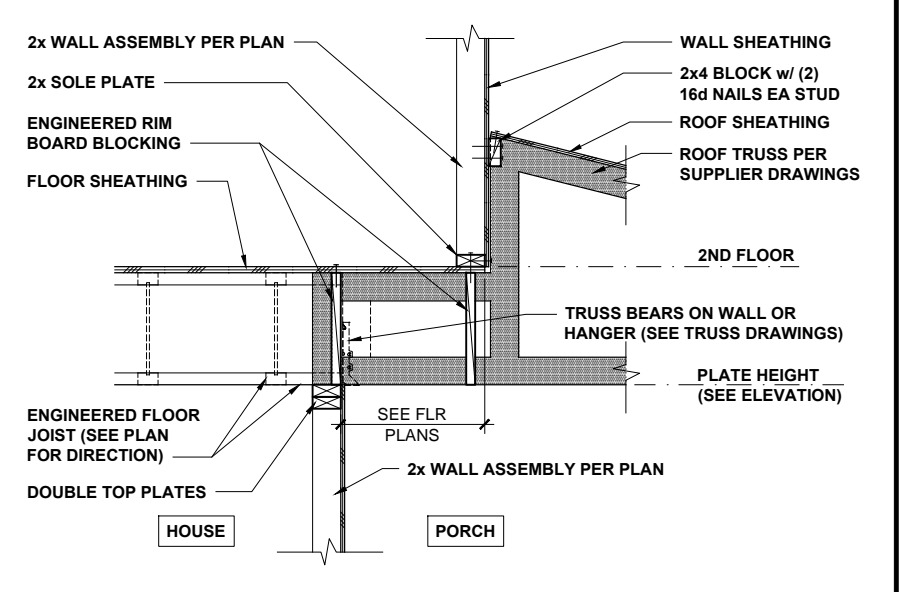

TRUSS AT FLOOR AND WALL 1/2" = 1'-0" **6**

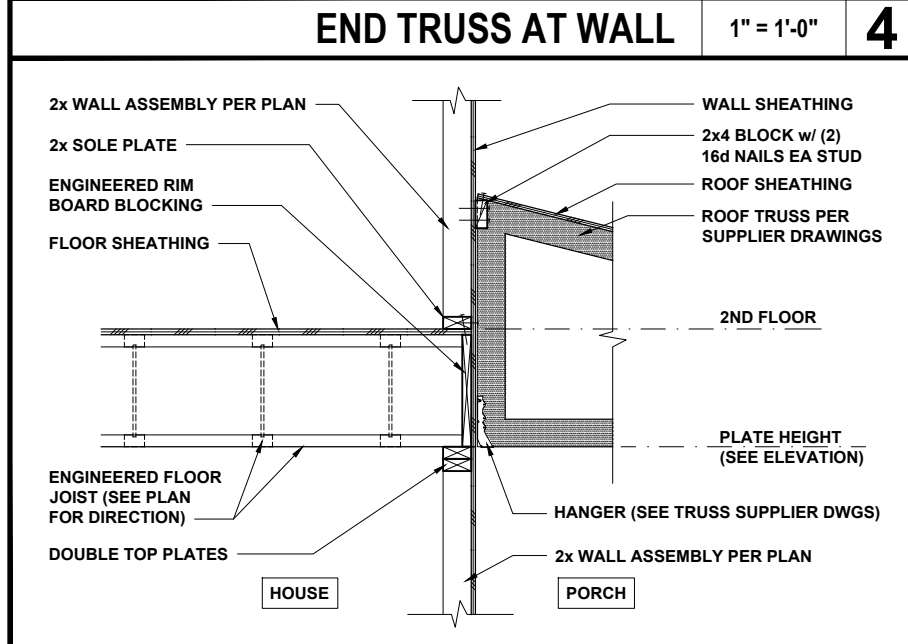

TRUSS AT FLOOR AND WALL 1/2" = 1'-0" **7**

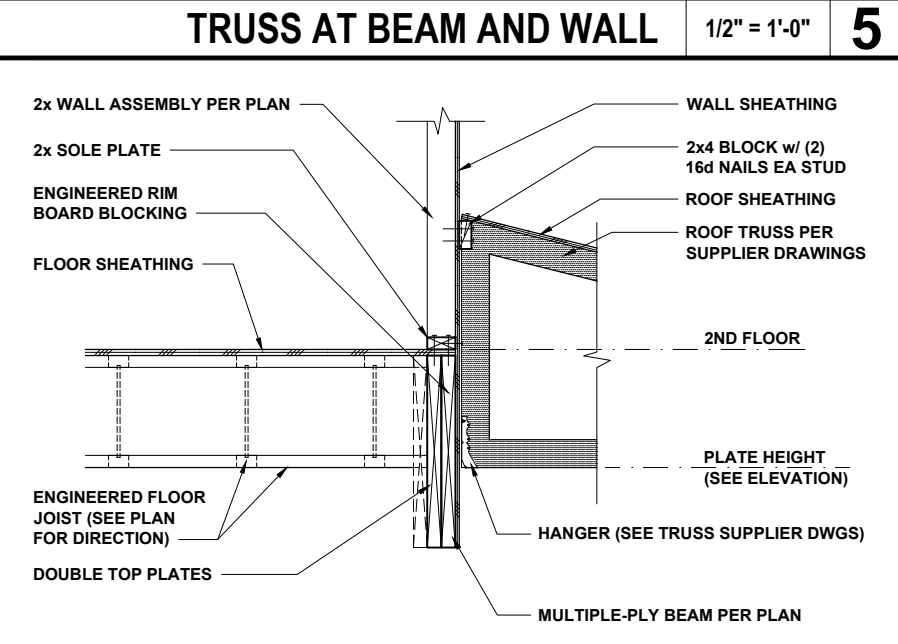

TRUSS AT BEAM AND WALL 1/2" = 1'-0" **8**

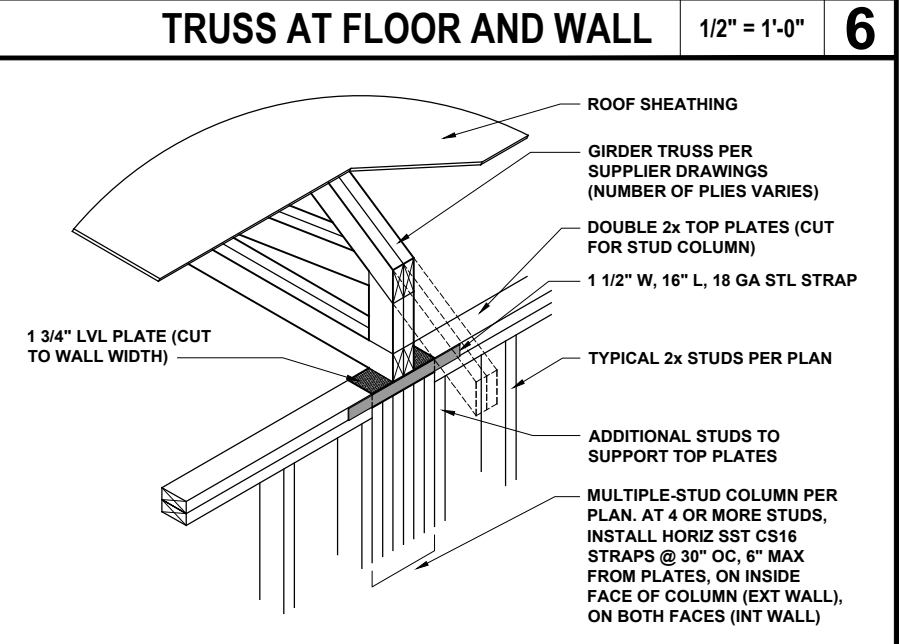

GIRDER TRUSS AT WALL 1/2" = 1'-0" **9**



KB HOME
NORTH CAROLINA DIVISION
4518 S. MIAMI BLVD.
SUITE 180
DURHAM, NC 27703
TEL: (919) 768-7988
FAX: (919) 472-0582

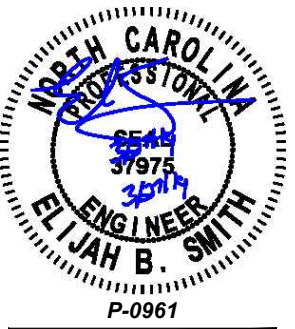

PROJECT NO.: 19900409
DATE: 3/21/2019

PLAN:
240.2596

ROOF TRUSS
FRAMING DETAILS
D10.0

These designs and drawings are CONFIDENTIAL and the exclusive property of KB Home Corporation and are not to be disclosed without the express permission of KB Home Corporation. Copyright © 2019 KB Home Corporation. All rights reserved.



KB HOME
NORTH CAROLINA DIVISION
4518 S. MIAMI BLVD.
SUITE 180
DURHAM, NC 27703
TEL: (919) 768-7988
FAX: (919) 472-0582

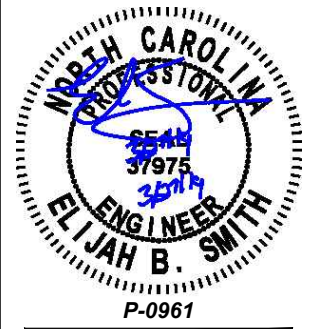

PROJECT NO.: 19900409
DATE: 3/21/2019

PLAN:
240.2596

WALL BRACING DETAILS

D15.0

These designs and drawings are CONFIDENTIAL and the exclusive property of KB Home Corporation and are not to be disclosed without the express permission of KB Home Corporation. They may not be used or duplicated without the express permission of KB Home Corporation. Copyright © 2019 KB Home Corporation. All rights reserved.

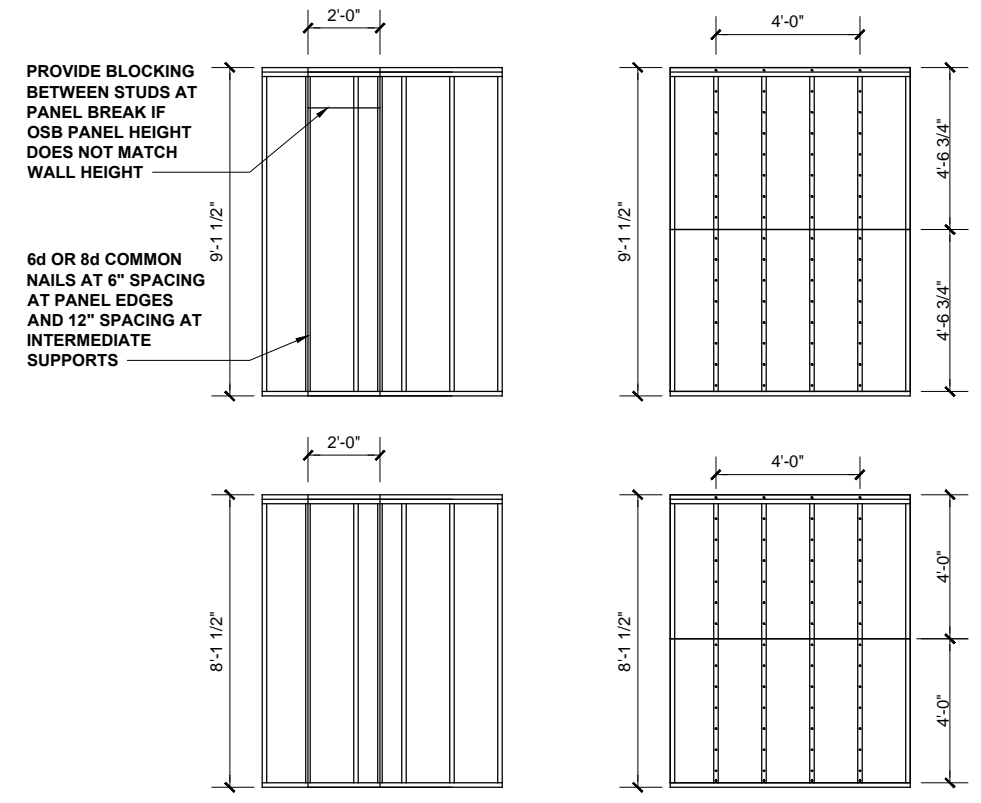
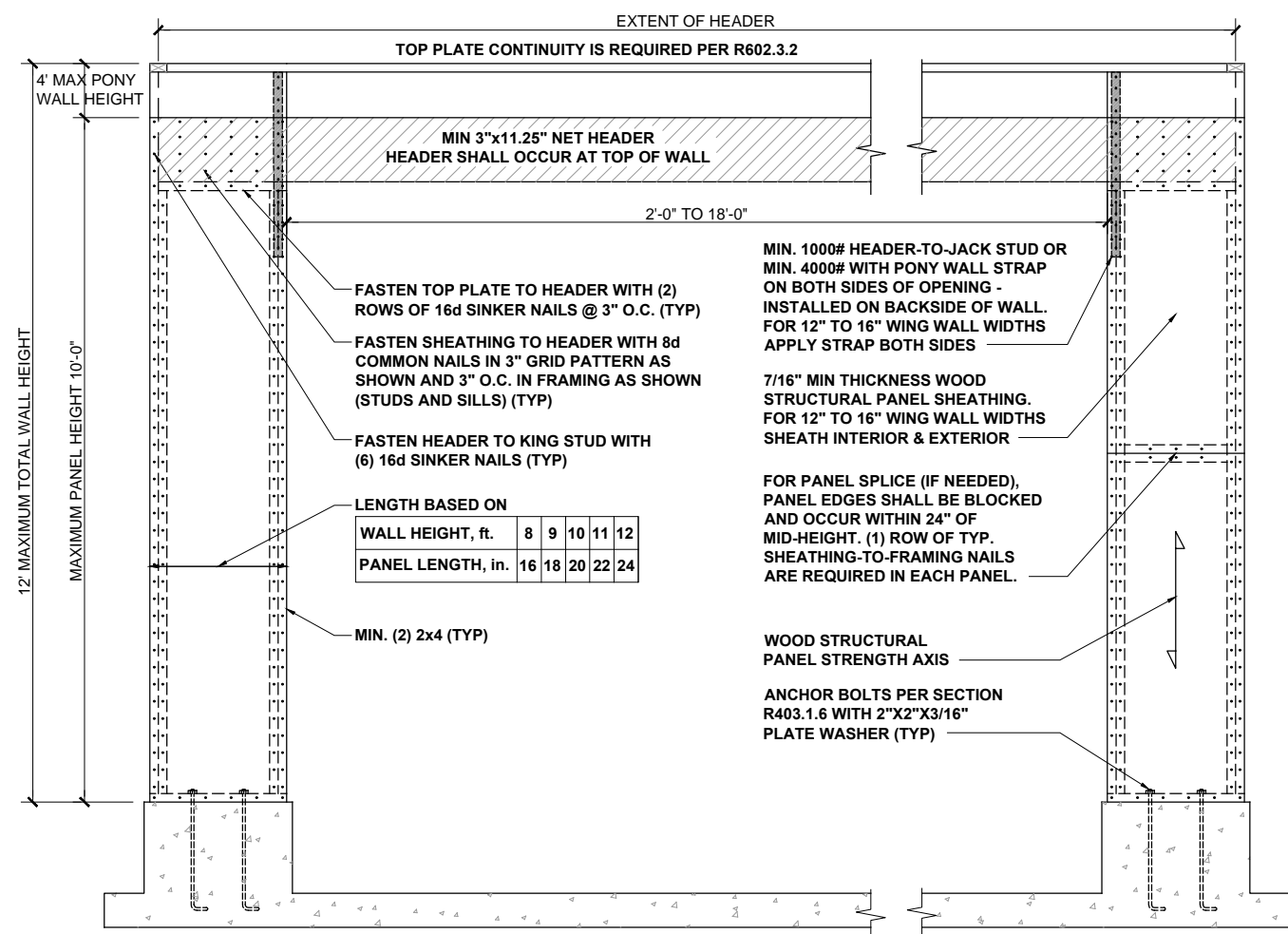

CS-WSP - WOOD STRUCTURAL PANEL (CONTINUOUSLY SHEATHED)

BRACED WALL PANEL 7/16" MIN. OSB SHEATHING ON ONE SIDE OF WALL. MINIMUM PANEL LENGTH 24".

GB - GYPSUM BOARD

BRACED WALL PANEL 1/2" GYPSUM BOARD NAILED TO STUDS AT 7" O.C. USING 5d COOLER NAILS OR #6 SCREWS. MINIMUM PANEL LENGTH 48" WHEN APPLIED TO BOTH SIDES OF WALL AND 96" WHEN APPLIED TO ONE SIDE OF WALL.

HIGH-SPEED WIND ZONES

FOR LOCATIONS OF 130 MPH OR MORE ULTIMATE DESIGN WIND SPEED (110 MPH OR MORE BASIC WIND SPEED IN VIRGINIA AND GEORGIA), WALLS SHALL BE BRACED PER THE LATEST ADOPTED EDITION OF THE AMERICAN SOCIETY OF CIVIL ENGINEERS PUBLICATION ASCE 7 OR STANDARD FOR RESIDENTIAL CONSTRUCTION IN HIGH-WIND REGIONS (ICC 600).

METHOD PF: PORTAL FRAME PANEL CONSTRUCTION

3/8" = 1'-0" **1**

BRACING METHODS

3/16" = 1'-0" **2**

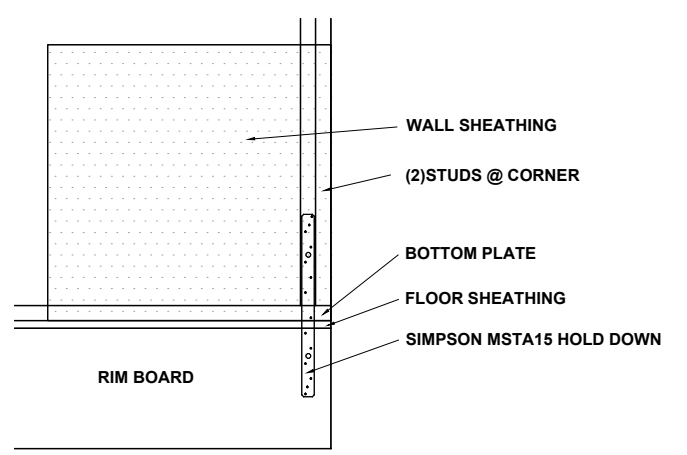

SIMPSON MSTA15 HOLD DOWN CAPACITY OF 970 POUNDS PER ANCHOR WITH (12) 10d NAILS. STRAP TO BE LOCATED AT EDGE OF BRACED WALL PANEL.

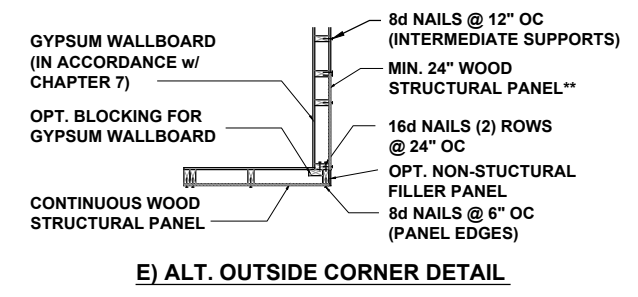
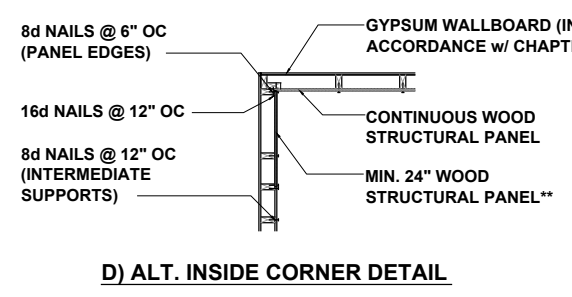
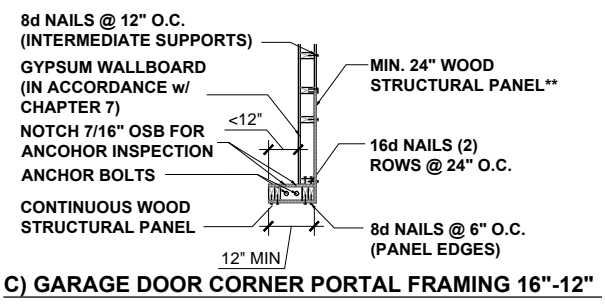
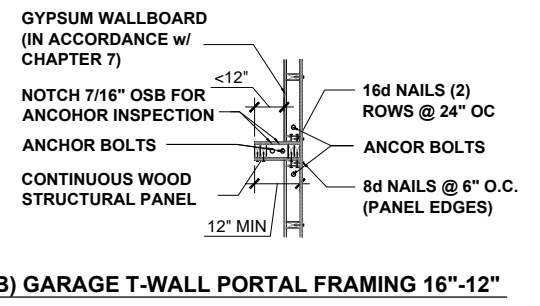
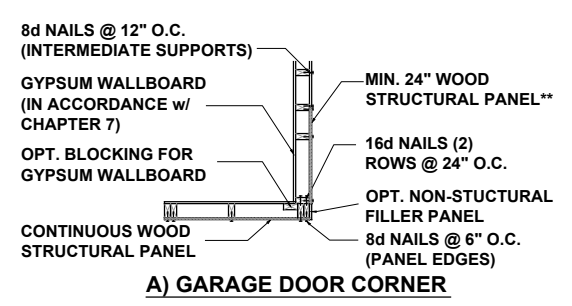

** IN LIEU OF THE CORNER RETURN, A HOLD-DOWN DEVICE WITH A MINIMUM UPLIFT DESIGN VALUE OF 800# SHALL BE FASTENED TO THE CORNER STUD AND TO THE FOUNDATION OR FRAMING BELOW.

BRACED WALL HOLD-DOWN

NTS **3**

CORNER FRAMING FOR CONTINUOUS SHEATHING

1/4" = 1'-0" **4**

JOIST DETAILS

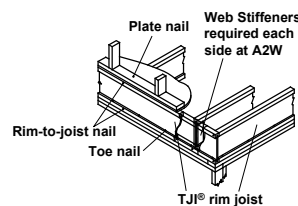

A2 A2W Must have 1 3/4" minimum joist bearing at ends. Attach rim joist per A3 detail.

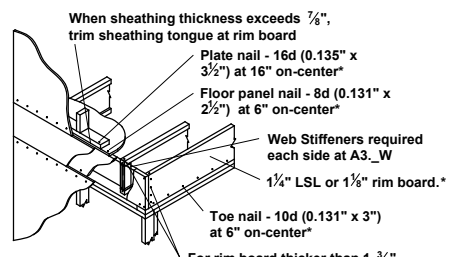

A3 For rim board thicker than 1 3/4" - Attach Joist to rim board with one 10d (0.128"x3") nail. Top nail from joist into rim board. - Connect corner with four 10d (0.128"x3") nails. Toe nail from side of parallel closure into rim board

A3W

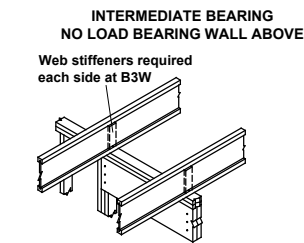

B3 B3W Blocking panels may be required with shear walls above or below (See detail B1)

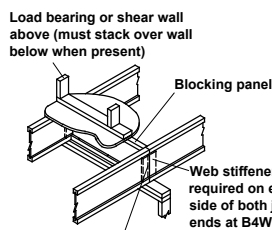

B4 B4W End of joists at centerline of support

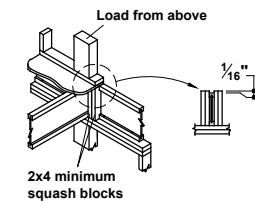

CS Use 2x4 minimum squash blocks to transfer load around joist

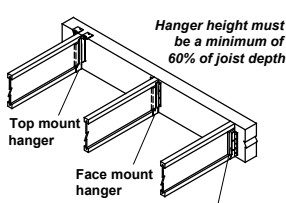

H1 Web stiffeners required if sides of hanger do not laterally support at least 3/8" of joist top flange

FASTENING OF FLOOR PANELS

Guidelines for Closest On-Center Spacing per Row

* SEE I-JOIST EQUIVALENCY CHART

Nail Size	I-JOIST *		Rim Board	1 1/2"	LVL	PSL
	110, 210, and 230 EQ.	360 and 560 EQ.	1/4" LSL	LSL or wider		
8d (0.131" x 2 1/2")	4"	3"	4"	3"	3"	3"
10d (0.148" x 3"), 12d (0.148" x 3 1/4")	4"	4"	4"	4"	4"	4"
16d (0.162" x 3 1/2")	6"	6"	6" (2)	6" (2)	8"	6"

(1) One row of fasteners permitted (two at abutting panel edges) for diaphragms. Stagger nails when using 4" on-center spacing and maintain 3/8" joist and panel edge distance. For other applications, multiple rows of fasteners are permitted if the rows are offset at least 1/2" and staggered.

(2) Can be reduced to 4" on-center if nail penetration into the narrow edge is no more than 1 3/8" (to avoid splitting).

• Recommended nailing is 12" on-center in field and 6" on-center along panel edge. Fastening requirements on engineered drawings supersede recommendations listed above.

• Recommended use of a non-polyurethane subfloor adhesive on all contact points between panels and floor framing.

• Nailing rows must be offset at least 1/2" and staggered.

• 14 ga. staples may be substituted for 8d (0.113" x 2 1/2") nails if minimum penetration of 1" into the joist or rim board is achieved.

• Maximum spacing of nails is 18" on-center for joists.

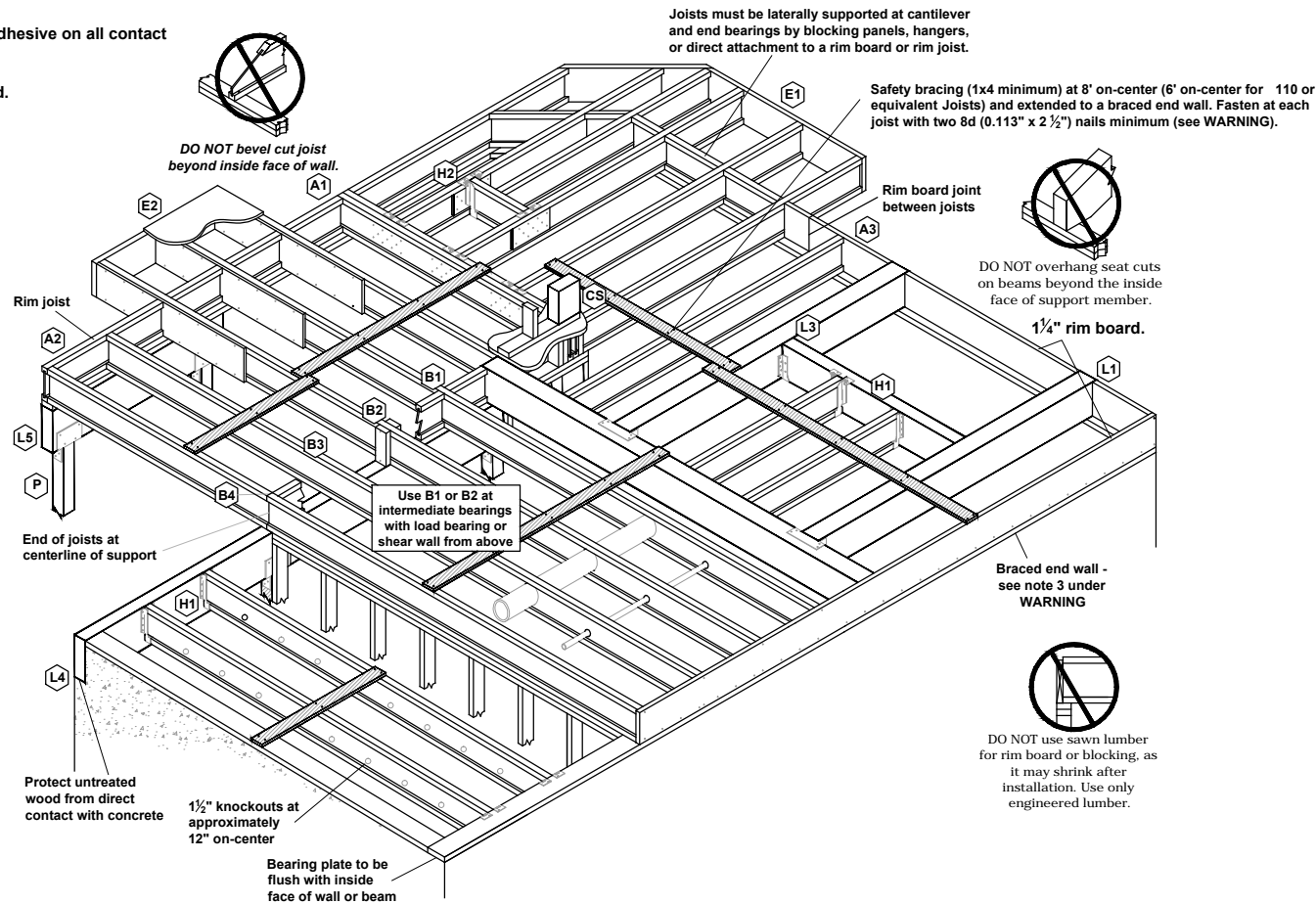

BEAM and COLUMN DETAILS

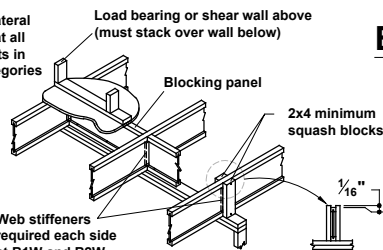

B1 B1W Blocking panels may be required with shear walls above or below - see detail B1

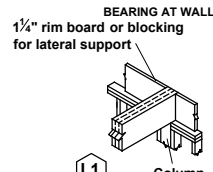

L1

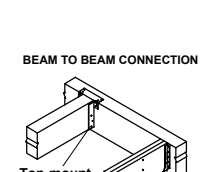

L3

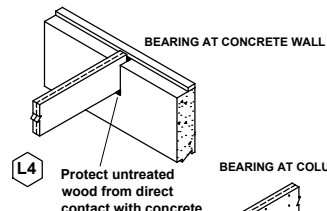

L4

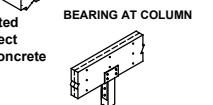

L5 Verify column capacity and beam bearing length.

FILLER and BACKER BLOCK SIZES

* SEE I-JOIST EQUIVALENCY CHART

I-Joists	110 EQ. *		210 EQ. *		230 or 360 EQ. *			560 EQ. *		
	9 1/2" or 11 7/8"	14"	9 1/2" or 11 7/8"	14" or 16"	9 1/2" or 11 7/8"	14" or 16"	18" or 20"	11 7/8"	14" or 16"	18" or 20"
Depth	2x6	2x8	2x6 + 3/8" sheathing	2x8 + 3/8" sheathing	2x6 + 1/2" sheathing	2x8 + 1/2" sheathing	2x12 + 1/2" sheathing	Two 2x6	Two 2x8	Two 2x12
Filler Block (Detail H2)	2x6	2x8	2x6 + 3/8" sheathing	2x8 + 3/8" sheathing	2x6 + 1/2" sheathing	2x8 + 1/2" sheathing	2x12 + 1/2" sheathing	Not applicable	Not applicable	Not applicable
Cantilever Filler (Detail E4)	4'-0" long	6'-0" long	4'-0" long	6'-0" long	4'-0" long	6'-0" long	Not applicable	Not applicable	Not applicable	Not applicable
Backer Block (Detail F1 or H2)	5/8" or 3/4"	3/4" or 7/8"	1" Net			2x6	2x8	2x12		

(1) If necessary, increase filler and backer block height for face mount hangers and maintain 1/8" gap at top of joist; see detail W. Filler and backer block lengths should accommodate required nailing without splitting (12" minimum for backer blocks and 24" minimum for filler blocks).

INSTALLATION TIPS

Subfloor adhesive will improve floor performance, but may not be required.

Squash blocks and blocking panels carry stacked vertical loads (details B1 and B2). Packing out the web of a joist (with web stiffeners) is not a substitute for squash blocks or blocking panels.

When joists are doubled at non-load bearing parallel partitions, space joists apart the width of the wall for plumbing or HVAC.

Additional joist at plumbing drop (see detail).

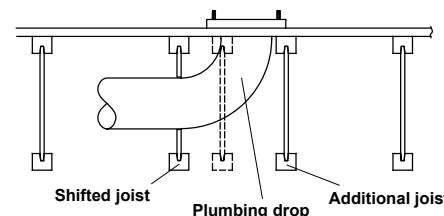

* I-JOIST EQUIVALENCY CHART

Depth	EQUIVALENT IN SPAN AND SPACING		
	Mfrt & Series	Mfrt & Series	Mfrt & Series
9 1/4"	TJI - 110	BCI 4500	
	TJI - 210	BCI 5000	
	TJI - 230	BCI 6000	EverEdge 20
11 7/8"	TJI - 110	BCI 4500	
	TJI - 210	BCI 5000	
	TJI - 230	BCI 6000	EverEdge 20
14"	TJI - 360	BCI 60'S	EverEdge 30
	TJI - 560	BCI 90'S	EverEdge 50/60
	TJI - 110	BCI 4500	
16"	TJI - 210	BCI 5000	
	TJI - 230	BCI 6000	EverEdge 20
	TJI - 360	BCI 60'S	EverEdge 30
	TJI - 560	BCI 90'S	EverEdge 50/60

JOIST NAILING REQUIREMENTS at BEARING

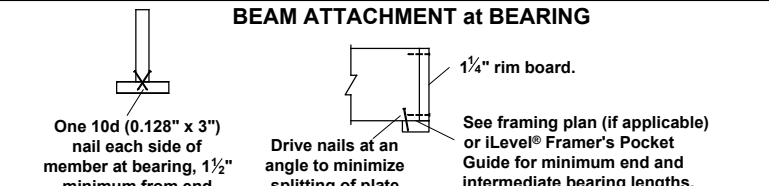
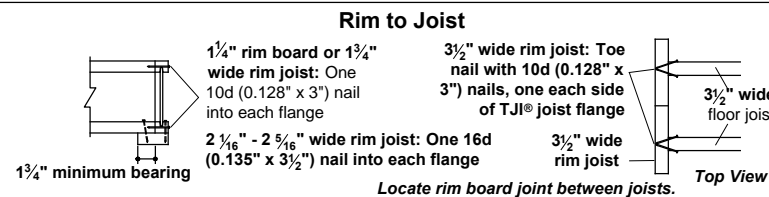
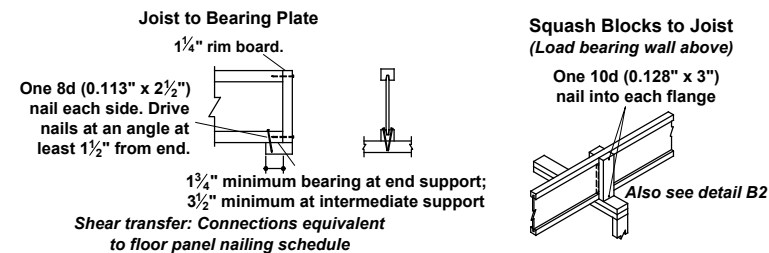

KB HOME
NORTH CAROLINA DIVISION

4518 S. MIAMI BLVD.
SUITE 180
DURHAM, NC 27703
TEL: (919) 768-7988
FAX: (919) 472-0582



JDS CONSULTING & DESIGN, PLLC
8600 D' JERSEY CT, RALEIGH, NC 27617
919.480.1075

INFO@JDSDESIGNONLINE.COM
WWW.JDSDESIGNONLINE.COM

PROJECT NO.: 19900409
DATE: 3/21/2019

PLAN:
240.2596

ENGINEERED JOIST
DETAILS

D16.0

All I-Joist and Versa-Lam Beams
Must be Installed per The
Boise Cascade Installation Guide!

KB Homes
2596 Elev B
Lot 44 Mason Pointe

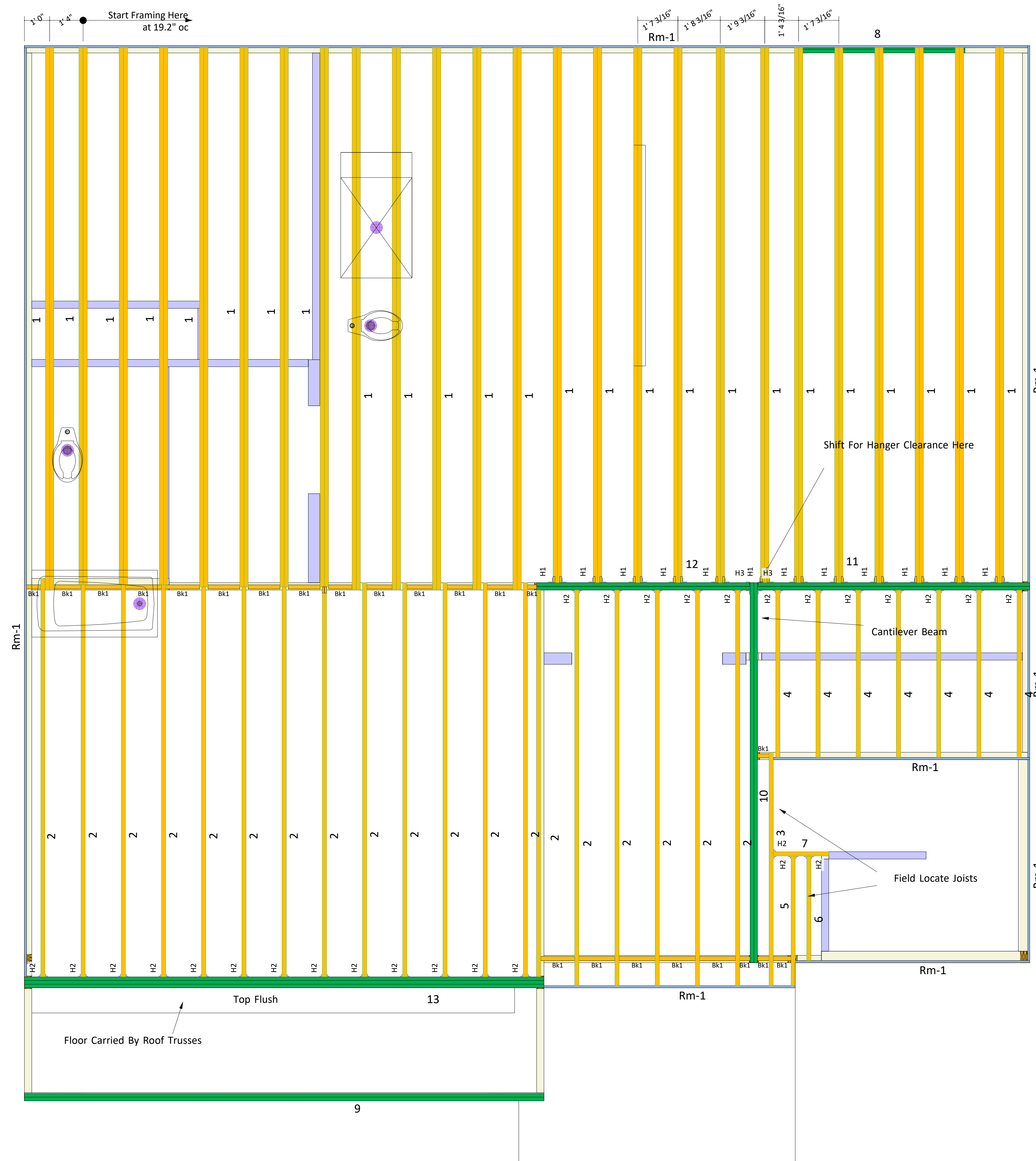

Products				
PlotID	Net Qty	Product	Length	Plies
1	50	14" BCI® 5000s-1.8	22' 0"	2
2	19	14" BCI® 5000s-1.8	16' 0"	1
3	1	14" BCI® 5000s-1.8	10' 0"	1
4	7	14" BCI® 5000s-1.8	7' 0"	1
5	1	14" BCI® 5000s-1.8	6' 0"	1
6	1	14" BCI® 5000s-1.8	5' 0"	1
7	1	14" BCI® 5000s-1.8	3' 0"	1
8	2	1-3/4" x 9-1/4" VERSA-LAM® 2.0 3100 SP	8' 0"	2
9	2	1-3/4" x 11-7/8" VERSA-LAM® 2.0 3100 SP	22' 0"	2
10	2	1-3/4" x 14" VERSA-LAM® 2.0 3100 SP	16' 0"	2
11	2	1-3/4" x 14" VERSA-LAM® 2.0 3100 SP	12' 0"	2
12	2	1-3/4" x 14" VERSA-LAM® 2.0 3100 SP	10' 0"	2
13	3	1-3/4" x 18" VERSA-LAM® 2.0 3100 SP	22' 0"	3
Rm-1	12	1" x 14" BC RIM BOARD OSB	12' 0"	1
Bk1	23	14" BCI® 5000s-1.8	2' 0"	1

Connector Summary			
PlotID	Qty	Manuf	Product
H1	12	Simpson	HU4.12/11
H2	28	Simpson	IUS 2.06/14
H3	2	Simpson	HUCQ412-SDS
BN-6*	33		6" bolt, nut & 2 washers*

Revisions:	BY:

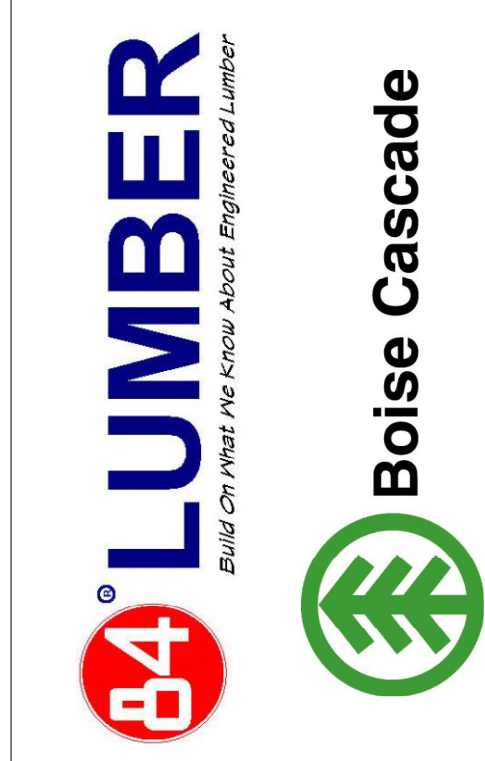

SALES PRESENTATION DRAWING
No structural or dimensional check has been made of this design drawings of the building, therefore, the user is to check all applicable dimensions, quantities, loads, and details carefully. This drawing has not been checked by Boise Engineering.

KB Homes
2596 Elev B
Lot 44 Mason Pointe
84 Lumber EWP

BC FRAMER II
Plan Date: 08132018
Structural Date: 09042018
By: CMM
Sheet: 2/3

Squash Blocks Required
Under The Ends Of All LVL
And Point Loads For Load
Transfer - See Details

ALL DIMENSIONS AND CONDITIONS
TO BE REVIEWED AND APPROVED
BY BOTH THE CONTRACTOR AND
THE ENGINEER OF RECORD
PRIOR TO INSTALLATION

Second Floor Layout

THIS LAYOUT IS INTENDED FOR THE PURPOSE OF TRUSS LOCATION AND PLACEMENT ONLY. REFER TO THE BUILDING PLANS FOR ACTUAL BUILDING CONSTRUCTION.



DEDICATED TO QUALITY AND EXCELLENCE
 200 EMMETT ROAD
 DUNN, NORTH CAROLINA 28334
 PHONE: 910-892-8400
 FAX: 910-892-8384

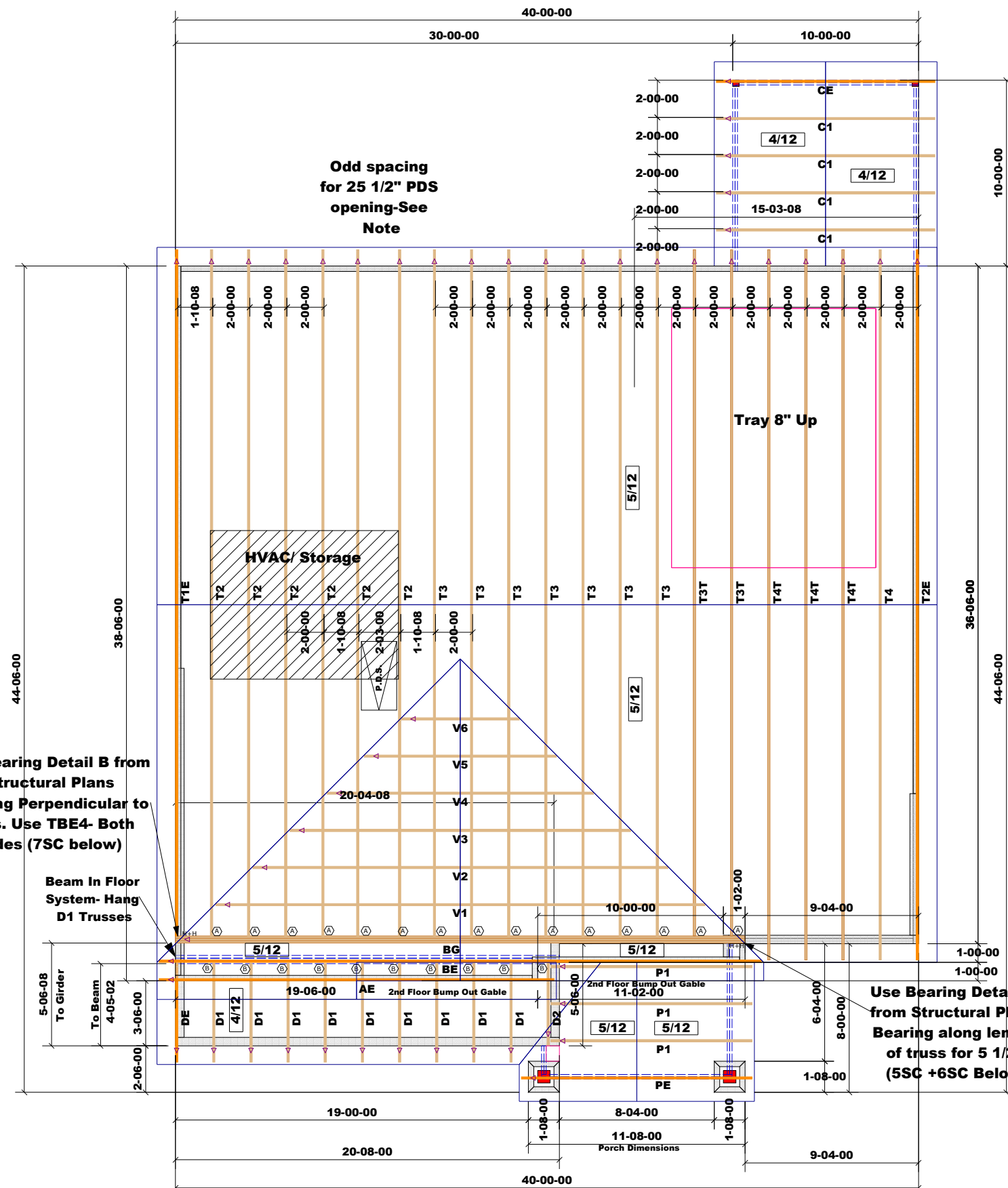
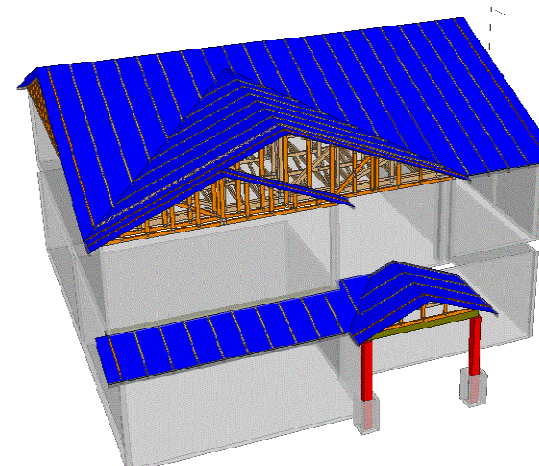

THE PURPOSE OF THIS DETAIL IS TO ILLUSTRATE HOW TO PROPERLY SPACE 24" O.C. ROOF TRUSSES TO ALLOW FOR A 25 1/2" OPENING FOR PULL DOWN ATTIC ACCESS

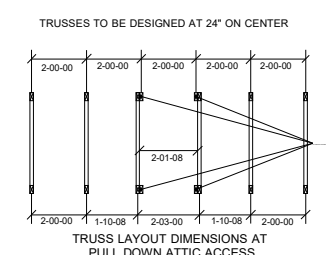

Hanger List		
Symbol	Name	Qty
A	HUS26	15
B	LUS24	10
C	TBE4	1 Set
H+H	(2) HTS20	4 Total

PROJECT: **Lot 44 @ Mason Pointe**

CUSTOMER: **KB HOME**

MODEL: **240.2596 "B" x 10x10 CP GOL**

SCALE: **NOT TO SCALE**

PO NUMBER: **PO #**

ORDER: **20176A**

SHIP DATE: **#####**

PRINT DATE: **03/20/19**

APPROVED: **MWM**

TOP LIVE: 20 PSF

TOP DEAD: 10 PSF

BOTM DEAD: 10 PSF

WIND SPD: 130 MPH

GENERAL NOTES:

DO NOT CUT OR MODIFY TRUSSES.

TRUSSES ARE SPACED 24" ON CENTER UNLESS NOTED OTHERWISE.

REFER TO THE INDIVIDUAL TRUSS DESIGN DRAWINGS FOR THE LOCATION OF LATERAL BRACING AND MULTI-PLY CONNECTION REQUIREMENTS.

PER ANSI TPI 1-2002 THE TRUSS ENGINEER IS RESPONSIBLE FOR TRUSS TO TRUSS CONNECTIONS AND TRUSS PLY TO PLY CONNECTIONS. THIS TRUSS PLACEMENT PLAN RECOMMENDS TRUSS TO BEARING CONNECTIONS AND TRUSS TO BEAM CONNECTIONS WHICH SHALL BE REVIEWED BY THE BUILDING DESIGNER. IT IS THE RESPONSIBILITY OF THE BUILDING DESIGNER TO RESOLVE ALL ROOF FORCES ADEQUATELY TO THE FOUNDATION.