

ISSUANCE OF PLANS FROM THIS DRAFTER'S OFFICE SHALL NOT RELIEVE THE BUILDER OF RESPONSIBILITY TO REVIEW AND VERIFY ALL NOTES, DIMENSIONS, AND ADHERENCE TO APPLICABLE BUILDING CODES PRIOR TO COMMENCEMENT OF ANY CONSTRUCTION.
 ANY DISCREPANCY OR ERROR IN NOTES, DIMENSIONS, OR ADHERENCE TO APPLICABLE BUILDING CODES SHALL BE BROUGHT TO THE ATTENTION OF THE DRAFTER'S OFFICE FOR CORRECTION BEFORE COMMENCEMENT OF ANY CONSTRUCTION.
 ANY REVISIONS OR CHANGES, NOT RELATED TO THE CORRECTION OF ERRORS THAT ARE MADE AFTER THE FINAL PLANS HAVE BEEN COMPLETED SHALL BE SUBJECT TO ADDITIONAL FEES.
 IF ANY MODIFICATIONS ARE MADE TO THESE PLANS BY ANY OTHER PARTY OTHER THAN THE DRAFTER'S OFFICE, THE DRAFTER SHALL NOT BE HELD RESPONSIBLE.



JOB NUMBER	B-1815878*
CAD FILE NAME	1755-L
ISSUED	11-08-17
REVISED	11-16-17
	09-12-18



150 STATE STREET EAST
 CLEARWATER, FLORIDA 34617
 813 - 925 - 1300 TEL
 813 - 925 - 1800 FAX
 WWW.DAVISBEWS.COM
 TAMPA • DENVER
 EST. 1994

DRAWINGS ON 11"x17" SHEET ARE ONE HALF THE SCALE NOTED

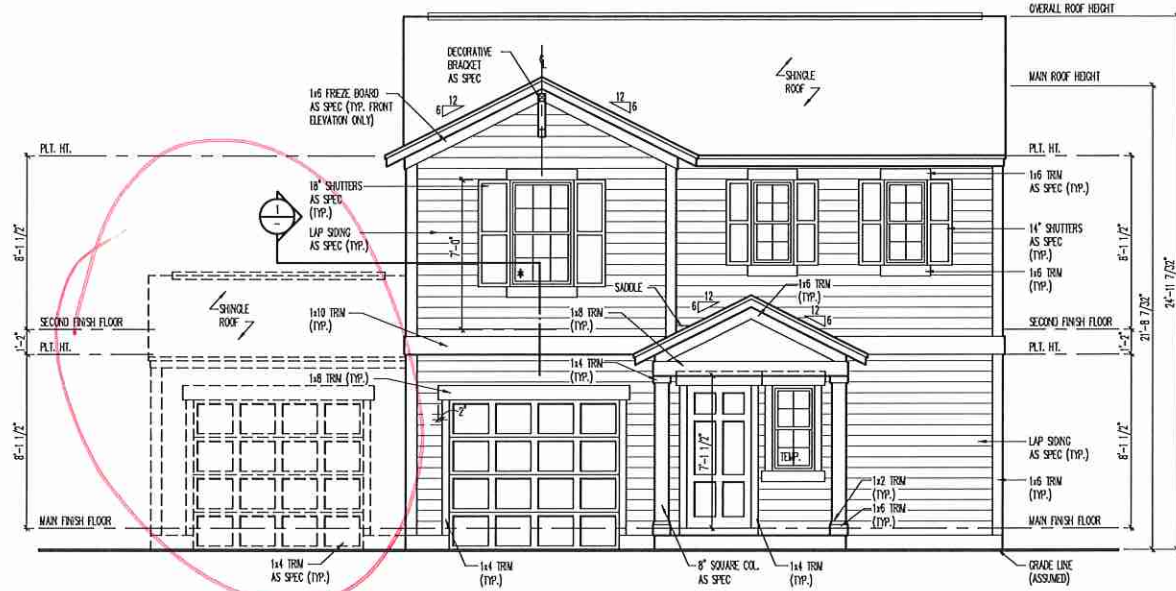
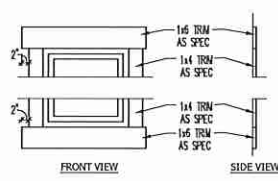
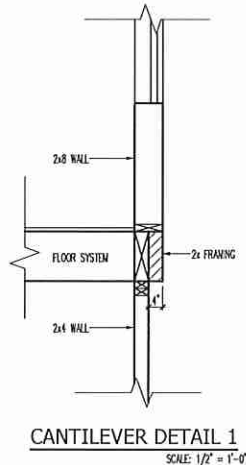
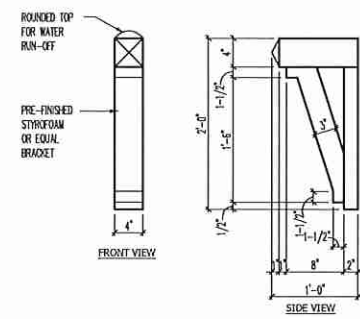

Approved
 Harnett COUNTY NORTH CAROLINA
 button 12/06/2018

WDS000423

ENGAGE
 H&H HOMES

1755

TITLE
 FRONT ELEVATION
 DETAILS

SHEET
A3.0

ELEVATION "A" - TRADITIONAL
 GARAGE LEFT

Inventory Marked

ISSUANCE OF PLANS FROM THIS DRAFTER'S OFFICE SHALL NOT RELIEVE THE BUILDER OF RESPONSIBILITY TO REVIEW AND VERIFY ALL NOTES, DIMENSIONS, AND ADHERENCE TO APPLICABLE BUILDING CODES PRIOR TO COMMENCEMENT OF ANY CONSTRUCTION.
 ANY DISCREPANCY OF ERROR IN NOTES, DIMENSIONS, OR ADHERENCE TO APPLICABLE BUILDING CODES SHALL BE BROUGHT TO THE ATTENTION OF THE DRAFTER'S OFFICE FOR CORRECTION BEFORE COMMENCEMENT OF ANY CONSTRUCTION.
 ANY REVISIONS OR CHANGES, NOT RELATED TO THE CORRECTION OF ERRORS THAT ARE MADE AFTER THE FINAL PLANS HAVE BEEN COMPLETED SHALL BE SUBJECT TO ADDITIONAL FEES.
 IF ANY MODIFICATIONS ARE MADE TO THESE PLANS BY ANY OTHER PARTY OTHER THAN THE DRAFTER'S OFFICE, THE DRAFTER SHALL NOT BE HELD RESPONSIBLE.

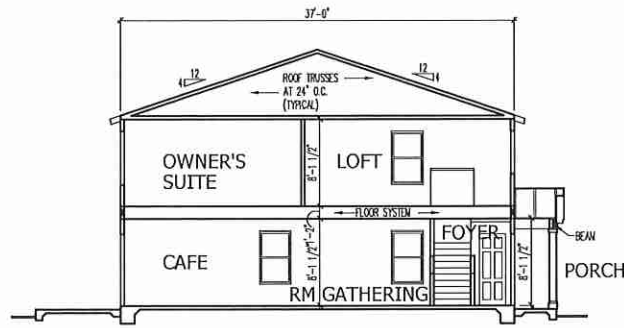

SECTION AA
 SCALE: 1/8" = 1'-0"

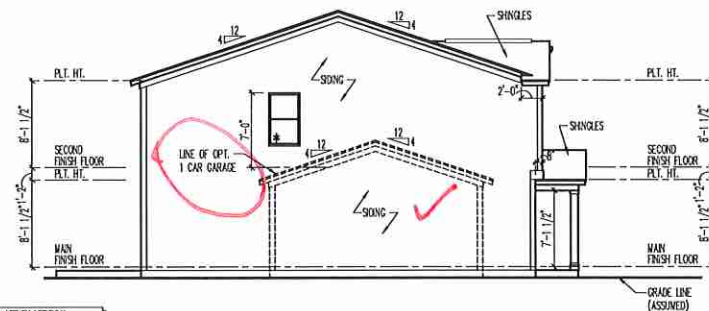

LEFT ELEVATION
 SCALE: 1/8" = 1'-0"

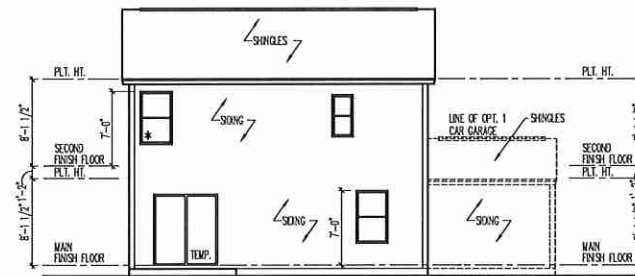

REAR ELEVATION
 SCALE: 1/8" = 1'-0"

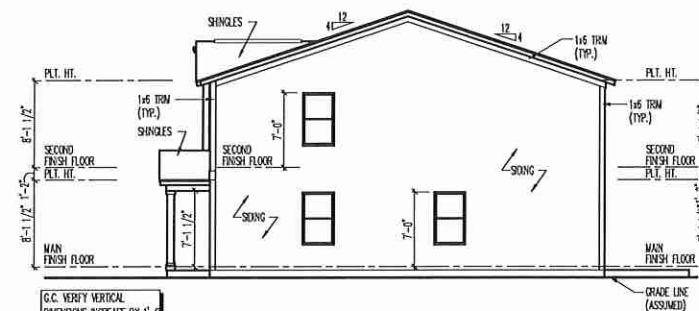

RIGHT ELEVATION
 SCALE: 1/8" = 1'-0"

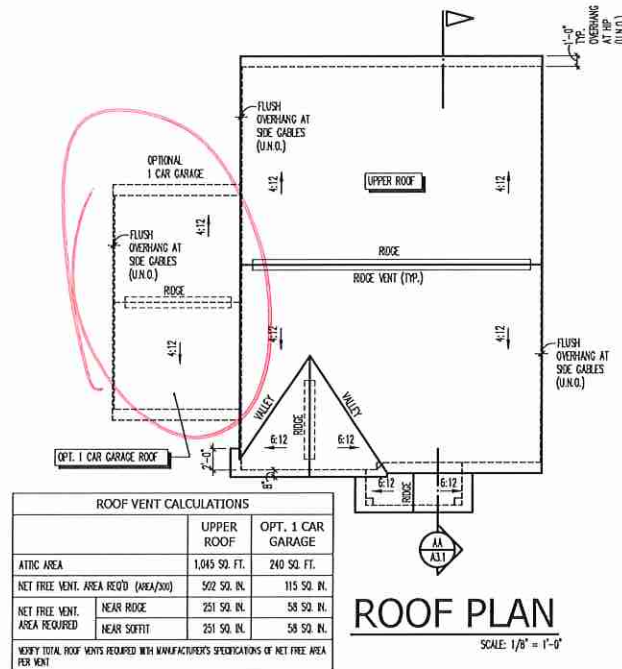

ROOF VENT CALCULATIONS		
	UPPER ROOF	OPT. 1 CAR GARAGE
ATIC AREA	1,045 SQ. FT.	240 SQ. FT.
NET FREE VENT. AREA REQ'D (AREA/20)	52.25 SQ. IN.	11.5 SQ. IN.
NET FREE VENT. AREA PROVIDED	58 SQ. IN.	58 SQ. IN.
NET FREE VENT. AREA REQUIRED	NEAR SOFFIT	NEAR SOFFIT
	251 SQ. IN.	58 SQ. IN.

VERIFY TOTAL ROOF VENTS PROVIDED WITH MANUFACTURER'S SPECIFICATIONS OF NET FREE AREA PER VENT

ROOF PLAN
 SCALE: 1/8" = 1'-0"



JOB NUMBER	B-1815878*
CAD FILE NAME	1755-1
ISSUED	11-09-17
REVISED	11-16-17
	09-12-18



150 STATE STREET EAST
 CLEARWATER, FLORIDA 34627
 813 - 925 - 1300 TEL.
 813 - 925 - 1800 FAX
 WWW.DAVISBEWS.COM
 TAMPA • DENVER
 EST. 1994

DRAWINGS ON 11"x17" SHEET ARE ONE HALF THE SCALE NOTED

ENGAGE
 H&H HOMES

1755

TITLE
 SIDE AND REAR ELEVATIONS
 ROOF PLAN
 BUILDING SECTION

SHEET
 A3.1

ELEVATION "A" - TRADITIONAL GARAGE LEFT



JOB NUMBER	B-1815878*
CAD FILE NAME	1755-L
ISSUED	11-08-17
REVISED	11-16-17
	09-12-18

DAVIS BEWS
DESIGN GROUP

150 STATE STREET EAST
OLDORCHARD, FLORIDA 34677
813-925-1300 TEL.
813-925-1800 FAX
WWW.DAVISBEWS.COM

TAMPA • DENVER
EST. 1994

DRAWINGS ON 11"x17"
SHEET ARE ONE HALF
THE SCALE NOTED

**ENGAGE
H&H HOMES**

1755

TITLE
SLAB INTERFACE PLAN

SHEET
A1.0

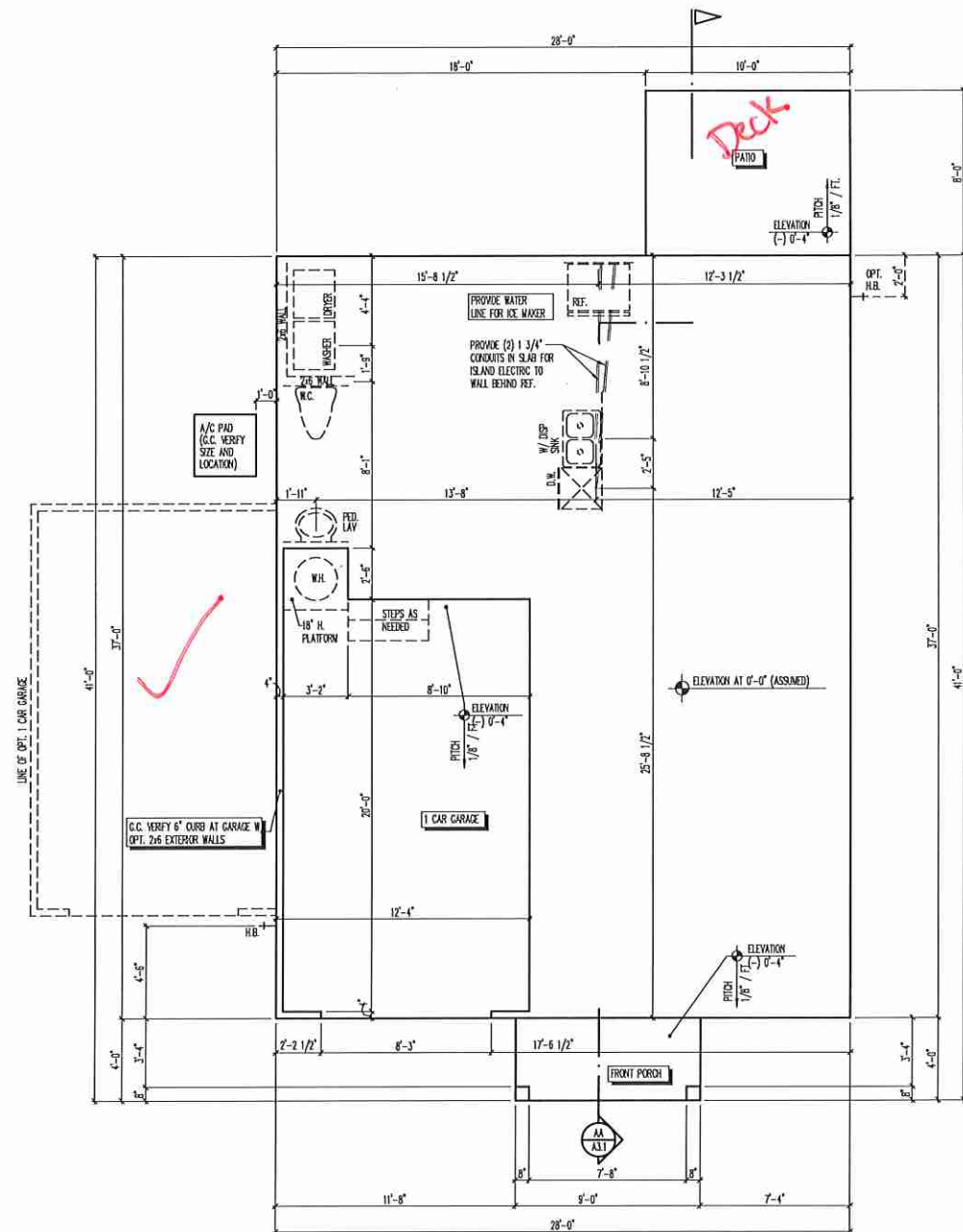

G.C. VERIFY INSTALLATION OF
OVERHEAD GAS DROPS AT
APPLICABLE APPLIANCE
LOCATIONS

SLAB INTERFACE PLAN
SCALE: 1/4" = 1'-0"
GARAGE LEFT

ISSUANCE OF PLANS FROM THIS DRAFTER'S OFFICE SHALL NOT RELIEVE THE BUILDER OF RESPONSIBILITY TO REVIEW AND VERIFY ALL NOTES, DIMENSIONS, AND ADHERENCE TO APPLICABLE BUILDING CODES PRIOR TO COMMENCEMENT OF ANY CONSTRUCTION.
ANY DISCREPANCY OF ERROR IN NOTES, DIMENSIONS, OR ADHERENCE TO APPLICABLE BUILDING CODES SHALL BE BROUGHT TO THE ATTENTION OF THE DRAFTER'S OFFICE FOR CORRECTION BEFORE COMMENCEMENT OF ANY CONSTRUCTION.
ANY REVISIONS OR CHANGES, NOT RELATED TO THE CORRECTION OF ERRORS THAT ARE MADE AFTER THE FINAL PLANS HAVE BEEN COMPLETED SHALL BE SUBJECT TO ADDITIONAL FEES.
IF ANY MODIFICATIONS ARE MADE TO THESE PLANS BY ANY OTHER PARTY OTHER THAN THE DRAFTER'S OFFICE, THE DRAFTER SHALL NOT BE HELD RESPONSIBLE.



JOB NUMBER	B-1615678*
CAD FILE NAME	1755-1
ISSUED	11-08-17
REVISED	11-16-17
	09-12-18

DAVIS BEWS
DESIGN GROUP

150 STATE STREET EAST
CLEARWATER, FLORIDA 34677
813 - 925 - 1300 TEL.
813 - 925 - 1800 FAX
WWW.DAVISBEWS.COM

TAMPA • DENVER
EST. 1994

DRAWINGS ON 11"x17"
SHEET ARE ONE HALF
THE SCALE NOTED

ENGAGE
H&H HOMES

1755

TITLE
SLAB INTERFACE PLAN
AT PLAN OPTIONS

SHEET
A1.1

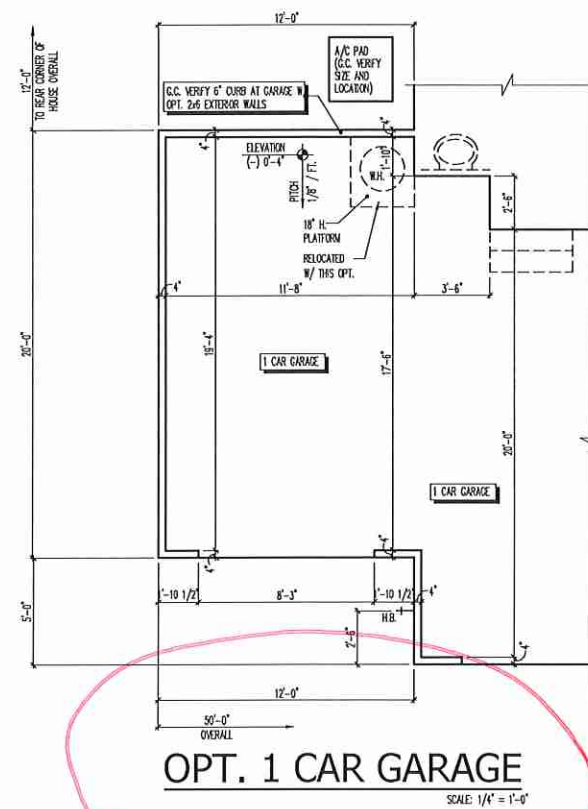

REFER TO STANDARD PLAN FOR
INFORMATION NOT SHOWN.

SLAB INTERFACE
AT PLAN OPTIONS
GARAGE LEFT

ISSUANCE OF PLANS FROM THIS DRAFTER'S OFFICE SHALL NOT RELIEVE THE BUILDER OF RESPONSIBILITY TO REVIEW AND VERIFY ALL NOTES, DIMENSIONS, AND ADHERENCE TO APPLICABLE BUILDING CODES PRIOR TO COMMENCEMENT OF ANY CONSTRUCTION.
ANY DISCREPANCY OF ERROR IN NOTES, DIMENSIONS, OR ADHERENCE TO APPLICABLE BUILDING CODES SHALL BE BROUGHT TO THE ATTENTION OF THE DRAFTER'S OFFICE FOR CORRECTION BEFORE COMMENCEMENT OF ANY CONSTRUCTION.
ANY REVISIONS OR CHANGES NOT RELATED TO THE CORRECTION OF ERRORS THAT ARE MADE AFTER THE FINAL PLANS HAVE BEEN COMPLETED SHALL BE SUBJECT TO ADDITIONAL FEES.
IF ANY MODIFICATIONS ARE MADE TO THESE PLANS BY ANY OTHER PARTY OTHER THAN THE DRAFTER'S OFFICE, THE DRAFTER SHALL NOT BE HELD RESPONSIBLE.

ISSUANCE OF PLANS FROM THIS DRAFTER'S OFFICE SHALL NOT RELIEVE THE BUILDER OF RESPONSIBILITY TO REVIEW AND VERIFY ALL NOTES, DIMENSIONS, AND ADHERENCE TO APPLICABLE BUILDING CODES PRIOR TO COMMENCEMENT OF ANY CONSTRUCTION.
 ANY DISCREPANCY OF ERROR IN NOTES, DIMENSIONS, OR ADHERENCE TO APPLICABLE BUILDING CODES SHALL BE BROUGHT TO THE ATTENTION OF THE DRAFTER'S OFFICE FOR CORRECTION BEFORE COMMENCEMENT OF ANY CONSTRUCTION.
 ANY REVISIONS OR CHANGES, NOT RELATED TO THE CORRECTION OF ERRORS THAT ARE MADE AFTER THE FINAL PLANS HAVE BEEN COMPLETED SHALL BE SUBJECT TO ADDITIONAL FEES.
 IF ANY MODIFICATIONS ARE MADE TO THESE PLANS BY ANY OTHER PARTY OTHER THAN THE DRAFTER'S OFFICE, THE DRAFTER SHALL NOT BE HELD RESPONSIBLE.

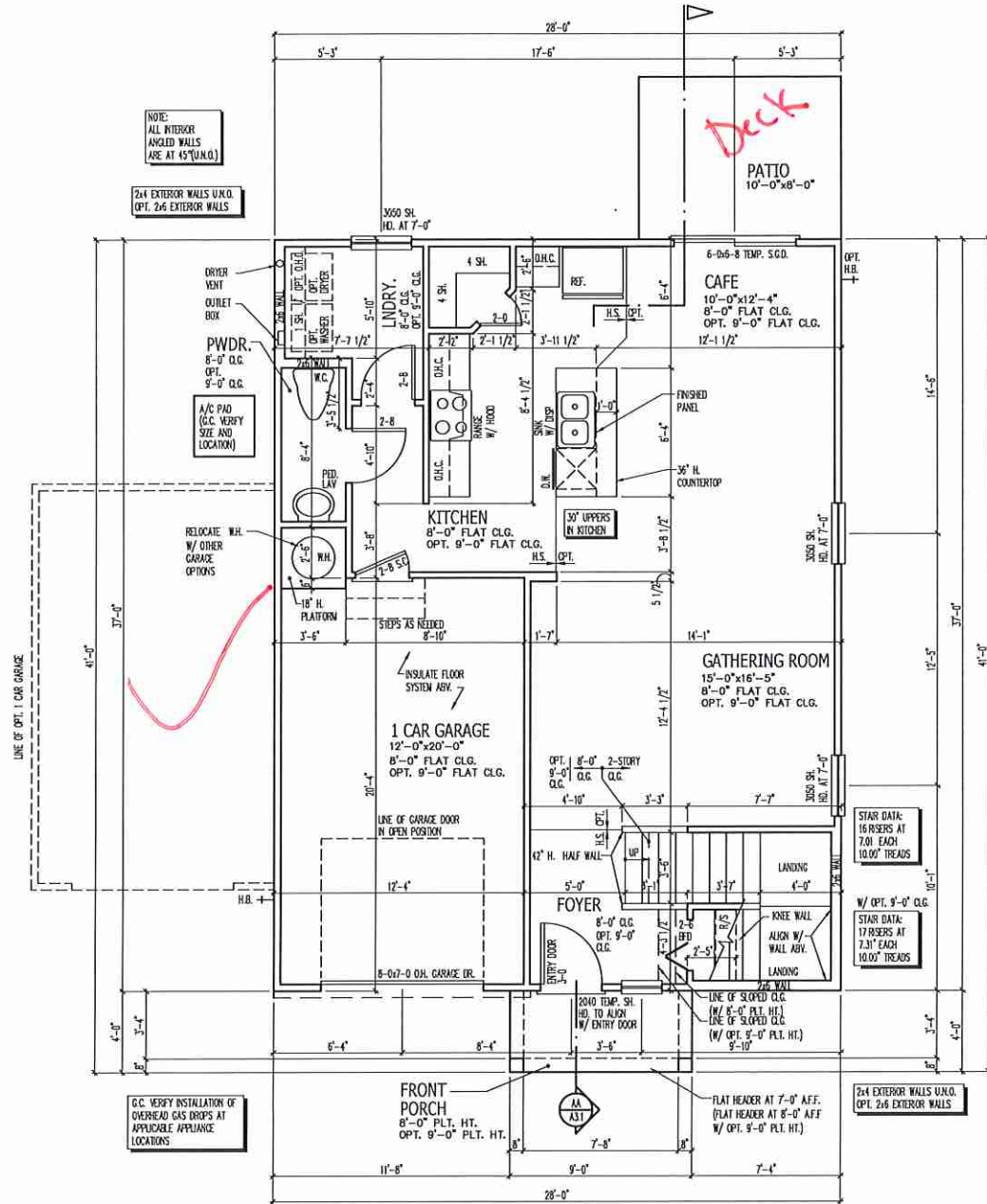

THE GARAGE SHALL BE SEPARATED FROM THE RESIDENCE AND ITS ATTIC AREA BY NOT LESS THAN 1/2 INCH (12.7 mm) GYPSUM BOARD APPLIED TO THE GARAGE SIDE. GARAGES BENEATH HABITABLE ROOMS SHALL BE SEPARATED FROM ALL HABITABLE ROOMS ABOVE BY NOT LESS THAN 5/8 INCH (15.9 mm) TYPE "X" GYPSUM BOARD OR EQUIVALENT, WHERE THE SEPARATION IS A FLOOR-CEILING ASSEMBLY, THE STRUCTURE SUPPORTING THE SEPARATION SHALL ALSO BE PROTECTED BY NOT LESS THAN 1/2 INCH (12.7 mm) GYPSUM BOARD OR EQUIVALENT.

MAIN FLOOR	777 S.F.
UPPER FLOOR	978 S.F.
TOTAL LIVING	1755 S.F.
GARAGE	259 S.F.
FRONT PORCH	36 S.F.
TOTAL SQ. FT.	2050 S.F.

MAIN FLOOR PLAN
 GARAGE LEFT
 SCALE: 1/4" = 1'-0"



JOB NUMBER	B-1815878*
CAD FILE NAME	1755-L*
ISSUED	11-09-17
REVISED	11-16-17
	09-12-18

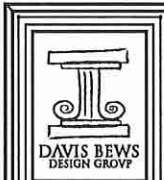

150 STATE STREET EAST
 CLEARWATER, FLORIDA 34617
 813-925-1300 TEL
 813-925-1800 FAX
 WWW.DAVISBEWS.COM

TAMPA • DENVER
 EST. 1994

DRAWINGS ON 11"x17"
 SHEET ARE ONE HALF
 THE SCALE NOTED

ENGAGE
 H&H HOMES

1755

MAIN FLOOR PLAN
 STAR SECTION

SHEET
 A2.0

STAIR NOTES:

RAILING:
BALUSTERS SHALL BE SPACED SO THAT A 4" SPHERE CANNOT PASS THROUGH.

THE TRIANGULAR OPENINGS FORMED BY THE RISER, TREAD AND BOTTOM RAIL OF A GUARD AT THE OPEN SIDE OF A STAIRWAY ARE PERMITTED TO BE A SUCH A SIZE THAT A SPHERE OF 6 INCHES CANNOT PASS THROUGH.

OPENINGS FOR RECOVERED GUARDS ON THE SIDES OF STAIR TREADS SHALL NOT ALLOW A SPHERE 4 3/8 INCHES TO PASS THROUGH.

HANDRAILS/HANDRAILS FOR STAIRWAYS SHALL BE CONTINUOUS FOR THE FULL LENGTH OF THE FLIGHT FROM A POINT DIRECTLY ABOVE THE 1ST RISER OF THE FLIGHT TO A POINT DIRECTLY ABOVE THE LOWEST RISER. HANDRAIL ENDS SHALL BE RETURNED OR SHALL TERMINATE IN NEVEL POSTS OR SAFETY TERMINALS. HANDRAILS ADJACENT TO A WALL SHALL HAVE A SPACE OF NOT LESS THAN 1-1/2 INCH BETWEEN THE WALL AND HANDRAILS.

CONTINUOUS GRASPABLE HANDRAIL MUST MEET TYPE ONE OR TYPE TWO CRITERIA.

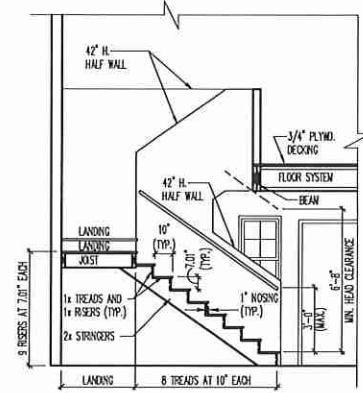
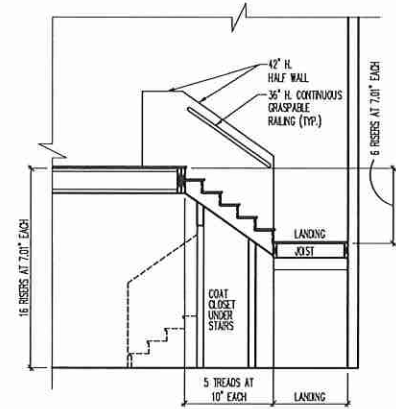

STAIR SECTION
W/ 8'-0" CLG.

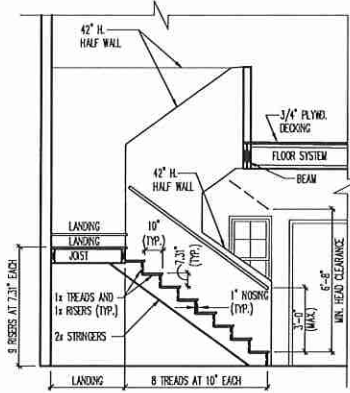
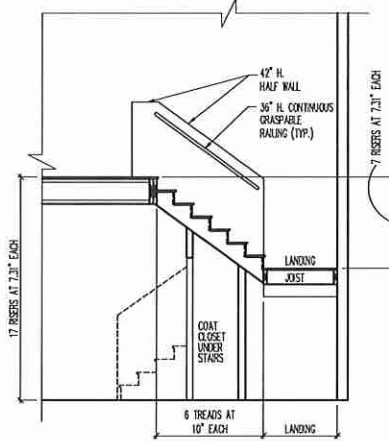

STAIR SECTION
W/ 9'-0" CLG.

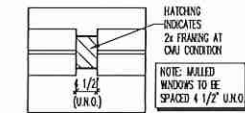

TYP. MULL DETAIL
SCALE: N.T.S.

ISSUANCE OF PLANS FROM THIS DRAFTER'S OFFICE SHALL NOT RELIEVE THE BUILDER OF RESPONSIBILITY TO REVIEW AND VERIFY ALL NOTES, DIMENSIONS, AND ADHERENCE TO APPLICABLE BUILDING CODES PRIOR TO COMMENCEMENT OF ANY CONSTRUCTION.

ANY DISCREPANCY OF ERROR IN NOTES, DIMENSIONS, OR ADHERENCE TO APPLICABLE BUILDING CODES SHALL BE BROUGHT TO THE ATTENTION OF THE DRAFTER'S OFFICE FOR CORRECTION BEFORE COMMENCEMENT OF ANY CONSTRUCTION.

ANY REVISIONS OR CHANGES, NOT RELATED TO THE CORRECTION OF ERRORS THAT ARE MADE AFTER THE FINAL PLANS HAVE BEEN COMPLETED SHALL BE SUBJECT TO ADDITIONAL FEES.

IF ANY MODIFICATIONS ARE MADE TO THESE PLANS BY ANY OTHER PARTY OTHER THAN THE DRAFTER'S OFFICE, THE DRAFTER SHALL NOT BE HELD RESPONSIBLE.

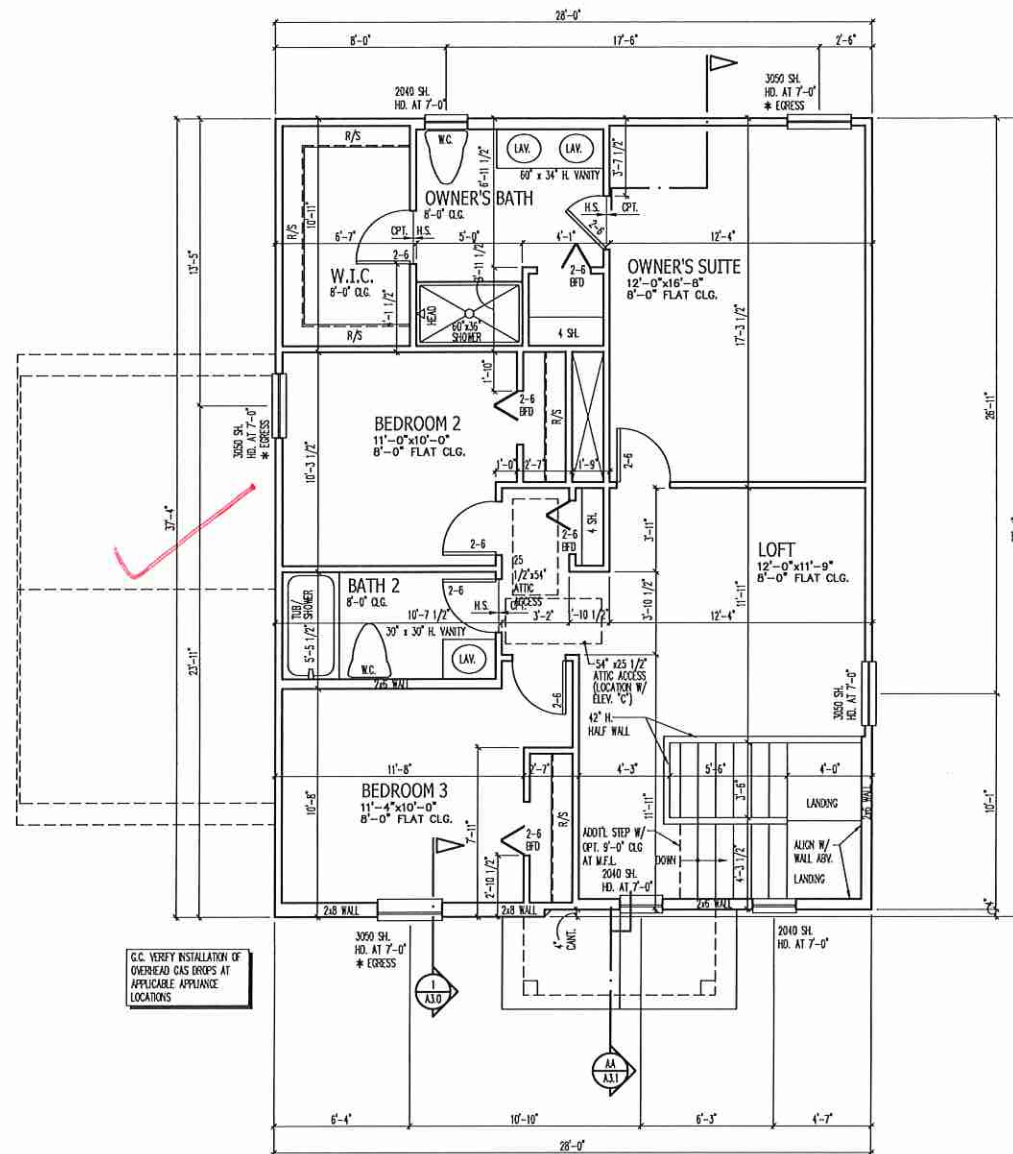

G.C. VERIFY INSTALLATION OF OVERHEAD GAS DROPS AT APPLICABLE APPLIANCE LOCATIONS

UPPER FLOOR W/ OPT. 9' CLG 974 S.F.

UPPER FLOOR PLAN
GARAGE LEFT



JOB NUMBER	B-1815878
CAD FILE NAME	1755-C
ISSUED	11-08-17
REVISED	11-16-17
	09-12-18

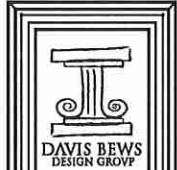

150 STATE STREET EAST
CLEARWATER, FLORIDA 34617
813 - 925 - 1300 TEL.
813 - 925 - 1800 FAX
WWW.DAVISBEWS.COM
TAMPA • DENVER
EST. 1994

DRAWINGS ON 11"x17" SHEET ARE ONE HALF THE SCALE NOTED

ENGAGE H&H HOMES

1755

TITLE
UPPER FLOOR PLAN

SHEET
A2.1

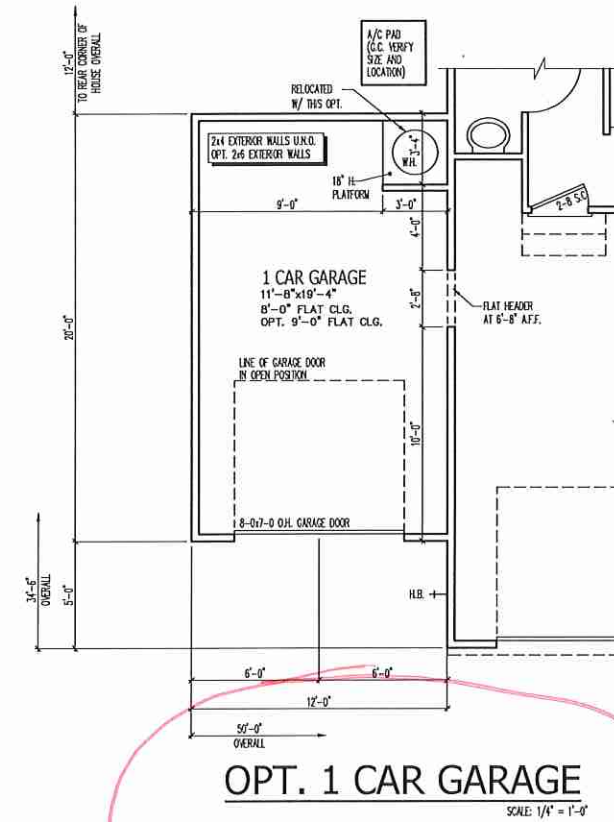
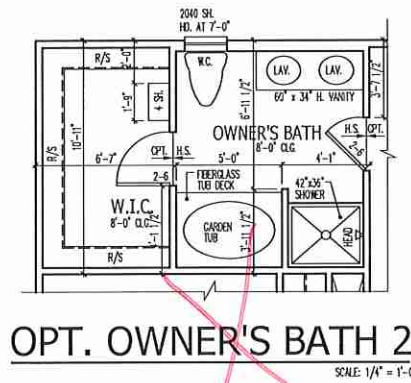

ISSUANCE OF PLANS FROM THIS DRAFTER'S OFFICE SHALL NOT RELIEVE THE BUILDER OF RESPONSIBILITY TO REVIEW AND VERIFY ALL NOTES, DIMENSIONS, AND ADHERENCE TO APPLICABLE BUILDING CODES PRIOR TO COMMENCEMENT OF ANY CONSTRUCTION. ANY DISCREPANCY OF ERROR IN NOTES, DIMENSIONS, OR ADHERENCE TO APPLICABLE BUILDING CODES SHALL BE BROUGHT TO THE ATTENTION OF THE DRAFTER'S OFFICE FOR CORRECTION BEFORE COMMENCEMENT OF ANY CONSTRUCTION. ANY REVISIONS OR CHANGES, NOT RELATED TO THE CORRECTION OF ERRORS THAT ARE MADE AFTER THE FINAL PLANS HAVE BEEN COMPLETED SHALL BE SUBJECT TO ADDITIONAL FEES. IF ANY MODIFICATIONS ARE MADE TO THESE PLANS BY ANY OTHER PARTY OTHER THAN THE DRAFTER'S OFFICE, THE DRAFTER SHALL NOT BE HELD RESPONSIBLE.



JOB NUMBER	B-1815878*
CAD FILE NAME	1755-1
ISSUED	11-08-17
REVISED	11-08-17
	09-12-18

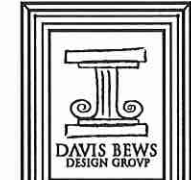

150 STATE STREET EAST
 CLEARWATER, FLORIDA 34677
 813 - 925 - 1300 TEL
 813 - 925 - 1800 FAX
 WWW.DAVISBEWS.COM

TAMPA • DENVER
 EST. 1994

DRAWINGS ON 11"x17"
 SHEET ARE ONE HALF
 THE SCALE NOTED

ENGAGE
 H&H HOMES

1755

TITLE
 PLAN OPTIONS

SHEET
 A2.2

REFER TO STANDARD PLAN FOR
 INFORMATION NOT SHOWN.
 PLAN OPTIONS
 GARAGE LEFT

ELECTRICAL KEY

- ⊕ Duplex convenience outlet
- ⊕ Duplex outlet above counter
- ⊕ Weatherproof duplex outlet
- ⊕ Ground fault interrupter duplex outlet
- ⊕ Half-switched duplex outlet
- ⊕ Special purpose outlet
- ⊕ Duplex outlet in floor
- ⊕ 220 volt outlet
- ⊕ Wall switch
- ⊕ Three-way switch
- ⊕ Four-way switch
- ⊕ Dimmer switch
- ⊕ Ceiling mounted incandescent light fixture
- ⊕ Wall mounted incandescent light fixture
- ⊕ Recessed incandescent light fixture
- ⊕ Light fixture with pull chain
- ⊕ Track light
- ⊕ Fluorescent light fixture
- ⊕ Exhaust fan
- ⊕ Exhaust fan/light combination
- ⊕ Electric door operator (optional)
- ⊕ Chimes (optional)
- ⊕ Pushbutton switch (optional)
- ⊕ Carbon monoxide detector
- ⊕ Smoke detector
- ⊕ Smoke / carbon monoxide combo detector
- ⊕ Telephone (optional)
- ⊕ Television (optional)
- ⊕ Thermostat
- ⊕ Electric meter
- ⊕ Electric panel
- ⊕ Disconnect switch
- ⊕ Speaker (optional)
- ⊕ Rough-in for opt. ceiling fan
- ⊕ Ceiling mounted incandescent light fixture w/ rough-in for opt. ceiling fan

NOTES:

1. PROVIDE AND INSTALL GROUND FAULT CIRCUIT-INTERRUPTERS (GFI) AS INDICATED ON PLANS OR AS ITEM NO. 4 AND 5 BELOW INDICATES.
2. UNLESS OTHERWISE INDICATED, INSTALL SWITCHES AND RECEPTACLES AT THE FOLLOWING HEIGHTS ABOVE FINISHED FLOOR:
 SWITCHES . . . 42"
 OUTLETS . . . 14"
 TELEPHONE . . . 14" (UNLESS ANY COUNTERTOP)
 TELEVISION . . . 14"
3. ALL SMOKE DETECTORS SHALL BE HARDWIRED INTO AN ELECTRICAL POWER SOURCE AND SHALL BE EQUIPPED WITH A MONITORED BATTERY BACKUP. PROVIDE AND INSTALL LOCALLY CERTIFIED SMOKE DETECTORS.
4. ALL 15A AND 20A RECEPTACLES IN SLEEPING ROOMS, FAMILY ROOMS, DINING ROOMS, LIVING ROOMS, PARLOYS, LIBRARIES, DECKS, SUNROOMS, RECREATION ROOMS, CLOSETS, HALLWAYS, AND SIMILAR AREAS WILL REQUIRE A COMBINATION TYPE AFCI DEVICE AND TAMPER-PROOF RECEPTACLES PER N.E.C. 2011 406.12 AND 406.13
5. ALL 15A AND 20A 120V RECEPTACLES LOCATED IN THE GARAGE AND UTILITY ROOMS SHALL BE GFCI PROTECTED (GFI).
6. IT IS THE RESPONSIBILITY OF THE LICENSED ELECTRICIAN TO ENSURE THAT ALL ELECTRICAL WORK IS IN FULL COMPLIANCE WITH N.E.P.A. 70, N.E.C. 2011, AND ALL APPLICABLE LOCAL STANDARDS, CODES, AND ORDINANCES.
7. EVERY BUILDING HAVING A FOSSIL-FUEL-BURNING HEATER OR APPLIANCE, FIREPLACE, OR AN ATTACHED GARAGE SHALL HAVE AN OPERATIONAL CARBON MONOXIDE DETECTOR INSTALLED WITHIN 10 FEET OF EACH ROOM USED FOR SLEEPING PURPOSES.
8. ALARMS SHALL RECEIVE THEIR PRIMARY POWER FROM THE BUILDING WIRING WHEN SUCH WIRING IS SERVED FROM THE LOCAL POWER UTILITY. SUCH ALARMS SHALL HAVE BATTERY BACKUP. COMBINATION SMOKE/CARBON MONOXIDE ALARMS SHALL BE LISTED OR LABELED BY A NATIONALLY RECOGNIZED TESTING LABORATORY.

ISSUANCE OF PLANS FROM THIS DRAFTER'S OFFICE SHALL NOT RELIEVE THE BUILDER OF RESPONSIBILITY TO REVIEW AND VERIFY ALL NOTES, DIMENSIONS, AND ADHERENCE TO APPLICABLE BUILDING CODES PRIOR TO COMMENCEMENT OF ANY CONSTRUCTION. ANY DISCREPANCY OF ERROR IN NOTES, DIMENSIONS, OR ADHERENCE TO APPLICABLE BUILDING CODES SHALL BE BROUGHT TO THE ATTENTION OF THE DRAFTER'S OFFICE FOR CORRECTION BEFORE COMMENCEMENT OF ANY CONSTRUCTION. ANY REVISIONS OR CHANGES, NOT RELATED TO THE CORRECTION OF ERRORS THAT ARE MADE AFTER THE FINAL PLANS HAVE BEEN COMPLETED SHALL BE SUBJECT TO ADDITIONAL FEES. IF ANY MODIFICATIONS ARE MADE TO THESE PLANS BY ANY OTHER PARTY OTHER THAN THE DRAFTER'S OFFICE, THE DRAFTER SHALL NOT BE HELD RESPONSIBLE.

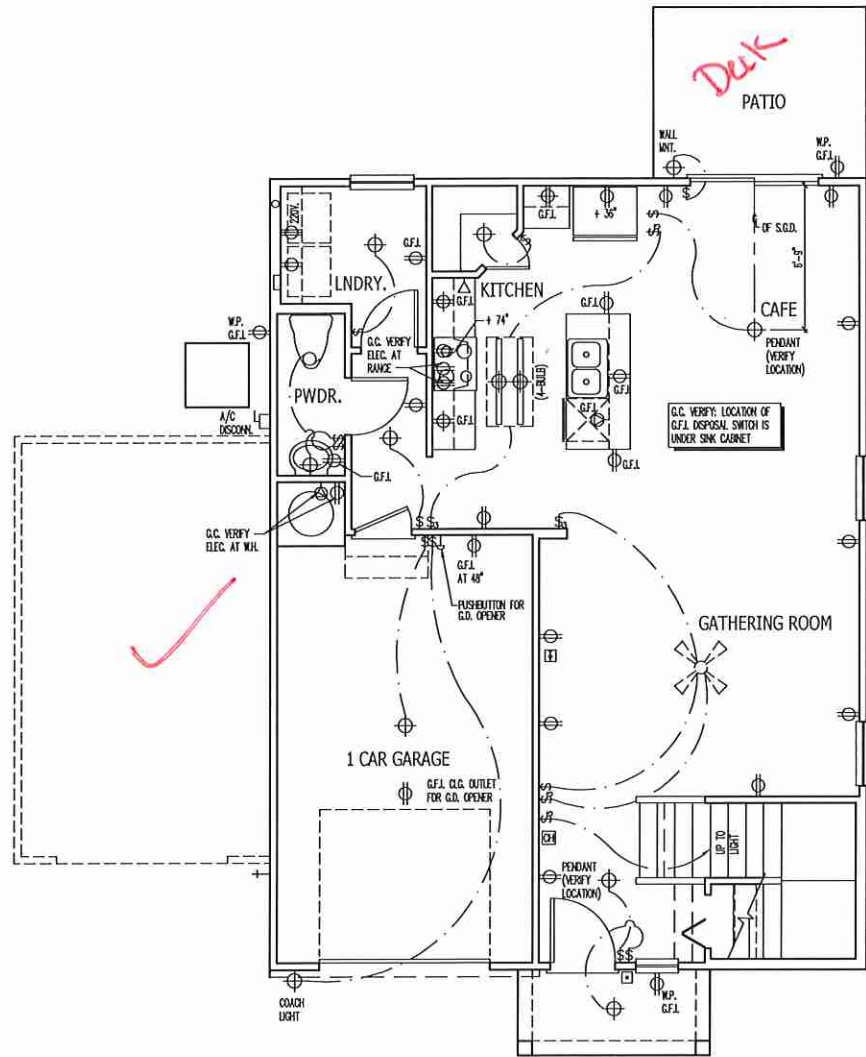

JOB NUMBER	B-1815878*
CAD FILE NAME	1755-L
ISSUED	11-09-17
REVISED	11-16-17
	09-12-18



150 STATE STREET EAST
 CLEARWATER, FLORIDA 34617
 813 - 925 - 1300 TEL.
 813 - 925 - 1800 FAX
 WWW.DAVISBEWS.COM
 TAMPA • DENVER
 EST. 1994

DRAWINGS ON 11"x17" SHEET ARE ONE HALF THE SCALE NOTED

ENGAGE H&H HOMES

1755

TITLE
 MAIN FLOOR ELEC. PLAN

SHEET
E1

MAIN FLOOR ELECTRICAL PLAN
 GARAGE LEFT

ELECTRICAL KEY

- ⊕ DUPLEX CONNEXION OUTLET
- ⊕ DUPLEX OUTLET ABOVE COUNTER
- ⊕ WEATHERPROOF DUPLEX OUTLET
- ⊕ GROUND FAULT INTERRUPTER DUPLEX OUTLET
- ⊕ HALF-SWITCHED DUPLEX OUTLET
- ⊕ SPECIAL PURPOSE OUTLET
- ⊕ DUPLEX OUTLET IN FLOOR
- ⊕ 220 VOLT OUTLET
- ⊕ WALL SWITCH
- ⊕ THREE-WAY SWITCH
- ⊕ FOUR-WAY SWITCH
- ⊕ DIMMER SWITCH
- ⊕ CEILING MOUNTED INCANDESCENT LIGHT FIXTURE
- ⊕ WALL MOUNTED INCANDESCENT LIGHT FIXTURE
- ⊕ RECESSED INCANDESCENT LIGHT FIXTURE
- ⊕ LIGHT FIXTURE WITH PULL CHAIN
- ⊕ TRACK LIGHT
- ⊕ FLUORESCENT LIGHT FIXTURE
- ⊕ EXHAUST FAN
- ⊕ EXHAUST FAN/LIGHT COMINATION
- ⊕ ELECTRIC DOOR OPERATOR (OPTIONAL)
- ⊕ DIMES (OPTIONAL)
- ⊕ PUSHBUTTON SWITCH (OPTIONAL)
- ⊕ CARBON MONOXIDE DETECTOR
- ⊕ SMOKE DETECTOR
- ⊕ SMOKE / CARBON MONOXIDE DETECTOR
- ⊕ TELEPHONE (OPTIONAL)
- ⊕ TELEVISION (OPTIONAL)
- ⊕ THERMOSTAT
- ⊕ ELECTRIC METER
- ⊕ ELECTRIC PANEL
- ⊕ DISCONNECT SWITCH
- ⊕ SPEAKER (OPTIONAL)
- ⊕ ROUGH-IN FOR OPL. CEILING FAN
- ⊕ CEILING MOUNTED INCANDESCENT LIGHT FIXTURE W/ ROUGH-IN FOR OPL. CEILING FAN

- NOTES:**
1. PROVIDE AND INSTALL GROUND FAULT CIRCUIT INTERRUPTERS (GFI) AS INDICATED ON PLANS OR AS ITEM NO. 4 AND 5 BELOW INDICATES.
 2. UNLESS OTHERWISE INDICATED, INSTALL SWITCHES AND RECEPTACLES AT THE FOLLOWING HEIGHTS ABOVE FINISHED FLOOR:
 SWITCHES . . . 42"
 OUTLETS . . . 14"
 TELEPHONE . . . 14" (UNLESS ASY COUNTERTOP)
 TELEVISION . . . 14"
 3. ALL SMOKE DETECTORS SHALL BE HARDWIRED INTO AN ELECTRICAL POWER SOURCE AND SHALL BE EQUIPPED WITH A MONITORED BATTERY BACKUP. PROVIDE AND INSTALL LOCALLY CERTIFIED SMOKE DETECTORS.
 4. ALL 15A AND 20A RECEPTACLES IN SLEEPING ROOMS, FAMILY ROOMS, DINING ROOMS, LIVING ROOMS, PARLORS, LIBRARIES, DEKS, SUNROOMS, RECREATION ROOMS, CLOSETS, HALLWAYS, AND SHOWER AREAS WILL REQUIRE A COMBINATION TYPE AFCI DEVICE AND TAMPER-PROOF RECEPTACLES PER N.E.C. 2011 406.12 AND 406.13.
 5. ALL 15A AND 20A 120V RECEPTACLES LOCATED IN THE GARAGE AND UTILITY ROOMS SHALL BE GFCI PROTECTED (GFI).
 6. IT IS THE RESPONSIBILITY OF THE LICENSED ELECTRICIAN TO ENSURE THAT ALL ELECTRICAL WORK IS IN FULL COMPLIANCE WITH N.E.P.A. 70, N.E.C. 2011, AND ALL APPLICABLE LOCAL STANDARDS, CODES, AND ORDINANCES.
 7. EVERY BUILDING HAVING A FOSSIL-FUEL-BURNING HEATER OR APPLIANCE, FIREPLACE, OR AN ATTACHED GARAGE SHALL HAVE AN OPERATIONAL CARBON MONOXIDE DETECTOR INSTALLED WITHIN 10 FEET OF EACH ROOM USED FOR SLEEPING PURPOSES.
 8. ALARMS SHALL RECEIVE THEIR PRIMARY POWER FROM THE BUILDING WIRING WHEN SUCH WIRING IS SERVED FROM THE LOCAL POWER UTILITY. SUCH ALARMS SHALL HAVE BATTERY BACKUP. COMBINATION SMOKE/CARBON MONOXIDE ALARMS SHALL BE LISTED OR LABELED BY A NATIONALLY RECOGNIZED TESTING LABORATORY.

ISSUANCE OF PLANS FROM THIS DRAFTER'S OFFICE SHALL NOT RELIEVE THE BUILDER OF RESPONSIBILITY TO REVIEW AND VERIFY ALL NOTES, DIMENSIONS, AND ADHERENCE TO APPLICABLE BUILDING CODES PRIOR TO COMMENCEMENT OF ANY CONSTRUCTION.
 ANY DISCREPANCY OF ERROR IN NOTES, DIMENSIONS, OR ADHERENCE TO APPLICABLE BUILDING CODES SHALL BE BROUGHT TO THE ATTENTION OF THE DRAFTER'S OFFICE FOR CORRECTION BEFORE COMMENCEMENT OF ANY CONSTRUCTION.
 ANY REVISIONS OR CHANGES, NOT RELATED TO THE CORRECTION OF ERRORS THAT ARE MADE AFTER THE FINAL PLANS HAVE BEEN COMPLETED SHALL BE SUBJECT TO ADDITIONAL FEES.
 IF ANY MODIFICATIONS ARE MADE TO THESE PLANS BY ANY OTHER PARTY OTHER THAN THE DRAFTER'S OFFICE, THE DRAFTER SHALL NOT BE HELD RESPONSIBLE.

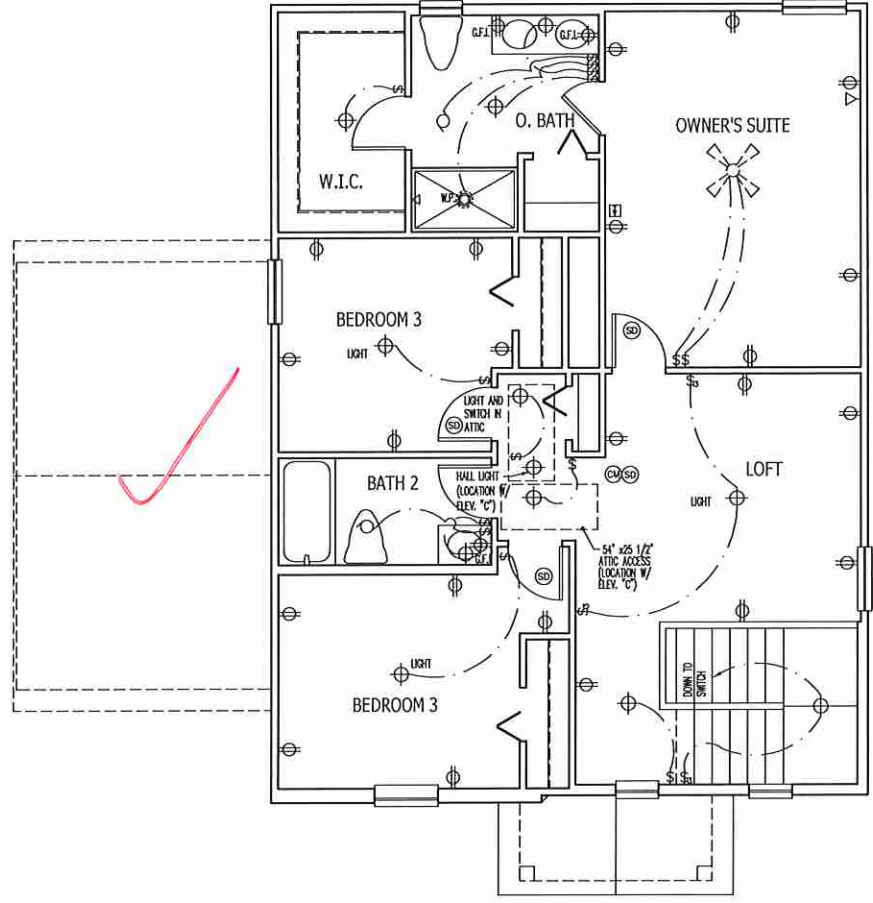

**UPPER FLOOR ELECTRICAL PLAN
GARAGE LEFT**



JOB NUMBER	B-1815878*
CAD FILE NAME	1755-E
ISSUED	11-08-17
REVISED	11-16-17
	09-12-18



150 STATE STREET EAST
 CLEARWATER, FLORIDA 34617
 813 - 925 - 1300 TEL
 813 - 925 - 1800 FAX
 WWW.DAVISBEWS.COM

TAMPA • DENVEN
 EST. 1994

DRAWINGS ON 11"x17"
 SHEET ARE ONE HALF
 THE SCALE NOTED

**ENGAGE
H&H HOMES**

1755

TITLE
 UPPER FLOOR ELEC. PLAN

SHEET
E2

ELECTRICAL KEY

- ⊕ DUPLEX CONVENIENCE OUTLET
- ⊕ DUPLEX OUTLET ABOVE COUNTER
- ⊕ WEATHERPROOF DUPLEX OUTLET
- ⊕ GROUND FAULT INTERRUPTER DUPLEX OUTLET
- ⊕ HALF-SWITCHED DUPLEX OUTLET
- ⊕ SPECIAL PURPOSE OUTLET
- ⊕ DUPLEX OUTLET IN FLOOR
- ⊕ 220 VOLT OUTLET
- ⊕ WALL SWITCH
- ⊕ THREE-WAY SWITCH
- ⊕ FOUR-WAY SWITCH
- ⊕ DIMMER SWITCH
- ⊕ CEILING MOUNTED INCANDESCENT LIGHT FIXTURE
- ⊕ WALL MOUNTED INCANDESCENT LIGHT FIXTURE
- ⊕ RECESSED INCANDESCENT LIGHT FIXTURE
- ⊕ LIGHT FIXTURE WITH PULL CHAIN
- ⊕ TRACK LIGHT
- ⊕ FLUORESCENT LIGHT FIXTURE
- ⊕ EXHAUST FAN
- ⊕ EXHAUST FAN/LIGHT COMBINATION
- ⊕ ELECTRIC DOOR OPERATOR (OPTIONAL)
- ⊕ CHIMES (OPTIONAL)
- ⊕ PUSHBUTTON SWITCH (OPTIONAL)
- ⊕ CARBON MONOXIDE DETECTOR
- ⊕ SMOKE DETECTOR
- ⊕ SMOKE / CARBON MONOXIDE DETECTOR
- ⊕ TELEPHONE (OPTIONAL)
- ⊕ TELEVISION (OPTIONAL)
- ⊕ THERMOSTAT
- ⊕ ELECTRIC METER
- ⊕ ELECTRIC PANEL
- ⊕ DISCONNECT SWITCH
- ⊕ SPEAKER (OPTIONAL)
- ⊕ ROUGH-IN FOR OPT. CEILING FAN
- ⊕ CEILING MOUNTED INCANDESCENT LIGHT FIXTURE W/
ROUGH-IN FOR OPT. CEILING FAN

NOTES:

1. PROVIDE AND INSTALL GROUND FAULT CIRCUIT INTERRUPTERS (GFI) AS INDICATED ON PLANS OR AS ITEM NO. 4 AND 5 BELOW INDICATES.
2. UNLESS OTHERWISE INDICATED, INSTALL SWITCHES AND RECEPTACLES AT THE FOLLOWING HEIGHTS ABOVE FINISHED FLOOR:
 SWITCHES . . . 42"
 OUTLETS . . . 18"
 TELEPHONE . . . 14" (UNLESS ANY COUNTERTOP)
 TELEVISION . . . 14"
3. ALL SMOKE DETECTORS SHALL BE HARDWIRED INTO AN ELECTRICAL POWER SOURCE AND SHALL BE EQUIPPED WITH A MONITORED BATTERY BACKUP. PROVIDE AND INSTALL LOCALLY CERTIFIED SMOKE DETECTORS.
4. ALL 15A AND 20A RECEPTACLES IN SLEEPING ROOMS, FAMILY ROOMS, DINING ROOMS, LIVING ROOMS, PARLORS, LEVERIES, DECKS, SANITARY, RECREATION ROOMS, CLOSETS, HALLWAYS, AND SIMILAR AREAS WILL REQUIRE A COMBINATION TYPE AFCI DEVICE AND TAMPER-PROOF RECEPTACLES PER N.E.C. 2011 408.12 AND 408.13
5. ALL 15A AND 20A 120V RECEPTACLES LOCATED IN THE GARAGE AND UTILITY ROOMS SHALL BE GFCI PROTECTED (G.F.I.).
6. IT IS THE RESPONSIBILITY OF THE LICENSED ELECTRICIAN TO ENSURE THAT ALL ELECTRICAL WORK IS IN FULL COMPLIANCE WITH N.F.P.A. 70, N.E.C. 2011, AND ALL APPLICABLE LOCAL STANDARDS, CODES, AND ORDINANCES.
7. EVERY BUILDING HAVING A FOSSIL-FUEL-BURNING HEATER OR APPLIANCE, FIREPLACE, OR AN ATTACHED GARAGE SHALL HAVE AN OPERATIONAL CARBON MONOXIDE DETECTOR INSTALLED WITHIN 10 FEET OF EACH ROOM USED FOR SLEEPING PURPOSES.
8. ALARMS SHALL RECEIVE THEIR PRIMARY POWER FROM THE BUILDING WIRING WHEN SUCH WIRING IS SERVED FROM THE LOCAL POWER UTILITY. SUCH ALARMS SHALL HAVE BATTERY BACKUP. COMBINATION SMOKE/CARBON MONOXIDE ALARMS SHALL BE LISTED OR LABELED BY A NATIONALLY RECOGNIZED TESTING LABORATORY.

ISSUANCE OF PLANS FROM THIS DRAFTER'S OFFICE SHALL NOT RELIEVE THE BUILDER OF RESPONSIBILITY TO REVIEW AND VERIFY ALL NOTES, DIMENSIONS, AND ADHERENCE TO APPLICABLE BUILDING CODES PRIOR TO COMMENCEMENT OF ANY CONSTRUCTION.
 ANY DISCREPANCY OF ERROR IN NOTES, DIMENSIONS, OR ADHERENCE TO APPLICABLE BUILDING CODES SHALL BE BROUGHT TO THE ATTENTION OF THE DRAFTER'S OFFICE FOR CORRECTION BEFORE COMMENCEMENT OF ANY CONSTRUCTION.
 ANY REVISIONS OR CHANGES, NOT RELATED TO THE CORRECTION OF ERRORS THAT ARE MADE AFTER THE FINAL PLANS HAVE BEEN COMPLETED SHALL BE SUBJECT TO ADDITIONAL FEES.
 IF ANY MODIFICATIONS ARE MADE TO THESE PLANS BY ANY OTHER PARTY OTHER THAN THE DRAFTER'S OFFICE, THE DRAFTER SHALL NOT BE HELD RESPONSIBLE.

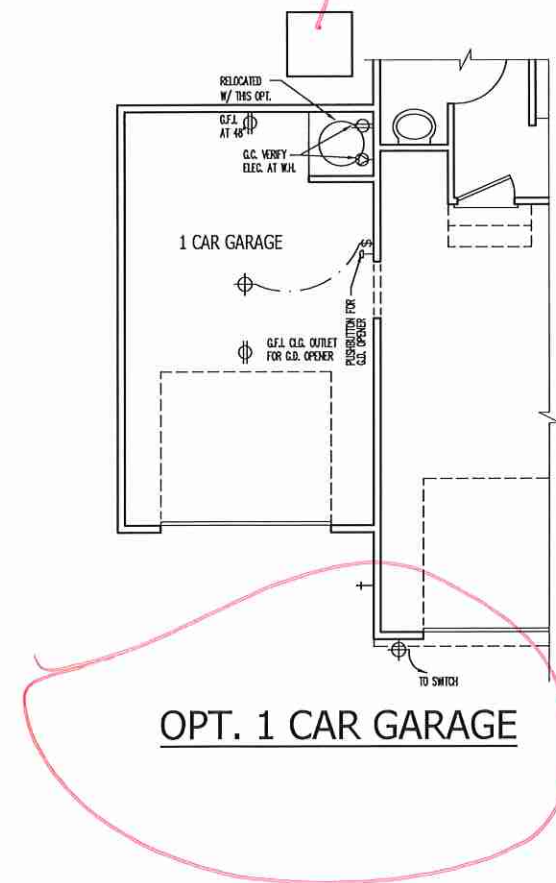
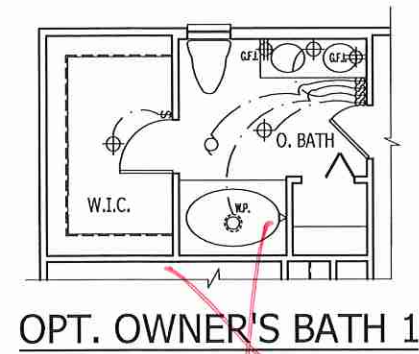
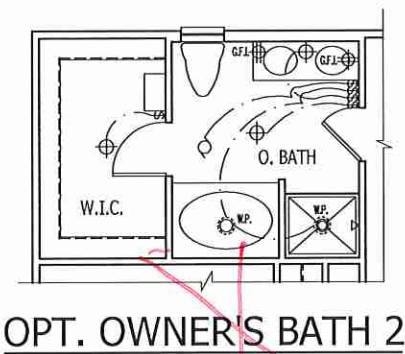

**ELECTRIC AT
PLAN OPTIONS
GARAGE LEFT**



JOB NUMBER	B-1815878
CAD FILE NAME	1755-E
ISSUED	11-06-17
REVISED	11-16-17
	09-12-18

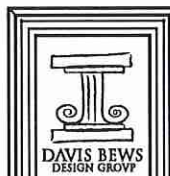

150 SEVENTH STREET EAST
 CLEARWATER, FLORIDA 34677
 813 - 925 - 1300 TEL.
 813 - 925 - 1800 FAX
 WWW.DAVISBEWS.COM
 TAMPA • DUNEDIN
 EST. 1994
 DRAWINGS ON 11"x17"
 SHEET ARE ONE HALF
 THE SCALE NOTED

**ENGAGE
H&H HOMES**

1755

TITLE
 ELECTRIC AT PLAN OPTIONS

SHEET
E3

SCALE NOTE:
LARGE FORMAT PRINTS ARE TO SCALE AS NOTED.
11" x 17" PRINTS ARE ONE HALF THE NOTED SCALE

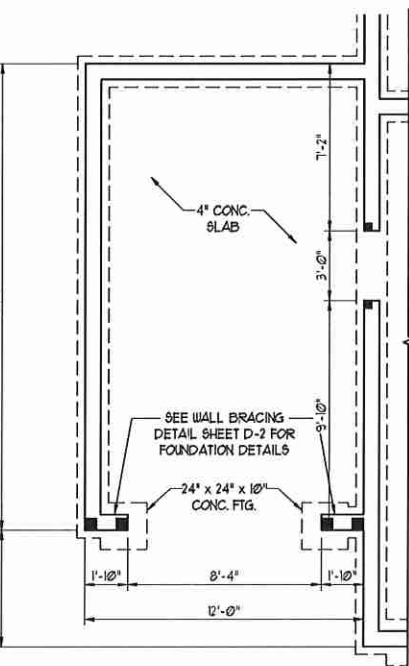
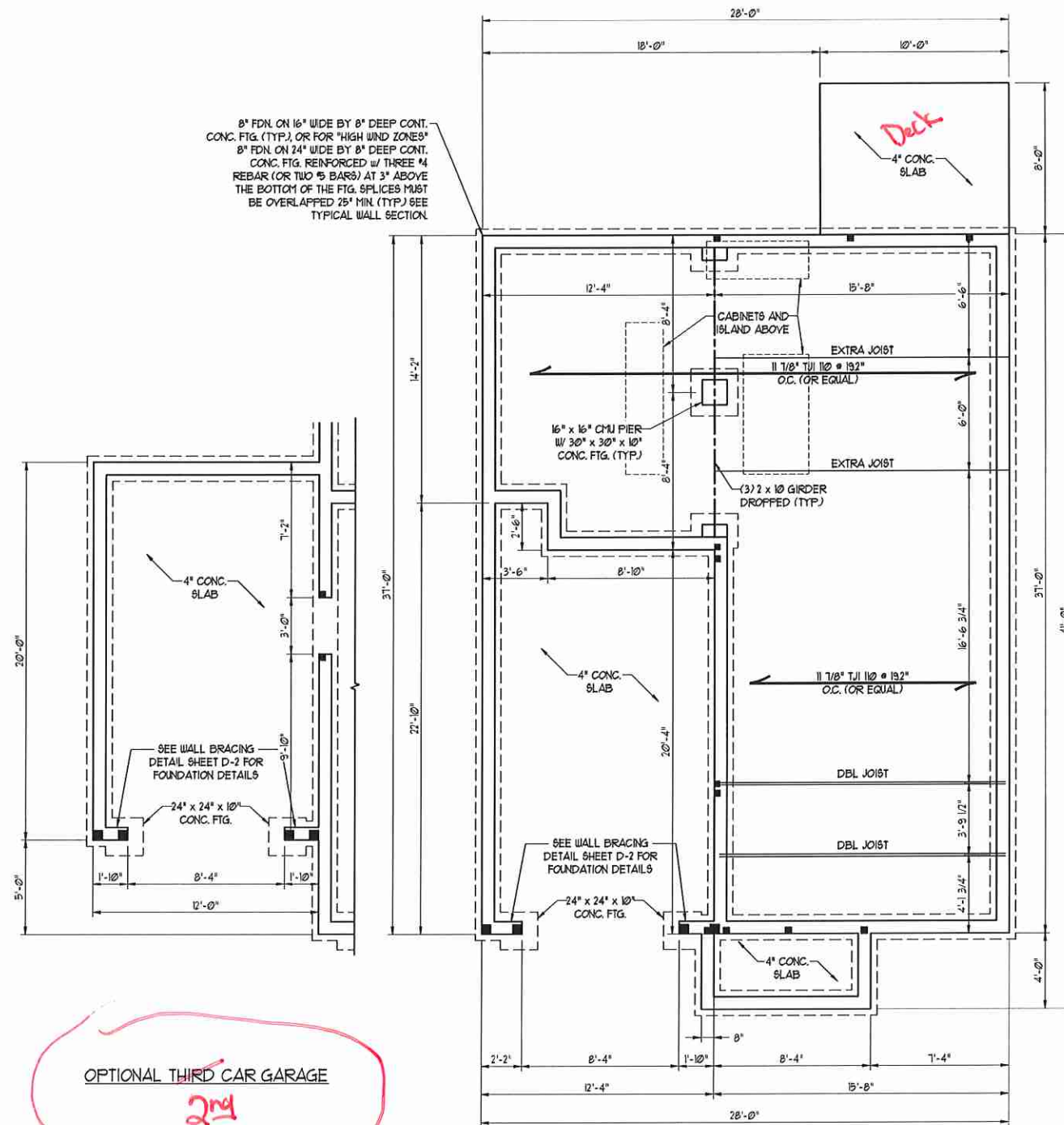

OPTIONAL THIRD CAR GARAGE
2nd

- 100-MPH WIND ZONE NOTES FOR LESS THAN 30' MEAN ROOF HEIGHT:**
- ENGINEER'S SEAL APPLIES ONLY TO STRUCTURAL COMPONENTS. ENGINEER'S SEAL DOES NOT CERTIFY DIMENSIONAL ACCURACY OR ARCHITECTURAL LAYOUT INCLUDING ROOF SYSTEM.
 - STRUCTURAL DESIGN PER NORTH CAROLINA RESIDENTIAL CODE, 2002 EDITION.
 - INSTALL 1/2" ANCHOR BOLTS 4'-0" O.C. AND WITHIN 1'-0" FROM END OF EACH PLATE. ANCHOR BOLTS MUST EXTEND A MINIMUM OF 1" INTO MASONRY OR CONCRETE.
 - MEAN ROOF HEIGHT IS LESS THAN 30 FEET.
 - EXTERIOR WALLS DESIGNED FOR 100 MPH WINDS.
 - WALL CLADDING DESIGNED FOR 241 PSF (POSITIVE AND NEGATIVE).
 - ROOF CLADDING DESIGNED FOR 210 PSF POSITIVE AND NEGATIVE FOR ROOF PITCHES 1/2 TO 3/8 AND 348 PSF (POSITIVE AND NEGATIVE) FOR ROOF PITCHES 2/3 TO 1/2.
 - INSTALL 7/8" OSB SHEATHING ON ALL EXTERIOR WALLS OF ALL STORIES IN ACCORDANCE WITH SECTION R602.03 OF THE NRC, 2002 EDITION. SEE THE WALL BRACING NOTES AND DETAILS SHEET FOR MORE INFORMATION.
 - ENERGY EFFICIENCY COMPLIANCE AND INSULATION VALUES OF THE BUILDING TO BE IN ACCORDANCE WITH CHAPTER 1 OF THE NRC, 2002 EDITION.
 - REFER TO NOTES AND DETAIL SHEETS FOR ADDITIONAL STRUCTURAL INFORMATION.

- 150-MPH WIND ZONE NOTES FOR LESS THAN 30' MEAN ROOF HEIGHT:**
- ENGINEER'S SEAL APPLIES ONLY TO STRUCTURAL COMPONENTS. ENGINEER'S SEAL DOES NOT CERTIFY DIMENSIONAL ACCURACY OR ARCHITECTURAL LAYOUT INCLUDING ROOF SYSTEM.
 - STRUCTURAL DESIGN PER NORTH CAROLINA RESIDENTIAL CODE, 2002 EDITION WITH SPECIAL CONSIDERATION TO CHAPTER 45 ('HIGH WIND ZONES' FOR 80 MPH WINDS).
 - BUILDER IS TO PROVIDE FRAMING CONNECTIONS AS REQUIRED BY CHAPTER 45 ('HIGH WIND ZONES' FOR 80 MPH WINDS) OF THE NORTH CAROLINA RESIDENTIAL CODE, 2002 EDITION.
 - FOUNDATION ANCHORAGE TO COMPLY WITH SECTION 4504 OF THE NORTH CAROLINA RESIDENTIAL CODE, 2002 EDITION.
 - MEAN ROOF HEIGHT IS LESS THAN 30 FEET.
 - WALL CLADDING DESIGNED FOR 401 PSF (POSITIVE AND NEGATIVE).
 - ROOF CLADDING DESIGNED FOR 356 PSF (POSITIVE AND NEGATIVE) FOR ROOF PITCHES 1/2 TO 3/8 AND 541 PSF (POSITIVE AND NEGATIVE) FOR ROOF PITCHES 2/3 TO 1/2.
 - 7/8" OSB SHEATHING IS REQUIRED ON ALL EXTERIOR WALLS.
 - WALLS TO BE BRACED IN ACCORDANCE WITH SECTION R602.10 OF THE NORTH CAROLINA RESIDENTIAL CODE, 2002 EDITION.
 - ENERGY EFFICIENCY COMPLIANCE AND INSULATION VALUES OF THE BUILDING TO BE IN ACCORDANCE WITH CHAPTER 1 OF THE NRC, 2002 EDITION.

- STRUCTURAL NOTES:**
- ALL FRAMING LUMBER TO BE #2 SPF (UNO). ALL TREATED LUMBER TO BE #2 SYP (UNO).
 - INSTALL AN EXTRA OR DOUBLE JOIST UNDER WALLS PARALLEL TO FLOOR JOISTS WHERE NOTED ON THE PLANS.
 - SQUARES DENOTE POINT LOADS WHICH REQUIRE SOLID BLOCKING TO GIRDER OR FOUNDATION.
 - SHADED PIERS TO BE FILLED SOLID.
 - INSTALL LADDER WIRE #16" O.C. TO SECURE MULTIPLE W/ THE FOUNDATION WALLS TOGETHER.
 - REFER TO NOTES AND DETAIL SHEETS FOR ADDITIONAL STRUCTURAL INFORMATION.

J.S. THOMPSON ENGINEERING INC.
600 WADSWORTH DRIVE, RALEIGH, NC 27605
PHONE: (919) 789-9919 FAX: (919) 789-9921
N.C. LICENSE NO. C-1713

ENGAGE - GARAGE LEFT
H & H HOMES

DATE: OCTOBER 29, 2018
SCALE: 1/4" = 1'-0"
DRAWN BY: DAVIS NEWS DESIGN CO.
ENGINEERED BY: WFB

SHEET 1 OF 8
S-1a
CRAWL
FOUNDATION PLAN



10/30/18

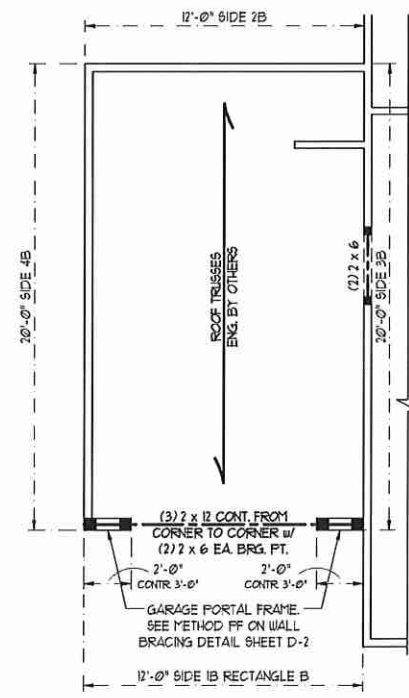

OPTIONAL THIRD CAR GARAGE
2nd

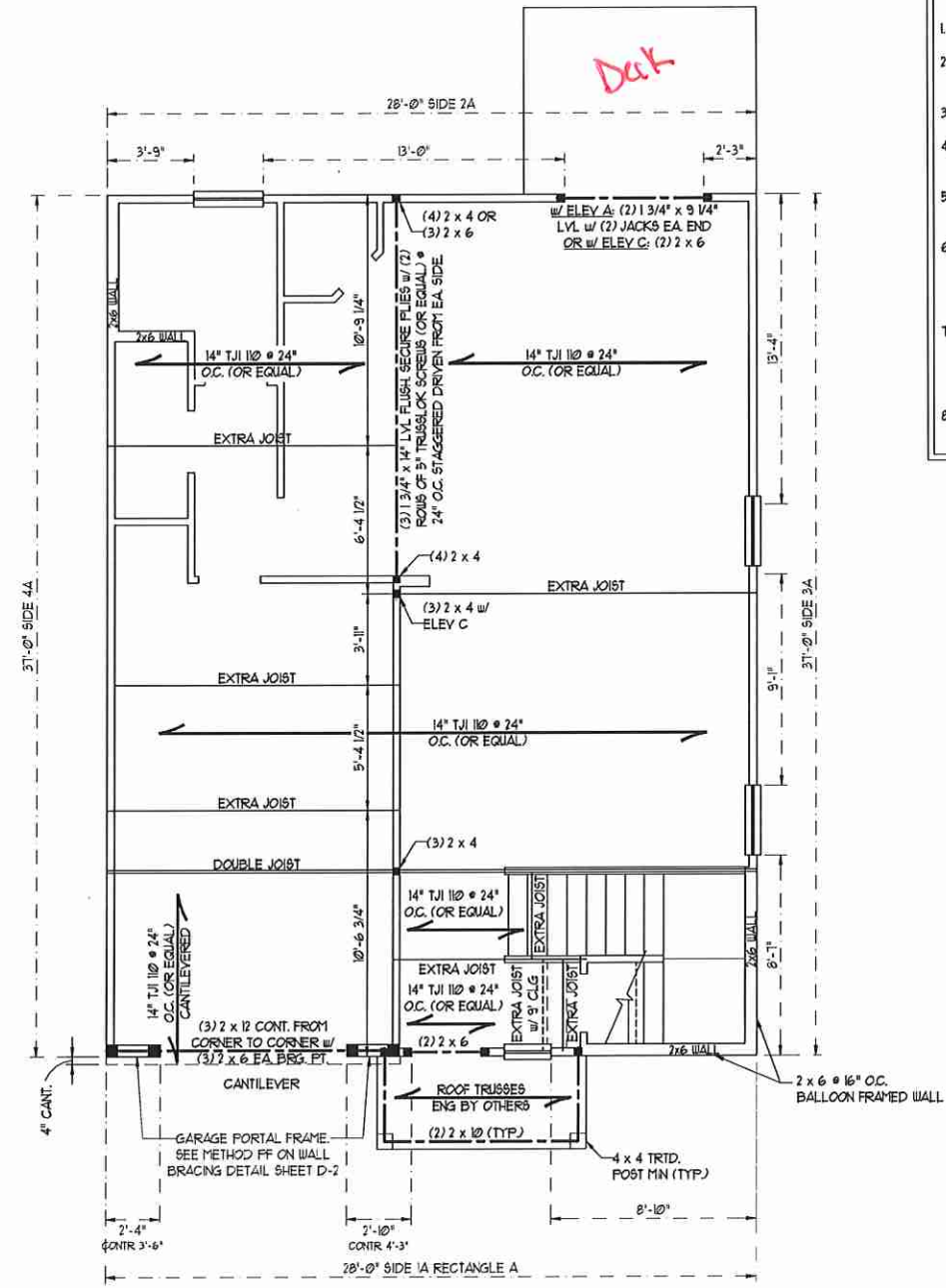

ELEVATION A

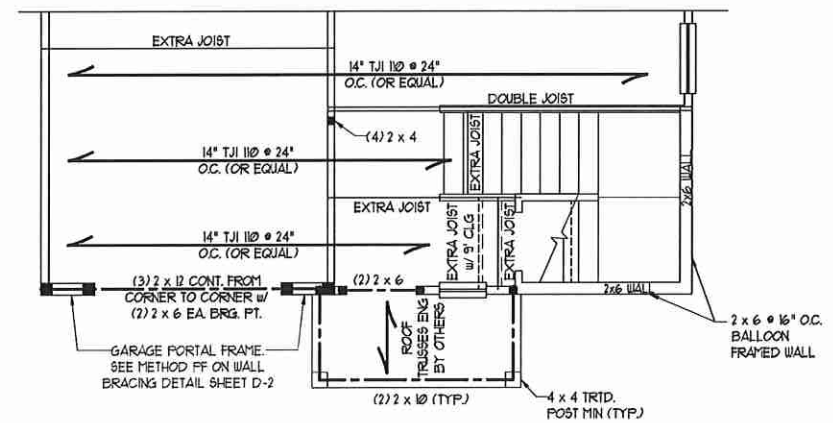

ELEVATION C

NOTE: ALL FIRST FLOOR EXTERIOR WALLS ARE TO BE 2 x 4 @ 16" O.C. 2 x 6 @ 16" O.C. FIRST FLOOR EXTERIOR WALLS MAY BE CONSTRUCTED IN LIEU OF 2 x 4 WALLS (UNO). ALL INTERIOR LOAD BEARING AND NON-LOAD BEARING WALLS ARE TO BE 2 x 4 SFF @ 24" O.C. (UNO).

SCALE NOTE:
LARGE FORMAT PRINTS ARE TO SCALE AS NOTED.
11" x 17" PRINTS ARE ONE HALF THE NOTED SCALE

- STRUCTURAL NOTES:**
- ALL FRAMING LUMBER TO BE SFF #2 (UNO). ALL TREATED LUMBER TO BE SYP #2 (UNO).
 - ALL LOAD BEARING HEADERS TO BE (2) 2 x 6 SFF #2 OR SYP #2 (KILN DRIED). HEADERS HAVE BEEN DESIGNED BASED ON CALCULATED LOADS. CODE TABLES HAVE NOT BEEN USED.
 - INSTALL AN EXTRA JOIST UNDER WALLS PARALLEL TO FLOOR JOISTS WHERE NOTED ON THE PLANS.
 - ALL BEAMS ARE TO BE SUPPORTED WITH (2) JACK STUDS EA. END (UNO). WINDOW AND DOOR HEADERS TO BE SUPPORTED W/ (1) JACK STUD AND (1) KING STUD EA. END (UNO).
 - SQUARES DENOTE POINT LOADS WHICH REQUIRE SOLID BLOCKING TO GIRDER OR FOUNDATION. ALL SQUARES TO BE (2) STUDS (UNO).
 - ALL 4 x 4 POSTS SHALL BE ANCHORED TO SLABS W/ SIMPSON ABU44 POST BASES (OR EQUAL) AND 6 x 6 POSTS W/ ABU66 POST BASES (OR EQUAL) (UNO). ALL 4 x 4 AND 6 x 6 POSTS TO BE INSTALLED WITH 100 LB CAPACITY UPLIFT CONNECTORS AT TOP (UNO).
 - FOR FIBERGLASS, ALUMINUM, OR COLUMN ENG. BY OTHERS, SECURE TO SLAB W/ (2) METAL ANGLES USING 2" CONC. SCREWS. FASTEN ANGLES TO COLUMNS W/ 1/4" THROUGH BOLTS W/ NUTS AND WASHERS. LOCATE ANGLES ON OPPOSITE SIDES OF COLUMN. THROUGH BOLTS MUST BE INSTALLED PRIOR TO SETTING COLUMN.
 - REFER TO NOTES AND DETAIL SHEETS FOR ADDITIONAL STRUCTURAL INFORMATION.

- BRACED WALL DESIGN NOTES:**
- BRACED WALL DESIGN PER SECTION R602.10 OF THE SIMPLIFIED WALL BRACING CRITERIA EFFECTIVE SEPTEMBER 1, 2013.
 - C5-WSP REFERS TO "CONTINUOUS SHEATHING - WOOD STRUCTURAL PANELS" CONTRACTOR IS TO INSTALL 1/8" OSB ON ALL EXTERIOR WALLS ATTACHED W/ 8d NAILS SPACED 6" O.C. ALONG PANEL EDGES AND 12" O.C. IN THE FIELD.
 - GB REFERS TO "GYPSUM BOARD" CONTRACTOR IS TO INSTALL 1/2" (MIN) GYPSUM WALL BOARD WHERE NOTED ON THE PLANS. FASTEN GB WITH 1 1/4" SCREWS OR 1 5/8" NAILS SPACED 1" O.C. ALONG PANEL EDGES AND IN THE FIELD INCLUDING TOP AND BOTTOM FLATES.
 - BRACED WALL DESIGN APPLIES IN WIND ZONES UP TO 110 MPH. FOR HIGH WIND ZONES, BRACE WALLS ARE TO BE CONSTRUCTED IN ACCORDANCE WITH CHAPTER 45 OF THE NCR 2012 EDITION. SEE NOTES AND DETAIL SHEETS FOR ADDITIONAL BRACED WALL INFORMATION.

BRACED WALL DESIGN

RECTANGLE A		RECTANGLE B	
SIDE 1A	METHOD: C5-WSP/FF TOTAL REQUIRED LENGTH: 14.1' TOTAL PROVIDED LENGTH: 16.5'	SIDE 1B	METHOD: C5-WSP/FF TOTAL REQUIRED LENGTH: 3.8' TOTAL PROVIDED LENGTH: 6.0'
SIDE 2A	METHOD: C5-WSP TOTAL REQUIRED LENGTH: 14.1' TOTAL PROVIDED LENGTH: 13'	SIDE 2B	METHOD: C5-WSP TOTAL REQUIRED LENGTH: 3.8' TOTAL PROVIDED LENGTH: 12.0'
SIDE 3A	METHOD: C5-WSP TOTAL REQUIRED LENGTH: 11.3' TOTAL PROVIDED LENGTH: 31'	SIDE 3B + 4A COMBINED	METHOD: C5-WSP TOTAL REQUIRED LENGTH: 8.36' TOTAL PROVIDED LENGTH: 30.5'
SIDE 4A	METHOD: C5-WSP TOTAL REQUIRED LENGTH: 11.3' TOTAL PROVIDED LENGTH: 31.33'	SIDE 4B	METHOD: C5-WSP TOTAL REQUIRED LENGTH: 2.66' TOTAL PROVIDED LENGTH: 16.33'

J.S. THOMPSON ENGINEERING INC
600 MADEIRA BLVD, SUITE 100, RALEIGH, NC 27605
PHONE: (919) 789-9910 FAX: (919) 789-9921
N.C. LICENSE NO.: C-17133

ENGAGE - GARAGE LEFT
H & H HOMES

DATE: OCTOBER 29, 2018
SCALE: 1/4" = 1'-0"
DRAWN BY: DAVIS BERS DESIGN CO.
ENGINEERED BY: WFB

SHEET 4 OF 8
S-2
SECOND FLOOR FRAMING PLAN

SCALE NOTE:
LARGE FORMAT PRINTS ARE TO SCALE AS NOTED.
11" x 17" PRINTS ARE ONE HALF THE NOTED SCALE

NOTE: ALL SECOND FLOOR EXTERIOR WALLS AND ATTIC WALLS ARE TO BE 2 x 4 SFF #2 @ 24" O.C. 2 x 6 SFF #2 @ 24" O.C. SECOND FLOOR EXTERIOR WALLS MAY BE CONSTRUCTED IN LIEU OF 2 x 4 WALLS (UNO). ALL INTERIOR LOAD BEARING AND NON-LOAD BEARING WALLS ARE TO BE 2 x 4 SFF #2 @ 24" O.C. (UNO).

BRACED WALL DESIGN NOTES:

1. BRACED WALL DESIGN PER SECTION R602.10 OF THE SIMPLIFIED WALL BRACING CRITERIA EFFECTIVE SEPTEMBER 1, 2013.
2. CS-USP REFERS TO "CONTINUOUS SHEATHING - WOOD STRUCTURAL PANELS" CONTRACTOR IS TO INSTALL 1/16" OSB ON ALL EXTERIOR WALLS ATTACHED w/ 8d NAILS SPACED 6" O.C. ALONG PANEL EDGES AND 12" O.C. IN THE FIELD.
3. GB REFERS TO "GYPSUM BOARD" CONTRACTOR IS TO INSTALL 1/2" (MIN) GYPSUM WALL BOARD WHERE NOTED ON THE PLANS. FASTEN GB WITH 1 1/4" SCREWS OR 1 5/8" NAILS SPACED 1" O.C. ALONG PANEL EDGES AND IN THE FIELD INCLUDING TOP AND BOTTOM FLATES.
4. BRACED WALL DESIGN APPLIES IN WIND ZONES UP TO 110 MPH. FOR HIGH WIND ZONES, BRACE WALLS ARE TO BE CONSTRUCTED IN ACCORDANCE WITH CHAPTER 45 OF THE NRC. 2012 EDITION. SEE NOTES AND DETAIL SHEETS FOR ADDITIONAL BRACED WALL INFORMATION.

NOTE:

1. PER SECTION R602.10.3.2 OF THE 2012 NRC, 2012 EDITION, THE AMOUNT OF BRACING ON THE SECOND FLOOR EXCEEDS THE AMOUNT REQUIRED FOR THE FIRST FLOOR AND NO BRACED WALL ANALYSIS IS REQUIRED.
2. SHEATH ALL EXTERIOR WALLS WITH 1/16" OSB SHEATHING ATTACHED WITH 8d NAILS AT 6" O.C. ALONG PANEL EDGES AND 12" O.C. IN THE FIELD.

STRUCTURAL NOTES:

1. ALL FRAMING LUMBER TO BE #2 SFF (UNO).
2. ALL LOAD BEARING HEADERS TO BE (2) 2 x 6 (UNO).
3. ALL BEAMS ARE TO BE SUPPORTED WITH (2) JACK STUDS EA. END (UNO). WINDOW AND DOOR HEADERS TO BE SUPPORTED w/ (1) JACK STUD AND (1) KING STUD EA. END (UNO).
4. SQUARES DENOTE POINT LOADS WHICH REQUIRE SOLID BLOCKING TO GIRDER OR FOUNDATION. SQUARES TO BE (2) STUDS (UNO).
5. REFER TO NOTES AND DETAIL SHEETS FOR ADDITIONAL STRUCTURAL INFORMATION.

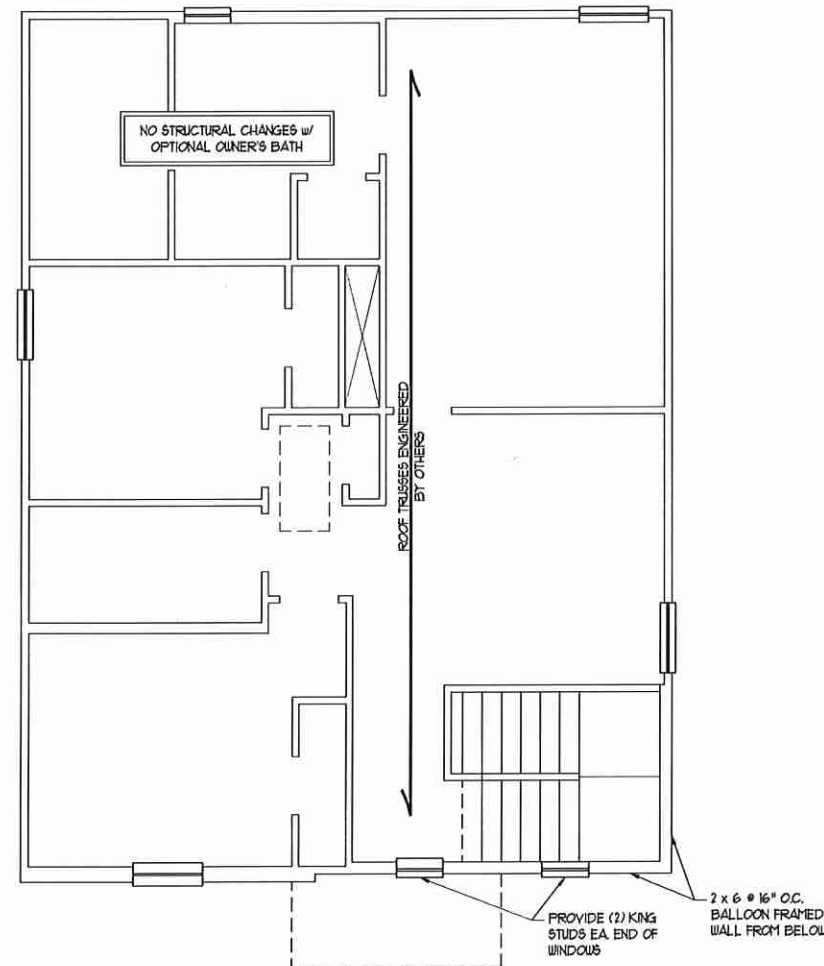

ELEVATION A



10/30/18

J.S. THOMPSON ENGINEERING, INC.
606 WADE AVE., SUITE 104 RALEIGH, NC 27605
PHONE: (919) 7899919 FAX: (919) 7899921
N.C. LICENSE NO. 61713

ENGAGE - GARAGE LEFT
H & H HOMES

DATE: OCTOBER 29, 2018
SCALE: 1/4" = 1'-0"
DRAWN BY: DWY'S BEWS DESIGN CO.
ENGINEERED BY: WFB

SHEET: 5 OF 8
S-3a
CEILING FRAMING
PLAN ELEV. A

SCALE NOTE:
 LARGE FORMAT PRINTS ARE TO SCALE AS NOTED.
 11" x 17" PRINTS ARE ONE HALF THE NOTED SCALE

- STRUCTURAL NOTES:**
1. ALL FRAMING LUMBER TO BE #2 SFF (NO).
 2. CIRCLES DENOTE (3) 2 x 4 POSTS FOR ROOF SUPPORT.
 3. FRAME DORMER WALLS ON TOP OF DOUBLE OR TRIPLE RAFTERS.
 4. HIP SPLICES ARE TO BE SPACED A MIN. OF 8'-0". FASTEN MEMBERS WITH THREE ROWS OF 12d NAILS @ 16" O.C. (TYP)
 5. STICK FRAME OVER-FRAME ROOF SECTIONS W 2 x 8 RIDGES, 2 x 6 RAFTERS @ 16" O.C. AND FLAT 2 x 10 VALLEYS OR USE VALLEY TRUSSES.
 6. FASTEN FLAT VALLEYS TO RAFTERS OR TRUSSES WITH SIMPSON H25A HURRICANE TIES @ 32" O.C. MAX. PASS HURRICANE TIES THROUGH NOTCH IN ROOF SHEATHING. EACH RAFTER IS TO BE FASTENED TO THE FLAT VALLEY WITH A MIN. OF (6) 12d TOE NAILS.
 7. REFER TO NOTES AND DETAIL SHEETS FOR ADDITIONAL STRUCTURAL INFORMATION.

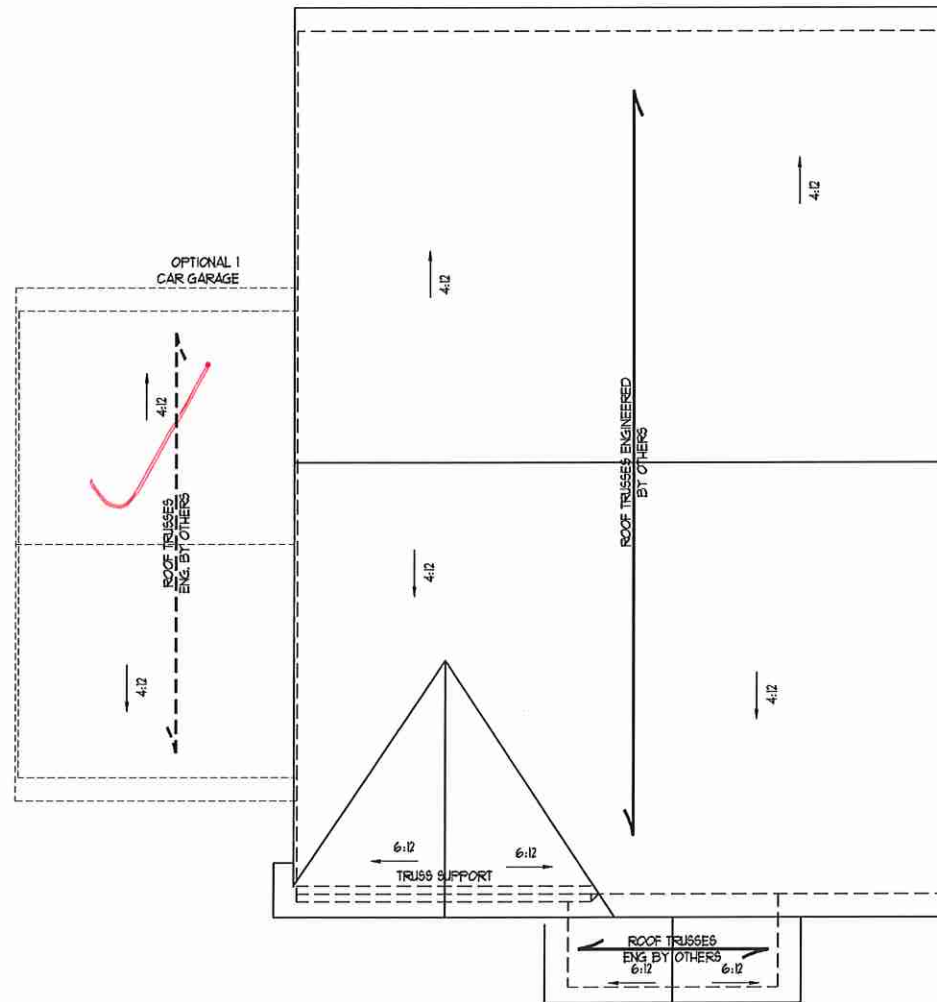

ELEVATION A



10/30/18

J.S. THOMPSON ENGINEERING, INC
 606 WADE AVE., SUITE 104 RALEIGH, NC 27605
 PHONE (919) 7899919 FAX (919) 7899921
 N.C. LICENSE NO. 01131

ENGAGE - GARAGE LEFT
 H & H HOMES

DATE: OCTOBER 29, 2018
 SCALE: 1/4" = 1'-0"
 DRAWN BY: DAVIS BICKS DESIGN CO.
 ENGINEERED BY: WTB

SHEET 7 OF 8
 S4a
 ROOF FRAMING PLAN

MONOLITHIC SLAB DETAILS

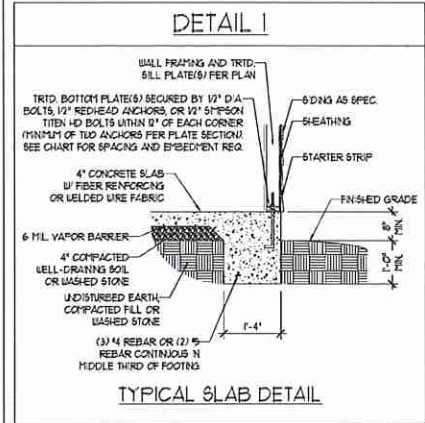

TYPICAL SLAB DETAIL

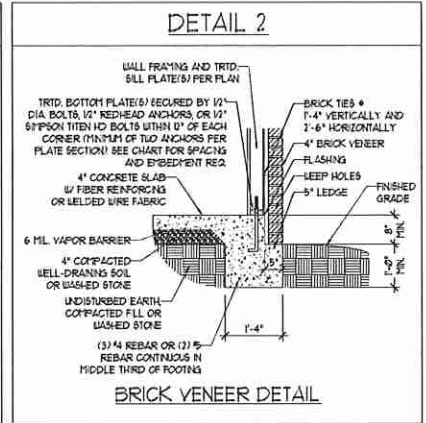

BRICK VENEER DETAIL

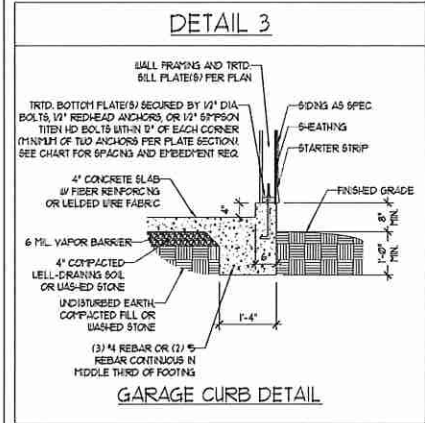

GARAGE CURB DETAIL

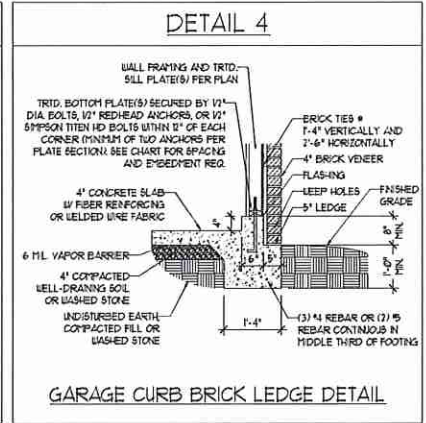

GARAGE CURB BRICK LEDGE DETAIL

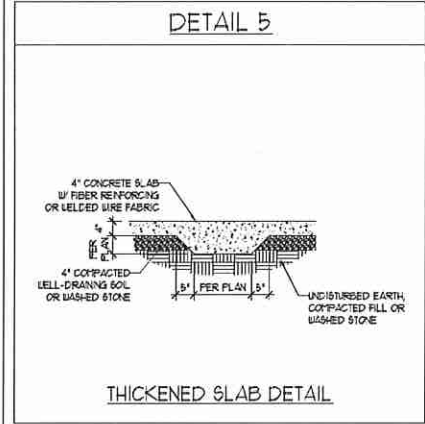

THICKENED SLAB DETAIL

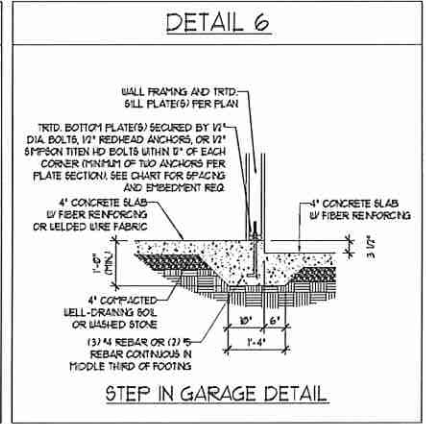

STEP IN GARAGE DETAIL

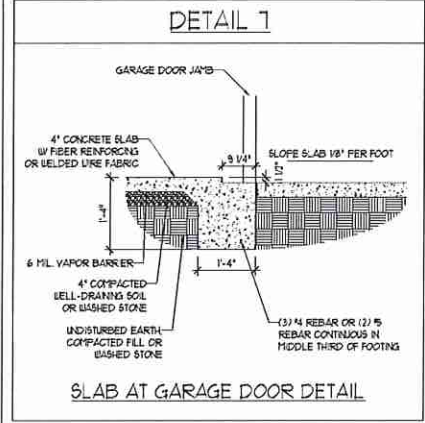

SLAB AT GARAGE DOOR DETAIL

STEM WALL DETAILS

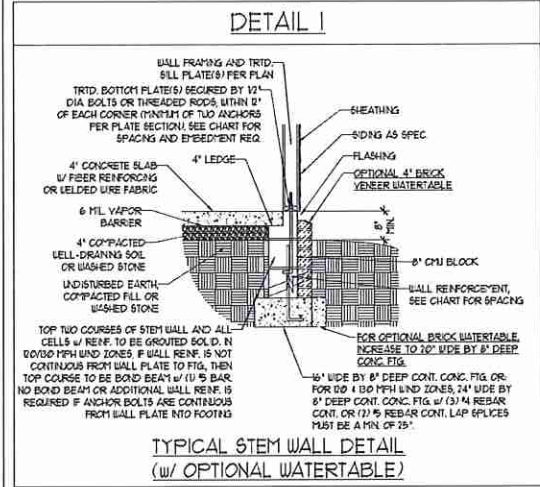

TYPICAL STEM WALL DETAIL (w/ OPTIONAL WATERTABLE)

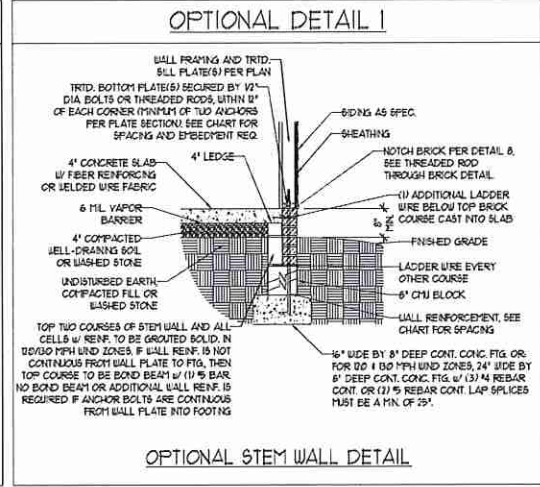

OPTIONAL STEM WALL DETAIL

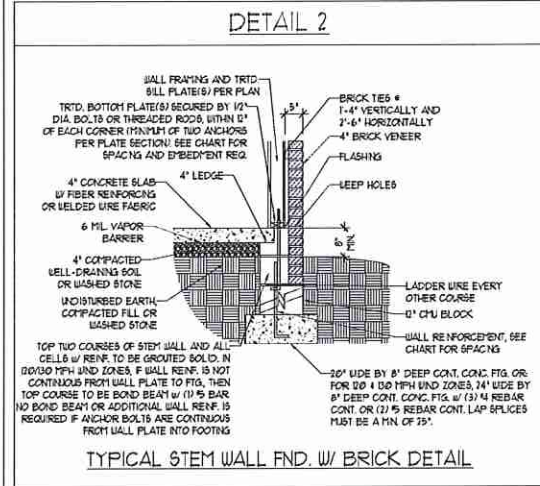

TYPICAL STEM WALL FND. w/ BRICK DETAIL

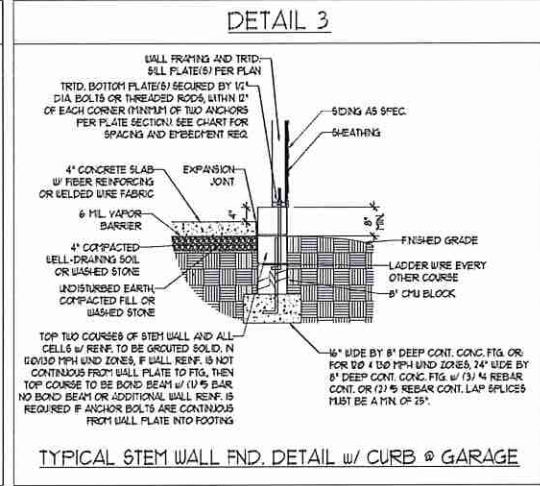

TYPICAL STEM WALL FND. DETAIL w/ CURB @ GARAGE

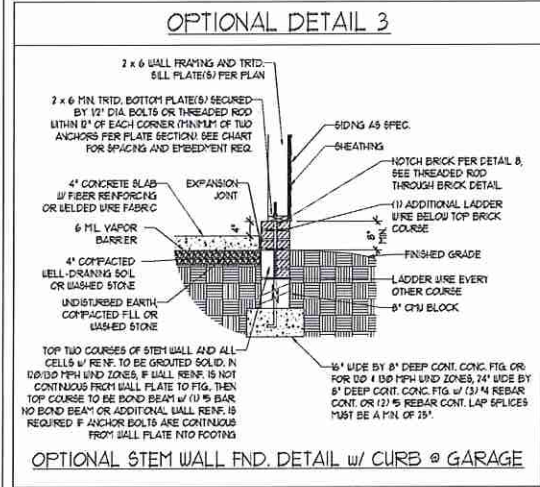

OPTIONAL STEM WALL FND. DETAIL w/ CURB @ GARAGE

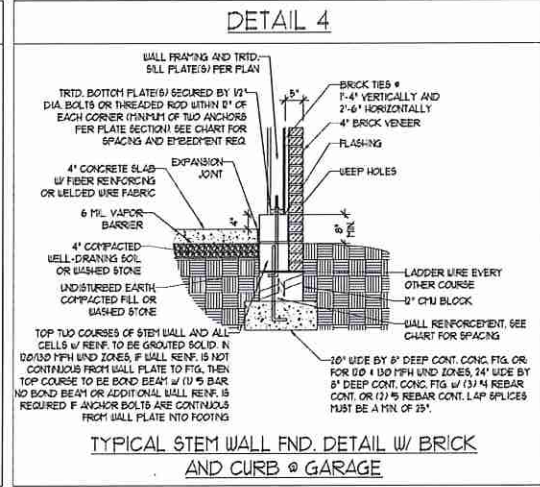

TYPICAL STEM WALL FND. DETAIL w/ BRICK AND CURB @ GARAGE

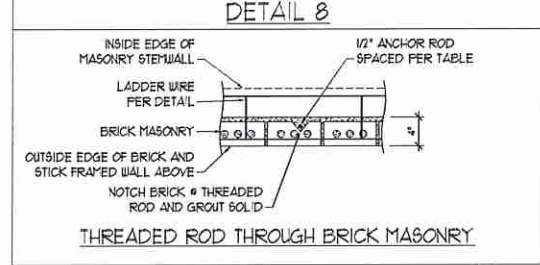

THREADED ROD THROUGH BRICK MASONRY

MASONRY STEMWALL SPECIFICATIONS

WALL HEIGHT (FEET)	MASONRY WALL TYPE			
	8" CMU	4" BRICK AND 4" CMU	4" BRICK AND 8" CMU	12" CMU
2 AND BELOW	UNGRADED	GROUT SOLID	UNGRADED	UNGRADED
3	UNGRADED	GROUT SOLID	UNGRADED	UNGRADED
4	GROUT SOLID	GROUT SOLID w/ 1/4" REBAR @ 48" O.C.	GROUT SOLID	GROUT SOLID w/ 1/4" REBAR @ 64" O.C.
5	GROUT SOLID w/ 1/4" REBAR @ 36" O.C.	NOT APPLICABLE	GROUT SOLID w/ 1/4" REBAR @ 36" O.C.	GROUT SOLID w/ 1/4" REBAR @ 64" O.C.
6	GROUT SOLID w/ 1/4" REBAR @ 24" O.C.	NOT APPLICABLE	GROUT SOLID w/ 1/4" REBAR @ 24" O.C.	GROUT SOLID w/ 1/4" REBAR @ 64" O.C.
1 AND GREATER	ENGINEERED DESIGN BASED ON SITE CONDITIONS			

STRUCTURAL NOTES:

1. WALL HEIGHT MEASURED FROM TOP OF FOOTING TO TOP OF THE WALL.
2. TIE MULTIPLE WALLS TOGETHER WITH LADDER WIRE AT 16" O.C. VERTICALLY.
3. CHART APPLICABLE FOR HOUSE FOUNDATION ONLY. CONSULT ENGINEER FOR DESIGN OF GARAGE FOUNDATION NOT COMMON TO HOUSE.
4. BACKFILL OF CLEAN #51 / #1 WASHED STONE IS ALLOWABLE.
5. BACKFILL OF WELL DRAINED OR SAND - GRAVEL MIXTURE SOILS (45 PCT FT BELOW GRADE) CLASSIFIED AS GROUP 1 ACCORDING TO UNIFIED SOILS CLASSIFICATION SYSTEM IN ACCORDANCE WITH TABLE 2002.1 OF THE 2012 INTERNATIONAL RESIDENTIAL CODE ARE ALLOWABLE.
6. PREP SLAB PER R202.2.1 AND R202.2.2 BASE OF THE 2012 INTERNATIONAL RESIDENTIAL CODE. MINIMUM 24" LAP SPlice LENGTH.
7. LOCATE REBAR IN CENTER OF FOUNDATION WALL.
8. WHERE REQUIRED, FILL BLOCK SOLID WITH TYPE "S" MORTAR OR 3000 PSI GROUT. USE OF "LOW LIFT GROUTING" METHOD REQUIRED WHEN FILLING WALLS WITH GROUT AT HEIGHTS OF 5' AND GREATER.

ANCHOR SPACING AND EMBEDMENT

	120 MPH		130 MPH	
	SPACING	EMBEDMENT	SPACING	EMBEDMENT
WIND ZONE	100 MPH	110 MPH	120 MPH	130 MPH
SPACING	6'-0" O.C.	4'-0" O.C.	6'-0" O.C. w/ DBL. BILL PLATE OR 4'-0" O.C. w/ SINGLE BILL PLATE w/ 2" x 2" x 1/8" WASHERS	6'-0" O.C. w/ DBL. BILL PLATE OR 4'-0" O.C. w/ SINGLE BILL PLATE w/ 2" x 2" x 1/8" WASHERS
EMBEDMENT	7"	5" INTO MASONRY 1" INTO CONCRETE	5" INTO MASONRY 1" INTO CONCRETE	5" INTO MASONRY 1" INTO CONCRETE

NOTE: HORIZONTAL FOOTING REBAR REQUIRED IN HIGH WIND ZONES ONLY (120 MPH - 130 MPH)



10/30/18

J.S. THOMPSON ENGINEERING, INC.
606 WADE AVE., SUITE 104 - RALEIGH, NC 27605
PHONE: (919) 789-9919 FAX: (919) 789-9921
N.C. LICENSE NO.: C1133

FOUNDATION DETAILS

DATE: JULY 11, 2018
SCALE: NTS
DRAWN BY: JST
ENGINEERED BY: JES

D-1 FOUNDATION DETAILS

GENERAL WALL BRACING NOTES:

1. WALL BRACING DESIGNED IN ACCORDANCE WITH CHAPTER 6 OF THE 2012 NC RESIDENTIAL BUILDING CODE (NRC). TABLES AND FIGURES REFERENCED ARE FROM THE 2012 NRC.
2. SEE THIS SHEET FOR GENERAL DETAILS. REFER TO THE 2012 NRC FOR ADDITIONAL INFORMATION AS NEEDED.
3. SEE STRUCTURAL SHEETS FOR BRACED WALL LOCATIONS, DIMENSIONS, HOLD DOWN TYPE AND LOCATIONS, BRACED WALL LINE KEY WITH WALL DESIGN SUMMARY OF REQUIRED/PROVIDED TOTALS FOR EACH WALL LINE AND ANY SPECIAL NOTES OR REQUIREMENTS.
4. ALL EXTERIOR WALLS ARE TO BE SHEATHED WITH CS-WSF IN ACCORDANCE WITH SECTION R602.10.3 UNLESS NOTED OTHERWISE.
5. ALL EXTERIOR AND INTERIOR WALLS TO HAVE 1/2" GYPSUM INSTALLED. WHEN NOT USING METHOD "GB", GYPSUM TO BE FASTENED PER TABLE R602.3.5. METHOD GB TO BE FASTENED PER TABLE R602.10.1
6. CS-WSF REFERS TO THE "CONTINUOUS SHEATHING - WOOD STRUCTURAL PANELS" WALL BRACING METHOD. 1/16" OSB SHEATHING IS TO BE INSTALLED ON ALL EXTERIOR WALLS ATTACHED w/ 6d COMMON NAILS OR 8d (2 1/2" LONG x 0.131" DIAMETER) NAILS SPACED 6" O.C. ALONG PANEL EDGES AND 12" O.C. IN THE FIELD (UNO).
7. GB REFERS TO THE "GYPSUM BOARD" WALL BRACING METHOD. 1/2" (MIN) GYPSUM WALL BOARD IS TO BE INSTALLED ON BOTH SIDES OF THE BRACED WALL FASTENED WITH 1 1/4" SCREWS OR 1 5/8" NAILS SPACED 1" O.C. ALONG PANEL EDGES INCLUDING TOP AND BOTTOM PLATES AND INTERMEDIATE SUPPORTS (UNO). VERIFY ALL FASTENER OPTIONS FOR 1/2" AND 5/8" GYPSUM PRIOR TO CONSTRUCTION. FOR INTERIOR FASTENER OPTIONS SEE TABLE R102.3.5. FOR EXTERIOR FASTENER OPTIONS SEE TABLE R602.3(1). EXTERIOR GB TO BE INSTALLED VERTICALLY.
8. REQUIRED BRACED WALL LENGTH FOR EACH SIDE OF THE CIRCUMSCRIBED RECTANGLE ARE INTERPOLATED PER TABLE R602.10.3. METHOD CS-WSF CONTRIBUTES ITS ACTUAL LENGTH, METHOD GB CONTRIBUTES 5 ITS ACTUAL LENGTH, AND METHOD PF CONTRIBUTES 15 TIMES ITS ACTUAL LENGTH.

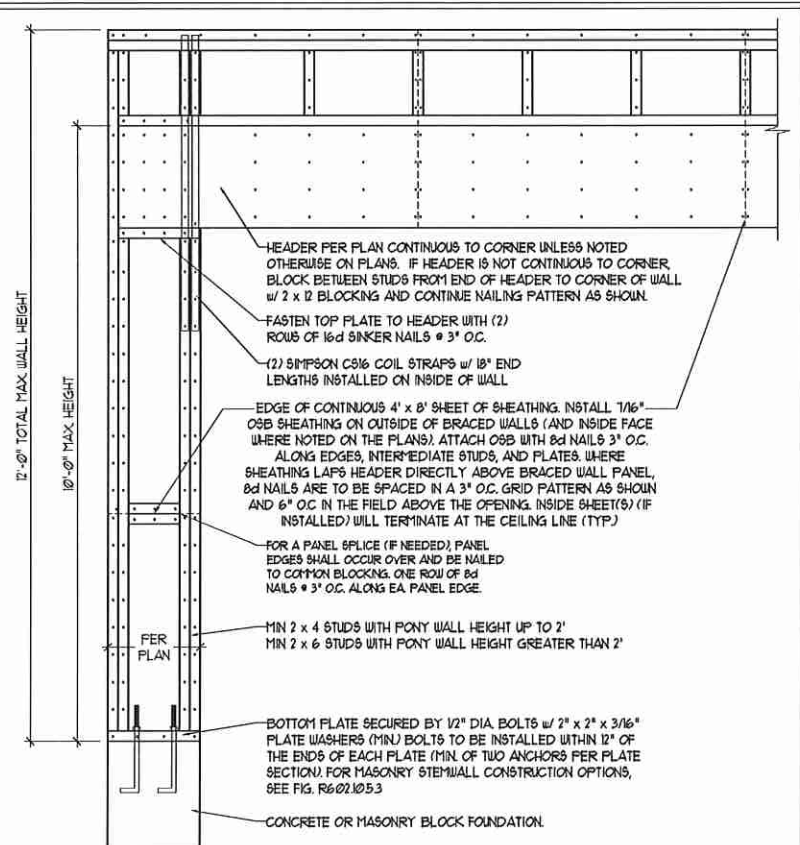

OVER CONCRETE OR MASONRY BLOCK FOUNDATION

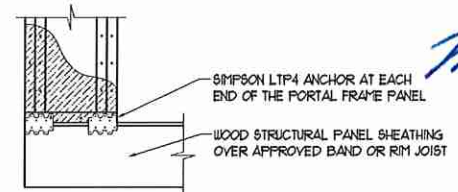

OVER RAISED WOOD FLOOR - FRAMING ANCHOR OPTION
 * APPLICABLE w/ GREATER THAN 12" KNEE WALL HEIGHTS IN CRAWL SPACE AND ABOVE FRAMED BASEMENT WALLS *

METHOD PF-PORTAL FRAME DETAIL ①



10/30/18

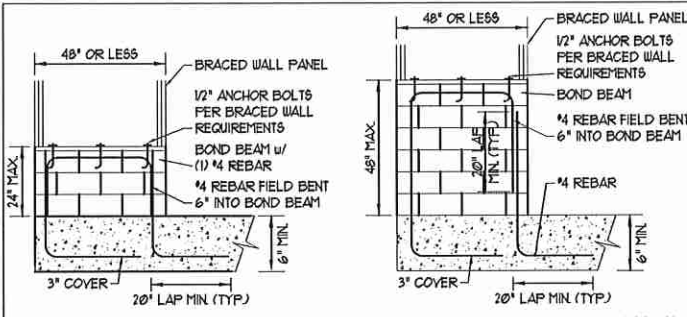

SHORT STEM WALL REINFORCEMENT

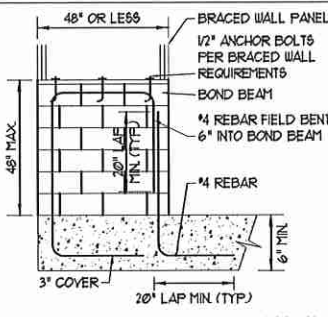

TALL STEM WALL REINFORCEMENT

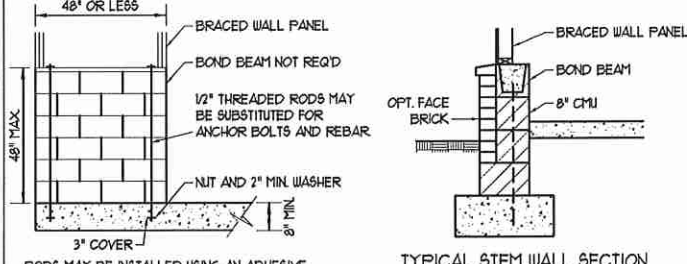

TYPICAL STEM WALL SECTION

RODS MAY BE INSTALLED USING AN ADHESIVE ANCHORING SYSTEM WITH A MINIMUM TENSILE CAPACITY OF 3150 LBS AND INSTALLED IN ACCORDANCE WITH MANUFACTURER'S SPECS.

OPTIONAL STEM WALL REINFORCEMENT

NOTE: GROUT BOND BEAMS AND ALL CELLS WHICH CONTAIN REBAR THREADED RODS AND ANCHOR BOLTS

MASONRY STEM WALLS SUPPORTING BRACED WALL PANELS ②

PER FIGURE R602.10.5.3

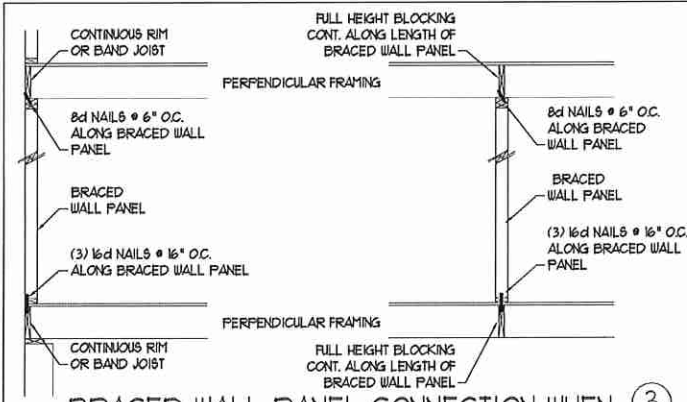

BRACED WALL PANEL CONNECTION WHEN PERPENDICULAR TO FLOOR/CEILING FRAMING ③

PER FIGURE CR602.10.5.4(1)

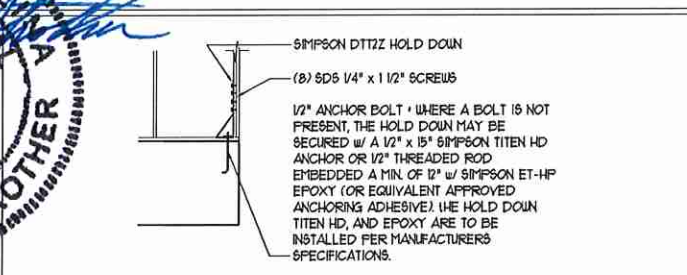

HOLD DOWN DETAIL FOR MASONRY FOUNDATION OR MONOLITHIC SLAB ④

* APPLICABLE ONLY WHERE SPECIFIED ON PLAN *

TYPICAL EXTERIOR CORNER FRAMING FOR CONTINUOUS SHEATHING ⑤

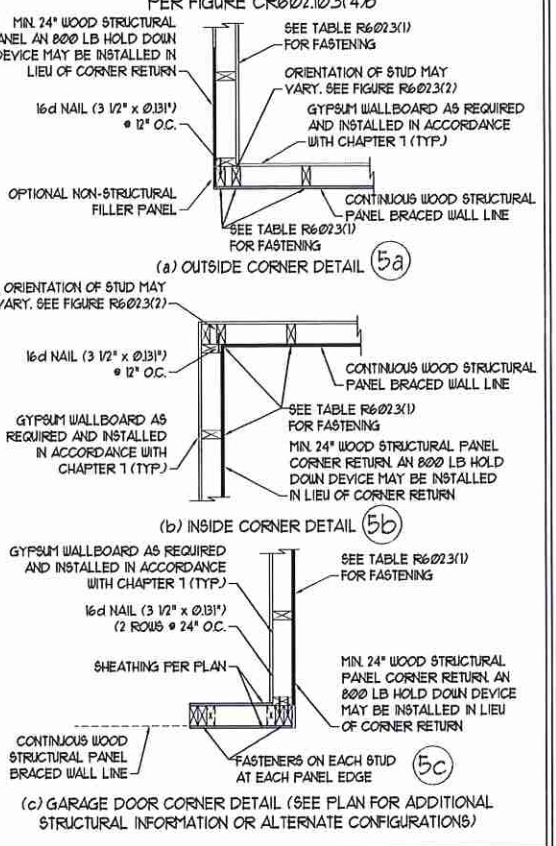

BRACED WALL PANEL CONNECTION WHEN PARALLEL TO FLOOR/CEILING FRAMING ⑥

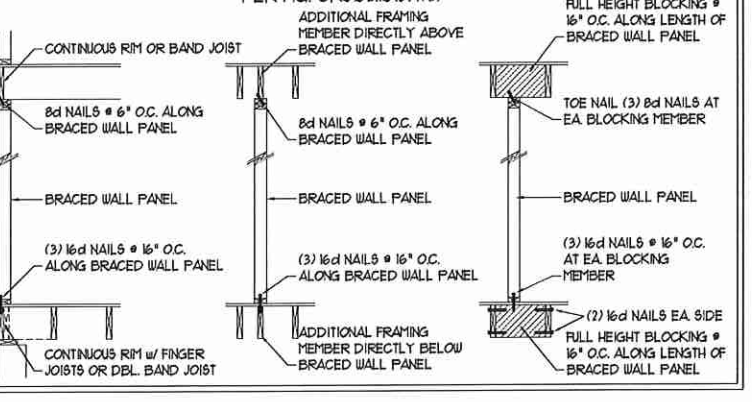

HOLD DOWN DETAIL FOR MONOLITHIC SLAB ⑦

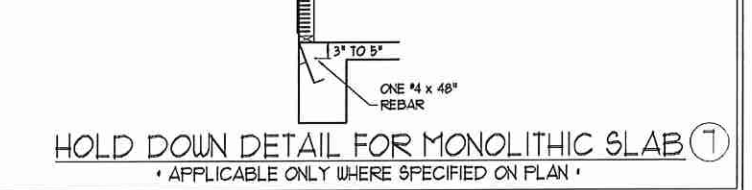

HOLD DOWN DETAIL FOR MONOLITHIC SLAB ⑦

* APPLICABLE ONLY WHERE SPECIFIED ON PLAN *

SCALE NOTE:
 -24" x 36" PRINTS ARE TO SCALE AS NOTED.
 11" x 17" PRINTS ARE ONE HALF THE NOTED SCALE

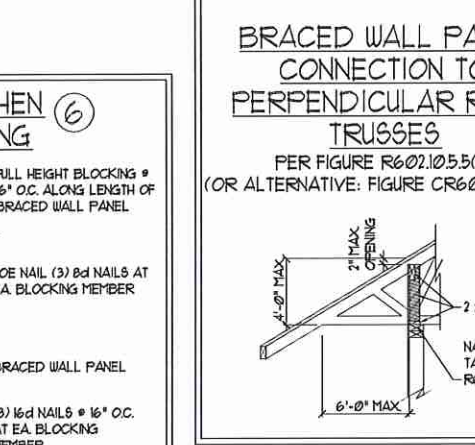
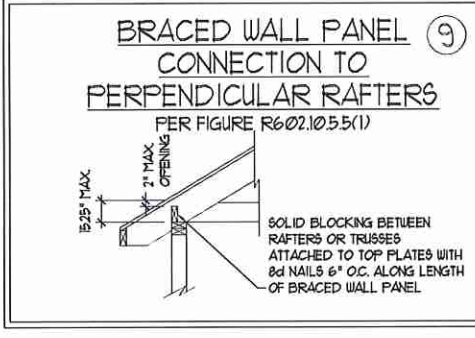
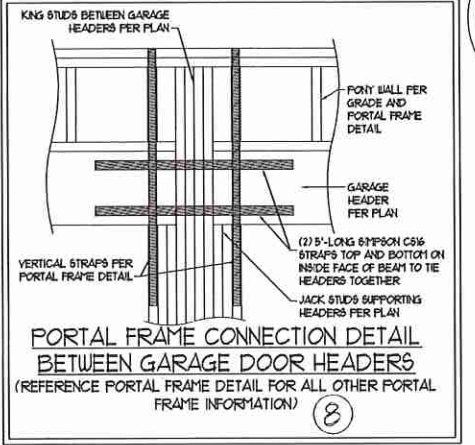

DATE: MARCH 19, 2018
 SCALE: NONE
 DRAWN BY: JST
 ENGINEERED BY: JST
 REVIEWED BY: JST

This sealed page is to be used in conjunction with a full plan set engineered by J.S. Thompson Engineering, Inc. only. Use of this individual sealed page within architectural pages or shop drawings by others is a punishable offense under N.C. Statute § 89C-23

J.S. THOMPSON ENGINEERING INC
 600 WALL STREET, 14th FLOOR, RALEIGH, NC 27605
 PHONE: (919) 789-9100 FAX: (919) 789-9211
 N.C. LICENSE NO. C-1733

WALL BRACING NOTES AND DETAILS

D-2
 BRACED WALL AND PORTAL FRAME DETAILS

GENERAL NOTES

- ENGINEER'S SEAL APPLIES ONLY TO STRUCTURAL COMPONENTS INCLUDING ROOF RAFTERS, HIPS, VALLEYS, RIDGES, FLOORS, WALLS, BEAMS, HEADERS, COLUMNS, CANTILEVERS, OFFSET LOAD BEARING WALLS, PIERS, GIRDER SYSTEM AND FOOTING. ENGINEER'S SEAL DOES NOT CERTIFY DIMENSIONAL ACCURACY OF ARCHITECTURAL LAYOUT INCLUDING ROOF. ENGINEER'S SEAL DOES NOT APPLY TO I-JOIST OR FLOOR/ROOF TRUSS LAYOUT DESIGN AND ACCURACY.
- ALL CONSTRUCTION SHALL CONFORM TO THE LATEST REQUIREMENTS OF THE NORTH CAROLINA RESIDENTIAL CODE (NRC), 2012 EDITION, PLUS ALL LOCAL CODES AND REGULATIONS. THE STRUCTURAL ENGINEER IS NOT RESPONSIBLE FOR, AND WILL NOT HAVE CONTROL OF, CONSTRUCTION MEANS, METHODS, TECHNIQUES, SEQUENCES OR PROCEDURES, OR SAFETY PRECAUTIONS AND PROGRAMS IN CONNECTION WITH THE CONSTRUCTION WORK. NOR WILL THE ENGINEER BE RESPONSIBLE FOR THE CONTRACTOR'S FAILURE TO CARRY OUT THE CONSTRUCTION WORK IN ACCORDANCE WITH THE CONTRACT DOCUMENTS.
- STRUCTURAL DESIGN BASED ON THE PROVISIONS OF THE NRC, 2012 EDITION (R301.4 - R301.7)

DESIGN CRITERIA:	LIVE LOAD (PSF)	DEAD LOAD (PSF)	DEFLECTION (IN)
ATTIC WITH LIMITED STORAGE	20	10	L/240
ATTIC WITHOUT STORAGE	10	10	L/360
DECKS	40	10	L/360
EXTERIOR BALCONIES	40	10	L/360
FIRE ESCAPES	40	10	L/360
HANDRAILS/GUARDRAILS	200 LB OR 50 (PLF)	10	L/360
PASSENGER VEHICLE GARAGE	50	10	L/360
ROOMS OTHER THAN SLEEPING ROO	40	10	L/360
SLEEPING ROOMS	30	10	L/360
STAIRS	40	10	L/360
WIND LOAD	(BASED ON FIGURE R301.2(4) WIND ZONE AND EXPOSURE)		
GROUND SNOW LOAD: P _g	20 (PSF)		

- I-JOIST SYSTEMS DESIGNED WITH 12 PSF DEAD LOAD AND DEFLECTION (IN) OF L/480
- FLOOR TRUSS SYSTEMS DESIGNED WITH 15 PSF DEAD LOAD

- FOR 30 AND 100 MPH WIND ZONES, FOUNDATION ANCHORAGE IS TO COMPLY WITH SECTION R403.1.6 OF THE NRC, 2012 EDITION. FOR 110 MPH, 120 MPH, AND 130 MPH WIND ZONES, FOUNDATION ANCHORAGE IS TO COMPLY WITH SECTION 450.4 OF THE NRC, 2012 EDITION.
- ENERGY EFFICIENCY COMPLIANCE AND INSULATION VALUES OF THE BUILDING TO BE IN ACCORDANCE WITH CHAPTER 11 OF THE NRC, 2012 EDITION.

FOOTING AND FOUNDATION NOTES

- FOUNDATION DESIGN BASED ON A MINIMUM ALLOWABLE BEARING CAPACITY OF 2000 PSF. CONTACT GEOTECHNICAL ENGINEER IF BEARING CAPACITY IS NOT ACHIEVED.
- FOR ALL CONCRETE SLABS AND FOOTINGS, THE AREA WITHIN THE PERIMETER OF THE BUILDING ENVELOPE SHALL HAVE ALL VEGETATION, TOP SOIL AND FOREIGN MATERIAL REMOVED. FILL MATERIAL SHALL BE FREE OF VEGETATION AND FOREIGN MATERIAL. THE FILL SHALL BE COMPACTED TO ASSURE UNIFORM SUPPORT OF THE SLAB, AND EXCEPT WHERE APPROVED, THE FILL DEPTHS SHALL NOT EXCEED 24" FOR CLEAN SAND OR GRAVEL. A 4" THICK BASE COURSE CONSISTING OF CLEAN GRADED SAND OR GRAVEL SHALL BE PLACED. A BASE COURSE IS NOT REQUIRED WHERE A CONCRETE SLAB IS INSTALLED ON WELL-DRAINED OR SAND-GRAVEL MIXTURE SOILS CLASSIFIED AS GROUP 1, ACCORDING TO THE UNITED SOIL CLASSIFICATION SYSTEM IN ACCORDANCE WITH TABLE R405.1 OF THE NRC, 2012 EDITION.
- PROPERLY DEWATER EXCAVATION PRIOR TO POURING CONCRETE WHEN BOTTOM OF CONCRETE SLAB IS AT OR BELOW WATER TABLE. IF APPLICABLE, 3/4" - 1" DEEP CONTROL JOINTS ARE TO BE SAUED WITHIN 4 TO 12 HOURS OF CONCRETE FINISHING AND WALL LOCATIONS HAVE BEEN MARKED. ADJUST WHERE NECESSARY.
- CONCRETE SHALL CONFORM TO SECTION R402.2 OF THE NRC, 2012 EDITION. CONCRETE REINFORCING STEEL TO BE ASTM A615 GRADE 60. WELDED WIRE FABRIC TO BE ASTM A105. MAINTAIN A MINIMUM CONCRETE COVER AROUND REINFORCING STEEL OF 3" IN FOOTINGS AND 1 1/2" IN SLABS. FOR POURED CONCRETE WALLS, CONCRETE COVER FOR REINFORCING STEEL MEASURED FROM THE INSIDE FACE OF THE WALL SHALL NOT BE LESS THAN 3/4". CONCRETE COVER FOR REINFORCING STEEL MEASURED FROM THE OUTSIDE FACE OF THE WALL SHALL NOT BE LESS THAN 1 1/2" FOR #5 BARS OR SMALLER, AND NOT LESS THAN 2" FOR #6 BARS OR LARGER.
- MASONRY UNITS TO CONFORM TO ACE 530/ASCE 5/7/15 402. MORTAR SHALL CONFORM TO ASTM C270.
- THE UNSUPPORTED HEIGHT OF MASONRY PIERS SHALL NOT EXCEED FOUR TIMES THEIR LEAST DIMENSION FOR UNFILLED HOLLOW CONCRETE MASONRY UNITS AND TEN TIMES THEIR LEAST DIMENSION FOR SOLID OR SOLID FILLED PIERS. PIERS MAY BE FILLED SOLID WITH CONCRETE OR TYPE M OR S MORTAR. PIERS AND WALLS SHALL BE CAPPED WITH 8" OF SOLID MASONRY.
- THE CENTER OF EACH OF THE PIERS SHALL BEAR IN THE MIDDLE THIRD OF ITS RESPECTIVE FOOTING. EACH GIRDER SHALL BEAR IN THE MIDDLE THIRD OF THE PIERS.
- ALL CONCRETE AND MASONRY FOUNDATION WALLS ARE TO BE CONSTRUCTED IN ACCORDANCE WITH THE PROVISIONS OF SECTION R404 OF THE NRC, 2012 EDITION OR IN ACCORDANCE WITH ACI 318, ACI 332, NCM TR68-A OR ACE 530/ASCE 5/7/15 402. MASONRY FOUNDATION WALLS ARE TO BE REINFORCED PER TABLE R404.1(1), R404.1(2), R404.1(3), OR R404.1(4) OF THE NRC, 2012 EDITION. CONCRETE FOUNDATION WALLS ARE TO BE REINFORCED PER TABLE R404.1(5) OF THE NRC, 2012 EDITION. STEP CONCRETE FOUNDATION WALLS TO 2 x 6 FRAMED WALLS AT 16" O.C. WHERE GRADE PERMITS (UNO).

This sealed page is to be used in conjunction with a full plan set engineered by J.S. Thompson Engineering, Inc. only. Use of this individual sealed page within architectural pages or shop drawings by others is a punishable offense under N.C. Statute § 89C-23

FRAMING NOTES

- ALL FRAMING LUMBER SHALL BE #2 SFF MINIMUM (Fb = 815 PSI, Fv = 315 PSI, E = 1600000 PSI) UNLESS NOTED OTHERWISE (UNO). TREATED LUMBER SHALL BE #2 SYP MINIMUM (Fb = 915 PSI, Fv = 115 PSI, E = 1600000 PSI) UNLESS NOTED OTHERWISE (UNO).
- LAMINATED VENEER LUMBER (LVL) SHALL HAVE THE FOLLOWING MINIMUM PROPERTIES: Fb = 2600 PSI, Fv = 285 PSI, E = 1900000 PSI. LAMINATED STRAND LUMBER (LSL) SHALL HAVE THE FOLLOWING MINIMUM PROPERTIES: Fb = 2375 PSI, Fv = 310 PSI, E = 1900000 PSI. PARALLEL STRAND LUMBER (PSL) UP TO 1" DEPTH SHALL HAVE THE FOLLOWING MINIMUM PROPERTIES: Fc = 2500 PSI, E = 1800000 PSI. PARALLEL STRAND LUMBER (PSL) MORE THAN 1" DEPTH SHALL HAVE THE FOLLOWING MINIMUM PROPERTIES: Fc = 2300 PSI, E = 2000000 PSI. INSTALL ALL CONNECTIONS PER MANUFACTURER'S SPECIFICATIONS.
- STRUCTURAL STEEL SHALL CONFORM TO THE FOLLOWING ASTM SPECIFICATIONS
 - A. W AND WT SHAPES: ASTM A992
 - B. CHANNELS AND ANGLES: ASTM A36
 - C. PLATES AND BARS: ASTM A36
 - D. HOLLOW STRUCTURAL SECTIONS: ASTM A500 GRADE B
 - E. STEEL PIPE: ASTM A53, GRADE B, TYPE E OR S
- STEEL BEAMS SHALL BE SUPPORTED AT EACH END WITH A MINIMUM BEARING LENGTH OF 3 1/2" AND FULL FLANGE WIDTH (UNO). PROVIDE SOLID BEARINGS FROM BEAM SUPPORT TO FOUNDATION. BEAMS SHALL BE ATTACHED AT THE BOTTOM FLANGE TO EACH SUPPORT AS FOLLOWS (UNO):
 - A. WOOD FRAMING: (2) 1/2" DIA. x 4" LONG LAG SCREWS
 - B. CONCRETE: (2) 1/2" DIA. x 4" WEDGE ANCHORS
 - C. MASONRY (FULLY GROUTED): (2) 1/2" DIA. x 4" LONG SIMPSON TITEN HD ANCHORS

LATERAL SUPPORT IS CONSIDERED ADEQUATE PROVIDING THE JOISTS ARE TOE NAILED TO THE 2x NAILER ON TOP OF THE STEEL BEAM, AND THE 2x NAILER IS SECURED TO THE TOP OF THE STEEL BEAM w/ (2) ROWS OF SELF TAPPING SCREWS @ 16" O.C. OR (2) ROWS OF 1/2" DIAMETER BOLTS @ 16" O.C. IF 1/2" BOLTS ARE USED TO FASTEN THE NAILER, THE STEEL BEAM SHALL BE FABRICATED w/ (2) ROWS OF 3/16" DIAMETER HOLES @ 16" O.C.

- SQUARES DENOTE POINT LOADS WHICH REQUIRE SOLID BLOCKING TO GIRDER OR FOUNDATION. SHADED SQUARES DENOTE POINT LOADS FROM ABOVE WHICH REQUIRE SOLID BLOCKING TO SUPPORTING MEMBER BELOW.
- ALL LOAD BEARING HEADERS TO CONFORM TO TABLE R502.5(1) AND R502.5(2) OF THE NRC, 2012 EDITION OR BE (2) 2 x 6 WITH (1) JACK AND (1) KING STUD EACH END (UNO) WHICHEVER IS GREATER. ALL HEADERS TO BE SECURED TO EACH JACK STUD WITH (4) 8d NAILS. ALL BEAMS TO BE SUPPORTED WITH (2) STUDS AT EACH BEARING POINT (UNO).
- ALL BEAMS, HEADERS, OR GIRDER TRUSSES PARALLEL TO WALL ARE TO BEAR FULLY ON (1) JACK OR (2) STUDS MINIMUM OR THE NUMBER OF JACKS OR STUDS NOTED. ALL BEAMS OR GIRDER TRUSSES PERPENDICULAR TO WALL AND SUPPORTED BY (3) STUDS OR LESS ARE TO HAVE 1 1/2" MINIMUM BEARING (UNO). ALL BEAMS OR GIRDER TRUSSES PERPENDICULAR TO WALL AND SUPPORTED BY MORE THAN (3) STUDS OR OTHER NOTED COLUMN ARE TO BEAR FULLY ON SUPPORT COLUMN FOR ENTIRE WALL DEPTH (UNO). BEAM ENDS THAT BUTT INTO ONE ANOTHER ARE TO EACH BEAR EQUAL LENGTHS (UNO).
- FLITCH BEAMS SHALL BE BOLTED TOGETHER USING 1/2" DIAMETER BOLTS (ASTM A307) WITH WASHERS PLACED AT THREADED END OF BOLT. BOLTS SHALL BE SPACED AT 24" CENTERS (MAXIMUM), AND STAGGERED AT TOP AND BOTTOM OF BEAM (2" EDGE DISTANCE), WITH (2) BOLTS LOCATED AT 6" FROM EACH END (UNO).
- ALL I-JOIST OR TRUSS LAYOUTS ARE TO BE IN COMPLIANCE WITH THE OVERALL DESIGN SPECIFIED ON THE PLANS. ALL DEVIATIONS ARE TO BE BROUGHT TO THE ATTENTION OF THE ENGINEER OF RECORD PRIOR TO INSTALLATION.
- BRACED WALL PANELS SHALL BE CONSTRUCTED ACCORDING TO THE CURRENT NORTH CAROLINA RESIDENTIAL CODE WALL BRACING CRITERIA. THE AMOUNT, LENGTH, AND LOCATION OF BRACING SHALL COMPLY WITH ALL APPLICABLE TABLES IN SECTION R602.10.
- PROVIDE DOUBLE JOIST UNDER ALL WALLS PARALLEL TO FLOOR JOISTS. PROVIDE SUPPORT UNDER ALL WALLS PARALLEL TO FLOOR TRUSSES OR I-JOISTS PER MANUFACTURER'S SPECIFICATIONS. INSTALL BLOCKING BETWEEN JOISTS OR TRUSSES FOR POINT LOAD SUPPORT FOR ALL POINT LOADS ALONG OFFSET LOAD LINES.
- FOR ALL HEADERS SUPPORTING BRICK VENEER THAT ARE LESS THAN 8'-0" IN LENGTH, REST A 6" x 4" x 5/16" STEEL ANGLE WITH 6" MINIMUM EMBEDMENT AT SIDES FOR BRICK SUPPORT. FOR ALL HEADERS 8'-0" AND GREATER IN LENGTH, BOLT A 6" x 4" x 5/16" STEEL ANGLE TO HEADER WITH 1/2" LAG SCREWS AT 12" O.C. STAGGERED FOR BRICK SUPPORT. FOR ALL BRICK SUPPORT AT ROOF LINES, BOLT A 6" x 4" x 5/16" STEEL ANGLE TO 2 x 10 BLOCKING INSTALLED BETWEEN WALL STUDS WITH 1/2" LAG SCREWS AT 12" O.C. STAGGERED AND IN ACCORDANCE WITH SECTION R103.1.2.2 OF THE NRC, 2012 EDITION.
- FOR STICK FRAMED ROOFS: CIRCLES DENOTE (3) 2 x 4 POSTS FOR ROOF MEMBER SUPPORT. HIP SPLICES ARE TO BE SPACED A MINIMUM OF 8'-0". FASTEN MEMBERS WITH THREE ROWS OF 12d NAILS AT 16" O.C. FRAME DORMER WALLS ON TOP OF DOUBLE OR TRIPLE RAFTERS AS SHOWN (UNO).
- FOR TRUSSED ROOFS: FRAME DORMER WALLS ON TOP OF 2 x 4 LADDER FRAMING AT 24" O.C. BETWEEN ADJACENT ROOF TRUSSES. STICK FRAME OVER-FRAMED ROOF SECTIONS WITH 2 x 8 RIDGES, 2 x 6 RAFTERS AT 16" O.C. AND FLAT 2 x 10 VALLEYS (UNO).
- ALL 4 x 4 AND 6 x 6 POSTS TO BE INSTALLED WITH 700 LB CAPACITY UPLIFT CONNECTORS TOP AND BOTTOM (UNO). POSTS MAY BE SECURED USING ONE SIMPSON H6 OR L192 UPLIFT CONNECTOR FASTENED TO THE BAND AT THE BOTTOM AND THE BEAM AT THE TOP OF EACH POST. ONE 16" SECTION OF SIMPSON C516 COIL STRAPPING WITH (8) 8d HDG NAILS AT EACH END MAY BE USED IN LIEU OF EACH TUBS STRAP IF DESIRED. FOR MASONRY OR CONCRETE FOUNDATION USE SIMPSON POST BASE.



10/30/18

J.S. THOMPSON ENGINEERING, INC.
 606 WADE AVE., SUITE 104 RALEIGH, NC 27605
 PHONE: (919) 789-9919 FAX: (919) 789-9921
 N.C. LICENSE NO. C173

STANDARD STRUCTURAL NOTES

DATE: DECEMBER 22, 2017
SCALE: N/A
DRAWN BY: JES
ENGINEERED BY: JES
REVIEWED BY: JST

S-0
STRUCTURAL NOTES