



Fire Marshal Division

October 24, 2018

David Benzo
221 Technology Park Ln.
Fuquay-Varina, NC 27526

**Re: Grace Community Church
2160 Harnett Central Rd.
Angier, NC 27501**

Application Number FMFW-1810-0009

Mr. Benzo,

Thank you for submitting the fire alarm replacement paperwork. The request for change has been carefully reviewed by a qualified code enforcement official to examine for compliance with the North Carolina Fire Prevention Code and all other fire protection regulatory documents. There are some items that need to be addressed before a final inspection of the new panel can be given. These items are outlined and described below.

- **Fire Alarm System Upgrade Notes**

All items in notes are to be completed at the time of final.

- Provide a record of completion.
- The Fire marshal's office will complete an acceptance test at completion of project.
- Provide a copy of account history after the acceptance test is completed and approve.
- Provide an accurate zone map at the FACP and remote annunciator panel.
- All work/installation shall be compliant with the NCSFC and NFPA 72.
- Call Fire Marshal's office to schedule the fire alarm acceptance test. (910-984-4003)



Thank you again for submitting the fire alarm panel upgrade. Please review and adhere to any notes. These remarks are for the paperwork that was submitted and its original intent. These remarks do not apply if the original intent changes or what was submitted on the above date changes. If you have any questions, please do not hesitate to call this office.

Again, thank you and we look forward to working with you during the construction period!

Sincerely,



D. Banks Wallace
Chief Deputy Fire Marshal



Fire Marshal Division

P.O. Box 370
Lillington, NC 27546
910-893-7580

Application for Plan Review

Application # _____ - FMFW1810-0009

Date Received: 10/22/18 Received By: Both P.

Name of Project: GRACE COMMUNITY CHURCH

Physical Address of Project: 2160 HARNET CENTRAL RD.
ANGIER NC _____

Plans Submitted By: DAVID BENZO

Project Phone: (919) 586 4369

Contact Person/Address: DAVID BENZO, 221 TECHNOLY PARK LN., FUQUAY-VARINA, NC 27526

Contact Phone: (919) 762 3703 (____) - ____ - ____

Contractor's Name/Info: PROSERVE FIRE

Contractor's Phone: (919) 586 4369

- Plans that are submitted will be reviewed as quickly as possible with an average time of review between 7-10 working days.
- Status checks may be conducted on plan reviews by visiting the website <http://hteweb.harnett.org/Click2GovBP/Index.jsp> or by calling the Harnett County Central Permitting Office (910-893-4759), or the Harnett County Fire Marshal's Office (910-893-7580).
- Approved plans must be picked up from the Central Permitting Office and all fees paid before any required inspections can be conducted.

ES-50X

Intelligent Addressable FACP with Communicator



Addressable Fire Alarm Control Panels

General

The ES-50X is the latest intelligent addressable fire alarm control panel (FACP) from Fire-Lite Alarms. The ES-50X comes with a pre-installed communicator and supports up to 50 addressable devices in any combination of detectors or modules. With an extensive list of powerful features, the ES-50X programs just like Fire-Lite's other addressable panels, yet fits into applications previously served only by conventional panels.

The pre-installed IPOTS-COM is a dual technology (POTS and IP) communicator. The POTS transmits system status (alarms, troubles, AC loss, etc.) to a Central Station via the public switched telephone network. The IP communicator's internet monitoring capability sends alarm signals over the Internet saving the monthly cost of two dedicated business telephone lines. Although not required, the secondary telephone line may be retained providing backup communication over the public switched telephone line. Optional cellular reporting is available using the CELL-MOD or CELL-CAB-FL.

Remote and local programming of the control panel is possible using the FS-Tools Upload/Download utility. Programming databases can be uploaded/downloaded via the panel's USB port (and USB cable) or via an ethernet connection using the IPOTS-COM communicator. The USB port also allows for the download or upload of the entire program, history file, walk-test data, current status and system voltages by means of a USB flash drive.

The power supply and all electronics are contained on a circuit board supported on a new quick install chassis and housed in a metal cabinet. Available accessories include local and remote upload/download software, remote annunciators, and reverse polarity/city box transmitter (4XTMF).

Features

- Listed to UL Standard 864, 10th edition
- Pre-installed IPOTS-COM Ethernet IP and POTS (Plain Old Telephone Service) Central Station Communicator
- Optional CELL-MOD or CELL-CAB-FL GSM Central Station Communicator over AlarmNet®
- Compatible with SWIFT® wireless devices
- Auto-programming (learn mode) reduces installation time. Reports two devices set to the same address
- Two independently programmable, built-in Style Z (Class A) or Style Y (Class B) NAC circuits
- Selectable strobe synchronization for System Sensor, Wheelock, and Gentex devices
- Notification Appliance Circuit End of Line resistor matching
- Four programmable function keys for ease of maintenance
- Two programmable relays and one fixed trouble relay
- Built-in Programmer
- Integral 80-character LCD display with backlighting
- Real-time clock/calendar with automatic daylight savings control
- History file with 1,000 event capacity
- Addressable sounder base
- Multi-criteria detector (smoke, heat, CO) with programmable response
- Control module delay timer
- Automatic detector sensitivity testing (NFPA 72 compliant)
- Automatic device type-code verification
- Point trouble identification
- Waterflow selection per module point
- Alarm verification selection per detector point



- Maintenance alert warns when smoke detector dust accumulation is excessive
- One-person audible or silent walktest with walktest log & printout
- System alarm verification selection per detector point
- PAS (Positive Alarm Sequence) and Pre-signal per point (NFPA 72 compliant)
- Up to 16 ANN-BUS annunciators- 8 per each ANN-Bus
- Remote Acknowledge, Alarm Silence, Reset and Drill via addressable modules or remote annunciator
- Upload/Download of program and data via USB with optional FS-Tools Programming Utility

SLC COMMUNICATION LOOP

- Supports LiteSpeed™ and CLIP protocols
- SLC operates up to 10,000 ft. (3,000 m) in LiteSpeed mode with twisted, unshielded wire
- Single addressable SLC loop which meets NFPA Class B and Class A requirements
- 50 addressable device capacity (any combination of addressable detectors and modules)
- Compatible with Fire-Lite's addressable devices (refer to the *SLC Wiring Manual*)

NOTIFICATION APPLIANCE CIRCUITS (NACS)

- Two independently programmable output circuits. Circuits can be configured for the following outputs:
 - Style Y (Class B)
 - Style Z (Class A)
 - Silence Inhibit and Autosilence timer options
 - Continuous, March Time, Temporal, or California code for main circuit board NACs with two-stage capability
 - Selectable strobe synchronization per NAC
 - 2.5 A special application, 250mA regulated, total power for NACs
- NOTE:** Maximum or total 24VDC system power shared between all NAC circuits and the ANN-BUS is 2.7 A

PROGRAMMING AND SOFTWARE

- Autoprogramming (learn mode) reduces installation time

- Custom English labels (per point) may be manually entered or selected from an internal library file
- Two programmable Form-C relay outputs
- 50 software zones
- Continuous fire protection during online programming
- Program Check automatically catches common errors not linked to any zone or input point
- **OFFLINE PROGRAMMING:** Create the entire program in your office using FS-Tools, a Windows®-based software package, and upload/download system programming locally. Offline programming requires an ethernet connection. FS-Tools is available on www.firelite.com.

User interface

LED INDICATORS

- Fire Alarm (red)
- CO Alarm (red)
- AC Power (green)
- Supervisory (yellow)
- Trouble (yellow)
- Ground fault (yellow)
- Battery fault (yellow)
- Disabled (yellow)
- Maintenance (yellow)
- Communication (yellow)
- Alarm Silenced (yellow)
- F1-F4 Programmable Function Keys (yellow)

KEYPAD

- 16 key alpha-numeric pad
- Acknowledge
- Alarm Silence
- Drill (Manual Evacuate)
- Four (4) programmable function keys
- Reset (lamp test)

Product Line Information

ES-50X: Addressable Fire Alarm Control Panel with one SLC loop. Includes main circuit board with display, pre-installed IPOTS-COM communicator, chassis with transformer, backbox with door, plastic bag containing screws, cables, key, etc. (For ES-50XC, refer to DF-60954.)

FS-Tools: Programming software for Windows®-based PC computer. Available for download at www.firelite.com.

CELL-CAB-FL/CELL-MOD: Optional GSM communicators.

IPOTS-COM: Dual technology (POTS and IP) communicator. (replacement board)

DP-ES-R: Optional dress panel for the ES-50X.

TR-CE: Optional trim ring for semi-flush mounting.

BB-2F: Optional cabinet for one or two modules.

BB-6F: Optional cabinet for up to six modules mounted on CHS-6 chassis.

BB-26: Battery backbox, holds up to two 25 AH batteries & CHG-75.

BB-55F: Battery box, houses two 55 AH batteries

CHS-6: Chassis, mounts up to six multi-modules in a BB-6F cabinet.

CHG-75: Battery charger for lead-acid batteries with a rating of 25 to 75 AH.

CHG-120F: Remote battery charging system for lead-acid batteries with a rating of 55 to 120 AH. Requires additional BB-55F for mounting.

BAT Series: Batteries, see data sheet DF-52397.

PRN Series: UL listed compatible event printer. Uses tractor-fed paper.

OPTIONAL MODULES

4XTMF Reverse Polarity Transmitter Module: Provides a supervised output for local energy municipal box transmitter, alarm and trouble. Includes a disable switch and disable trouble LED.

COMPATIBLE ANNUNCIATORS

ANN-80: Remote, red LCD annunciator mimics the information displayed on the FACP LCD display. Recommended wire type is unshielded.

ANN-100: Remote LCD annunciator mimics the information displayed on the FACP LCD display. Recommended wire type is unshielded. For use in FM applications only.

ANN-I/O: LED Driver Module provides connections to a user supplied graphic annunciator. (See DF-52430.)

ANN-LED: Annunciator Module provides three LEDs for each zone: Alarm, Trouble, and Supervisory. Ships with red enclosure. (See DF-60241.)

ANN-RLED: Provides alarm (red) indicators for up to 30 input zones or addressable points. (See DF-60241.)

ANN-RLY: Relay Module provides 10 programmable Form-C relays. Can be mounted inside the cabinet. (See DF-52431.)

ANN-S/PG: Serial/Parallel Printer Gateway module provides a connection for a serial or parallel printer. (See DF-52429.)

ADDRESSABLE DEVICES

All feature a polling LED and rotary switches for addressing.

SD365: Addressable low-profile photoelectric smoke detector. LiteSpeed only.

SD365-IV: Addressable low-profile photoelectric smoke detector. Ivory. LiteSpeed and CLIP mode.

SD365T: Addressable low-profile photoelectric smoke detector with thermal sensor. LiteSpeed only.

SD365T-IV: Addressable low-profile photoelectric smoke detector with thermal sensor. Ivory. LiteSpeed and CLIP mode.

SD365R: Remote test capable addressable photoelectric smoke detector for use with DNR(W) duct detector housing. LiteSpeed only.

SD365R-IV: Remote test capable addressable photoelectric smoke detector for use with DNR(W) duct detector housing. Ivory. LiteSpeed and CLIP mode.

H365: Low-profile 135°F fixed thermal sensor. LiteSpeed only.

H365-IV: Low-profile 135°F fixed thermal sensor. Ivory. LiteSpeed and CLIP mode.

H365R: Low-profile, intelligent, rate-of-rise thermal sensor. LiteSpeed only.

H365R-IV: Low-profile, intelligent, rate-of-rise thermal sensor. Ivory. LiteSpeed and CLIP mode.

H365HT: Low-profile intelligent 190°F/88°C fixed thermal sensor. LiteSpeed only.

H365HT-IV: Low-profile intelligent 190°F/88°C fixed thermal sensor. Ivory. LiteSpeed and CLIP mode.

Legacy Devices

SD355: Addressable low-profile photoelectric smoke detector.

SD355T: Addressable low-profile photoelectric smoke detector with thermal sensor.

SD355R: Remote test capable addressable photoelectric smoke detector for use with DNR(W) duct detector housing.

SD355CO: Addressable, low-profile device that provides fire, heat, and carbon monoxide (CO) detection.

H355: Fast-response, low-profile heat detector.

H355R: Fast-response, low-profile heat detector with rate-of-rise option.

H355HT: Fast-response, low-profile heat detector that activates at 190°F/88°C.

AD355: Low-profile, intelligent, "Adapt" multi-sensor detector (B350LP base included).

B200SR: Addressable sounder base.

BEAM355: Intelligent beam smoke detector.

BEAM355S: Intelligent beam smoke detector with integral sensitivity test.

D355PL: InnovairFlex low-flow non-relay duct-detector housing; includes SD355R.

DNR: InnovairFlex low-flow non-relay duct-detector housing. (Order SD355R/SD365R separately.)

DNRW: InnovairFlex low-flow non-relay duct-detector housing, with NEMA-4 rating. Watertight. (Order SD355R/SD365R separately.)

Addressable Modules

MMF-300: Addressable Monitor Module for one zone of normally-open dry-contact initiating devices. Mounts in standard 4.0" (10.16 cm.) box. Includes plastic cover plate and end-of-line resistor. Module may be configured for either a Style B (Class B) or Style D (Class A) IDC.

MDF-300: Dual Monitor Module. Same as MMF-300 except it provides two Style B (Class B) only IDCs.

MMF-301: Miniature version of MMF-300. Excludes LED and Style D option. Connects with wire pigtails. May mount in device backbox.

MMF-302: Similar to MMF-300. Addressable Monitor Module for one zone of conventional two-wire detectors. Requires resettable 24 VDC power. Refer to the *Device Compatibility Document* for listed compatible devices and quantity limitation.

CMF-300: Addressable Control Module for one Style Y/Z (Class B/A) zone of supervised polarized Notification Appliances. Mounts directly to a 4.0" (10.16 cm.) electrical box. NAC option requires external 24 VDC to power notification appliances.

CRF-300: Addressable relay module containing two isolated sets of Form-C contacts, which operate as a DPDT switch. Mounts directly to a 4.0" (10.16 cm.) box, surface mount using the SMB500.

BG-12LX: Addressable manual pull station with interface module mounted inside.

I300: This module isolates the SLC loop from short circuit conditions (required for Style 6 or 7 operation).

ISO-6: Six-fault isolator module. Mount one or two modules in a BB-2F cabinet (optional). Mount up to six modules on a CHS-6 chassis in a BB-6F cabinet.

SMB500: Used to mount all modules except MMF-301 and M301.

MMF-300-10: Ten-input monitor module. Mount one or two modules in a BB-2F cabinet (optional). Mount up to six modules on a CHS-6 chassis in a BB-6F cabinet.

MMF-302-6: Six-zone interface module. Mount one or two modules in a BB-2F cabinet (optional). Mount up to six modules on a CHS-6 chassis in a BB-6F cabinet.

CMF-300-6: Six-circuit supervised control module. Mount one or two modules in a BB-2F cabinet (optional). Mount up to six modules on a CHS-6 chassis in a BB-6F cabinet.

CRF-300-6: Six-relay control module (Form-C relays). Mount one or two modules in a BB-2F cabinet (optional). Mount up to six modules on a CHS-6 chassis in a BB-6F cabinet.

SWIFT Wireless Devices

W-GATE: LiteSpeed Wireless Gateway

W-SD355: LiteSpeed intelligent, wireless photo detector.

W-H355R: LiteSpeed intelligent wireless rate of rise (135°) heat detector.

W-SD355T: intelligent wireless photo/heat detector.

W-H355: LiteSpeed intelligent wireless fixed-temperature (135°) heat detector.

W-MMF: LiteSpeed Intelligent wireless monitor module.

W-CRF: LiteSpeed Intelligent wireless relay module.

W-BG12LX: LiteSpeed Intelligent wireless pull station.

WAV-RL, WAV-WL, WAV-CRL, WAV-CWL: LiteSpeed Intelligent AV bases.

W-USB: Wireless USB radio/antenna dongle that plugs into the USB port of a PC running SWIFT Tools.

SWIFT Tools: Programming and diagnostic utility for the Wireless Gateway and devices. Available for download from firelite.com.

NOTE: For more information on Compatible Addressable Devices for use with the ES-50X, see the following data sheets (document numbers): SD365 Series (DF-61010), H365 Series (DF-61011), AD355 (DF-52386), BG-12LX (DF-52013), CMF-300-6 (DF-52365), CRF-300-6 (DF-52374), CMF/CRF Series (DF-52130), CP355 (DF-52383), H355 Series (DF-52385), I300 (DF-52389), ISO-6 (DF-60485), MMF-300 Series/MDF-300 (DF-52121), MMF-300-10 (DF-52347), MMF-302-6 (DF-52356), SD355/SD355T (DF-52384), and SLC Wiring Manual (51309).

NOTE: Legacy 300 Series detection devices such as the CP300/CP350, SD300(T)/SD350(T) and older modules such as the M300, M301, M302, C304, and BG-10LX are not compatible with LiteSpeed polling. If the SLC contains one of these devices, polling must be set for standard CLIP protocol. Please consult factory for further information on previous 300 Series devices.

ADDRESSABLE DEVICE ACCESSORIES

End-of-Line Resistor Assembly (R-47K and R-3.9K): The 47k ohm assembly supervises the MMF-300, MDF-300, MMF-301, and CMF-300 module circuits. The 3.9k ohm assembly supervises the MMF-302 module circuit. These resistors are included with each module.

Power Supervision Relay: Supervises the power to 4-wire smoke detectors and notification appliances.

Wiring Requirements

While shielded wire is not required, it is recommended that all SLC wiring be twisted-pair to minimize the effects of electrical interference. Refer to the panel manual for wiring details.

SYSTEM SPECIFICATIONS

System Capacity

- Intelligent Signaling Line Circuits..... 1
- Addressable device capacity..... 50
- Programmable software zones..... 50
- Annunciators..... 16

Electrical Specifications

AC Power: 120/240 VAC, 50/60 Hz, 3.25 A. Wire size: minimum 14 AWG (2.00 mm²) with 600 V insulation. Nonpower-limited, supervised.

Battery: Two 12 V 18 AH lead-acid batteries. Battery Charger Capacity: 7-18 AH (ES-50X cabinet holds maximum of two 18 AH batteries.)

Communication Loop: Supervised and power-limited.

Notification Appliance Circuits: Terminal Block provides connections for two NACs, Style Y (Class B) or Style Z (Class A). Special Application power. Power-limited, supervised circuitry. Maximum signaling current per circuit: 2.5 amps special application, 250mA regulated. End-of-Line Resistor: 4.7k ohm, ½ watt (P/N 71252 UL listed) for Style Y (Class B) NAC; system capable of 1.9 kΩ - 22 kΩ ELR range. Refer to the *Fire-Lite Device Compatibility Document* for listed compatible devices.

Two Programmable Relays and One Fixed Trouble Relay: Contact rating: 2.0 A @ 30 VDC (resistive), 0.5 A @ 30 VAC (resistive). Form-C relays, non-power-limited, non-supervised.

Cabinet Specifications

Door: 19.26" (48.92 cm.) high x 16.82" (42.73 cm.) wide x 0.72" (1.82 cm.) deep. **Backbox:** 19.00" (48.26 cm.) high x 16.65" (42.29 cm.) wide x 5.25" (13.34 cm.) deep. **Trim Ring (TR-CE):** 22.00" (55.88 cm.) high x 19.65" (49.91 cm.) wide.

Shipping Specifications

Weight: 26.9 lbs. (12.20 kg.) **Dimensions:** 20.00" (50.80 cm.) high x 22.5" (57.15 cm.) wide x 8.5" (21.59 cm.) deep.

Temperature and Humidity Ranges

This system meets NFPA requirements for operation at 0 – 49°C/32 – 120°F and at a relative humidity 93% ± 2% RH (noncondensing) at

32°C ± 2°C (90°F ± 3°F). However, the useful life of the system's standby batteries and the electronic components may be adversely affected by extreme temperature ranges and humidity. Therefore, it is recommended that this system and its peripherals be installed in an environment with a normal room temperature of 15 – 27°C/60 – 80°F.

NFPA Standards

The ES-50X complies with the following NFPA 72 Fire Alarm Systems requirements:

- **LOCAL** (Automatic, Manual, Waterflow and Sprinkler Supervisory).
- **AUXILIARY** (Automatic, Manual and Waterflow) (requires 4XTMF).
- **REMOTE STATION** (Automatic, Manual and Waterflow) (Where a DACT is not accepted, the alarm, trouble and supervisory relays may be connected to UL 864 listed transmitters. For reverse polarity signaling of alarm and trouble, 4XTMF is required.)
- **PROPRIETARY** (Automatic, Manual and Waterflow).
- **CENTRAL STATION** (Automatic, Manual and Waterflow, and Sprinkler Supervised).
- **OT, PSDN** (Other Technologies, Packet-switched Data Network)
- **IBC 2012, IBC 2009, IBC 2006, IBC 2003, IBC 2000** (Seismic).
- **CBC 2007** (Seismic)

Agency Listings and Approvals

The listings and approvals below apply to the basic ES-50X control panel. In some cases, certain modules may not be listed by certain approval agencies, or listing may be in process. Consult factory for latest listing status.

- **UL:** S624
- **FM approved**
- **CSFM:** 7165-0075:0500
- **FDNY:** COA #6261

NOTE: See DF-60954 for ULC-listed model.

AlarmNet®, Fire-Lite® Alarms, SWIFT®, and System Sensor® are registered trademarks of Honeywell International Inc. Microsoft® and Windows® are registered trademarks of the Microsoft Corporation.
©2018 by Honeywell International Inc. All rights reserved. Unauthorized use of this document is strictly prohibited.



This document is not intended to be used for installation purposes.
We try to keep our product information up-to-date and accurate.
We cannot cover all specific applications or anticipate all requirements.
All specifications are subject to change without notice.

For more information, contact Fire-Lite Alarms. Phone: (800) 627-3473, FAX: (877) 699-4105.
www.firelite.com



Country of Origin: USA

ANN-80

80-Character Serial LCD Annunciator

Annunciators

General

The ANN-80 annunciator is a compact, backlit, 80-character LCD fire annunciator that mimics the Fire Alarm Control Panel (FACP) display. It provides system status indicators for AC Power, Alarm, Trouble, Supervisory, and Alarm Silenced conditions. The ANN-80 and the FACP communicate over a two-wire serial interface employing the ANN-Bus communication format. Connected devices are powered, via two additional wires, by either the host FACP or a remote UL-listed, filtered power supply. The ANN-80 is red; for white, order ANN-80-W.

The ANN-80 displays English-language text of system point information including device type, zone, independent point alarm, trouble or supervisory status, as well as any custom alpha labels programmed into the control panel. It includes control switches for remote control of critical system functions. (A keyswitch prevents unauthorized operation of the control switches.)

Up to eight ANN-80s may be connected to the ANN-Bus of each FACP. No programming is required, which saves time during system commissioning.

Features

- Listed to UL Standard 864, 9th Edition
- Backlit 80-character LCD display (20 characters x 4 lines)
- Mimics all display information from the host panel
- Control switches for System Acknowledge, Signal Silence, Drill, and Reset
- Control switches can be independently enabled or disabled at the FACP
- Keyswitch enables/disables control switches and mechanically locks annunciator enclosure
- Keyswitch can be enabled or disabled at the FACP
- Enclosure supervised for tamper
- System status LEDs for AC Power, Alarm, Trouble, Supervisory, and Alarm Silence
- Local sounder can be enabled or disabled at the FACP
- ANN-80 connects to the ANN-Bus terminal on the FACP and requires minimal panel programming
- Displays device type identifiers, individual point alarm, trouble, supervisory, zone, and custom alpha labels
- Time-and date display field
- Surface mount directly to wall or to single, double, or 4" square electrical box
- Semi-flush mount to single, double, or 4" square electrical box. Use ANN-SB80KIT for angled view mounting
- Can be remotely located up to 6,000 feet (1,800 m) from the panel
- Backlight turns off during AC loss to conserve battery power but will turn back on if an alarm condition occurs
- May be powered by 24 VDC from the host FACP or by remote power supply (requires 24 VDC)
- Up to eight ANN-80s can be connected on the ANN-Bus

Controls and Indicators

- AC Power
- Alarm
- Trouble



- Supervisory
- Alarm Silenced

Specifications

- **Operating voltage range:** 18 VDC to 28 VDC
- **Current consumption @ 24 VDC nominal** (filtered and non-resettable): 40 mA maximum
- **Ambient temperature:** 32°F to 120°F (0°C to 49°C)
- **Relative humidity:** 93% ± 2% RH (non-condensing) at 32°C ± 2°C (90°F ± 3°F)
- 5.375" (13.65 cm.) high x 6.875" (17.46 cm.) wide x 1.375" (3.49 cm.) deep
- For use indoors in a dry location
- All connections are power-limited and supervised

The ANN-Bus

POWERING THE DEVICES ON THE ANN-BUS FROM AUXILIARY POWER SUPPLY

The ANN-Bus can be powered by an auxiliary power supply when the maximum number of ANN-Bus devices exceeds the ANN-Bus power requirements. See the FACP manual for more information.

ANN-BUS DEVICE ADDRESSING

Each ANN-Bus device requires a unique address (ID Number) in order to communicate with the FACP. A maximum of 8 devices can be connected to the FACP ANN-Bus communication circuit. See the FACP manual for more information.

WIRE REQUIREMENTS: COMMUNICATIONS CIRCUIT

The ANN-80 connects to the FACP ANN-Bus communications circuit. To determine the type of wire and the maximum wiring distance that can be used with FACP ANN-Bus accessory modules, it is necessary to calculate the total worst case current draw for all modules on a single 4-conductor bus. The total worst case current draw is calculated by adding the individual worst case currents for each module.

NOTE: For total worst case current draw on a single ANN-Bus refer to appropriate FACP manual.

WIRE REQUIREMENTS: POWER CIRCUIT

- 14 to 18 AWG (0.75 - 2.08 mm²) wire for 24 VDC power circuit is acceptable. Power wire distance limitation is set by 1.2 volt maximum line drop from source to end of circuit.
- All connections are power-limited and supervised.
- A maximum of eight ANN-80 modules may be connected to this circuit.

Ordering Options

ANN-80: Red 80 character LCD Annunciator.

ANN-80-W: White, 80 character LCD Annunciator.

ANN-SB80KIT-R: Red surface mount backbox with angled wedge.

ANN-SB80KIT-W: White surface mount backbox with angled wedge.

Agency Listings and Approvals

The listings and approvals below apply to the ANN-80. In some cases, certain modules may not be listed by certain approval agencies, or listing may be in process. Consult factory for latest listing status.

- **UL:** S2424
- **FM approved**
- **CSFM:** 7120-0075:0211
- **MEA:** 442-06-E

Fire-Lite® Alarms is a registered trademark of Honeywell International Inc.
©2018 by Honeywell International Inc. All rights reserved. Unauthorized use of this document is strictly prohibited.



This document is not intended to be used for installation purposes.
We try to keep our product information up-to-date and accurate.
We cannot cover all specific applications or anticipate all requirements.
All specifications are subject to change without notice.

For more information, contact Fire-Lite Alarms. Phone: (800) 627-3473, FAX: (877) 699-4105.
www.firelite.com



Country of Origin: USA



D355PL Duct Smoke Detector

SPECIFICATIONS

Operating Temperature:	-4° to 158°F (-20° to 70°C) 32° to 120°F (0° to 49°C) with module installed in the D355PL
Storage Temperature:	-22° to 158°F (-30° to 70°C)
Humidity:	0% to 93% Relative Humidity Non-condensing
Air Velocity:	100 to 4000 ft./min. (0.5 to 20.3 m/sec.)
Rectangular Footprint Dimensions:	14.38 in L x 5 in W x 2.5 in D (37 cm L x 12.7 cm W x 6.35 cm D)
Square Footprint Dimensions:	7.75 in L x 9 in W x 2.5 in D (19.7 cm L x 22.9 cm W x 6.35 cm D)
Weight:	1.8 pounds; 0.82 kg
Operating Voltage Range:	15 to 32 VDC
Standby Current:	300µA @ 24 VDC (one communication every 5 seconds with LED blink enabled)
Max. Alarm Current (LED on):	6.5 mA @ 24 VDC

ACCESSORY CURRENT LOADS AT 24 VDC		
DEVICE	STANDBY	ALARM
RA400Z/RA100Z	0mA	12mA Max.
RTS451/RTS151	0mA	12mA Max.
RTS451KEY/ RTS151KEY	12mA	12mA Max.

NOTE: The D355PL come with the sensor head factory installed, part number SD355R.

Table of Contents	Page
[1] Limitations of Duct Smoke Detectors	1
[2] General Description	1
[3] Contents of the Duct Smoke Detector Kit	1
[4] Detector Installation	1
[5] Sampling Tube Installation	2
[6] Measurement Tests	3
[7] Field Wiring	3
[8] Verification of Operation	4
[9] Detector Cleaning Procedures	4
[10] Sensor Replacement	5
[11] Optional Accessories	5
Warranty	6

BEFORE INSTALLING

Read the System Sensor Guide for Proper Use of Smoke Detectors in Duct Applications (A05-1004), which provides detailed information on detector spacing, placement, zoning, wiring, and special applications. Copies of this manual are available online at www.systemsensor.com. NFPA Standards 72 and 90A should also be referenced for detailed information.

NOTICE: This manual shall be left with the owner/user of this equipment. IMPORTANT: This detector must be tested and maintained regularly following NFPA 72 requirements. The detector should be cleaned at least once a year.

[1] LIMITATIONS OF DUCT SMOKE DETECTORS



The National Fire Protection Association has established that DUCT DETECTORS MUST NOT BE USED AS A SUBSTITUTE FOR OPEN AREA DETECTOR PROTECTION as a means of providing life safety. Nor are they a substitute for early warning in a building's regular fire detection system.

System Sensor supports this position and strongly recommends that the user read NFPA Standards 90A, 72, and 101. The D355PL Air Duct Smoke Detectors are listed per UL 268A.

This device will not operate without electrical power. Fire situations may cause an interruption of power. The system safeguards should be discussed with your local fire protection specialist.

This device will not sense smoke unless the ventilation system is operating and the cover is installed.

For this detector to function properly, it MUST be installed according to the instructions in this manual. Furthermore, the detector MUST be operated within ALL electrical and environmental specifications listed in this manual and the sensor head installation manual. Failure to comply with these requirements may prevent the detector from activating when smoke is present in the air duct.

[2] GENERAL DESCRIPTION

Smoke introduced into this air duct system will be distributed throughout the entire building. Smoke detectors designed for use in air duct systems are used to sense the presence of smoke in the duct.

Model D355PL Air Duct Smoke Detector utilizes photoelectric technology for the detection of smoke. This detection method, when combined with an efficient housing design, samples air passing through the duct and allows detection of a developing hazardous condition. When sufficient smoke is sensed, an alarm signal is initiated at the fire control panel monitoring the detector, and appropriate action can be taken to shut off fans, blowers, change over air handling systems, etc. These actions can facilitate the management of toxic smoke and fire gases throughout the areas served by the duct system.

The D355PL incorporates a sensor cover tamper feature that provides a trouble signal at the panel immediately if the cover is removed or improperly installed. Proper installation of the sensor cover removes the trouble condition.

If programmed with the system control panel, two LEDs on each duct smoke detector light to provide local visible indication.

The D355PL provides a remote alarm output for use with auxiliary devices, such as the RA400Z/RA100Z remote LED annunciator, as well as remote test capability with the RTS451/151 or RTS451KEY/RTS151KEY Remote Test Stations.

[2.1] DETECTOR FEATURE SET

- Utilizes plug-in head, part number SD355R
- Sampling tubes install from front and rear
- Compatible with existing accessories
- Able to address detector per code switches on sensor head.

[3] CONTENTS OF THE DUCT SMOKE DETECTOR KIT

1. Sensor/power board assembly and covers sensor head is factory installed
2. Three #10 sheet metal screws for mounting
3. One test magnet
4. Drilling template
5. One sampling tube end cap
6. One plastic exhaust tube

NOTE: A sampling tube must be ordered to complete the installation. It must be the correct length for the width of the duct where it will be installed. See Table 1 on page 3 to determine the inlet tube required for different duct widths.

[4] DETECTOR INSTALLATION

[4.1] VERIFY DUCT AIR FLOW DIRECTION AND VELOCITY

Model D355PL detectors are designed to be used in air handling systems having air velocities of 100 to 4000 feet per minute. Duct widths from 6 inches to 12 feet can be accommodated. Be sure to check engineering specifications to ensure that the air velocity in the duct falls within these parameters. If necessary, use a velocity meter (anemometer) to check the air velocity in the duct.

[4.2] DETERMINE MOUNTING LOCATION AND CONFIGURATION

On ducts wider than 18 inches it is recommended that the detector be mounted downstream of a bend, obstruction in the duct, or the supply or return air inlet.

FIGURE 1. EXPLODED VIEW OF DUCT SMOKE DETECTOR COMPONENTS:

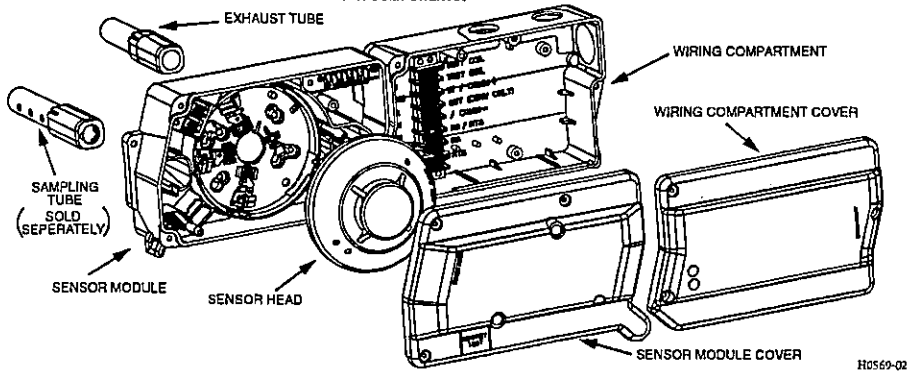

Exception: Installation of duct detectors can be on or within a commercial packaged rooftop heating and air-conditioning system, fire/smoke dampers and economizers. They may be mounted in either the supply and/or return air section as determined by local code.

Once a suitable location is selected, determine if the detector is to be mounted in a side-by-side "rectangular" configuration or a top-over-bottom "square" configuration as shown in Figure 2. If mounting in the square configuration, remove the rear attachment screw, rotate the unit at hinge, and replace the screw into the new attachment hole as shown in Figure 2. Do NOT remove the hinge screw during this process. Final installation approval shall be based upon passing differential pressure and smoke entry tests described in the Measurement Tests section.

FIGURE 2:

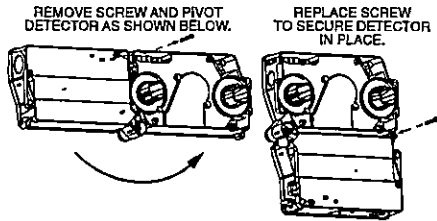

[4.3] DRILL THE MOUNTING HOLES

Remove the paper backing from the mounting template supplied. Affix the template to the duct at the desired mounting location. Make sure the template lies flat and smooth on the duct.

[4.3.1] FOR RECTANGULAR SIDE-BY-SIDE MOUNTING CONFIGURATION:

Center punch at (4) target centers: (2) "A" for sampling tubes and (2) "B" for the rectangular configuration mounting tabs as shown on mounting template. Drill pilot holes at target "A" centers and cut two 1.375 inch diameter holes using a 1 1/8-inch hole saw or punch. Drill .156 inch diameter holes using a 1/8 inch drill at target "B" centers.

[4.3.2] FOR SQUARE TOP-OVER-BOTTOM MOUNTING CONFIGURATION:

Center punch at (4) target centers: (2) "A" for sampling tubes and (2) "C" for the square configuration mounting tabs as shown on mounting template. Drill pilot holes at target "A" centers and cut two 1.375 inch diameter holes using a 1 1/8-inch hole saw or punch. Drill .156 inch diameter holes using a 1/8 inch drill at target "C" centers. If desired, drill an additional .156 inch hole at the location of one of the mounting tabs on the lower housing.

[4.4] SECURE THE DUCT DETECTOR TO THE DUCT

Use two (rectangular configuration) or three (square configuration) of the provided sheet metal screws to screw the duct detector to the duct.

CAUTION: Do not overtighten the screws.

[6] SAMPLING TUBE INSTALLATION

[6.1] SAMPLING TUBE SELECTION

The sampling tube must be purchased separately. Order the correct length, as specified in Table 1, for width of the duct where it will be installed. The sampling tube length must extend at least 1/3 across the duct width for optimal performance.

The sampling tube is always installed with the air inlet holes facing into the air flow. To assist proper installation, the tube's connector is marked with an arrow. Make sure the sampling tube is mounted so that the arrow points into the airflow as shown in Figure 3. Mounting the detector housing in a vertical orientation is acceptable provided that the air flows directly into the sampling tube holes as indicated in Figure 3. The sampling tube and exhaust tube can be mounted in either housing connection as long as the exhaust tube is mounted downstream from the sampling tube.

TABLE 1. SAMPLING TUBES RECOMMENDED FOR DIFFERENT DUCT WIDTHS:

Outside Duct Width	Sampling Tube Recommended*
Up to 1 ft.	DST1
1 to 2 ft.	DST1.5
2 to 4 ft.	DST3
4 to 8 ft.	DST5
8 to 12 ft.	DST10 (2-piece)

*Must extend a minimum of 1/3 the duct width

FIGURE 3. AIR DUCT DETECTOR SAMPLING TUBE:

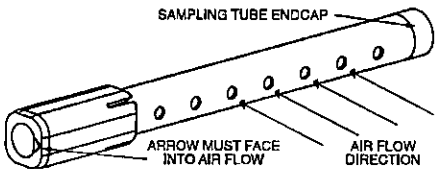

CAUTION: The sampling tube end cap, included with the detector, is critical to proper operation of the duct smoke detector. The end cap is needed to create the proper air flow to the sensor of the duct smoke detector. Once any sampling tube length adjustments are made, plug the end of the sampling tube with the provided end cap.

A plastic exhaust tube is included with the unit to be installed if needed. Install into the housing connection that is downstream from the sampling tube connection. The exhaust tube can be installed from the front of the detector or the back. A longer 1 foot exhaust tube, model ETX, is available as an accessory in cases where the molded exhaust tube does not extend at least 2 inches into the duct.

[5.2] SAMPLING TUBE INSTALLATION

- For tubes shorter than the width of the duct, slide the sampling tube, with installed end cap, into the housing connection that meets the airflow first. Position the tube so that the arrow points into the airflow as shown in Figure 3. Per NFPA sampling tubes over 3 feet long should be supported at the end opposite of the duct detector. In ducts wider than 8 feet, work must be performed inside the duct to couple the other section of the sampling tube to the section already installed using the 1/4-inch conduit fitting supplied. Make sure that the holes on both sections of the air inlet sampling tube are lined up and facing into the airflow.
- For tubes longer than the width of the air duct, the tube should extend out of the opposite side of the duct. Drill a 1/4-inch hole in the duct opposite the hole already cut for the sampling tube. Ensure that the sampling tube is angled downward from the duct smoke detector to allow for moisture drainage away from the detector. The sampling tube should be angled at least 1/4" downward for every 12" of duct width per Figure 4. There should be 10 to 12 holes spaced as evenly as possible across the width of the duct. If there are more than 2 holes in the section of the tube extending out of the duct, select a shorter tube using Table 1. Otherwise, trim the tube to leave approximately 1 to 2 inches extending outside the duct. Plug the end with the end cap and tape closed any holes in the protruding section of the tube. Be sure to seal the duct where the tube protrudes.

FIGURE 4.

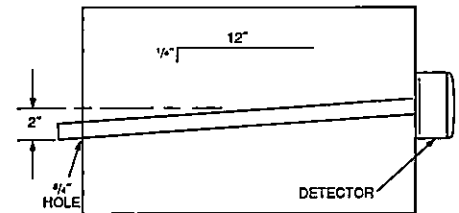

110215-00

NOTE: Air currents inside the duct may cause excessive vibration, especially when the longer sampling tubes are used. In these cases, a 3-inch floor flange (available at most plumbing supply stores) may be used to fasten the sampling tube to the other side of the duct. When using the flange/connector mounting technique, drill a 1 to 1 1/4-inch hole where the flange will be used.

[5.3] MODIFICATIONS OF SAMPLING TUBES

There may be applications where duct widths are not what is specified for the installation. In such cases, it is permissible to modify a sampling tube that is longer than necessary to span the duct width.

Use a 0.193-inch diameter (#10) drill and add the appropriate number of holes so that the total number of holes exposed to the air flow in the duct is 10 to 12. Space the additional holes as evenly as possible over the length of the tube.

CAUTION: This procedure should only be used as a temporary fix. It is not intended as a permanent substitute for ordering the correct length tubes.

[5.4] REMOTE SAMPLING TUBE INSTALLATION

The detector arrangement can also incorporate the remote mounting of the sampling tube and/or exhaust tube. In this case both the detector, sampling tube and exhaust tube (if included) should be rigidly mounted to withstand the pressure and vibrations caused by the air velocity. The location of the detector's sampling tube should be such that there is uniform airflow in the cross section area.

Pressure differential across the sampling and exhaust ports in the detector housing shall be verified to be between 0.01 and 1.11 inches of water. Do so by measuring the pressure difference between the inlet and outlet ports on the detector housing using a manometer as described in the Measurement Tests section of this manual.

[6] MEASUREMENT TESTS

[6.1] AIR FLOW

The D355PL is designed to operate over an extended air speed range of 100 to 4000 FPM. To verify sufficient sampling of ducted air, turn the air handler on and use a manometer to measure the differential pressure between the two sampling tubes. The differential pressure should measure at least 0.01 inches of water and no more than 1.11 inches of water. Because most commercially available manometers cannot accurately measure very low pressure differentials, applications with less than 500 FPM of duct air speed may require one of the following: 1) the use of a current-sourcing pressure transmitter (Dwyer Series 607) or 2) the use of aerosol smoke, see below for test descriptions.

FIGURE 5. PROCEDURE FOR VERIFYING AIR FLOW:

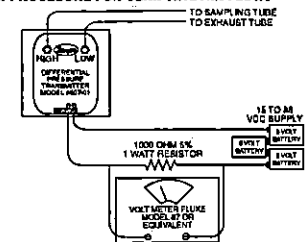

110163-01

[6.2] LOW FLOW AIR FLOW TEST USING DWYER SERIES 607 DIFFERENTIAL PRESSURE TRANSMITTER

Verify the air speed of the duct using an anemometer. Air speed must be at least 100 FPM. Wire the Dwyer transmitter as shown in Figure 5. Connect the leads of the meter to either side of the 1000Ω resistor. Allow unit to warm up for 15 seconds. With both HIGH and LOW pressure ports open to ambient air, measure and record the voltage drop across the 1000Ω resistor (measurement 1), 4.00 volts is typical. Using flexible tubing and rubber stoppers, connect the HIGH side of the transmitter to the sampling tube of the duct smoke detector housing, and the LOW side of the transmitter to the exhaust tube of the duct smoke detector housing. Measure and record the voltage drop across the 1000Ω resistor (measurement 2). Subtract the voltage recorded in measurement 1 from the voltage recorded in measurement 2. If the difference is greater than 0.15 volts, there is enough air flow through the duct smoke detector for proper operation.

[7] FIELD WIRING; INSTALLATION GUIDELINES

All wiring must be installed in compliance with the National Electrical Code and the local codes having jurisdiction. Proper wire gauges should be used. The conductors used to connect smoke detectors to control panels and accessory devices should be color-coded to prevent wiring mistakes. Improper connections can prevent a system from responding properly in the event of a fire.

For signal wiring (the wiring between detectors or from detector to auxiliary devices), it is usually recommended that single conductor wire be no smaller than 18 gauge. The duct smoke detector terminals accommodate wire sizes up to 12 gauge. Flexible conduit is recommended for the last foot of conduit; solid conduit connections may be used if desired.

Duct smoke detectors and alarm system control panels have specifications for Signaling Line Circuit (SLC) wiring. Consult the control panel manufacturer's specifications for wiring requirements before wiring the detector loop.

Please refer to Insert for the Limitations of Fire Alarm Systems

THREE-YEAR LIMITED WARRANTY

System Sensor warrants its enclosed product to be free from defects in materials and workmanship under normal use and service for a period of three years from date of manufacture. System Sensor makes no other express warranty for the enclosed product. No agent, representative, dealer, or employee of the Company has the authority to increase or alter the obligations or limitations of this Warranty. The Company's obligation of this Warranty shall be limited to the replacement of any part of the product which is found to be defective in materials or workmanship under normal use and service during the three year period commencing with the date of manufacture. After phoning System Sensor's toll free number 800-SENSOR2 (736-7672) for a Return Authorization number, send defective units postage prepaid to: System Sensor, Returns Department, RA

3825 Ohio Avenue, St. Charles, IL 60174. Please include a note describing the malfunction and suspected cause of failure. The Company shall not be obligated to replace units which are found to be defective because of damage, unreasonable use, modifications, or alterations occurring after the date of manufacture. In no case shall the Company be liable for any consequential or incidental damages for breach of this or any other Warranty, expressed or implied whatsoever, even if the loss or damage is caused by the Company's negligence or fault. Some states do not allow the exclusion or limitation of incidental or consequential damages, so the above limitation or exclusion may not apply to you. This Warranty gives you specific legal rights, and you may also have other rights which vary from state to state.

[7.1] WIRING INSTRUCTIONS

Disconnect power from the communication line before installing the D355PL duct smoke detector.

The D355PL detectors are designed for easy wiring. The housing provides a terminal strip with clamping plates. Wiring connections are made by sliding the bare end under the plate, and tightening the clamping plate screw. See Figure 6 below for system wiring.

FIGURE 6. SYSTEM WIRING DIAGRAM FOR D355PL

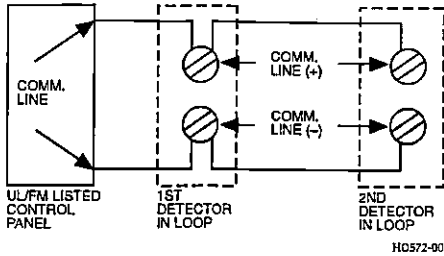

H0572-00

[7.2] SET THE ADDRESS

Set the desired address on the sensor head code wheel switches. on the back of the sensor head.

FIGURE 7. ROTARY ADDRESS SWITCHES

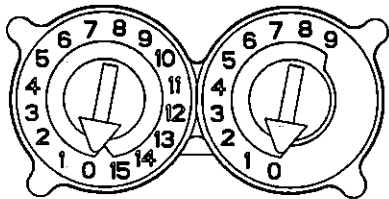

H0112-00

[8] VERIFICATION OF OPERATION

[8.1] INSTALL THE COVER

Install the covers making sure that the cover fits into the base groove. Tighten the seven screws that are captured in the covers. Note that the cover must be properly installed for proper operation of the sensor.

NOTE: Verify sensor cover gasket is properly seated on cover prior to cover installation.

[8.2] POWER THE UNIT

Activate the communication line on terminals COM + and COM -.

[8.3] DETECTOR CHECK

Standby - If programmed by the system control panel, look for the presence of the flashing LEDs through the transparent housing cover. The LED will flash with each communication.

Trouble - If programmed by the system control panel and the detector LEDs do not flash, then the detector lacks power (check wiring, missing or improperly placed cover, panel programming, or power supply), the sensor head is missing (replace), or the unit is defective (return for repair).

[8.4] DUCT SMOKE DETECTOR TEST & MAINTENANCE PROCEDURES

Test and maintain duct smoke detectors as recommended in NFPA 72. The tests contained in this manual were devised to assist maintenance personnel in verification of proper detector operation.

Before conducting these tests, notify the proper authorities that the smoke detection system will be temporarily out of service. Disable the zone or system under test to prevent unwanted alarms.

[8.4.1] TEST THE UNIT

1. M02-04-00 Magnet Test - This sensor can be functionally tested with a test magnet. The test magnet electronically simulates smoke in the sensing chamber, testing the sensor electronics and connections to the control panel.
2. Remote Test Accessory - The use of a remote accessory for visible indication of power and alarm is recommended.

Verify system control panel alarm status and control panel execution of all intended auxiliary functions (i.e. fan shutdown, damper control, etc.).

Two LEDs on the sensor are controlled by the panel to indicate sensor status. Coded signals, transmitted from the panel, can cause the LEDs to blink, latch on, or latch off. Refer to the control panel technical documentation for sensor LED operation and expected delay to alarm.

[8.4.2] THE DETECTOR MUST BE RESET BY THE SYSTEM CONTROL PANEL.

[8.4.3] SMOKE ENTRY TEST USING AEROSOL SMOKE

This test is intended for low-flow systems (100-500 FPM). If the air speed is greater than 500 FPM, use a conventional manometer to measure differential pressure between the sampling tubes, as described under Measurement Tests on Page 3.

Drill a 1/4-inch hole 3 feet upstream from the duct smoke detector. With the air handler on, measure the air velocity with an anemometer. Air speed must be at least 100 FPM. Spray aerosol smoke* into the duct through the 1/4-inch hole for five seconds. Wait two minutes for the duct smoke detector to alarm. If the duct smoke detector alarms, air is flowing through the detector. Remove the duct smoke detector cover and blow out the residual aerosol smoke from the chamber and reset the duct smoke detector at the panel. Use duct tape to seal the aerosol smoke entry hole. Remember to replace the cover after the test or the detector will not function properly.

*Aerosol smoke can be purchased from Home Safeguard Industries at home-safeguard.com, model 25S Smoke Detector Tester, and Cheikh Smoke Detector Tester model CHEK02 and CHEK06 available from SDI. When used properly, the canned smoke agent will cause the smoke detector to go into alarm. Refer to the manufacturer's published instructions for proper use of the canned smoke agent.

CAUTION

Canned aerosol simulated smoke (canned smoke agent) formulas will vary by manufacturer. Misuse or overuse to these products may have long term adverse effects on the smoke detector. Consult the canned smoke agent manufacturer's published instructions for any further warnings or caution statements.

[9] DETECTOR CLEANING PROCEDURES

Notify the proper authorities that the smoke detector system is undergoing maintenance, and that the system will temporarily be out of service. Disable the zone or system undergoing maintenance to prevent unwanted alarms and possible dispatch of the fire department.

[9.1] DETECTOR SENSOR

1. Remove the sensor to be cleaned from the system.
2. Remove the sensor cover by pressing firmly on each of the four removal tabs that hold the cover in place.
3. Vacuum the screen carefully without removing it. If further cleaning is required continue with Step 4, otherwise skip to Step 7.
4. Remove the chamber cover/screen assembly by pulling it straight out.
5. Use a vacuum cleaner or compressed air to remove dust and debris from the sensing chamber.
6. Reinstall the chamber cover/screen assembly by sliding the edge over the sensing chamber. Turn until it is firmly in place.
7. Replace the cover using the LEDs to align the cover and then gently pushing it until it locks into place.
8. Reinstall the detector.

[9.2] REINSTALLATION

1. Reinstall the detector in its housing.
2. Restore system power.
3. Perform Detector Check.
4. Notify the proper authorities testing has been completed and the smoke detector system is back in operation.

[10] SENSOR REPLACEMENT

1. Remove the sensor head by rotating counterclockwise.
2. Pull gently to remove it.
3. To replace the sensor head, align the mounting features and rotate clockwise into place.

[11] OPTIONAL ACCESSORIES

Optional accessories include RA400Z/RA100Z, RTS451/RTS151 and RTS451KEY/RTS151KEY.

NOTE: Ensure blue wire always remains connected to RA+ on the field connector side of the terminal block.

FIGURE 8. WIRING DIAGRAM FOR D355PL TO RA400Z/RA100Z

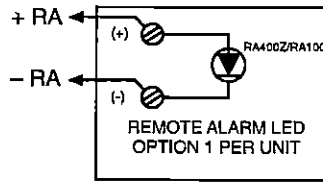

H0570-00

Note: If using a RA400Z, the tab should be broken for use with the Intelliduct duct smoke detector. If using RA100Z, ensure that jumper is removed.

The RTS451/RTS151/RTS451KEY/RTS151KEY Remote Test Station facilitates test of the alarm capability of the duct smoke detector. These accessories provide the stimulus to initiate an alarm condition at the detector. The D355PL duct smoke detector must be reset by the system control panel.

[11.1] OPTION 1:

REMOTE TEST USING SENSOR WITH REMOTE TEST CAPABILITY (WITHOUT A TEST COIL):

A sensor with suffix "R" is available for use inside the D355PL. Suffix "R" represents a head with Remote Test Capability. Using this head inside the D355PL eliminates the need for a test coil when wired to a RTS451/RTS151/RTS451KEY/RTS151KEY Remote Test Station.

To install the RTS451/RTS151/RTS451KEY/RTS151KEY, using the sensor with remote test capability connect the device as shown in Figure 9; wire runs must be limited to 25 ohms or less per interconnecting wire.

NOTE: Resistor assembly must be in place between RA+ and OUT+ inside the D355PL for Remote Test function to operate.

FIGURE 9. RTS451/RTS451KEY/RTS151/RTS151KEY USING SENSOR WITH REMOTE TEST CAPABILITY

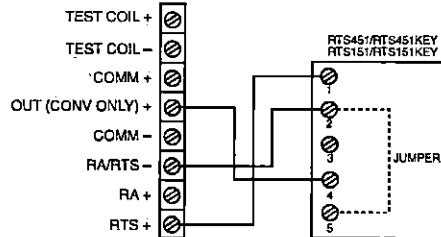

H0633-00

[11.2] OPTION 2:

REMOTE TEST USING A TEST COIL:

The use of a remote test station requires the installation of an accessory coil, part number DCOIL, sold separately.

- 1) Install DCOIL in housing pocket insuring that arrow is pointing toward detector
 - 2) Install DCOIL mounting screw
 - 3) Connect each DCOIL lead to a Test Coil Terminal
- See Figure 10 below for reference.

FIGURE 10. D355PL USING A TEST COIL

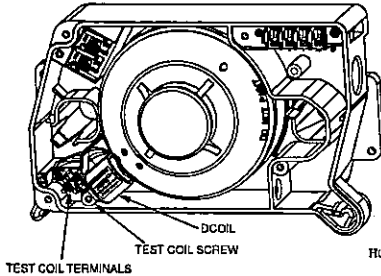

H0561-01

FIGURE 11. WIRING DIAGRAM FROM D355PL TO RTS451/RTS151/RTS451KEY/RTS151KEY USING A TEST COIL

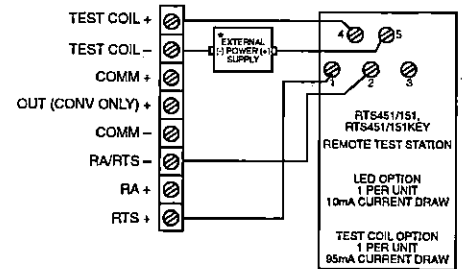

H0571-07

NOTE: The RTS451/151, RTS451/151KEY test coil circuit requires an external 24 VDC power supply which must be UL listed.

[11.3] ADDITIONAL MODULE OPTION

The D355PL can also accommodate a relay or control module (sold separately) within the power board side of the housing. The relay or control module must be listed as compatible to the fire alarm control panel.

Physical Module Mounting

- 1) Remove the breakaway tabs at the four corners of the module
- 2) Locate the module at right most corner of the power board. The upper left corner mounting hole of the module will align with a screw boss in the housing.
- 3) Install a #8 x 3/4" Plastic screw at the screw boss location

Note: See the corresponding module Installation Instructions for general description, control panel compatibility, wiring and ratings.

CMF-300(A)

Control Module



Addressable Devices

General

The CMF-300(A) Addressable Control Module provides Fire-Lite intelligent control panels a circuit for Notification Appliances (horns, strobes, etc.). Addressability allows the CMF-300(A) to be activated through panel programming, on a select (zone or area of coverage) basis.

LiteSpeed™ is a communication protocol developed by Fire-Lite Engineering that greatly enhances the speed of communication between analog intelligent devices. Intelligent devices communicate in a grouped fashion. If one of the devices within the group has new information, the panel CPU stops the group poll and concentrates on single points. The net effect is response speed greater than five times that of other designs.

Features

- Built-in type identification automatically identifies these devices to the control panel.
- Internal circuitry powered directly by two-wire SLC loop. The CMF-300(A) module requires power (for horns, strobes, etc.).
- Integral LED "blinks" green each time a communication is received from the control panel and turns on steady red when activated.
- High noise immunity (EMF/RFI).
- The CMF-300(A) may be used to switch 24-volt NAC power.
- Wide viewing angle of LED.
- SEMS screws with clamping plates for wiring ease.
- Direct-dial entry of address: 01– 159 for MS-9600 series panels, 01 – 99 on MS-9200UDLS and MS-9050UD.

Applications

The CMF-300(A) is used to switch 24 VDC audible/visual power.

Construction

- The face plate is made of off-white heat-resistant plastic.
- Controls include two rotary switches for direct-dial entry of address setting.
- The CMF-300(A) is configured for a single Class B (Style Y) or Class A (Style Z) Notification Appliance Circuit.

Operation

Each CMF-300(A) uses one of the module addresses on a SLC loop. It responds to regular polls from the control panel and reports its type and status, including the open/normal/short status of its Notification Appliance Circuit (NAC). The LED blinks with each poll received. On command, it activates its internal relay. The CMF-300(A) supervises Class B (Style Y) or Class A (Style Z) notification or control circuits.

Upon code command from the panel, the CMF-300(A) will disconnect the supervision and connect the external power supply in the proper polarity across the load device. The disconnection of the supervision provides a positive indication to the panel that the control relay actually turned ON. The

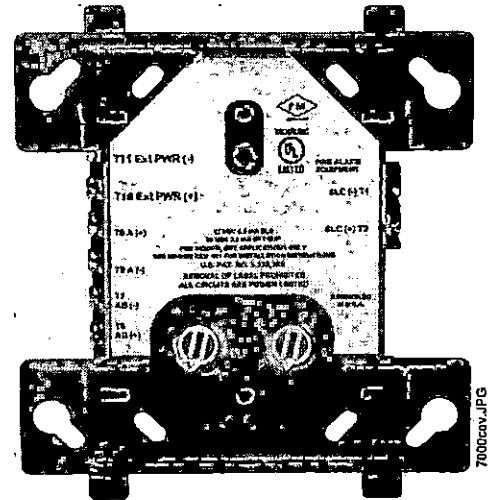

CMF-300(A)

external power supply is always relay-isolated from the communication loop so that a trouble condition on the external power supply will never interfere with the rest of the system.

Rotary switches set a unique address for each module. The address may be set before or after mounting. The built-in TYPE CODE (not settable) will identify the module to the control panel, so as to differentiate between a module and a sensor address.

Specifications

Normal operating voltage: 15 to 32 VDC.

Maximum SLC current draw: 6.5 mA (LED on).

Average operating current: 350 μ A direct poll (CLIP mode), 375 μ A group poll (LiteSpeed mode) with LED flashing.

External supply voltage: maximum 80 volts (RMS or DC).

Drain on external supply: 2 mA maximum (using internal EOL relay).

EOL resistance: 47K ohms.

Temperature range: 32°F to 120°F (0°C to 49°C).

Humidity range: 10% to 93% non-condensing.

Dimensions: 4.5" (11.43 cm) high x 4" (10.16 cm) wide x 1.25" (3.175 cm) deep. Mounts to a 4" (10.16 cm) square x 2.125" (5.398 cm) deep box.

Agency Listings and Approvals

In some cases, certain modules may not be listed by certain approval agencies, or listing may be in process. Consult factory for latest listing status.

- ULC: S2424

Product Line Information

CMF-300: Intelligent addressable control module.

CMF-300A: Canadian intelligent addressable control module.

SMB500: Optional surface-mount backbox.

CB500: Optional control module barrier, required by UL for separating power-limited and non-power-limited wiring in the same junction box as CMF-300(A).

NOTE: For installation instructions, see document I56-1189-009 and refer to the SLC Wiring Manual, document 51309. The CRF-300(A) relay module, previously on this data sheet, is now on DF-60379.

LiteSpeed™ is a trademark and Fire•Lite® Alarms is a registered trademark of Honeywell International Inc.
©2010 by Honeywell International Inc. All rights reserved. Unauthorized use of this document is strictly prohibited.



This document is not intended to be used for installation purposes.
We try to keep our product information up-to-date and accurate.
We cannot cover all specific applications or anticipate all requirements.
All specifications are subject to change without notice.

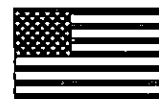

Made in the U.S. A.

For more information, contact Fire•Lite Alarms. Phone: (800) 627-3473, FAX: (877) 699-4105.
www.firelite.com

BG-12LX

Addressable Manual Pull Station



Addressable Devices

General

The Fire-Lite BG-12LX is a state-of-the-art, dual-action (i.e., requires two motions to activate the station) pull station that includes an addressable interface (mounted inside) for Fire-Lite's addressable fire alarm control panels (FACPs). Because the BG-12LX is addressable, the control panel can display the exact location of the activated manual station. This leads fire personnel quickly to the location of the alarm.

Features

- Maintenance personnel can open station for inspection and address setting without causing an alarm condition.
- Built-in bicolor LED, which is visible through the handle of the station, flashes in normal operation and latches steady red when in alarm.
- Handle latches in down position and the word "ACTIVATED" appears to clearly indicate the station has been operated.
- Captive screw terminals wire-ready for easy connection to SLC loop (accepts up to 12 AWG/3.25 mm² wire).
- Can be surface mounted (with SB-10 or SB-I/O) or semi-flush mounted. Semi-flush mount to a standard single-gang, double-gang, or 4" (10.16 cm) square electrical box.
- Smooth dual-action design.
- Meets ADAAG controls and operating mechanisms guidelines (Section 4.1.3[13]); meets ADA requirement for 5 lb. maximum activation force.
- Highly visible.
- Attractive shape and textured finish.
- Key reset.
- Includes Braille text on station handle.
- Optional trim ring (BG12TR).
- Meets UL 38, Standard for Manually Actuated Signaling Boxes.

Construction

Shell, door, and handle are molded of durable polycarbonate material with a textured finish.

Specifications

- **Shipping Weight:** 9.6 oz. (272.15 g)
- **Normal operating voltage:** 24 VDC.
- **Maximum SLC loop voltage:** 28.0 VDC.
- **Maximum SLC standby current:** 375 μ A.
- **Maximum SLC alarm current:** 5 mA.
- **Temperature Range:** 32°F to 120°F (0°C to 49°C)
- **Relative Humidity:** 10% to 93% (noncondensing)
- **For use indoors in a dry location**

Installation

The BG-12LX will mount semi-flush into a single-gang, double-gang, or standard 4" (10.16 cm) square electrical outlet box, or will surface mount to the model SB-10 or SB-I/O surface backbox. If the BG-12LX is being semi-flush mounted, then the optional trim ring (BG12TR) may be used. The BG12TR is

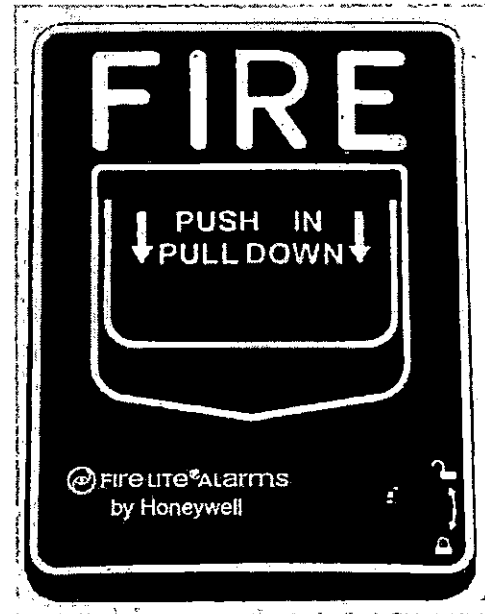

FLPullStation.jpg

usually needed for semi-flush mounting with 4" (10.16 cm) or double-gang boxes (not with single-gang boxes).

Operation

Pushing in, then pulling down on the handle causes it to latch in the down/activated position. Once latched, the word "ACTIVATED" (in bright yellow) appears at the top of the handle, while a portion of the handle protrudes from the bottom of the station. To reset the station, simply unlock the station with the key and pull the door open. This action resets the handle; closing the door automatically resets the switch.

Each manual station, on command from the control panel, sends data to the panel representing the state of the manual switch. Two rotary decimal switches allow address settings (1 – 159 with Breakaway Tab removed for MS-9600 Series, 1 – 99 and MS-9200UDLS, 1 – 50 for MS-9050UD).

Architectural/Engineering Specifications

Manual Fire Alarm Stations shall be non-coded, with a key-operated reset lock in order that they may be tested, and so designed that after actual Emergency Operation, they cannot be restored to normal except by use of a key. An operated station shall automatically condition itself so as to be visually detected as activated. Manual stations shall be constructed of red-colored polycarbonate material with clearly visible operating instructions provided on the cover. The word FIRE shall appear on the front of the stations in white letters, 1.00 inches (2.54 cm) or larger. Stations shall be suitable for surface mounting on matching backbox SB-10 or SB-I/O; or semi-flush mounting on a standard single-gang, double-gang, or 4" (10.16 cm) square electrical box, and shall be installed

within the limits defined by the Americans with Disabilities Act (ADA) or per national/local requirements. Manual Stations shall be Underwriters Laboratories listed.

Manual stations shall connect with two wires to one of the control panel SLC loops. The manual station shall, on command from the control panel, send data to the panel representing the state of the manual switch. Manual stations shall provide address setting by use of rotary decimal switches.

Product Line Information

BG-12LX: Dual-action addressable pull station. Includes key locking feature. (Listed for Canadian and non-Canadian applications.)

SB-10: Surface backbox; metal.

SB-I/O: Surface backbox; plastic.

BG12TR: Optional trim ring.

17003: Keys, set of two.

Agency Listings and Approvals

In some cases, certain modules or applications may not be listed by certain approval agencies, or listing may be in process. Consult factory for latest listing status.

- **UL/JULC Listed:** S711 (listed for Canadian and non-Canadian applications).
- **MEA:** 67-02-E.
- **CSFM:** 7150-0075:0184.
- **FM Approved.**

Patented: U.S. Patent No. D428,351; 6,380,846; 6,314,772; 6,632,108.

FireLite® Alarms® is a registered trademark of Honeywell International Inc. ©2012 by Honeywell International Inc. All rights reserved. Unauthorized use of this document is strictly prohibited.



This document is not intended to be used for installation purposes.
We try to keep our product information up-to-date and accurate.
We cannot cover all specific applications or anticipate all requirements.
All specifications are subject to change without notice.



Made in the U.S.A.

For more information, contact Fire•Lite Alarms. Phone: (800) 627-3473, FAX: (877) 699-4105.
www.firelite.com

CRF-300(A)

Relay Module

 **Fire-Lite Alarms**
by Honeywell

Addressable Devices

General

The CRF-300(A) Addressable Relay Module provides the system with a dry-contact output for activating a variety of auxiliary devices, such as fans, door holders, dampers, control equipment, etc. Addressability allows the dry contact to be activated through panel programming, on a select basis.

LiteSpeed™ is a communication protocol developed by Fire-Lite Engineering that greatly enhances the speed of communication between analog intelligent devices. Intelligent devices communicate in a grouped fashion. If one of the devices within the group has new information, the panel CPU stops the group poll and concentrates on single points. The net effect is response speed greater than five times that of other designs.

Features

- Built-in type identification automatically identifies these devices to the control panel.
- Internal circuitry and relay powered directly by two-wire SLC loop.
- Integral LED "blinks" green each time a communication is received from the control panel and turns on in steady red when activated.
- High noise immunity (EMF/RFI).
- Wide viewing angle of LED.
- SEMS screws with clamping plates for wiring ease.
- Direct-dial entry of address: 01– 159 for MS-9600(A) series panels, 01 – 99 on MS-9200UDLS(A) and MS-9050UD(A).

Applications

The CRF-300(A) may be programmed to operate dry contacts for door holders, Air Handling Unit shutdown, etc., and to reset four-wire smoke detector power.

Construction

- The face plate is made of off-white heat-resistant plastic.
- Controls include two rotary switches for direct-dial entry of address setting.
- The CRF-300(A) is configured for a single Class B (Style Y) or Class A (Style Z) Notification Appliance Circuit.
- The CRF-300(A) provides two Form-C dry contacts that switch together.

Operation

Each CRF-300(A) uses one of the addresses on a SLC loop. It responds to regular polls from the control panel and reports its type and status, including the open/normal/short status of its Notification Appliance Circuit (NAC). The LED blinks with each poll received. On command, it activates its internal relay.

NOTE: Open/short supervision is suspended with the CRF-300.

Rotary switches set a unique address for each module. The address may be set before or after mounting. The built-in TYPE CODE (not settable) will identify the module to the control panel, so as to differentiate between a control module and a relay module.

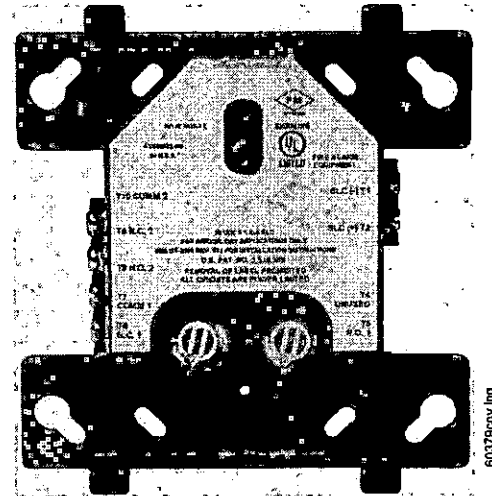

CRF-300(A)

Specifications

Normal operating voltage: 15 to 32 VDC.

Maximum SLC current draw: 6.5 mA (LED on).

Average operating current: 230 μ A direct poll (CLIP mode), 255 μ A group poll (LiteSpeed mode) with LED flashing.

EOL resistance: not used.

Temperature range: 32°F to 120°F (0°C to 49°C).

Humidity range: 10% to 93% non-condensing.

Dimensions: 4.5" (11.43 cm) high x 4" (10.16 cm) wide x 1.25" (3.175 cm) deep. Mounts to a 4" (10.16 cm) square x 2.125" (5.398 mm) deep box.

Relay Contact Ratings

Load Description	Application	Maximum Voltage	Current Rating
Resistive	Non-Coded	30 VDC	3.0 A
Resistive	Coded	30 VDC	2.0 A
Resistive	Non-Coded	110 VDC	0.9 A
Resistive	Non-Coded	125 VAC	0.9 A
Inductive (L/R=5ms)	Coded	30 VDC	0.5 A
Inductive (L/R=2ms)	Coded	30 VDC	1.0 A
Inductive (PF=0.35)	Non-Coded	125 VAC	0.5 A

Agency Listings and Approvals

In some cases, certain modules may not be listed by certain approval agencies, or listing may be in process. Consult factory for latest listing status.

- **UL:** S2424
- **ULC:** S2424
- **FM approved**
- **CSFM:** 7300-0075:185
- **MEA:** 72-01-E

Product Line Information

CRF-300(A): Intelligent addressable relay module.

: Intelligent addressable relay module, ULC listed model.

SMB500: Optional surface-mount backbox.

NOTE: For installation instructions, see document 156-1190-005 and refer to the *SLC Wiring Manual*, document 51309.

LiteSpeed™ is a trademark and Fire•Lite® Alarms is a registered trademark of Honeywell International Inc.
©2009 by Honeywell International Inc. All rights reserved. Unauthorized use of this document is strictly prohibited.



This document is not intended to be used for installation purposes.
We try to keep our product information up-to-date and accurate.
We cannot cover all specific applications or anticipate all requirements.
All specifications are subject to change without notice.



Made in the U.S. A.

For more information, contact Fire•Lite Alarms. Phone: (800) 627-3473, FAX: (877) 699-4105.
www.firelite.com

SD355(A) Series

Addressable Photoelectric Smoke Detectors



Addressable Devices

General

The SD355(A), SD355T(A), and SD355R(A) addressable, low-profile plug-in photoelectric detectors use a state-of-the-art photoelectric sensing chamber with communications to provide open area protection and are used exclusively with Fire-Lite's Addressable Fire Alarm Control Panels (FACPs). The SD355T(A) adds thermal sensors that will alarm at a fixed temperature of 135°F (57°C). Since these detectors are addressable, they will help emergency personnel quickly locate a fire during its early stages, potentially saving precious rescue time while also reducing property damage. Two LEDs on each sensor light to provide a local, visible sensor indication. Remote LED annunciator capability is available as an optional accessory, PN RA100Z(A). The SD355R(A) is a remote test capable detector for use with D355PL(A) or DNR(A)/DNRW duct smoke detector housings.

Features

SLC LOOP

- Two-wire loop connection.
- Unit uses base for wiring.

ADDRESSING

- Addressable by device.
- Rotary, decimal addressing: 01 – 99 with MS-9200UD(LS), and 01 – 159 with MS-9600UD(LS).

ARCHITECTURE

- Unique single-source, dual-chamber design to respond quickly and dependably to a broad range of fires.
- Sleek, low-profile design.
- Integral communications and built-in type identification.
- Built-in tamper-resistant feature.
- Removable cover and insect-resistant screen for simple field cleaning.

OPERATION

- Withstands air velocities up to 4,000 feet-per-minute (20 m/sec.) without triggering a false alarm.
- Factory preset at 1.5% nominal sensitivity for panel alarm threshold level.
- Visible LED "blinks" when the unit is addressed (communicating with the fire panel) and latches on in alarm.

MECHANICALS

- Sealed against back pressure.
- Direct surface mounting or electrical box mounting.
- Mounts to: single-gang box, 3.5" (8.89 cm) or 4.0" (10.16 cm) octagonal box, or 4.0" (10.16 cm) square electrical box (using a plaster ring — included).

OTHER SYSTEM FEATURES

- Fully coated circuit boards and superior RF/transient protection.
- 94-V0 plastic flammability rating.
- Low standby current.

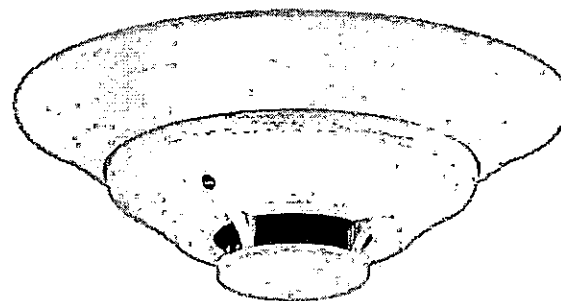

SD355(A) in B210LP(A) Base

2151_2251B_CEILING.png

OPTIONS

- Remote LED output connection, PN RA100Z(A).

Applications

Use photoelectric detectors in life-safety applications to provide a broad range of fire-sensing capability, especially where smoldering fires are anticipated. Ionization detectors are often better than photoelectric detectors at sensing fast, flaming fires.

Construction

These detectors are constructed of off-white fire resistant plastic. SD355(A) series plug-in, low-profile smoke detectors are designed to commercial standards and offer an attractive appearance.

Installation

SD355(A) series plug-in detectors use a detachable mounting base to simplify installation, service and maintenance.

Mount base (all base types) on an electrical backbox which is at least 1.5" (3.81 cm) deep. For a chart of compatible junction boxes, see DF-60059.

NOTE: Because of the inherent supervision provided by the SLC loop, end-of-line resistors are not required. Wiring "T-taps" or branches are permitted for Style 4 (Class B) wiring. SD355R(A) mounts in a D355PL(A) or DNR(A)/DNRW duct detector housing.

Operation

Each SD355(A) series detector uses one of 99 possible addresses on the MS-9200UD(LS) and up to 318 (159 on each loop) on the MS-9600UD(LS) Signaling Line Circuit (SLC). It responds to regular polls from the system and reports its type and status.

The addressable photoelectric sensor in the SD355(A) series has a unique unipolar chamber that responds quickly and uniformly to a broad range of smoke conditions. It can withstand wind gusts up to 4,000 feet-per-minute (20 m/sec.) without sending an alarm level signal. Because of its unipolar chamber, the SD355(A) series is approximately two times more responsive than most photoelectric sensors. This makes it a more stable detector.

Detector Sensitivity Test

Each detector can have its sensitivity tested (required per NFPA 72, Chapter 14 on *Inspection, Testing and Maintenance*) when installed/connected to a MS-9200UD(LS) or MS-9600UD(LS) addressable fire alarm control panel. The results of the sensitivity test can be printed off the MS-9200UD(LS) or MS-9600UD(LS) for record keeping.

Specification

Voltage range: 15 – 32 VDC (peak).

Standby current: 300 µA @ 24 VDC.

LED current: 6.5 mA @ 24 VDC (latched "ON").

Air velocity: 4,000 ft./min. (20 m/sec.) maximum.

Size: 2.1" (5.33 cm) high; base determines diameter.

– **B210LP(A):** 6.1" (15.5 cm) diameter.

– **B501(A):** 4.1" (10.4 cm) diameter.

– **B200SR(A):** 6.875" (17.46 cm) diameter.

– **B224RB(A):** 6.2" (15.748 cm) diameter.

Weight: 3.6 oz. (102 g).

Operating temperature range: for **SD355(A):** 0°C to 49°C (32°F to 120°F); for **SD355T(A):** 0°C to 38°C (32°F to 100°F). **SD355R(A):** installed in a DNR(A)/DNRW -20°C to 70°C (-4°F to 158°F).

Temperature: 0°C – 49°C (32°F – 120°F).

Relative humidity: 10% – 93%, non-condensing.

Listings

Listings and approvals below apply to the SD355(A), SD355T(A), and SD355RT(A) detectors. In some cases, certain modules may not be listed by certain approval agencies, or listing may be in process. Consult factory for latest listing status.

- **UL Listed:** S1059.
- **ULC Listed:** S1059.
- **CSFM:** 7272-0075:0194.
- **MEA:** 243-02-E.
- **FM approved.**

Product Line Information

NOTE: "A" suffix indicates ULC Listed model.

SD355: Addressable photoelectric detector; B210LP base included.

SD355A: Same as SD355 with ULC Listing; B210LPA base included.

SD355T: Same as SD355 but with **thermal** element; B210LP base included.

SD355TA: Same as SD355T with ULC Listing; B210LPA base included.

SD355R: Remote test capable addressable photoelectric detector for use with a D355PL(A) or DNRA/DNRW duct detector housing; B210LP base included.

SD355RA: Same as SD355R with ULC Listing for use with a D355PLA or DNRA duct detector housing; B210LPA base included.

INTELLIGENT BASES

NOTE: "A" suffix indicates ULC Listed model.

NOTE: The detector's plug-in base can be changed off for special applications. For details about intelligent bases and their mounting, see DF-60059.

B210LP(A): Plug-in detector base (included); standard U.S. flanged low-profile mounting base.

B210LPBP: Bulk pack of B210LP; package contains 10.

B501(A): Standard European flangeless mounting base.

B501BP: Bulk pack of B501; package contains 10.

B200SR(A): Intelligent sounder base capable of producing sound output with ANSI Temporal 3 or continuous tone. Replaces B501BH series bases in retrofit applications.

B224RB(A): Plug-in System Sensor **relay** base. Screw terminals: up to 14 AWG (2.0 mm²). Relay type: Form-C. Rating: 2.0 A @ 30 VDC resistive; 0.3 A @ 110 VDC inductive; 1.0 A @ 30 VDC inductive.

B224BI(A): Plug-in System Sensor **isolator** detector base. Maximum 25 devices between isolator bases (see DF-52389).

ACCESSORIES

F110: Retrofit flange to convert B210LP(A) to match the B350LP(A) profile, or to convert older high-profile bases to low-profile.

F110BP: Bulk pack of F110; package contains 15.

F210: Replacement flange for B210LP(A) base.

RA100Z(A): Remote LED annunciator. 3 – 32 VDC. Mounts to a U.S. single-gang electrical box. For use with B501(A) and B210LP(A) bases only.

SMB600: Surface mounting kit

M02-04-00: Test magnet.

M02-09-00: Test magnet with telescoping handle.

XR2B: Detector removal tool. Allows installation and/or removal of detector heads from bases in high ceiling applications.

XP-4: Extension pole for XR2B. Comes in three 5-foot (1.524 m) sections.

T55-127-010: Detector removal tool without pole.

BCK-200B: Black detector covers for use with SD355(A) only; box of 10.

WCK-200B: White detector covers for use with SD355(A) only; box of 10.

FireLite® Alarms is a registered trademark of Honeywell International Inc. ©2015 by Honeywell International Inc. All rights reserved. Unauthorized use of this document is strictly prohibited.



This document is not intended to be used for installation purposes.
We try to keep our product information up-to-date and accurate.
We cannot cover all specific applications or anticipate all requirements.
All specifications are subject to change without notice.

For more information, contact Fire•Lite Alarms. Phone: (800) 627-3473, FAX: (877) 699-4105.
www.firelite.com



by Honeywell

SpectrAlert® Advance

Description

SpectrAlert® Advance selectable-output horns, strobes and horn/strobes are rich with features guaranteed to decrease installation times and maximize profits. The SpectrAlert Advance Series of notification appliances is designed to simplify your installations that offer the following features:

- Plug-in designs.
- Instant feedback messages to ensure correct installation of individual devices.
- Eleven field-selectable candela settings for wall, ceiling strobes and horn/strobes.

Installation

More specifically, to install the Advance products, do the following:

1. Attach a universal mounting plate to a four-inch square, four-inch octagon, or double-gang junction box. The two-wire mounting plate attaches to a single-gang junction box.
2. Connect the notification appliance circuit wiring to the SEMS terminals on the mounting plate.
3. To attach the horn, strobe, or horn/strobe to the mounting plate, insert the product's tabs in the mounting plate's grooves.
4. Rotate the device into position, locking the product's pins into the mounting plate's terminals.
5. The device temporarily holds in place with a catch until you secure it with a captured mounting screw.

SpectrAlert Advance products offer the following options:

- 12 or 24 volts.
- At 24 volts, 15, 15/75, 30, 75, 95, 110, 115, 135, 150, 177, or 185 candela by way of rear-mounted slide switch and front viewing window.
- Horn tones and volume by way of rotary switch.

The SpectrAlert Advance series includes outdoor notification appliances. Outdoor strobes and horn/strobes (two-wire and four-wire) are available for wall or ceiling. Outdoor horns are available for wall only. All System Sensor outdoor products are rated between -40°F and 151°F (-40°C and 66°C) in wet or dry applications.

Sync-Circuit™ is a trademark, and SpectrAlert® and System Sensor® are registered trademarks of Honeywell International Inc. ©2006 by ADT. All rights reserved. Unauthorized use of this document is strictly prohibited.

Selectable Output Notification Appliances

7087pho1.jpg



Indoor Ceiling Horn/Strobe

7087pho2.jpg

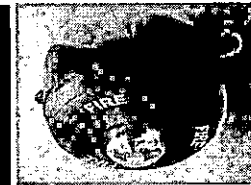

Outdoor Ceiling Strobe

7087pho3.jpg

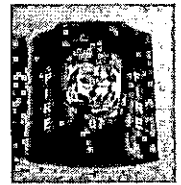

Indoor Wall Horn/Strobe

7087pho4.jpg



Indoor Ceiling Strobe

7087pho5.jpg

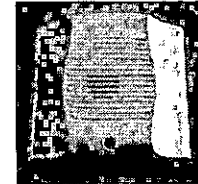

Indoor Wall Horn

7087pho6.jpg

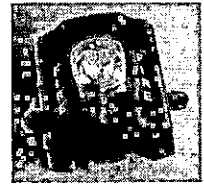

Outdoor Wall Strobe

Features

- Provides a plug-in design.
- Comprises an assortment of outdoor wall and ceiling products.
- Has tamper-resistance capability with minimal intrusion into the backbox.
- Offers the same mounting plate for wall- and ceiling-mount units.
- Includes a shorting spring on the mounting plate for a continuity check before installation and a captive mounting screw.
- Field-selectable candela settings on wall or ceiling units: 15, 15/75, 30, 75, 95, 110, 115, 135, 150, 177, 185.
- Contains an automatic selection of 12 or 24 volt operation at 15 and 15/75 candela.
- Outdoor products rated from -40°F and 151°F (-40°C and 66°C).
- Horn rated at 88+ dbA at 16 volts.
- Provides a rotary switch for tone selection.
- Offers three horn volume settings.
- Electrically compatible with SpectrAlert® products.

SIGNALING



LISTED
S4011

MEA
Approved
FDNY



452-05-E 7125-1653-0188



GAMEWELL-FCI

12 Clintonville Road, Northford, CT 06472-1653 USA • Tel: (203) 484-7161 • Fax: (203) 484-7118

Specifications are for information only, are not intended for installation purposes, and are subject to change without notice. No responsibility is assumed by Gamewell-FCI for their use.

©2015 Honeywell International Inc. All rights reserved.

www.gamewell-fci.com

CS-2539 Rev. D page 1 of 4

Available Models:

- Indoor wall-mount: horn, strobe, 2-wire horn/strobe, 4-wire horn/strobe.
- Indoor ceiling-mount: strobe, 2-wire horn/strobe, 4-wire horn/strobe.
- Outdoor wall-mount: horn, strobe, 2-wire horn/strobe, 4-wire horn/strobe.
- Outdoor ceiling-mount: strobe, 2-wire horn/strobe, 4-wire horn/strobe.

Engineering Specifications

SpectrAlert Advance horns, strobes, and horn/strobes shall mount on a standard 4.0" x 4.0" x 1.5" (10.16 x 10.16 x 3.81 cm) backbox, 4.0" (10.16 cm) octagonal backbox, or a double-gang backbox. Two-wire products shall also mount on a single-gang 2.0" x 4.0" x 1.875" (5.08 x 10.16 x 4.763 cm) backbox. A universal mounting plate shall be used for mounting ceiling and wall products. The notification appliance circuit wiring shall terminate at the universal mounting plate. Also, SpectrAlert Advance products, when used with the Sync•Circuit™ Module accessory, shall be powered from a non-coded notification appliance circuit output and shall operate on a nominal 12 or 24 volts. When used with the Sync•Circuit Module, 12-volt rated notification appliance circuit outputs shall operate between 9 and 17.5 volts; 24-volt rated notification appliance circuit outputs shall operate between 17 and 33 volts. Indoor SpectrAlert Advance products shall operate between 32°F and 120°F (0°C and 49°C) from a regulated DC, or full-wave-rectified, unfiltered power supply. Strobes and horn/strobes shall have field-selectable candela settings including 15, 15/75, 30, 75, 95, 110, 115, 135, 150, 177, 185.

Strobe

The strobe shall be a System Sensor SpectrAlert Advance Model _____ Listed to UL STD 1971 and shall be approved for fire protective service. The strobe shall be wired as a primary-signaling notification appliance and comply with the Americans with Disabilities Act requirements for visible signaling appliances, flashing at 1 Hz over the strobe's entire operating voltage range. The strobe light shall consist of a xenon flash tube and associated lens/reflector system.

Horn/Strobe Combination

The horn/strobe shall be a System Sensor SpectrAlert Advance Model _____ Listed to UL Standards 1971 and 464 and shall be approved for fire protective service. The horn/strobe shall be wired as a primary-signaling notification appliance and comply with the Americans with Disabilities Act requirements for visible signaling appliances, flashing at 1 Hz over the strobe's entire operating voltage range. The strobe light shall consist of a xenon flash tube and associated lens/reflector system. The horn shall have three audibility options and an option to switch between a Temporal 3 pattern and a Non-Temporal (continuous) pattern. These options are set by a multiple position switch. On four-wire products, the strobe shall be powered independently of the sounder. The horn on horn/strobe models shall operate on a coded or non-coded power supply.

Outdoor Products

SpectrAlert Advance outdoor horns, strobes and horn/strobes shall be listed for outdoor use by UL and shall operate between -40°F and 151°F (-40°C and 66°C). The products shall be listed for use with a System Sensor outdoor/weatherproof backbox with half-inch and three-fourths-inch conduit entries.

Synchronization Module

The module shall be a System Sensor Sync•Circuit _____ Listed to UL STD 464 and shall be approved for fire protective service. The module shall synchronize SpectrAlert strobes at 1 Hz and horns at Temporal 3. Also, while operating the strobes, the module shall silence the horns on horn/strobe models over a single pair of wires. The module shall mount to a 4.688" x 4.688" x 2.125" (11.906 x 11.906 x 5.398 cm) backbox. The module shall also control two Style Y (Class B) circuits or one Style Z (Class A) circuit. The module shall synchronize multiple zones. Daisy-chaining two or more synchronization modules together will synchronize all the zones the modules control. The module shall not operate on a coded power supply.

Operating Specifications

Standard operating

temperature: 32° F to 120° F (0° C to 49° C)

K Series operating

temperature:

-40° F and 151° F
(-40° C and 66° C)

Humidity range:

10% to 93% non-condensing
(indoor products).

Strobe flash rate:

1 flash per second.

Nominal voltage:

regulated 12 VDC/FWR or regulated
24 VDC.FWR.

Note: Full Wave Rectified (FWR)
voltage is a non-regulated, time-
varying power source that is used
on some power supply and panel
outputs.

Operating voltage

range:

8 V to 17.5 V (12 V nominal); or 16
V to 33 V (24 V nominal).

Note: P, S, PC, and SC products will
operate at 12 V nominal only for 15
cd and 15/75 cd.

Input terminal wire

gauge:

12 to 18 AWG (3.31 to 0.821 mm²).

Ceiling-mount

dimensions

(including lens):

6.8" diameter x 2.5" deep
(17.3 diameter x 6.4 deep cm)

Wall-mount

dimensions

(including lens):

5.6" H x 4.7" W x 2.5" D
(14.2 H x 11.9 W x 6.4 D cm)

Horn dimensions:

5.6" H x 4.7" W x 1.3" D
(14.2 H x 11.9 W x 3.3 D cm)

GAMEWELL-FCI

12 Clintonville Road, Northford, CT 06472-1653 USA • Tel: (203) 484-7161 • Fax: (203) 484-7118

Strobe Current Draw, UL Maximum (mA RMS)

Candela		8 - 17.5 V		16 - 33 V	
		DC	FWR	DC	FWR
Standard Candela Range	15	123	128	66	71
	15/75	142	148	77	81
	30	NA	NA	94	96
	75	NA	NA	158	153
	95	NA	NA	181	176
	110	NA	NA	202	195
	115	NA	NA	210	205
High Candela Range	135	NA	NA	228	207
	150	NA	NA	246	220
	177	NA	NA	281	251
	185	NA	NA	286	258

Horn Current Draw, UL Maximum (mA RMS)

Sound Pattern	dB	8 - 17.5 V		16 - 33 V	
		DC	FWR	DC	FWR
Temporal	High	57	55	69	75
Temporal	Medium	44	49	58	69
Temporal	Low	38	44	44	48
Non-temporal	High	57	56	69	75
Non-temporal	Medium	42	50	60	69
Non-temporal	Low	41	44	50	50
Coded	High	57	55	69	75
Coded	Medium	44	51	56	69
Coded	Low	40	46	52	50

Horn and Horn/Strobe Rotary Switch Setting

Setting	Repetition Rate	dB Level
1	Temporal Horn	High
2	Temporal horn	Medium
3	Temporal horn	Low
4	Normal horn	Low
5	Normal horn	Medium
6	Normal horn	Low
7*	Externally coded	High
8*	Externally coded	Medium
9*	Externally coded	Low

*NOTE: Settings 7, 8 and 9 are not available on 2-wire horn/strobe

Horn and Horn/Strobe Output (dBA)

Switch Position	Sound Pattern	dB	8 - 17.5 V		16 - 33 V	
			DC	FWR	DC	FWR
1	Temporal	High	78	78	84	84
2	Temporal	Medium	74	74	80	80
3	Temporal	Low	71	73	76	76
4	Non-temporal	High	82	82	88	88
5	Non-temporal	Medium	78	78	85	85
6	Non-temporal	Low	75	75	81	81
7*	Coded	High	82	82	88	88
8*	Coded	Medium	78	78	85	85
9*	Coded	Low	75	75	81	81

*NOTE: Settings 7, 8, and 9 are not available on 2-wire horn/strobe.

GAMEWELL-FCI

12 Clintonville Road, Northford, CT 06472-1653 USA • Tel: (203) 484-7161 • Fax: (203) 484-7118

www.gamewell-fci.com

CS-2539 Rev. D page 3 of 4

Two-Wire Horn/Strobe, STANDARD Candela Range (15 - 115 cd), UL Maximum Current Draw (mA RMS)									
Input, Sound Pattern, dB Level	8 - 17.5 V				16 - 33 V				
	15	15/75	15	15/75	30	75	95	110	115
DC Input, Temporal High	137	147	79	90	107	176	194	212	218
DC Input, Temporal, Medium	132	144	69	80	97	157	182	201	210
DC Input, Temporal, Low	132	143	66	77	93	154	179	198	207
DC Input, Non-temporal, High	141	152	91	100	116	176	201	221	229
FWR Input, Non-temporal Medium	133	145	75	85	102	163	187	207	216
DC Input, Non-temporal, Low	131	144	68	79	96	156	182	201	210
FWR Input, Temporal, High	136	155	88	97	112	168	190	210	218
FWR Input, Temporal, Medium	129	152	78	88	103	160	184	202	206
FWR Input, Temporal, Low	129	151	76	86	101	160	184	194	201
FWR Input, Non-temporal, High	142	161	103	112	126	181	203	221	229
FWR Input, Non-temporal, Medium	134	155	85	95	110	166	189	208	216
FWR Input, Non-temporal, Low	132	154	80	90	105	161	184	202	211

Two-Wire Horn/Strobe, HIGH Candela Range (135 - 185 cd), UL Maximum Current Draw (mA RMS)									
DC Input	16 - 33 V				FWR Input	16 - 33 V			
	135	150	177	185		135	150	177	185
DC, Temporal High	245	259	290	297	FWR, Temporal, High	215	231	258	265
DC, Temporal Medium	235	253	288	297	FWR, Temporal, Medium	209	224	250	258
DC, Temporal Low	232	251	282	292	FWR, Temporal, Low	207	221	248	256
DC, Non-temporal, High	255	270	303	309	FWR, Non-temporal, High	233	248	275	281
DC, Non-temporal, Medium	242	259	293	299	FWR, Non-temporal, Medium	219	232	262	267
DC, Non-temporal, Low	238	254	291	295	FWR, Non-temporal, Low	214	229	256	262

Ordering Information:

Model	Description	Model	Description
WALL HORNS/STROBES		CEILING HORN/STROBES	
P2R	2-wire horn/strobe, standard cd, red.	PC2R	2-wire horn/strobe, standard cd, red.
P2RH	2-wire horn/strobe, high cd, red.	PC2RH	2-wire horn/strobe, high cd, red.
P2RK	2-wire horn/strobe, standard cd, red, outdoor.	PC2RK	2-wire horn/strobe, standard cd, red, outdoor.
P2RHK	2-wire horn/strobe, high cd, red, outdoor (includes backbox).	PC2RHK	2-wire horn/strobe, high cd, red, outdoor.
P2W	2-wire horn/strobe, standard cd, white.	PC2W	2-wire horn/strobe, standard cd, white.
P2WH	2-wire horn/strobe, high cd, white.	PC2WH	2-wire horn/strobe, high cd, white.
P2WK	2-wire horn/strobe, standard cd, white, outdoor, (includes backbox).	PC4R	4-wire horn/strobe, standard cd, red.
P4R	4-wire horn/strobe, standard cd, red.	PC4RH	4-wire horn/strobe, high cd, red.
P4RH	4-wire horn/strobe, high cd, red.	PC4RK	4-wire horn/strobe, standard cd, red, outdoor, (ceiling mount).
P4RK	4-wire horn/strobe, standard.	PC4RHK	4-wire horn/strobe, high cd, red, outdoor.
P4RHK	4-wire horn/strobe, high cd, red, outdoor.	PC4W	4-wire horn/strobe, standard cd, white.
P4W	4-wire horn/strobe, standard cd, white.	PC4WH	4-wire horn/strobe, high cd, white.
P4WH	4-wire horn/strobe, high cd, white.		
WALL STROBES		CEILING STROBES	
SR	Strobe, standard cd, red.	SWHK	Strobe, high cd, white, outdoor.
SRH	Strobe, high cd, red.	SCR	Strobe, standard cd, red.
SRK	Strobe, standard cd, red, outdoor.	SCRH	Strobe, high cd, red.
SRHK	Strobe, high cd, red, outdoor.	SCRK	Strobe, standard cd, red, outdoor.
SW	Strobe, standard cd, white.	SCRHK	Strobe, high cd, red, outdoor.
SWH	Strobe, high cd, white.	SCW	Strobe, standard cd, white.
SWK	Standard, white, outdoor	SCHW	Strobe, high cd, white.
SPEAKER STROBES/HORNS			
SPSCWV-P	Unmarked Speaker Strobe, ceiling-mount, standard candela, high dBA, white.	SPWK	Outdoor Speaker, includes backbox, wall-mounted, white.
SPSR-P	Unmarked Speaker Strobe, indoor, wall-mounted, standard candela, red.	SR-P	Unmarked Horn, wall-mounted, standard candela, red.
SPSR-P	Unmarked Speaker Strobe, indoor, wall-mounted, standard candela dBA, red.		
ACCESSORIES		HORNS	
SBBR	Backbox skirt, wall, red.	HR	Horn, red.
SBBW	Backbox skirt, wall, white.	HRK	Horn, red, outdoor.
SBBCR	Backbox skirt, ceiling, red.	HW	Horn, white.
SBBCW	Backbox skirt, ceiling, white.		

NOTE: "High cd" refers to strobes that include 135, 150, 177, and 185 candela settings. "Standard cd" refers to strobes that include 15, 15/75, 30, 75, 95, 110, and 115 candela settings.