

# Equipment & Supply



## U.S. ELECTRICAL SPECIFICATIONS GUIDELINES

PC	PRODUCT DESCRIPTION	ELECTRICAL SPECIFICATION
22147D	54" Route Stand (48" APW)	120V/60/6.7A per outlet - 2 outlets needed(20-Amp Plug)
0.2634	62" Three tier route stand	120V/925 W/7.7A per ouetlet - 3 20 amp plugs needed (20-Amp Plug)
338704,5	6' Delfield Makeline	3/4 HP/115V/60C/1P/16A (20-Amp Plug)
338702,3	6'-11" Delfield Makeline	3/4 HP/115V/60C/1P/16A (20-Amp Plug)
338700,1	8'-3" Delfield Makeline	3/4 HP/115V/60C/1P/16A (20-Amp Plug)
338715,6	10' Delfield Makeline	3/4 HP/115V/60/1/11.5A (20-Amp Plug)
336201,2	6'-2" Randell Makeline	1/2 HP/115V/60C/1P/12A (15-Amp Plug)
337601,2	7'-6" Randell Makeline	3/4 HP/115V/60C/1P/13A (20-Amp Plug)
338611,601	8'-6" Randell Makeline	3/4 HP/115V/60C/1P/13A (20-Amp Plug)
338617,18	10' Randell Makeline	3/4 HP/115V/60C/1P/13A (20-Amp Plug)
338600	Randell Grab n Go	115/60/1/8.6A (15-Amp Plug)
320260	Hatco Hot Hold	120/60/1/15A (20-Amp Plug)
	Kolpak Walk-In	Evaporators: 1 HP - 115V/60/4.2A 1 1/2 HP - 115V/60/6.4A 2 HP - 115V/60/10A Compressors: 1 HP - 208-230V/9.5A/1P, 6.6A/3P 1 1/2 HP - 208-230V/60/14.3A/1P, 9.2A/3P 2 HP - 208-230V/60/15.2A/1P, 11A/3P
	LED Signs	Standard 110 outlet, 1 amp
	Delfield Sandwich Tables	115/60/1/7.2A/5-15P
345310	1-Door Delfield Refrigerator	115V/12A/1/4 HP/5-15P ,
345311	2-Door Delfield Refrigerator	115V/12A/1/3 HP/5-15P
22272	1-Door Under-Counter Refrigerator	115V/5A
201000	Immersion Blender	120V/400W/3.3A
27005	Washer/Dryer	208-240V/3460-4600W/30A
26997	Washer	120V/60Hz/10A
26996	Electric Dryer	240V/60Hz/5400W/27A
26995	Gas Dryer (Needs 3/8" Line)	120V/60Hz/6A (22,000 BTU/HR)
8117	48" Warming Shelf	120V/400W/3.3A
320300	48" Overhead Warmer	120V/800/6.7A
320815	54" Overhead Warmer	120V/925W/7.7A
8186	Pelouze Digital Portion Scale	110/120V
238725	CookTek Charger Gen. III	120V/1P/15A
320255	Hot-Holding Display Cabinet	120V/60Hz/1470W/12.3A/5-15P (5-20P in Canada) Export voltages available
320819	3/4-Size Hot-Holding Cabinet	120V/60Hz/12A/5-15P
320818	Full-Size Hot-Holding Cabinet	120V/60Hz/16A/5-20P

The above are general guidelines only. Always check manufacturer specifications for complete details.

## GENERAL ELECTRICAL SPECIFICATIONS FOR OVENS & HOODS

PC	PRODUCT DESCRIPTION	ELECTRICAL SPECIFICATION
-	XLT-3255-TS-D	120V/1P/60Hz/Single 6A, Double 12A, Triple 18A Natural Gas: 8"-14" W.C./150,000 BTU Propane Gas: 11.5"-14" W.C./150,000 BTU
-	XLT-3270-TS-D	Gas Lines: 1 1/2" 120V/1P/60Hz/Single 10A, Double 20A, Triple 30A Natural Gas: 8"-14" W.C./190,000 BTU Propane Gas: 11.5"-14" W.C./190,000 BTU Gas Lines: 1 1/2"
	Middleby Marshall	208-240/60/1/12A Nema L-6-20P Cord and Plug NEMA L-6-20P provided with every Oven, customer supplies matching receptacle 6-20-R Gas Lines: 2" for runs up to 200', terminated at a 1-1/4" FULL FLOW gas valve; 6"-12" w.c. Meter size 750 cfm
-	Cap Hood for BOFI 3255	1/2 HP/115V/1/60/9.8A
-	Cap Hood for BOFI 3270	1/2 HP/115V/1/60/9.8A
-	10' Universal Hood	3/4 HP/208-240V/5A
-	11'-6" Universal Hood	3/4 HP/208-240V/5A
26007	10' HP Hood System	3/4 HP/115V/13.8A • 1/2 HP/115V/9.8A
25999	12' HP Hood System	1 HP/115V/16A • 3/4 HP/115V/13.80A
26008	10' XL Hood System	3/4 HP/115V/13.8A • 1/2 HP/115V/9.8A
26001	12' XL Hood System	1 HP/115V/16A • 1 HP/115V/13.80A
	Captive-Aire	Electrical specs vary based on customer need

The above are general guidelines only. Always check manufacturer specifications for complete details. Always check Oven specifications for complete details. Always provide a separate electrical circuit and shut-off valve for each Oven. All breakers must adhere to local codes. Gas-line sizes stated are minimum required. Long runs or runs with many turns may require larger supply.



Simple. Smart.

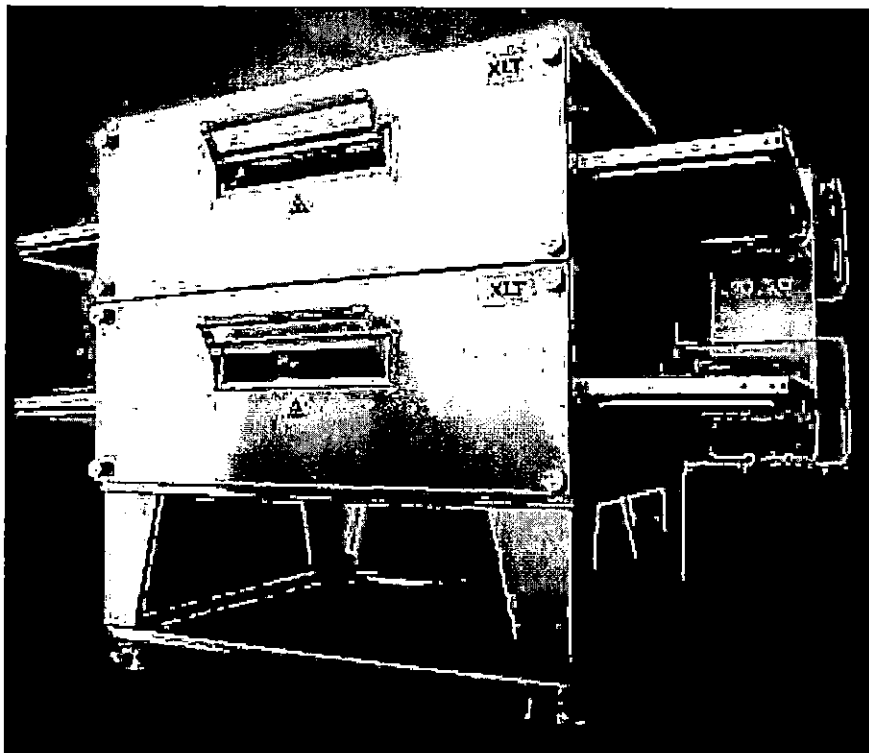

- Five-year warranty (warranty valid only if service is preauthorized through XLT Ovens by BOFI)
- Triples on 1-1/2" gas line
- Fuses are customer accessible on front
- Electrical 120 Volt, 1 Ph.
- Standard perforated crumb tray
- Front panel is easy to remove, making oven easier to clean
- All-Stainless-Steel construction
- Factory installation available in most areas

All Ovens are available  
by cavity:  
Single, Double,  
or Triple stack.  
Please call for a quote.

Electric  
Ovens  
Available.  
Call for  
details.

- BOFI-XLT3870 Extra-Wide 38" Belt = Highest Production
- BOFI-XLT3270 = High Output (the choice for high-volume stores)
- BOFI-XLT3855 = Extra wide 38" belt for high production output
- BOFI-XLT3255 = The choice for new stores
- BOFI-XLT3240 = Space saver with impressive production
- BOFI-XLT2440 = Perfect for tight spaces
- BOFI-XLT1832 = Great for C-Stores or Kiosks

**NOTES**  
All items on this page ship directly from the manufacturer. Lead times vary. For further information, contact your Project Consultant  
  
BOFI-XLT Ovens are also available without windows.  
  
Ask about our Factory-Installation program.

**IMPORTANT REMINDER**  
Check for accuracy and damages to your order at time of delivery. This is very important if you need to file freight claims.

# OVEN CURTAIN

## "Coolkeeper" Oven Curtain

To get a quotation, first, check the box on the form below that indicates the number of sides your enclosure requires. Then, fill in the dimensions (in inches) below per the illustration. Finally, call or fax this information to your local representative or contact a Curtron sales person at 800-833-5005 (Fax: 412-787-3665).

- Clear, reach-through barrier directs oven heat toward the exhaust fan
- Features see-through and reach-through design
- .020" clear, UV stabilized PVC with fire-retardant additive
- Weighted bottoms to keep Strips straight
- No-tear eyelet design
- All-washable parts.

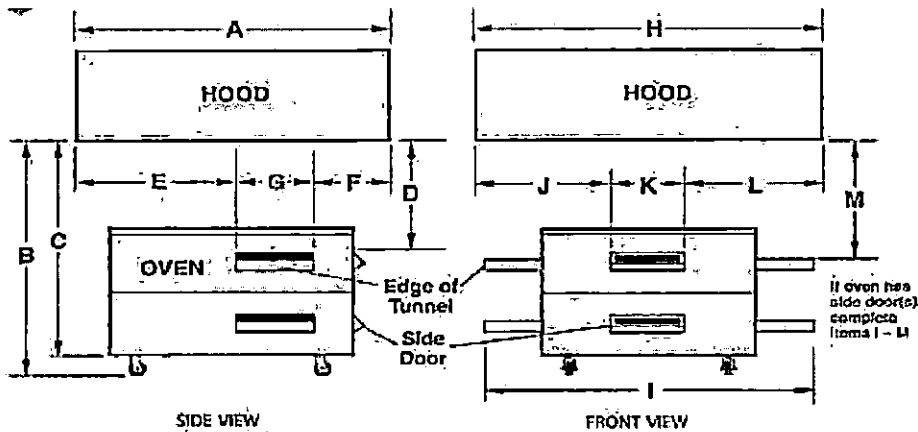
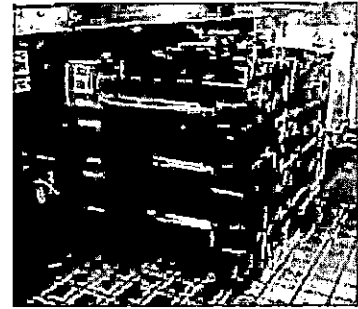
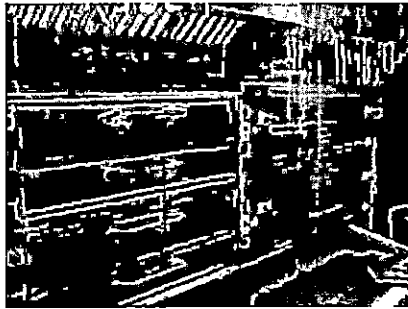

- 2 Sided Enclosure     3 Sided Enclosure     4 Sided Enclosure

- A — Hood Width ( $A = E + G + F$ ) \_\_\_\_\_"  
 B — Bottom of Hood to Floor \_\_\_\_\_"  
 C — Bottom of Hood to Bottom of Oven \_\_\_\_\_"  
 D — Bottom of Hood to Top of Tunnel \_\_\_\_\_"  
 E — Left of Hood to Left Edge of Tunnel \_\_\_\_\_"  
 F — Right of Hood to Right Edge of Tunnel \_\_\_\_\_"  
 G — Width of Tunnel \_\_\_\_\_"  
 H — Length of Hood ( $H = J + K + L$ ) \_\_\_\_\_"  
 I — Length of Oven \_\_\_\_\_"  
 J — Left of Hood to Left Edge of Side Door \_\_\_\_\_"  
 K — Width of Side Door \_\_\_\_\_"  
 L — Right of Hood to Right Edge of Side Door \_\_\_\_\_"  
 M — Bottom of Hood to Top of Side Door \_\_\_\_\_"

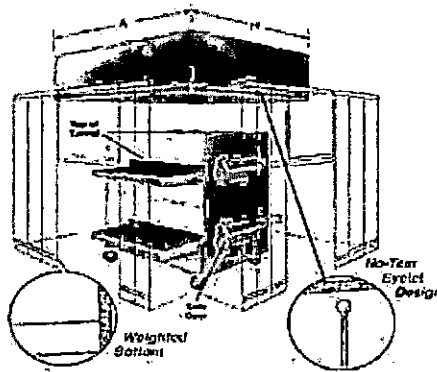

Customer Name: \_\_\_\_\_  
 Customer Location: \_\_\_\_\_  
 Store #: \_\_\_\_\_  
 Customer Phone: \_\_\_\_\_

## Ceiling-Tile Protector

\* Ships directly from the manufacturer. Lead times vary. For further information, contact your Customer Satisfaction Representative

Special Order items are not covered by our return policy. These items will be accepted only at the discretion of our suppliers and may be subject to a restocking fee.

- Quick and easy installation
- Transparent
- Keep airborne dirt away from ceiling tiles
- Flame retardant
- NSF® approved
- Compatible with most diffusers
- 10 years of useful life



Ceiling Tile Protector 4 per box PC 357400

CEILING TILE PROTECTOR

Toll Free: 800-521-8274 • Fax 800-442-0330

**HOODS**

E&S offers the lowest cost systems to achieve great comfort levels and low operating cost. For further information, contact your E&S Capital Equipment Project Consultant. All of our rooftop packages are for flat roofs with an average duct run of about eight feet. Please contact your Capital Equipment Project Consultant for a quote on other applications.

**AVTEC COMPENSATING HOOD SYSTEMS****Traditional Hood System**

- Canopy style
- Partial supply system – 40% of what is being exhausted
- Must exhaust at higher rate for system to work
- Can be more expensive system to install and run (2 sets of ducts and 2 fans)
- High-Performance Hoods have adjustable supply-air louvers

7'-6" Economy Hood PC 357363

7'-6" x 6'-0" - Exh. 2,025 CFM, Supply 810 CFM

9' High-Performance Hood PC 357360

9' x 6'-5" - Exh. 2,475 CFM, Supply 990 CFM

9' Economy Hood PC 357364

9' x 6'-2" - Exh. 2,475 CFM, Supply 990 CFM

10' High-Performance Hood PC 357361

10' L x 6'-5" D - Exh. 3,000 CFM, Supply 1,200 CFM

10' Economy Hood PC 357365

10' L x 6'-5" D - Exh. 3,000 CFM, Supply 1,200 CFM

12' High-Performance Hood PC 357362

12' L x 6'-5" D - Exh. 3,300 CFM, Supply 1,320 CFM

12' Economy Hood PC 357366

12' L x 6'-5" D - Exh. 3,300 CFM, Supply 1,320 CFM

**CAP HOODS****Least Costly Installation**

- Hangs just above Oven (instead of canopy style)
- Exhaust-only hood
- Low exhaust rate (1,200-1,800 CFM)
- Smaller size is good for tight spaces
- Need to replace exhaust air (but MUA rates are small)
- Low installation cost (hangs from braces in ceiling, 1 duct, and 1 fan)
- Capture and containment not as good as some canopy hoods

XLT1832 Cap Hood Package PC 357377

80" x 26" x 24" - 932 CFM

XLT3240/640 Cap Hood Package PC 357388

88" x 32" x 24" - 1,026 CFM

XLT3255/XLT3855/MM555 Cap Hood Package PC 357369

113" x 46" x 30" - 1,200 CFM (Triple 1,800)

XLT3255 Cap Hood Only PC 357370

~~XLT3270/XLT3870/MM 570/670 Cap Hood Package PC 357367~~

~~128" x 46" x 30" - 1,200 CFM (Triple 1,800)~~

XLT3270 Cap Hood Only PC 357368

2-Speed Upgrade for BOFI Hood PC 357212



• All Hood Systems should be balanced after installation to create an optimum work environment.

• Special Order items are not covered by our return policy. These items will be accepted only at the discretion of our suppliers and may be subject to a restocking fee.

• All items on this page ship directly from the manufacturer. Lead times vary. For further information, contact your Project Consultant.

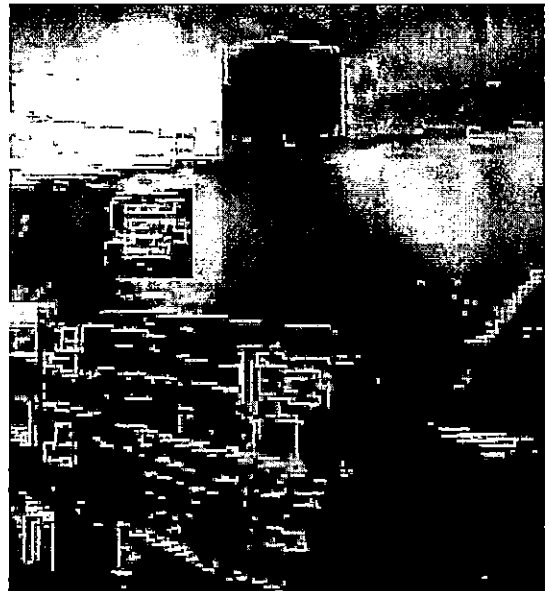

**IMPORTANT REMINDER**  
Check for accuracy and damages to your order at time of delivery. This is very important if you need to file freight claims.

## UNIVERSAL EXHAUST-ONLY HOODS

Great Capture at a Great Cost

- Canopy style
- Exhaust-only hood system – lower exhaust rate than Compensating Hood
- Installation is less than other canopy hoods (one duct and one fan)
- Must have 100% MUA from outside source

11'-6" Universal Wall Hood PC 357165  
 11'-6" L x 6' D - 1,800 CFM (Double) to 2,600 CFM (Triple)

11'-6" Universal Island Hood PC 357166  
 11'-6" L x 6' D - 1,800 CFM (Double) to 2,600 CFM (Triple)

10' Universal Island Hood PC 357171  
 10' L x 6' D - 1,800 CFM (Double) to 2,600 CFM (Triple)

10' Universal Wall Hood PC 357160  
 10' L x 6' D - 1,800 CFM (Double) to 2,600 CFM (Triple)

*NOTE: Two-speed fan included with every package.*

Full Wall Panel for Greenheck Hoods PC 357168



## AVI HOOD SYSTEMS

- For XLT ovens only
- Cap style with the lowest exhaust rates in the market place
- Smart looks that add to any kitchen design
- Pre-piping for ansul system available

## FOUR SIMPLE STEPS TO CUSTOMIZING YOUR AVI HOOD SYSTEM

\*Installation includes setting hood on top of oven and hanging panels around conveyor ends.  
 Installation does not include hanging hood, duct work, or roof top work.

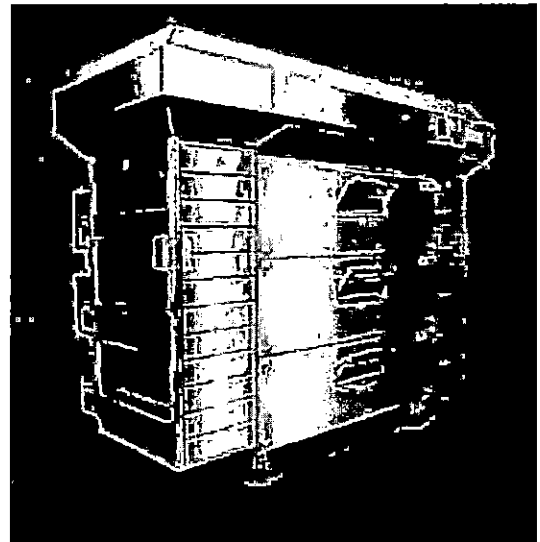

PC	Description	Comments
	<b>(Step 1 - Hoods Choose the right size hood for your ovens.)</b>	
357604	3240/55/70 Hood w/full VFD controls	
357605	3855/70 Hood w/full VFD controls	
357606	3240/55/70 Hood w/ no control system	
357603	3855/70 Hood with no control system	
357620	Intl: 3240/55/70 with full VFD controls	Includes crating - for International only
	<b>(Step 2 - Exhaust Fan: Choose the right exhaust fan for your application.)</b>	
357610	AVI Exhaust fan and flat roof curb	
357612	AVI Exhaust fan and side mount curb	
357613	AVI Side mount exhaust fan and no curb	
	<b>(Step 3 - Transportation: Choose whether you will have unit shipped or factory installed.)</b>	
357609	AVI Hood crating	Order must include crating or install cost
357608	AVI Panel crating	
357618	AVI Panel install w/oven delivery	
357619	AVI Hood/panel delivery and install	
357621	AVI Hood/panel crating (International)	
	<b>(Step 4 - Options)</b>	
355028	S/S Product shelf for XLT	Includes 2 product shelves
357614	Ansul pre-piping for hood	Optional - check local requirements
355085	Retro kit with existing double XLT ovens	Need SN to confirm for retrofitting new hood with older ovens
355086	Retro kit with existing triple XLT ovens	Need SN to confirm for retrofitting new hood with older ovens
357611	AVI Universal S/S duct shroud	Optional
357601	S/S Valance - AVI Hood 9'-9'5" ceiling	Optional
357600	S/S Valance - AVI Hood 9'6"-10' ceiling	Optional
357602	S/S Valance - AVI Hood 10'1"-10'6" ceiling	Optional

**KOLPAK® WALK-IN COOLER BOXES**

Kolpak Cooler Boxes feature four-inch foamed-in-place, Class-1 Urethane insulation with an R factor of 34. UL and NSF certified. Available in Natural or White Galvalume exterior finish. Other sizes available (call for quotes and specifications) also available are Cooler Conversion Kits, allowing you to increase your Cooler sizes. Boxes available with or without floor; and all Boxes include LED light fixture. Kolpak's "Structural Floor Panels" feature a .100-thick Aluminum surface bonded to 3/4-plywood underlayment. The floor is reinforced with Fibreglas® joists 12" on center. The floor panels can withstand loads up to 5,000 pounds per square foot.

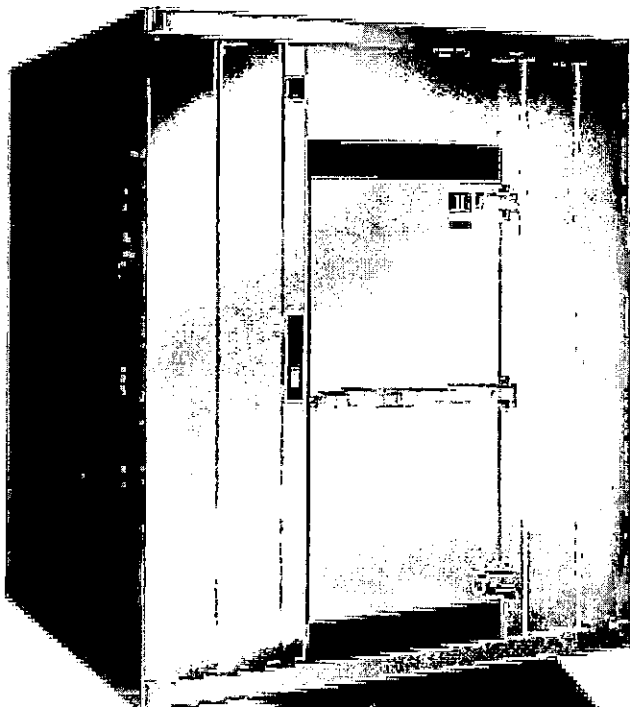

Kolpak is the Leader in Walk-Ins  
All Walk-Ins purchased through E&S can be  
expanded at a later date as needed.

- Due to the pounds per square inch typically carried on DoughDollies, E&S recommends floorless Walk-Ins whenever possible.
- For International orders, a voltage upcharge may apply.
- All items on this page ship directly from the manufacturer. Lead times vary. For further information, contact your Project Consultant.

All items on this page ship directly from the manufacturer. Lead times vary. For further information, contact your Project Consultant

**IMPORTANT REMINDER**

Check for accuracy and damages to your order at time of delivery. This is very important if you need to file freight claims.

Toll Free: 800-521-8274 • Fax 800-442-0330

**COOLER BOXES WITH FLOOR**

8' x 10' - Dimensions: Outside - 7'-9" W x 8'-6-1/4" H x 9'-8" D	
Cooler Box, Door Centered on 8' Side	PC 342500
Cooler Box, Door Off-Centered on 10' Side to the Left	PC 342501
Cooler Box, Door Off-Centered on 10' Side to the Right	PC 342502
Cooler Door Section, Left Hinged	PC 340900
Cooler Door Section, Right Hinged	PC 340901
Galvalume Exterior Finish	PC 342422

10' x 10' - Dimensions: Outside - 9'-8" W x 8'-6-1/4" H x 9'-8" D	
Cooler Box, Door Centered	PC 342510
Cooler Box, Door Off-Centered to the Left	PC 342511
Cooler Box, Door Off-Centered to the Right	PC 342512
Cooler Door Section, Left Hinged	PC 340900
Cooler Door Section, Right Hinged	PC 340901
Galvalume Exterior Finish	PC 342422

**COOLER BOXES WITHOUT FLOOR**

8' x 10' - Dimensions: Outside - 7'-9" W x 8'-3-3/4" H x 9'-8" D	
Cooler Box, Door Centered on 8' Side	PC 24010S
Cooler Box, Door Off-Centered on 10' Side to the Left	PC 24011S
Cooler Box, Door Off-Centered on 10' Side to the Right	PC 24012S
Cooler Door Section, Left Hinged	PC 340902
Cooler Door Section, Right Hinged	PC 340903
Galvalume Exterior Finish	PC 342422

10' x 10' - Dimensions: Outside - 9'-8" W x 8'-3-3/4" H x 9'-8" D	
Cooler Box, Door Centered	PC 24015S
Cooler Box, Door Off-Centered to the Left	PC 24016S
Cooler Box, Door Off-Centered to the Right	PC 24017S
Cooler Door Section, Left Hinged	PC 340902
Cooler Door Section, Right Hinged	PC 340903
Galvalume Exterior Finish	PC 342422

The smallest standard cooler allowed in new builds is 8'x12'.

Custom Coolers PC 340000

It's cheaper  
to buy more  
Walk-In Cooler now,  
then add  
panels later.

Reach-in  
Glass Doors  
are available.  
Call your  
Sales Consultant  
for information.

\* Evaporator and Compressor must be sized based on Cooler size and geographic region. Please ask your Project Consultant for assistance.  
\*\* Please order the correct electrical phase for your location.



## COOLER EXPANSION KITS

With Floor  
 Cooler Expansion Kit (To 8' x 12') PC 342503  
 Cooler Expansion Kit (To 10' x 12') PC 342513

Without Floor  
 Cooler Expansion Kit (To 8' x 12') PC 24180S  
 Cooler Expansion Kit (To 10' x 12') PC 24023S

## KOLPAK® WALK-IN COOLER COMPONENTS

Clear-Vu Swing Door, Installed on New Walk-In  
 (See Page XX) PC 23997

Tread Kickplate, 36" x 1/8"  
 (For Bottom of Exterior Door; order when you order the Cooler Box) PC 24001

Tread Kickplate, 36" x 1/8"  
 (For Bottom of Interior Door; order when you order the Cooler Box) PC 24002

Tread Kickplate, 36" x 1/8"  
 (For Bottom of Exterior Door; Retrofit) PC 24003

Tread Kickplate, 36" x 1/8"  
 (For Bottom of Interior Door; Retrofit) PC 24004

Nonskid Cooler Strip Kit, 25 Pcs.  
 (For 8' x 12' Cooler) PC 24025

Replacement Nonskid Strip,  
 (Single Strip) PC 24028

Fluorescent Light Fixture, 48" PC 24029

LED Light Fixture for cooler PC 24181

Replacement Lens Cover for 48" Fluorescent Light Fixture PC 342410

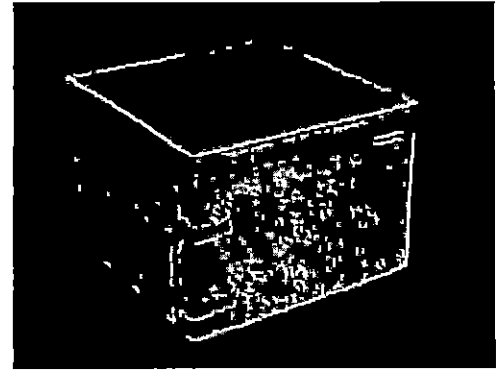

STRUCTURAL FLOOR PANEL, CUT-AWAY

### NOTES

All items on this page ship directly from the manufacturer. Lead times vary. For further information, contact your Project Consultant

Call  
 for a Quote  
 on Extra-Tall  
 Coolers!

## REFRIGERATION SYSTEMS - CONDENSING UNIT

Copeland® Compressors available in either single or triple phase; oversize condenser to ensure efficient performance at ambient temperatures up to 120 degrees; pre-assembled, pre-charged remote units with outdoor package; Hermetic R404A refrigerant for environmental and ozone protection; all compressors come with a five year warranty (4 year parts only).

1-HP Single-Phase Compressor PC 24007  
 1-HP Triple-Phase Compressor PC 24008  
 1.5-HP Single-Phase Compressor PC 24031  
 1.5-HP Triple-Phase Compressor PC 24032  
 2-HP Single-Phase Compressor PC 343006  
 2-HP Triple-Phase Compressor PC 343007

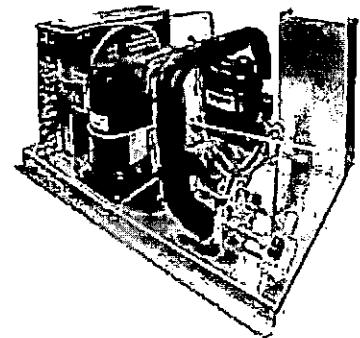

## REFRIGERATION SYSTEMS - EVAPORATORS

Bohn® coils in center mount space saver evaporator with E.C. motors; low velocity for stable air movement and low humidity; PVC coated fan guards; heavy gauge, grained aluminum exterior for durability and easy cleaning; uses R404A refrigerant.

1-HP Evaporator PC 24009  
 1.5-HP Evaporator PC 24030  
 2-HP Evaporator PC 343005

Toll Free: 800-521-8274 • Fax 800-442-0330

**IMPORTANT REMINDER**  
 Check for accuracy and damages to your order at time of delivery. This is very important if you need to file freight claims.

## IMPERIAL WALK IN COOLERS

Imperial Manufacturing Company is an employee-owned company with plants in Oregon and North Carolina. The best possible panel insulation meet or exceed EISA R-value requirements, and use environment friendly HCFC-free 245a blowing agent. R-32 insulation factor 4" panels.



- Taller 9'-0"H walk ins for greater storage space in the same footprint
- Taller 84"H door opening to handle your tallest stack of dough trays (27 trays on dOugh dolly!)

Cooler boxes are available with and without floors.

PC 340001

Beacon II Refrigeration System offers several advantages:

- Fewer mechanical components for increased reliability
- Field installation savings - set the processor and you're done! No need to return for final valve adjustments
- Evaporator coil location on back wall increases vertical storage capacity inside walk in. Coil is well above the tall mobile dough tray stacks.

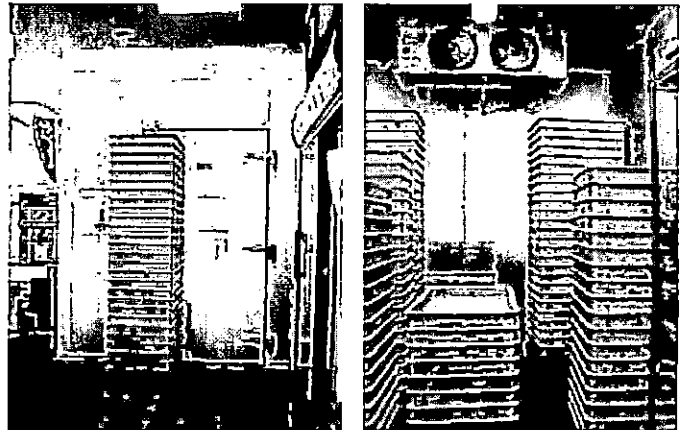

## CLEAR-VU SWING DOOR

- Self-closing swing doors
- For use with nominal-size Coolers with 34" x 78" doors
- 31 lbs.

Clear-Vu Swing Walk-In Cooler Door	PC 23990
Right "Z" Bracket (allows for installation around light fixtures on older Coolers)	PC 342437
Left "Z" Bracket	PC 342438
Replacement Panel for Clear-Vu Swing Door	PC 342435



CLEAR-VU WALK-IN COOLER DOOR

## CURTAINS

- Cuts energy use by up to 44%
- Flexible and durable for quick and easy installation
- Available in custom sizes upon request
- Eliminates temperature fluctuations

G-Series Style Cooler Curtain, 36" Nominal (Not Shown)	PC 23998
G-Series Style Cooler Curtain, 41" x 84" (Older Coolers)	PC 24000
"G" Replacement Strips, 3-Pack (use with older Walk-In Coolers)	PC 23992
"U" Replacement Strips, 3-Pack, 6" wide	PC 23993

G-SERIES HARDWARE  
(loop slides into bar chamber)

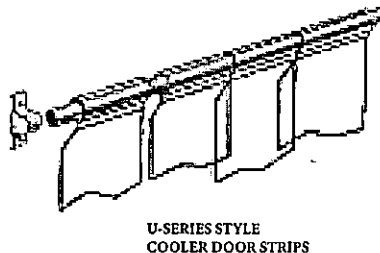
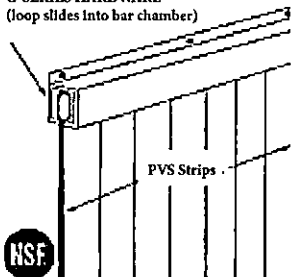

U-SERIES STYLE COOLER DOOR STRIPS



G-SERIES STYLE CURTAIN

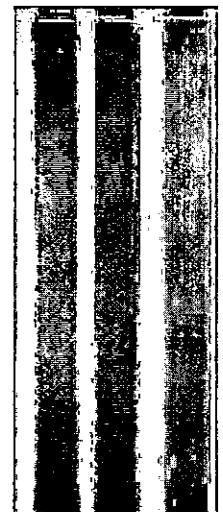

U-SERIES STYLE CURTAIN

Toll Free: 800-521-8274 • Fax 800-442-0330

**IMPORTANT REMINDER**  
Check for accuracy and damages to your order at time of delivery. This is very important if you need to file freight claims.

**DELFIELD® MAKELINES**

- Makelines come with the compressor on either the right or left end as needed (should be located away from the cheese); pull-down covers incorporated into overshef; R404-A refrigerant. The catch pan's temperature has been lowered, and is now NSF® listed for food-product holding.
- NSF®-certified product temperature with or without Overshef
- Catch pans are made of ABS (lightweight and durable) for easier handling and cleaning with lifetime warranty
- Dual-controlled temperature controls

10' RCP Makeline	PC 338715
120"L X 34"W X 52"H	
10' LCP Makelines	PC 338716
120" L X 34" W X 52" H	
8'-3" RCP Makeline - 2001 Model	PC 338700
99" L x 34" W x 52" H	
8'-3" LCP Makeline - 2001 Model	PC 338701
99" L x 34" W x 52" H	
6'-11" RCP Makeline - 2001 Model	PC 338702
83" L x 34" W x 52" H	
6'-11" LCP Makeline - 2001 Model	PC 338703
83" L x 34" W x 52" H	
6' RCP Makeline - 2001 Model	PC 338704
72" L x 34" W x 52" H	
6' LCP Makeline - 2001 Model	PC 338705
72" L x 34" W x 52" H	

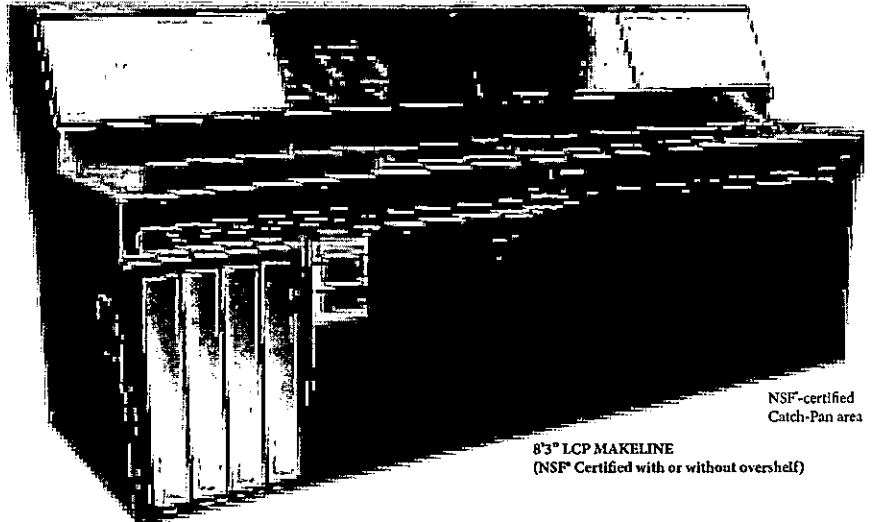

NSF-certified Catch-Pan area

8'-3" LCP MAKELINE (NSF® Certified with or without overshef)

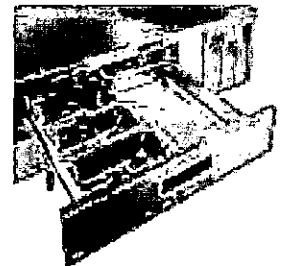

Available with drawer

Now available with a Drawer for easy access, located next to compressor.

8'-3" RCP Makeline with Drawer PC 338710  
99" L x 34" W x 52" H

8'-3" LCP Makeline with Drawer PC 338711

**DELFIELD MAKELINE SPECIFICATIONS**

Size	Dimensions	Doors	HP Volt/Hz/PH Amps	NEMA
10' RCP	120"L x 34"D x 51.5"H	(3)27" & (1) 19"	3/4+ 115/60/1	11.5 5-20P
10' LCP	120"L x 34"D x 51.5"H	(3)27" & (1) 19"	3/4+ 115/60/1	11.5 5-20P
8'-3" RCP	99" L x 34" D x 51.5" H	(3) 27" 3/4	115/60/1	16 5-20P
8'-3" LCP	99" L x 34" D x 51.5" H	(3) 27" 3/4	115/60/1	16 5-20P
6'-11" RCP	83" L x 34" D x 51.5" H	(1) 27" 3/4	115/60/1	16 5-20P + (2) 19"
6'-11" LCP	83" L x 34" D x 51.5" H	(1) 27" 3/4	115/60/1	16 5-20P + (2) 19"
6' RCP	72" L x 34" D x 51.5" H	(2) 27" 3/4	115/60/1	16 5-20P
6' LCP	72" L x 34" D x 51.5" H	(2) 27" 3/4	115/60/1	16 5-20P

**NOTES**

- Autocheeser Makeline Bracket is also available (see Page 40).
- Charges may apply for International voltage.
- If Makeline is tipped on its side during unloading or installation, unit must sit for 24 hours before being plugged in.
- All items on this page ship directly from the manufacturer. Lead times vary. For further information, contact your Capital Equipment Project Consultant.

**PREVENTATIVE MAINTENANCE**

- Clean Makelines daily as per the MRG.
- Wipe Door Gaskets clean daily.
- Clean fins on Compressors daily or at least weekly.
- Remember to clean fins on Coke® coolers and Walk-Ins.
- Change HVAC filters on a regular basis.

**IMPORTANT REMINDER**

Check for accuracy and damages to your order at time of delivery. This is very important if you need to file freight claims.

\* Ships directly from the manufacturer. Lead times vary. For further information, contact your Capital Equipment Project Consultant.

Toll Free: 800-521-8274 • Fax 800-442-0330

## MAKELINE ACCESSORIES

### Makeline Door Gaskets

Available for Delfield and Randell Makelines. Easy to install.

Replacing worn-out Gaskets:

- Will help Makelines maintain proper temperatures
- Helps prolong Compressor life
- Will use less energy
- Helps keep hot air out

### Delfield Door Gaskets

18" Delfield Makeline Door Gasket	PC 203630*
19" Delfield Makeline Door Gasket	PC 203631*
24" Delfield Makeline Door Gasket	PC 203632*
27" Delfield Makeline Door Gasket	PC 203633*

### Randell Door Gaskets

24" Randell Makeline Door Gasket	PC 203120*
27" Randell Makeline Door Gasket	PC 203121*

### Fin Comb (Compressor Cleaner)

For Walk-In and Makeline; Stainless-Steel "teeth" get in and around fins on your Compressor; straightens fins for long-operating efficiency; features sliding tension bar and "knuckle-saver" handle.

Fin Comb PC 24006



FIN COMB

## MAKELINE DOORS & GASKETS GUIDE

MAKELINE	DOOR(s)	SIZE-MODEL #
<b>Delfield®</b>		
6'	(3) 18"	D0001025
6'	(2) 27"	D000A05/08
6'	(2) 27"	D00A072R/L
6'-11"	(2) 19" + (1) 27"	D00A083R/L
6'-11"	(2) 19" + (1) 27"	D0000A04/07
7'	(2) 18" + (1) 24"	D0001041
7'	(3) 24"	D0001052
8'-3"	(3) 27"	D0000A03/06 & D000A0994/L
10'	(3) 27" +(1) 19"	DO0A1ZOR/L
<b>Randell®</b>		
6'-2"	(2) 27"	DPM74R/L
7'-6"	(3) 24"	DPM90R/L
8'-6"	(3) 27"	DPM102R/L
10'	(3) 27"	DPM120R/L
10'	(4) 24"	DPM I20 R/L-4

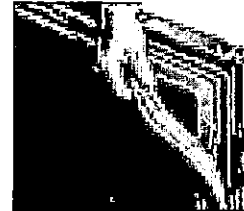

PRESS-FIT GASKET

Contact your Capital  
Equipment Project  
Consultant for  
a current copy of  
the Pizza Theater  
Catalog.

### IMPORTANT REMINDER

Check for accuracy and damages to your order  
at time of delivery. This is very important  
if you need to file freight claims.

\* Ships directly from the manufacturer. Lead times vary. For further information, contact your Customer Satisfaction Representative or Capital Equipment Project Consultant.

## CUT TABLES, OVERSHELVES, AND OVERSHELF ACCESSORIES

### Domino's Cut Table

Developed to maximize efficiency by keeping everything within arm's reach. The modular design is flexible and allows for easy adjustment in order to meet individual crew members' preferences and ergonomic needs. Modular construction provides the added benefit of being able to be shipped knocked down, resulting in freight savings.

6' Cut Table with Overshelf, 72" L x 54" D PC 320850

Item #1

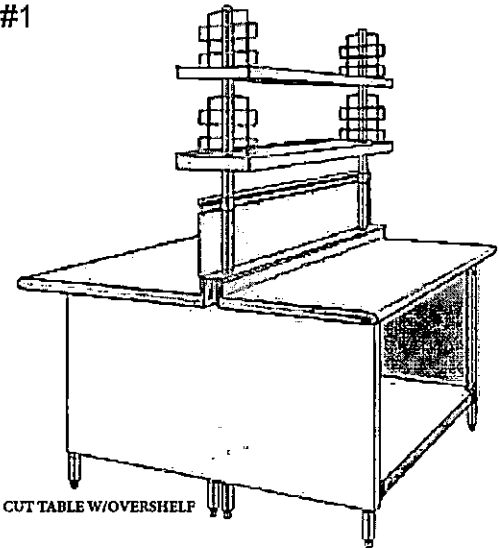

6' CUT TABLE W/OVERSHELF

### Cut - Table Bases - Traditional

Order-taking side is open for storage of boxes; 16-gauge Stainless-Steel table; adjustable feet; NSF® certified; other lengths available as Special Order. Contact your Capital Equipment Project Consultant.

Dimensions: Cut-Table Bases - 36" H x 54" D

6' Cut-Table Base (Not Shown)	PC 22257D
7' Cut-Table Base (Not Shown)	PC 320701
8' Cut-Table Base (Not Shown)	PC 22258D

### Retrofit Overshelves

Developed for existing Cut Tables to increase efficiency and productivity, the Retrofit units will fit on 6', 7' and 8' Cut Tables; Overshelf for 8' Base is 7' long. Modular technology offers flexibility to meet individual crew members' preferences and needs.

6' Retrofit Overshelf	PC 320860
7' Retrofit Overshelf	PC 320870
6' Stainless-Steel Single Overshelf	PC 320802
7' Stainless-Steel Single Overshelf	PC 320805

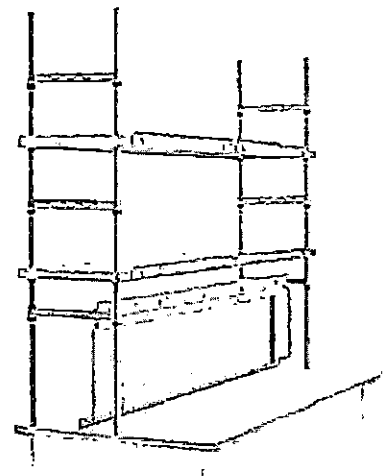

RETRO-FIT OVERSHELF

### Tool Accessories & Screen Holders

Tool Accessories attach directly to the Tool Rail for maximum productivity. No assembly required. Made in accordance with NSF® guidelines. All metal parts are 100% Stainless Steel.

Tool Accessory Package PC 320825  
(Includes Items listed below, which are also available separately)

#### Accessories:

Tub Holder	PC 320828
2-Bottle Holder	PC 320826
3-Bottle Holder	PC 320827
12" Screen Holder	PC 320830
14" Screen Holder	PC 320831
6' Tool Accessory Rail for Laminate Overshelf	PC 320835
8' Tool Accessory Rail for Laminate Overshelf	PC 320836

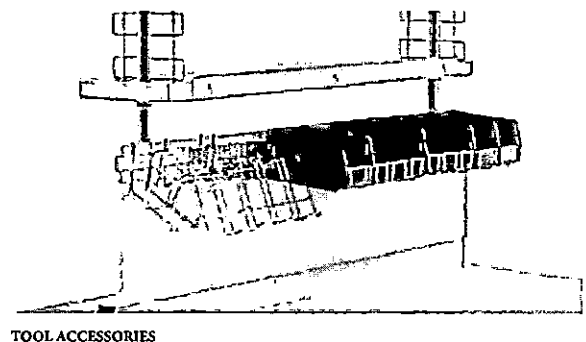

TOOL ACCESSORIES

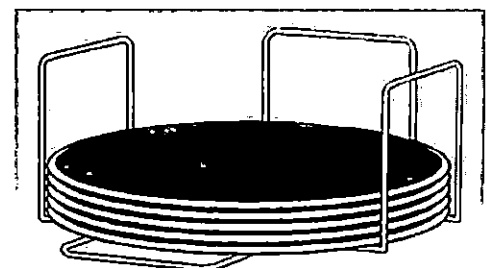

SCREEN HOLDER

#### IMPORTANT REMINDER

Check for accuracy and damages to your order at time of delivery. This is very important if you need to file freight claims.

Toll Free: 800-521-8274 • Fax 800-442-0330

# SINKS AND ACCESSORIES

## SINKS & ACCESSORIES

### Molded-Stone Mop Sink

- Stone composite
- Includes faucet, vacuum breaker and wall-mounted mop hangers
- 48" reinforced rubber hose
- Stainless-Steel hose bracket and mounting hardware
- 24" x 24" outside; 1" rim; 10" deep
- Weighs 61 lbs.

Molded-Stone Mop Sink

PC 28096



MOLDED STONE MOP SINK

Item #29

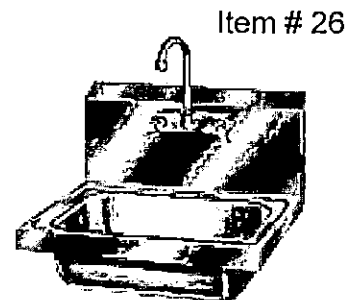

HAND SINK WITH FAUCET

### Hand Sink With Faucet

- Heavy-gauge, 300 Series, Stainless Steel
- NSF® certified
- Gooseneck faucet included
- Mounts on 8"-high backsplash
- Basin measures 14" x 10" x 5"

Hand Sink

PC 28099

Hand Sink with Wrist Handles

PC 383101\*

Item #28

16x16x14

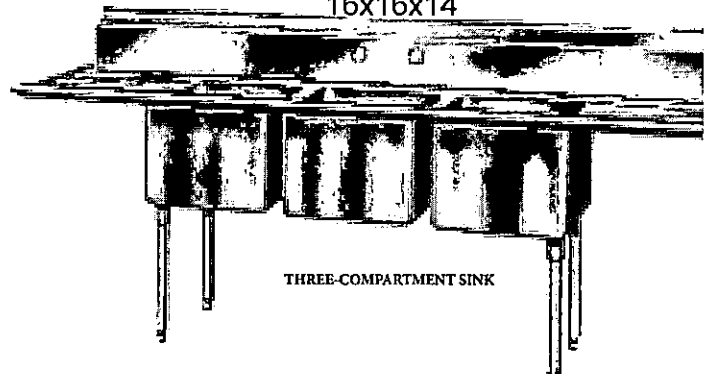

THREE-COMPARTMENT SINK

### Compartment Sinks

- 14" deep basins with 20-gallon capacity
- Two 18" drainboards
- 16-gauge, 300 Series Stainless Steel
- NSF® certified
- 37" working height

3-Compartment Sink

PC 28102\*

87-1/4" L x 27-1/2" D x 39-1/2" H (Shown)

4-Compartment Sink

PC 383005\*

(Requires 2 Faucets)

103" L x 27-1/2" D x 39-1/2" H (Not Shown)

3-Compartment 24" Drainboard

PC 383010\*



FAUCET

### Faucet

- Mounts on backsplash of Three-Compartment Sink
- Swinging tube spout

Economy Faucet with 14" Nozzle

PC 383012

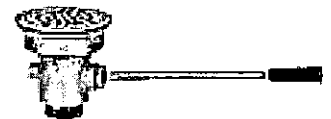

LEVER WASTE

### Lever Waste

- Opens and closes 3-1/2" drains
- Individual compartment drainage of Three-Compartment Sink
- Stainless-Steel strainer, flange and handle

Lever Waste

PC 383050

### Three-Compartment Sink Sprayers

- 14" Add-On Faucet
- Flexible Stainless-Steel gooseneck hose
- On/Off valve
- Approximately 40" high

Economy Sprayer with Add-On Faucet

PC 383011

Sprayer with Add-On Faucet

PC 383055

Wall Bracket for Overhead Sprayer

PC 28108

Replacement Hose

PC 383054

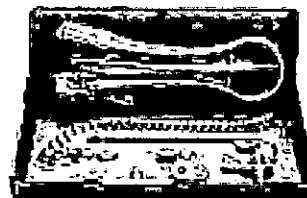

THREE-COMPARTMENT SINK SPRAYER

WALL BRACKET FOR OVERHEAD SPRAYER

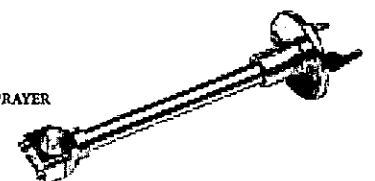

\* Ships directly from the manufacturer. Lead times vary. For further information, contact your Customer Satisfaction Representative or Project Consultant

**ROUTE STANDS**

Item #3

Shelves use a special heat-absorbing coating and raised ribs to allow moisture to escape while the heat-retention side and front panels minimize heat loss. Assembly required.

60" Route Stand, 60" x 18" x 86" PC 320810 (A)  
 NOTE: Heat Lamps sold separately

Stainless-Steel 3-Tier Route Stand PC 0.2634 (B)  
 62-3/8" x 24" x 82-1/4" (Three 54" Heat Lamps Included)

54" Overhead Warmer with Remote-Mounted Infinite Controller PC 320815 (C)

54" Overhead Warmer Infinite Controller (220V/50H, International Use) PC 320315\*

54" Traditional Route Stand PC 22147D\*  
 54" W x 70-1/2" H x 24" D

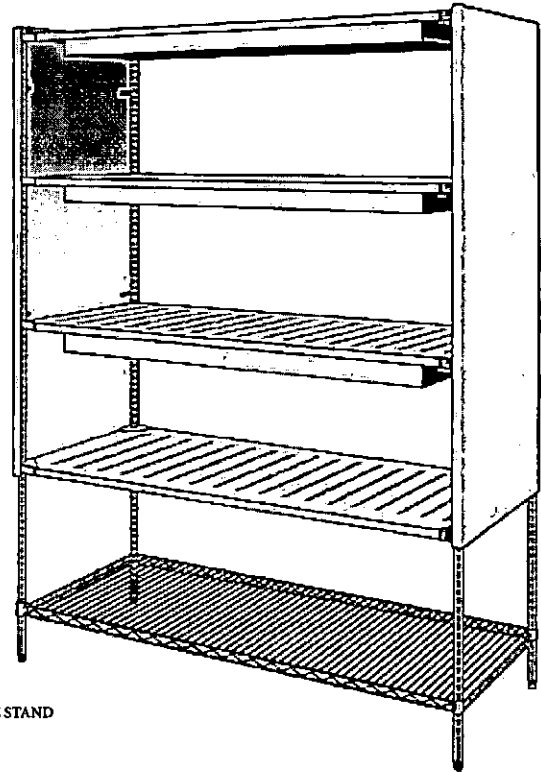

(A)  
ROUTE STAND

**WARMING SHELVES**

- Built-in Infinite control on Warming Shelf
- Stainless-Steel box and construction
- Dual-purpose mounting and hanging brackets included
- Two-year element warranty, one-year parts and labor
- Shelves are 48" long
- Fits most routing stands

48" Overhead Warmer with On/Off Switch PC 320300 (D)  
 48" Warming Shelf APW PC 8117 (E)

54" Overhead Warmer with On/Off Switch (Not Shown) PC 320305

60" Overhead Warmer with On/Off Switch (Not Shown) PC 320310

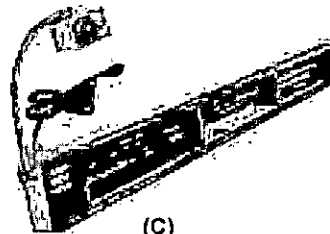

(C)  
54" OVERHEAD WARMER

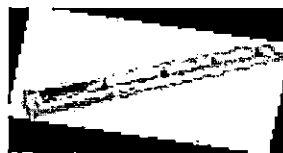

(D) 48" OVERHEAD WARMER

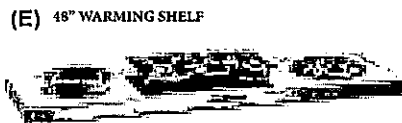

(E) 48" WARMING SHELF

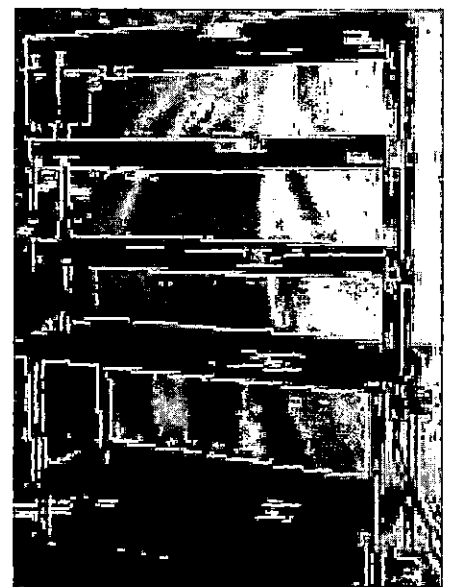

(B) ROUTE STAND W/WARMING SHELVES

**NOTES**

- See Pages 1-3 for information on warranties and electrical specifications.
- Charges may apply for International voltage.
- Contact your Capital Equipment Project Consultant for a current copy of the Pizza Theater Catalog

**IMPORTANT REMINDER**  
 Check for accuracy and damages to your order at time of delivery. This is very important if you need to file freight claims.





**DOUGH COUNTERS**

- 16-gauge, 300 Series polished Stainless-Steel worktops
- Tops are 34" deep and have a 36" working height
- Extra strength and durability with channel supports under the center
- Sound-deadening material applied to the undersurfaces
- Constructed in accordance with NSF® Certification #2
- Easy to assemble
- Easy and reliable leveling with adjustable bullet feet
- Dough Counters with legs are shipped knocked down to economize on freight charges (for 4', 5' and 6' Dough Counters)

	4" Backsplash <i>(Pizza Theater)</i>	10 1/2" Backsplash
1' Spacer (No Legs)	PC 273159	PC 22261D
2' Spacer (No Legs)	PC 273160	PC 22262D
3' <del>Spacer (No Legs)</del>	PC 273161	PC 22263D
4' Dough Counter with Legs	PC 273162	PC 22264D
5' Dough Counter with Legs	PC 273163	PC 22265D
6' Dough Counter with Legs	PC 273164	PC 22266D
Double-Leg Assembly	PC 22314D	PC 22314D

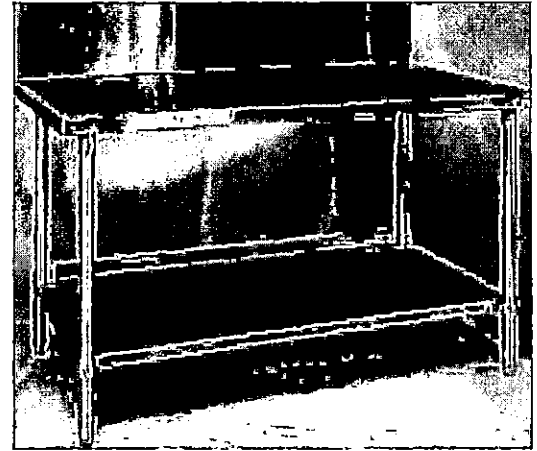

6' DOUGH COUNTER W/LEGS

Optional Undershelves

4' Underself	PC 233334
5' Underself	PC 233335
6' Underself	PC 233336

**UNIVERSAL CORNER**

Changes the corner of the layout into a more direct "L" shape without sacrificing space or quality. Includes one set of legs.

	4" Backsplash <i>(Pizza Theater)</i>	10 1/2" Backsplash
Universal Corner 34" W x 36" H x 34" D	PC 273165	PC 22139D



UNIVERSAL CORNER

**UTILITY DRAWER**

Utility Drawer attaches to underside of Rolling Table or 4', 5' or 6' Dough Counter, giving extra storage space.

Utility Drawer (Fits Rolling Table, & 4', 5', & 6' Dough Counters) PC 0.2656  
25-5/8" x 24-5/8" x 11-1/2"; 10" deep

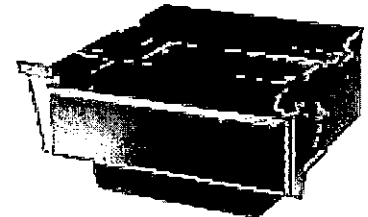

UTILITY DRAWER

**DOUGH TABLE AND CUSTOMER VIEWING LEDGE**

*(Pizza Theater)*

Curved Corian® Customer Ledge - Left (112" x 18")	PC 273154 A
Curved Corian® Customer Ledge - Right (112" x 18")	PC 273155
Curved Corian® Customer Ledge w/ADA - Left (112" x 18")	PC 273156 B
Curved Corian® Customer Ledge w/ADA - Right (112" x 18")	PC 273157
8' Dough Table w/Corian® Top Curved - 96" x 42 1/4" x 36" H	PC 273150 C
Straight Corian® Customer Ledge - 78" x 18"	PC 273151 D
Straight Corian® Customer Ledge w/ADA - Left - 78" x 18"	PC 273152 E
Straight Corian® Customer Ledge w/ADA - Right - 78" x 18"	PC 273153
8' Stainless Dough Table - Straight - 96" x 34" x 36" H (includes 4" Backsplash)	PC 273100 F
8' Dough Table w/Corian® Top - Straight - 96" x 34" x 36" H	PC 273101 G

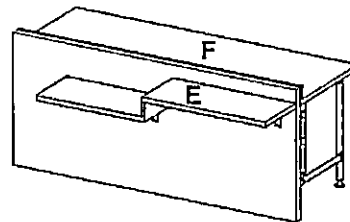
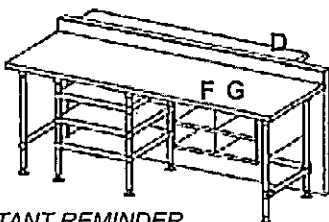
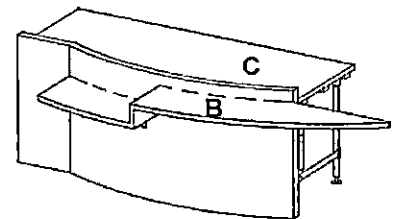
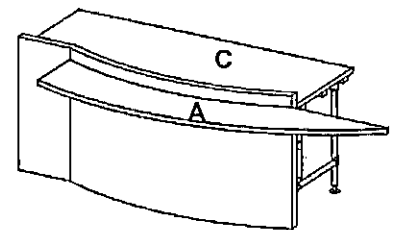

**IMPORTANT REMINDER**

Check for accuracy and damages to your order at time of delivery. This is very important if you need to file freight claims.

Toll Free: 800-521-8274 • Fax 800-442-0330

\* Ships directly from the manufacturer. Lead times vary. For further information, contact your Capital Equipment Project Consultant.

# WORK TABLES AND HOT/HOLD CABINETS

## WORK TABLES

### Standard Work Tables

Reinforced 18-gauge, Stainless-Steel top; heavy galvanized undershelf; 35-1/2" high with adjustable bullet feet; rolled rim edge. Call for quote on special sizes.

2' Work Table, 24" x 24" (Not Shown)	PC SUB020
3' Work Table, 36" x 30" (Not Shown)	PC SUB019
4' Work Table, 48" x 30" (Not Shown)	PC 326031*
5' Work Table, 60" x 30" (Shown)	PC 22289

### Economy Work Tables

New 35-1/2"-high Tables have an 18-gauge Stainless-Steel top, a galvanized undershelf and adjustable bullet feet; straight edge.

Economy Work Table, 24" x 24"	PC 233340
Economy Work Table, 36" x 30"	PC 233341
Economy Work Table, 4'	PC 233342
Economy Work Table, 5'	PC 233343
Drawer (ships separately)	PC 233349
Casters, Set of 4 (2 with brakes)	PC 233348

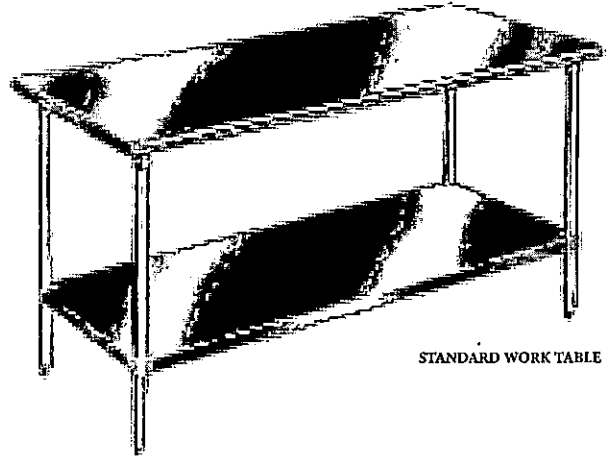

STANDARD WORK TABLE

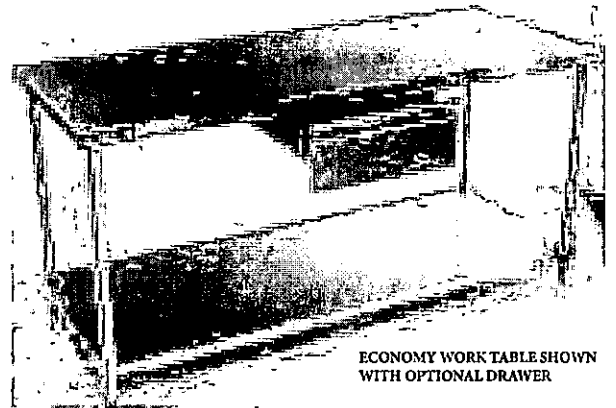

ECONOMY WORK TABLE SHOWN WITH OPTIONAL DRAWER

## HOT HOLD DISPLAY CABINETS

Powerful, efficient Holding Cabinets are fully insulated and keep prepared foods at serving temperatures. Pass-thru design allows for access for preparation and service areas. Doors are field reversible for flexibility. 3/4 Height holds up to 24 14" pies, full size height holds up to 36 14" pies.

3/4" Height Hot Holding Cabinet	PC 320819
25"W x 33"D x 57 1/4"H	
Graphics Upgrade	PC 320817
Full Size Height Hot Holding Cabinet	PC 320818
25"W x 33" D x 74 1/2"H	
Graphics Upgrade	PC 320816

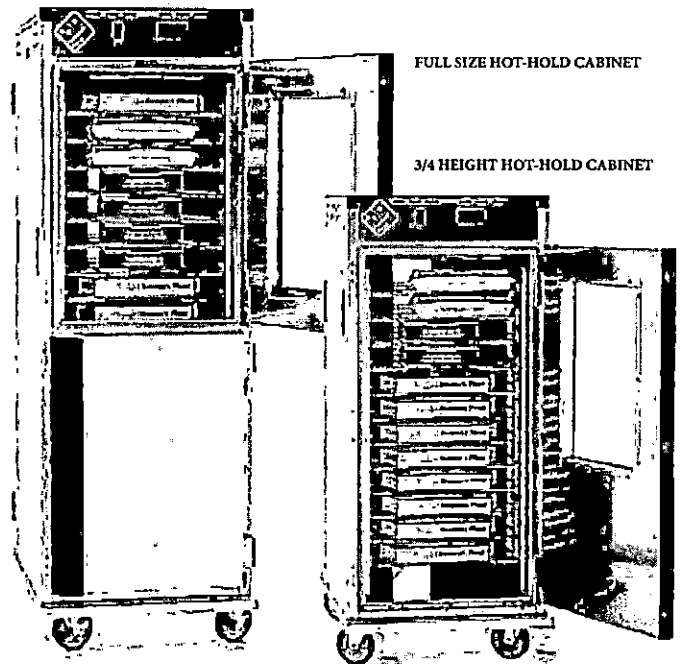

**CRES COR.**

\* Ships directly from the manufacturer. Lead times vary. For further information, contact your Capital Equipment Project Consultant.

**IMPORTANT REMINDER**  
Check for accuracy and damages to your order at time of delivery. This is very important if you need to file freight claims.

**METRO® STORAGE SYSTEMS**

Ergonomically designed Wall Storage Systems are designed to improve storage and efficiency by locating items where they are easily accessible, freeing up valuable counter space. Stainless-Steel track allows grid to be easily mounted on a variety of wall materials. Grid and accessories are easily removed for cleaning with the use of any tools. Flexible for customizing to your needs

**Slap Table Wall System**

- Improves speed and work flow by efficiently locating screens, pans, cutters, bottles, paper, and spoodles
- Includes 22" track, 30"x48" chrome wall grid, 18"x48" basket shelf, shelf with side ledges, 17"x17" shelf, stainless steel two bottle holder, tub holder, and six inch prong hook

Slap table wall system

PC 411980

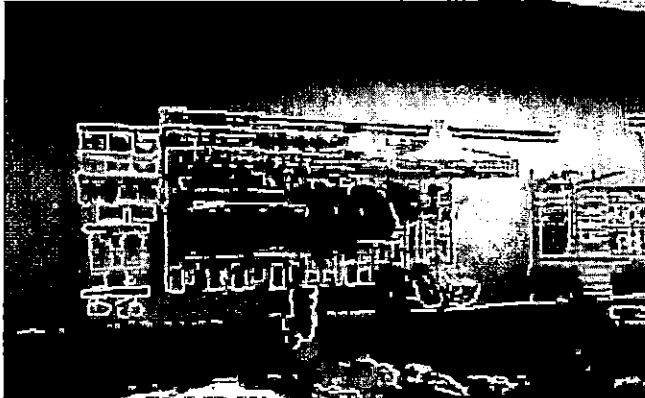

SLAP TABLE WALL SYSTEM

**Three-Compartment Sink Wall System**

- Provides convenient, low-cost, effective storage of your small-ware items
- Includes track, 36" x 30" wall grid, one large 3' basket, one small basket, one Bottle Holder, one lid/cutter holder, and four single prongs for adjustable storage

Complete Sink Wall Storage System

PC 411956

6" Single-Prong Holder

PC 411951\*

Basket for Wall- Mount Storage

PC 411952\*

Lid-Drying Rack

PC 411953\*

Basket Shelf for Storage System

PC 411955\*

Bottle Holder for Storage System

PC 411954\*

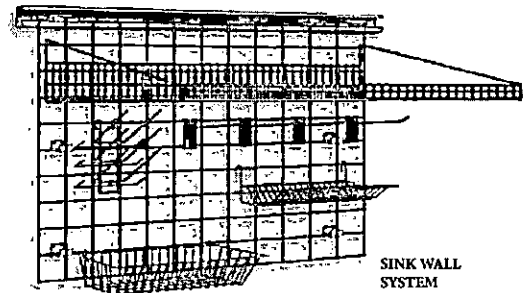

SINK WALL SYSTEM

**Makeline Wall Shelf**

- Provides additional storage and functionality above the makeline
- Improves speed and work flow by efficiently locating bottles, tubs and spice containers
- Post mounting allows for adjustable heights

Includes:

60" Single Tier

- (1) 60"x12" cantilevered shelf with 1" turned up edge
- (2) 13" posts with wall brackets
- (2) double bottle holders
- (1) tub holder



SINGLE TIER WALL SHELF

60" Single tier

PC 320886

60" Double Tier

- (2) 60"x12" cantilevered shelf with 1" turned up edge
- (2) 33" posts with wall brackets
- (2) double bottle holders
- (1) tub holder

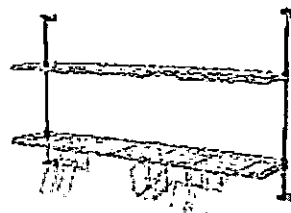

DOUBLE TIER WALL SHELF

60" Double tier

PC 620887

**Wall-Mounted Office Storage**

- Includes 24" x 12" cantilevered shelf to hold CPU, 72" Stainless-Steel mounting track, 33" posts and two 12" x 48" cantilevered shelves
- Holds up to 200 lbs.
- Some assembly required

Wall-Mounted Office Shelf

PC 411981

**Office-Area Desk**

- Includes 24" x 12" cantilevered shelf to hold CPU and keyboard shelf to minimize clutter on desk
- Laminated top
- Some assembly required

Office-Area Desk Box 1 of 2 PC 321010

Office-Area Desk Box 2 of 2 PC 321012

NOTE: Must order both items to receive the complete package.

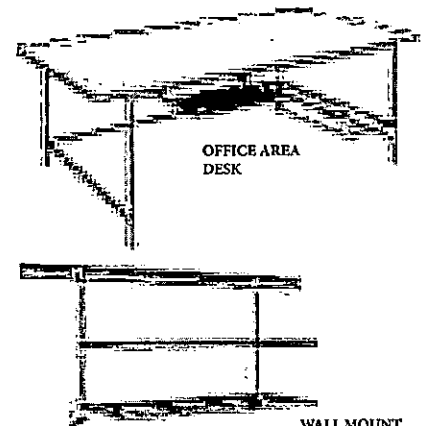

OFFICE AREA DESK

WALL MOUNT OFFICE SHELF

**IMPORTANT REMINDER**

Check for accuracy and damages to your order at time of delivery. This is very important if you need to file freight claims.

Toll Free: 800-521-8274 • Fax 800-442-0330

Special Order items are not covered by our return policy. These items will be accepted only at the discretion of our suppliers and may be subject to a restocking fee.

**HEALTH DEPARTMENT: FOOD STORAGE**

Most health departments require all food products to be stored at least six inches off the floor. If you are unsure about your food storage, check with your local health department

## WALL STORAGE

### Wall-Mount Shelf

- Stainless Steel
- Durable, easy to clean
- 48" in length
- NSF® certified
- Includes wall brackets
- 48" L x 12" D



WALL MOUNT SHELF

Wall-Mount Shelf PC 8201

### Wall-Mount Pan Shelf

- Mounting brackets included
- Chrome-plated, rust-free Steel Shelf



WALL MOUNT PAN SHELF

Pan Shelf PC 9221  
36" L x 12" D (Shown)

Two-Tiered Pan Shelf PC 9223\*  
60" L x 12" D, (not shown)

### Speed Rail

- 21-1/4" L x 6" H x 4-1/8" D
- Mounts to side of Cut Table
- Holds eight 24-oz. Squeeze Bottles
- Weighs 4-1/2 lbs.



SPEED RAIL

Speed Rail PC 8351

## Olympic® Shelving

- NSF® certified
- Green Epoxy
- Suitable for wet or dry storage
- Weight capacity: 800 lbs. for each Shelf (up to 48")
- Weight capacity: 600 lbs. for each Shelf (over 48")

Olympic Wire Shelf 18" x 36" PC 411960  
 Olympic Wire Shelf 18" x 48" PC 411961  
 Olympic Wire Shelf 18" x 60" PC 411962  
 Olympic Wire Shelf 18" x 72" PC 411963  
 Olympic Wire Shelf 24" x 24" PC 411964  
 Olympic Wire Shelf 24" x 36" PC 411965  
 Olympic Wire Shelf 24" x 48" PC 411966  
Olympic Wire Shelf 24" x 60" PC 411967  
 Metro 3-Sided Double Frames  
 Olympic Green, Finish, 18" x 48"  
 PC 411971  
 Metro 3-Sided Double Frames, Olympic  
 Green Finish, 24" x 60" PC 411972  
 Metro Shelving Collets PC 3250  
 Olympic Posts PC 411970

## WALL STORAGE

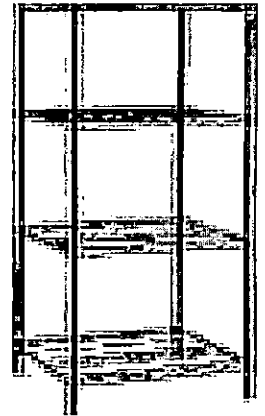

OLYMPIC® SHELVING

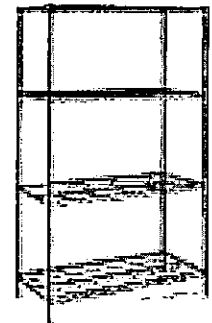

## MetroMax® Shelving

- Microban® antimicrobial protection
- Lifetime warranty against corrosion and rust
- Use in or out of Walk-In
- Open Shelves snap into place
- Each square Post has a leveling foot
- Order four Posts for every Shelving unit required

MetroMax Shelf, 18" x 36" PC 3240  
 MetroMax Shelf, 18" x 48" PC 3241  
 MetroMax Shelf, 18" x 60" PC 3242  
 MetroMax Shelf, 24" x 48" PC 3243  
 MetroMax Post, 74", Each PC 3244  
 MetroMax Post, 13", Each PC 3245\*

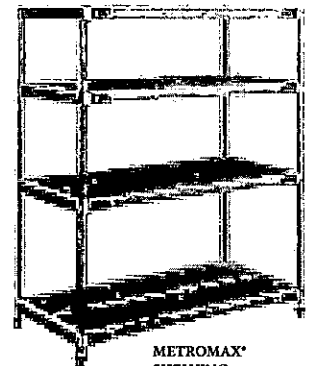

METROMAX® SHELVING

**HEALTH DEPARTMENT; FOOD STORAGE**  
 Most health departments require all food products to be stored at least six inches off the floor. If you are unsure about your food storage, check with your local health department.

### IMPORTANT REMINDER

Check for accuracy and damages to your order at time of delivery. This is very important if you need to file freight claims.

\* Ships directly from the manufacturer. Lead times vary. For further information, contact your Customer Satisfaction Representative.

## WASHERS AND DRYERS

Item #31A

WASHERS & DRYERS

### Sears® Kenmore® All-In-One Washer-Dryer

- 27" W x 37-1/4" D x 72-3/4" H
- Available in 220V/50 cycle
- Gas is 16,000 BTU

All-In-One Washer-Dryer, Electric  
All-In-One Washer-Dryer, Gas

PC 27005  
PC 27006

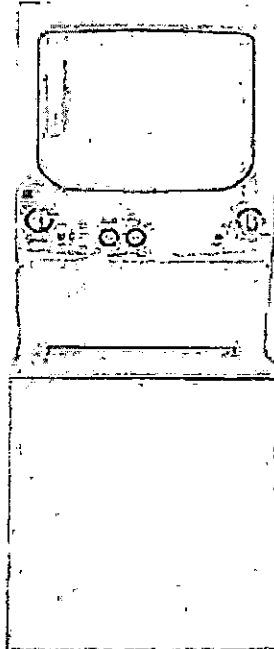

ALL-IN-ONE WASHER-DRYER

### Sears® Kenmore® Side-By-Side Washer-Dryer

- 26-7/8" W x 25-1/2" D x 43-1/8" H
- Available in 220V/50 cycle
- Dryer is available in Gas or Electric

Extra-Capacity Washer, Gas Model  
Extra-Capacity Dryer, Electric Model  
Extra-Capacity Dryer, Gas Model

PC 26997  
PC 26996  
PC 26995

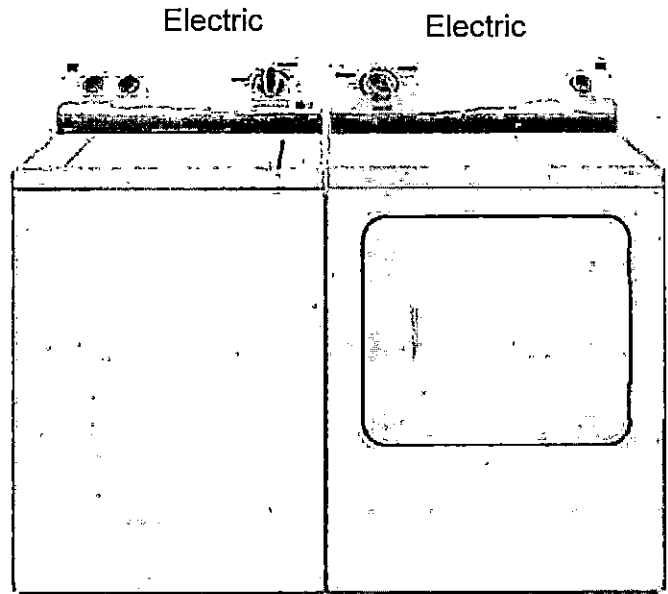

## SAFES & SECURITY

### Time-Delay Safes

Secure, value-added Safe has mailbox-drop slot into locked inner compartment with nine-minute time delay; Sargent & Greenleaf electronic lock on outer door; 1/2"-thick Steel body and door; four anchor holes and bolts on Safe floor. Comes with two-year warranty, second-year parts only. Weighs 290 lbs.

Dual-Compartment Safe with Digital Lock/Time Delay  
19" W x 20" H x 22" D

PC 381811

Dual-Compartment Safe with Digital Lock/Time Delay  
19" W x 27" H x 22" D

PC 381810

### Securitron®

#### Electromagnetic Door-Locking System

Keeps store locked during, as well as after, business hours without hindering access to store personnel; touch-sensitive bar inside the door releases the lock so drivers can exit easily and safely; entry is possible only when button is pushed (entry button is on the inside of the store, out of sight of the customer). Other buttons and components available on Special Order. Fits doors up to 36" wide; other sizes available upon request. Call for details. (Not Shown)

Securitron Security System

PC 22160



DUAL-COMPARTMENT SAFE  
W/DIGITAL LOCK/TIME DELAY

\* Ships directly from the manufacturer. Lead times vary.  
For further information, contact your Customer Satisfaction Representative or Capital Equipment Project Consultant.

**IMPORTANT REMINDER**  
Check for accuracy and damages to your order at time of delivery. This is very important if you need to file freight claims.

**PIZZA THEATER**

The Pizza Theater design was developed to showcase a revitalized Domino's brand. It takes Domino's store presence from "delivery plus carry-out" to a full "dine-in" experience. The open design showcases our pizza-making process and promotes an exciting customer experience. The Resource Guide contains the equipment you will need to install the Pizza Theater concept in your new or existing store.

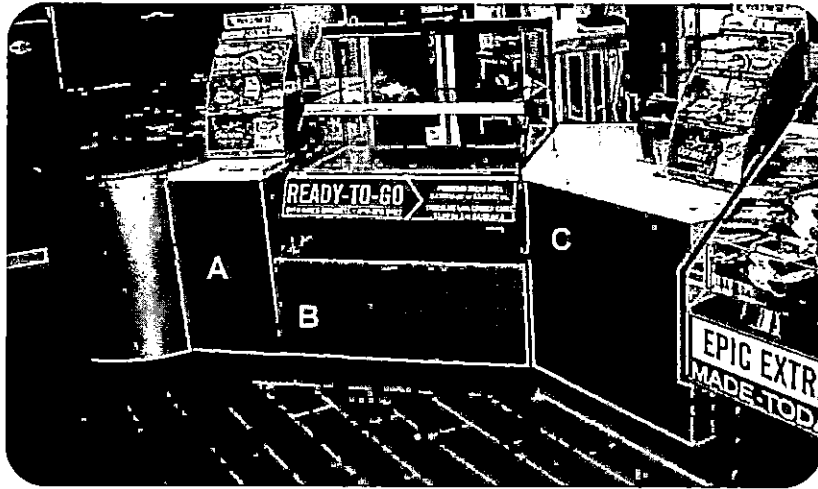

**POINT OF SALE COUNTERS**  
 Left Hand Pickup Counter/Corner Radius **A**  
 Hot Hold Cabinet Base **B**  
 Left Hand 45 degree POS Counter **C**  
 Monitor Posts for POS Counters **D**  
 (Included with all POS Order Counters)

PC 273124  
 PC 273126  
 PC 273125

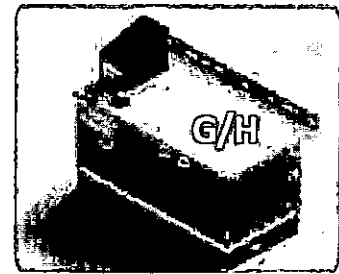
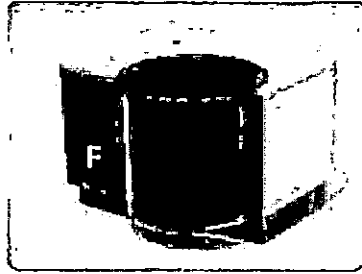
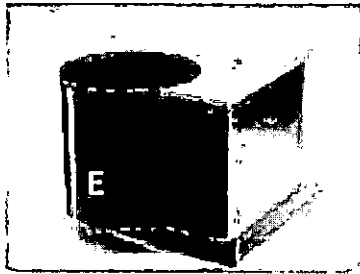
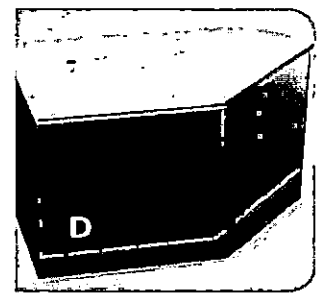
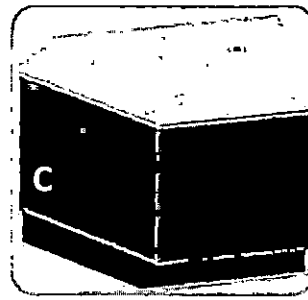
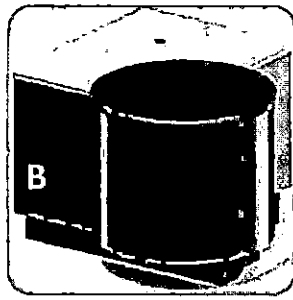
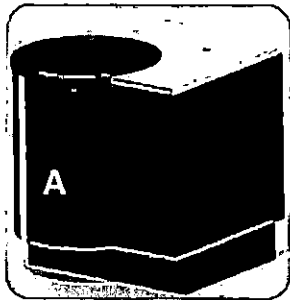

**POINT OF SALE COUNTERS**

Left Hand Pickup Counter/Corner Radius **A**  
 Right Hand Pickup Counter/Corner Radius **B**  
 Left Hand 45 degree POS Counter **C**  
 Right Hand 45 degree POS Counter **D**  
 Left Hand Pickup Counter/Center Radius **E**  
 Right Hand Pickup Counter/Center Radius **F**  
 Beverage Counter **G/H**  
 Beverage Counter Top Organizer **G/H**  
 36" POS Order Cabinet (not shown)  
 includes grommet hole for POS Electrical

PC 273124	30" POS Order Cabinet (not shown)	
PC 273130	includes grommet hole for POS electrical	PC 273137
PC 273125	36" POS Filler Cabinet (not shown) Solid Corian® Top	PC 273142
PC 273133	30" POS Filler Cabinet (not shown) Solid Corian® Top	PC 273143
PC 273131	25" POS Filler Cabinet (not shown) Solid Corian® Top	PC 273138
PC 273132	14" POS Filler Cabinet (not shown) Solid Corian® Top	PC 273135
PC 273140	Coke® Cooler Cabinet Base, (not shown)	
PC 273141	Cooler available through Coke®	PC 273134
PC 273136	Monitor Posts for POS Counters, (optional), Raises Monitors 12"	PC 273114

## LOBBY SEATING

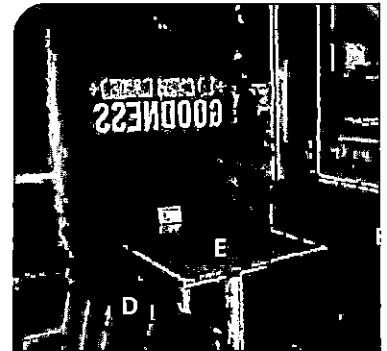

- |   |   |                 |
|---|---|-----------------|
| Barstool with silver frame                      | A | 318046          |
| 3-seat waiting bench 60"                        | B | 318021          |
| Counter stool with silver frame 27"             | C | 318047          |
| Side chair with silver frame 18"                | D | 318045          |
| 36" x 48" Table top and 2 bases (ADA compliant) | E | 318028 / 318029 |
| 1' Section of booth seating (priced per foot)   |   | 318025          |
| 36" x 24" Table top and 1 base (not shown)      |   | 318026 / 318027 |
| 36" Round table and 1 base (not shown)          |   | 318034 / 318035 |
| 48" Single long booth section                   | F | 318048          |
| 48" Double long booth section                   |   | 318049          |

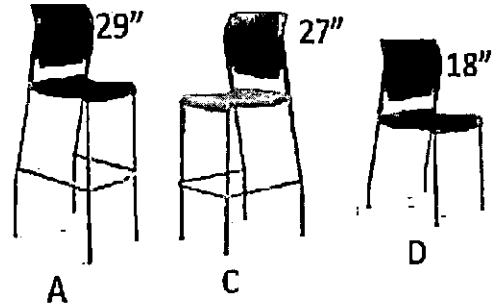

## DOUGH TABLE AND CUSTOMER VIEWING LEDGE



- |   |   |        |
|---|---|--------|
| Curved Corian® customer ledge - left - 120" x 20" | A | 273154 |
| 8' Dough Table w/Corian® top curved - 96" x 39"   | B | 273150 |
| Straight Corian® customer ledge - 96" x 12"       | C | 273151 |

### IMPORTANT REMINDER

Check for accuracy and damages to your order at time of delivery. This is very important if you need to file freight claims.

## DOUGH TABLE AND CUSTOMER VIEWING LEDGE

(Pizza Theater)

Curved Corian® Customer Ledge - Left (112" x 18")	PC 273154 A
Curved Corian® Customer Ledge - Right (112" x 18")	PC 273155
Curved Corian® Customer Ledge w/ADA - Left (112" x 18")	PC 273156 B
Curved Corian® Customer Ledge w/ADA - Right (112" x 18")	PC 273157
8' Dough Table w/Corian® Top Curved - 96" x 42 1/4" x 36" H	PC 273150 C
Straight Corian® Customer Ledge - 78" x 18"	PC 273151 D
Straight Corian® Customer Ledge w/ADA - Left - 78" x 18"	PC 273152 E
Straight Corian® Customer Ledge w/ADA - Right - 78" x 18"	PC 273153
<u>8' Stainless Dough Table - Straight - 96" x 34" x 36" H</u>	PC 273100 F
(includes 4" Backsplash)	
8' Dough Table w/Corian® Top - Straight - 96" x 34" x 36" H	PC 273101 G

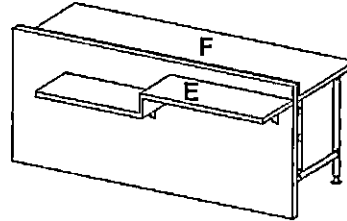
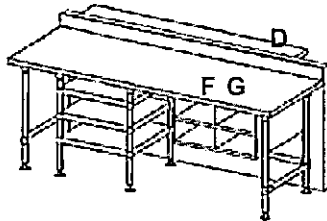
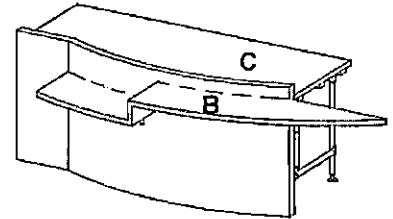
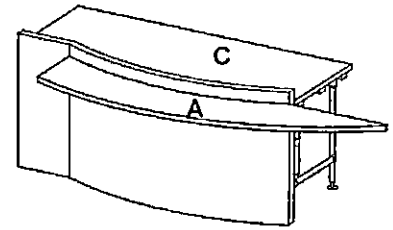

## DOUGH TABLE ACCESSORIES

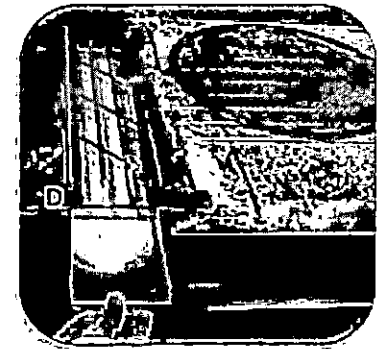
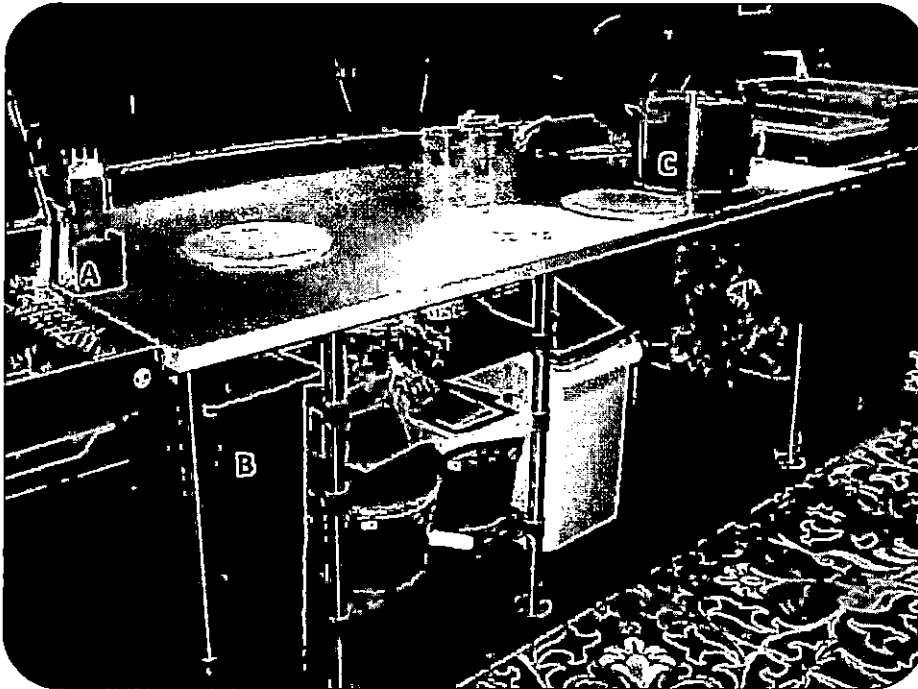

Speedrail for Squeeze Bottles	A	8351
23 gal. Slim Jim gray Garbage Can (no top)	B	7045
Stainless Sauce Bucket Shelf	C	273012
Cornmeal Catcher	D	237021

### IMPORTANT REMINDER

Check for accuracy and damages to your order at time of delivery. This is very important if you need to file freight claims.

Toll Free: 800-521-8274 • Fax 800-442-0330



## Cut - Table

7' Cut Table (84"L X 32"D X 36"H)

PC 273117

7' Overshelf

PC 273128

14 x 36 Solid Stainless Steel Box Shelf (3 required)

PC 273119

54° Super Erecta Posts (4/case)

PC 273120

Cut Table Accessory Package

PC 320825



7' CUT TABLE

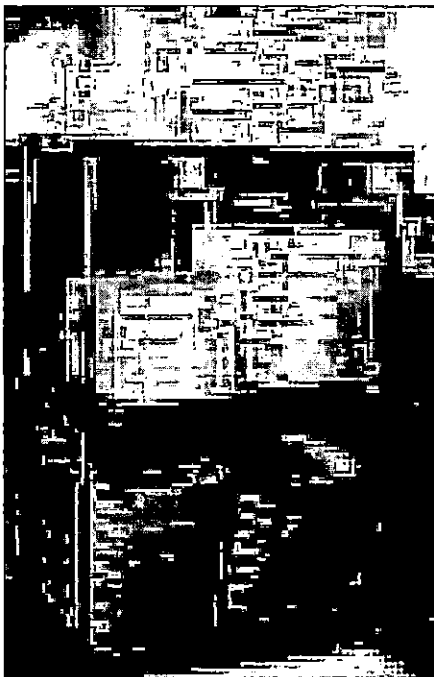

SOLID STAINLESS STEEL BOX SHELF  
(3 required - shown with 4 Posts)

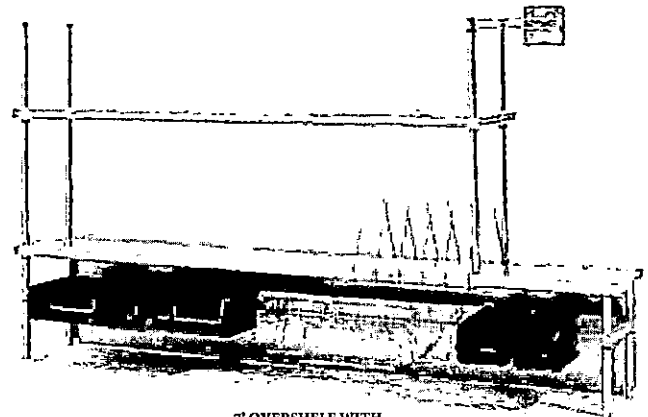

7' OVERSHELF WITH  
BOX DIVIDER TOOL RAIL  
(shown accessories sold separately)

Contact your Capital  
Equipment Project  
Consultant for  
a current copy of  
the Pizza Theater  
Catalog.

**IMPORTANT REMINDER**  
Check for accuracy and damages to your order  
at time of delivery. This is very important  
if you need to file freight claims.

**ENTRYWAY GRAPHICS**



Contact your Capital Equipment Project Consultant for a current copy of the Pizza Theater Catalog.

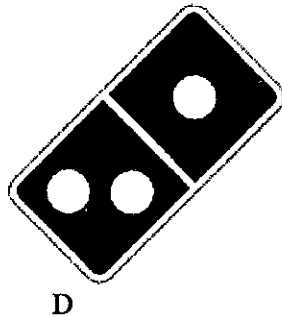
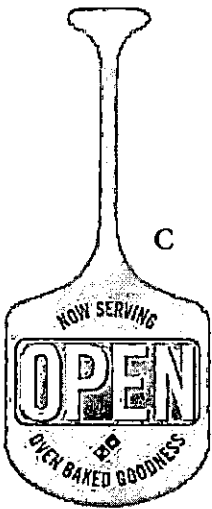

Welcome - Customer Entry Door  
 Welcome - Glass Partition Wall Vinyl  
 "Now Serving" Open Peel Sign  
 Logo Window Vinyl

A 272243  
 B 273260  
 C 318555  
 D 273259

**WALLPAPER GRAPHICS**

Wallpaper Roll #1  
 Wallpaper Roll #3

PC 273204  
 PC 273206

Wallpaper Roll #2  
 Wallpaper Roll #4

PC 273205  
 PC 273207

Wallpaper comes in 4' wide x 11' high rolls. Always order Roll #1 first. All 4 rolls are required for wallpaper to be complete.

Please ensure proper measurements before ordering. Wallpaper is non-returnable and non-refundable.

**INSTALLATION RECOMMENDATIONS**

- Prior to installation, prime the wall with a white, mold-inhibiting primer.
- Use a quality, heavy-duty, and clear pre-mixed adhesive
- Use a wallpaper brush or plastic scraper to smooth the wallpaper onto the wall
- Rolls are to be applied from left to right and top to bottom
- we strongly recommend a professional wall-paper hanger install wall-paper.

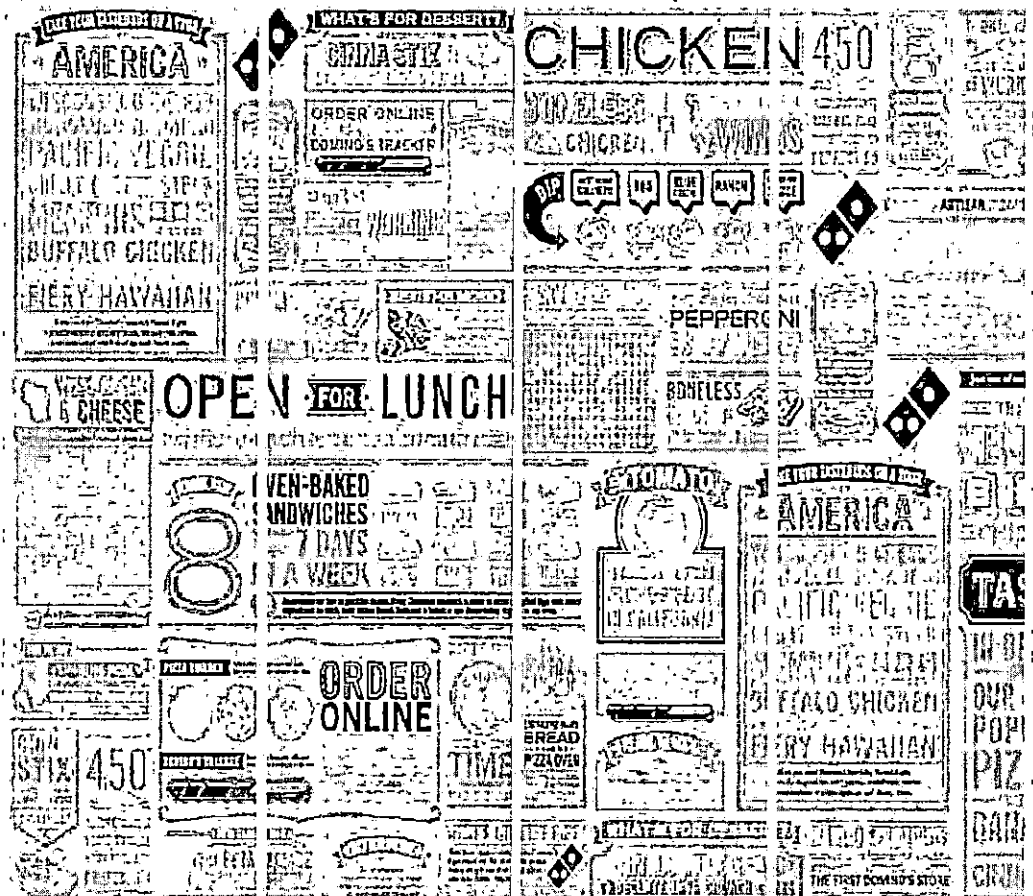

# LOBBY WALL GRAPHICS

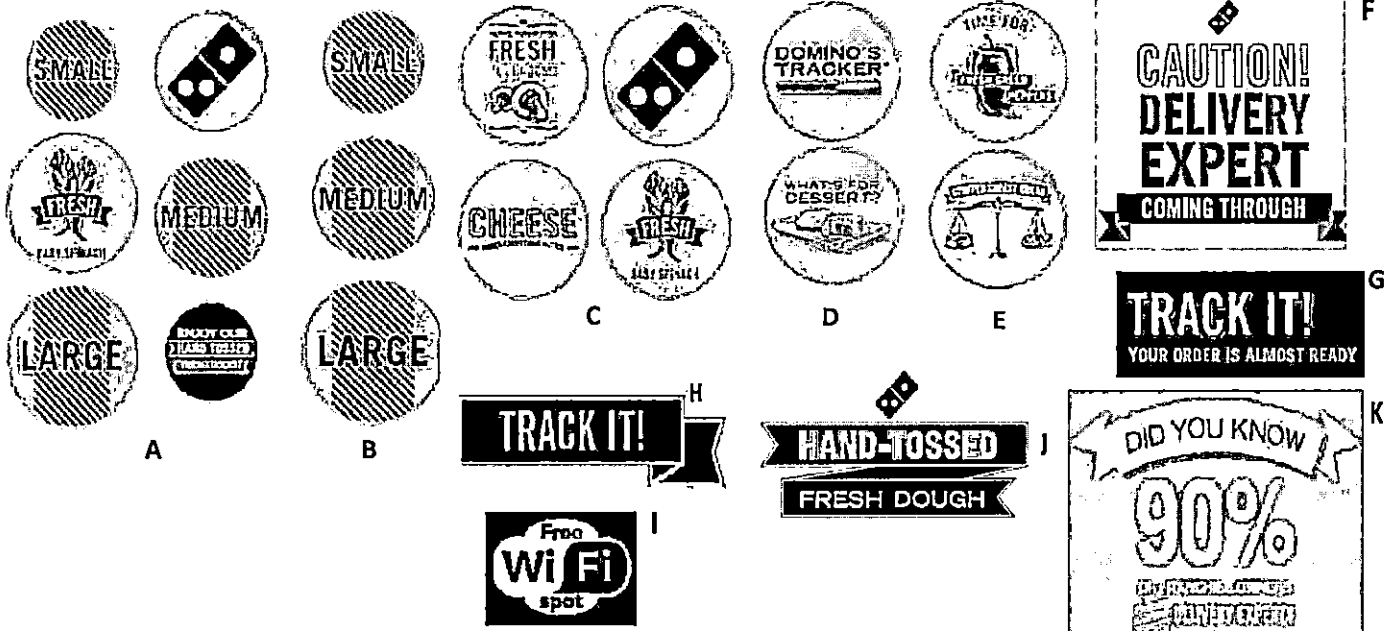

- Size pizza pan art (set of 6, to be hung close to POS counters)
- Size pizza pan art (set of 3, to be hung close to POS counters)
- Ingredient pizza pan art (set of 4)
- Tracker & Dessert Pan art (set of 2)
- Pepper and Stuffed Cheesy Bread pan art (set of 2)
- "Caution, Delivery Experts" door vinyl (used if glass separates lobby from production area)
- "Track It" vinyl (for use with order tracking monitor)
- "Track It" dimensional ribbon
- "Free WiFi" spot vinyl
- "Hand Tossed Fresh Dough" wall vinyl
- "90% of Franchisees" wall vinyl

- A PC 273210
- B PC 273254
- C PC 273211
- D PC 273250
- E PC 273251
- F PC 273217
- G PC 273214
- H PC 273215
- I PC 273216
- J PC 273224
- K PC 273253

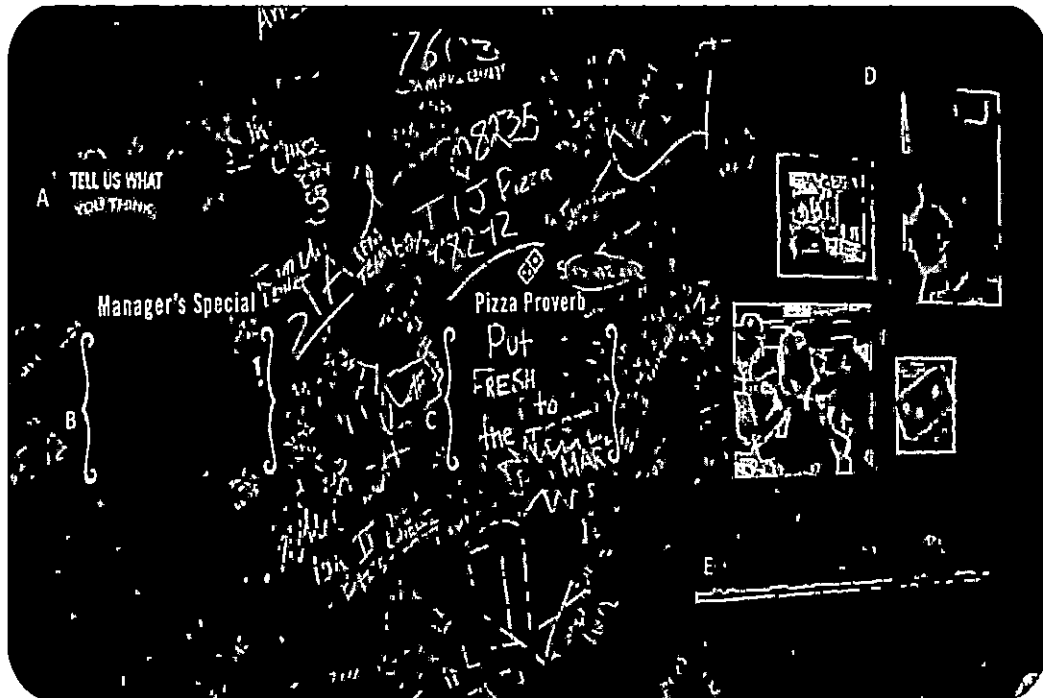

- "Tell Us What You Think" chalk wall vinyl A PC 273252
- "Manager's Special" chalk wall vinyl B PC 273209
- "Pizza Proverb" chalk wall vinyl C PC 273208
- Framed Photo Collage (set of 4) D PC 273212
- 4' Chalk Tray E PC 273027
- 2' Chalk Tray (not shown) E PC 273025

**CUSTOMER VIEWING LEDGE GRAPHICS**



**D PLEASE DO NOT FEED THE EMPLOYEES**

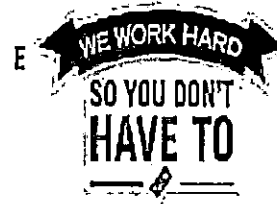

**F YOUNG PIZZA INSPECTORS STEP UP TO WATCH THE DOUGH SHOW**

- "Hand Tossed Dough" vinyl (sneeze guard in front of dough counter)
- "450 degrees is the Temp It Takes" vinyl (sneeze guard in front of makeline)
- Dimensional logo and brand statement vinyl (for red focal wall)
- "Don't Feed The Employees" vinyl (sneeze guard in front of makeline)
- "We Work Hard" vinyl (sneeze guard in front of makeline)
- "Pizza Inspector" step up vinyl

- A PC 273223
- B PC 273254
- C PC 273221 - PC 273222
- D PC 273229
- E PC 273228
- F PC 273248

**POS GRAPHICS**

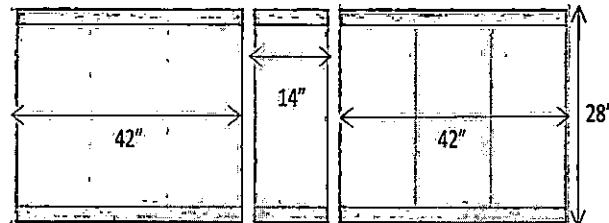
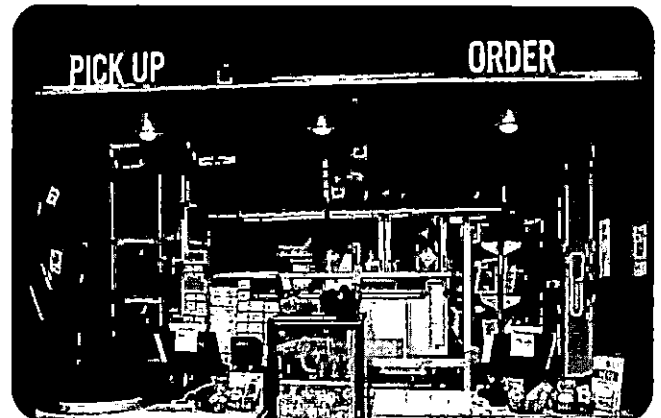
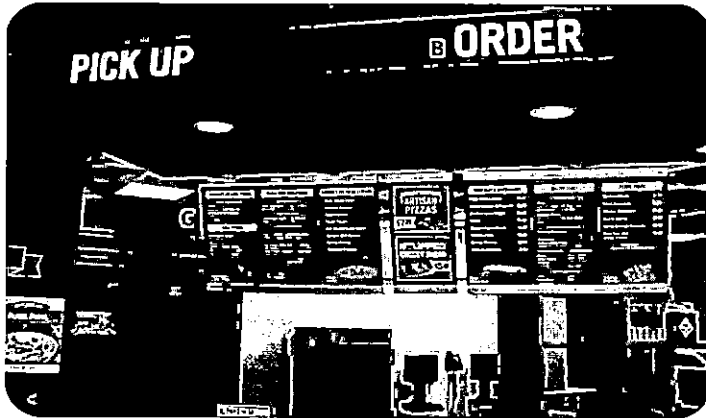

MENUBOARD DIMENSIONS

Contact your Capital Equipment Project Consultant for a current copy of the Pizza Theater Catalog.

- "Pick Up" soffit dimensional letters
- "Order" soffit dimensional letters
- 28" High Speed 3-Panel Menu Board (inserts sold separately)
- Promo Chalkboard for POS Counter
- 6' Soffit Baseline Silver Rail (only for soffits in Image 2000 Retrofits)
- "Pick Up" POS Vinyl (not shown - use on counters if no soffit available)

- A PC 273232
- B PC 273234
- C PC 273247
- D PC 273237
- E PC 273236
- PC 273231

## RESTROOM GRAPHICS and ACCESSORIES

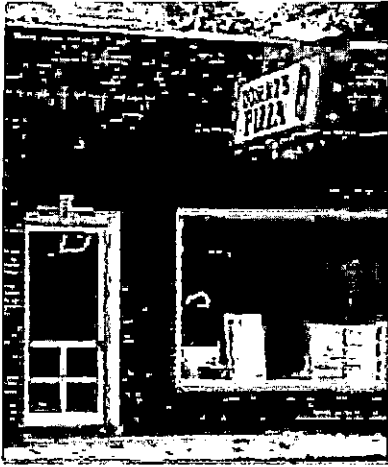

A



B



C



D



E



F

Restroom Frames Art (set of 2, one for each opposite blue wall)  
 "Keep Your Friends" sign (red wall inside restroom next to door)  
 Unisex / Handicapped Restroom Sign  
 Women's Restroom Sign  
 Men's Restroom Sign  
 "Employees Must Wash" sign (required by sink for customer restroom)  
 White 15-gallon Trash Can

A PC 273242  
 B PC 273239  
 C PC 4040  
 D PC 4041  
 E PC 4042  
 F PC 4043  
 G PC 273014

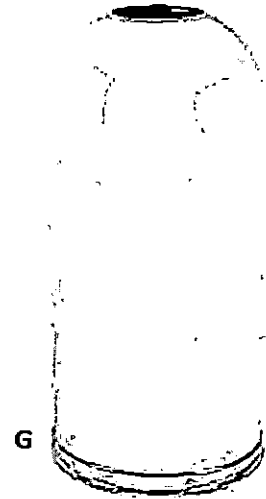

G

## STORE ACCESSORIES



A

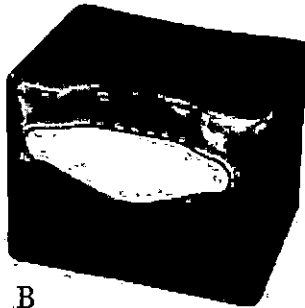

B

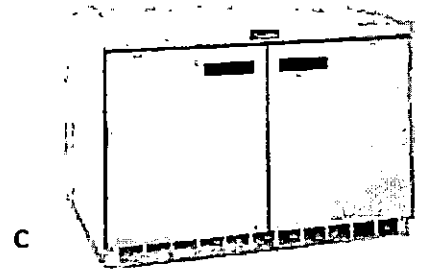

C

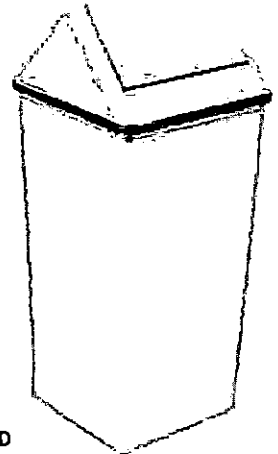

D

Concierge Apron  
 Napkin Dispenser  
 Low 48" Delfield® Reach-In  
 36 Gallon White Trash Can for Lobby  
 Metal Cash Drawer with Removable Till (not shown)  
 Metal Cash Drawer Brackets (not shown)  
 Safe - 20"H x 19"W x 22"D (not shown - due to electrical outlets and cash drawer, only the 20" high safe will fit in the POS counters)  
 3' x 5' Brown Floor Mat (not shown - single door entryway)  
 4' x 6' Brown Floor Mat (not shown - double door entryway)

A PC 141117  
 B PC 258165  
 C PC 345320  
 D PC 273013  
 PC 312661  
 PC 312666  
 PC 381811  
 PC 318037  
 PC 318038

# RACKS, DOLLIES, AND CARTS

## RACKS & CARTS

### Metal Cart

- Medium duty, Stainless Steel
- Welded construction
- Swivel casters
- ABS plastic handle
- 300-lb. capacity
- 27-1/2" W x 15-1/2" D x 32-5/8" H (overall)
- Shelves are 24" W x 15-1/2" D (12" between Shelves)

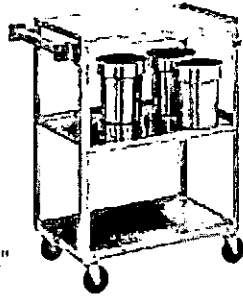

METAL CART

Metal Cart PC 203698\*

### Dough Dollies

- All-welded Steel construction with four 3" swivel casters
- 900-lb. weight-load capacity

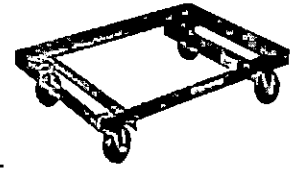

STEEL DOUGH DOLLY

Steel Dough Dolly PC 460005  
 Aluminum Dough Dolly (Not Shown) PC 3110\*  
 Blue dough dolly for International PC 460010

### Plastic Cart

- Thermoplastic Cart
- 4" swivel casters
- Won't chip, warp, crack, peel or rust
- 24" W x 18" D x 34" H (overall)
- Shelves are 24" W x 18" D



PLASTIC CART

Plastic Cart PC 460500\*

### Pan Pizza Pan Racks

- Pans slide into built-in runners
- Spaced to allow for air circulation
- Heavy-duty Aluminum, NSF® certified
- Locking swivel casters for easy relocating
- Racks are adjustable to fit 10", 12", 14" and 15" Pans

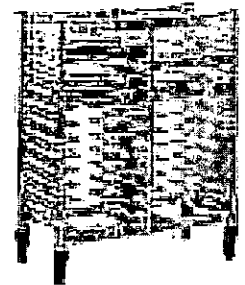

DOUBLE WIDE, SINGLE HIGH PAN RACK

Single-High, Single-Wide (SHSW) Pan Rack, 13  
 32" H x 16" W x 14" D PC 9225\*

Single-Wide, Double-High (SWDH) Pan Rack, 26  
 64" H x 16" W x 14" D PC 9226\*

Double-Wide, Single-High (DWSH) Pan Rack, 26  
 32" H x 32" W x 14" D PC 9227\*

Double-Wide, Double-High (DWDH) Pan Rack, 52  
 64" H x 32" W x 14" D PC 9228\*

Triple-Wide, Double-High (TWDH) Pan Rack, 78  
 62-1/8" H x 13-3/8" W x Adjustable Length PC 9229\*

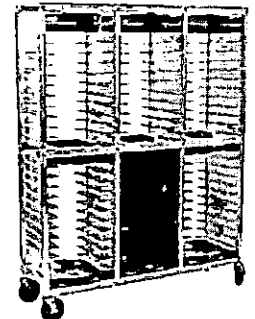

TRIPLE WIDE, DOUBLE HIGH PAN RACK

### Dunnage Racks

- Rust-free Aluminum
- NSF® certified
- 2,000-lb. capacity
- 12" height to satisfy health department requirements



DUNNAGE RACK

Rack, 24" x 36" x 12" PC 462450  
 Rack, 24" x 48" x 12" PC 462451  
 Rack, 20" x 36" x 12" PC 462452  
 Rack, 20" x 48" x 12" PC 462453

*NOTE: The RED number before the dimensions is the Deep Dish Pizza capacity.*

**IMPORTANT REMINDER**  
 Check for accuracy and damages to your order at time of delivery. This is very important if you need to file freight claims.

\* Ships directly from the manufacturer. Lead times vary. For further information, contact your Customer Satisfaction Representative.

## JANITORIAL SUPPLIES

### Broom Handles

- 60" long
- Metal handle
- Fits PC 7007, 7008 and 7001



THREADED

Threaded Handle PC 237051

- 54" long
- Wood Handle
- Fits PC 7011



TAPERED

Tapered Handle PC 7053

### Dustpans

- Hard Rubber construction
- Chip and crack resistant
- 12" wide
- 30-1/2"-long handle



DUSTPAN

Dustpan PC 7012  
Lobby Dustpan PC 237015

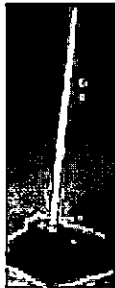

LOBBY DUSTPAN

### Oreck® Random Orbital Floor Machine/Sweeper

- Cleans carpet, wood, ceramic, vinyl, marble, concrete, brick and slate
- 13" cleaning path
- 1-year overall warranty, 5 years on motor
- Includes one scrub pad; additional brushes and pads available on a special-order basis

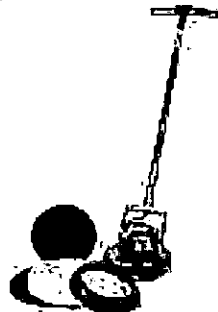

ORBITAL FLOOR MACHINE

Floor Machine 550MC PC 237061

### Squeegee

- Plastic handle
- 12" wide
- Rubber blade
- Use with Tapered Handle PC 7053

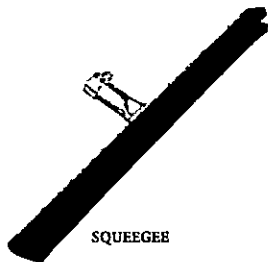

SQUEEGEE

Squeegee PC 7011

### Soap Dispensers & Soap

- Economical and easy to mount
- Required at every store

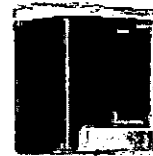

LIQUID SOAP DISPENSER



LOTION SOAP DISPENSER

Liquid-Soap Dispenser PC 244006  
Antibacterial Lotion- Soap Dispenser, White PC 244004  
Antibacterial Lotion- Soap Refills, case of 8 PC 244005

LOTION SOAP REFILLS



For Liquid Soap Refills, contact your Supply Chain Center.

### Rubbermaid® Trash Cans

- Brute® containers by Rubbermaid®
- Resistant to chemicals, rust, dents and leaks

Trash Can, White, 20-Gallon PC 7030  
Trash-Can Lid for 20-Gallon PC 7031  
Trash Can, Grey, 32-Gallon PC 7032  
Trash-Can Lid for 32-Gallon PC 7033  
Trash Can, Grey, 44-Gallon PC 7034  
Trash-Can Lid for 44-Gallon PC 7035  
Trash Can w/Lid, 45 gallon, 2 door PC 7055  
Replacement Decal 12" x 12" PC 8038N

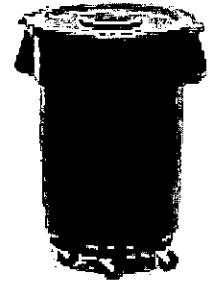

TRASH CAN (SHOWN WITH PC 7038 DOLLY)

### Trash-Can Dolly

- Five self-locking casters on the bottom
- Designed to fit our 20-, 32- or 44-Gallon Trash Cans



TRASH CAN DOLLY

Trash-Can Dolly PC 7038

**COMPUTER ACCESSORIES & CASH HANDLING**

**Monitor/Keyboard Stands**

- Stands hold Monitor with keyboard underneath
- Metal construction

PC 213712 Metal Monitor/Keyboard-  
Stand Mounting Brackets, Set of 2

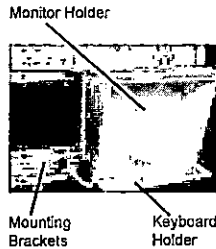

**Metal CPU Holder**

- "U"-shaped Metal Holder
- Mounted on wall or under counter

Metal CPU Holder PC 213711

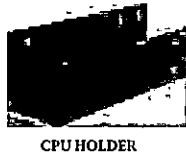

**Credit-Card Imprinter**

- Fits into driver's pocket
- Hand held
- Personalized Charge Plate available at additional cost (Up to three lines of imprint; merchant number can only be engraved at time of Credit-Card Imprinter purchase. Bank may require certain information on plate.)
- Less than 5" square
- Weighs less than 8 oz.

Manual Credit-Card Imprinter PC 288047  
Engraved Merchant Number PC 288048\*

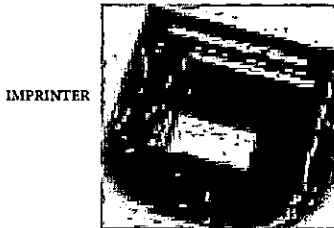

**Cash Drawer**

- Brackets must also be ordered with this item)
- Removable Drawer comes with key and lock
- Bracket sold separately
- 16-23/64" D x 19-1/2" L x 4" H (Outside)
- 15.9" W 16.7" L x 3.86" H (Inside)



Metal Cash Drawer with Removable Till PC 312661  
Brackets for Metal Cash Drawer PC 312662

**Bank Bags**

- Tamper and theft proof
- Non-imprinted and no logo

- "Driver" Bags, 5.5"x8.5" PC 8615\*  
250 per case
- 2 slot bags with logo PC 8618  
400 per case
- 8"x10" clear, no logo PC 8619  
200 per case

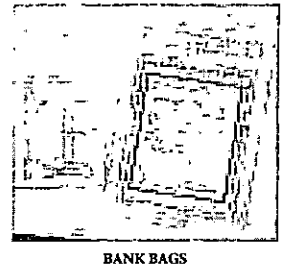

**Modular Metal Drop Box**

- Five compartments
- Comes with security bar to alleviate theft
- Mounting hardware included
- 23" H x 7" W x 7" D



Modular Drop Box PC 8610A

MODULAR DROP BOX  
Shown above (right) are three units attached together

**16-Compartment Locker**

- Heavy, 16-gauge Steel
- Grey
- Lockers accept standard padlock
- Built-in coat bar
- Stands alone or mounts together
- 72" W x 18" D x 78" H (Overall)
- 12" W x 18" D x 12" H (Individual Lockers)

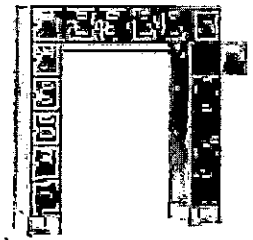

16-Compartment Locker PC 26610\*

For PULSE  
printer receipt paper  
and printer stands,  
contact your PULSE  
representative at  
800-546-2993 or  
734-930-3702.

**IMPORTANT REMINDER**  
Check for accuracy and damages to your order  
at time of delivery. This is very important  
if you need to file freight claims.

Toll Free: 800-521-8274 • Fax 800-442-0330

\* Ships directly from the manufacturer. Lead times vary. For further information,  
contact your Customer Satisfaction Representative.