

PHOTOVOLTAIC ROOF MOUNT SYSTEM

CODE AND STANDARDS

THE INSTALLATION OF SOLAR ARRAYS AND PHOTOVOLTAIC POWER SYSTEMS SHALL COMPLY WITH THE FOLLOWING CODES:

- 2020 NATIONAL ELECTRICAL CODE
- 2018 NORTH CAROLINA RESIDENTIAL CODE
- 2018 NORTH CAROLINA BUILDING CODE
- ALL OTHER ORDINANCE ADOPTED BY THE LOCAL GOVERNING AGENCIES



SITE NOTES / OSHA REGULATION

1. A LADDER SHALL BE IN PLACE FOR INSPECTION IN COMPLIANCE WITH OSHA REGULATIONS.
2. THE SOLAR PV INSTALLATION SHALL NOT OBSTRUCT ANY PLUMBING, MECHANICAL, OR BUILDING ROOF VENTS.
3. ROOFTOP MOUNTED PHOTOVOLTAIC PANELS AND MODULES SHALL BE TESTED, LISTED AND IDENTIFIED BY RECOGNIZED ELECTRICAL TESTING LABORATORY.
4. MODULES AND SUPPORT STRUCTURES SHALL BE GROUNDED
5. SOLAR INVERTER SHALL BE LISTED TO UL1741
6. ALL CONDUCTORS SHALL BE COPPER AND SHOULD BE 75 AND 90 DEG RATED
7. REMOVAL OF AN INTERACTIVE INVERTER OR OTHER EQUIPMENT SHALL NOT DISCONNECT THE BONDING CONNECTION BETWEEN THE GROUNDING ELECTRODE CONDUCTOR, THE PHOTOVOLTAIC SOURCE AND OUTPUT CIRCUIT GROUNDED CONDUCTORS.
8. LIVE PARTS OF PV SOURCE CIRCUITS AND PV OUTPUT CIRCUITS OVER 150V TO GROUND SHALL NOT BE ACCESSIBLE TO OTHER THAN QUALIFIED PERSONS WHILE ENERGIZED.
9. ALL PV MODULES AND ASSOCIATED EQUIPMENT AND WIRING SHALL BE PROTECTED FROM PHYSICAL DAMAGE.

SOLAR CONTRACTOR

1. MODULE CERTIFICATIONS INCLUDE UL1703, IEC61646, IEC61370.
2. IF APPLICABLE, MODULE GROUNDING LUGS MUST BE INSTALLED AT THE MARKED GROUNDING LUG HOLES PER THE MANUFACTURERS INSTALLATION REQUIREMENTS.
3. AS INDICATED BY DESIGN, OTHER NRTL LISTED MODULE GROUNDING DEVICES MAY BE USED IN PLACE OF STANDARD GROUNDING LUGS AS SHOWN IN MANUFACTURER DOCUMENTATION AND APPROVED BY THE AHJ.
4. ALL MICROINVERTERS, PHOTOVOLTAIC MODULES, AC COMBINERS, DC-AC CONVERTERS AND SOURCE CIRCUIT COMBINERS INTENDED FOR USE IN A PHOTOVOLTAIC POWER SYSTEM WILL BE IDENTIFIED AND LISTED FOR THE APPLICATION PER NEC690.4(B).
5. ALL SIGNAGE TO BE INSTALLED IN ACCORDANCE WITH LOCAL BUILDING CODE.
6. TERMINALS AND LUGS WILL BE TIGHTENED TO MANUFACTURER TORQUE SPECIFICATIONS (WHEN PROVIDED) IN ACCORDANCE WITH NEC CODE 110.14(D) ON ALL ELECTRICAL CONNECTIONS.
7. MAX DC VOLTAGE CALCULATED USING MANUFACTURER PROVIDED TEMP COEFFICIENT FOR VOC UNLESS NOT AVAILABLE.

DESIGN CRITERIA
 WIND SPEED: 120 MPH
 GROUND SNOW LOAD: 10 PSF
 WIND EXPOSURE FACTOR: B

UTILITY COMPANY:
CEMC

PERMIT ISSUER (AHJ):
HARNETT COUNTY

SCOPE OF WORK
 INSTALLATION OF UTILITY INTERACTIVE PHOTOVOLTAIC SOLAR SYSTEM.

SR.#	PROJECT INFORMATION	
1	PV MODULES	40 x REC460AA Pure-RX
2	INVERTER	40 x IQ8X-80-M-US
3	BATTERY	03 X IQ5P ENPHASE
4	ROOF TYPE	ASPHALT SHINGLES
5	RACKING	PSR-B84 RAILS (BLACK)
6	MOUNTING TYPE	COMP MOUNT FLASHING (BLACK)
7	DC SIZE	18.4 KW
8	AC SIZE	15.2 KVA
SR.#	PROJECT INFORMATION	
1	PV1	DRAWING INDEX
2	PV2	SITE LAYOUT
3	PV3	STRING MAPPING
4	PV4	ELECTRICAL ONE LINE DIAGRAM
5	PV5	DETAILED ELECTRICAL WIRING SCHEMATIC
6	PV6	PV LABELS
7	PV7	BILL OF MATERIALS
8	PV8	ATTACHMENT DETAILS

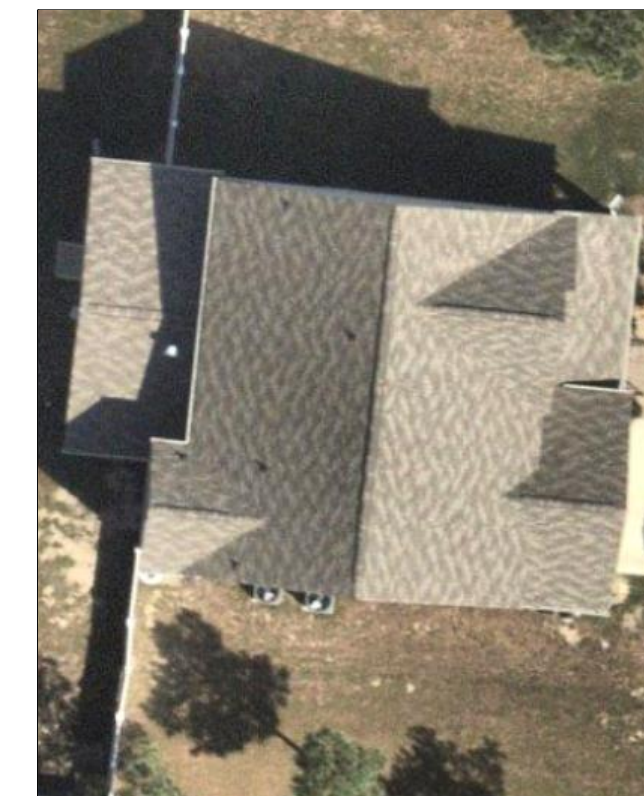

VICINITY MAP

TOP VIEW OF THE BUILDING



5112 Departure Drive,
 Raleigh NC 27616
 O: 919.948.6474
 E: info@8msolar.com

Customer Information:

Bonnes John
 97 Sunnybrook Lane
 Lillington, NC 27546

Customer Signature:

Sheet Name:

Drawing Index

JOB NUMBER:

24-762-JB

Date:

12/17/2024

Revision:

A

Sheet Size:

ANSI C
 17" X 22"

Sheet Number:

PV1



ROOF DESCRIPTION			
ROOF	PITCH	AZIMUTH	NO. OF MODULES
A	33°	96°	20
B	33°	276°	20
Vent		<ul style="list-style-type: none"> Roof A has no vents No vents will be covered by PV modules during the installation 	

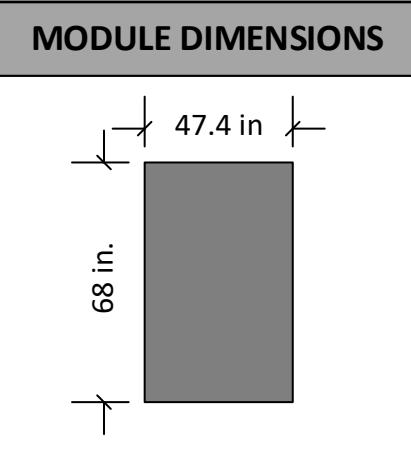

PV System Dead Load (Panel + Racking weight) / PV System Area (No. of panels x Weight of panel (lbs.) + Length of racking (ft.) x 1.15 lb.ft) / (No. of panels x Height x Width) = Total psf			
ROOF	A	B	
DEAD LOAD (PSF)	2.69	2.68	

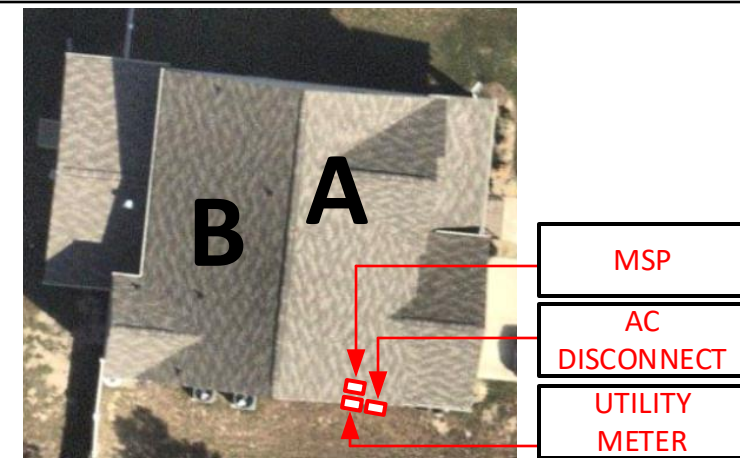

5112 Departure Drive,
Raleigh NC 27616
O: 919.948.6474
E: info@8msolar.com

SYSTEM DETAILS
 NUMBER OF PANELS : 40
 PANELS MODEL : REC460AA PURE-RX
 DC SIZE : 18.4 KW
 AC SIZE : 15.2 KVA

Customer Information:

Bonnes John
 97 Sunnybrook Lane
 Lillington, NC 27546

Customer Signature:

Sheet Name:

Site Layout

JOB NUMBER:

24-762-JB

Date:

12/17/2024

Revision:

A

Sheet Size:

ANSI C
17" X 22"

Sheet Number:

PV2

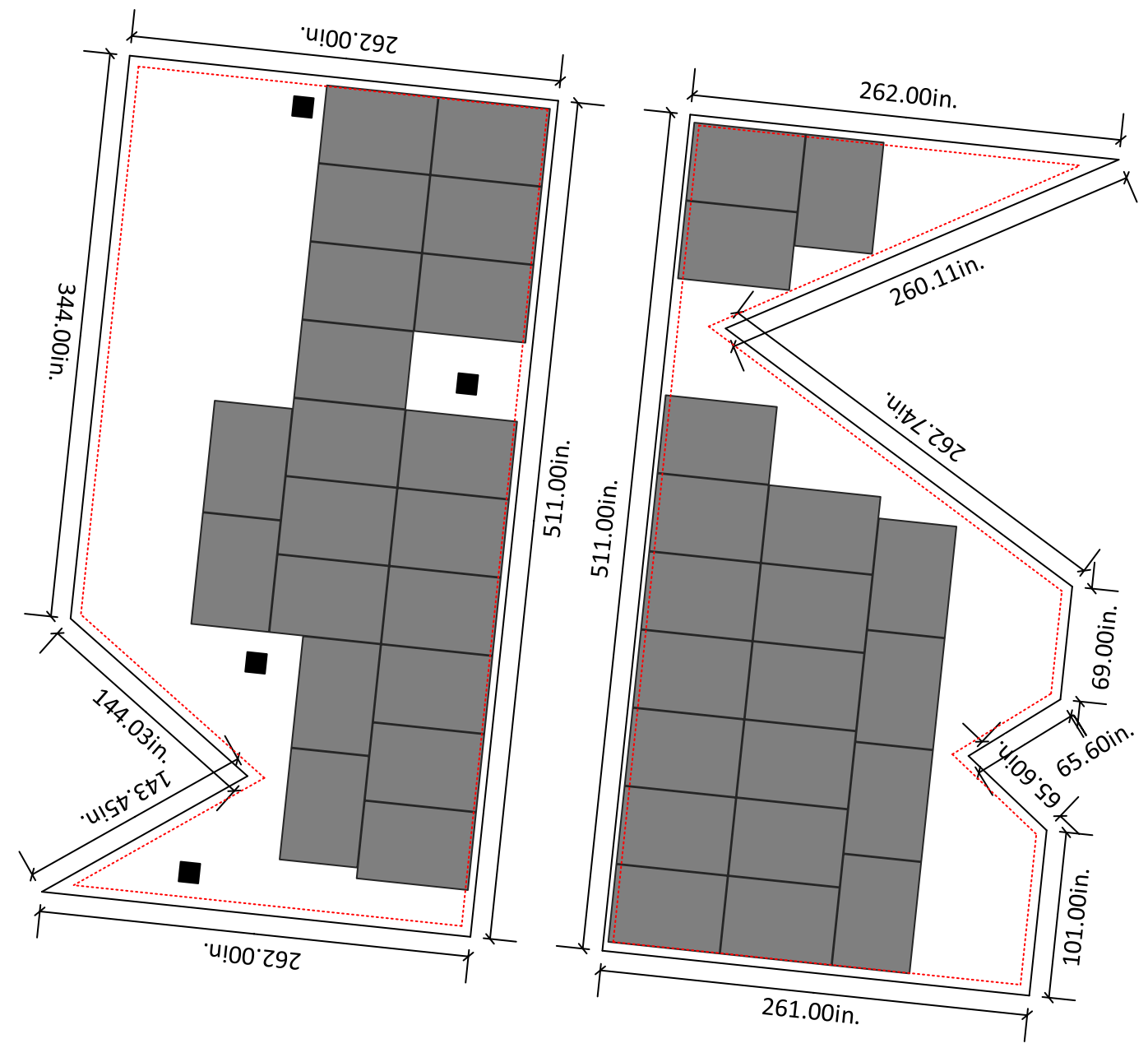

Roof B
20 Modules

Roof A
20 Modules

6in setback from
sides of the roof

SITE LAYOUT
SCALE: 1/8" - 1'

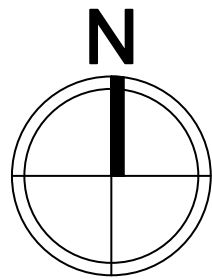

ROOF DESCRIPTION				MODULE DIMENSIONS	STRING LAYOUT					
ROOF	PITCH	AZIMUTH	NO. OF MODULES		ENPHASE IQ COMBINER 5C					
A	33°	96°	20		Strings #	No. of Modules	Color	Strings #	No. of Modules	Color
B	33°	276°	20		String 1	10	Blue	String 4	10	Green
					String 2	10	Orange			Purple
					String 3	10	Yellow			Light Blue

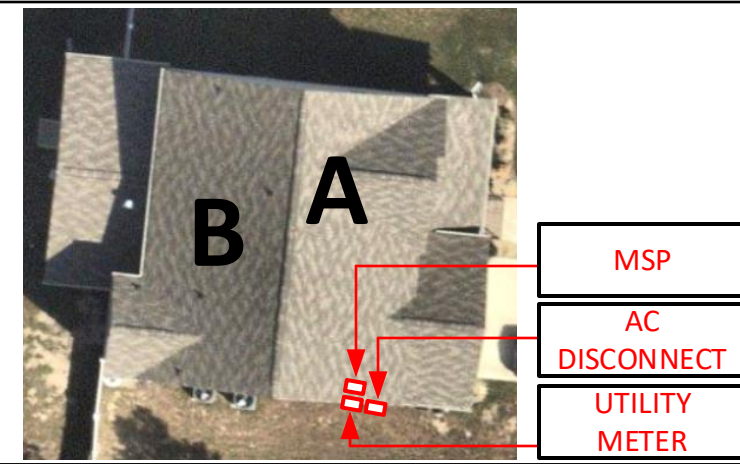

5112 Departure Drive,
Raleigh NC 27616
O: 919.948.6474
E: info@8msolar.com

SYSTEM DETAILS

NUMBER OF PANELS : 40
PANELS MODEL : REC460AA PURE-RX
DC SIZE : 18.4 KW
AC SIZE : 15.2 KVA

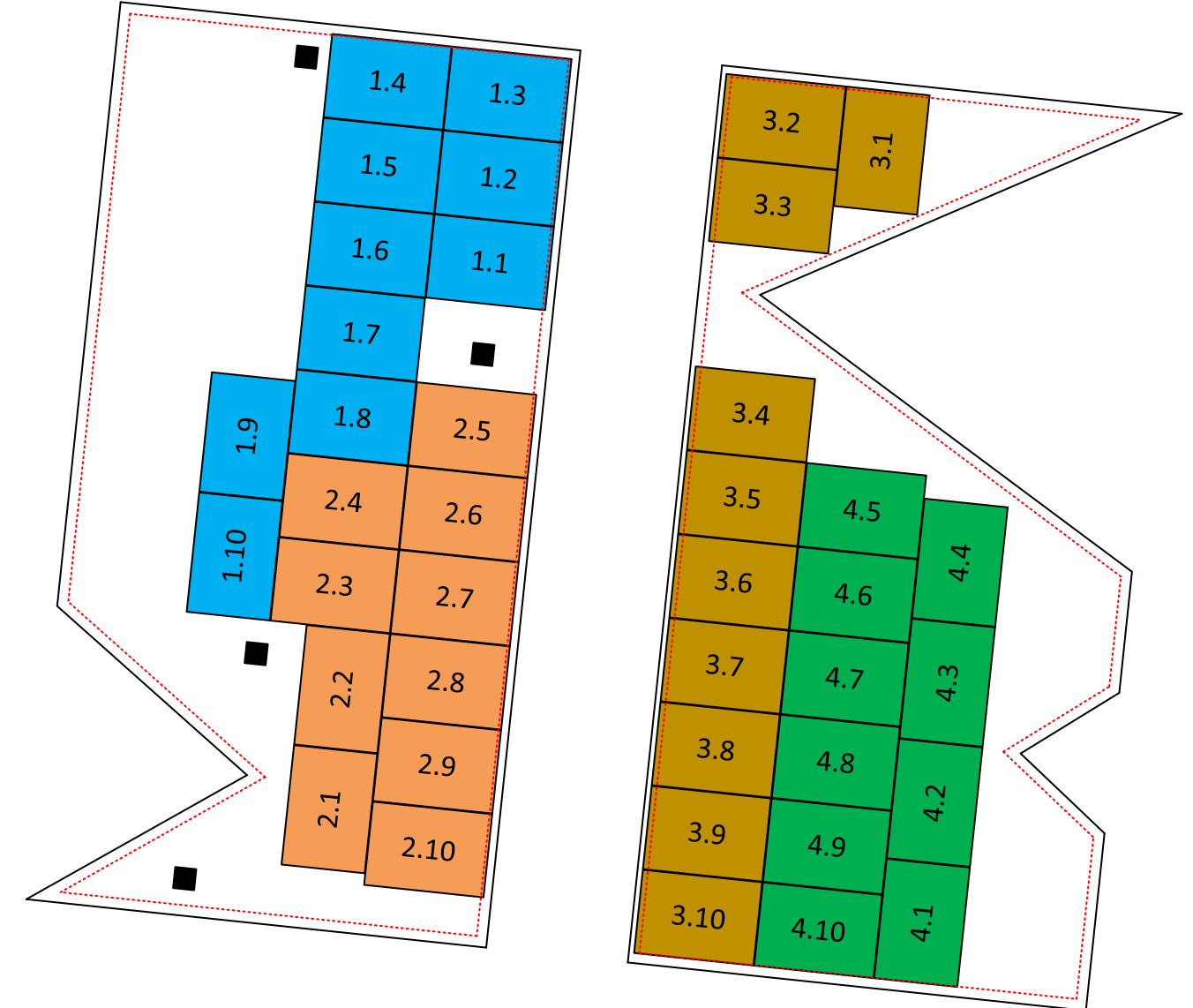

Roof B
20 Modules

Roof A
20 Modules

Customer Information:

Bonnes John
97 Sunnybrook Lane
Lillington, NC 27546

Customer Signature:

Sheet Name:

String Mapping

JOB NUMBER:

24-762-JB

Date:

12/17/2024

Revision:

A

Sheet Size:

ANSI C
17" X 22"

Sheet Number:

PV3

6in setback from
sides of the roof

STRING MAPPING
SCALE: 1/8" - 1'

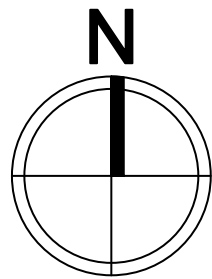

STRING CALCULATION

String #	No of Modules	Estimated Power	I _{max}	V _{oc}	V _{mpp}	V _{rise} (<= 2%)
1,2,3,4	10	4,600 W	19.75 AC	<30	240V AC	1.07+0.62 = 1.69

NEC Code (2020) and UL Standard References

Rapid Shut Down	NEC 690.12 (A-D), UL1741	Grounding	NEC Article 250.30(A)
Disconnecting Means	NEC 690.13	Conduit Fill	NEC Table C.9, 310.15(B)(3)(a)
Feeder Sizing	NEC Table 310, 15(B)(16, 17)	Interconnection	NEC 705.12
Over current Protection	NEC 690.9		



5112 Departure Drive,
Raleigh NC 27616
O: 919.948.6474
E: info@8msolar.com

40 X REC460AA PURE-RX
460W
ENPHASE IQ8X-80-M-US MICROINVERTERS
380VA
RAPID SHUTDOWN EQUIPPED

Service Side Work: Power Drop Required

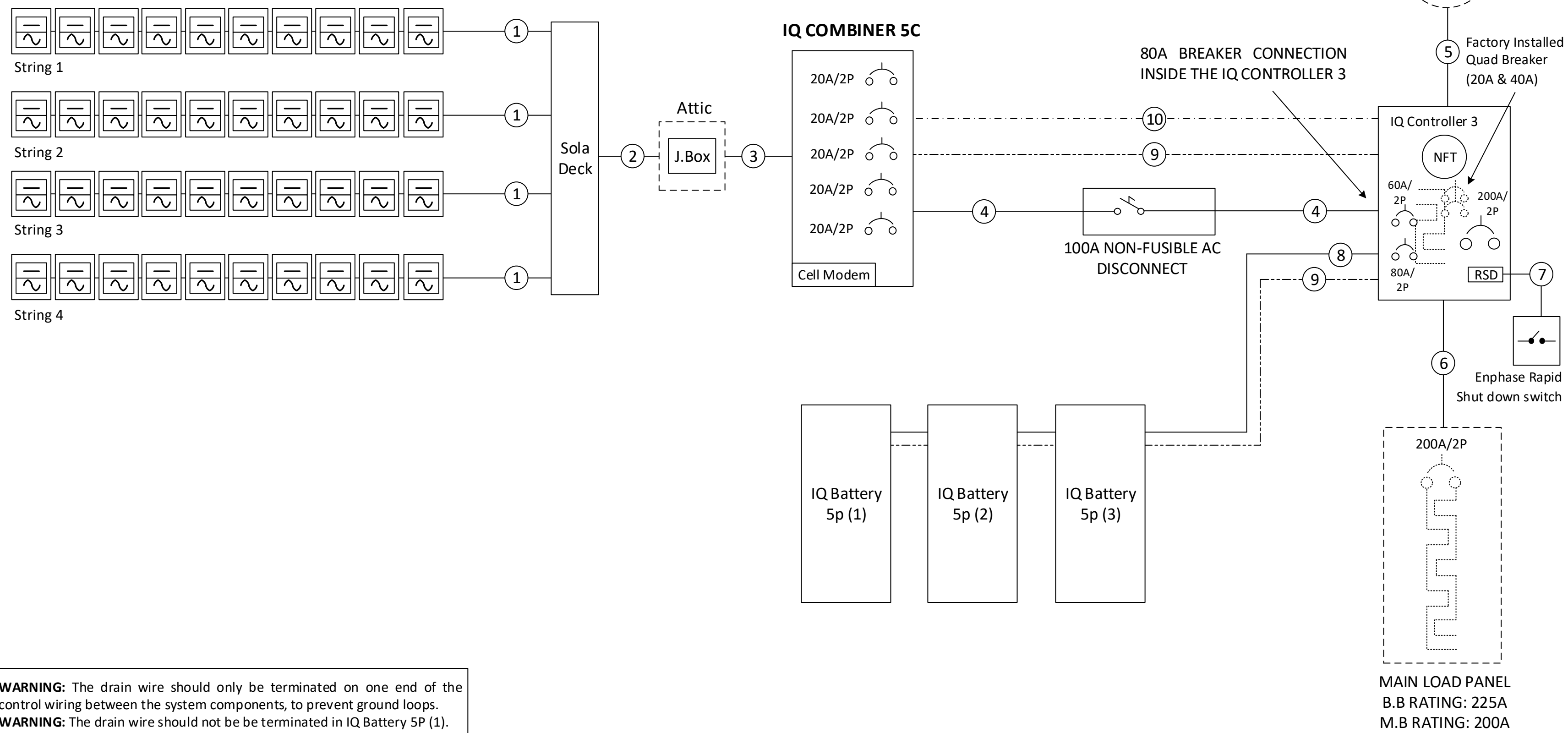

Customer Information:

Bonnes John
97 Sunnybrook Lane
Lillington, NC 27546

Customer Signature:

Sheet Name:

Electrical One Line Diagram

JOB NUMBER:

24-762-JB

Date:

12/17/2024

Revision:

A

Sheet Size:

ANSI C
17" X 22"

Sheet Number:

PV4

WARNING: The drain wire should only be terminated on one end of the control wiring between the system components, to prevent ground loops.
WARNING: The drain wire should not be terminated in IQ Battery 5P (1).

- System Size: 18,400W DC
- Battery Total Energy: 15.0 kWh
- (40) REC460AA Pure-RX
- (40) ENPHASE IQ8X-80-M-US MICROINVERTERS
- 03 x IQBATTERY-5P-1P-NA: IQ Battery 5P
- Inverter Output: 1.58A max @ 240 VAC (each microinverter)
- 380 VA AC output max (each micro inverter)
- 15.2 kVA AC output max

- Grounding will be done via Pegasus grounding lugs and mid-clamps to ensure the rail and panels are continuously grounded.
- Rapid Shutdown is included in the Mid Circuit Interrupter, refer to Mid Circuit Interrupter and Inverter attached datasheets.
- The load center/disconnect will be visible, lockable, accessible to utility linesmen, and properly labeled per NEC requirements. It will be located on the exterior wall next to the utility meter.
- Prepare cable in usual manner.
- Stretch tape and apply half-lapped to form void-free joint. Degree of stretch is not critical and may vary in different sections of joint to accomplish void-free application.
- Protect the joint with two half-lapped layers of any scotch vinyl plastic electrical tape.

Sr.No	#Wire	Conduit Size	Ground Wire	Amperage
1	1 x #12 Q Cable		#10 Bare Cu	20
2	4 x #10 MC Cable			20
3	8 x #10 THHN Cu	3/4" EMT	#10 Green Cu	20
4	3 x #4 THHN Cu	3/4" EMT	#6 Green Cu	80
5	3 x #3/0 THHN Cu	2" PVC		200
6	3 x #3/0 THHN Cu	2" PVC	#6 Green Cu	200
7	4 x #12 THHN Cu	3/4" EMT	#10 Green Cu	16
8	2 x #6 THHN Cu	3/4" EMT	#8 Green Cu	60
9	Enphase Control Cable (4 conductors)			
10	Lead Wire 18AWG, PVC Extruded			



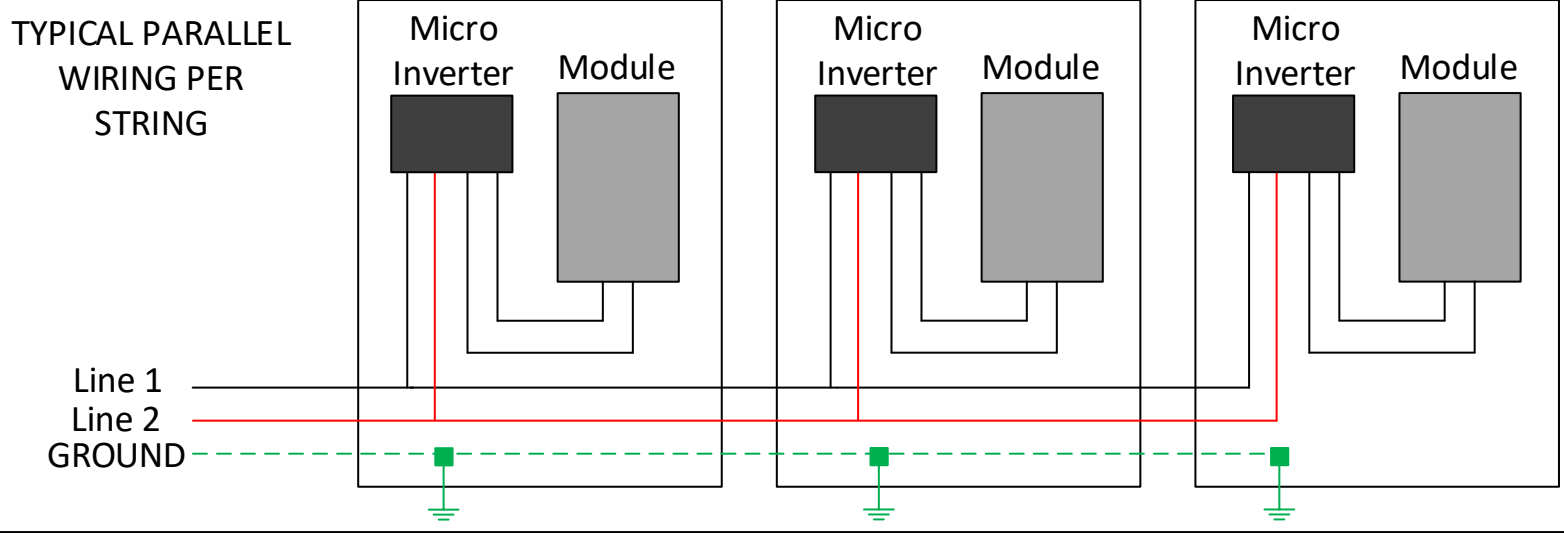

Note: Connect both grounding rods in a series connections with a bare copper keeping the minimum distance of 6ft between them

Note: Do not plug in both positive (B1) and negative (B2) battery DC circuit connectors before and during the electrical work on batteries.

Line 1		Note: 15A breaker from IQ Gateway will be removed and envoy will be wired to the 20Amp Quad breaker on IQ System Controller 3.
Line 2		
Neutral		Note: Ground and neutral should be bound in the IQ Controller 3.
Ground		Note: Loads more than 48A will be non-backed up by Enphase IQ 5P Batteries and will be managed manually.
CT Wire		

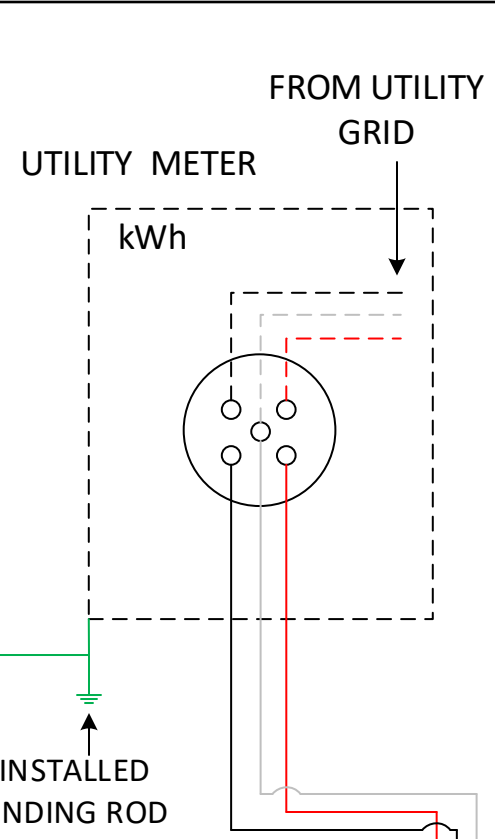

5112 Departure Drive,
Raleigh NC 27616
O: 919.948.6474
E: info@8msolar.com

Customer Information:

Bonnes John
97 Sunnybrook Lane
Lillington, NC 27546

Customer Signature:

Sheet Name:

Detailed Electrical Diagram

JOB NUMBER:

24-762-JB

Date:

12/17/2024

Revision:

A

Sheet Size:

ANSI C
17" X 22"

Sheet Number:

PV5

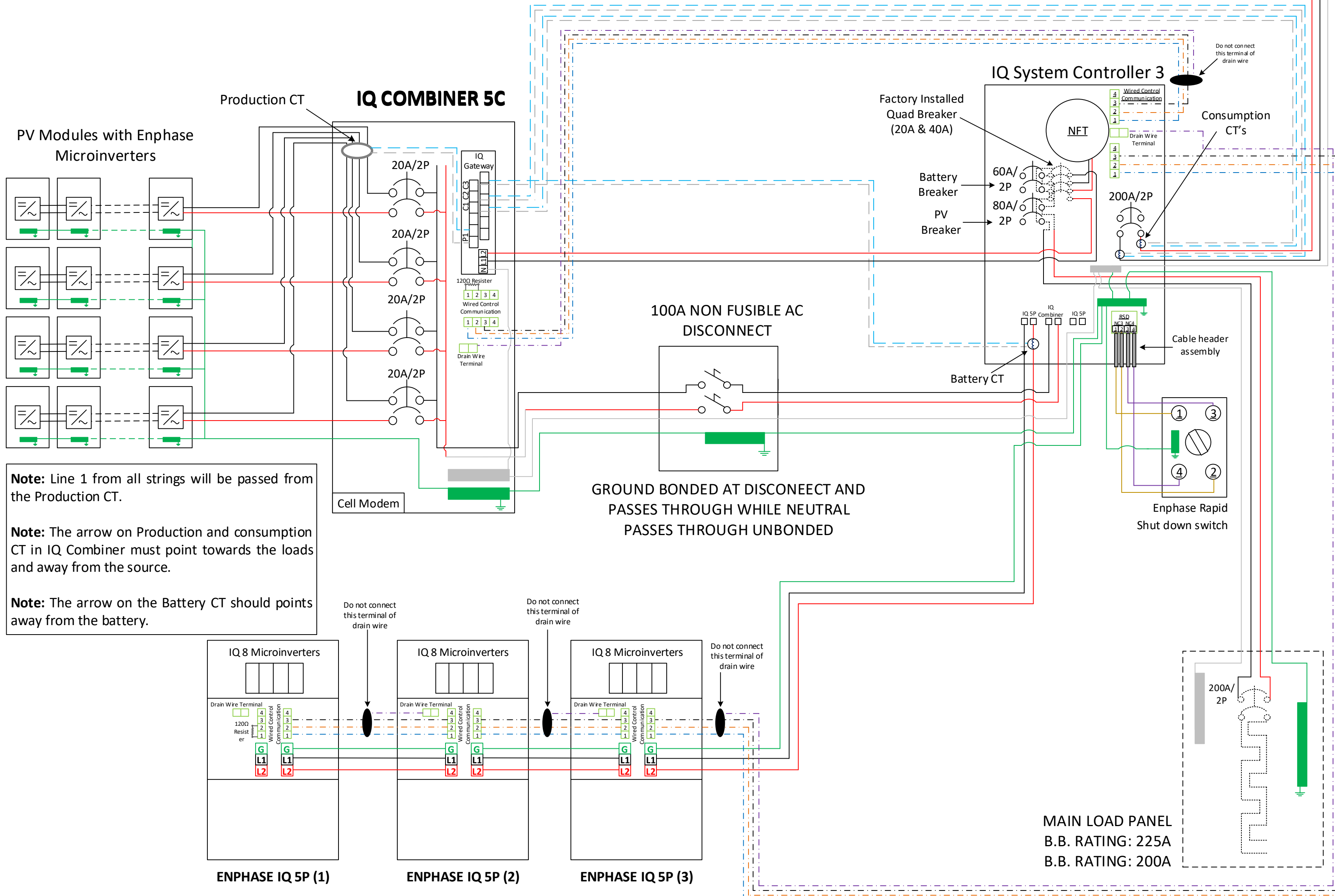

Note: Line 1 from all strings will be passed from the Production CT.

Note: The arrow on Production and consumption CT in IQ Combiner must point towards the loads and away from the source.

Note: The arrow on the Battery CT should points away from the battery.



MAIN LOAD PANEL
B.B. RATING: 225A
B.B. RATING: 200A

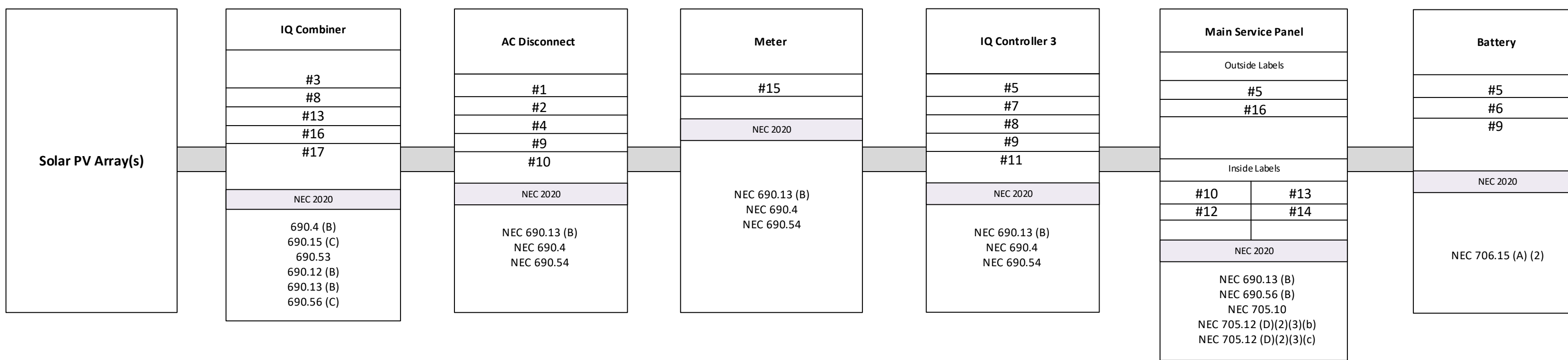

5112 Departure Drive,
 Raleigh NC 27616
 O: 919.948.6474
 E: info@8msolar.com

LABELING AND WARNING SIGNS: NEC 2020

A. PURPOSE

PROVIDE EMERGENCY RESPONDERS WITH APPROPRIATE WARNING AND GUIDANCE WITH RESPECT TO ISOLATING THE SOLAR ELECTRIC SYSTEM. THIS CAN FACILITATE IDENTIFYING ENERGIZED ELECTRICAL LINES THAT CONNECT THE SOLAR PANELS TO THE INVERTER, AS SHOULD NOT BE CUT WHEN VENTING FOR SMOKE REMOVAL.

B. MAIN SERVICE DISCONNECT:

1. RESIDENTIAL BUILDINGS- THE MARKING MAY BE PLACED WITHIN THE MAIN SERVICE DISCONNECT. THE MARKING SHALL BE PLACED ON THE OUTSIDE COVER IF THE MAIN SERVICE DISCONNECT IS OPERABLE WITH THE SERVICE PANEL CLOSED.

2. COMMERCIAL BUILDINGS- THE MARKINGS SHALL BE PLACED ADJACENT TO THE MAIN SERVICE DISCONNECT CLEARLY VISIBLE FROM THE LOCATION WHERE THE LEVER IS OPERATED

3. MARKINGS, VERBIAGE, FORMAT AND TYPE OF MATERIAL

- a. VERBIAGE: CAUTION; SOLAR ELECTRIC SYSTEM CONNECTED
 b. FORMAT:

- (1) WHITE LETTERING ON A RED BACKGROUND
 (2) MINIMUM 3/8 INCH LETTER HEIGHT
 (3) ALL LETTERS SHALL BE CAPITALIZED
 (4) ARIAL OR SIMILAR FONT, NON-BOLD

c. MATERIAL:

- (1) REFLECTIVE, WEATHER RESISTANT MATERIAL SUITABLE FOR THE ENVIRONMENT (USE UL-969) AS STANDARD FOR WEATHER RATING); DURABLE ADHESIVE MATERIALS MEET THIS REQUIREMENT.

C. MARKING REQUIREMENTS ON CONDUIT, RACEWAYS, ENCLOSURES, CABLE ASSEMBLIES, COMBINERS AND JUNCTION BOXES;

1. MARKING: PLACEMENT, VERBIAGE, FORMAT AND TYPE OF MATERIAL.

- a. PLACEMENT: MARKINGS SHALL BE PLACED EVERY 10 (TEN) FEET ON ALL INTERIOR AND EXTERIOR DC CONDUITS, RACEWAYS, ENCLOSURES AND CABLE ASSEMBLIES, AT TURNS ABOVE AND/OR BELOW PENETRATIONS, ALL COMBINERS AND JUNCTION BOXES.
 b. VERBIAGE: CAUTION SOLAR CIRCUIT
 c. THE FORMAT AND TYPE OF MATERIAL SHALL ADHERE TO SECTION B-3.B & C ABOVE

D. INVERTERS ARE NOT REQUIRED TO HAVE CAUTION MARKINGS

#1 PHOTOVOLTAIC
 AC DISCONNECT

#6 BATTERY

#12 WARNING
 TURN OFF PHOTOVOLTAIC AC DISCONNECT PRIOR TO WORKING INSIDE PANEL

#2 RAPID SHUTDOWN SWITCH FOR SOLAR PV SYSTEM

#7 MAIN BATTERY SYSTEM DISCONNECT

#13 WARNING
 ELECTRIC SHOCK HAZARD
 TERMINAL ON THE LINE AND LOAD SIDES MAY BE ENERGIZED IN THE OPEN POSITION

#3 PHOTOVOLTAIC POWER SOURCE
 OPERATING AC VOLTAGE 240 V
 MAXIMUM OPERATING AC OUTPUT CURRENT 63.2 A

#8 WARNING
 THREE POWER SOURCES
 SOURCES: UTILITY GRID, BATTERY AND PV SOLAR ELECTRIC SYSTEM

#14 WARNING
 POWER SOURCE OUTPUT CONNECTION DO NOT RELOCATE THIS OVERCURRENT DEVICE

#9 SERVICE DISCONNECT LOCATED IN THE IQ CONTROLLER 3

#15 WARNING
 THIS SERVICE METER IS ALSO SERVED BY A PHOTOVOLTAIC SYSTEM

#4 AC DISCONNECT PHOTOVOLTAIC SYSTEM POWER SOURCE
 RATED AC OUTPUT CURRENT 63.2 AMPS
 NOMINAL OPERATING AC VOLTAGE 240 VOLTS

#10 BATTERY DISCONNECT LOCATED IN THE IQ CONTROLLER 3

#16 SOLAR PV SYSTEM EQUIPPED WITH RAPID SHUTDOWN
 TURN RAPID SHUTDOWN SWITCH TO THE "OFF" POSITION TO SHUT DOWN PV SYSTEM AND REDUCE SHOCK HAZARD IN THE ARRAY

#5 SOLAR AC DISCONNECT LOCATED AT SOUTH SIDE WALL OF THE HOUSE BESIDE THE UTILITY METER

#11 WARNING
 SOLAR ELECTRIC CIRCUIT BREAKER IS BACKFEED

#17 PHOTOVOLTAIC SYSTEM COMBINER PANEL DO NOT ADD LOADS

Customer Information:

Bonnes John

97 Sunnybrook Lane
 Lillington, NC 27546

Customer Signature:

Sheet Name:

PV Labels

JOB NUMBER:

24-762-JB

Date:

12/17/2024

Revision:

A

Sheet Size:

ANSI C
 17" X 22"

Sheet Number:

PV6



ROOF DESCRIPTION			
ROOF	PITCH	AZIMUTH	NO. OF MODULES
A	33°	96°	20
B	33°	276°	20

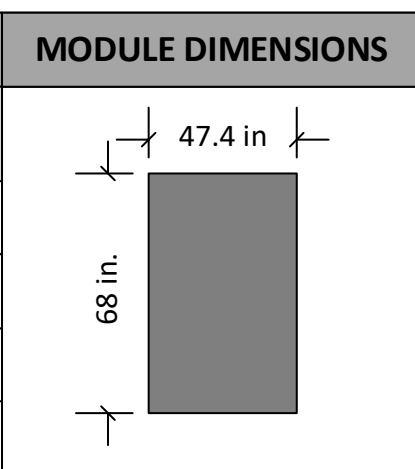

Rails and Splices : PSR-B84 (BLACK)	Roof Attachment : Pegasus Comp Mount
Rafter Spacing : 24 in	There is one layer of shingles Roofing material is asphalt shingles
Attachment Span: 4ft	The roof is located in 120mph wind zone

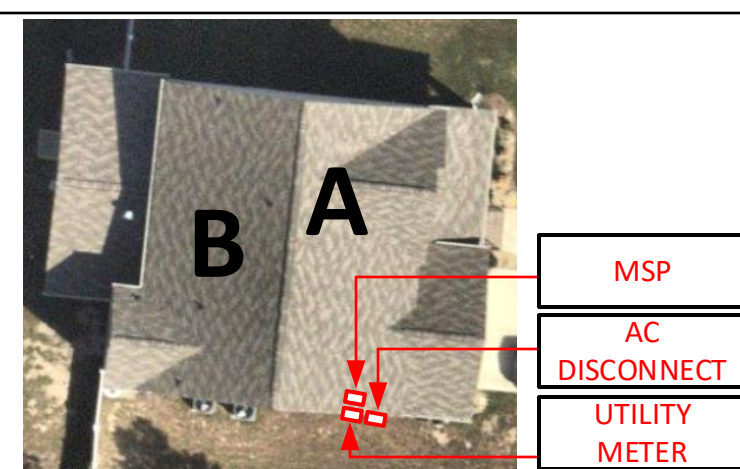

5112 Departure Drive,
Raleigh NC 27616
O: 919.948.6474
E: info@8msolar.com

PV LABELS		
Sr No	Code	Qty
01	03-302	01
02	02-316	01
03	03-390	01
04	03-306	01
05	8M-001	05
06	03-395	03
07	03-304	01
08	03-230	02
09	8M-002	05
10	8M-004	02
11	05-342	01
12	05-372	01
13	05-215	02
14	05-216	01
15	07-359	01
16	07-111	02
17	03-355	01

- RAILS AND MOUNTING SYSTEM**
- 62 x PSR-B84: Pegasus Rail, Black, 84" (7 Feet)
 - 42 x PSR-SPLS: Pegasus - Bonded, Structural Splice
 - 60 x PSR-MCB: Pegasus - Multiclamp, Mid/End, 30 to 40 mm, Black
 - 40 x PSR-HEC: Pegasus - Hidden End Clamp
 - 40 x PSR-MLP: Pegasus - MLPE Mount
 - 12 x PSR-LUG: Pegasus - Grounding Lug
 - 60 x PSR-WMC: Pegasus - Wire Management Clip
 - 08 x PSR-CBG: Pegasus - Cable Grip
 - 40 x PSR-CAP: Pegasus - End Cap
 - 104 x PSCR-UBBDT: Pegasus Comp Mount - Open Slot, Black L Foot, Black Flashing, Dovetail 3/8" T-Bolt
 - 80 x Heyco Wire Clips
 - 03 x S6466 EdgeScreen 6" x 100' (236ft Heyco SunScreen)
 - 03 x S6438 EdgeScreen BLK - Heyco SunScreen Clips (Per Bag)

- SOLAR MODULES**
- 40 x REC460AA Pure-RX
- INVERTER & SUPPORTING ITEMS**
- 40 x ENPHASE IQ8X-80-M-US MICROINVERTERS
 - 01 x X-IQ-AM1-240-5C: IQ Combiner 5C
 - 01 x SC200D111C240US01: IQ System Controller 3
 - 03 x IQBATTERY-5P-1P-NA: IQ Battery 5P
 - 01 x CTRL-SC3-NA-01: Enphase Control Cable (150 ft.)
- ENPHASE CABLES AND ACCESSORIES**
- 34 x Q-12-10-240: Q Cable
 - 11 x Q-12-20-200: Q Cable
 - 01 x Q-12-RAW-300:Q Cable, 12 AWG (50ft)
 - 14 x Q-CONN-10M Male Field-wireable connector
 - 14 x Q-CONN-10F Female Field-wireable connector
 - 04 x Q-TERM-10: Terminator Cap
 - 05 x Q-SEAL-10: Female Sealing Cap
 - 01 x Q-CLIP-100: Q Cable rail mount cable management clip (Pack of 100)
 - 01 x Q-DISC-10: Disconnect tool

- ELECTRICAL ITEMS**
- 04 x Eaton BR220B with hold down kit support (Circuit breaker, 2 pole, 20A)
 - 01 x X-IQ-NA-HD-125A: Hold down kit for Eaton circuit breaker with screws
 - 01 x BRK-200A-2P-240V: Main Breaker, 2-Pole, 200Amps(Eaton CSR2200N)
 - 01 x BRK-80A-2P-240V: Circuit Breaker, 2 pole, 80A (Eaton BR280B)
 - 01 x BRK-60A-2P-240V: Circuit Breaker, 2 pole, 60A (Eaton BR260B)
 - 01 x DG223URB: 250volt/100amp/2pole non fusible disconnect (NEMA 3R)
 - 03 x EZSLR JB-1.2: SolaDeck
 - 03 x PSCA-0MB0: Roof Flashing Conduit Supports
 - 03 x BPT 921S: 3/4" 1H EMT Pipe Strap Steel

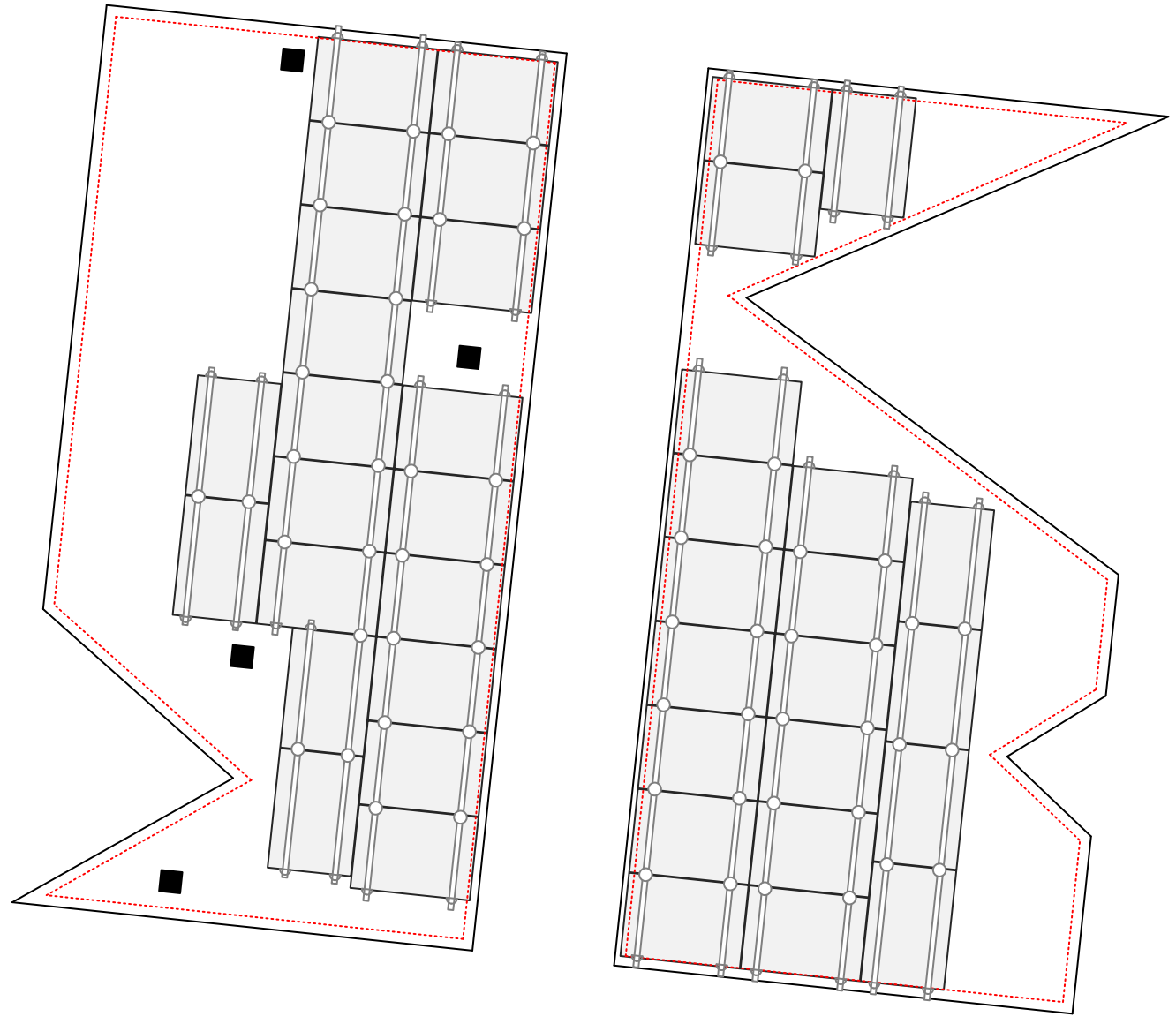

Roof B
20 Modules

Roof A
20 Modules

6in setback from sides of the roof

BILL OF MATERIAL
SCALE: 1/8" - 1'

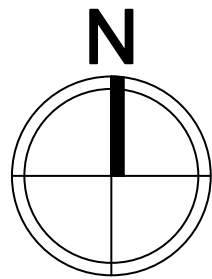

Customer Information:

Bonnes John
97 Sunnybrook Lane
Lillington, NC 27546

Customer Signature:

Sheet Name:

Bill of Material

JOB NUMBER:

24-762-JB

Date:

12/17/2024

Revision:

A

Sheet Size:

ANSI C
17" X 22"

Sheet Number:

PV7



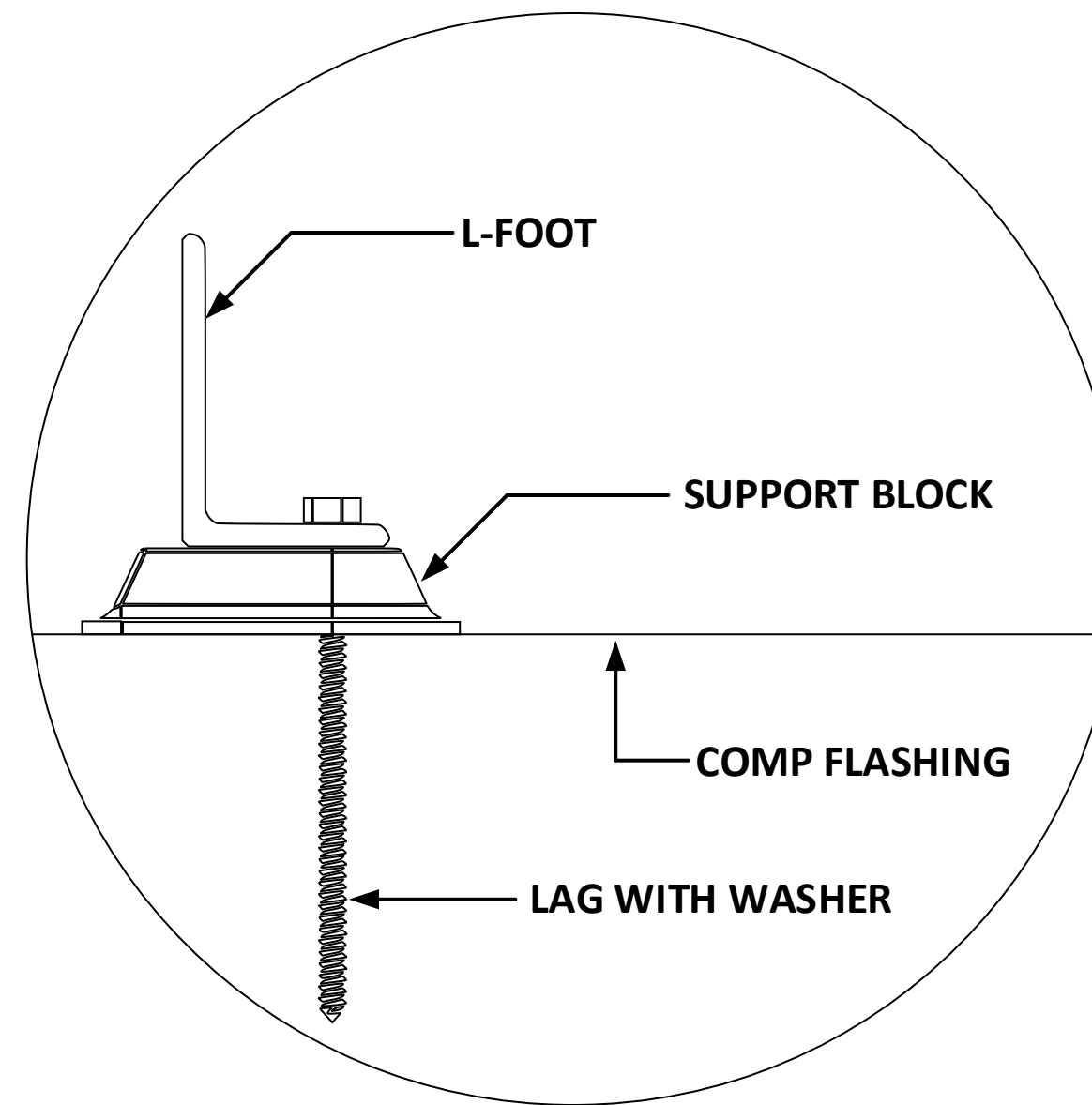
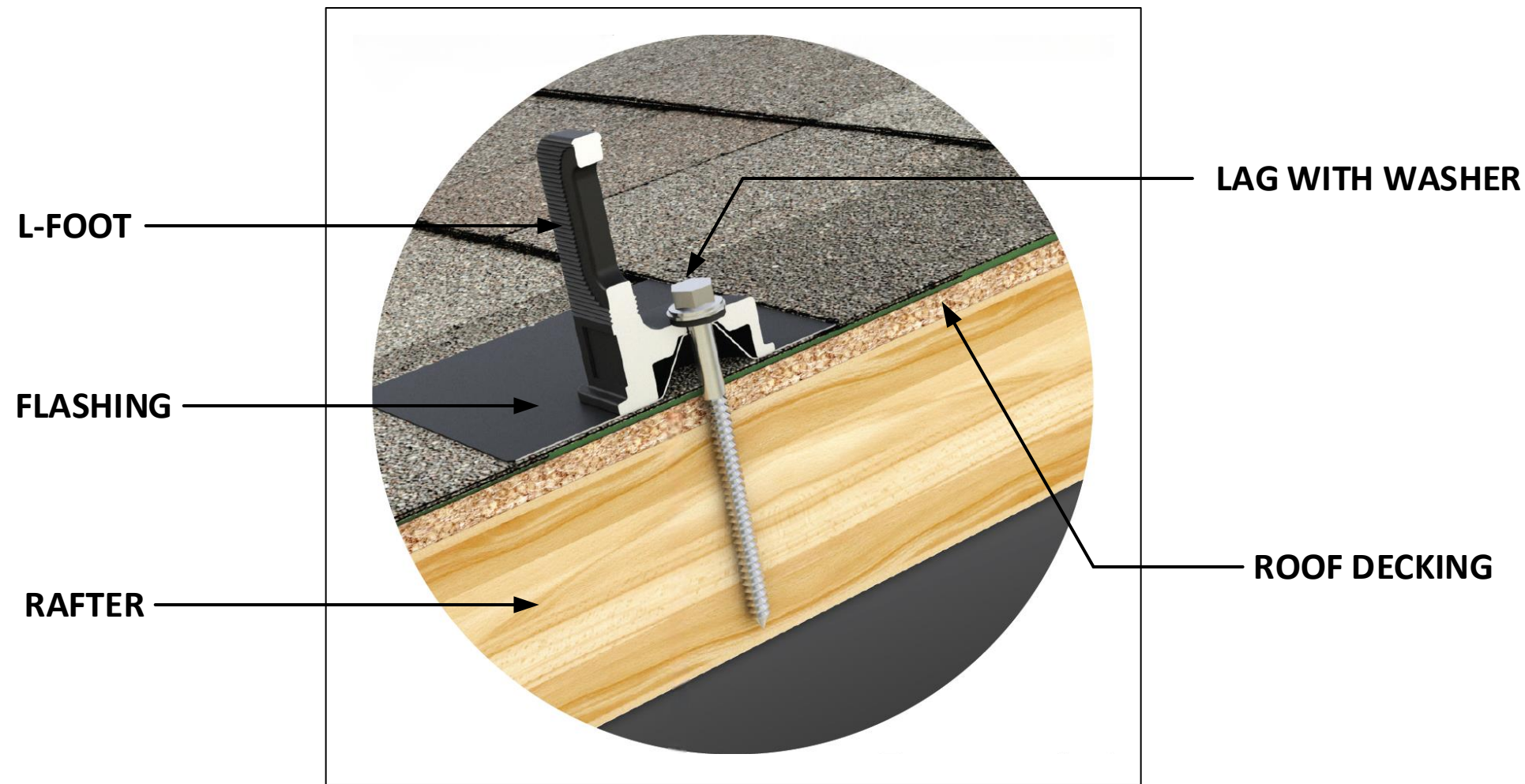

5112 Departure Drive,
Raleigh NC 27616
O: 919.948.6474
E: info@8msolar.com

Customer Information:

Bonnes John
97 Sunnybrook Lane
Lillington, NC 27546

Customer Signature:

Sheet Name:

Attachment Details

JOB NUMBER:

24-762-JB

Date:

12/17/2024

Revision:

A

Sheet Size:

ANSI C
17" X 22"

Sheet Number:

PV8



Multi-Clamp	Hidden End Clamp	MLPE Mount	Dovetail T-Bolt	Ground Lug	Cable Grip
Torque Value 100 in-lbs.	Torque Value 135 in-lbs.	Torque Value 135 in-lbs.	Torque Value 300 in-lbs.	Torque Value 135 in-lbs.	Torque Value 135 in-lbs.

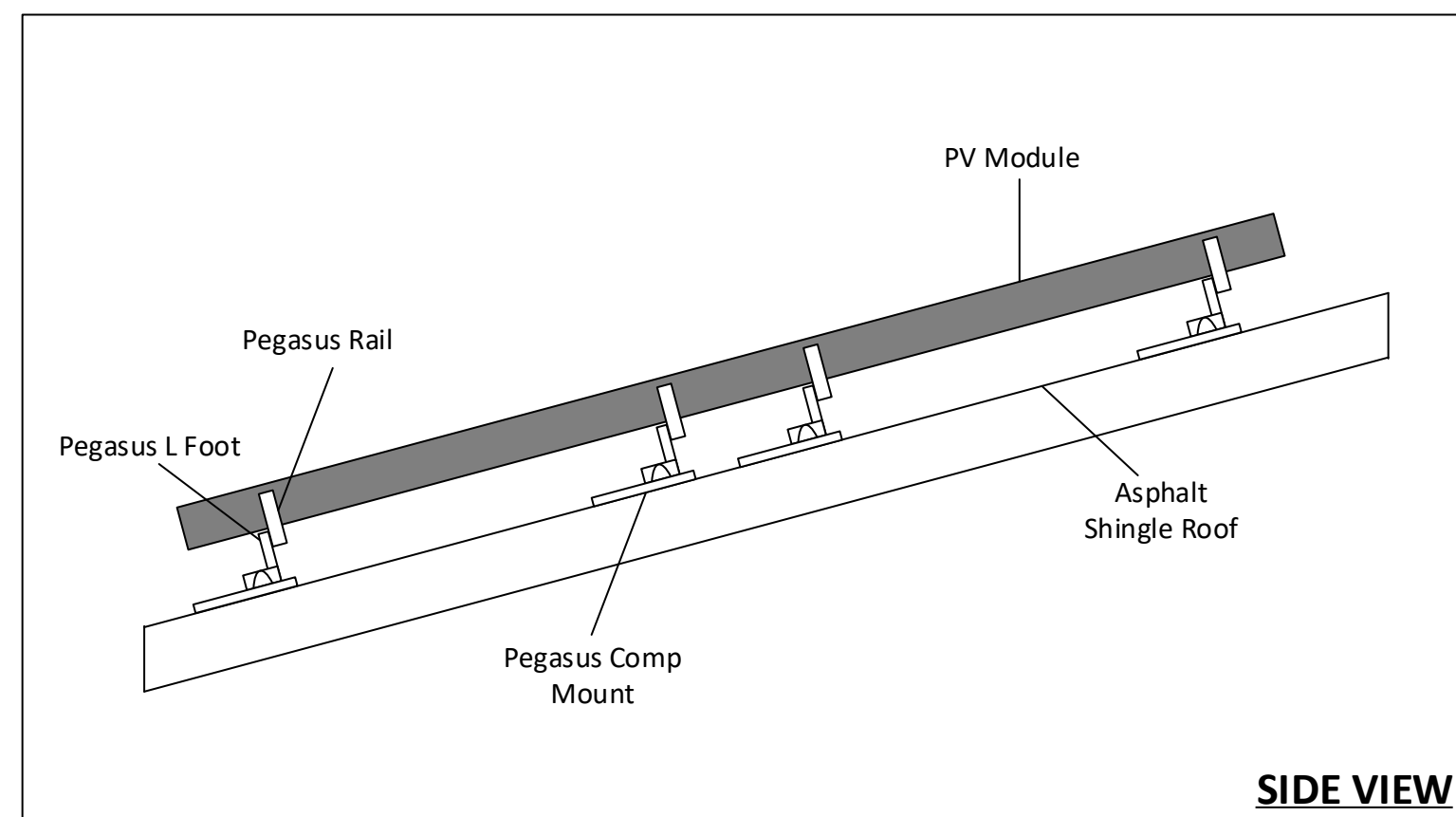

PV Dead Load	
Roof A	<p>PV System Dead Load (Panel + Racking weight) / PV System Area (20 panels x 48.7 lbs./panel + 177 ft. of racking x 1.17 lb.ft) / (20 panels x 6.11' x 3.37') = 2.69 psf</p>

PV Dead Load	
Roof B	<p>PV System Dead Load (Panel + Racking weight) / PV System Area (20 panels x 48.7 lbs./panel + 173 ft. of racking x 1.17 lb.ft) / (20 panels x 6.11' x 3.37') = 2.68 psf</p>

SOLAR'S MOST TRUSTED



REC ALPHA[®] PURE-RX SERIES

DATASHEET

470 W_P

22.6% EFFICIENCY

21 W/FT²

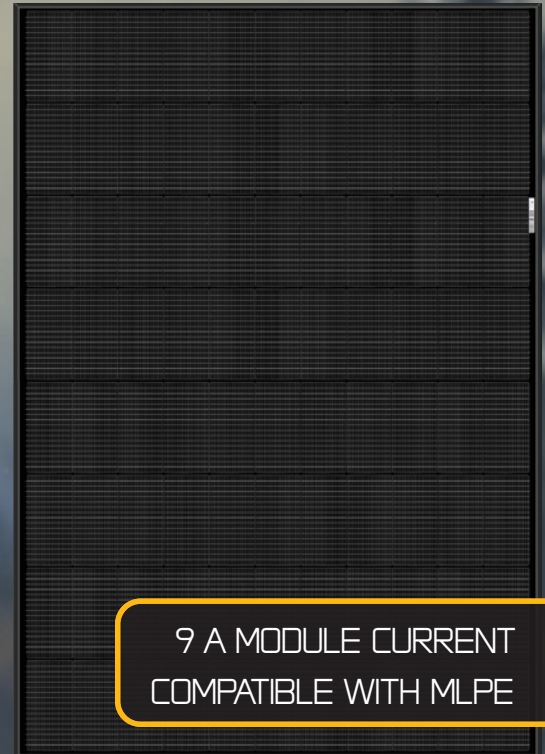

9 A MODULE CURRENT
COMPATIBLE WITH MLPE



ELIGIBLE

EXPERIENCE



PERFORMANCE

REC ALPHA[®] PURE-RX SERIES

DATASHEET

GENERAL DATA

Cell Type	88 half-cut bifacial REC heterojunction cells, with gapless technology
Glass	0.13 in. solar glass with anti-reflective surface treatment in accordance with EN12150
Backsheet	Highly resistant polymer (Black)
Frame	Anodized aluminum (Black)
Junction Box	4-part, 4 bypass diodes, IP68 rated, in accordance with IEC 62790
Connectors	Stäubli MC4 PV-KBT4/KST4 (12AWG) in accordance with IEC 62852, IP68 only when connected
Cable	12 AWG solar cable, 66.9 in. + 66.9 in. in accordance with EN50618
Dimensions	68 x 47.4 x 1.2 in. (22.4 ft ²)
Weight	50 lbs
Origin	Made in Singapore

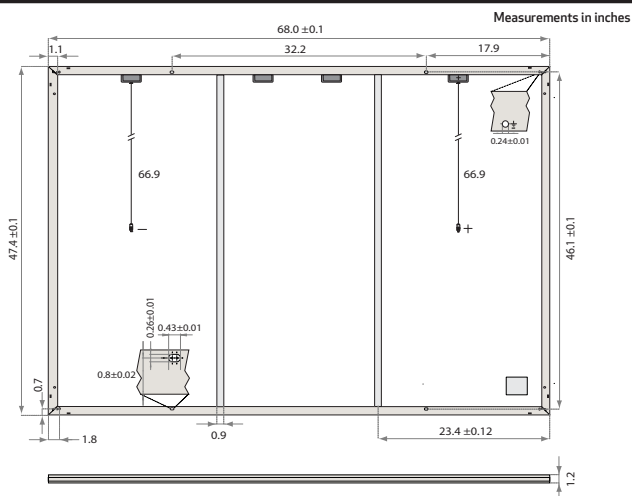

ELECTRICAL DATA

PRODUCT CODE*: RECxxxAA Pure-RX

	450	460	470
Power Output - P _{MAX} (W _p)	450	460	470
Watt Class Sorting - (W)	0/+10	0/+10	0/+10
Nominal Power Voltage - V _{MPP} (V)	54.3	54.9	55.4
Nominal Power Current - I _{MPP} (A)	8.29	8.38	8.49
Open Circuit Voltage - V _{OC} (V)	65.1	65.3	65.6
Short Circuit Current - I _{SC} (A)	8.81	8.88	8.95
Power Density (W/ft ²)	20.1	20.5	21.0
Panel Efficiency (%)	21.6	22.1	22.6

CERTIFICATIONS

IEC 61215:2021; IEC61730:2016; UL61730
 ISO 11925-2 Ignitability (EN 13501-1 Class E)
 IEC 62716 Ammonia Resistance
 IEC 61701 Salt Mist (SM6)
 IEC 61215:2016 Hailstone (35mm)
 UL 61730 Fire Type 2
 ISO 14001; ISO9001; IEC45001; IEC62941



takeaway
for an easy way
Take-e-way WEEE-compliant scheme

STC

NMOT

Power Output - P _{MAX} (W _p)	343	350	358
Nominal Power Voltage - V _{MPP} (V)	51.2	51.7	52.2
Nominal Power Current - I _{MPP} (A)	6.70	6.77	6.86
Open Circuit Voltage - V _{OC} (V)	61.3	61.6	61.8
Short Circuit Current - I _{SC} (A)	7.11	7.17	7.23

Values at standard test conditions (STC: air mass AM1.5, irradiance 1000 W/m², temperature 77°F (25°C)), based on a production spread with a tolerance of P_{MAX}, V_{OC} & I_{SC} ±3% within one watt class. Nominal module operating temperature (NMOT: air mass AM1.5, irradiance 800 W/m², temperature 68°F (20°C), windspeed 3.3 ft/s (1 m/s)). *Where xxx indicates the nominal power class (P_{MAX}) at STC above.

MAXIMUM RATINGS*

Operational Temperature	-40 °F - 185 °F
System Voltage	1000 V
Maximum Test Load (front)	+7000 Pa (146 lb/ft ²)
Maximum Test Load (rear)	-4000 Pa (83.4 lb/ft ²)
Max Series Fuse Rating	25 A
Max Reverse Current	25 A

* See installation manual for mounting instructions.
Design load = Test load / 1.5 (safety factor)

TEMPERATURE RATINGS*

Nominal Module Operating Temperature	44 °C ± 2 °C
Temperature coefficient of P _{MAX}	-0.24% /K
Temperature coefficient of V _{OC}	-0.24% /K
Temperature coefficient of I _{SC}	0.04% /K

*The temperature coefficients stated are linear values

DELIVERY INFORMATION

Panels per Pallet	33
Panels per 40 ft GP/high cube container	594 (18 Pallets)
Panels per 53 ft truck	792 (24 Pallets)

Available from:

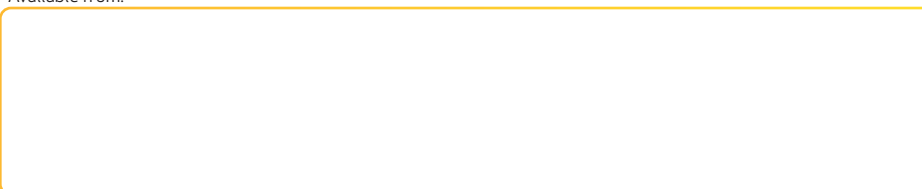

Founded in 1996, REC Group is an international pioneering solar energy company dedicated to empowering consumers with clean, affordable solar power. As Solar's Most Trusted, REC is committed to high quality, innovation, and a low carbon footprint in the solar materials and solar panels it manufactures. Headquartered in Norway with operational headquarters in Singapore, REC also has regional hubs in North America, Europe, and Asia-Pacific.

WARRANTY

	Standard	REC ProTrust	
Installed by an REC Certified Professional	No	Yes	Yes
System Size	All	<25 kW	25-500 kW
Product Warranty (yrs)	20	25	25
Power Warranty (yrs)	25	25	25
Labor Warranty (yrs)	0	25	10
Power in Year 1	98%	98%	98%
Annual Degradation	0.25%	0.25%	0.25%
Power in Year 25	92%	92%	92%

The REC ProTrust Warranty is only available on panels purchased through an REC Certified Solar Professional installer. Warranty conditions apply. See www.recgroup.com for more details

LOW LIGHT BEHAVIOR

Typical low irradiance performance of module at STC:

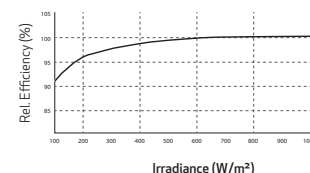

REC Solar PTE. LTD.
20 Tuas South Ave. 14
Singapore 637312
post@recgroup.com
www.recgroup.com

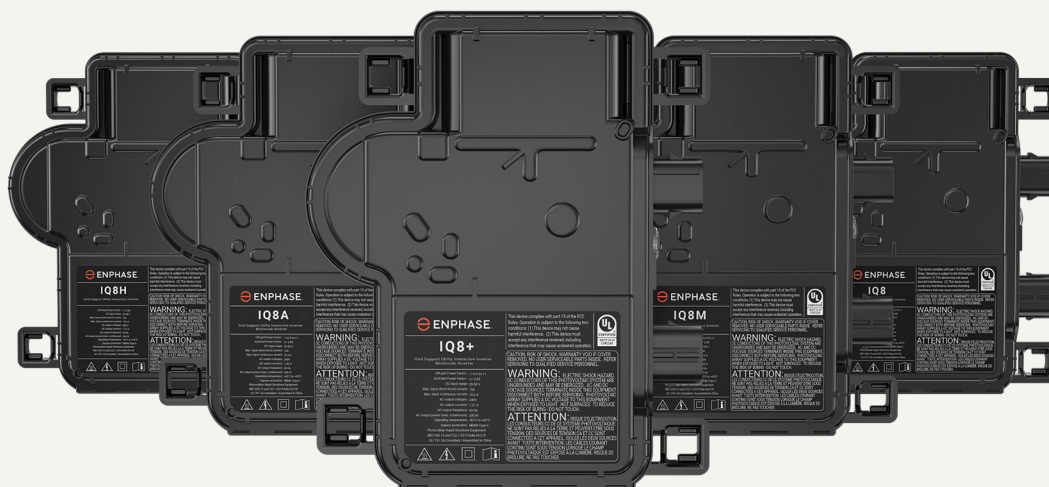

IQ8 Series Microinverters

Our newest IQ8 Microinverters are the industry’s first microgrid-forming, software-defined microinverters with split-phase power conversion capability to convert DC power to AC power efficiently. The brain of the semiconductor-based microinverter is our proprietary application-specific integrated circuit (ASIC) which enables the microinverter to operate in grid-tied or off-grid modes. This chip is built in advanced 55nm technology with high speed digital logic and has super-fast response times to changing loads and grid events, alleviating constraints on battery sizing for home energy systems.



Part of the Enphase Energy System, IQ8 Series Microinverters integrate with the Enphase IQ Battery, Enphase IQ Gateway, and the Enphase App monitoring and analysis software.



IQ8 Series Microinverters redefine reliability standards with more than one million cumulative hours of power-on testing, enabling an industry-leading limited warranty of up to 25 years.



Connect PV modules quickly and easily to IQ8 Series Microinverters using the included Q-DCC-2 adapter cable with plug-n-play MC4 connectors.



IQ8 Series Microinverters are UL Listed as PV Rapid Shut Down Equipment and conform with various regulations, when installed according to manufacturer’s instructions.

Easy to install

- Lightweight and compact with plug-n-play connectors
- Power Line Communication (PLC) between components
- Faster installation with simple two-wire cabling

High productivity and reliability

- Produce power even when the grid is down*
- More than one million cumulative hours of testing
- Class II double-insulated enclosure
- Optimized for the latest high-powered PV modules

Microgrid-forming

- Complies with the latest advanced grid support**
- Remote automatic updates for the latest grid requirements
- Configurable to support a wide range of grid profiles
- Meets CA Rule 21 (UL 1741-SA) requirements

IQ8 Series Microinverters

INPUT DATA (DC)		IQ8-60-2-US	IQ8PLUS-72-2-US	IQ8M-72-2-US	IQ8A-72-2-US	IQ8H-240-72-2-US	IQ8H-208-72-2-US ¹
Commonly used module pairings ²	W	235 – 350	235 – 440	260 – 460	295 – 500	320 – 540+	295 – 500+
Module compatibility		60-cell/120 half-cell	60-cell/120 half-cell, 66-cell/132 half-cell and 72-cell/144 half-cell				
MPPT voltage range	V	27 – 37	29 – 45	33 – 45	36 – 45	38 – 45	38 – 45
Operating range	V	25 – 48	25 – 58				
Min/max start voltage	V	30 / 48	30 / 58				
Max input DC voltage	V	50	60				
Max DC current ³ [module Isc]	A	15					
Overtoltage class DC port		II					
DC port backfeed current	mA	0					
PV array configuration		1x1 Ungrounded array; No additional DC side protection required; AC side protection requires max 20A per branch circuit					
OUTPUT DATA (AC)		IQ8-60-2-US	IQ8PLUS-72-2-US	IQ8M-72-2-US	IQ8A-72-2-US	IQ8H-240-72-2-US	IQ8H-208-72-2-US ¹
Peak output power	VA	245	300	330	366	384	366
Max continuous output power	VA	240	290	325	349	380	360
Nominal (L-L) voltage/range ⁴	V	240 / 211 – 264					208 / 183 – 250
Max continuous output current	A	1.0	1.21	1.35	1.45	1.58	1.73
Nominal frequency	Hz	60					
Extended frequency range	Hz	50 – 68					
AC short circuit fault current over 3 cycles	Arms	2					4.4
Max units per 20 A (L-L) branch circuit ⁵		16	13	11	11	10	9
Total harmonic distortion		<5%					
Overtoltage class AC port		III					
AC port backfeed current	mA	30					
Power factor setting		1.0					
Grid-tied power factor (adjustable)		0.85 leading – 0.85 lagging					
Peak efficiency	%	97.5	97.6	97.6	97.6	97.6	97.4
CEC weighted efficiency	%	97	97	97	97.5	97	97
Night-time power consumption	mW	60					
MECHANICAL DATA							
Ambient temperature range		-40°C to +60°C (-40°F to +140°F)					
Relative humidity range		4% to 100% (condensing)					
DC Connector type		MC4					
Dimensions (HxWxD)		212 mm (8.3") x 175 mm (6.9") x 30.2 mm (1.2")					
Weight		1.08 kg (2.38 lbs)					
Cooling		Natural convection – no fans					
Approved for wet locations		Yes					
Pollution degree		PD3					
Enclosure		Class II double-insulated, corrosion resistant polymeric enclosure					
Environ. category / UV exposure rating		NEMA Type 6 / outdoor					
COMPLIANCE							
Certifications		CA Rule 21 (UL 1741-SA), UL 62109-1, UL1741/IEEE1547, FCC Part 15 Class B, ICES-0003 Class B, CAN/CSA-C22.2 NO. 107.1-01 This product is UL Listed as PV Rapid Shut Down Equipment and conforms with NEC 2014, NEC 2017, and NEC 2020 section 690.12 and C22.1-2018 Rule 64-218 Rapid Shutdown of PV Systems, for AC and DC conductors, when installed according to manufacturer's instructions.					

(1) The IQ8H-208 variant will be operating in grid-tied mode only at 208V AC. (2) No enforced DC/AC ratio. See the compatibility calculator at <https://link.enphase.com/module-compatibility> (3) Maximum continuous input DC current is 10.6A (4) Nominal voltage range can be extended beyond nominal if required by the utility. (5) Limits may vary. Refer to local requirements to define the number of microinverters per branch in your area.



X-IQ-AM1-240-5
X-IQ-AM1-240-5C

IQ Combiner 5/5C

The IQ Combiner 5/5C consolidates interconnection equipment into a single enclosure and streamlines IQ Series Microinverters and IQ Gateway installation by providing a consistent, pre-wired solution for residential applications. IQ Combiner 5/5C uses wired control communication and is compatible with IQ System Controller 3/3G and IQ Battery 5P.

The IQ Combiner 5/5C, along with IQ Series Microinverters, IQ System Controller 3/3G, and IQ Battery 5P provides you with a complete grid-agnostic Enphase Energy System.



IQ Series Microinverters

The high-powered smart grid-ready IQ Series Microinverters (IQ6, IQ7, and IQ8 Series) dramatically simplify the installation process



IQ System Controller 3/3G

Provides microgrid interconnection device (MID) functionality by automatically detecting grid failures and seamlessly transitioning the home energy system from grid power to backup power



IQ Battery 5P

Fully integrated AC battery system. Includes six field-replaceable IQ8D-BAT Microinverters



IQ Load Controller

Helps prioritize essential appliances during a grid outage to optimize energy consumption and prolong battery life

Smart

- Includes IQ Gateway for communication and control
- Includes Enphase Mobile Connect (CELLMODEM-M1-06-SP-05), only with IQ Combiner 5C
- Supports flexible networking: Wi-Fi, Ethernet, or cellular
- Provides production metering (revenue grade) and consumption monitoring

Easy to install

- Mounts to one stud with centered brackets
- Supports bottom, back, and side conduit entry
- Supports up to four 2-pole branch circuits for 240 VAC plug-in breakers (not included)
- 80 A total PV branch circuits

Reliable

- Durable NRTL-certified NEMA type 3R enclosure
- 5-year limited warranty
- Two years labor reimbursement program coverage included for both the IQ Combiner SKUs
- UL1741 listed



5-year
limited
warranty



IQ Combiner 5/5C

MODEL NUMBER	
IQ Combiner 5 (X-IQ-AM1-240-5)	IQ Combiner 5 with IQ Gateway printed circuit board for integrated revenue grade PV production metering (ANSIC12.20 ±0.5%), consumption monitoring (± 2.5%) and IQ Battery monitoring (±2.5%). Includes a silver solar shield to deflect heat
IQ Combiner 5C (X-IQ-AM1-240-5C)	IQ Combiner 5C with IQ Gateway printed circuit board for integrated revenue grade PV production metering (ANSI C12.20 ±0.5%), consumption monitoring (±2.5%) and IQ Battery monitoring (±2.5%). Includes Enphase Mobile Connect cellular modem (CELLMODEM-M1-06-SP-05) ¹ . Includes a silver solar shield to deflect heat
WHAT'S IN THE BOX	
IQ Gateway printed circuit board	IQ Gateway is the platform for total energy management for comprehensive, remote maintenance and management of the Enphase IQ System
Busbar	125A busbar with support for 1 x IQ Gateway breaker and 4 x 20A breaker for installing IQ Series Microinverters and IQ Battery 5P
IQ Gateway breaker	Circuit breaker, 2-pole, 10 A/15 A
Production CT	Prewired revenue-grade solid core CT, accurate up to 0.5%
Consumption CT	Two consumption metering clamp CTs, shipped with the box, accurate up to 2.5%
IQ Battery CT	One battery metering clamp CT, shipped with the box, accurate up to 2.5%
CTRL board	Control board for wired communication with IQ System Controller 3/3G and the IQ Battery 5P
Enphase Mobile Connect (only with IQ Combiner 5C)	4G-based LTE-M1 cellular modem (CELLMODEM-M1-06-SP-05) with a 5-year T-Mobile data plan
Accessories kit	Spare control headers for CTRL board
ACCESSORIES AND REPLACEMENT PARTS (NOT INCLUDED, ORDER SEPARATELY)	
CELLMODEM-M1-06-SP-05	4G-based LTE-M1 cellular modem with a 5-year T-Mobile data plan
CELLMODEM-M1-06-AT-05	4G-based LTE-M1 cellular modem with a 5-year AT&T data plan
Circuit breakers (off-the-shelf)	Supports Eaton BR210, BR215, BR220, BR230, BR240, BR250, and BR260 circuit breakers Supports Eaton BR220B, BR230B, and BR240B circuit breakers compatible with hold-down kit
Circuit breakers (provided by Enphase)	BRK-10A-2-240V, BRK-15A-2-240V, BRK-20A-2P-240V, BRK-15A-2P-240V-B, and BRK-20A-2P-240V-B (More details in "Accessories" section)
XA-SOLARSHIELD-ES	Replacement solar shield for IQ Combiner 5/5C
XA-ENV2-PCBA-5	IQ Gateway replacement printed circuit board (PCB) for Combiner 5/5C
X-IQ-NA-HD-125A	Hold-down kit compatible with Eaton BR-B series circuit breakers (with screws)
ELECTRICAL SPECIFICATIONS	
Rating	80 A
System voltage	120/240 VAC, 60 Hz
Busbar rating	125 A
Fault current rating	10 kAIC
Maximum continuous current rating (input from PV/storage)	64 A
Branch circuits (solar and/or storage)	Up to four 2-pole Eaton BR series distributed generation (DG) breakers only (not included)
Maximum total branch circuit breaker rating (input)	80 A of distributed generation/95 A with IQ Gateway breaker included
IQ Gateway breaker	10 A or 15 A rating GE/Siemens/Eaton included
Production metering CT	200 A solid core pre-installed and wired to IQ Gateway
Consumption monitoring CT (CT-200-CLAMP)	A pair of 200 A clamp-style current transformers is included with the box
IQ Battery metering CT	200 A clamp-style current transformer for IQ Battery metering, included with the box

¹ A plug-and-play industrial-grade cell modem for systems up to 60 microinverters. (Available in the US, Canada, Mexico, Puerto Rico, and the US Virgin Islands, where there is adequate cellular service in the installation area.)

MECHANICAL DATA	
Dimensions (WxHxD)	37.5 cm x 49.5 cm x 16.8 cm (14.75" x 19.5" x 6.63"). Height is 21.06" (53.5 cm) with mounting brackets
Weight	7.5 kg (16.5 lbs)
Ambient temperature range	-40°C to 46°C (-40°F to 115°F)
Cooling	Natural convection, plus heat shield
Enclosure environmental rating	Outdoor, NRTL-certified, NEMA type 3R, polycarbonate construction
Wire sizes	<ul style="list-style-type: none"> • 20 A to 50 A breaker inputs: 14 to 4 AWG copper conductors • 60 A breaker branch input: 4 to 1/0 AWG copper conductors • Main lug combined output: 10 to 2/0 AWG copper conductors • Neutral and ground: 14 to 1/0 copper conductors • Always follow local code requirements for conductor sizing
Communication (In-premise connectivity)	Built-in CTRL board for wired communication with IQ Battery 5P and IQ System Controller 3/3G. Integrated Power Line Communication for IQ Series Microinverters
Altitude	Up to 2,600 meters (8,530 feet)
COMMUNICATION INTERFACES	
Integrated Wi-Fi	802.11b/g/n (dual band 2.4 GHz/5 GHz), for connecting the Enphase cloud via the internet
Wi-Fi range (recommended)	10 m
Ethernet	Optional, 802.3, Cat5E (or Cat 6) UTP Ethernet cable (not included), for connecting to the Enphase Cloud via the internet
Mobile Connect	CELLMODEM-M1-06-SP-05 or CELLMODEM-M1-06-AT-05 (included with IQ Combiner 5C)
Digital I/O	Digital input/output for grid operator control
USB 2.0	For Mobile Connect
Access point (AP) mode	For connection between the IQ Gateway and a mobile device running the Enphase Installer App
Metering ports	Up to two Consumption CTs, one IQ Battery CT, and one Production CT
Power line communication	90–110 kHz
Web API	Refer to https://developer-v4.enphase.com
Local API	Refer to guide for local API
COMPLIANCE	
IQ Combiner	UL 1741, CAN/CSA C22.2 No. 107.1, Title 47 CFR, Part 15, Class B, ICES 003
IQ Gateway	UL 60601-1/CANCSA 22.2 No. 61010-1, IEEE 1547: 2018 (UL 1741-SB, 3 rd Ed.) IEEE 2030.5/CSIP Compliant Production metering: ANSI C12.20 accuracy class 0.5 (PV production)
COMPATIBILITY	
IQ System Controller 3/3G	SC200D111C240US01, SC200G111C240US01
IQ Battery 5P	IQBATTERY-5P-1P-NA
Microinverter	IQ6, IQ7, and IQ8 Series Microinverters

Accessories



Enphase Mobile Connect

4G-based LTE-M1 cellular modem with a 5-year data plan
(CELLMODEM-M1-06-SP-05 for Sprint and
CELLMODEM-M1-06-AT-05 for AT&T)



Circuit breakers

BRK-10A-2-240V Circuit breaker, 2-pole, 10 A, Eaton BR210
BRK-15A-2-240V Circuit breaker, 2-pole, 15 A, Eaton BR215
BRK-20A-2P-240V Circuit breaker, 2-pole, 20 A, Eaton BR220
BRK-15A-2P-240V-B Circuit breaker, 2-pole, 15 A, Eaton BR215B
with hold-down kit support
BRK-20A-2P-240V-B Circuit breaker, 2-pole, 20 A, Eaton
BR220B with hold-down kit support



CT-200-SOLID

200 A revenue grade solid core Production CT
with <0.5% error rate (replacement SKU)



CT-200-CLAMP

200 A clamp-style consumption and battery
metering CT with <2.5% error rate (replacement
SKU)

Revision history

REVISION	DATE	DESCRIPTION
DSH-00007-1.0	May 2023	Initial release



IQ Battery 5P

The IQ Battery 5P all-in-one AC-coupled system is powerful, reliable, simple, and safe. It has a total usable energy capacity of 5.0 kWh and includes six embedded grid-forming microinverters with a 3.84 kVA continuous power rating. It provides backup capability, and installers can quickly design the right system size to meet the customer needs.

Dimensions

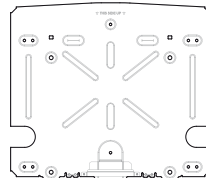
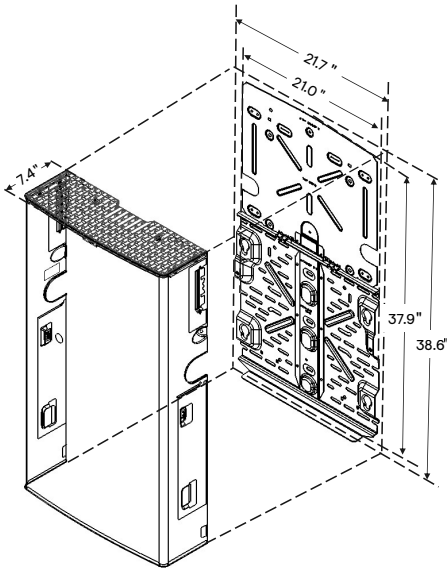

Top shield

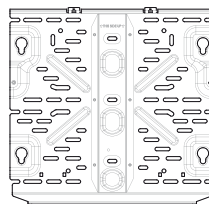

Bottom mounting bracket



15-year limited warranty



LISTED



UL 9540A Certified

Powerful

- Provides 3.84 kVA continuous and 7.68 kVA peak power
- Doubles the available power per kWh of prior generations of IQ Battery
- Includes six embedded IQ8D-BAT Microinverters

Reliable

- 15-year limited warranty
- Cools passively with no moving parts or fans
- Uses wired communication for fast and consistent connection
- Updates software and firmware remotely

Simple

- Fully integrated AC battery system
- Installs and commissions easily
- Supports Backup, Self-Consumption, and time-of-use (TOU) modes
- Offers homeowners remote monitoring and control from the Enphase App
- Field replaceable components

Safe

- Evaluated to UL 9540A for large scale fire testing and reduced separation distance as required in 2021 IRC R328.3.1, 2021 IFC 1207.1.5, and 2023 NFPA 855 15.3.1 and 9.1.5.¹
- Uses lithium iron phosphate (LFP) chemistry for maximum safety and longevity

¹Follow all installation instructions when installing Enphase ESS.

IQ Battery 5P

MODEL NUMBER	
IQBATTERY-5P-1P-NA	The IQ Battery 5P system with integrated IQ Microinverters and battery management system (BMS) with battery controller
WHAT'S IN THE BOX	
IQ Battery 5P unit	IQ Battery 5P unit (B05-T02-US00-1-3)
ID cover and conduit cover	IQ Battery 5P cover with two conduit covers for the left and right sides of the unit
Bottom mounting bracket and top shield	Bottom mounting bracket for mounting the battery on the wall. One top shield is required for UL9540A
M5 seismic screws	Two M5 seismic screws for securing the battery unit on the bottom mounting bracket
M4 grounding screws	Two M4 grounding screws for securing the top shield on the bottom mounting bracket
M5 ID cover grounding screws	Two M5 ID cover grounding screws for the EMI/EMC requirement
Cable ties	Six cable ties for securing field cables to the unit
Control (CTRL) connector	Spare CTRL connector without resistor for CTRL wiring
Control (CTRL) connector with resistor	Spare CTRL connector with resistor for CTRL wiring
Quick Install Guide (QIG)	QIG for IQ Battery unit installation instructions
OPTIONAL ACCESSORIES AND REPLACEMENT PARTS	
IQ8D-BAT-RMA	IQ8D-BAT Microinverter for field replacement
B05-T02-US00-1-3-RMA	IQ Battery 5P Battery unit for field replacement
B05-CX-0550-O	IQ Battery 5P cover for field replacement
B05-PI-0550-O	IQ Battery 5P pedestal mount
B05-CP-096-O	IQ Battery 5P conduit plates for field replacement. Includes one left-side and one right-side conduit plate
B05-WB-0543-O	IQ Battery 5P wall bracket for field replacement. Includes one bottom mounting bracket and one top shield
IQBATTERY-HNDL-5	IQ Battery 5P lifting handles. Includes one left-side and one right-side lifting handle
B05-ACFB-080-O	IQ Battery 5P AC filter board for field replacement
B05-BMSNA-0490-O	IQ Battery 5P BMS board for field replacement
B05-CANB-063-O	IQ Battery 5P control communication board for field replacement
B05-NICS-0524-O, B05-NUCS-0524-O	IQ Battery 5P control switch is preinstalled on the wiring cover for field replacement
OUTPUT [AC]	
	@ 240 VAC ²
Rated (continuous) output power	3.84 kVA
Peak output power	7.68 kVA (3 seconds), 6.14 kVA (10 seconds)
Nominal voltage/range	240/211–264 VAC
Nominal frequency/range	60/57–63 Hz
Rated output current (@240 VAC)	16 A
Peak output current (@240 VAC)	32 A (3 seconds), 25.6 A (10 seconds)
Load start capability	Up to 48 A LRA ³
Power factor (adjustable)	0.85 leading...0.85 lagging
Maximum units per 20 A branch circuit	One unit (single-phase)
Maximum conductor size supported	3 AWG
Overcurrent protection device (OCPD) for 3 AWG cable	80 A
Interconnection	Single-phase
AC round-trip efficiency ⁴	90%

²Supported in both grid-connected and backup/off-grid operation

³ Load start capability may vary

⁴ AC to the battery to AC at 50% power rating

IQ Battery 5P

BATTERY

Total capacity	5.0 kWh
Usable capacity	5.0 kWh
DC round-trip efficiency	96%
Nominal DC voltage	76.8 V
Maximum DC voltage	86.4 V
Ambient operating temperature range (charging)	-20°C to 50°C (-4°F to 122°F) non-condensing
Ambient operating temperature range (discharging)	-20°C to 55°C (-4°F to 131°F) non-condensing
Optimum operating temperature range	0°C to 30°C (32°F to 86°F)
Chemistry	Lithium iron phosphate (LFP)

MECHANICAL DATA

Dimensions (HxWxD)	980 mm x 550 mm x 188 mm (38.6 in x 21.7 in x 7.4 in)
Lifting weight	66.3 kg (146.1 lbs)
Total installed weight	78.9 kg (174 lbs)
Enclosure	Outdoor-NEMA 3R
IQ8D-BAT Microinverter enclosure	NEMA type 6
Cooling	Natural convection
Altitude	Up to 2,500 meters (8,202 feet)
Mounting	Wall-mount or pedestal-mount (sold separately)

FEATURES AND COMPLIANCE

Compatibility	Compatible with IQ and M Series Microinverters, IQ System Controller 3/3G, IQ Combiner 5/5C, and IQ Gateway for grid-tied and backup operation
Communication	Wired control communication
Services	Backup, Self-Consumption, TOU, and NEM integrity
Monitoring	Enphase Installer Platform and Enphase App monitoring options; API integration
Compliance	CA Rule 21 (UL 1741-SA), IEEE 1547:2018 (UL 1741-SB, 3rd Ed.) CAN/CSA C22.2 No. 107.1-16 UL 9540, UL 9540A, UN 38.3, UL 1998, UL 991, NEMA Type 3R, AC156 EMI: 47 CFR, Part 15, Class B, ICES 003 Cell module: UL 1973, UN 38.3 Inverters: UL 62109-1, IEC 62109-2

LIMITED WARRANTY

Limited warranty	>60% capacity, up to 15 years or 6,000 cycles ⁵
------------------	--

⁵ Whichever occurs first. Restrictions apply

Revision history

REVISION	DATE	DESCRIPTION
DSH-00010-2.0	July 2023	<ul style="list-style-type: none">• Added battery isometric view on the first page.• Editorial updates.
DSH-00010-1.0	May 2023	Initial release.



IQ System Controller 3/3G

The Enphase IQ System Controller 3/3G connects the home to grid power, the IQ Battery system, and solar PV. It provides microgrid interconnect device (MID) functionality by automatically detecting and seamlessly transitioning the home energy system from grid power to backup power in the event of a grid failure. It consolidates interconnection equipment into a single enclosure and streamlines grid-independent capabilities of PV and storage installations by providing a consistent, pre-wired solution for residential applications.



IQ Series Microinverters

The high-powered smart grid-ready IQ Series Microinverters (M Series, IQ6, IQ7, and IQ8 Series) dramatically simplify the installation process



IQ Combiner 5/5C

Consolidates PV interconnection equipment into a single enclosure and streamlines IQ Series Microinverters and IQ Gateway installation by providing a consistent, pre-wired solution for residential applications



IQ Battery 5P

Fully integrated AC battery system. Includes six field-replaceable IQ8D-BAT microinverters



IQ Load Controller

Helps prioritize essential appliances during a grid outage to optimize energy consumption and prolong battery life

Easy to Install

- Connects to service entrance¹ or main load center
- Includes neutral-forming transformer
- Mounts on single stud with centered brackets
- Provides conduit entry from bottom, left, or right
- Includes color-coded wires for ease of wiring System Shutdown Switch
- Integrates hold-down functionality to eliminate the need for hold-down kits and special breakers

Flexible

- Can be used for Sunlight Backup, Home Essentials Backup, or Full Energy Independence
- IQ System Controller 3 integrates with IQ Battery 5P
- IQ System Controller 3G integrates with select AC standby generators. See [Generator Integration Tech Brief](#) for a list of generators
- Provides a seamless transition to backup

Safe and Reliable

- System Shutdown Switch can be used to disconnect PV, battery, and generator systems
- It acts as a rapid shutdown initiator of grid-forming IQ8 PV Microinverters for safety of maintenance technicians/first responders
- 10-year limited warranty



10-year limited warranty



IQ System Controller 3/3G

DATASHEET

MODEL NUMBER	DESCRIPTION
SC200D11C240US01	IQ System Controller 3 streamlines grid-independent capabilities of PV and storage installations. Integrates hold-down capability. Supports up to 40 kWh (without PCS*) and 80 kWh (with PCS*) IQ Battery 5P. Does not support generator integration
SC200G11C240US01	IQ System Controller 3G streamlines grid-independent capabilities of PV and storage installations. Integrates hold-down capability. Supports up to 20 kWh (without PCS*) and 40 kWh (with PCS*) IQ Battery 5P. Supports generator integration
WHAT'S IN THE BOX	
IQ System Controller 3/3G	Includes neutral-forming transformer (NFT) and microgrid interconnect device (MID)
System Shutdown Switch	Includes pre-wired red, black, orange and purple 12 AWG wire (EP200G-NA-02-RSD)
Wall-mounting bracket	Screws provided in the accessories kit for mounting
4-pole circuit breaker	Pre installed Quad breaker (BRK-20A40A-4P-240V), 20 A-40 A, 10 kAIC, Eaton BQC220240 ²
Accessories Kit	IQ System Controller 3/3G literature kit, including labels, CTRL headers, screws, filler plates, and QIG (EP200G-LITKIT)
OPTIONAL ACCESSORIES AND REPLACEMENT PARTS	
CT-200-SPLIT	200 A split core current transformers for metering (accuracy: $\pm 2.5\%$) ³
CT-200-CLAMP	200 A clamp-type current transformers for metering (accuracy: $\pm 2.5\%$) ³
Circuit breakers (order separately, as needed) ⁴ : <ul style="list-style-type: none"> BRK-100A-2P-240V : Main breaker, 2-pole, 100A, 25kAIC, CSR2100N or CSR2100 BRK-125A-2P-240V: Main breaker, 2-pole, 125A, 25kAIC, CSR2125N BRK-150A-2P-240V: Main breaker, 2-pole, 150A, 25kAIC, CSR2150N BRK-175A-2P-240V: Main breaker, 2-pole, 175A, 25kAIC, CSR2175N BRK-200A-2P-240V: Main breaker, 2-pole, 200A, 25kAIC, CSR2200N 	Circuit breakers (order separately, as needed) ⁵ : <ul style="list-style-type: none"> BRK-20A-2P-240V-B: Circuit breaker, 2-pole, 20 A, 10 kAIC, BR220B/BR220 BRK-30A-2P-240V-B: Circuit breaker, 2-pole, 30 A, 10 kAIC, BR230 BRK-40A-2P-240V-B: Circuit breaker, 2-pole, 40 A, 10 kAIC, BR240B/BR240 BRK-60A-2P-240V: Circuit breaker, 2-pole, 60 A, 10 kAIC, BR260 BRK-80A-2P-240V: Circuit breaker, 2-pole, 80 A, 10 kAIC, BR280
EP200G-HNDL-R1	IQ System Controller 3/3G installation handle kit (order separately)
CTRL-SC3-NA-01	Control cable, 500 ft. spool (order separately)
ELECTRICAL SPECIFICATIONS	
Nominal voltage/Range (L-L)	240 V \sim $\pm 20\%$
Voltage measurement accuracy	$\pm 1\%$ V nominal (± 1.2 V L-N and ± 2.4 V L-L)
Auxiliary (dry)contact for load control, excess PV control, and generator two-wire control	24 V, 1 A
Nominal frequency/Range	60 Hz/56–63 Hz
Frequency measurement accuracy	± 0.1 Hz
Maximum continuous current rating	160 A
Maximum input overcurrent protection device	200 A
Maximum output overcurrent protection device	200 A
Maximum overcurrent protection device rating for generator circuit	80 A (IQ System Controller 3G only - SC200G11C240US01)
Maximum overcurrent protection device rating for storage circuit	2x 80 A (IQ System Controller 3 - SC200D11C240US01), 1x 80 A (IQ System Controller 3G - SC200G11C240US01)
Maximum overcurrent protection device rating for PV combiner unit	80 A
Internal busbar rating	200 A
Neutral-forming transformer (NFT)	<ul style="list-style-type: none"> Maximum continuous unbalance current: 30 A @ 120 V Peak rated power: 8,800 VA for 30 seconds Peak unbalanced current: 80 A @ 120 V for 2 seconds
<ul style="list-style-type: none"> Breaker rating (pre-installed): 40A between L1 and Neutral; 40A between L2 and Neutral Continuous rated power: 3,600 VA 	

(2) Factory installed quad breaker (Siemens or Eaton). NFT pre-wired to 40 A terminal of the quad breaker.

(3) Two unit of CT-200-SPLIT or CT-200-CLAMP to be bought separately for generator integration

(4) The IQ System Controller 3 is rated at 22 kAIC.

(5) Integrated hold down kit also support breakers (BR220/BR230/BR240) without predrilled hole.

(6) "-" indicates alternating current (AC) supply.

(*) Power Control System

MECHANICAL DATA		
Dimensions (WxHxD)	50 cm x 91.6 cm x 24.6 cm (19.7 in x 36 in x 9.7 in)	
Weight	39.4 kg (87 lbs)	
Ambient temperature range	-40°C to 50°C (-40°F to 122°F)	
Cooling	Natural convection, plus heat shield	
Enclosure environmental rating	Outdoor, NEMA type 3R, polycarbonate construction	
Maximum altitude	2,500 meters (8,200 feet)	
WIRE SIZES		
Connections (All lugs are rated to 90°C)	Main lugs and backup load lugs CSR breaker bottom wiring lugs AC combiner lugs, IQ Battery lugs, and generator lugs Neutral (large lugs)	Cu/Al: 6 AWG–300 kcmil Cu/Al: 2 AWG–300 kcmil 14 AWG–2 AWG Cu/Al: 6 AWG–300 kcmil
Neutral and ground bars	Large holes (5/16–24 UNF) Small holes (10–32 UNF)	14 AWG–1/0 AWG 14 AWG–6 AWG
COMPLIANCE		
Compliance (under progress)	UL 1741, UL 1741 SA, IEEE 1547:2018 (UL 1741-SB, 3rd Ed.), UL 1741 PCS CRD, UL1998, UL 869A, UL 675, UL 508 ⁷ , UL 50E ⁷ CSA 22.2 No. 107.1, 47 CFR Part 15 Class B, ICES 003, ICC ES AC156. The IQ System Controller 3/3G is approved for use as service equipment in the United States	
WARRANTY		
Limited warranty (restrictions apply)	Up to 10 years (EP200G-NA-02-RSD is warranted for 5 years)	
COMPATIBILITY		
IQ Battery 5P	IQBATTERY-5P-1P-NA	
Microinverters	IQ6, IQ7, IQ8, and M ⁸ Series Microinverters ⁹	
IQ Combiner 5/5C	X-IQ-AM1-240-5C, X-IQ-AM1-240-5	
Communications Kit 2	COMMS-KIT-02	

(7) Sections from these standards were used during the safety evaluation and included in the UL 1741 listing.

(8) M Series microinverters can only be supported in states that have not yet adopted IEEE 1547:2018.

(9) Enphase does not support mixing IQ8 Series Microinverters with other Series on the same IQ Gateway.

Figure 1A: Installing DER breakers for IQ8 System without generator

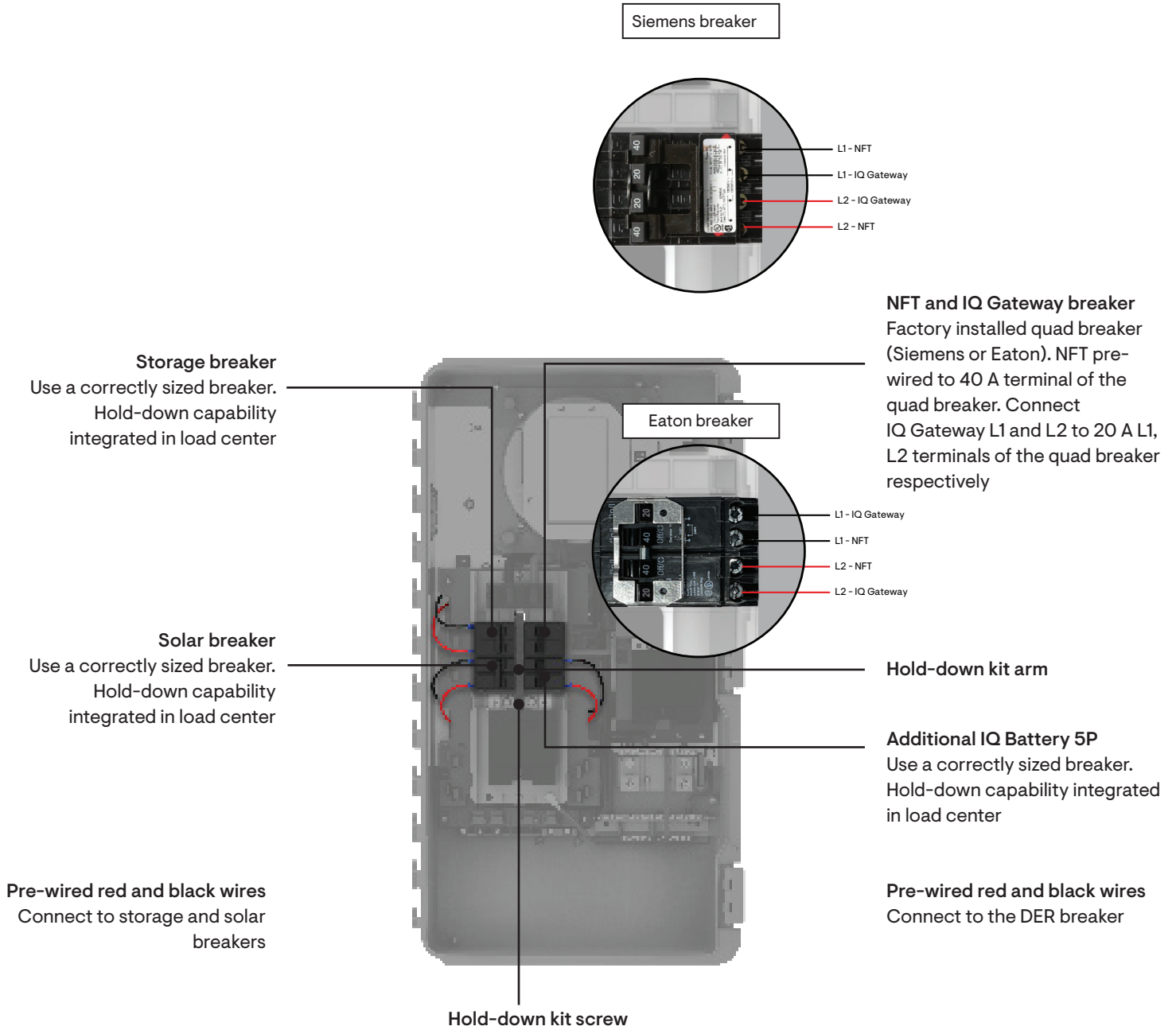

Figure 1B: Installing DER breakers for IQ8 System with generator

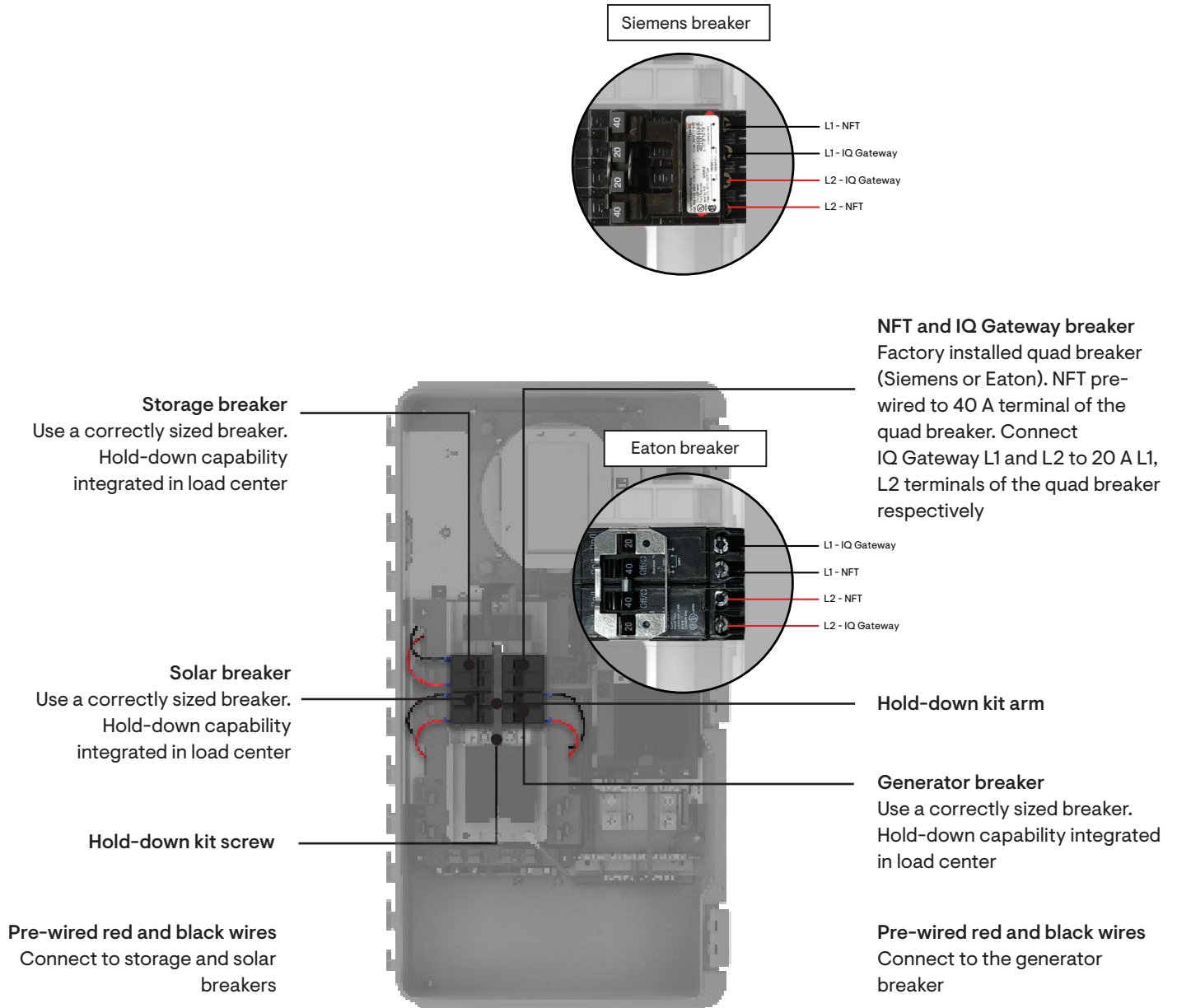
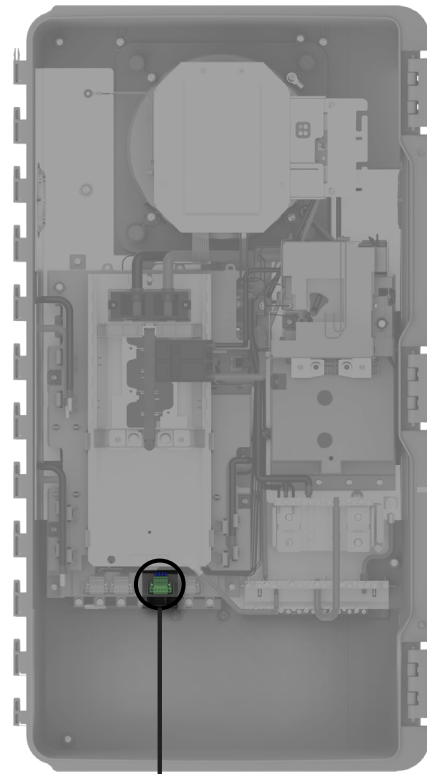
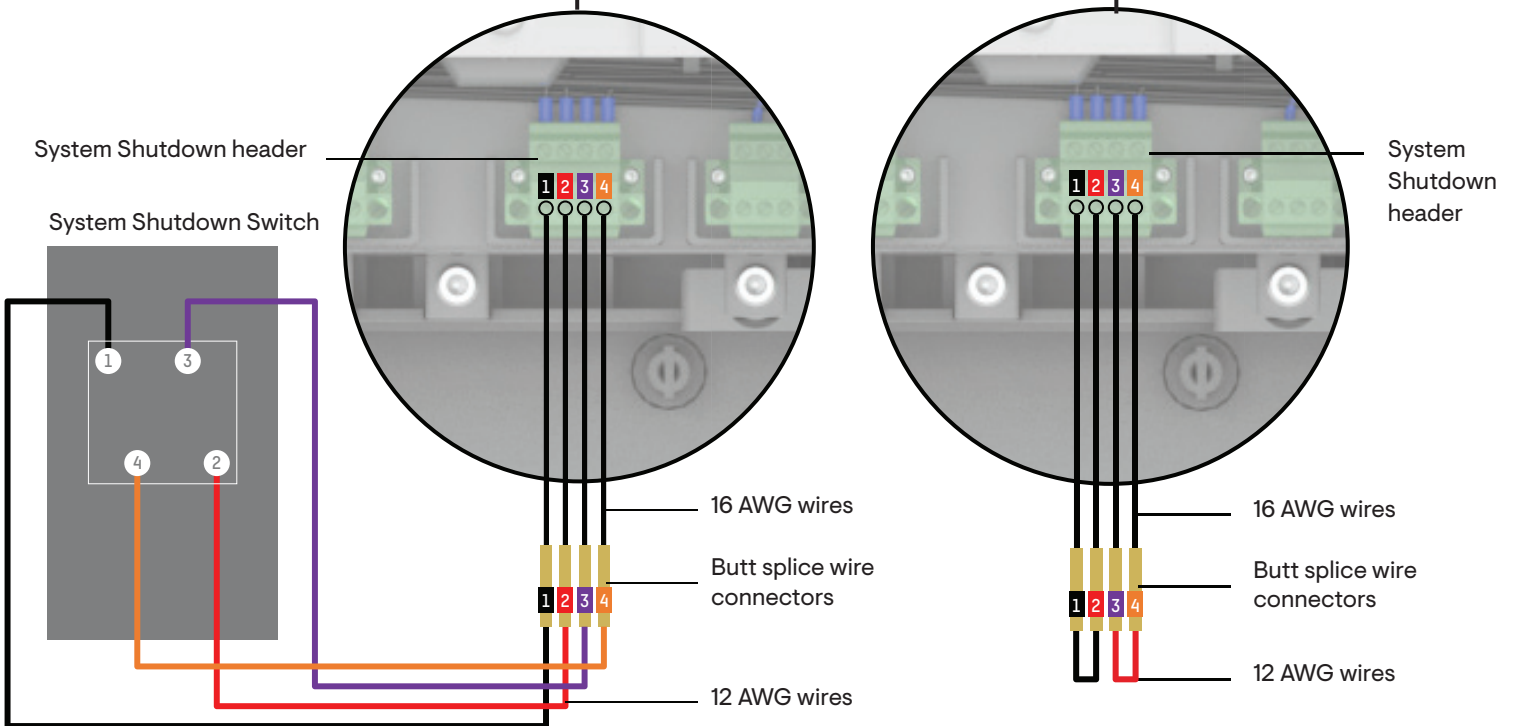

Figure 2: Wiring System Shutdown Switch



Wiring for systems with IQ8 Microinverters

Wiring for systems with non-IQ8 Microinverters



Revision history

REVISION	DATE	DESCRIPTION
DSH-00021-1.0	May 2023	Initial release

One Clamp Anywhere

The Multi-Clamp works as mid- or end-clamp, and fits standard 30-40mm frames.

Instant Bonding

The N-S Bonding Jumper bonds row to row with no tools.

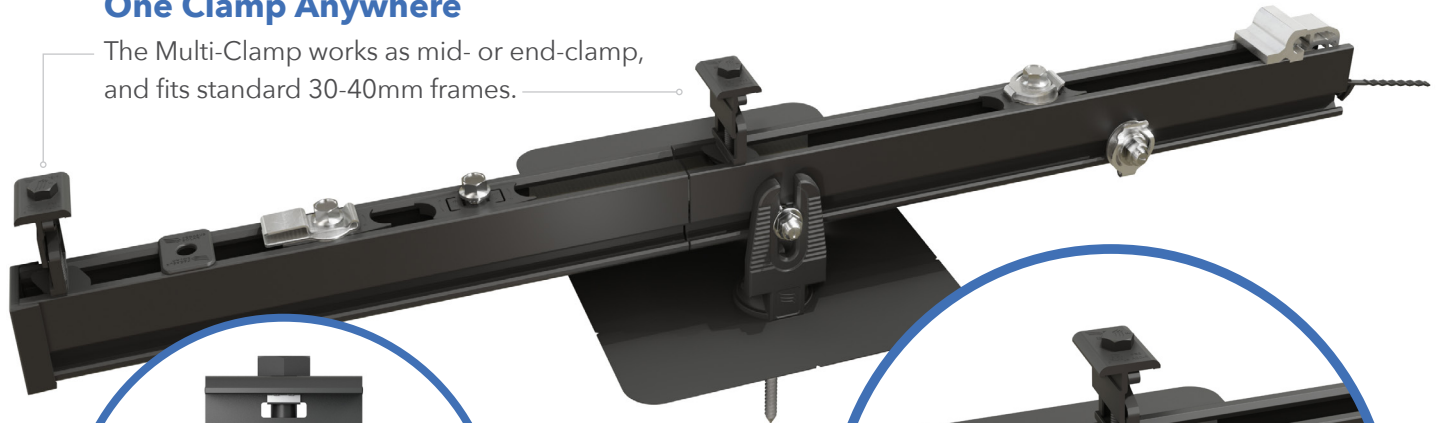

Lifetime Wire Management

Open rail channel holds and protects wires. Clamps won't pinch wires after tightening.

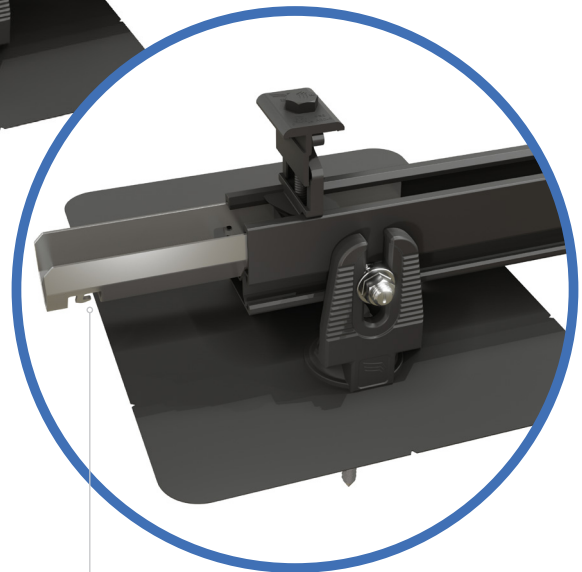

Bonding Structural Splice

Connect rails instantly, without tools, interference or limitations.

Next-Level Solar Mounting

A complete system for hassle-free rooftop installation, from watertight mounts to lifetime wire management.



Simplicity

1/2" socket for everything.
One clamp for mid or end.
No tool splicing and bonding.
Easy wire management.



Code Compliant

UL 2703 listed
LTR-AE-001-2012 listed
Class A fire rating for any slope
ASCE 7-16 PE Certified



Premium Aesthetics

The narrowest panel gap available. Optional Hidden End Clamps and End Caps provide a flush look on the edge of the array.



Watertight for Life

Secured on industry-leading Pegasus Mounts, for composite shingle and tile roofs. Backed by a 25-year warranty.

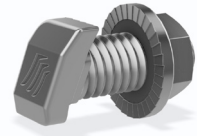
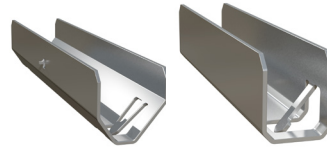
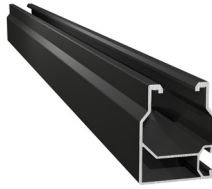

Pegasus Rail

Available in 14' and 7' lengths for easy layout and shipping.
Open-channel design holds MC4 connectors, PV wire and trunk cables.
Black and Mill finish

Pegasus Max Rail

Maximum-strength design.
Meets specifications for high snow-load and hurricane zones.
Black and Mill finish

Splice and Max Splice

Installs by hand.
Works over mounts.
Structurally connects and bonds rails automatically; UL2703 listed as reusable.

Dovetail T-bolt

Dovetail shape for extra strength.
Uses 1/2" socket.



Multi-Clamp

Fits 30-40mm PV frames, as mid- or end-clamp.
Twist-locks into position; doesn't pinch wires in rail.
Bonds modules to rail; UL2703 listed as reusable

Hidden End Clamp

Offers premium edge appearance.
Preinstalled pull-tab grips rail edge, allowing easy, one-hand installation.
Tucks away for reuse.

Ground Lug

Holds 6 or 8 AWG wire.
Mounts on top or side of rail.
Assembled on MLPE Mount.
UL2703 listed as reusable.

N-S Bonding Jumper

Installs by hand, eliminates row-to-row copper wire.
UL2703 listed as reusable only with Pegasus Rail.

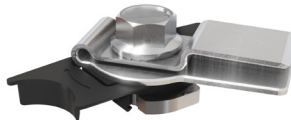
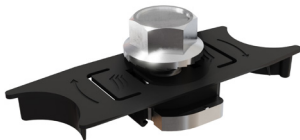

MLPE Mount

Secures and bonds most micro-inverters and optimizers to rail.
Connectors and wires easily route underneath after installation.
UL2703 listed as reusable.

Cable Grip

Secures four PV wires or two trunk cables.
Stainless-steel backing provides durable grip.
Eliminates sagging wires.

Wire Clip

Hand operable.
Holds wires in channel.
Won't slip.

End Cap and Max End Cap

Fits flush to PV module and hides raw or angled cuts.
Hidden drain quickly clears water from rail.

Certifications:

- UL 2703, Edition 1
- LTR-AE-001-2012
- ASCE 7-16 PE certified
- Class A fire rating for any slope roof



Quickly calculate the most efficient layout, spans and materials needed to suit your job. Visit the Pegasus Customer Portal. pegasussolar.com/portal

LOAD		SPAN			
SNOW (PSF)	WIND (MPH)	32"	4'	6'	8'
0	120	PEGASUS RAIL			
	160	PEGASUS RAIL			PEGASUS MAX RAIL
	190	PEGASUS RAIL		PEGASUS MAX RAIL	
15	140	PEGASUS RAIL			PEGASUS MAX RAIL
	160	PEGASUS RAIL		PEGASUS MAX RAIL	
30	160	PEGASUS RAIL		PEGASUS MAX RAIL	
	190	PEGASUS RAIL		PEGASUS MAX RAIL	
45	190	PEGASUS RAIL		PEGASUS MAX RAIL	
70	190	PEGASUS RAIL		PEGASUS MAX RAIL	
110	190	PEGASUS RAIL		PEGASUS MAX RAIL	

For reference only. Spans above are calculated using ASCE 7-16 for a Gable Roof, Exposure Category B, 7-20deg roof angle, 30ft mean roof height with non-exposed modules. For PE certified span tables, visit www.pegasussolar.com/spans.

Patents pending. All rights reserved. ©2021 Pegasus Solar Inc.

COMP MOUNT

One-Piece Flashing with Elevated Cone

No press-fits or deck-level EPDM washers to fail

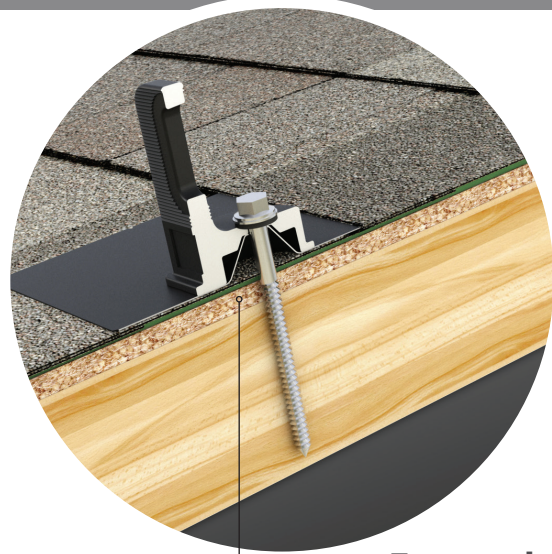

Encapsulating Design

Raises the water seal 0.9" Above roof deck



Simple 3-Piece Design Watertight For Life

Pegasus solar's comp mounts are a cost effective, high-quality option for rail installations on composition shingle roofs. Designed to last decades, the one-piece flashing with elevated cone means there is simply nothing to fail.



25-Year Warranty

Manufactured with advanced materials and coatings to outlast the roof itself



Code Compliant

Fully IBC/CBC Code Compliant
Exceeds ASCE 7-16 Standards



Superior Waterproofing

Tested to AC286 without sealant
Water seal elevated 0.9" above



All-In-One Kit Packaging

Flashings, L-Feet and SS lags with bonded EPDM washers are included in each 24-pack

1

Drill pilot hole in the center of the rafter.

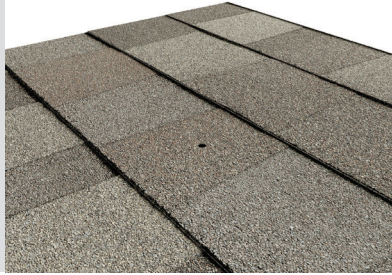
2

Optional: Apply a "u-shape" of sealant to the underside of the flashing and position under 2nd shingle course, cone over pilot hole.

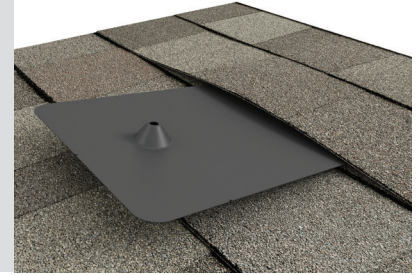
3

Place L-Foot over cone and install lag with washer through L-Foot.

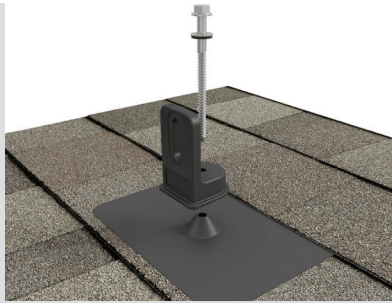
4

Drive lag to required depth. Attach rail per rail manufacturer's instructions.

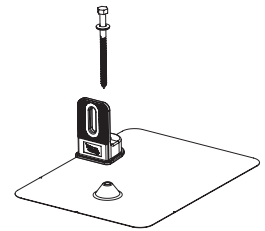
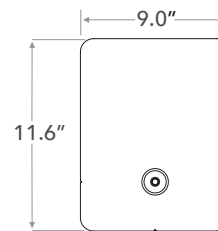
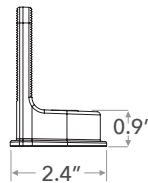
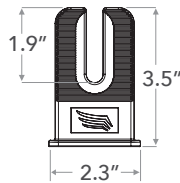
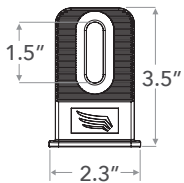
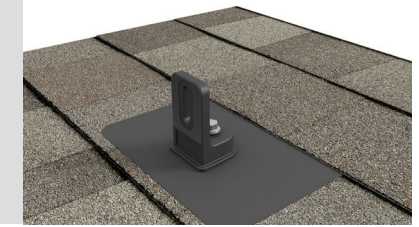

SPECIFICATIONS	COMP MOUNT INSTALL KITS				
SKU	PSCR-CBB0	PSCR-UBB0	SPCR-CBBH	PSCR-CMM0	PSCR-UMM0
Finish	Black L-Foot And Black Flashing			Mill	
L-Foot Type	Closed Slot	Open Slot	Closed Slot	Closed Slot	Open Slot
Kit Contents	L-Foot, Flashing, 5/16" x 4 1/2" SS Lag with metalized EPDM washer	L-Foot, Flashing, 5/16" x 4 1/2" SS Lag with metalized EPDM washer and M10 Hex Bolt	L-Foot, Flashing, 5/16" x 4 1/2" SS Lag with metalized EPDM washer	L-Foot, Flashing, 5/16" x 4 1/2" SS Lag with metalized EPDM washer	L-Foot, Flashing, 5/16" x 4 1/2" SS Lag with metalized EPDM washer
Roof Type	Composition Shingle				
Certifications	IBC, ASCE/SEI 7-16, AC286				
Install Application	Railed Systems				
Compatible Rail	Most				
Kit Quantity	24				
Boxes per Pallet	72				

Protected under US Patent: 10,998,847. Additional patents pending. All rights reserved. ©2021 Pegasus

SolaDeck

PV ROOF-MOUNT ENCLOSURE

**INTRODUCED AT
*SOLAR POWER 2007***



UL50 Type 3R Enclosure • Stamped 18 gauge gal. steel • Powder coated finish • Weather tight



Enclosure Includes:

- Dual ground lug
- Universal DIN rail
- 1/2", 3/4" & 1" knockouts
- Wire strain relief clip
- Complete hardware package

PV Roof-Mount Combiner/Enclosure

Benefits

- The ability to prep the building is now possible
- Replaces several parts used today
- Provides professional looking install
- Saves time on install
- Allows for easy access
- Guaranteed seal to roof
- Low profile design

***For product information contact us at
(866) 367-7782***

www.commdeck.com



RSTC Enterprises, Inc
2219 Heimstead Road
Eau Claire, WI 54703
1 (866) 367 - 7782



SolaDeck Part # 780

Specifications:

18 Gauge Steel Base (1) and Cover (2)
Pre Punched 7 holes in base (1) for roof deck
Pre Punched 4 holes in base (1) and cover (2) for match
Draw Process both parts
Powder Coated to withstand 1000 hours Salt Spray (Primer Gray)
High UV resistance
15" x 15" flashing dimension
Cavity dimension 8"W x 9" L x 2.5"D
Approx. 162 Cubic inch equipment cavity
Norloked steel base plate (3) to drawn base (2)
Three knockout locations .5", .75" and 1"
3" DIN rail installed
Grounding Lug- Installed (In Equipment Cavity)
Wire Strain Relief Clip –Installed (In Equipment Cavity)
Hardware pack withstands 500 hours Salt Spray
7 - 2" Trusshead Screws
4 - .5" 8-32 thread cutting screws
4 - #10 Bonded Seal washers
1 – Foam closed Cell Seal
ETL Listed UL50 Type 3R

Total Weight 6.9 pounds each

Packaging:

Individually bagged and boxed
Box dimension 15.5"w x 16" L x 3" D
White Carton labeled with Cut out template
Print One Color - Black

Master Cartons of 6 Units each
Master Carton dimension 18.75"x16"x16.375"
Master Carton Weight – 42 pounds
18 Master Cartons per skid Approx 800 pounds with skid

Eaton DG223URB

Catalog Number: DG223URB

Eaton General duty non-fusible safety switch, single-throw, 100 A, NEMA 3R, Rainproof, Painted galvanized steel, Two-pole, Two-wire, 240 V



General specifications

Product Name

Eaton general duty non-fusible safety switch

Catalog Number

DG223URB

UPC

782114731154

Product Length/Depth

7.38 in

Product Height

19.25 in

Product Width

9.13 in

Product Weight

12 lb

Warranty

Eaton Selling Policy 25-000, one (1) year NEC 230.62 (C) Compliant Barrier from the date of installation of the Product or eighteen (18) months from the date of shipment of the Product, whichever occurs first.

Compliances

Certifications

UL Listed

Catalog Notes

WARNING! Switch is not approved for service entrance unless a neutral kit is installed.

Physical Attributes

Enclosure

NEMA 3R

Enclosure material

Painted galvanized steel

Fuse configuration

Non-fusible

Number Of Poles

Two-pole

Number of wires

2

Type

Non-fusible, single-throw

Performance Ratings

Amperage Rating

100A

Voltage rating

240V

Miscellaneous

Product Category

General duty safety switch

Resources

Multimedia

[Switching Devices Flex Center](#)

[Double Up on Safety](#)

Specifications and datasheets

[Eaton Specification Sheet - DG223URB](#)



Eaton Corporation plc
Eaton House
30 Pembroke Road
Dublin 4, Ireland
Eaton.com
© 2024 Eaton. All Rights Reserved.

Eaton is a registered trademark.

All other trademarks are property of their respective owners.



[Eaton.com/socialmedia](https://www.eaton.com/socialmedia)

Enphase P/N: EP200G-NA-02-RSD

IMO P/N: SI16-PEL64R-2-ENP



Key Features

- Enclosed Solar Isolator
- 600VDC, 16A
- IP66 / NEMA 4X Protection Rating
- 2 Pole, 1 String
- Grey/Black Enclosure Cover & Handle



Technical Data for DC

Main Contacts	DC	Units	SI16 DC-PV1 (acc. to IEC 60947-3)	SI16 (acc. to UL508i)
Rated Thermal Current I_{the}		A		16
Rated Insulation Voltage UI ¹⁾		V		1000
Rated Insulation Voltage UI ²⁾		V		1500
Distance of Contacts (per pole)		mm		8
Rated Operational Current I_s	300V	A	16	16
	350V	A	16	16
	400V	A	16	16
	500V	A	16	16
	600V	A	16	16
Rated Conditional Short Circuit Current		kA _{eff}		5
Max. Fuse Size	gL (gG)	A		40
Mechanical Life		Ops		10,000
Rated Short-time Withstand Current (1s) I_{cw}		A		800
Short Circuit Making Capacity I_{cw}		A		800
Size of Terminal Screw				M4 Pz2
Cable Cross Sections (solid or stranded)		mm / AWG		4 - 16 / 12-10
Tightening Torque		Nm / lb.in		1.7 - 1.8 / 9 - 16
Maximum Operation Ambient Temperature		°C		-40 to +45
Maximum Storage Ambient Temperature		°C		-50 to +90
Power Loss at I_{onmax}		(A) / W		(16) / 1

Contact Resistance per pole 1.75mΩ

1) Suitable at overvoltage category I to III, pollution degree 3 (standard-industry): Uimp = 8kV.

2) Suitable at overvoltage category I to III, pollution degree 2 (min. IP55): Uimp = 8kV.

Dimensions (mm)

