

# ROOF MOUNT PHOTOVOLTAIC SYSTEM

**CODES:**

THIS PROPOSED INSTALLATION COMPLIES WITH THE FOLLOWING:  
 2018 NORTH CAROLINA BUILDING CODE  
 2018 NORTH CAROLINA RESIDENTIAL CODE  
 2018 NORTH CAROLINA PLUMBING CODE  
 2018 NORTH CAROLINA MECHANICAL CODE  
 2018 NORTH CAROLINA FUEL GAS CODE  
 2020 NATIONAL ELECTRICAL CODE  
 AS ADOPTED BY COUNTY OF HARNETT

**CONSTRUCTION NOTES:**

CONDUIT AND CONDUCTOR SPECIFICATIONS ARE BASED ON MINIMUM CODE REQUIREMENTS AND ARE NOT MEANT TO LIMIT UP-SIZING AS REQUIRED BY FIELD CONDITIONS.

ALL SOLAR ENERGY SYSTEM EQUIPMENT SHALL BE SCREENED TO THE MAXIMUM EXTENT POSSIBLE AND SHALL BE PAINTED A COLOR SIMILAR TO THE SURFACE UPON WHICH THEY ARE MOUNTED.

MODULES SHALL BE TESTED , LISTED AND IDENTIFIED WITH FIRE CLASSIFICATION IN ACCORDANCE WITH UL 2703. SMOKE AND CARBON MONOXIDE ALARMS ARE REQUIRED PER SECTION R314 AND 315 TO BE VERIFIED AND INSPECTED BY INSPECTOR IN THE FIELD.

DIG ALERT (811) TO BE CONTACTED AND COMPLIANCE WITH EXCAVATION SAFETY PRIOR TO ANY EXCAVATION TAKING PLACE

PHOTOVOLTAIC SYSTEM GROUND WILL BE TIED INTO EXISTING GROUND AT MAIN SERVICE FROM DC DISCONNECT/INVERTER AS PER 2020 NEC SEC 250.166(A).

SOLAR PHOTOVOLTAIC SYSTEM EQUIPMENT WILL BE INSTALLED IN ACCORDANCE WITH REQUIREMENTS OF ART. 690 OF THE 2020 NEC

THE MAIN SERVICE PANEL WILL BE EQUIPPED WITH A GROUND ROD OR UFER

UTILITY COMPANY WILL BE NOTIFIED PRIOR TO ACTIVATION OF THE SOLAR PV SYSTEM

SOLAREEDGE OPTIMIZERS ARE LISTED TO IEC 62109-1 (CLASS II SAFETY) AND UL 1741 STANDARDS

INSTALL CREW TO VERIFY ROOF STRUCTURE PRIOR TO COMMENCING WORK. EMT CONDUIT ATTACHED TO THE ROOF USING CONDUIT MOUNT.

**VICINITY MAP:**

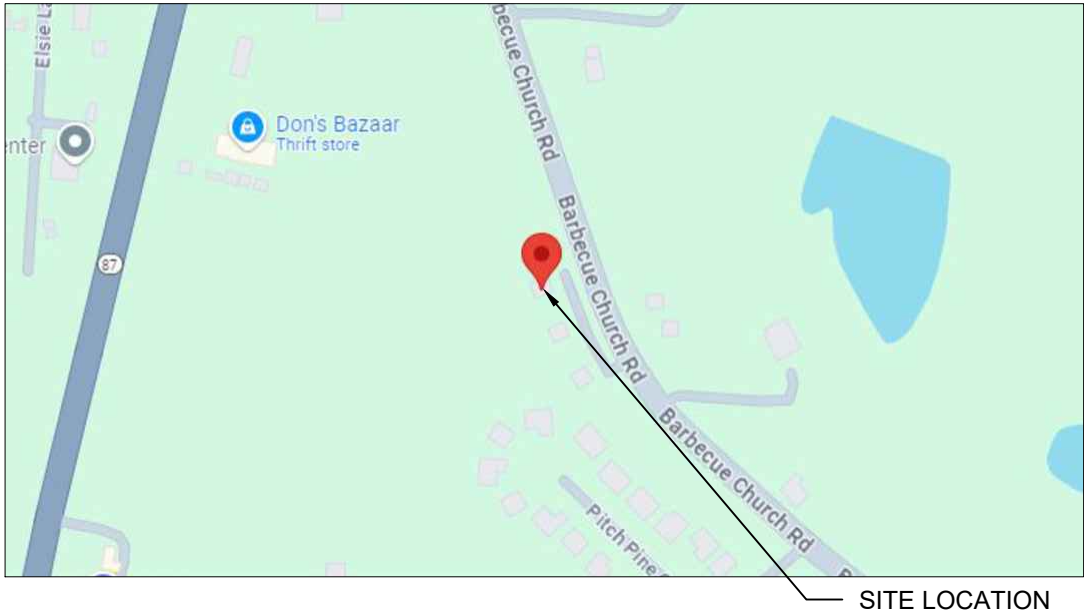

SITE LOCATION

**TABLE OF CONTENTS:**

PV-1	PROJECT DETAILS
PV-2	SITE PLAN
PV-2A	ROOF PLAN WITH MODULES LAYOUT
PV-2B	ARRAY DETAILS
PV-3	MOUNTING DETAILS
PV-4	THREE LINE DIAGRAM
PV-5	CONDUCTOR CALCULATIONS
PV-6	EQUIPMENT & SERVICE LIST
PV-7	LABELS
PV-7A	SITE PLACARD
PV-8	OPTIMIZER CHART
PV-9	SAFETY PLAN
PV-10	SAFETY PLAN
APPENDIX	MANUFACTURER SPECIFICATION SHEETS

**CLIENT:**  
 STEPHEN STEWARD  
 4943 BARBECUE CHURCH RD, SANFORD, NC 27332  
 AHJ: COUNTY OF HARNETT  
 UTILITY: DUKE ENERGY  
 APN: 039569 0012 05  
 EMAIL: SMSTEWA4@PROTON.ME  
 FINANCE: MOSAIC

**SYSTEM:**  
 SYSTEM SIZE (DC): 16 X 410 = 6.560 kW  
 SYSTEM SIZE (AC): 5.000 kW @ 240V  
 MODULES: 16 X TRINA: TSM-410NE09RC.05  
 OPTIMIZERS: 16 X SOLAREEDGE S440  
 INVERTER: SOLAREEDGE SE5000H-USRGM [S11]











REVISIONS		
NO.	REVISED BY	DATE
-	-	-
-	-	-
-	-	-



**freedom FOREVER**  
 FREEDOM FOREVER LLC  
 902 PURSER DRIVE, RALEIGH, SC 27603  
 Tel: (800) 385-1075  
**GREG ALBRIGHT**  
  
 CONTRACTOR LICENSE:  
 ELECTRICAL CONTRACTOR U.34043

PROJECT DETAILS			
JOB NO:	DATE:	DESIGNED BY:	SHEET:
518972	11/19/2024	P.O.	PV-1

**LEGEND:**

-  CHIMNEY
-  PIPE VENT
-  MODULES
-  CONDUIT
-  SETBACK
-  AC DISCONNECT
-  UTILITY METER
-  JUNCTION BOX
-  INVERTER
-  MAIN SERVICE PANEL

**TOTAL ROOF AREA RIDGE SETBACK CALCS:**  
 TOTAL ROOF AREA: 1372.68 SQ FT  
 SINGLE MODULE AREA: 21.50763451 SQ FT  
 TOTAL NUMBER OF MODULES: 16  
 TOTAL AREA OF MODULES: 344.12 SQ FT  
 ROOF COVERAGE: 25.07%  
 FIRE SPRINKLERS : NO

**THIS SYSTEM DESIGNED WITH:**  
 WIND SPEED: 130  
 WIND EXPOSURE: B  
 SNOW LOAD: 15

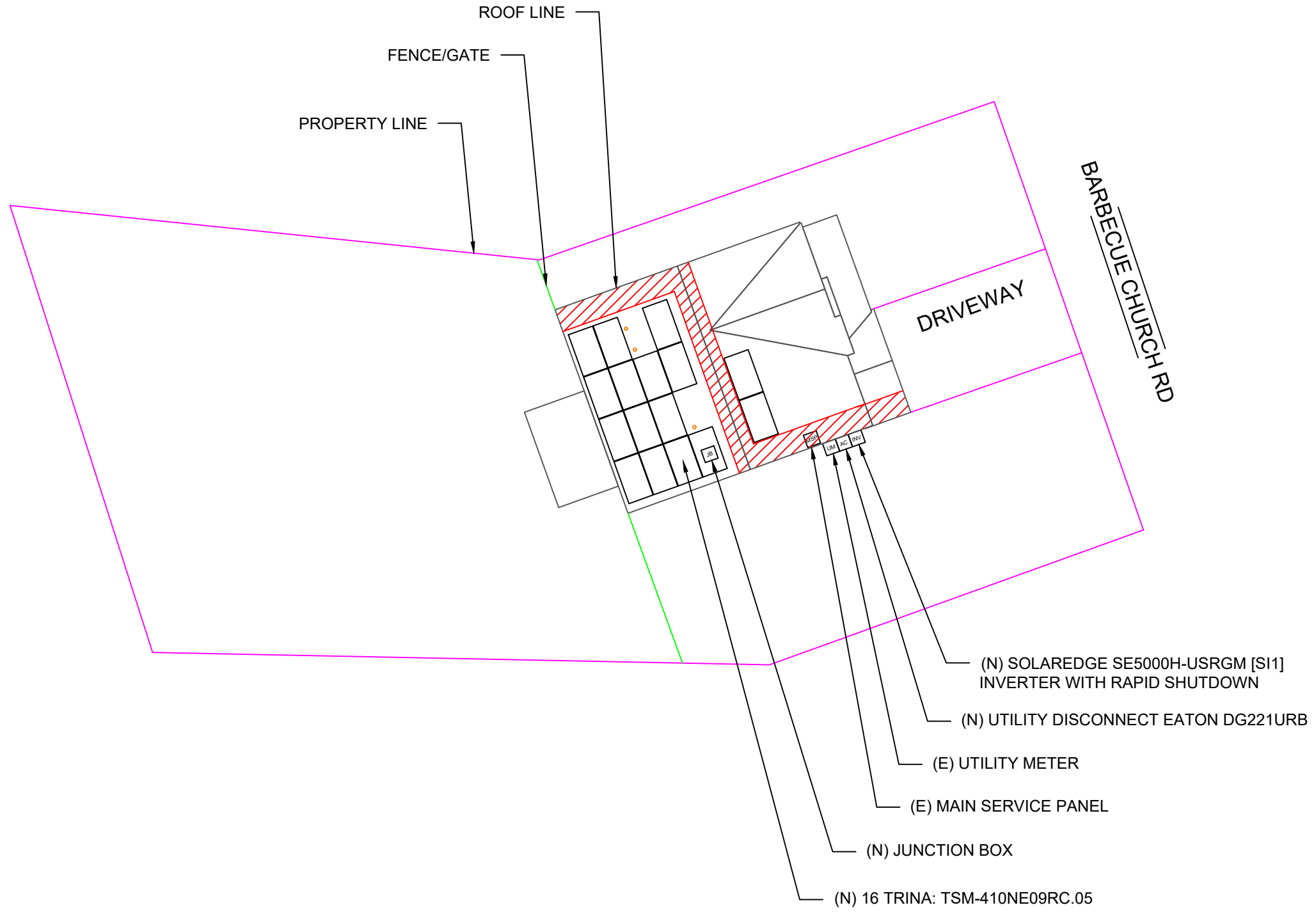

**PV SYSTEM**  
 6.560 kW-DC  
 5.000 kW-AC

ROOF AREA: 1372.68 SQ FT

**CLIENT:**  
 STEPHEN STEWARD  
 4943 BARBECUE CHURCH RD, SANFORD, NC 27332  
 AHJ: COUNTY OF HARNETT  
 UTILITY: DUKE ENERGY  
 APN: 039569 0012 05  
 EMAIL: SMSTEWA4@PROTON.ME  
 FINANCE: MOSAIC

**SYSTEM:**  
 SYSTEM SIZE (DC): 16 X 410 = 6.560 kW  
 SYSTEM SIZE (AC): 5.000 kW @ 240V  
 MODULES: 16 X TRINA: TSM-410NE09RC.05  
 OPTIMIZERS: 16 X SOLAREEDGE S440  
 INVERTER: SOLAREEDGE SE5000H-USRGM [S11]

REVISIONS		
NO.	REVISED BY	DATE
-	-	-
-	-	-
-	-	-



**FREEDOM FOREVER LLC**  
 902 PURSER DRIVE, RALEIGH, SC 27603  
 Tel: (800) 385-1075  
**GREG ALBRIGHT**

*Greg Albright*

**CONTRACTOR LICENSE:**  
 ELECTRICAL CONTRACTOR U.34043

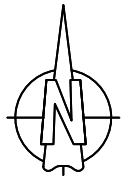







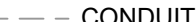

**SITE PLAN**  
 SCALE: 1/16" = 1'-0"

1

SITE PLAN			
JOB NO:	DATE:	DESIGNED BY:	SHEET:
518972	11/19/2024	P.O.	PV-2

**LEGEND:**

-  CHIMNEY
-  PIPE VENT
-  MODULES
-  CONDUIT
-  SETBACK
-  AC DISCONNECT
-  UTILITY METER
-  JUNCTION BOX
-  INVERTER
-  MAIN SERVICE PANEL

THIS SYSTEM DESIGNED WITH:  
 WIND SPEED: 130  
 WIND EXPOSURE: B  
 SNOW LOAD: 15

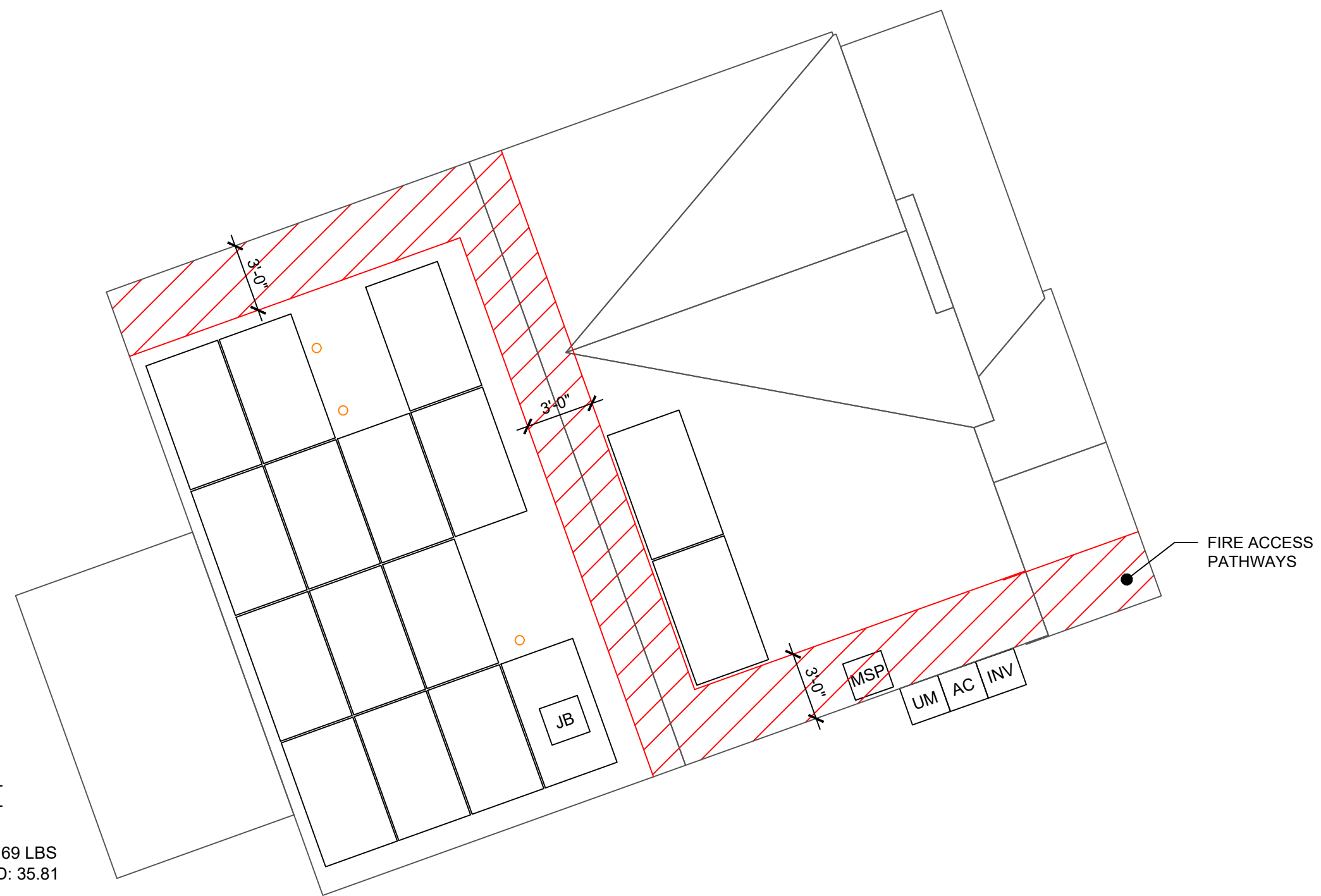

TOTAL ROOF AREA: 1372.68 SQ FT  
 TOTAL ARRAY AREA: 344.12 SQ FT  
 ARRAY COVERAGE: 25.07%  
 SYSTEM DISTRIBUTED WEIGHT: 2.69 LBS  
 ROCKIT SMART SLIDE POINT-LOAD: 35.81 LBS

**PV SYSTEM**  
 6.560 kW-DC  
 5.000 kW-AC

ROOF AREA: 1372.68 SQ FT

**CLIENT:**  
 STEPHEN STEWARD  
 4943 BARBECUE CHURCH RD, SANFORD, NC 27332  
 AHJ: COUNTY OF HARNETT  
 UTILITY: DUKE ENERGY  
 APN: 039569 0012 05  
 EMAIL: SMSTEW4@PROTON.ME  
 FINANCE: MOSAIC

**SYSTEM:**  
 SYSTEM SIZE (DC): 16 X 410 = 6.560 kW  
 SYSTEM SIZE (AC): 5.000 kW @ 240V  
 MODULES: 16 X TRINA: TSM-410NE09RC.05  
 OPTIMIZERS: 16 X SOLAREEDGE S440  
 INVERTER: SOLAREEDGE SE5000H-USRGM [S11]

REVISIONS		
NO.	REVISED BY	DATE
-	-	-
-	-	-
-	-	-



FREEDOM FOREVER LLC  
 902 PURSER DRIVE, RALEIGH, SC 27603  
 Tel: (800) 385-1075  
 GREG ALBRIGHT

CONTRACTOR LICENSE:  
 ELECTRICAL CONTRACTOR U.34043



**ROOF PLAN**  
 SCALE: 3/16" = 1'-0"

1

- NOTES:**
- EMT CONDUIT ATTACHED TO THE ROOF USING CONDUIT MOUNTS
  - ATTACHED CLAMPS AT 25% FROM THE EDGE AND 50% FROM THE CENTER OF THE MODULES
  - JUNCTION BOX IS MOUNTED TO THE RAIL.

ROOF PLAN WITH MODULES LAYOUT

JOB NO: 518972	DATE: 11/19/2024	DESIGNED BY: P.O.	SHEET: PV-2A
-------------------	---------------------	----------------------	-----------------

# ROOF DETAILS:

TOTAL ROOF AREA: 1372.68 SQ FT  
 TOTAL ARRAY AREA: 344.12 SQFT  
 ARRAY COVERAGE: 25.07%  
 SYSTEM DISTRIBUTED WEIGHT: 2.69 LBS  
 ROCKIT SMART SLIDE POINT-LOAD: 35.81 LBS

ROOF AREA STATEMENT						
ROOF	MODULE QUANTITY	ROOF PITCH	ARRAY PITCH	AZIMUTH	ROOF AREA	ARRAY AREA
ROOF 1	14	26	26	250.3	530.39 SQ FT	301.11 SQ FT
ROOF 2	2	26	26	70.3	369.97 SQ FT	43.02 SQ FT
----	----	----	----	----	SQ FT	SQ FT
----	----	----	----	----	SQ FT	SQ FT
----	----	----	----	----	SQ FT	SQ FT
----	----	----	----	----	SQ FT	SQ FT
----	----	----	----	----	SQ FT	SQ FT
----	----	----	----	----	SQ FT	SQ FT
----	----	----	----	----	SQ FT	SQ FT
----	----	----	----	----	SQ FT	SQ FT

**CLIENT:**  
 STEPHEN STEWARD  
 4943 BARBECUE CHURCH RD, SANFORD, NC 27332  
 AHJ: COUNTY OF HARNETT  
 UTILITY: DUKE ENERGY  
 APN: 039569 0012 05  
 EMAIL: SMSTEW4@PROTON.ME  
 FINANCE: MOSAIC

**SYSTEM:**  
 SYSTEM SIZE (DC): 16 X 410 = 6.560 kW  
 SYSTEM SIZE (AC): 5.000 kW @ 240V  
 MODULES: 16 X TRINA: TSM-410NE09RC.05  
 OPTIMIZERS: 16 X SOLAREEDGE S440  
 INVERTER: SOLAREEDGE SE5000H-USRGM [S1]

REVISIONS		
NO.	REVISED BY	DATE
-	-	-
-	-	-
-	-	-



**FREEDOM FOREVER LLC**  
 902 PURSER DRIVE, RALEIGH, SC 27603  
 Tel: (800) 385-1075  
**GREG ALBRIGHT**

**CONTRACTOR LICENSE:**  
 ELECTRICAL CONTRACTOR U.34043

ARRAY DETAILS			
JOB NO:	DATE:	DESIGNED BY:	SHEET:
518972	11/19/2024	P.O.	PV-2B

TABLE 1 – ARRAY INSTALLATION

	ROOF PITCH	ROOFING TYPE	ATTACHMENT TYPE	FRAMING TYPE	MAX UNBRACED LENGTH(FT.)	STRUCTURAL ANALYSIS RESULT	PENETRATION PATTERN	MAX ATTACHMENT SPACING (IN.)	MAX RAIL OVERHANG(IN. N.)
ROOF 1	26	Comp Shingle	Ecofasten Rockit Smart Slide	2x6 @ 24" O.C.	7	PASS	STAGGERED	72	24
ROOF 2	26	Comp Shingle	Ecofasten Rockit Smart Slide	2x6 @ 24" O.C.	7	PASS	STAGGERED	72	24

1. CONTRACTOR TO VERIFY FRAMING TYPE AND MAX UNBRACED LENGTH PRIOR TO INSTALLATION. IF THE ABOVE INFORMATION DOES NOT MATCH FIELD CONDITIONS, NOTIFY ENGINEER OF RECORD IMMEDIATELY.
2. WHERE COLLAR TIES OR RAFTER SUPPORTS EXIST, CONTRACTOR SHALL USE RAFTERS WITH COLLAR TIES AS ATTACHMENT POINTS.
3. MAX RAIL OVERHANG APPLICABLE FOR RAILED ATTACHMENT INSTALLATIONS.

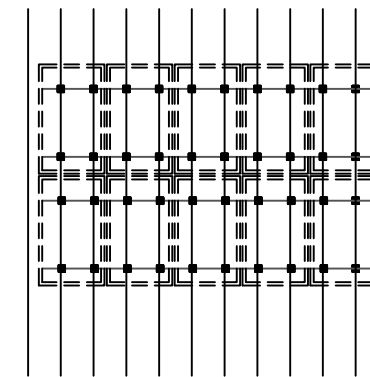

STACKED DETAIL

For Illustration purposes only

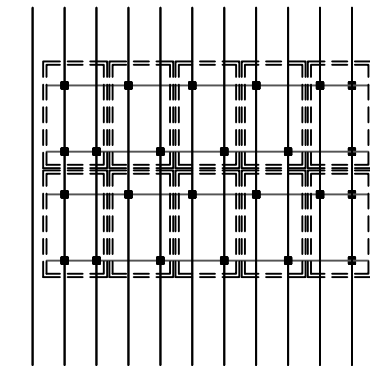

STAGGERED DETAIL

For Illustration purposes only

CLIENT:  
 STEPHEN STEWARD  
 4943 BARBECUE CHURCH RD, SANFORD, NC 27332  
 AHJ: COUNTY OF HARNETT  
 UTILITY: DUKE ENERGY  
 APN: 039569 0012 05  
 EMAIL: SMSTEWA4@PROTON.ME  
 FINANCE: MOSAIC

SYSTEM:  
 SYSTEM SIZE (DC): 16 X 410 = 6.560 kW  
 SYSTEM SIZE (AC): 5.000 kW @ 240V  
 MODULES: 16 X TRINA: TSM-410NE09RC.05  
 OPTIMIZERS: 16 X SOLAREEDGE S440  
 INVERTER: SOLAREEDGE SE5000H-USRGM [S1]

REVISIONS		
NO.	REVISED BY	DATE
-	-	-
-	-	-
-	-	-



FREEDOM FOREVER LLC  
 902 PURSER DRIVE, RALEIGH, SC 27603  
 Tel: (800) 385-1075  
 GREG ALBRIGHT

CONTRACTOR LICENSE:  
 ELECTRICAL CONTRACTOR U.34043

MOUNTING DETAILS

JOB NO: 518972	DATE: 11/19/2024	DESIGNED BY: P.O.	SHEET: PV-3
-------------------	---------------------	----------------------	----------------

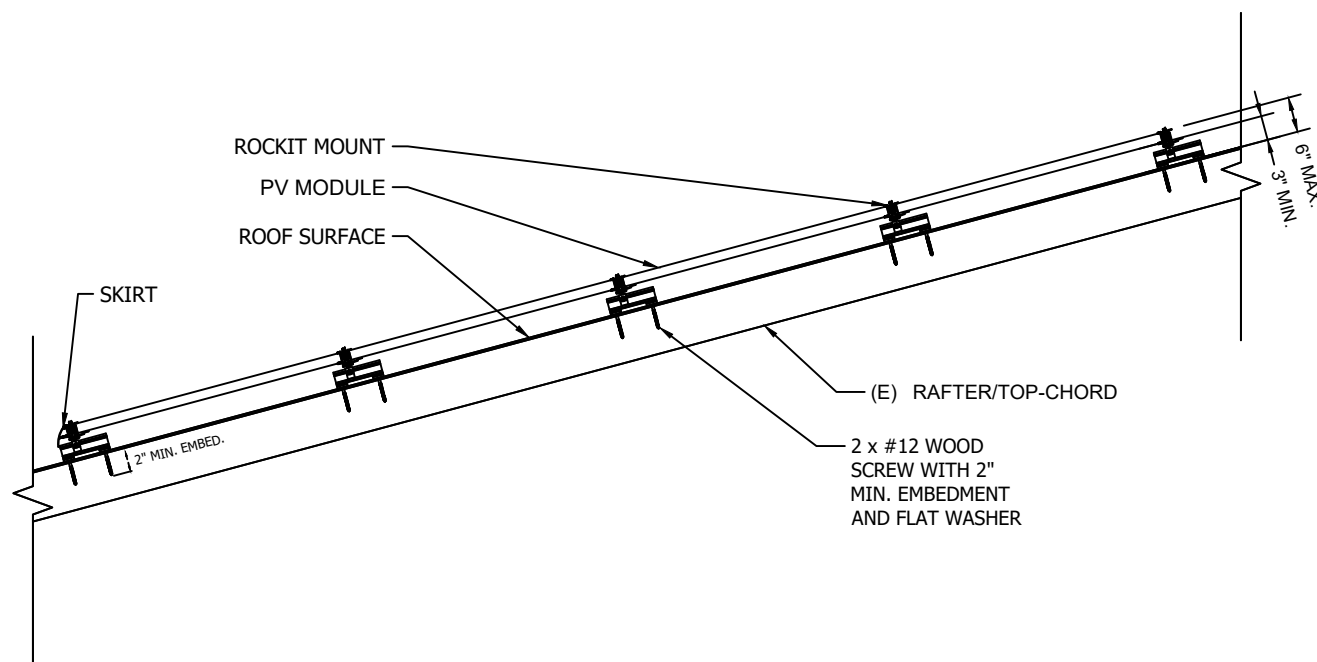

SOLAR PV ARRAY SECTION VIEW

Scale: NTS

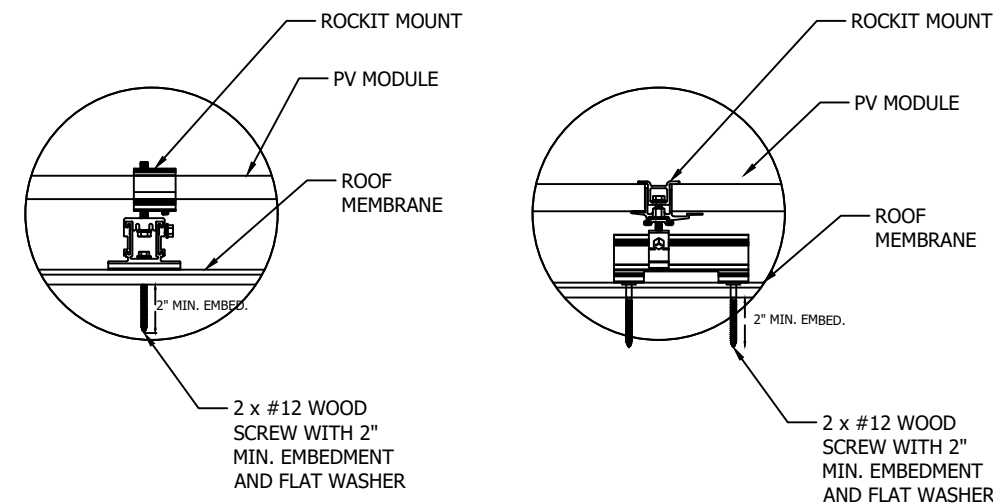

ATTACHMENT DETAIL

Scale: NTS

BACKFEED BREAKER SIZING					
MAX. CONTINUOUS OUTPUT 21.00A @ 240V					
21.00	X	1.25	=	26.25AMPS	30A BREAKER - OK
SEE 705.12 OF 2020 NEC					
225	X	1.20	=	270	
270	-	200	=	70A ALLOWABLE BACKFEED	

**PV SYSTEM**  
**6.560 kW-DC**  
**5.000 kW-AC**

**CLIENT:**  
STEPHEN STEWARD  
4943 BARBECUE CHURCH RD, SANFORD, NC 27332  
AHJ: COUNTY OF HARNETT  
UTILITY: DUKE ENERGY  
APN: 039569 0012 05  
EMAIL: SMSTEWA4@PROTON.ME  
FINANCE: MOSAIC

**SYSTEM:**  
SYSTEM SIZE (DC): 16 X 410 = 6.560 kW  
SYSTEM SIZE (AC): 5.000 kW @ 240V  
MODULES: 16 X TRINA: TSM-410NE09RC.05  
OPTIMIZERS: 16 X SOLAREEDGE S440  
INVERTER: SOLAREEDGE SE5000H-USRGM [S11]

REVISIONS		
NO.	REVISED BY	DATE
-	-	-
-	-	-
-	-	-



**FREEDOM FOREVER LLC**  
902 PURSER DRIVE, RALEIGH, SC 27603  
Tel: (800) 385-1075

**GREG ALBRIGHT**

*Greg Albright*

**CONTRACTOR LICENSE:**  
ELECTRICAL CONTRACTOR U.34043

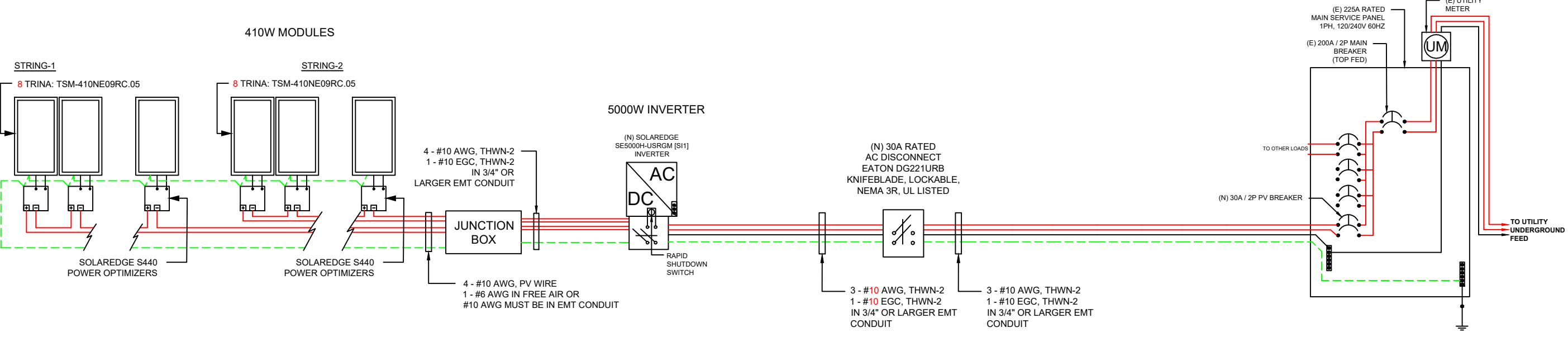

**NOTE:**  
CONDUIT AND CONDUCTORS SPECIFICATIONS ARE BASED ON MINIMUM CODE REQUIREMENTS AND ARE NOT MEANT TO LIMIT UP-SIZING AS REQUIRED BY FIELD CONDITIONS

THREE LINE DIAGRAM

JOB NO:	DATE:	DESIGNED BY:	SHEET:
518972	11/19/2024	P.O.	PV-4







**MAIN PHOTOVOLTAIC SYSTEM DISCONNECT**  
690.13(B)

**DO NOT DISCONNECT UNDER LOAD**  
NEC 690.15 (B) & NEC 690.33(D)(2)

**WARNING**  
SINGLE 120-VOLT SUPPLY  
DO NOT CONNECT  
MULTIWIRE BRANCH CIRCUITS  
NEC 710.15(C) & 692.9 (C)

**WARNING DUAL POWER SOURCE**  
SECOND SOURCE IS PHOTOVOLTAIC SYSTEM  
NEC 705.12(D) & NEC 690.59

**WARNING**  
TURN OFF PHOTOVOLTAIC  
AC DISCONNECT PRIOR TO  
WORKING INSIDE PANEL  
NEC 110.27(C) & OSHA 1910.145(F)(7)

**WARNING**  
ELECTRICAL SHOCK HAZARD  
TERMINALS ON THE LINE AND  
LOAD SIDES MAY BE ENERGIZED  
IN THE OPEN POSITION  
706.15(C)(4) & 690.13(B)

**WARNING**  
THIS EQUIPMENT FED BY  
MULTIPLE SOURCES:  
TOTAL RATING OF ALL OVERCURRENT  
DEVICES EXCLUDING MAIN POWER  
SUPPLY SHALL NOT EXCEED  
AMPACITY OF BUSBAR  
NEC 705.12(B)(3)(3)

**WARNING**  
THE DISCONNECTION OF THE  
GROUNDED CONDUCTOR(S)  
MAY RESULT IN OVERVOLTAGE  
ON THE EQUIPMENT  
NEC 690.31(E)

**RAPID SHUTDOWN SWITCH FOR  
SOLAR PV SYSTEM**  
690.56(C)(3)

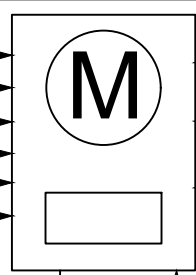

**SOLAR PV SYSTEM EQUIPPED WITH RAPID SHUTDOWN**

TURN RAPID SHUTDOWN SWITCH TO THE "OFF" POSITION TO SHUT DOWN PV SYSTEM AND REDUCE SHOCK HAZARD IN THE ARRAY

IFC 605.11.3.1(1) & 690.56(C)

**CAUTION**  
PHOTOVOLTAIC SYSTEM CIRCUIT IS BACKFED  
NEC 705.12(D) & NEC 690.59

**WARNING**  
POWER SOURCE OUTPUT CONNECTION. DO NOT RELOCATE THIS OVERCURRENT DEVICE.  
NEC 705.12(C) & NEC 690.59

**WARNING**  
ARC FLASH AND SHOCK HAZARD  
APPROPRIATE PPE REQUIRED  
24 INCH FLASH HAZARD BOUNDARY  
3 CALCMF2 FLASH HAZARD AT 18 INCHES  
480 VAC SHOCK HAZARD WHEN COVER IS REMOVED  
42 INCH LIMITED APPROACH  
12 INCH RESTRICTED APPROACH - 500 V CLASS 00 GLOVES  
1 INCH PROHIBITED APPROACH - 500 V CLASS 00 GLOVES  
LOCATION: 4943 BARBECUE CHURCH RD, SANFORD, NC 27332

**PHOTOVOLTAIC AC DISCONNECT**  
NEC 690.13(B)

**PHOTOVOLTAIC AC DISCONNECT**  
RATED AC OUTPUT CURRENT: **21.00A**  
NOMINAL OPERATING AC VOLTAGE: **240V**  
NEC 690.54

**WARNING DUAL POWER SOURCE**  
SECOND SOURCE IS PHOTOVOLTAIC SYSTEM  
NEC 705.12(D) & NEC 690.59

**SOLAR PV DC CIRCUIT**  
EVERY 10' ON CONDUIT AND ENCLOSURES  
NEC 690.31

**PHOTOVOLTAIC POWER SOURCE**  
EVERY 10' ON CONDUIT AND ENCLOSURES  
NEC 690.31(D)(2)

MAXIMUM VOLTAGE **480** V  
MAXIMUM CIRCUIT CURRENT **13.5** A  
MAX DC-DC CONVERTER OUTPUT CURRENT **15** A

**NOTES:**

- NEC ARTICLES 690 AND 705 AND IRC SECTION R324 MARKINGS SHOWN HEREON.
- ALL MARKING SHALL CONSIST OF THE FOLLOWING:
  - UV RESISTANT SIGN MATERIAL WITH ENGRAVED OR MACHINE PRINTED LETTERS OR ELECTRO-PLATING.
  - RED BACKGROUND COLOR WHITE TEXT AND LINE WORK.
  - ARIAL FONT.
- ALL SIGNS SHALL BE SIZED APPROPRIATELY AND PLACED IN THE LOCATIONS SPECIFIED. SIGNAGE CANNOT BE HAND-WRITTEN.
- SIGNS SHALL BE ATTACHED TO THE SERVICE EQUIPMENT WITH POP-RIVETS OR SCREWS

**PHOTOVOLTAIC DC DISCONNECT**  
NEC 690.13(B)

**MAXIMUM DC VOLTAGE OF PV SYSTEM**  
NEC 690.53

**WARNING**  
ELECTRICAL SHOCK HAZARD  
TERMINALS ON THE LINE AND LOAD SIDES MAY BE ENERGIZED IN THE OPEN POSITION  
DC VOLTAGE IS ALWAYS PRESENT WHEN SOLAR MODULES ARE EXPOSED TO SUNLIGHT  
706.15(C)(4) & 690.13(B)

**WARNING**  
ELECTRICAL SHOCK HAZARD  
TERMINALS ON THE LINE AND LOAD SIDES MAY BE ENERGIZED IN THE OPEN POSITION  
706.15(C)(4) & 690.13(B)

**WARNING**  
TURN OFF PHOTOVOLTAIC AC DISCONNECT PRIOR TO WORKING INSIDE PANEL  
NEC 110.27(C) & OSHA 1910.145(F)(7)

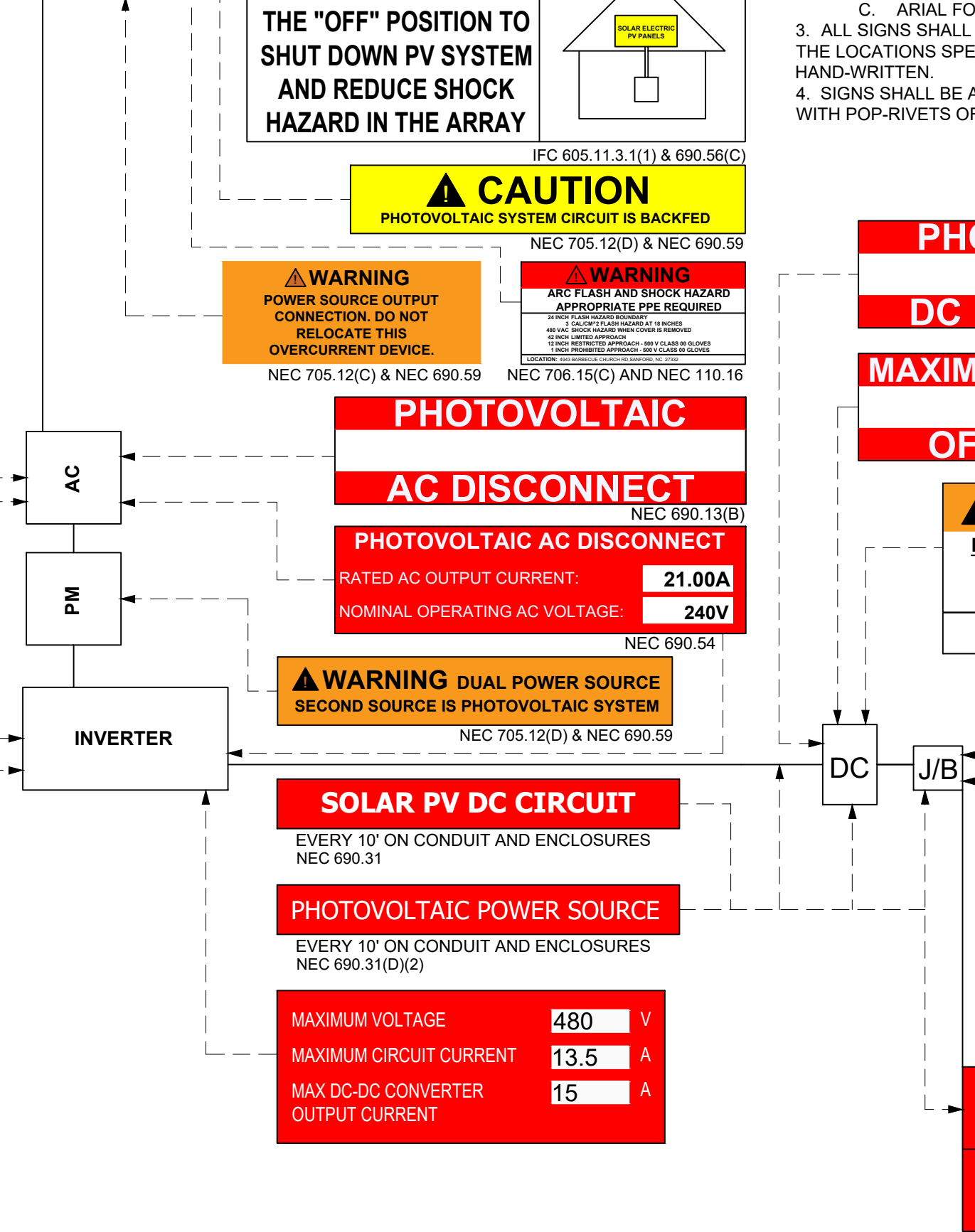
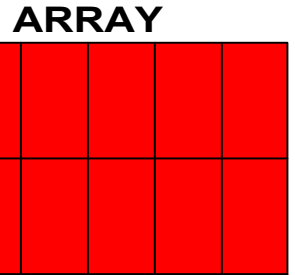

CLIENT:  
STEPHEN STEWARD  
4943 BARBECUE CHURCH RD, SANFORD, NC 27332  
AHJ: COUNTY OF HARNETT  
UTILITY: DUKE ENERGY  
APN: 039569 0012 05  
EMAIL: SMSTEW44@PROTON.ME  
FINANCE: MOSAIC

SYSTEM:  
SYSTEM SIZE (DC): 16 X 410 = 6.560 kW  
SYSTEM SIZE (AC): 5.000 kW @ 240V  
MODULES: 16 X TRINA: TSM-410NE09RC.05  
OPTIMIZERS: 16 X SOLAREEDGE S440  
INVERTER: SOLAREEDGE SE5000H-USRGM [S11]

REVISIONS		
NO.	REVISED BY	DATE
-	-	-
-	-	-
-	-	-



FREEDOM FOREVER LLC  
902 PURSER DRIVE, RALEIGH, SC 27603  
Tel: (800) 385-1075

GREG ALBRIGHT

*Greg Albright*

CONTRACTOR LICENSE:  
ELECTRICAL CONTRACTOR U.34043

LABELS			
JOB NO:	DATE:	DESIGNED BY:	SHEET:
518972	11/19/2024	P.O.	PV-7

# CAUTION:

POWER TO THIS BUILDING IS ALSO SUPPLIED FROM THE FOLLOWING SOURCES WITH DISCONNECTS AS SHOWN

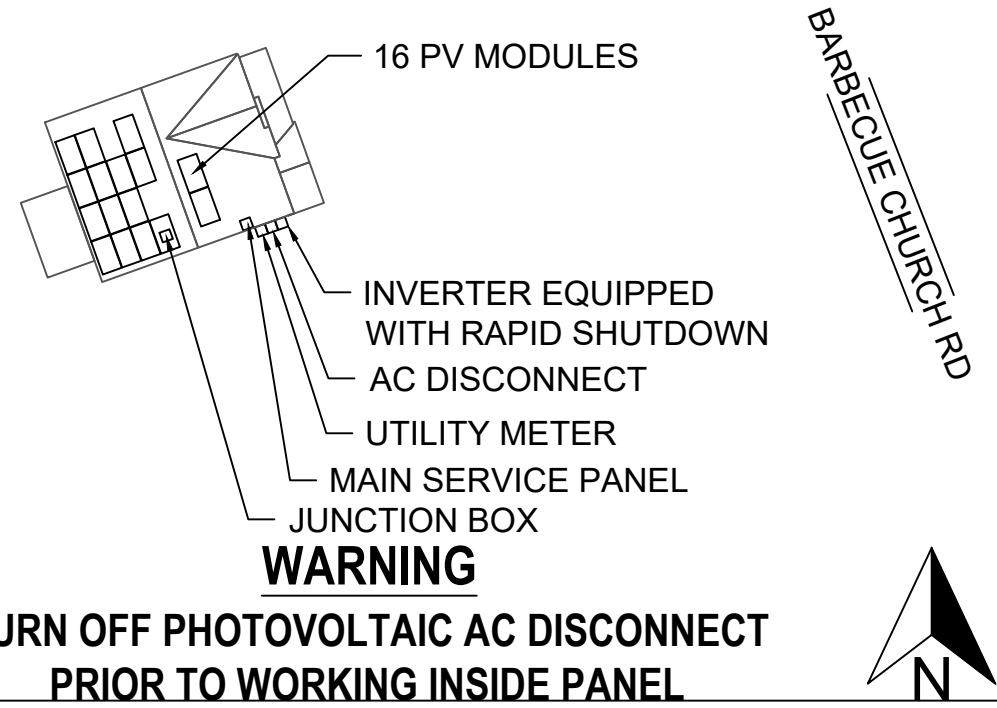

## WARNING

TURN OFF PHOTOVOLTAIC AC DISCONNECT PRIOR TO WORKING INSIDE PANEL

### NOTES:

1. NEC ARTICLES 690 AND 705 AND IRC SECTION R324 MARKINGS SHOWN HEREON.
2. ALL MARKING SHALL CONSIST OF THE FOLLOWING:
  - A. UV RESISTANT SIGN MATERIAL WITH ENGRAVED OR MACHINE PRINTED LETTERS OR ELECTRO-PLATING.
  - B. RED BACKGROUND COLOR WHITE TEXT AND LINE WORK.
  - C. AERIAL FONT.
3. ALL SIGNS SHALL BE SIZED APPROPRIATELY AND PLACED IN THE LOCATIONS SPECIFIED. SIGNAGE CANNOT BE HAND-WRITTEN.
4. SIGNS SHALL BE ATTACHED TO THE SERVICE EQUIPMENT WITH POP-RIVETS OR SCREWS.

**CLIENT:**  
 STEPHEN STEWARD  
 4943 BARBECUE CHURCH RD, SANFORD, NC 27332  
 AHJ: COUNTY OF HARNETT  
 UTILITY: DUKE ENERGY  
 APN: 039569 0012 05  
 EMAIL: SMSTEWA4@PROTON.ME  
 FINANCE: MOSAIC

**SYSTEM:**  
 SYSTEM SIZE (DC): 16 X 410 = 6.560 kW  
 SYSTEM SIZE (AC): 5.000 kW @ 240V  
 MODULES: 16 X TRINA: TSM-410NE09RC.05  
 OPTIMIZERS: 16 X SOLAREEDGE S440  
 INVERTER: SOLAREEDGE SE5000H-USRGM [S1]

REVISIONS		
NO.	REVISED BY	DATE
-	-	-
-	-	-
-	-	-



**FREEDOM FOREVER LLC**  
 902 PURSER DRIVE, RALEIGH, SC 27603  
 Tel: (800) 385-1075

**GREG ALBRIGHT**

**CONTRACTOR LICENSE:**  
 ELECTRICAL CONTRACTOR U.34043

SITE PLACARD			
JOB NO:	DATE:	DESIGNED BY:	SHEET:
518972	11/19/2024	P.O.	PV-7A

1-10    11-20    21-30    31-40    41-50    51-60

# SOLAREEDGE OPTIMIZER CHART

1

2

3

4

5

6

7

8

9

10

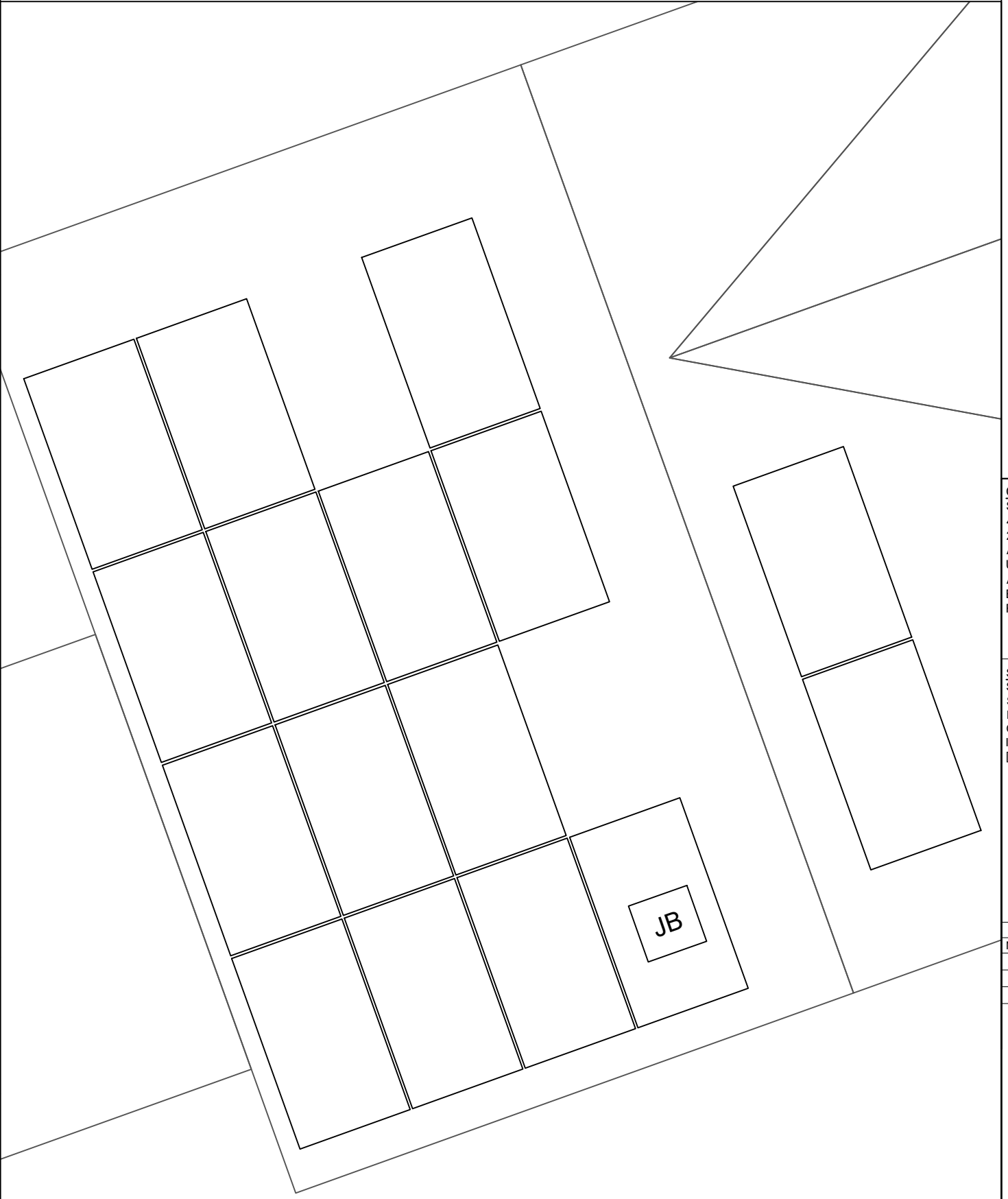

**CLIENT:**  
 STEPHEN STEWARD  
 4943 BARBECUE CHURCH RD, SANFORD, NC 27332  
 AHJ: COUNTY OF HARNETT  
 UTILITY: DUKE ENERGY  
 APN: 039569 0012 05  
 EMAIL: SMSTEWA4@PROTON.ME  
 FINANCE: MOSAIC

**SYSTEM:**  
 SYSTEM SIZE (DC): 16 X 410 = 6.560 kW  
 SYSTEM SIZE (AC): 5.000 kW @ 240V  
 MODULES: 16 X TRINA: TSM-410NE09RC.05  
 OPTIMIZERS: 16 X SOLAREEDGE S440  
 INVERTER: SOLAREEDGE SE5000H-USRGM [S1]

REVISIONS		
NO.	REVISED BY	DATE
-	-	-
-	-	-
-	-	-



**FREEDOM FOREVER LLC**  
 902 PURSER DRIVE, RALEIGH, SC 27603  
 Tel: (800) 385-1075

**GREG ALBRIGHT**

**CONTRACTOR LICENSE:**  
 ELECTRICAL CONTRACTOR U.34043

**OPTIMIZER CHART**

JOB NO: 518972	DATE: 11/19/2024	DESIGNED BY: P.O.	SHEET: PV-8
-------------------	---------------------	----------------------	----------------



# JOB HAZARD ANALYSIS

Crew leader to fill out all sections below, hold a pre-job safety meeting with all personnel, and upload this completed document and the Safety Plan to Site Capture

## Ladder Access

- Ladders must be inspected before each use.
- Extension ladders must be set up on a firm and level surface at a 4-to-1 rise to run angle (or 75 degrees) and the top must be secured to the structure. Extension style ladders placed on uneven, loose or slippery surfaces must additionally have the base firmly anchored or lashed so the base will not slip out.
- Extension ladders must be used with walk-through devices or the ladder must extend 36" above the stepping off point.
- A-frame ladders must only be climbed with the ladder spreader bars locked in the open position; A-frame ladders shall not be climbed while in the closed position (ex, closed and used while leaned against a structure).

Additional notes:

## Mobile Equipment

- Only Qualified operators will operate equipment; operators must maintain a certification on their person for the equipment being operated.
- Type(s) of mobile equipment (Type/Make/Model):
- Qualified operator(s):

## Material Handling and Storage

- Materials will be staged/stored in a way that does not present a hazard to client, personnel or public. Materials stored on the roof will be physically protect from failing or sliding off.

## Fall Protection

- A site-specific plan for fall prevention and protection is required prior to starting work and must remain onsite at all times until work is complete; a fall rescue plan must be outlined and discussed among the crew prior to work start.
- First-person-Up (FPU) must install their anchor and connect before any other task, including installing other anchors. The Last-Person-Down (LPD) must be the only person on a roof uninstalling fall protection.

FPCP (name and title):

FPU and LPD (name and title):

## Electrical Safety

- The Electrical Qualified Person (EQP) is required onsite to perform electrical work.
- All electrical work will be performed with equipment in an electrically safe condition (de-energized) unless approval has been granted prior to work.
- Service drops and overhead electrical hazards will be identified and protected from contact, as necessary.

EQP (name and title):

## Public Protection

- The safety of the Client and Public must be maintained at all times.
- The Client and the Public shall be prevented from entering the work zone through the use of barriers and/or signage, as required.
- Company, Client and Public property shall be protected from falling objects.
- Pets (including dogs) shall be secured by their owners prior to work start.
- The Client should not leave pets, family members, or others in charge or care of Employees, Contractors, or Temporary Workers.

Crew leader responsible for communication with the client:

Client and public is excluded from work area by barricades (N/A, Yes, No):

## Training and Pre-Job Safety Briefing

- All employees onsite shall be made aware of the specific hazards of this project and review this HJA during a pre-job briefing, and their signature indicates awareness of site conditions and the plan to eliminate any hazards identified prior to and during the project.

Crew leader (name/title):

Crew member (name/title):

Crew member (name/title):

Crew member (name/title):

Crew member (name/title):

Crew member (name/title):

## Airborne Contaminants:

- Asbestos-containing (Transite) piping (ACP) - Do not disturb (move, drill, cut fracture, etc.)
- Asbestos-containing thermal insulation (ACI) and Asbestos-containing duct wrapping (ACW) - do not disturb, no attic or crawlspace access is allowed if work to be performed could cause exposure to personnel, client or public.

If yes, list specific tasks and protection in place:

## Weather and Environment

- The site supervisor shall forecast the weather conditions at the job site, prior to crew arrival, in order to mitigate any hazards associated with inclement weather (heat, cold, wind, rain, etc.)
- The site supervisor will utilized a portable wind meter (anemometer) to verify actual onsite wind conditions, by checking at the ground and on any elevated work surface (ex, rooftop) prior to work start, at midday and prior to solar panel staging on a roof.
- Elevated work involving the moving or maneuvering of solar panels shall cease at 25mph (sustained wind) until wind subsides.

Forecasted weather maximum temp (degrees f):

## Heat Related Illness Prevention

- Employees shall have access to potable drinking water that is fresh, pure, and suitably cool. The water shall be located as close as practicable to the areas where employees are working. Water shall be supplied in sufficient quantity at the beginning of the work shift to provide at least one quart per employee per hour for drinking for the entire shift. Employees may begin the shift with smaller quantities of water if they identify the location and have effective means for replenishment during the shift to allow employees to drink on quart or more per hour. The frequent drinking of water shall be encouraged.
- Shade shall be present when temperature exceeds 80 degrees Fahrenheit. When the outdoor temperature in the work exceeds 80 degrees Fahrenheit, employees shall have and maintain one or more areas with shade at all times.
- New employees must be acclimatized. New employees will be monitored by their Crew Leader (site supervisor) for the first two (2) weeks of employment or longer when necessary.
- Employees will be allowed and encouraged to implement scheduled breaks during each shift. Employees must take cool-down breaks in the shade any time they feel the need to do so to protect them from overheating. Supervisors are REQUIRED to allow employees any break period they need during high heat conditions.
- Cool Vests are encouraged for all employees at all times during periods of high heat.
- Identify the location of the closet Occupational/Industrial Clinic or Hospital in case a crew member becomes ill.

What is the specific plan to provide and replenish sufficient water for all employees on site?

If offsite replenish is necessary, where will you go to replenish water (location/address):

Who will replenish the drinking water (name):

## Restroom facilities

- Employees shall have access to restroom facilities with hand-washing stations. Use of onsite restroom is at the client's discretion (location is annotated below). If client does not give permission, location of suitable restroom facilities with hand-washing stations offsite will be provided. The onsite supervisor will identify location and make arrangements to ensure all employees have access at any point.

Restroom facilities will be (circle one): Onsite - Offsite

If Offsite, add location name and address:

## Incident Reporting Procedure

- Contact your Site Supervisor

Name:

Phone:

- Contact your Manager

Name:

Phone:

- Contact your Site Supervisor

Name:

Phone:

With: Your full name, phone number, office location, brief description of what happen and when.

## NOTE ADDITIONAL HAZARDS NOT ADDRESSED ABOVE

(add as many as necessary by using additional sheets)

Define the Hazard:	Method/steps to prevent incident:
Define the Hazard:	Method/steps to prevent incident:
Define the Hazard:	Method/steps to prevent incident:
Define the Hazard:	Method/steps to prevent incident:

**CLIENT:**  
STEPHEN STEWARD  
4943 BARBECUE CHURCH RD, SANFORD, NC 27332  
AHJ: COUNTY OF HARNETT  
UTILITY: DUKE ENERGY  
APN: 039569 0012 05  
EMAIL: SMSTEW4@PROTON.ME  
FINANCE: MOSAIC

**SYSTEM:**  
SYSTEM SIZE (DC): 16 X 410 = 6.560 kW  
SYSTEM SIZE (AC): 5.000 kW @ 240V  
MODULES: 16 X TRINA: TSM-410NE09RC.05  
OPTIMIZERS: 16 X SOLAREEDGE S440  
INVERTER: SOLAREEDGE SE5000H-USRGM [S11]

REVISIONS		
NO.	REVISED BY	DATE
-	-	-
-	-	-
-	-	-



**FREEDOM FOREVER LLC**  
902 PURSER DRIVE, RALEIGH, SC 27603  
Tel: (800) 385-1075

**GREG ALBRIGHT**

**CONTRACTOR LICENSE:**  
ELECTRICAL CONTRACTOR U.34043

## SAFETY PLAN

JOB NO: 518972	DATE: 11/19/2024	DESIGNED BY: P.O.	SHEET: PV-10
-------------------	---------------------	----------------------	-----------------

FOR INSTALLATION REFERENCE ONLY

SCAN QR CODE TO ACCESS REFERENCE LINK

**FREEDOM REFERENCES**



INSTALL HOTLINE

**PV INSTALLATION REFERENCES**



ENPHASE



SOLAREEDGE



TESLA

**BATTERY INSTALLATION REFERENCES**



Enphase Storage Systems



SOLAREEDGE Storage Systems



TESLA Storage Systems



NON-BACKUP Battery Systems



Misc. Quick Guide

# Vertex S+

BACKSHEET MONOCRYSTALLINE MODULE

PRODUCT: TSM-NE09RC.05  
PRODUCT RANGE: 400-430W

## 430W

MAXIMUM POWER OUTPUT

## 0~+5W

POSITIVE POWER TOLERANCE

## 21.5%

MAXIMUM EFFICIENCY

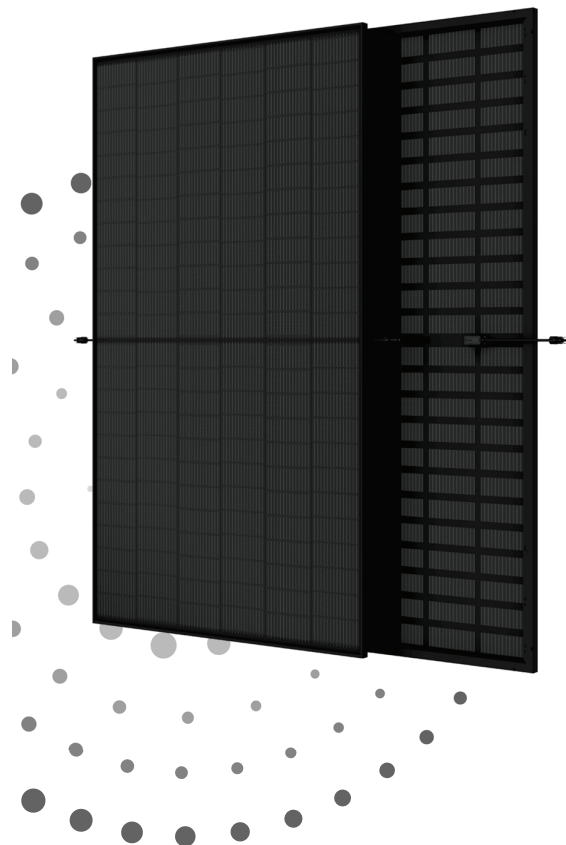

### Small in size, bigger on power

- Up to 430W, 21.5% module efficiency with high density interconnect technology
- Reduce installation cost with higher power bin and efficiency
- Boost performance in warm weather with low temperature coefficient and operating temperature



### High Reliability

- Innovative non-destructive cutting for improved mechanical resistance and strength
- Excellent fire rating, weather resistance, salt spray, sand dust, ammonia performance which is fully applicable in coastal, high temperature, humidity area and harsh environment



### Ultra-low Degradation, longer warranty, higher output

- First-year degradation 1% and annual degradation at 0.4%
- Up to 25 years product warranty and 25 years power warranty



### Universal solution for residential and C&I rooftops

- Easy for integration, designed for compatibility with existing mainstream inverters and diverse mounting systems
- Perfect size and low weight for handling and installation
- Most valuable solution on low load capacity rooftops (weight similar to backsheet version)
- Mechanical performance up to 6000 Pa positive load and 4000 Pa negative load

### Trina Solar's Vertex Bifacial Backsheet Performance Warranty

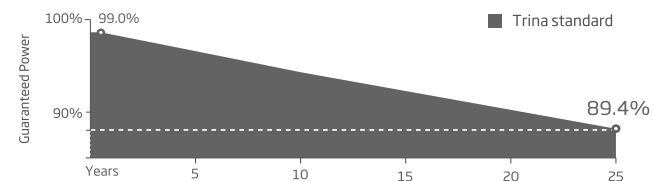

# Vertex S+

BACKSHEET MONOCRYSTALLINE MODULE

## DIMENSIONS OF PV MODULE(mm)

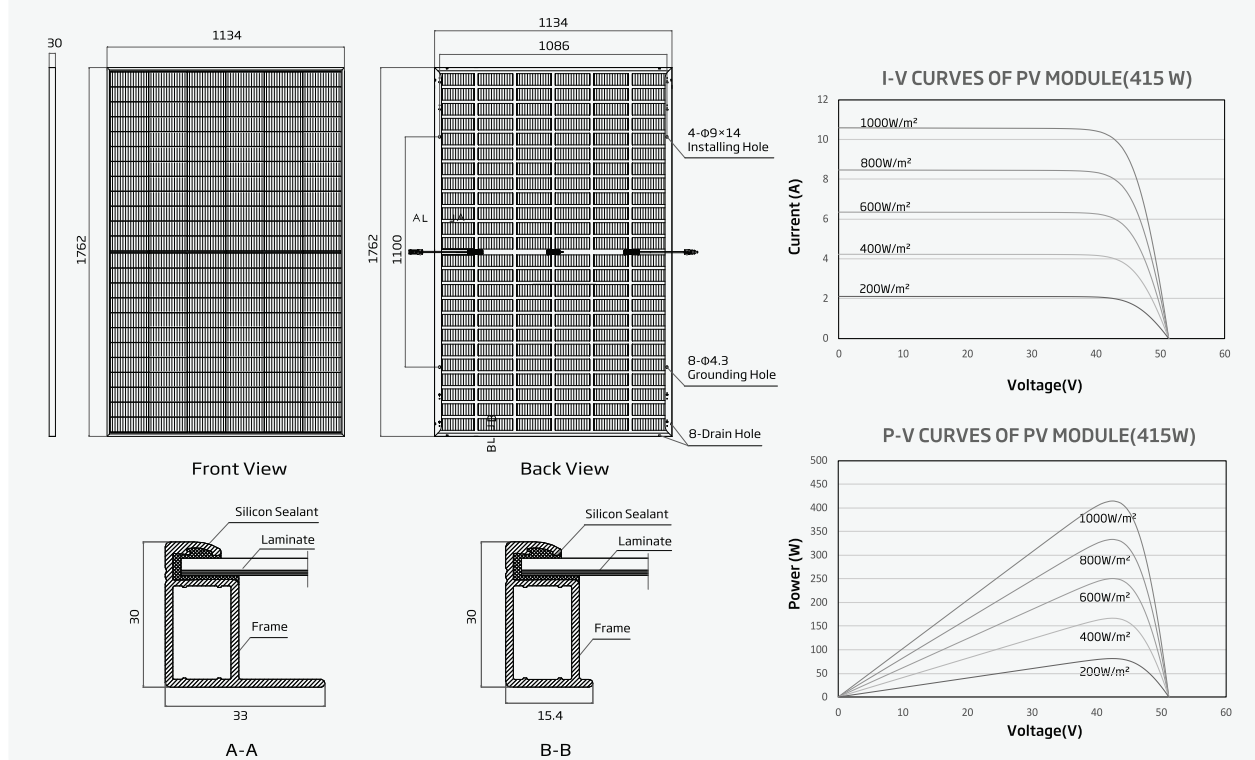

### ELECTRICAL DATA (STC)

	400	405	410	415	420	425	430
Peak Power Watts-P <sub>MAX</sub> (Wp)*	400	405	410	415	420	425	430
Power Tolerance-P <sub>MAX</sub> (W)	0 ~ +5						
Maximum Power Voltage-V <sub>MPP</sub> (V)	41.3	41.7	42.1	42.5	42.8	43.2	43.6
Maximum Power Current-I <sub>MPP</sub> (A)	9.68	9.71	9.73	9.77	9.80	9.84	9.87
Open Circuit Voltage-V <sub>OC</sub> (V)	49.2	49.6	50.1	50.5	50.9	51.4	51.8
Short Circuit Current-I <sub>SC</sub> (A)	10.30	10.33	10.37	10.40	10.43	10.47	10.50
Module Efficiency η <sub>m</sub> (%)	20.0	20.3	20.5	20.8	21.0	21.3	21.5

STC: Irradiance 1000W/m<sup>2</sup>, Cell Temperature 25°C, Air Mass AML5. \*Measuring tolerance: ±3%.

### Electrical characteristics with different power bin (reference to 10% Irradiance ratio)

	426	431	437	442	447	453	458
Total Equivalent power -P <sub>MAX</sub> (Wp)	426	431	437	442	447	453	458
Maximum Power Voltage-V <sub>MPP</sub> (V)	41.3	41.7	42.1	42.5	42.8	43.2	43.6
Maximum Power Current-I <sub>MPP</sub> (A)	10.31	10.34	10.36	10.41	10.44	10.48	10.51
Open Circuit Voltage-V <sub>OC</sub> (V)	49.2	49.6	50.1	50.5	50.9	51.4	51.8
Short Circuit Current-I <sub>SC</sub> (A)	10.97	11.00	11.04	11.08	11.11	11.15	11.18
Irradiance ratio (rear/front)	10%						

Power Bifaciality: 65±10%.

### ELECTRICAL DATA (NOCT)

	312	308	312	316	319	324	328
Maximum Power-P <sub>MAX</sub> (Wp)	312	308	312	316	319	324	328
Maximum Power Voltage-V <sub>MPP</sub> (V)	38.6	39.0	39.3	39.7	40.0	40.4	40.7
Maximum Power Current-I <sub>MPP</sub> (A)	7.88	7.91	7.93	7.96	7.98	8.01	8.04
Open Circuit Voltage-V <sub>OC</sub> (V)	46.6	47.0	47.5	47.8	48.2	48.7	49.1
Short Circuit Current-I <sub>SC</sub> (A)	8.30	8.32	8.36	8.38	8.41	8.44	8.46

NOCT: Irradiance at 800W/m<sup>2</sup>, Ambient Temperature 20°C, Wind Speed 1m/s.

### MECHANICAL DATA

Solar Cells	Topcon Bifacial
No. of cells	144cells
Module Dimensions	1762×1134×30 mm (69.37×44.65×1.18 inches)
Weight	21.3kg (47.0 lb)
Front Glass	3.2 mm (0.12inches), High Transmission, Tempered Glass
Encapsulant material	POE/EVA
BackSheet	Black Grid Transparent Backsheet
Frame	30mm (1.18 inches) Anodized Aluminium Alloy, Black
J-Box	IP 68 rated
Cables	Photovoltaic Technology Cable 4.0mm <sup>2</sup> (0.006 inches <sup>2</sup> ) Landscape: N 1100 mm/ P1100 mm(43.31/43.31 inches)
Connector	MC4 EVO2
Fire Type	Type 1 or Type2

### TEMPERATURE RATINGS

NOCT (Nominal Operating Cell Temperature)	43°C (±2°C)
Temperature Coefficient of P <sub>MAX</sub>	-0.30%/°C
Temperature Coefficient of V <sub>OC</sub>	-0.24%/°C
Temperature Coefficient of I <sub>SC</sub>	0.04%/°C

### MAXIMUM RATINGS

Operational Temperature	-40~+85°C
Maximum System Voltage	1500V DC (IEC)
Max Series Fuse Rating	25 A

### WARRANTY

- 25 year Product Workmanship Warranty
- 25 year Power Warranty
- 1% first year degradation
- 0.4% Annual Power Attenuation

### PACKAGING CONFIGURATION

- Modules per box: 36 pieces
- Modules per 40' container: 792 pieces
- Pallet dimensions (L x W x H): 1800 x 1135 x 1259 mm
- Pallet weight: 829 kg (1827 lb)

(Please refer to product warranty for details)

### Comprehensive Products and System Certificates



IEC61215/IEC61730/IEC61701/IEC62716/UL61730  
ISO 9001: Quality Management System  
ISO 14001: Environmental Management System  
ISO14064: Greenhouse Gases Emissions Verification  
ISO45001: Occupational Health and Safety Management System

# Trina solar

# Trina solar

CAUTION: READ SAFETY AND INSTALLATION INSTRUCTIONS BEFORE USING THE PRODUCT.

© 2023 Trina Solar Co., Ltd. All rights reserved. Specifications included in this datasheet are subject to change without notice.

Version number: TSM\_NA\_EN\_2023\_A

www.trinasolar.com

# SolarEdge Home Wave Inverter For North America

SE3800H-US / SE5000H-US / SE6000H-US /  
SE7600H-US / SE10000H-US / SE11400H-US

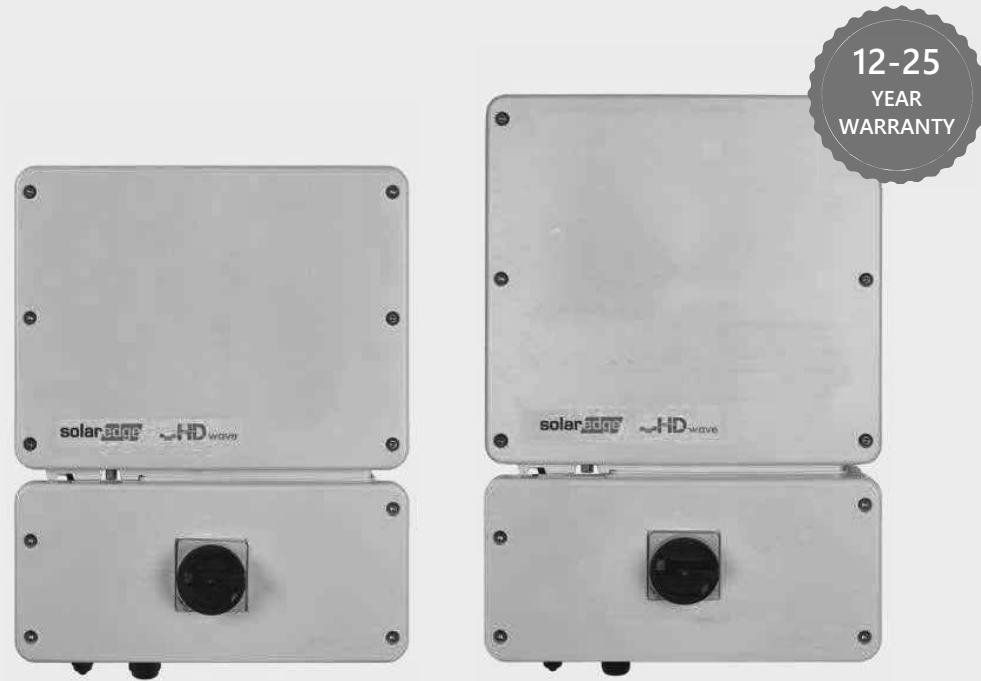

INVERTERS

## Optimized installation with HD-Wave technology

- Specifically designed to work with power optimizers
- Record-breaking 99% weighted efficiency
- Quick and easy inverter commissioning directly from a smartphone using SolarEdge SetApp
- Fixed voltage inverter for longer strings
- Integrated arc fault protection and rapid shutdown for NEC 2014-2023 per articles 690.11 and 690.12
- UL1741 SA certified, for CPUC Rule 21 grid compliance
- Small, lightweight, and easy to install both outdoors or indoors
- Built-in module-level monitoring
- Optional: Faster installations with built-in consumption metering (1% accuracy) and production revenue grade metering (0.5% accuracy, ANSI C12.20)

# / SolarEdge Home Wave Inverter For North America

SE3800H-US / SE5000H-US / SE6000H-US /  
SE7600H-US / SE10000H-US / SE11400H-US

Applicable to inverters with part number	SEXXXXH-XXXXBXX4					SE11400H-XXXXBXX5	Units
	SE3800H-US	SE5000H-US	SE6000H-US	SE7600H-US	SE10000H-US	SE11400H-US	
<b>OUTPUT</b>							
Rated AC Power Output	3800 @ 240V 3300 @ 208V	5000	6000 @ 240V 5000 @ 208V	7600	10000	11400 @ 240V 10000 @ 208V	VA
Maximum AC Power Output	3800 @ 240V 3300 @ 208V	5000	6000 @ 240V 5000 @ 208V	7600	10000	11400 @ 240V 10000 @ 208V	VA
AC Output Voltage Min.-Nom.-Max. (211 - 240 - 264)	✓	✓	✓	✓	✓	✓	Vac
AC Output Voltage Min.-Nom.-Max. (183 - 208 - 229)	✓	-	✓	-	-	✓	Vac
AC Frequency (Nominal)	59.3 - 60 - 60.5 <sup>(1)</sup>						Hz
Maximum Continuous Output Current @240V	16	21	25	32	42	47.5	A
Maximum Continuous Output Current @208V	16	-	24	-	-	48.5	A
Power Factor	1, Adjustable - 0.85 to 0.85						
GFDI Threshold	1						A
Utility Monitoring, Islanding Protection, Country Configurable Thresholds	Yes						
<b>INPUT</b>							
Maximum DC Power @240V	5900	7750	9300	11800	15500	17650	W
Maximum DC Power @208V	5100	-	7750	-	-	15500	W
Transformer-less, Ungrounded	Yes						
Maximum Input Voltage	480						Vdc
Nominal DC Input Voltage	380						Vdc
Maximum Input Current @240V <sup>(2)</sup>	10.5	13.5	16.5	20	27	30.5	Adc
Maximum Input Current @208V <sup>(2)</sup>	9	-	13.5	-	-	27	Adc
Max. Input Short Circuit Current	45						Adc
Reverse-Polarity Protection	Yes						
Ground-Fault Isolation Detection	600k Sensitivity						
Maximum Inverter Efficiency	99.2						%
CEC Weighted Efficiency	99					99 @ 240V 98.5 @ 208V	%
Nighttime Power Consumption	< 2.5						W

(1) For other regional settings please contact SolarEdge support.

(2) A higher current source may be used; the inverter will limit its input current to the values stated.



# / SolarEdge Home Wave Inverter

## For North America

SE3800H-US / SE5000H-US / SE6000H-US/

SE7600H-US / SE10000H-US / SE11400H-US

Applicable to inverters with part number	SEXXXXH-XXXXXBXX4					SE11400H-XXXXXBXX5	
	SE3800H-US	SE5000H-US	SE6000H-US	SE7600H-US	SE10000H-US	SE11400H-US	
<b>ADDITIONAL FEATURES</b>							
Supported Communication Interfaces	RS485, Ethernet, ZigBee (optional), wireless SolarEdge Home Network (optional) <sup>(3)</sup> , Wi-Fi (optional), Cellular (optional)						
Revenue Grade Metering, ANSI C12.20	Optional <sup>(4)</sup>						
Consumption Metering							
Inverter Commissioning	With the SetApp mobile application using Built-in Wi-Fi Access Point for Local Connection						
Rapid Shutdown - NEC 2014-2023 per articles 690.11 and 690.12	Automatic Rapid Shutdown upon AC Grid Disconnect						
<b>STANDARD COMPLIANCE</b>							
Safety	UL1741, UL1741 SA, UL1741 SB, UL1699B, CSA C22.2, Canadian AFCI according to T.I.L. M-07						
Grid Connection Standards	IEEE1547-2018, Rule 21, Rule 14 (H1), CSA C22.3 No. 9						
Emissions	FCC Part 15 Class B						
<b>INSTALLATION SPECIFICATIONS</b>							
AC Output Conduit Size / AWG Range	1" Maximum / 14 – 6 AWG			1" Maximum / 14 – 4 AWG			
DC Input Conduit Size / # of Strings / AWG Range	1" Maximum / 1 – 2 strings / 14 – 6 AWG			1" Maximum / 1 – 3 strings / 14 – 6 AWG			
Dimensions with Safety Switch (H x W x D)	17.7 x 14.6 x 6.8 / 450 x 370 x 174			21.06 x 14.6 x 7.3 / 535 x 370 x 185	21.06 x 14.6 x 8.2 / 535 x 370 x 208 <sup>(5)</sup>		in / mm
Weight with Safety Switch	22 / 10	25.1 / 11.4	26.2 / 11.9	38.8 / 17.6	44.9 / 20.4 <sup>(5)</sup>		lb / kg
Noise	< 25			< 50			dBA
Cooling	Natural Convection						
Operating Temperature Range	-40 to +140 / -40 to +60 <sup>(6)</sup>						°F / °C
Protection Rating	NEMA 4X (Inverter with Safety Switch)						

(3) For more information, refer to the [SolarEdge Home Network](#) datasheet

(4) Inverter with Revenue Grade Production and Consumption Meter P/N: SExxxxH-US000BEI4. For consumption metering, current transformers should be ordered separately: SEACT0750-400NA-20 or SEACT0750-400NA-20. 20 units per box.

(5) SE11400H-USxxxBox5 is the updated PN, though SE11400H-USxxxBox4 will still be available. All specifications are similar for both models, **EXCLUDING** the weight and dimensions [HxWxD]. The weight and dimensions of SE11400H-USxxxBox4 are 17.6 [kg] and 21.06-14.6-7.3 / 535-370-185 [in/mm], accordingly.

(6) Full power up to at least 50°C / 122°F; for power de-rating information refer to the [Temperature De-rating Technical Note for North America](#).

## How to Enable Consumption Monitoring

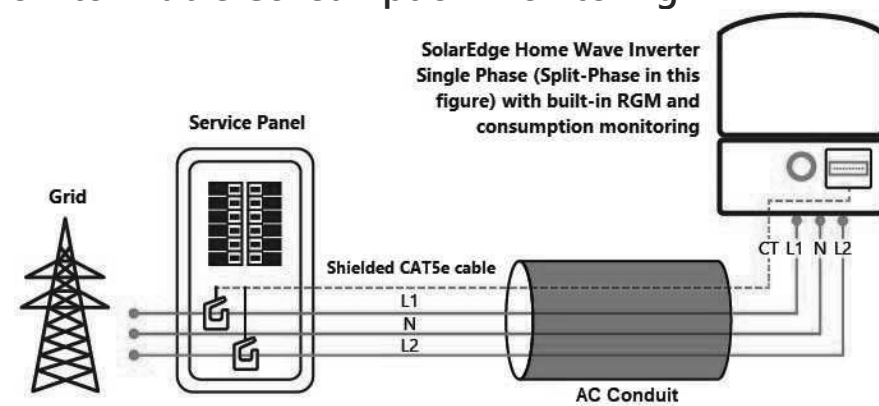

By simply wiring current transformers through the inverter's existing AC conduits and connecting them to the service panel, homeowners will gain full insight into their household energy usage helping them to avoid high electricity bills.

# Power Optimizer

## For North America

S440, S500



# POWER OPTIMIZER

## PV power optimization at the module level

- Specifically designed to work with SolarEdge residential inverters
- Detects abnormal PV connector behavior, preventing potential safety issues\*
- Module-level voltage shutdown for installer and firefighter safety
- Superior efficiency (99.5%)
- Mitigates all types of module mismatch loss, from manufacturing tolerance to partial shading
- Faster installations with simplified cable management and easy assembly using a single bolt
- Flexible system design for maximum space utilization
- Compatible with bifacial PV modules
- Meets NEC requirements for arc fault protection (AFCI) and Photovoltaic Rapid Shutdown System (PVRSS)

\* Expected availability in 2022

[solaredge.com](http://solaredge.com)



# / Power Optimizer

## For North America

S440, S500

	S440	S500	Unit
<b>INPUT</b>			
Rated Input DC Power <sup>(1)</sup>	440	500	W
Absolute Maximum Input Voltage (Voc)	60		Vdc
MPPT Operating Range	8 - 60		Vdc
Maximum Short Circuit Current (Isc) of Connected PV Module	14.5	15	Adc
Maximum Efficiency	99.5		%
Weighted Efficiency	98.6		%
Ovenvoltage Category	II		
<b>OUTPUT DURING OPERATION</b>			
Maximum Output Current	15		Adc
Maximum Output Voltage	60		Vdc
<b>OUTPUT DURING STANDBY (POWER OPTIMIZER DISCONNECTED FROM INVERTER OR INVERTER OFF)</b>			
Safety Output Voltage per Power Optimizer	1+/-0.1		Vdc
<b>STANDARD COMPLIANCE</b>			
Photovoltaic Rapid Shutdown System	NEC 2014, 2017 & 2020		
EMC	FCC Part 15 Class B, IEC61000-6-2, IEC61000-6-3		
Safety	IEC62109-1 (class II safety), UL1741		
Material	UL94 V-0, UV Resistant		
RoHS	Yes		
Fire Safety	VDE-AR-E 2100-712:2013-05		
<b>INSTALLATION SPECIFICATIONS</b>			
Maximum Allowed System Voltage	1000		Vdc
Dimensions (W x L x H)	129 x 153 x 30 / 5.07 x 6.02 x 1.18		mm / in
Weight (including cables)	655 / 1.5		gr / lb
Input Connector	MC4 <sup>(2)</sup>		
Input Wire Length	0.1 / 0.32		m / ft
Output Connector	MC4		
Output Wire Length	(+) 2.3, (-) 0.10 / (+) 7.54, (-) 0.32		m / ft
Operating Temperature Range <sup>(3)</sup>	-40 to +85		°C
Protection Rating	IP68 / Type6B		
Relative Humidity	0 - 100		%

(1) Rated power of the module at STC will not exceed the power optimizer Rated Input DC Power. Modules with up to +5% power tolerance are allowed

(2) For other connector types please contact SolarEdge

(3) For ambient temperature above +70°C / +158°F power de-rating is applied. Refer to Power Optimizers Temperature De-Rating Technical Note for more details

PV System Design Using a SolarEdge Inverter	Single Phase HD-Wave	Three Phase for 208V grid	Three Phase for 277/480V grid	
Minimum String Length (Power Optimizers)	S440, S500	8	14	18
Maximum String Length (Power Optimizers)	25		50 <sup>(4)</sup>	
Maximum Nominal Power per String	5700 (6000 with SE7600-US-SE11400-U)	6000	12750	W
Maximum Allowed Connected Power per String <sup>(5)</sup> (Permitted only when the difference in connected power between strings is 1,000W or less)	Refer to Footnote 5	One String 7200W Two strings or more 7800W	15,000W	
Parallel Strings of Different Lengths or Orientations	Y			

(4) A string with more than 30 optimizers does not meet NEC rapid shutdown requirements; safety voltage will be above the 30V requirement

(5) If the inverters rated AC power < maximum nominal power per string, then the maximum power per string will be able to reach up to the inverters maximum input DC power. Refer to: <https://www.solaredge.com/sites/default/files/se-power-optimizer-single-string-design-application-note.pdf>

(6) It is not allowed to mix S-series and P-series Power Optimizers in new installations

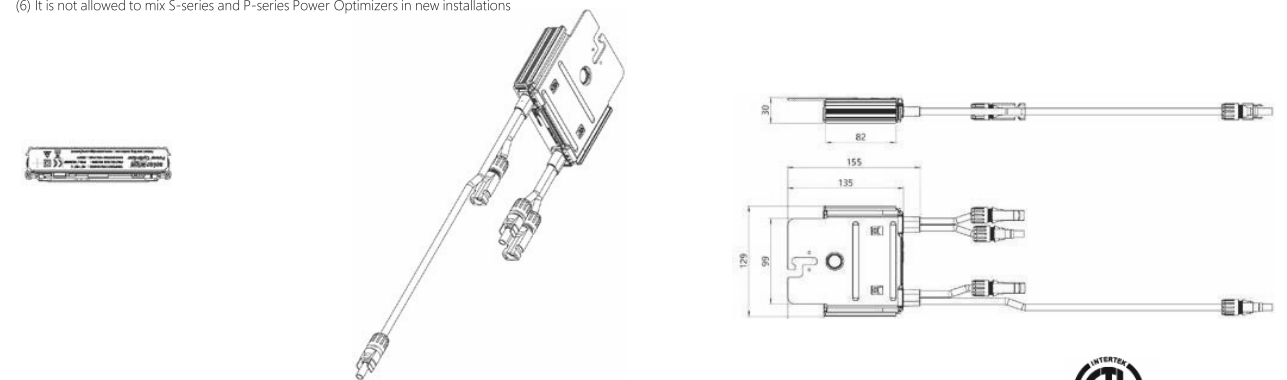

© SolarEdge Technologies, Inc. All rights reserved. SOLAREEDGE, the SolarEdge logo, OPTIMIZED BY SOLAREEDGE are trademarks or registered trademarks of SolarEdge Technologies, Inc. All other trademarks mentioned herein are trademarks of their respective owners. Date: February 8, 2022 DS-000018-NA. Subject to change without notice.



## Product specifications

# Eaton DG221URB

Catalog Number: DG221URB

Eaton General duty non-fusible safety switch, single-throw, 30 A, 240 V, NEMA 3R, Rainproof, Painted galvanized steel, Two-pole, Two-wire

## General specifications

Product Name	Catalog Number
Eaton general duty non-fusible safety switch	DG221URB
	UPC
	782113120232
Product Length/Depth	Product Height
6.88 in	10.81 in
Product Width	Product Weight
6.38 in	6 lb
Warranty	Certifications
Eaton Selling Policy 25-000, one (1) year from the date of installation of the Product or eighteen (18) months from the date of shipment of the Product, whichever occurs first.	UL Listed
	Catalog Notes
	WARNING! Switch is not approved for service entrance unless a neutral kit is installed.



## Product specifications

Product Category
General duty safety switch
Enclosure material
Painted galvanized steel
Type
Non-fusible, single-throw
Fuse configuration
Non-fusible
Number of wires
2
Enclosure
NEMA 3R
Voltage rating
240V
Amperage Rating
30A
Number Of Poles
Two-pole

## Resources

Catalogs
Eaton's Volume 2—Commercial Distribution
Multimedia
Double Up on Safety
Switching Devices Flex Center
Specifications and datasheets
Eaton Specification Sheet - DG221URB



Eaton Corporation plc  
Eaton House  
30 Pembroke Road  
Dublin 4, Ireland  
Eaton.com  
© 2023 Eaton. All Rights Reserved.

Eaton is a registered trademark.

All other trademarks are property of their respective owners.



Eaton.com/socialmedia

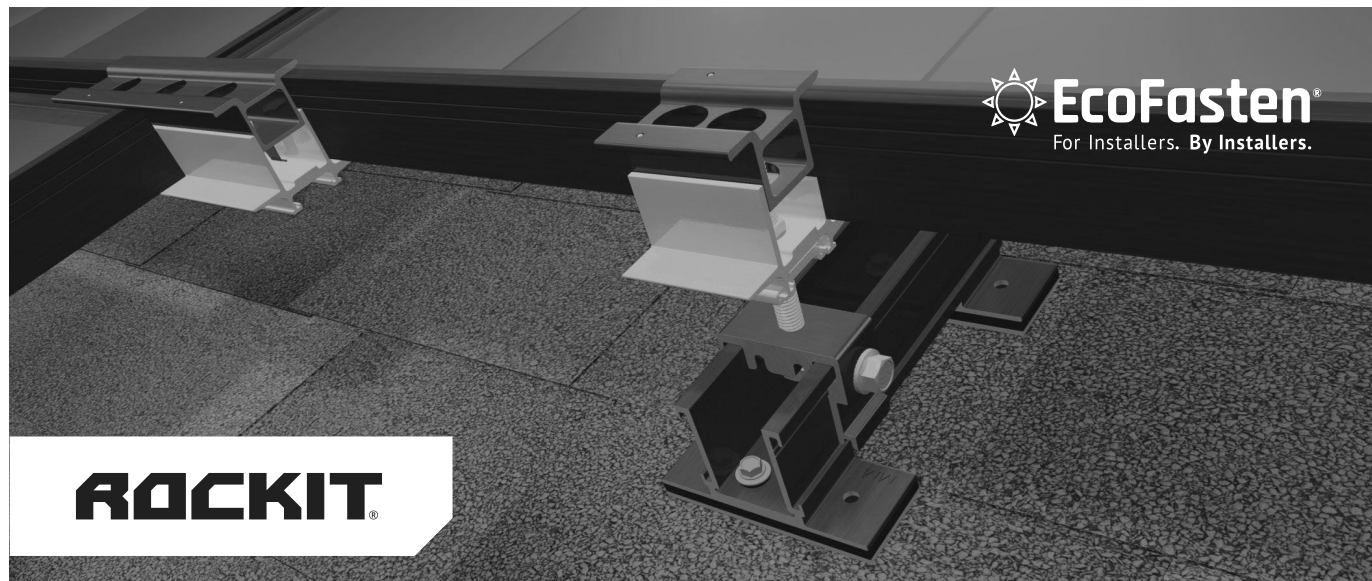

# ROCKIT SMART SLIDE

## Integrated UltraGrip Technology™

Pre-installed sealing pads are compatible with all composition shingle roofs. The compression achieved when fastened to the roof creates a super strong watertight seal. In most cases, the slide can be mounted to the deck without the need for sealant. A layer of flexible foam provides cushioning, which allows the waterproofing sealant to embed deep into the granules of the shingle as well as to flexibly conform over the steps found on architectural-style shingles.



**ROCKIT**

## INTRODUCING ROCKIT SMART SLIDE!

Introducing EcoFasten's patent pending RockIt Smart Slide, our simple solution for quickly installing the popular RockIt rail-less racking system to composition shingle roofs.

### Features & Benefits

- Eliminates the need to pry up shingle courses and install a metal flashing
- Multiple opportunities to find the rafter
- No need for additional material when architectural shingles are not level
- Longer 6.75" slide avoids overlaps in shingle courses
- Integrated flashing utilizes UltraGrip Technology™ to create a watertight seal



ROCKIT SMART SLIDE

### Required Components:

Part Number:	Description:
2011024	RI SMART SLIDE BLK 6.75"
2011025	RI SMART SCRW #12X3" W/BW

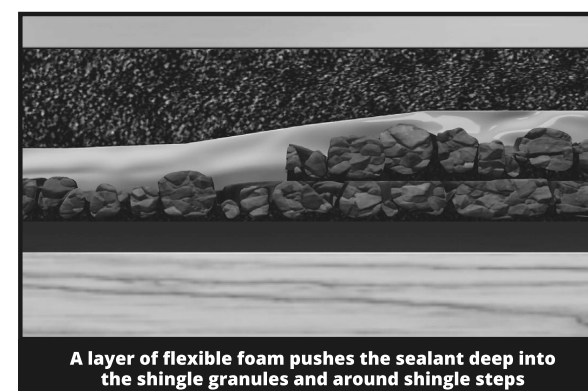

A layer of flexible foam pushes the sealant deep into the shingle granules and around shingle steps

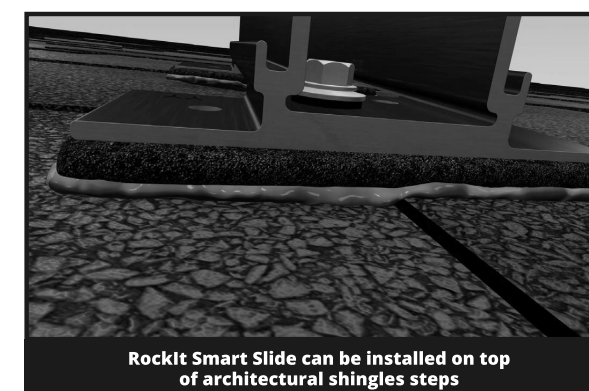

RockIt Smart Slide can be installed on top of architectural shingles steps

## Testing & Documentation

- [UL441 Rain Report](#)
- [TAS 100 \(A\)-95 Wind and Wind Driven Rain Resistance](#)
- [Mechanical Load Test/Structural Capacity Certification](#)
- [Florida Product Approval](#)
- [RockIt Installation Manual](#)
- [RockIt CutSheets](#)



# RI SMART SLIDE BLK 6.75"

PART NUMBER	DESCRIPTION
2011024	RI SMART SLIDE BLK 6.75"

ITEM NO.	DESCRIPTION
1	ROCKIT SMART SLIDE ASSEMBLY

1) ROCKIT FLASHLESS SLIDE ASSEMBLY

MATERIAL	ALUMINUM, EPDM, ADHESIVE, TREATED PAPER
FINISH	BLACK

Rev: CS-3

# RI SMART SCREW #12X3" W/BW

PART NUMBER	DESCRIPTION
2011025	RI SMART SCREW #12X3" W/BW

ITEM NO.	DESCRIPTION
1	SELF TAPPING SCREW #12 WITH SEALING WASHER ASSEMBLY

MATERIAL	STAINLESS STEEL, EPDM RUBBER
FINISH	MILL, BLACK

Rev: CS-2



## ROCKIT®

### COMPLETE RAIL-LESS RACKING SYSTEM

The RockIt system is the industry's premier rail-less PV racking system for composition shingle, tile, and metal roofs. Designed in conjunction with the needs of installers, RockIt quickly & easily installs with a single tool. Featuring an easy-to-position alignment slide and a top-down leveling system, RockIt is logistically intelligent with no need to ship or transport long rails. Components are available in a black finish that complements both commercial and residential applications. Conforms to UL 2703.

### FEATURES & BENEFITS

- Patented watertight technology
- Fully integrated bonding
- Top-down leveling system
- North-South adjustability
- Single tool install
- Florida Product Approved for composition shingle roofs

### STREAMLINED INSTALLATION WITH MINIMAL ROOF PENETRATIONS



## ROCKIT

### ROCKIT COUPLING

The fast installing RockIt Coupling easily attaches to the module frame to bridge the gaps between modules.

### SKIRT

The sleek black Skirt installs first and acts as an alignment guide for the entire array. The Skirt End Cap does double duty as a skirt coupling device and an aesthetically-pleasing finishing touch.

### ROCKIT MOUNT

Featuring integrated bonding pins, the RockIt Mount connects to the Slide and can easily be positioned for fast installation. Features top-down leveling.

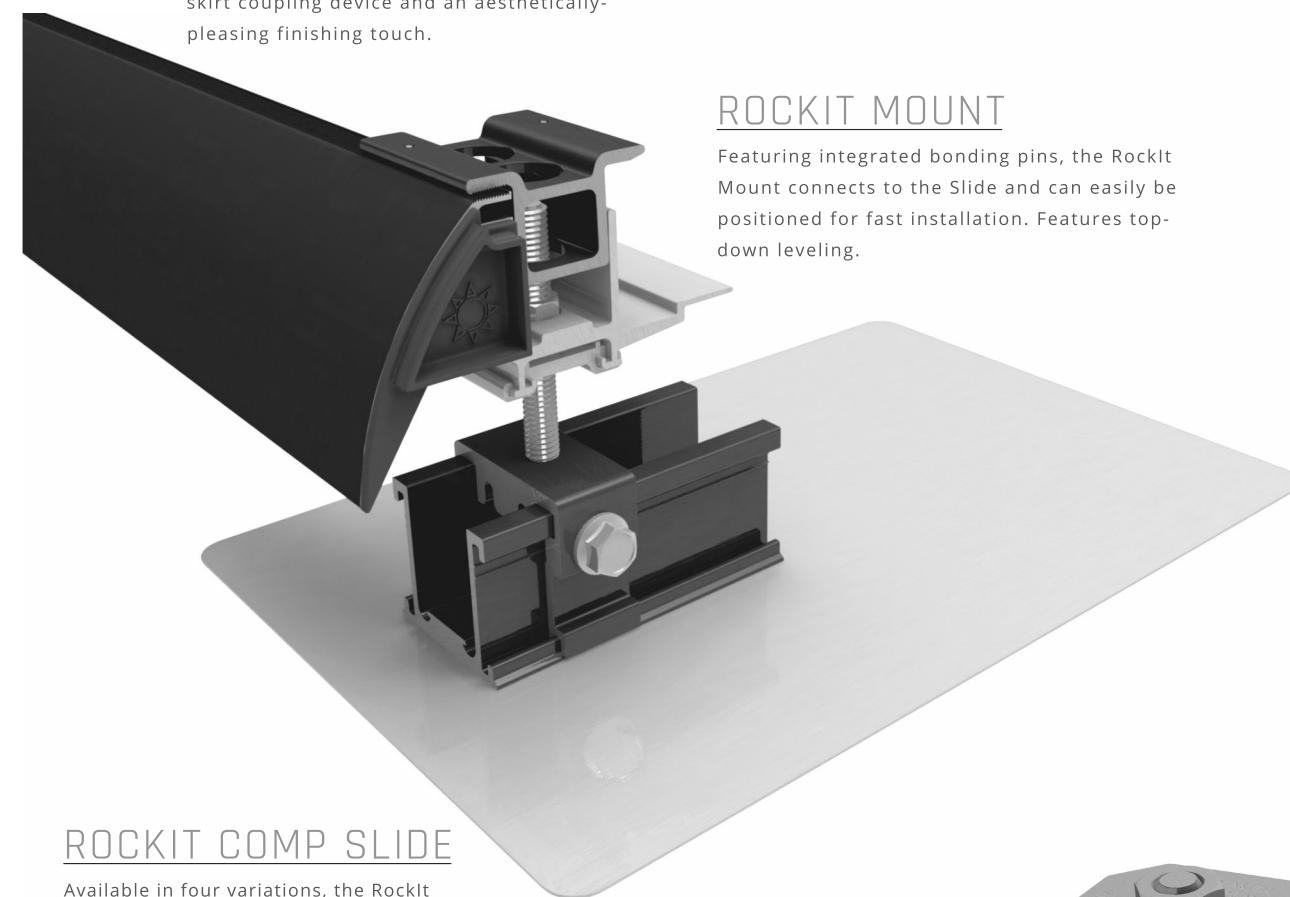

### ROCKIT COMP SLIDE

Available in four variations, the RockIt Slide allows installation on composition shingle, tile, and metal roofs.

### FRAME MLPE MOUNT

Attaches and fully bonds MLPE's (Module Level Power Electronics) to the module frame with a single bolt clip.

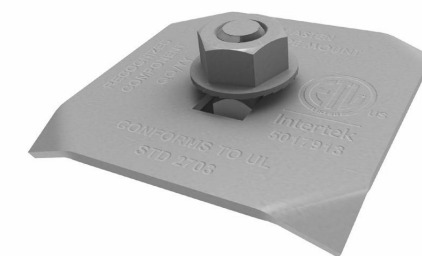

# RI COMP SLIDE AL BLK

PART NUMBER	DESCRIPTION
2011013	RI COMP SLIDE AL BLK

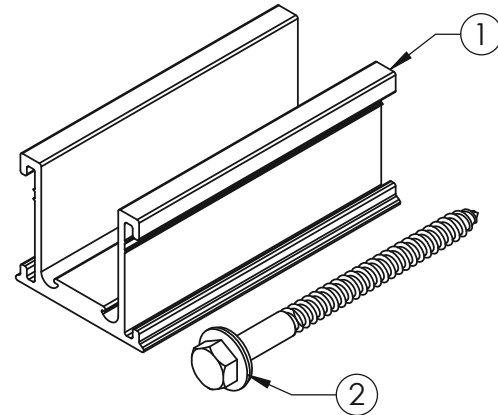

ITEM NO.	DESCRIPTION
1	ROCKIT V3 SLIDECOMP
2	LAG SCREW, 5/16-4", THREAD 3", EPDM BACKED WASHER

1) ROCKIT V3 SLIDECOMP

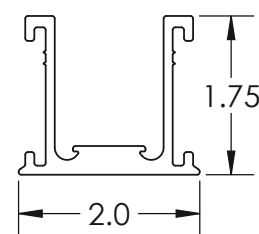
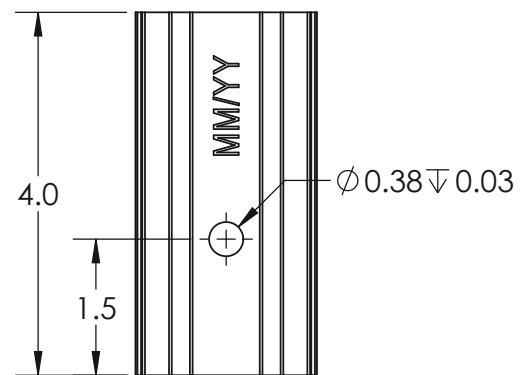

Material	Aluminum
Finish	Black

REV.- CS1

# RI COMP SLIDE AL BLK

2) LAG SCREW, 5/16-4", THREAD 3", EPDM BACKED WASHER

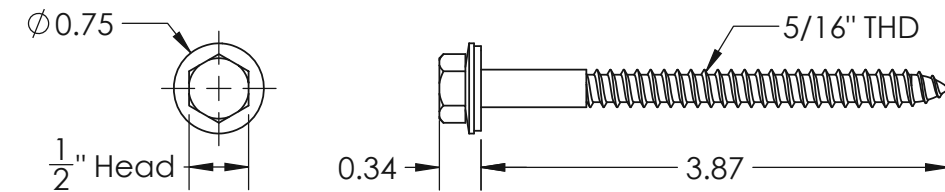

Material	Stainless Steel
Finish	Mill

REV.- CS1

# GF-1 FLASHING GLV BLK 8X10"

PART NUMBER	DESCRIPTION
3012020	GF-1 FLASHING GLV BLK 8X10"

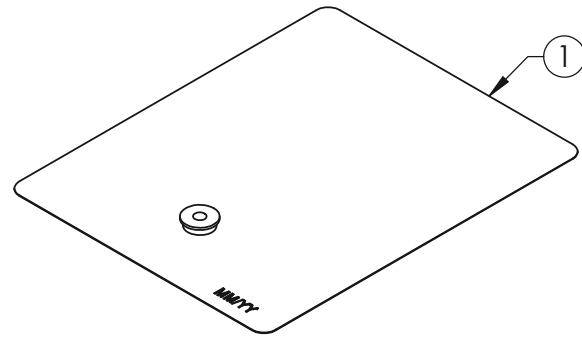

ITEM NO.	DESCRIPTION
1	GF1M-GAL-BLK-810 W/O WASHER ASSEMBLY

1) GF1M-GAL-BLK-810 W/O WASHER ASSEMBLY

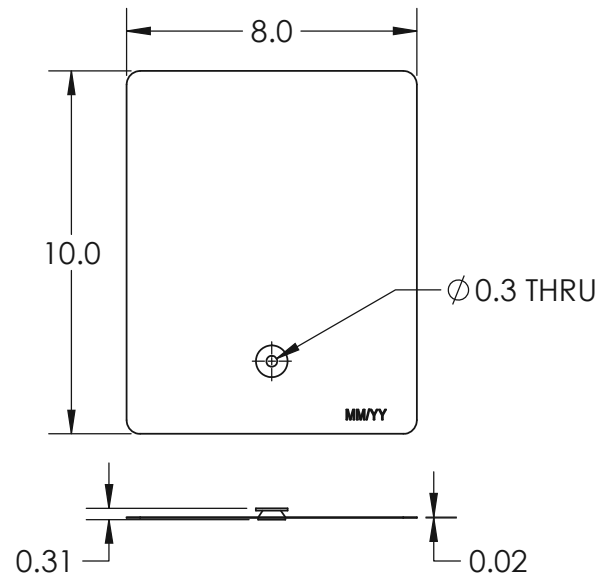

Material	Corrosion Resistant Steel
Finish	Black

REV.- CS1







ECOFASTEN SOLAR LLC  
4141 W. VAN BUREN ST., SUITE 2  
PHOENIX, AZ 85009

877-859-3947  
INFO@ECOFASTENSOLAR.COM

April 8<sup>th</sup>, 2024

EcoFasten  
4141 West Van Buren St.  
Phoenix, AZ 85009

Attn.: EcoFasten Solar Engineering Department

**Re:** Report # 7.16-RockIt\_CS-SS EcoFasten RockIt System, with Comp Slide or Smart Slide,  
Certification for Gable and Hip roofs.

This letter certifies the loading criteria and design basis used for the structural analysis of the EcoFasten - RockIt System as shown in Report # 7.16-RockIt\_CS-SS "Engineering Certification for the EcoFasten - RockIt System with Comp or Smart Slide for Gable and Hip Roofs". All information, data, and analysis therein are based on, and comply with, the following building codes and typical specifications. The Span Tables provided in the referenced report may be used when all assumptions listed therein are met.

Building Codes:

1. ASCE/SEI 7-16, Minimum Design Loads for Buildings and Other Structures, by American Society of Civil Engineers
2. 2021 International Building Code (IBC)
3. 2021 International Residential Code (IRC)
4. SEAOC (Structural Engineer Association of California) report PV2-2017 Wind Design for Solar Arrays
5. AC428, Acceptance Criteria for Modular Framing Systems Used to Support Photovoltaic (PV) Panels, November 1, 2012 by ICC-ES
6. Aluminum Design Manual 2020, by The Aluminum Association, Inc.
7. ANSI/AWC NDS-2018, National Design Specification for Wood Construction, by the American Wood Council

Please note our evaluation only applies to EcoFasten products and excludes the structural adequacy of the chosen roof attachments, PV modules, or underlying roof supporting members. It shall be the responsibility of the installer or system designer to verify the structural capacity and adequacy of the referenced system components with respect to the applied or resultant loads of the chosen array configuration.

Sincerely,



Matthew S Kuzila, P.E.

Sealed 04.08.2024  
Expires 12.31.2024