

PHOTOVOLTAIC ROOF MOUNT SYSTEM

(N) 06 + (E) 30 MODULES-ROOF MOUNTED - 13.890 kW DC, 10.440 kW AC

165 JARED DR, FUQUAY VARINA, NC 27526



TOP TIER SOLAR SOLUTIONS

1530 CENTER PARK DR #2911,
CHARLOTTE, NC 28217,
UNITED STATES

PROJECT DATA

PROJECT ADDRESS: 165 JARED DR, FUQUAY VARINA, NC 27526

OWNER: MICHAEL SPERICO

DESIGNER: ESR

SCOPE:
(N) 2.340 kW DC ROOF MOUNT SOLAR PV SYSTEM WITH (N) 06 JINKO SOLAR: JKM390M-72HBL-V 390W PV MODULES WITH (N) 06 ENPHASE IQ8PLUS-72-2-US 290W MICRO INVERTERS EQUIPPED WITH RAPID SHUTDOWN

EXISTING:
(E) 11.550 kW DC ROOF MOUNT SOLAR PV SYSTEM WITH (E) 30 MISSION SOLAR: MSE385SX5R 385W MODULES WITH (E) 30 ENPHASE IQ8PLUS-72-2-US 290W MICRO INVERTERS EQUIPPED WITH RAPID SHUTDOWN

AUTHORITIES HAVING JURISDICTION:
BUILDING: HARNETT COUNTY
ZONING: HARNETT COUNTY
UTILITY: DUKE ENERGY

SHEET INDEX

PV-1 COVER SHEET
PV-2 SITE PLAN
PV-3 ROOF PLAN & MODULES
PV-4 ELECTRICAL PLAN
PV-5 STRUCTURAL DETAIL
PV-6 ELECTRICAL LINE DIAGRAM
PV-7 WIRING CALCULATIONS
PV-8 LABELS
PV-9+ EQUIPMENT SPECIFICATIONS

SIGNATURE

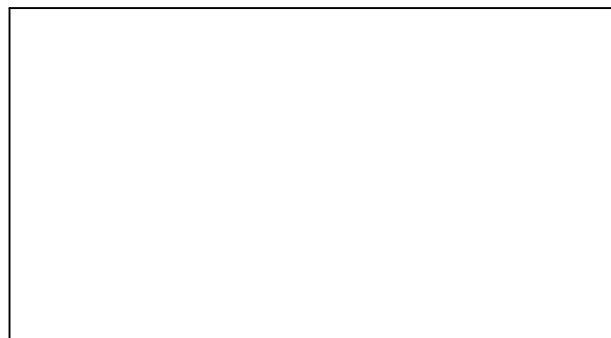

GENERAL NOTES

- ALL COMPONENTS ARE UL LISTED AND CEC CERTIFIED, WHERE WARRANTED.
- THE SOLAR PV SYSTEM WILL BE INSTALLED IN ACCORDANCE WITH ARTICLE 690 OF THE NEC 2017.
- THE UTILITY INTERCONNECTION APPLICATION MUST BE APPROVED AND PV SYSTEM INSPECTED PRIOR TO PARALLEL OPERATION.
- ALL CONDUCTORS OF A CIRCUIT, INCLUDING THE EGC, MUST BE INSTALLED IN THE SAME RACEWAY, OR CABLE, OR OTHERWISE RUN WITH THE PV ARRAY CIRCUIT CONDUCTORS WHEN THEY LEAVE THE VICINITY OF THE PV ARRAY.
- WHERE METALLIC CONDUIT CONTAINING DC CONDUCTORS IS USED INSIDE THE BUILDING, IT SHALL BE IDENTIFIED AS "CAUTION: SOLAR CIRCUIT" EVERY 10FT.
- HEIGHT OF THE AC DISCONNECT SHALL NOT EXCEED 6'-7" PER NEC CODE 240.24.
- A GROUNDING ELECTRODE SYSTEM IN ACCORDANCE WITH CEC 690.47 AND 250.50 THROUGH 60 AND 250-166 SHALL BE PROVIDED. PER NEC GROUNDING ELECTRODE SYSTEM OF EXISTING BUILDING MAY BE USED AND BONDED TO THE SERVICE ENTRANCE. IF EXISTING SYSTEM IS INACCESSIBLE OR INADEQUATE A SUPPLEMENTAL GROUNDING ELECTRODE WILL BE USED AT THE INVERTER LOCATION CONSISTING OF A UL LISTED 8 FT. GROUND ROD WITH ACORN CLAMP. GROUNDING ELECTRODE CONDUCTORS SHALL BE NO LESS THAN #8 AWG AND NO LARGER THAN #6 AWG COPPER AND BONDED TO THE EXISTING GROUNDING ELECTRODE TO PROVIDE FOR A COMPLETE SYSTEM.
- PHOTOVOLTAIC MODULES ARE TO BE CONSIDERED NON-COMBUSTIBLE.
- PHOTOVOLTAIC INSTALLATION WILL NOT OBSTRUCT ANY PLUMBING, MECHANICAL, OR BUILDING ROOF VENTS.
- ALL WIRING MUST BE PROPERLY SUPPORTED BY DEVICES OR MECHANICAL MEANS DESIGNED AND LISTED FOR SUCH USE. WIRING MUST BE PERMANENTLY AND COMPLETELY HELD OFF THE ROOF SURFACE.
- ALL SINAGE TO BE PLACED IN ACCORDANCE WITH THE LOCAL BUILDING CODE. IF EXPOSED TO SUNLIGHT, IT SHALL BE UV RESISTANT. ALL PLAQUES AND SINAGE WILL BE INSTALLED AS REQUIRED BY THE NEC AND AHJ.
- INVERTER(S) USED IN UNGROUNDED SYSTEM SHALL BE UL 1741 LISTED.
- THE INSTALLATION OF EQUIPMENT AND ALL ASSOCIATED WIRING AND INTERCONNECTION SHALL BE PERFORMED ONLY BY QUALIFIED PERSONS [NEC 690.4(C)]
- ALL OUTDOOR EQUIPMENT SHALL BE NEMA 3R RATED (OR BETTER), INCLUDING ALL ROOF MOUNTED TRANSITION BOXES AND SWITCHES.
- ALL EQUIPMENT SHALL BE PROPERLY GROUNDED AND BONDED IN ACCORDANCE WITH NEC ARTICLE 250.
- SYSTEM GROUNDING SHALL BE IN ACCORDANCE WITH NEC 690.41.
- PV SYSTEM CIRCUITS INSTALLED ON OR IN BUILDINGS SHALL INCLUDE A RAPID SHUTDOWN FUNCTION IN ACCORDANCE WITH NEC 690.12
- DISCONNECTING MEANS SHALL BE LOCATED IN A VISIBLE, READILY ACCESSIBLE LOCATION WITHIN THE PV SYSTEM EQUIPMENT OR A MAXIMUM OF 10 FEET AWAY FROM THE SYSTEM [NEC 690.13(A)]
- ALL WIRING METHODS SHALL BE IN ACCORDANCE WITH NEC 690.31
- WORK CLEARANCES AROUND ELECTRICAL EQUIPMENT WILL BE MAINTAINED PER NEC 110.26(A)(1), 110.26(A)(2) AND 110.26(A)(3).
- ROOFTOP MOUNTED PHOTOVOLTAIC PANELS AND MODULES SHALL BE TESTED, LISTED & IDENTIFIED IN ACCORDANCE WITH UL1703
- ELECTRICAL CONTRACTOR TO PROVIDE CONDUIT EXPANSION JOINTS AND ANCHOR CONDUIT RUNS AS REQUIRED PER NEC.

VICINITY MAP



HOUSE PHOTO



CODE REFERENCES

2018 NORTH CAROLINA BUILDING CODE
2018 NORTH CAROLINA RESIDENTIAL CODE
2018 NORTH CAROLINA FIRE CODE
2017 NATIONAL ELECTRICAL CODE

REVISIONS		
DESCRIPTION	DATE	REV
INITIAL DESIGN	10/25/2024	

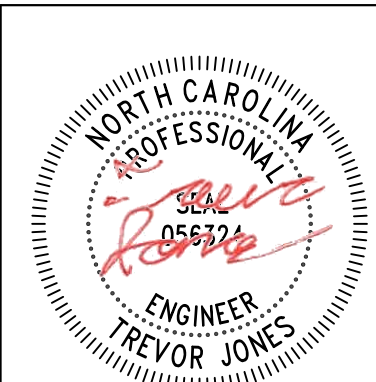

STRUCTURAL ONLY
10/25/2024

PROJECT NAME & ADDRESS

MICHAEL SPERICO
RESIDENCE
165 JARED DR,
FUQUAY VARINA, NC 27526

DRAWN BY
ESR

SHEET NAME
COVER SHEET

SHEET SIZE
ANSI B
11" X 17"

SHEET NUMBER
PV-1

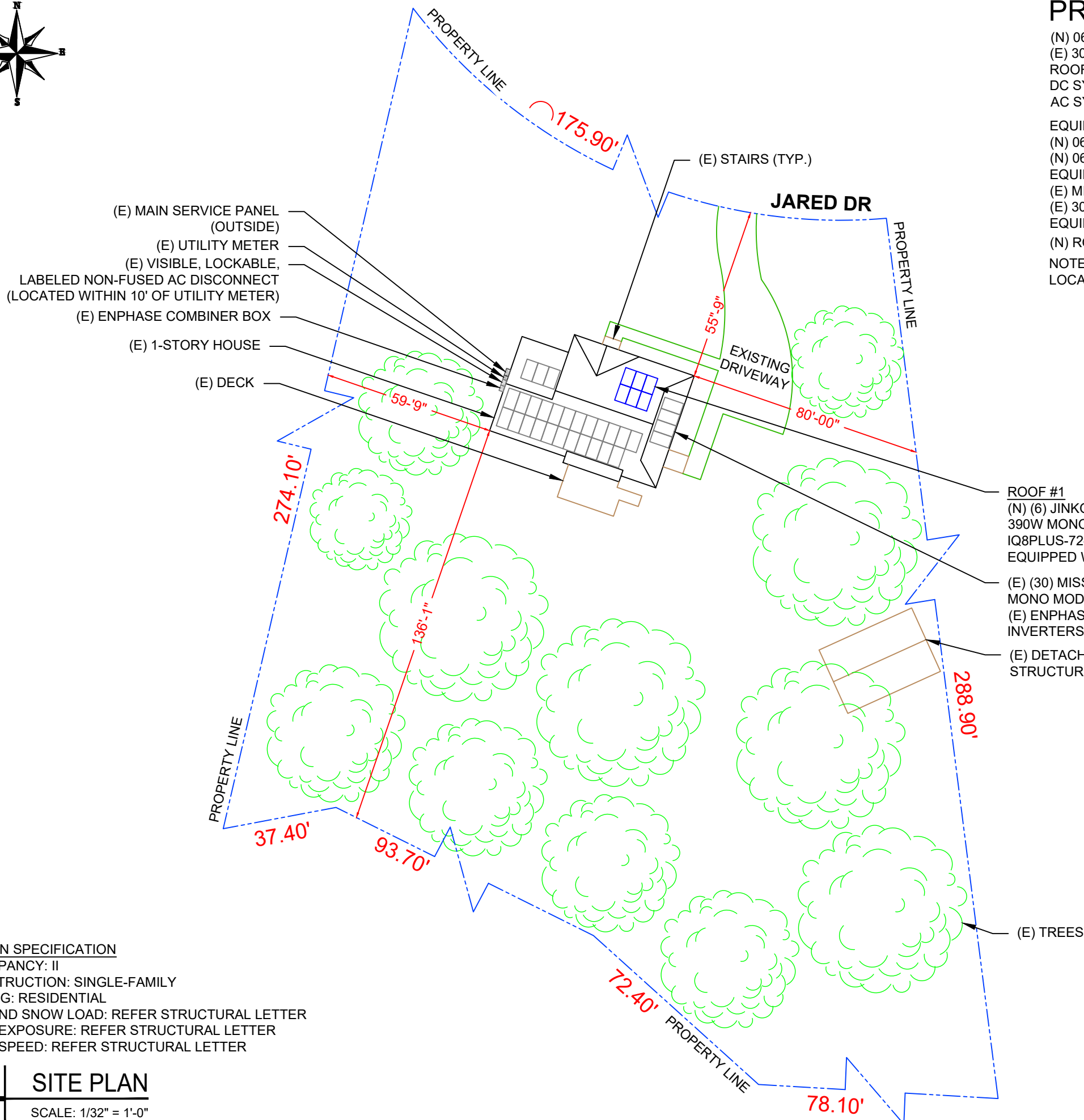
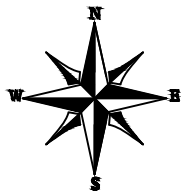

- (E) MAIN SERVICE PANEL (OUTSIDE)
- (E) UTILITY METER
- (E) VISIBLE, LOCKABLE, LABELED NON-FUSED AC DISCONNECT (LOCATED WITHIN 10' OF UTILITY METER)
- (E) ENPHASE COMBINER BOX
- (E) 1-STORY HOUSE
- (E) DECK

PROJECT DESCRIPTION:

(N) 06 X JINKO SOLAR: JKM390M-72HBL-V 390W MONO MODULES AND
 (E) 30 X MISSION SOLAR: MSE385SX5R 385W MONO MODULES
 ROOF MOUNTED SOLAR PHOTOVOLTAIC MODULES
 DC SYSTEM SIZE: (N) 06 x 390W + (E) 30 x 385W = 13.890 kW DC
 AC SYSTEM SIZE: (N) 06 x 290W + (E) 30 x 290W = 10.440 kW AC

EQUIPMENT SUMMARY
 (N) 06 JINKO SOLAR: JKM390M-72HBL-V 390W MONO MODULES
 (N) 06 ENPHASE IQ8PLUS-72-2-US 290W MICRO INVERTERS EQUIPPED WITH RAPID SHUTDOWN
 (E) MISSION SOLAR: MSE385SX5R 385W MONO MODULES
 (E) 30 ENPHASE IQ8PLUS-72-2-US 290W MICRO INVERTERS EQUIPPED WITH RAPID SHUTDOWN
 (N) ROOF ARRAY AREA #1:- 129.96 SQ FT.
 NOTE: VISIBLE, LOCKABLE, LABELED AC DISCONNECT LOCATED WITHIN 10' OF UTILITY METER



TOP TIER SOLAR SOLUTIONS
 1530 CENTER PARK DR #2911,
 CHARLOTTE, NC 28217,
 UNITED STATES

REVISIONS		
DESCRIPTION	DATE	REV
INITIAL DESIGN	10/25/2024	

ENGINEER
TREVOR JONES
 STRUCTURAL ONLY
 10/25/2024

PROJECT NAME & ADDRESS
MICHAEL SPERICO RESIDENCE
 165 JARED DR,
 FUQUAY VARINA, NC 27526

DRAWN BY
ESR

SHEET NAME
SITE PLAN

SHEET SIZE
**ANSI B
 11" X 17"**

SHEET NUMBER
PV-2

DESIGN SPECIFICATION
 OCCUPANCY: II
 CONSTRUCTION: SINGLE-FAMILY
 ZONING: RESIDENTIAL
 GROUND SNOW LOAD: REFER STRUCTURAL LETTER
 WIND EXPOSURE: REFER STRUCTURAL LETTER
 WIND SPEED: REFER STRUCTURAL LETTER

MODULE TYPE, DIMENSIONS & WEIGHT

NUMBER OF MODULES = 06 MODULES
 MODULE TYPE = JINKO SOLAR: JKM390M-72HBL-V 390W MONO MODULES
 MODULE WEIGHT = 49.6 LBS / 22.5KG.
 MODULE DIMENSIONS = 79.06" x 39.45" = 21.66 SF

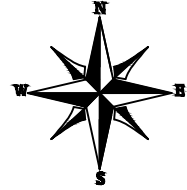

ROOF DESCRIPTION					
ROOF TYPE			ASPHALT SHINGLE		
ROOF LAYER			1 LAYER		
ROOF	# OF MODULES	ROOF PITCH	AZIMUTH	TRUSS SIZE	TRUSS SPACING
#1	6	40°	19°	2"X4"	24"

ARRAY AREA & ROOF AREA CALC'S			
PV SYSTEM	TOTAL PV ARRAY AREA (SQ. FT.)	TOTAL ROOF AREA (Sq. Ft.)	ROOF AREA COVERED BY ARRAY (%)
NEW	129.96	1749.93	7
EXISTING	649.20	1749.93	37
TOTAL	757.50	1749.93	43

TOP TIER SOLAR SOLUTIONS

1530 CENTER PARK DR #2911,
 CHARLOTTE, NC 28217,
 UNITED STATES

REVISIONS		
DESCRIPTION	DATE	REV
INITIAL DESIGN	10/25/2024	

NORTH CAROLINA PROFESSIONAL ENGINEER

TREVOR JONES

STRUCTURAL ONLY
 10/25/2024

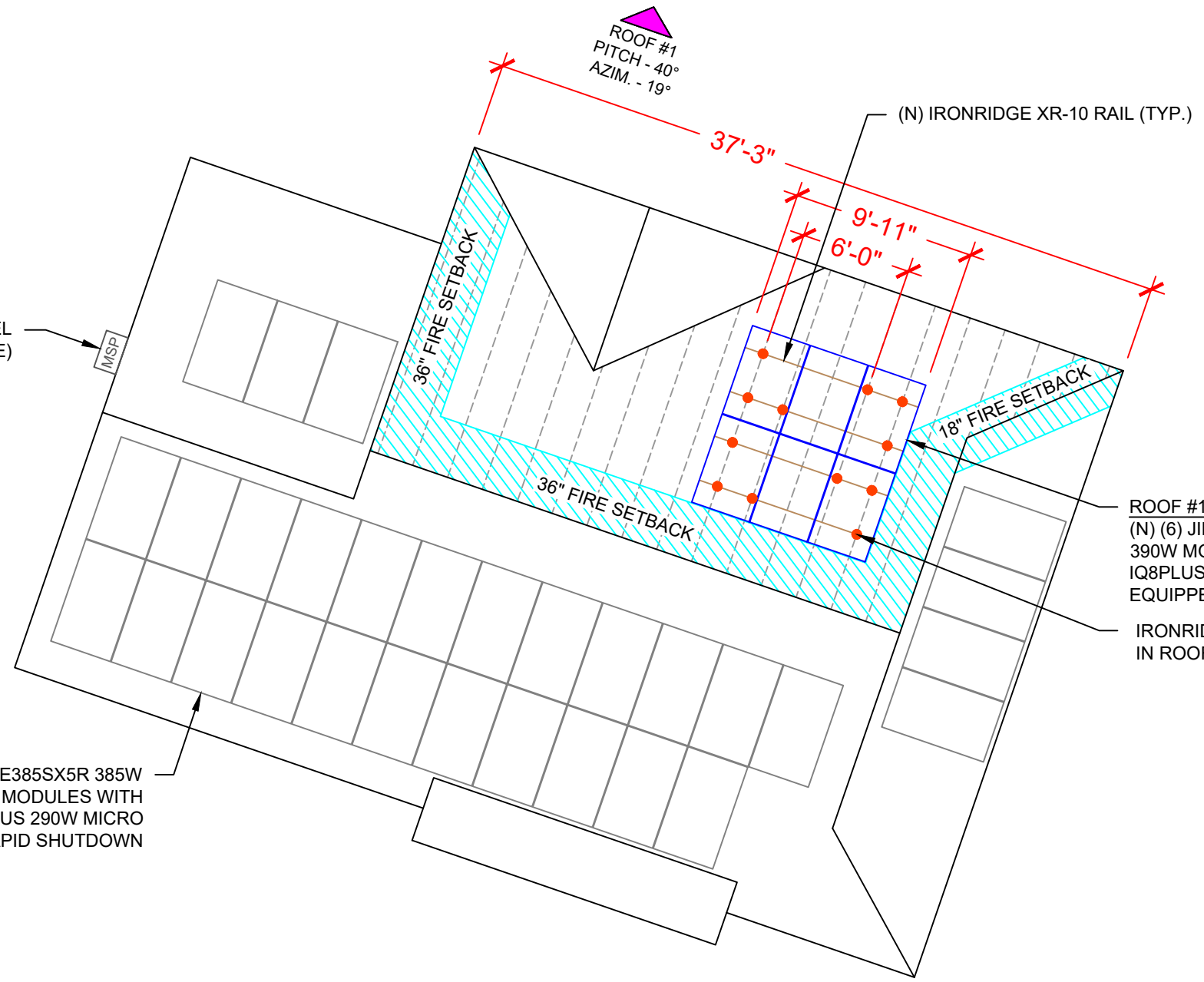

(E) MAIN SERVICE PANEL (OUTSIDE)

(E) (30) MISSION SOLAR: MSE385SX5R 385W MONO MODULES WITH
 (E) ENPHASE IQ8PLUS-72-2-US 290W MICRO INVERTERS EQUIPPED WITH RAPID SHUTDOWN

ROOF #1
 (N) (6) JINKO SOLAR: JKM390M-72HBL-V 390W MONO MODULES WITH (N) ENPHASE IQ8PLUS-72-2-US 290W MICRO INVERTERS EQUIPPED WITH RAPID SHUTDOWN
 IRONRIDGE HALO ULTRAGRIP ATTACHMENTS IN ROOF TRUSS TOP CHORD ONLY

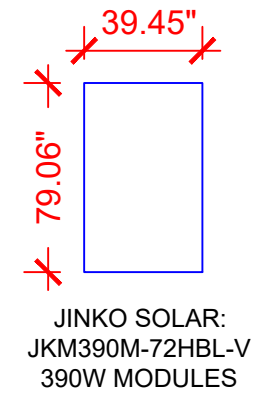

LEGEND

- JB - JUNCTION BOX
- CB - COMBINER BOX
- ACD - AC DISCONNECT
- UM - UTILITY METER
- MSP - MAIN SERVICE PANEL
- SUB - SUBPANEL
- - VENT, ATTIC FAN (ROOF OBSTRUCTION)
- - ROOF ATTACHMENT
- - - TRUSS
- - - CONDUIT

PROJECT NAME & ADDRESS

MICHAEL SPERICO RESIDENCE

165 JARED DR,
 FUQUAY VARINA, NC 27526

DRAWN BY
ESR

SHEET NAME
ROOF PLAN & MODULES

SHEET SIZE
**ANSI B
 11" X 17"**

SHEET NUMBER
PV-3

DC SYSTEM SIZE: (N) 06 x 390W + (E) 30 x 385W = 13.890 kW DC
 AC SYSTEM SIZE: (N) 06 x 290W + (E) 30 x 290W = 10.440 kW AC

(N) 06 JINKO SOLAR: JKM390M-72HBL-V 390W MONO MODULES
 (N) 06 ENPHASE IQ8PLUS-72-2-US 290W MICRO INVERTERS
 EQUIPPED WITH RAPID SHUTDOWN
 LOCATED UNDER EACH PANEL (240V)
 (E) 30 MISSION SOLAR: MSE385SX5R 385W MONO MODULES
 (E) 30 ENPHASE IQ8PLUS-72-2-US 290W MICRO INVERTERS WITH
 RAPID SHUTDOWN

CIRCUIT LEGENDS

- - - (E) CIRCUIT #1
- - - (E) CIRCUIT #2
- - - (E) CIRCUIT #3
- - - (N) CIRCUIT #4

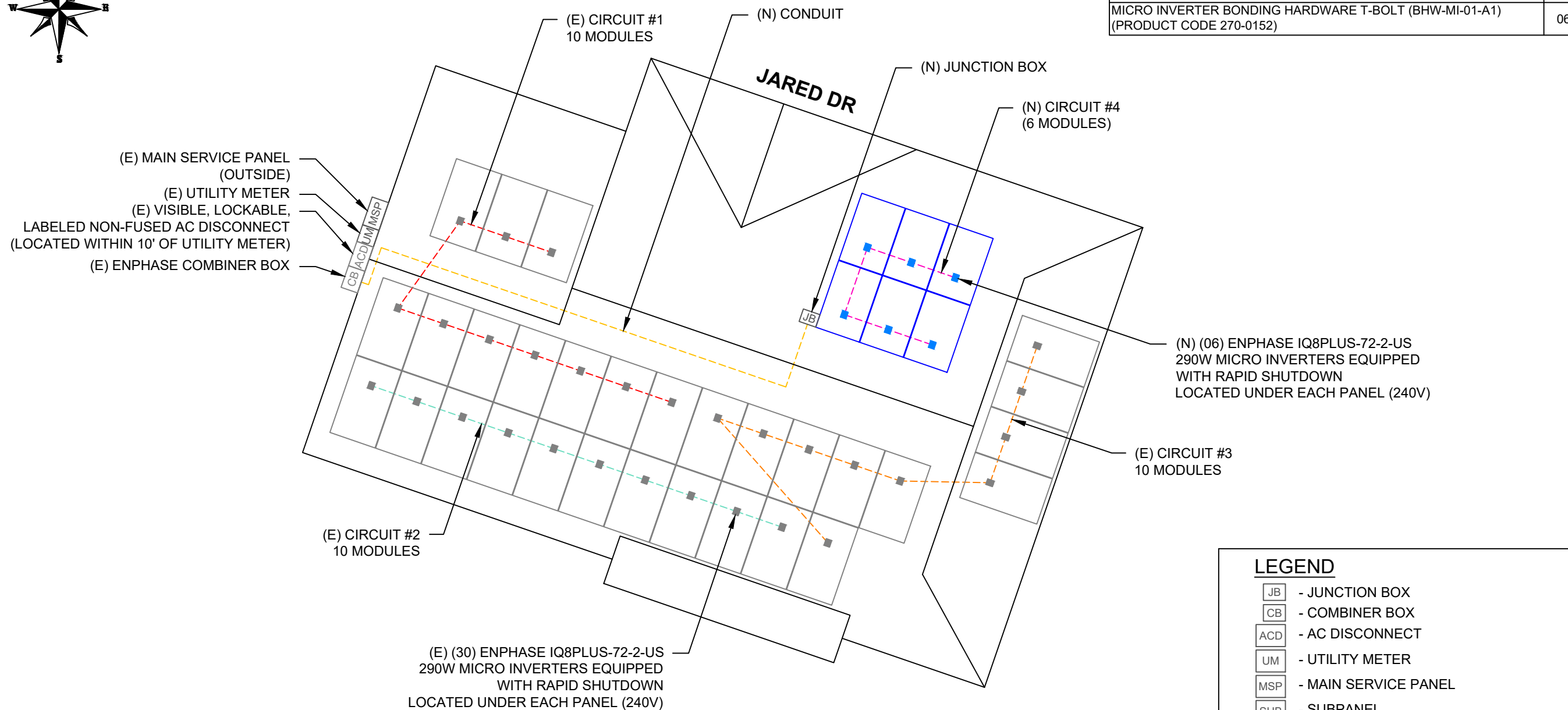
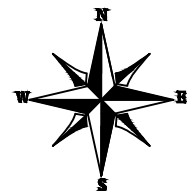

BILL OF MATERIALS	
EQUIPMENT DESCRIPTION	QTY
SOLAR PV MODULES: JINKO SOLAR: JKM390M-72HBL-V 390W MODULE	06
MICRO INVERTERS: ENPHASE IQ8PLUS-72-2-US 290W MICRO INVERTERS EQUIPPED WITH RAPID SHUTDOWN	06
20A BREAKER	1
JUNCTION BOX: JUNCTION BOX UL 1741, NEMA 3R CSA C22.2 NO.290	1
IRONRIDGE XR10 RAIL (RAIL 168" (14 FEET) CLEAR) (XR-10-168A)	4
UNIVERSAL MODULE CLAMP, CLEAR (UFO-CL-01-A1)	8
END FASTENING OBJECT (END CLAMP, 30-40MM), MILL (UFO-END-01-A1)	8
GROUNDING LUG (XR-LUG-03-A1)	2
IRONRIDGE HALO ULTRAGRIP ATTACHMENTS (QM-HUG-01-M1)	10
RD STRUCTURAL SCREW, 3.0L (HW-RD1430-01-M1)	20
T-BOLT BONDING HARDWARE (BHW-TB-02-A1) (PRODUCT CODE 590-0116)	10
MICRO INVERTER BONDING HARDWARE T-BOLT (BHW-MI-01-A1) (PRODUCT CODE 270-0152)	06

TOP TIER
SOLAR SOLUTIONS

TOP TIER SOLAR SOLUTIONS

1530 CENTER PARK DR #2911,
CHARLOTTE, NC 28217,
UNITED STATES

REVISIONS		
DESCRIPTION	DATE	REV
INITIAL DESIGN	10/25/2024	

PROJECT NAME & ADDRESS

**MICHAEL SPERICO
RESIDENCE**

165 JARED DR,
FUQUAY VARINA, NC 27526

DRAWN BY
ESR

SHEET NAME
ELECTRICAL PLAN

SHEET SIZE
**ANSI B
11" X 17"**

SHEET NUMBER
PV-4

LEGEND

	- JUNCTION BOX
	- COMBINER BOX
	- AC DISCONNECT
	- UTILITY METER
	- MAIN SERVICE PANEL
	- SUBPANEL
	- VENT, ATTIC FAN (ROOF OBSTRUCTION)
	- ROOF ATTACHMENT
	- TRUSS
	- CONDUIT



TOP TIER SOLAR SOLUTIONS

1530 CENTER PARK DR #2911,
CHARLOTTE, NC 28217,
UNITED STATES

REVISIONS		
DESCRIPTION	DATE	REV
INITIAL DESIGN	10/25/2024	

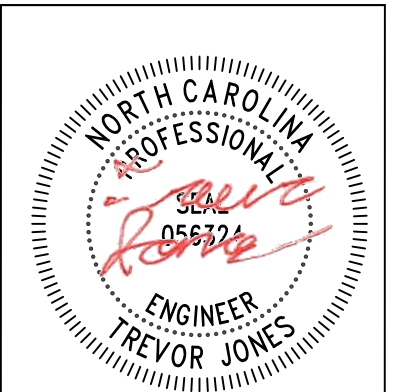

STRUCTURAL ONLY
10/25/2024

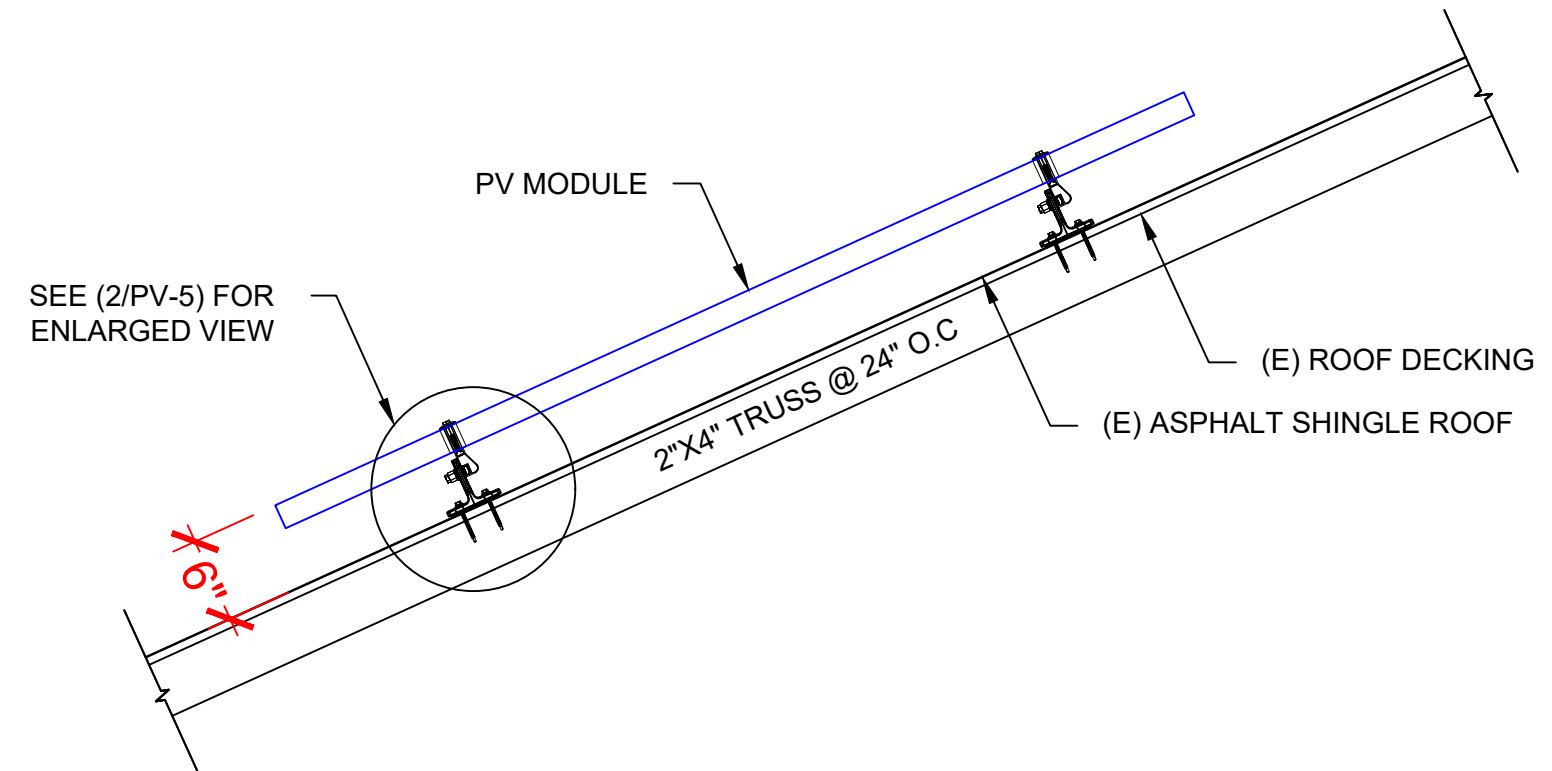

1 | STRUCTURAL ATTACHMENT (Side view)
PV-5 | SCALE: N.T.S

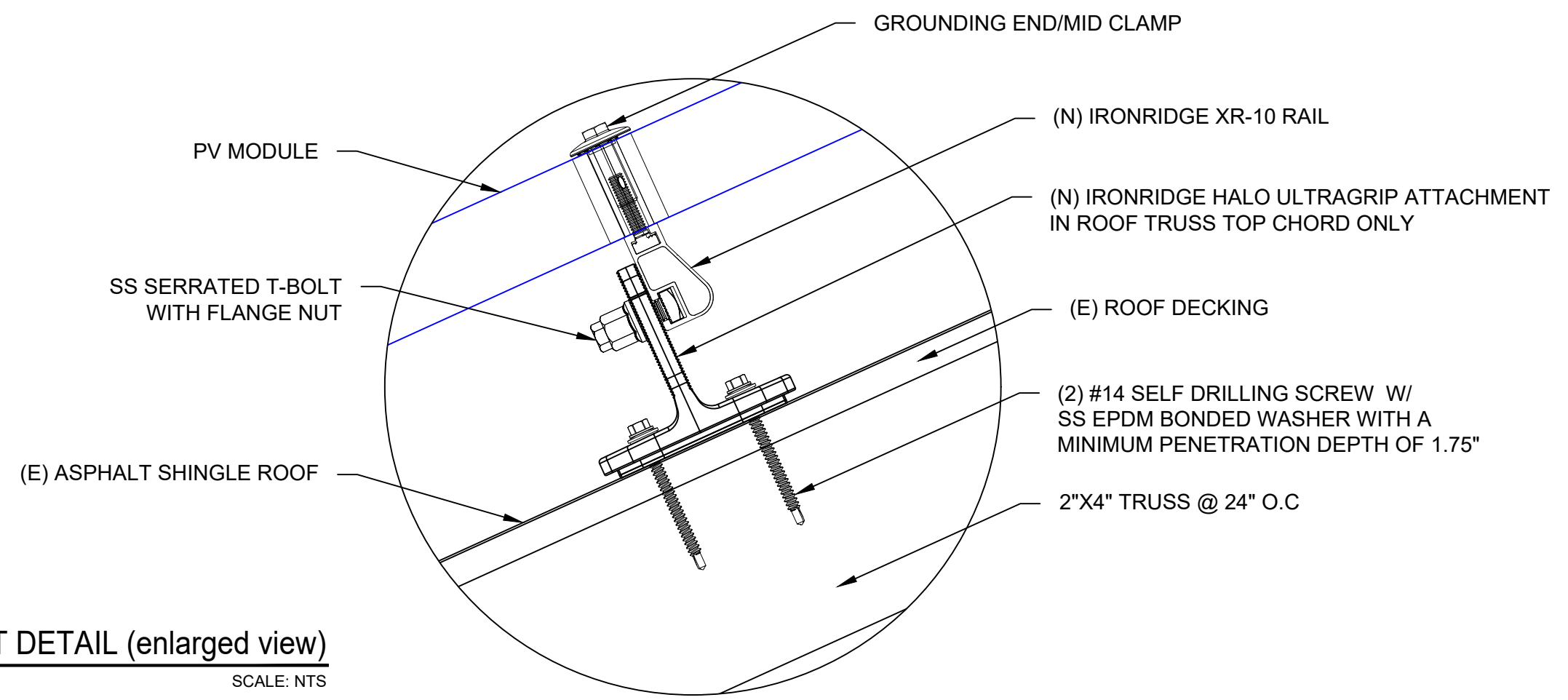

2 | ATTACHMENT DETAIL (enlarged view)
PV-5 | SCALE: NTS

PROJECT NAME & ADDRESS

MICHAEL SPERICO
RESIDENCE
165 JARED DR,
FUQUAY VARINA, NC 27526

DRAWN BY
ESR

SHEET NAME
STRUCTURAL DETAIL

SHEET SIZE
ANSI B
11" X 17"

SHEET NUMBER
PV-5

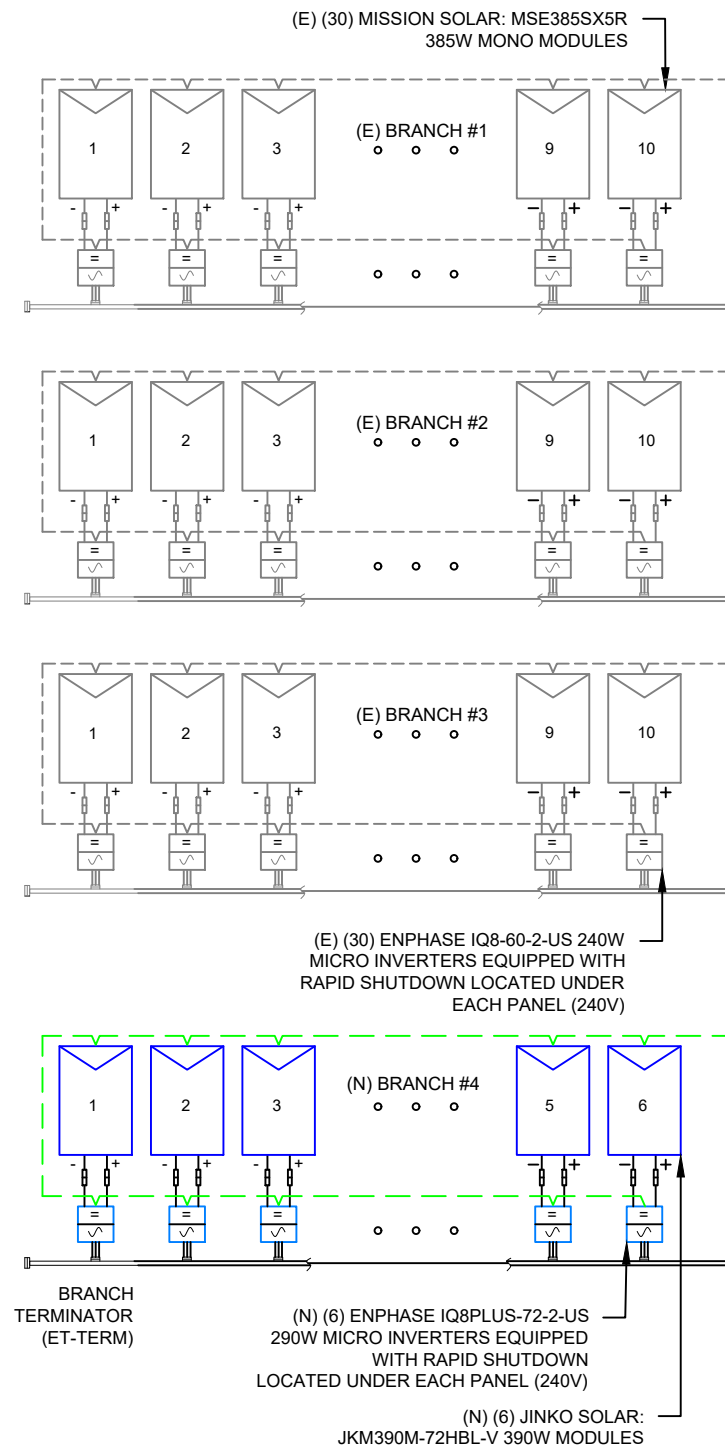

DC SYSTEM SIZE: (N) 06 x 390W + (E) 30 x 385W = 13.890 kW DC
 AC SYSTEM SIZE: (N) 06 x 290W + (E) 30 x 290W = 10.440 kW AC

(N) 06 JINKO SOLAR: JKM390M-72HBL-V 390W MONO MODULES
 (N) 06 ENPHASE IQ8PLUS-72-2-US 290W MICRO INVERTERS EQUIPPED WITH RAPID SHUTDOWN LOCATED UNDER EACH PANEL (240V)
 (E) 30 MISSION SOLAR: MSE385SX5R 385W MONO MODULES
 (E) 30 ENPHASE IQ8PLUS-72-2-US 290W MICRO INVERTERS WITH RAPID SHUTDOWN
 (03) BRANCH CIRCUITS OF (E) 10 MODULES AND
 (01) BRANCH CIRCUIT OF (N) 06 MODULES ARE CONNECTED IN PARALLEL

NOTE: CONDUIT TO BE UL LISTED FOR WET LOCATIONS AND UV PROTECTED

NOTE: WIRE SCHEDULE CALLOUT "1A, 2A, 3, 4" ARE EXISTING SYSTEMS

(E) ENPHASE IQ COMBINER
 X-IQ-AM1-240-4/4C 120/240VAC,
 1φ, 3W 125A RATED BUS BAR,
 NEMA 3R SOLAR LOADS ONLY
 UL 1741 COMPLIANT

IQ ENVOY : PER MANUFACTURER SPECIFICATIONS, EITHER 10A OR 15A BREAKER IS SUITABLE FOR USE

(E) JUNCTION BOX,
 600V, NEMA 3R,
 UL LISTED

QTY	CONDUCTOR INFORMATION	CONDUIT TYPE	CONDUIT SIZE
(2)	#12AWG - ENPHASE ENGAGE CABLE (L1 & L2 NO NEUTRAL)	N/A	N/A
(1)	#6AWG - BARE COPPER IN FREE AIR	N/A	N/A
(6)	#12AWG - ENPHASE ENGAGE CABLE (L1 & L2 NO NEUTRAL)	N/A	N/A
(1A)	#6AWG - BARE COPPER IN FREE AIR		
(2)	#10AWG - CU, THWN-2	EMT OR LFMC IN ATTIC	3/4"
(1)	#10AWG - CU, THWN-2 GND		
(6)	#10AWG - CU, THWN-2	EMT OR LFMC IN ATTIC	3/4"
(1)	#10AWG - CU, THWN-2 GND		
(2)	#6AWG - CU, THWN-2		
(1)	#6AWG - CU, THWN-2 N	EMT, LFMC OR PVC	3/4"
(1)	#10AWG - CU, THWN-2 GND		
(2)	#6AWG - CU, THWN-2		
(1)	#6AWG - CU, THWN-2 N	EMT, LFMC OR PVC	3/4"
(1)	#10AWG - CU, THWN-2 GND		

BACKFEED BREAKER CALCULATION (120% RULE):
 MAIN BUSS X 1.2 - MAIN BREAKER => PV BREAKER
 200A X 1.2 - 175A >= 60A
 65A => 60A HENCE OK

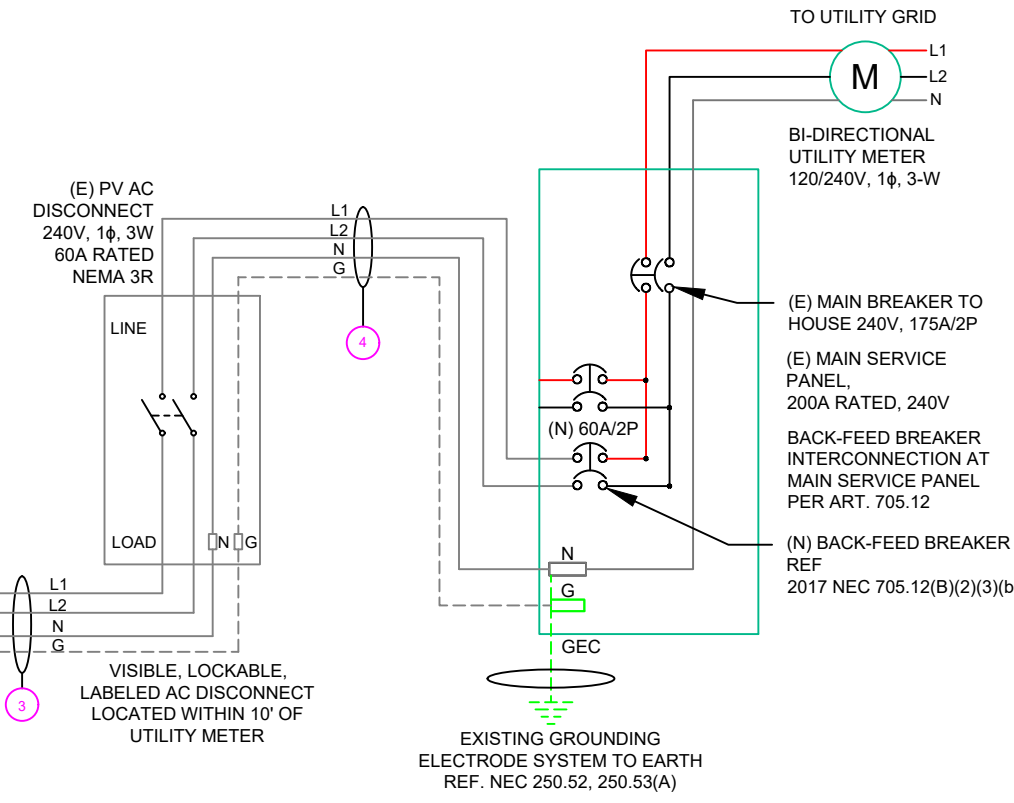

GROUNDING & GENERAL NOTES:

- PV GROUNDING ELECTRODE SYSTEM NEEDS TO BE INSTALLED IN ACCORDANCE WITH [NEC 690.43]
- PV INVERTER IS UNGROUNDED, TRANSFORMER-LESS TYPE.
- DC GEC AND AC EGC TO REMAIN UNSPLICED, OR SPLICED TO EXISTING ELECTRODE
- ANY EXISTING WIRING INVOLVED WITH PV SYSTEM CONNECTION THAT IS FOUND TO BE INADEQUATE PER CODE SHALL BE CORRECTED PRIOR TO FINAL INSPECTION.
- JUNCTION BOX QUANTITIES, AND PLACEMENT SUBJECT TO CHANGE IN THE FIELD - JUNCTION BOX DEPICTED ON ELECTRICAL DIAGRAM REPRESENT WIRE TYPE TRANSITIONS.
- AC DISCONNECT NOTED IN EQUIPMENT SCHEDULE OPTIONAL IF OTHER AC DISCONNECTING MEANS IS LOCATED WITHIN 10' OF SERVICE DISCONNECT.
- RACEWAYS AND CABLES EXPOSED TO SUNLIGHT ON ROOFTOPS SHOULD BE INSTALLED MORE THAN 7/8" ABOVE THE ROOF USING CONDUIT SUPPORTS.

RACKING NOTE:

- BOND EVERY OTHER RAIL WITH #6 BARE COPPER

INTERCONNECTION NOTES:

- INTERCONNECTION SIZING, LIMITATIONS AND COMPLIANCE DETERMINED IN ACCORDANCE WITH [NEC 705.12], AND [NEC 690.59].
- GROUND FAULT PROTECTION IN ACCORDANCE WITH [NEC 215.9], [NEC 230.95].
- ALL EQUIPMENT TO BE RATED FOR BACKFEEDING.
- PV BREAKER TO BE POSITIONED AT THE OPPOSITE END OF THE BUSBAR RELATIVE TO THE MAIN BREAKER.

DISCONNECT NOTES:

- DISCONNECTING SWITCHES SHALL BE WIRED SUCH THAT WHEN THE SWITCH IS OPENED THE CONDUCTORS REMAINING LIVE ARE CONNECTED TO THE TERMINALS MARKED "LINE SIDE" (TYPICALLY THE UPPER TERMINALS)
- AC DISCONNECT MUST BE ACCESSIBLE TO QUALIFIED UTILITY PERSONNEL, BE LOCKABLE, AND BE A VISIBLE-BREAK SWITCH
- DISCONNECT MEANS AND THEIR LOCATION SHALL BE IN ACCORDANCE WITH [NEC 225.31] AND [NEC 225.32].

TOP TIER SOLAR SOLUTIONS

1530 CENTER PARK DR #2911,
 CHARLOTTE, NC 28217,
 UNITED STATES

REVISIONS

DESCRIPTION	DATE	REV
INITIAL DESIGN	10/25/2024	

PROJECT NAME & ADDRESS

MICHAEL SPERICO RESIDENCE

165 JARED DR,
 FUQUAY VARINA, NC 27526

DRAWN BY
ESR

SHEET NAME
ELECTRICAL LINE DIAGRAM

SHEET SIZE
**ANSI B
 11" X 17"**

SHEET NUMBER
PV-6

INVERTER SPECIFICATIONS	
MANUFACTURER / MODEL #	ENPHASE IQ8PLUS-72-2-US 290W MICRO INVERTERS EQUIPPED WITH RAPID SHUTDOWN
MIN/MAX DC VOLT RATING	22V MIN/ 60V MAX
MAX INPUT POWER	235W-440W
NOMINAL AC VOLTAGE RATING	240V/ 211-264V
MAX AC CURRENT	1.21A
MAX MODULES PER CIRCUIT	13 (SINGLE PHASE)
MAX OUTPUT POWER	290 VA

SOLAR MODULE SPECIFICATIONS	
MANUFACTURER / MODEL #	JINKO SOLAR: JKM390M-72HBL-V 390 W MODULE
VMP	39.64V
IMP	9.84A
VOC	48.60V
ISC	10.46A
TEMP. COEFF. VOC	-0.29%/°C
MODULE DIMENSION	79.06"L x 39.45"W x 1.57"D (In Inch)

AMBIENT TEMPERATURE SPECS	
AMBIENT TEMP (HIGH TEMP 2%)	36°
RECORD LOW TEMP	-11°
MODULE TEMPERATURE COEFFICIENT OF Voc	-0.29%/°C

PERCENT OF VALUES	NUMBER OF CURRENT CARRYING CONDUCTORS IN EMT
.80	4-6
.70	7-9
.50	10-20

AC CALCULATIONS																						
CIRCUIT ORIGIN	CIRCUIT DESTINATION	VOLTAGE (V)	FULL LOAD AMPS "FLA" (A)	FLA*1.25 (A)	OC PD SIZE (A)	NEUTRAL SIZE	GROUND SIZE	CONDUCTOR SIZE	75°C AMPACITY (A)	AMPACITY CHECK #1	AMBIENT TEMP. (°C)	TOTAL CC CONDUCTORS IN RACEWAY	90°C AMPACITY (A)	DERATION FACTOR FOR AMBIENT TEMPERATURE NEC 310.15(B)(2)(a)	DERATION FACTOR FOR CONDUCTORS PER RACEWAY NEC 310.15(B)(3)(a)	90°C AMPACITY DERATED (A)	AMPACITY CHECK #2	FEEDER LENGTH (FEET)	CONDUCTOR RESISTANCE (OHM/KFT)	VOLTAGE DROP AT FLA (%)	CONDUIT SIZE	CONDUIT FILL (%)
CIRCUIT 1	JUNCTION BOX	240	12.1	15.125	20	N/A	BARE COPPER #6 AWG	CU #12 AWG	25	PASS	36	2	30	0.91	1	27.3	PASS			0.46	N/A	#N/A
CIRCUIT 2	JUNCTION BOX	240	12.1	15.125	20	N/A	BARE COPPER #6 AWG	CU #12 AWG	25	PASS	36	2	30	0.91	1	27.3	PASS			0.46	N/A	#N/A
CIRCUIT 3	JUNCTION BOX	240	12.1	15.125	20	N/A	BARE COPPER #6 AWG	CU #12 AWG	25	PASS	36	2	30	0.91	1	27.3	PASS			0.46	N/A	#N/A
CIRCUIT 4	JUNCTION BOX	240	7.26	9.075	20	N/A	BARE COPPER #6 AWG	CU #12 AWG	25	PASS	36	2	30	0.91	1	27.3	PASS			0.18	N/A	#N/A
JUNCTION BOX	COMBINER BOX	240	12.1	15.125	20	N/A	CU #10 AWG	CU #10 AWG	35	PASS	36	8	40	0.91	0.7	25.48	PASS	20	1.24	0.250	3/4" EMT	35.62852
COMBINER BOX	AC DISCONNECT	240	43.56	54.45	60	CU #6 AWG	CU #10 AWG	CU #6 AWG	65	PASS	36	2	75	0.91	1	68.25	PASS	5	0.491	0.089	3/4" EMT	32.49531
AC DISCONNECT	POI	240	43.56	54.45	60	CU #6 AWG	CU #10 AWG	CU #6 AWG	65	PASS	36	2	75	0.91	1	68.25	PASS	5	0.491	0.089	3/4" EMT	32.49531

Circuit 1 Voltage Drop	0.888
Circuit 2 Voltage Drop	0.888
Circuit 3 Voltage Drop	0.888
Circuit 4 Voltage Drop	0.608



TOP TIER SOLAR SOLUTIONS

1530 CENTER PARK DR #2911,
CHARLOTTE, NC 28217,
UNITED STATES

REVISIONS		
DESCRIPTION	DATE	REV
INITIAL DESIGN	10/25/2024	

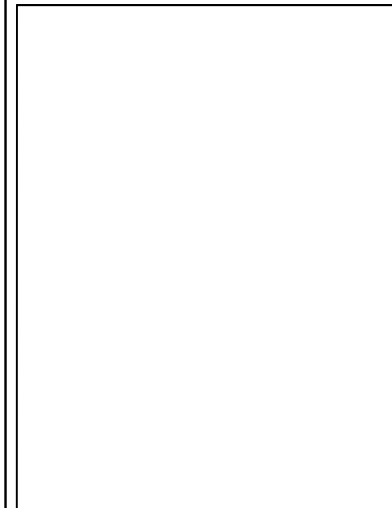

PROJECT NAME & ADDRESS

**MICHAEL SPERICO
RESIDENCE**

165 JARED DR,
FUQUAY VARINA, NC 27526

ELECTRICAL NOTES

- ALL EQUIPMENT TO BE LISTED BY UL OR OTHER NRTL, AND LABELED FOR ITS APPLICATION.
- ALL CONDUCTORS SHALL BE COPPER, RATED FOR 600 V AND 90 DEGREE C WET ENVIRONMENT.
- WIRING, CONDUIT, AND RACEWAYS MOUNTED ON ROOFTOPS SHALL BE ROUTED DIRECTLY TO, AND LOCATED AS CLOSE AS POSSIBLE TO THE NEAREST RIDGE, HIP, OR VALLEY.
- WORKING CLEARANCES AROUND ALL NEW AND EXISTING ELECTRICAL EQUIPMENT SHALL COMPLY WITH NEC 110.26.
- DRAWINGS INDICATE THE GENERAL ARRANGEMENT OF SYSTEMS. CONTRACTOR SHALL FURNISH ALL NECESSARY OUTLETS, SUPPORTS, FITTINGS AND ACCESSORIES TO FULFILL APPLICABLE CODES AND STANDARDS.
- WHERE SIZES OF JUNCTION BOX, RACEWAYS, AND CONDUITS ARE NOT SPECIFIED, THE CONTRACTOR SHALL SIZE THEM ACCORDINGLY.
- ALL WIRE TERMINATIONS SHALL BE APPROPRIATELY LABELED AND READILY VISIBLE.
- MODULE GROUNDING CLIPS TO BE INSTALLED BETWEEN MODULE FRAME AND MODULE SUPPORT RAIL, PER THE GROUNDING CLIP MANUFACTURER'S INSTRUCTION.
- MODULE SUPPORT RAIL TO BE BONDED TO CONTINUOUS COPPER G.E.C. VIA WEEB LUG OR ILSCO GBL-4DBT LAY-IN LUG.
- TEMPERATURE RATINGS OF ALL CONDUCTORS, TERMINATIONS, BREAKERS, OR OTHER DEVICES ASSOCIATED WITH THE SOLAR PV SYSTEM SHALL BE RATED FOR AT LEAST 75 DEGREE C.

DRAWN BY
ESR

SHEET NAME
WIRING CALCULATIONS

SHEET SIZE
**ANSI B
11" X 17"**

SHEET NUMBER
PV-7

⚠ WARNING
ELECTRIC SHOCK HAZARD
TERMINALS ON THE LINE AND LOAD SIDES MAY BE ENERGIZED IN THE OPEN POSITION

LABEL- 1:
 LABEL LOCATION:
 AC DISCONNECT
 CODE REF: NEC 690.13(B)

⚠ WARNING DUAL POWER SOURCE
SECOND SOURCE IS PHOTOVOLTAIC SYSTEM

LABEL- 2:
 LABEL LOCATION:
 UTILITY METER
 MAIN SERVICE PANEL
 SUBPANEL
 CODE REF: NEC 705.12(C) & NEC 690.59

⚠ WARNING
TURN OFF PHOTOVOLTAIC AC DISCONNECT PRIOR TO WORKING INSIDE PANEL

LABEL- 3:
 LABEL LOCATION:
 MAIN SERVICE PANEL
 SUBPANEL
 MAIN SERVICE DISCONNECT
 COMBINER
 CODE REF: NEC 110.27(C) & OSHA 1910.145 (f) (7)

⚠ CAUTION
PHOTOVOLTAIC SYSTEM CIRCUIT IS BACKFEED

LABEL- 4:
 LABEL LOCATION:
 MAIN SERVICE PANEL (ONLY IF SOLAR IS BACK-FED)
 SUBPANEL (ONLY IF SOLAR IS BACK-FED)
 CODE REF: NEC 705.12(B)(3-4) & NEC 690.59

⚠ WARNING
POWER SOURCE OUTPUT CONNECTION. DO NOT RELOCATE THIS OVERCURRENT DEVICE

LABEL- 5:
 LABEL LOCATION:
 MAIN SERVICE PANEL (ONLY IF SOLAR IS BACK-FED)
 SUBPANEL (ONLY IF SOLAR IS BACK-FED)
 CODE REF: NEC 705.12(B)(3)(2)

SOLAR PV SYSTEM EQUIPPED WITH RAPID SHUTDOWN

TURN RAPID SHUTDOWN SWITCH TO THE "OFF" POSITION TO SHUT DOWN PV SYSTEM AND REDUCE SHOCK HAZARD IN THE ARRAY

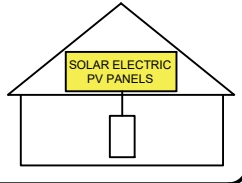

LABEL- 6:
 LABEL LOCATION:
 AC DISCONNECT
 CODE REF: [NEC 690.56(C)(1)(A)]

RAPID SHUTDOWN SWITCH FOR SOLAR PV SYSTEM

LABEL- 7:
 LABEL LOCATION:
 AC DISCONNECT
 CODE REF: NEC 690.56(C)(2)

PHOTOVOLTAIC
AC DISCONNECT

LABEL- 8:
 LABEL LOCATION:
 AC DISCONNECT
 CODE REF: NEC 690.13(B)

PHOTOVOLTAIC AC DISCONNECT

NOMINAL OPERATING AC VOLATGE	240 V
RATED AC OUTPUT CURRENT	43.56 A

LABEL- 9:
 LABEL LOCATION:
 MAIN SERVICE PANEL
 SUBPANEL
 AC DISCONNECT
 CODE REF: NEC 690.54

MAIN PHOTOVOLTAIC SYSTEM DISCONNECT

LABEL- 10:
 LABEL LOCATION:
 MAIN SERVICE DISCONNECT (ONLY IF MAIN SERVICE DISCONNECT IS PRESENT)
 CODE REF: NEC 690.13(B)



TOP TIER SOLAR SOLUTIONS
 1530 CENTER PARK DR #2911,
 CHARLOTTE, NC 28217,
 UNITED STATES

REVISIONS		
DESCRIPTION	DATE	REV
INITIAL DESIGN	10/25/2024	

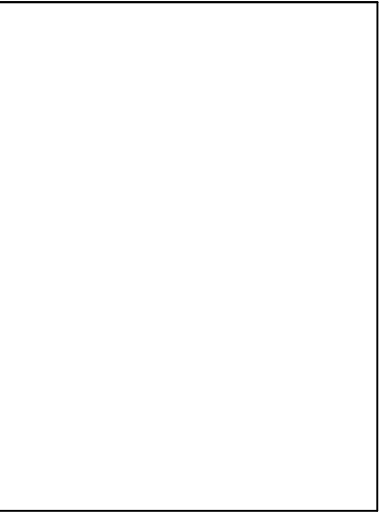

PROJECT NAME & ADDRESS

MICHAEL SPERICO RESIDENCE

**165 JARED DR,
 FUQUAY VARINA, NC 27526**

DRAWN BY
ESR

SHEET NAME
LABELS

SHEET SIZE
**ANSI B
 11" X 17"**

SHEET NUMBER
PV-8

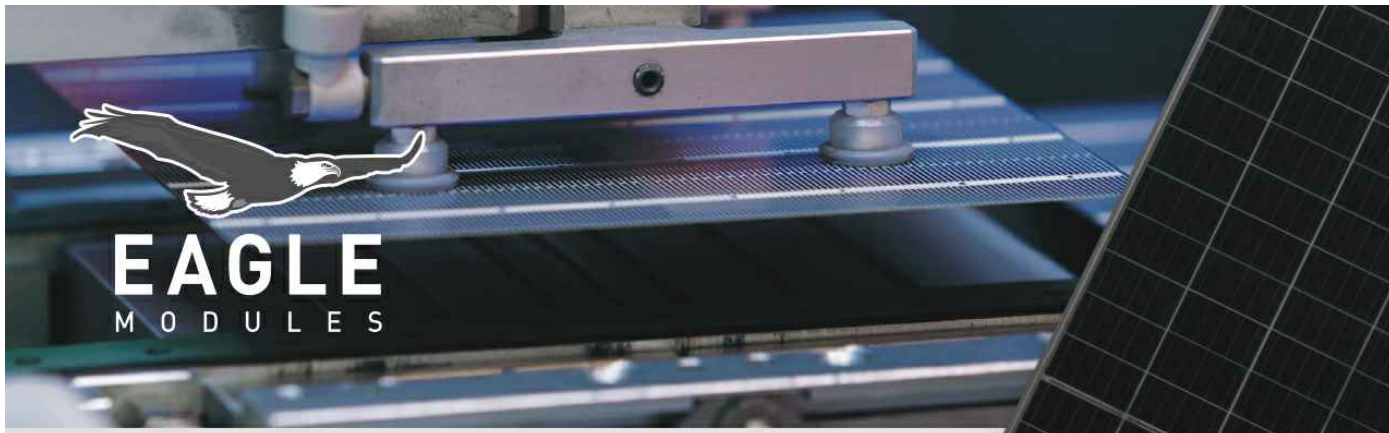

EAGLE CONTINENTAL

380-400 WATT • MONO PERC HALF-CELL MODULE

Positive power tolerance of 0~+3%



- NYSE-listed since 2010, Bloomberg Tier 1 manufacturer
- Top performance in the strictest 3rd party labs
- Automated manufacturing utilizing artificial intelligence
- Vertically integrated, tight controls on quality
- Premium solar module factory in Jacksonville, Florida

KEY FEATURES

- Superior Aesthetics**
Black backsheet and black frame create ideal look for residential applications.
- Diamond Half-Cell Technology**
World-record breaking efficient mono PERC half-cells deliver high power in a small footprint.
- Thick and Tough**
Fire Type 1 rated module engineered with a thick frame, 3.2mm front side glass, and thick backsheet for added durability.
- Shade Tolerant**
Twin array design allows continued performance even with shading by trees or debris.
- Protected Against All Environments**
Certified to withstand humidity, heat, rain, marine environments, wind, hailstorms, and packed snow.
- Warranty**
12-year product and 25-year linear power warranty.



- ISO9001:2008 Quality Standards
- ISO14001:2004 Environmental Standards
- IEC61215, IEC61730 certification pending
- ISO 45001 2018 Occupational Health & Safety Standards
- UL1703/61730 certification pending

BUILDING YOUR TRUST IN SOLAR. WWW.JINKOSOLAR.US



ENGINEERING DRAWINGS

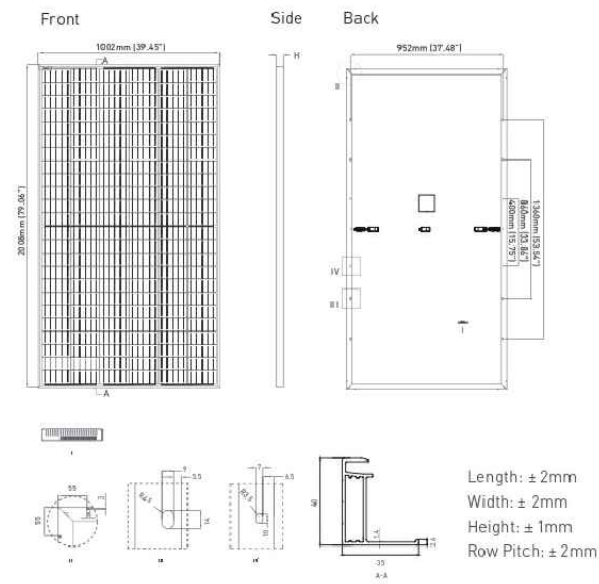

ELECTRICAL PERFORMANCE & TEMPERATURE DEPENDENCE

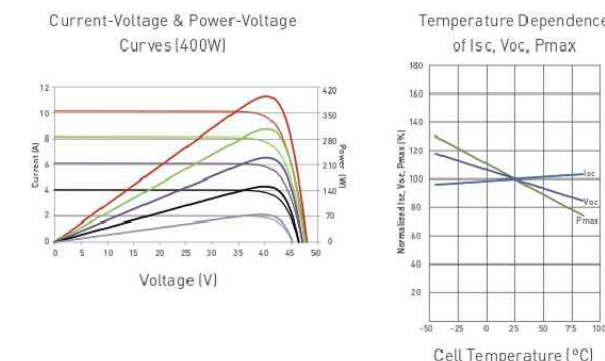

ELECTRICAL CHARACTERISTICS

Module Type	JKM380M-72HBL-V		JKM385M-72HBL-V		JKM390M-72HBL-V		JKM395M-72HBL-V		JKM400M-72HBL-V	
	STC	NOCT	STC	NOCT	SCT	NOCT	STC	NOCT	STC	NOCT
Maximum Power (Pmax)	380Wp	279Wp	385Wp	283Wp	390Wp	287Wp	395Wp	291Wp	400Wp	294Wp
Maximum Power Voltage (Vmp)	39.10V	36.5V	39.37V	36.8V	39.64V	37.0V	39.90V	37.4V	40.16V	37.6V
Maximum Power Current (Imp)	9.72A	7.67A	9.78A	7.71A	9.84A	7.75A	9.90A	7.77A	9.96A	7.82A
Open-circuit Voltage (Voc)	48.2V	45.4V	48.4V	45.6V	48.6V	45.8V	48.8V	46.0V	49.1V	46.2V
Short-circuit Current (Isc)	10.30A	8.32A	10.38A	8.38A	10.46A	8.45A	10.54A	8.51A	10.61A	8.57A
Module Efficiency STC (%)	18.9%		19.14%		19.38%		19.63%		19.88%	

*STC: ☀ Irradiance 1000W/m² 🌡 Cell Temperature 25°C ☁ AM = 1.5
 NOCT: ☀ Irradiance 800W/m² 🌡 Ambient Temperature 20°C ☁ AM = 1.5 🌬 Wind Speed 1m/s
 *Power measurement tolerance: ±3%

The company reserves the final right for explanation on any of the information presented hereby. JKM380-400M-72HBL-V-D1-US

BUILDING YOUR TRUST IN SOLAR. WWW.JINKOSOLAR.US



MECHANICAL CHARACTERISTICS

Cells	Mono PERC Diamond Cell (158.75 x 158.75mm)
No. of Half Cells	144 (6 x 24)
Dimensions	2008 x 1002 x 40mm (79.06 x 39.45 x 1.57in)
Weight	22.5kg (49.6lbs)
Front Glass	3.2mm, Anti-Reflection Coating High Transmission, Low Iron, Tempered Glass
Frame	Anodized Aluminum Alloy
Junction Box	IP68 Rated
Output Cables	12 AWG, 1400mm (55.12in)
Connector	Staubli MC4 Series
Fire Type	Type 1
Pressure Rating	5400Pa (Snow) & 2400Pa (Wind)
Hailstone Test	50 mm Hailstones at 35m/s

TEMPERATURE CHARACTERISTICS

Temperature Coefficients of Pmax	-0.35%/°C
Temperature Coefficients of Voc	-0.29%/°C
Temperature Coefficients of Isc	0.048%/°C
Nominal Operating Cell Temperature (NOCT)	45±2°C

MAXIMUM RATINGS

Operating Temperature (°C)	-40°C ~ +85°C
Maximum System Voltage	1500VDC (UL and IEC)
Maximum Series Fuse Rating	20A

PACKAGING CONFIGURATION

(Two pallets = One stack)
 27pcs/pallet, 54pcs/stack, 594pcs/40'HQ Container

WARRANTY

12-year product and 25-year linear power warranty
 1st year degradation not to exceed 2.5%, each subsequent year not to exceed 0.6%, minimum power at year 25 is 83.1% or greater.

TOP TIER SOLAR SOLUTIONS

TOP TIER SOLAR SOLUTIONS
 1530 CENTER PARK DR #2911,
 CHARLOTTE, NC 28217,
 UNITED STATES

REVISIONS		
DESCRIPTION	DATE	REV
INITIAL DESIGN	10/25/2024	

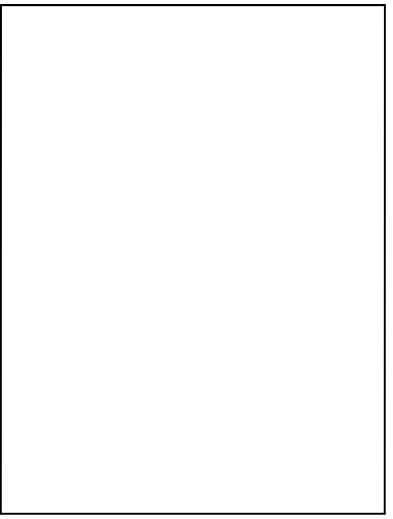

PROJECT NAME & ADDRESS
MICHAEL SPERICO RESIDENCE
 165 JARED DR,
 FUQUAY VARINA, NC 27526

DRAWN BY
ESR

SHEET NAME
EQUIPMENT SPECIFICATION

SHEET SIZE
**ANSI B
 11" X 17"**

SHEET NUMBER
PV-9

REVISIONS

DESCRIPTION	DATE	REV
INITIAL DESIGN	10/25/2024	

PROJECT NAME & ADDRESS

MICHAEL SPERICO
RESIDENCE
165 JARED DR,
FUQUAY VARINA, NC 27526

DRAWN BY

ESR

SHEET NAME
EQUIPMENT
SPECIFICATION

SHEET SIZE

ANSI B
11" X 17"

SHEET NUMBER

PV-10

CERTIFICATE OF COMPLIANCE

Certificate Number E362479
Report Reference E362479-20200410
Date 2023-July-16

Issued to: JINKO SOLAR CO LTD
No.1, Yingbin Road, Economic Development Zone
Shangrao Jiangxi Sheng 334100 CN

This is to certify that representative samples of PHOTOVOLTAIC MODULES AND PANELS WITH SYSTEM VOLTAGE RATINGS OVER 600 VOLTS See Addendum Page for Product Designation(s). Have been evaluated by UL in accordance with the Standard(s) indicated on this Certificate.

Standard(s) for Safety: UL 61730-1 - Standard for Photovoltaic (PV) Module Safety Qualification - Part 1: Requirements for Construction, Edition 2, Issue Date 10/28/2022 and UL 61730-2, Photovoltaic (PV) Module Safety Qualification - Part 2: Requirements for Testing, Edition 2, Revision Date 04/25/2023 and CSA C22.2 No. 61730-1:19 December 2019, Photovoltaic (PV) module safety qualification — Part 1: Requirements for construction and CSA C22.2 No. 61730-2:19 December 2019, Photovoltaic (PV) module safety qualification — Part 2: Requirements for testing.

Additional Information: See the UL Online Certifications Directory at <https://iq.ulprospector.com> for additional information

This Certificate of Compliance indicates that representative samples of the product described in the certification report have met the requirements for UL certification. It does not provide authorization to apply the UL Mark. Only the Authorization Page that references the Follow-Up Services Procedure for ongoing surveillance provides authorization to apply the UL Mark.

Only those products bearing the UL Mark should be considered as being UL Certified and covered under UL's Follow-Up Services.

Look for the UL Certification Mark on the product.

Deborah Jennings-Conner
Deborah Jennings-Conner, VP Regulatory Services
UL LLC



Any information and documentation involving UL Mark services are provided on behalf of UL LLC (UL) or any authorized licensee of UL. For questions, please contact a local UL Customer Service Representative at <http://ul.com/about/locations/>

CERTIFICATE OF COMPLIANCE

Certificate Number E362479
Report Reference E362479-20200410
Date 2023-July-16

JKM525N-72HL4-V, JKM530N-72HL4-V, JKM535N-72HL4-V, JKM540N-72HL4-V, JKM545N-72HL4-V, JKM550N-72HL4-V, JKM555N-72HL4-V, JKM560N-72HL4-V, JKM565N-72HL4-V, JKM570N-72HL4-V, JKM575N-72HL4-V.

JKM480N-66HL4-V, JKM485N-66HL4-V, JKM490N-66HL4-V, JKM495N-66HL4-V, JKM500N-66HL4-V, JKM505N-66HL4-V, JKM510N-66HL4-V, JKM515N-66HL4-V, JKM520N-66HL4-V, JKM525N-66HL4-V

JKM435N-60HL4-V, JKM440N-60HL4-V, JKM445N-60HL4-V, JKM450N-60HL4-V, JKM455N-60HL4-V, JKM460N-60HL4-V, JKM465N-60HL4-V, JKM470N-60HL4-V, JKM475N-60HL4-V, JKM480N-60HL4-V.

JKM395N-54HL4-V, JKM400N-54HL4-V, JKM405N-54HL4-V, JKM410N-54HL4-V, JKM415N-54HL4-V, JKM420N-54HL4-V, JKM425N-54HL4-V, JKM430N-54HL4-V.

JKM565M-78HL4-V, JKM570M-78HL4-V, JKM575M-78HL4-V, JKM580M-78HL4-V, JKM585M-78HL4-V, JKM590M-78HL4-V, JKM595M-78HL4-V, JKM600M-78HL4-V, JKM605M-78HL4-V

JKM370M-72HBL-V, JKM375M-72HBL-V, JKM380M-72HBL-V, JKM385M-72HBL-V, **JKM390M-72HBL-V**, JKM395M-72HBL-V, JKM400M-72HBL-V, JKM405M-72HBL-V, JKM410M-72HBL-V, JKM415M-72HBL-V, JKM420M-72HBL-V.

JKM330M-60HBL-V, JKM335M-60HBL-V, JKM340M-60HBL-V, JKM345M-60HBL-V, JKM350M-60HBL-V.

JKM515N-72HL4-B-V, JKM520N-72HL4-B-V, JKM525N-72HL4-B-V, JKM530N-72HL4-B-V, JKM535N-72HL4-B-V, JKM540N-72HL4-B-V, JKM545N-72HL4-B-V, JKM550N-72HL4-B-V, JKM555N-72HL4-B-V, JKM560N-72HL4-B-V, JKM565N-72HL4-B-V, JKM570N-72HL4-B-V.

JKM475N-66HL4-B-V, JKM480N-66HL4-B-V, JKM485N-66HL4-B-V, JKM490N-66HL4-B-V, JKM495N-66HL4-B-V, JKM500N-66HL4-B-V, JKM505N-66HL4-B-V, JKM510N-66HL4-B-V, JKM515N-66HL4-B-V, JKM520N-66HL4-B-V.

JKM430N-60HL4-B-V, JKM435N-60HL4-B-V, JKM440N-60HL4-B-V, JKM445N-60HL4-B-V, JKM450N-60HL4-B-V, JKM455N-60HL4-B-V, JKM460N-60HL4-B-V, JKM465N-60HL4-B-V, JKM470N-60HL4-B-V.

JKM385N-54HL4-B-V, JKM390N-54HL4-B-V, JKM395N-54HL4-B-V, JKM400N-54HL4-B-V, JKM405N-54HL4-B-V, JKM410N-54HL4-B-V, JKM415N-54HL4-B-V, JKM420N-54HL4-B-V, JKM425N-54HL4-B-V, JKM430N-54HL4-B-V, JKM435N-54HL4-B-V, JKM440N-54HL4-B-V.

JKM585N-78HL4R-V, JKM590N-78HL4R-V, JKM595N-78HL4R-V, JKM600N-78HL4R-V, JKM605N-78HL4R-V, JKM610N-78HL4R-V, JKM615N-78HL4R-V, JKM620N-78HL4R-V, JKM625N-78HL4R-V, JKM630N-78HL4R-V, JKM635N-78HL4R-V, JKM640N-78HL4R-V, JKM645N-78HL4R-V, JKM650N-78HL4R-V

Deborah Jennings-Conner
Deborah Jennings-Conner, VP Regulatory Services
UL LLC



Any information and documentation involving UL Mark services are provided on behalf of UL LLC (UL) or any authorized licensee of UL. For questions, please contact a local UL Customer Service Representative at <http://ul.com/about/locations/>



DATA SHEET



IQ8 and IQ8+ Microinverters

Our newest IQ8 Microinverters are the industry's first microgrid-forming, software-defined microinverters with split-phase power conversion capability to convert DC power to AC power efficiently. The brain of the semiconductor-based microinverter is our proprietary application-specific integrated circuit (ASIC), which enables the microinverter to operate in grid-tied or off-grid modes. This chip is built using advanced 55-nm technology with high-speed digital logic and has superfast response times to changing loads and grid events, alleviating constraints on battery sizing for home energy systems.



Part of the Enphase Energy System, IQ8 Series Microinverters integrate with the IQ Battery, IQ Gateway, and the Enphase App monitoring and analysis software.



IQ8 Series Microinverters redefine reliability standards with more than one million cumulative hours of power-on testing, enabling an industry-leading limited warranty of up to 25 years.



Connect PV modules quickly and easily to IQ8 Series Microinverters using the included Q-DCC-2 adapter cable with plug-and-play MC4 connectors.



IQ8 Series Microinverters are UL Listed as PV rapid shutdown equipment and conform with various regulations, when installed according to the manufacturer's instructions.

*Meets UL 1741 only when installed with IQ System Controller 2 or 3.
**IQ8 and IQ8+ support split-phase, 240 V installations only.

© 2024 Enphase Energy. All rights reserved. Enphase, the e and CC logos, IQ, and certain other marks listed at <https://enphase.com/trademark-usage-guidelines> are trademarks of Enphase Energy, Inc. in the U.S. and other countries. Data subject to change.

IQ8SP-12A-DSH-00207-3.0-EN-US-2024-02-12

IQ8 and IQ8+ Microinverters

INPUT DATA (DC)	UNITS	IQ8-60-2-US	IQ8PLUS-72-2-US
Commonly used module pairings ¹	W	235-350	235-440
Module compatibility	—	To meet compatibility, PV modules must be within maximum input DC voltage and maximum module I_{sc} listed below. Module compatibility can be checked at https://enphase.com/installers/microinverters/calculator .	
MPPT voltage range	V	27-37	27-45
Operating range	V	16-48	16-58
Minimum/Maximum start voltage	V	22/48	22/58
Maximum input DC voltage	V	50	60
Maximum continuous input DC current	A	10	12
Maximum input DC short-circuit current	A		25
Maximum module (I_{sc})	A		20
Overvoltage class DC port	—		II
DC port backfeed current	mA		0
PV array configuration	—	Ungrounded array; no additional DC side protection required; AC side protection requires maximum 20 A per branch circuit.	
OUTPUT DATA (AC)	UNITS	IQ8-60-2-US	IQ8PLUS-72-2-US
Peak output power	VA	245	300
Maximum continuous output power	VA	240	290
Nominal grid voltage (L-L)	V	240, split-phase (L-L), 180°	
Minimum and Maximum grid voltage ²	V	211-264	
Maximum continuous output current	A	1.0	1.21
Nominal frequency	Hz	60	
Extended frequency range	Hz	47-68	
AC short-circuit fault current over three cycles	Arms	2	
Maximum units per 20 A (L-L) branch circuit ³	—	16	13
Total harmonic distortion	%	<5	
Overvoltage class AC port	—	III	
AC port backfeed current	mA	30	
Power factor setting	—	1.0	
Grid-tied power factor (adjustable)	—	0.85 leading ... 0.85 lagging	
Peak efficiency	%	97.7	
CEC weighted efficiency	%	97	
Nighttime power consumption	mW	23	25
MECHANICAL DATA			
Ambient temperature range		-40°C to 60°C (-40°F to 140°F)	
Relative humidity range		4% to 100% (condensing)	
DC connector type		MC4	
Dimensions (H x W x D)		212 mm (8.3 in) x 175 mm (6.9 in) x 30.2 mm (1.2 in)	
Weight		1.08 kg (2.38 lbs)	
Cooling		Natural convection—no fans	
Approved for wet locations		Yes	
Pollution degree		PD3	
Enclosure		Class II double-insulated, corrosion-resistant polymeric enclosure	
Environmental category/UV exposure rating		NEMA Type 6/Outdoor	

(1) No enforced DC/AC ratio.
(2) Nominal voltage range can be extended beyond nominal if required by the utility.
(3) Limits may vary. Refer to local requirements to define the number of microinverters per branch in your area.

IQ8SP-12A-DSH-00207-3.0-EN-US-2024-02-12

TOP TIER
SOLAR SOLUTIONS

TOP TIER SOLAR SOLUTIONS

1530 CENTER PARK DR #2911,
CHARLOTTE, NC 28217,
UNITED STATES

REVISIONS

DESCRIPTION	DATE	REV
INITIAL DESIGN	10/25/2024	

PROJECT NAME & ADDRESS

MICHAEL SPERICO
RESIDENCE

165 JARED DR,
FUQUAY VARINA, NC 27526

DRAWN BY

ESR

SHEET NAME
EQUIPMENT
SPECIFICATION

SHEET SIZE
ANSI B
11" X 17"

SHEET NUMBER

PV-11



XR Rail® Family

Solar Is Not Always Sunny

Over their lifetime, solar panels experience countless extreme weather events. Not just the worst storms in years, but the worst storms in 40 years. High winds capable of ripping panels from a roof, and snowfalls weighing enough to buckle a panel frame.

XR Rails® are the structural backbone preventing these results. They resist uplift, protect against buckling and safely and efficiently transfer loads into the building structure. Their superior spanning capability requires fewer roof attachments, reducing the number of roof penetrations and the amount of installation time.

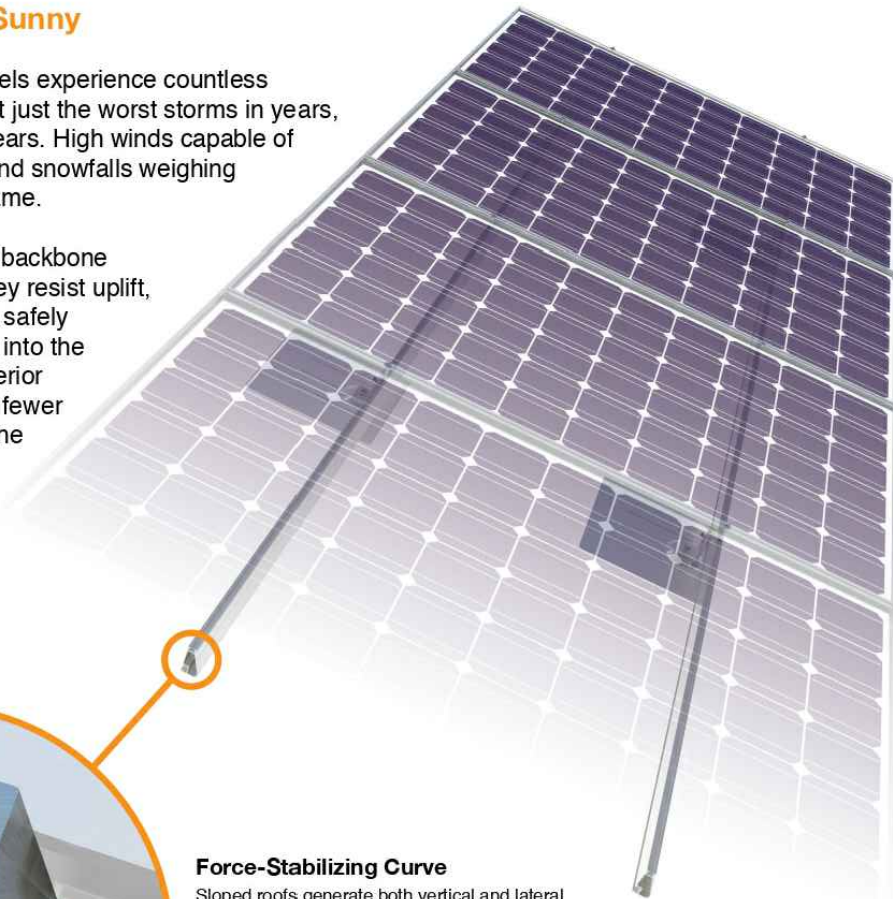

Force-Stabilizing Curve

Sloped roofs generate both vertical and lateral forces on mounting rails which can cause them to bend and twist. The curved shape of XR Rails® is specially designed to increase strength in both directions while resisting the twisting. This unique feature ensures greater security during extreme weather and a longer system lifetime.

Compatible with Flat & Pitched Roofs



Corrosion-Resistant Materials

All XR Rails® are made of 6000-series aluminum alloy, then protected with an anodized finish. Anodizing prevents surface and structural corrosion, while also providing a more attractive appearance.



XR Rail® Family

The XR Rail® Family offers the strength of a curved rail in three targeted sizes. Each size supports specific design loads, while minimizing material costs. Depending on your location, there is an XR Rail® to match.



XR10

XR10 is a sleek, low-profile mounting rail, designed for regions with light or no snow. It achieves spans up to 6 feet, while remaining light and economical.

- 6' spanning capability
- Moderate load capability
- Clear & black anodized finish
- Internal splices available



XR100

XR100 is a residential and commercial mounting rail. It supports a range of wind and snow conditions, while also maximizing spans up to 10 feet.

- 10' spanning capability
- Heavy load capability
- Clear & black anodized finish
- Internal splices available



XR1000

XR1000 is a heavyweight among solar mounting rails. It's built to handle extreme climates and spans up to 12 feet for commercial applications.

- 12' spanning capability
- Extreme load capability
- Clear anodized finish
- Internal splices available

Rail Selection

The table below was prepared in compliance with applicable engineering codes and standards.* Values are based on the following criteria: ASCE 7-16, Gable Roof Flush Mount, Roof Zones 1 & 2e, Exposure B, Roof Slope of 8 to 20 degrees and Mean Building Height of 30 ft. Visit IronRidge.com for detailed certification letters.

Load		Rail Span					
Snow (PSF)	Wind (MPH)	4'	5' 4"	6'	8'	10'	12'
None	90						
	120						
	140	XR10		XR100		XR1000	
	160						
20	90						
	120						
	140						
	160						
30	90						
	160						
40	90						
	160						
80	160						
	160						
120	160						
	160						

*Table is meant to be a simplified span chart for conveying general rail capabilities. Use approved certification letters for actual design guidance.



TOP TIER SOLAR SOLUTIONS

1530 CENTER PARK DR #2911,
CHARLOTTE, NC 28217,
UNITED STATES

REVISIONS		
DESCRIPTION	DATE	REV
INITIAL DESIGN	10/25/2024	

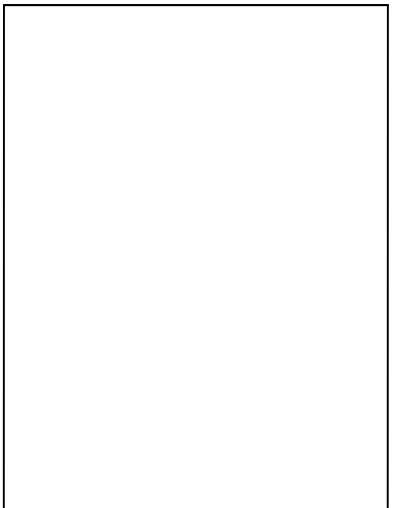

PROJECT NAME & ADDRESS

MICHAEL SPERICO
RESIDENCE

165 JARED DR,
FUQUAY VARINA, NC 27526

DRAWN BY
ESR

SHEET NAME
EQUIPMENT
SPECIFICATION

SHEET SIZE
ANSI B
11" X 17"

SHEET NUMBER
PV-12



UFO® Family of Components

Simplified Grounding for Every Application

The UFO® family of components eliminates the need for separate grounding hardware by bonding solar modules directly to IronRidge® XR Rails®. All system types that feature the UFO® family—Flush Mount®, Tilt Mount® and Ground Mount®—are fully listed to the UL 2703 standard.

UFO® hardware forms secure electrical bonds with both the module and the rail, resulting in many parallel grounding paths throughout the system. This leads to safer and more reliable installations.

Only for installation and use with IronRidge products in accord with written instructions. See IronRidge.com/UFO

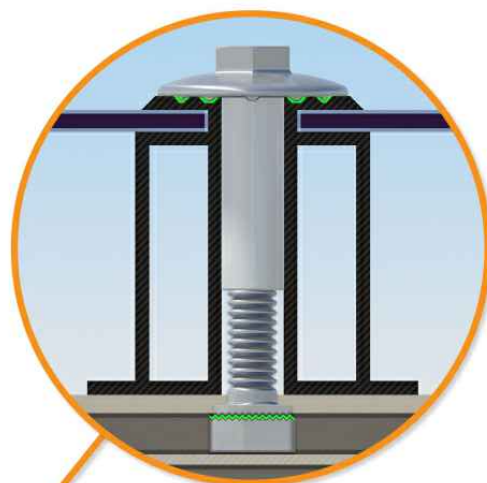

Universal Fastening Object (UFO®)
The UFO® securely bonds solar modules to XR Rails®. It comes assembled and lubricated, and can fit a wide range of module heights.



Stopper Sleeve
The Stopper Sleeve snaps onto the UFO®, converting it into a bonded end clamp.

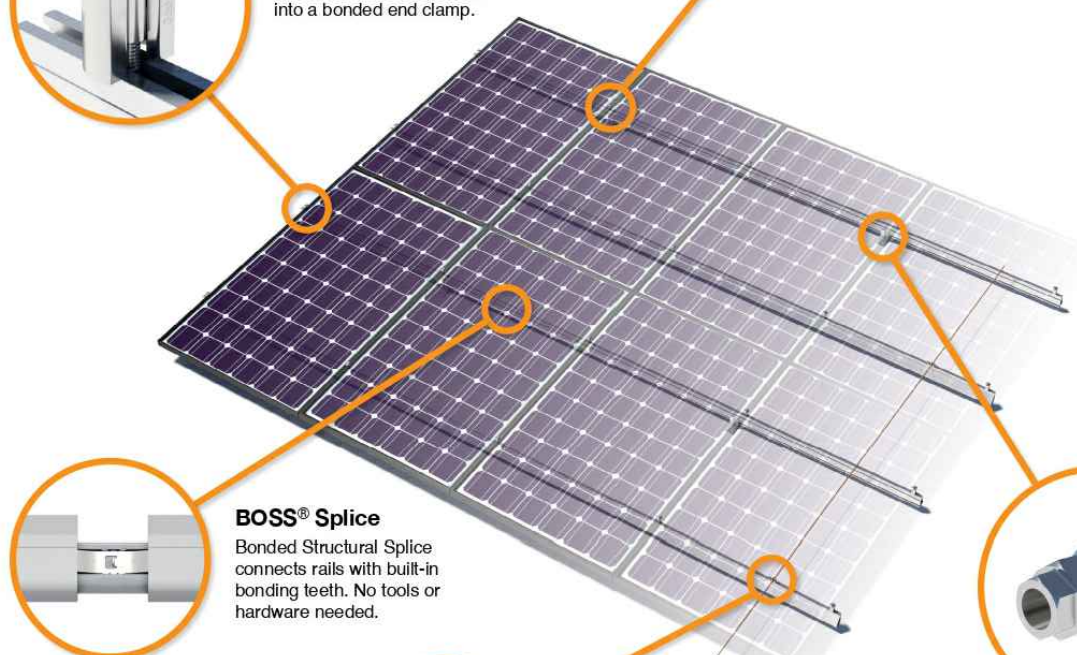

BOSS® Splice
Bonded Structural Splice connects rails with built-in bonding teeth. No tools or hardware needed.



Grounding Lug
A single Grounding Lug connects an entire row of PV modules to the grounding conductor.



Bonded Attachments
The bonding bolt attaches and bonds the L-foot® to the rail. It is installed with the same socket as the rest of the system.

System Diagram

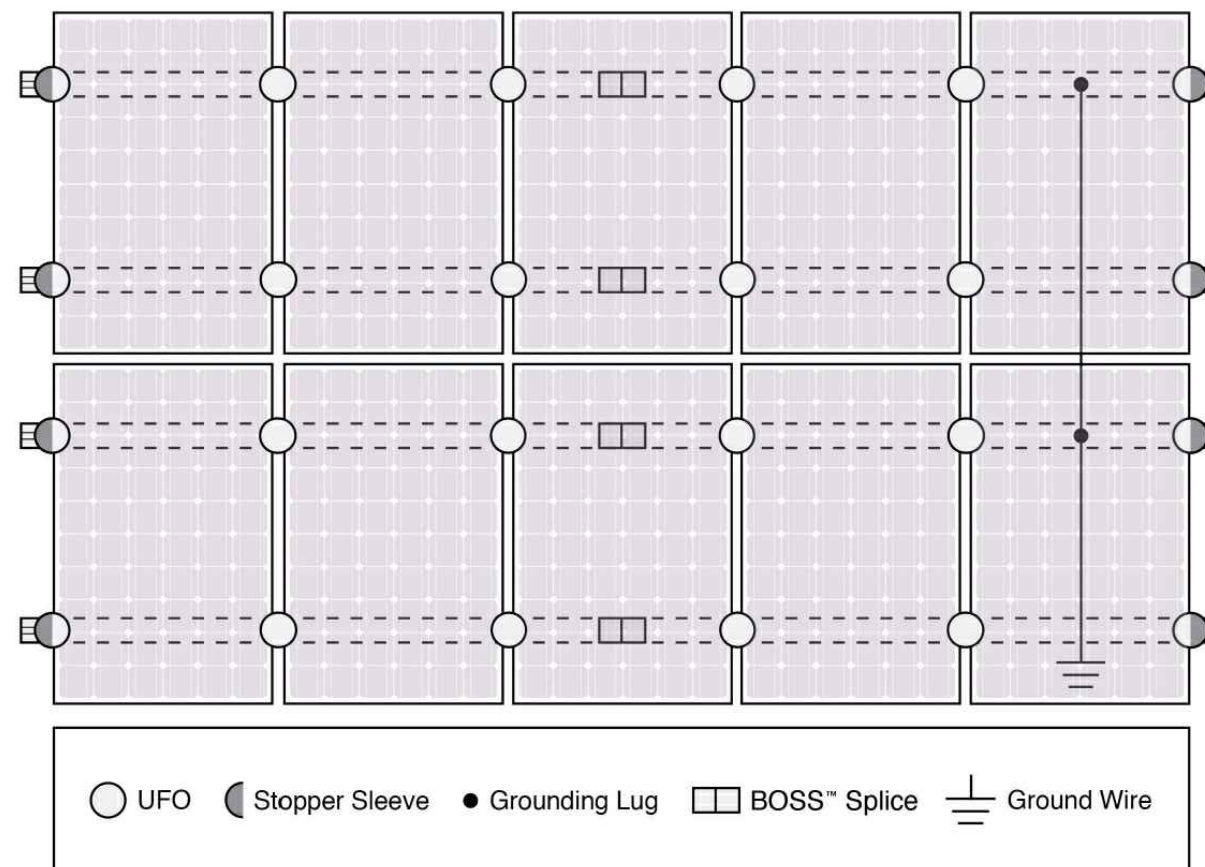

⚠ Approved Enphase microinverters can provide equipment grounding of IronRidge systems, eliminating the need for grounding lugs and field installed equipment ground conductors (EGC). A minimum of two microinverters mounted to the same rail and connected to the same Engage cable is required. Refer to installation manuals for additional details.

UL Certification

The IronRidge® Flush Mount®, Tilt Mount®, and Ground Mount Systems have been listed to UL 2703 by Intertek Group plc.

UL 2703 is the standard for evaluating solar mounting systems. It ensures these devices will maintain strong electrical and mechanical connections over an extended period of time in extreme outdoor environments.

🔗 Go to IronRidge.com/UFO

Cross-System Compatibility			
Feature	Flush Mount	Tilt Mount	Ground Mount
XR Rails®	✓	✓	XR100 & XR1000
UFO®/Stopper	✓	✓	✓
BOSS® Splice	✓	✓	N/A
Grounding Lugs	1 per Row	1 per Row	1 per Array
Microinverters & Power Optimizers	Compatible with most MLPE manufacturers. Refer to system installation manual.		
Fire Rating	Class A	Class A	N/A
Modules	Tested or Evaluated with over 400 Framed Modules. Refer to installation manuals for a detailed list.		



TOP TIER SOLAR SOLUTIONS

1530 CENTER PARK DR #2911,
CHARLOTTE, NC 28217,
UNITED STATES

REVISIONS		
DESCRIPTION	DATE	REV
INITIAL DESIGN	10/25/2024	

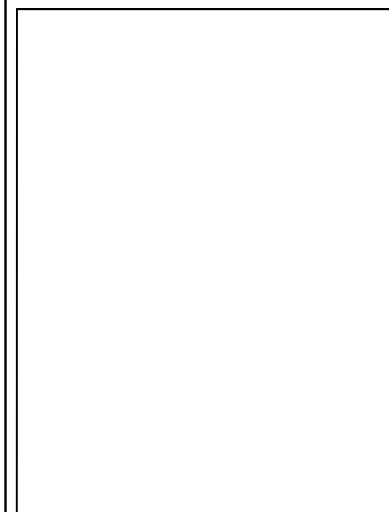

PROJECT NAME & ADDRESS

MICHAEL SPERICO
RESIDENCE

165 JARED DR,
FUQUAY VARINA, NC 27526

DRAWN BY
ESR

SHEET NAME
EQUIPMENT
SPECIFICATION

SHEET SIZE
ANSI B
11" X 17"

SHEET NUMBER
PV-13



QuickMount® Halo UltraGrip

Cut Sheet

Cut Sheet

Release Liner shown for reference

RD STRUCTURAL SCREW PN RD-1430-01-M1
SOLD SEPARATELY
SHOWN FOR REFERENCE

ITEM NO	DESCRIPTION	QTY IN KIT
1	QM Halo UltraGrip(Mill or Black)	1

PART NUMBER	DESCRIPTION
QM-HUG-01-M1	Halo UltraGrip - Mill
QM-HUG-01-B1	Halo UltraGrip - Black

© 2022 IronRidge, Inc. All rights reserved. Visit www.ir-patents.com for patent information.

QM-HUG-01-B1 or QM-HUG-01-M1 Cut Sheet Rev 1.0

1. Halo UltraGrip

Property	Value
Material	3000 Series Aluminium
Finish	Mill or Black

© 2022 IronRidge, Inc. All rights reserved. Visit www.ir-patents.com for patent information.

QM-HUG-01-B1 or QM-HUG-01-M1 Cut Sheet Rev 1.0



TOP TIER SOLAR SOLUTIONS

1530 CENTER PARK DR #2911,
CHARLOTTE, NC 28217,
UNITED STATES

REVISIONS		
DESCRIPTION	DATE	REV
INITIAL DESIGN	10/25/2024	

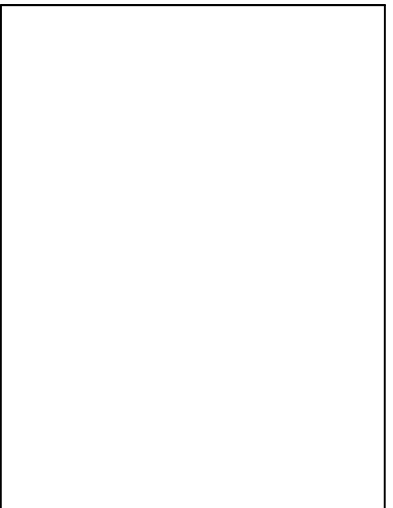

PROJECT NAME & ADDRESS

**MICHAEL SPERICO
RESIDENCE**

165 JARED DR,
FUQUAY VARINA, NC 27526

DRAWN BY
ESR

SHEET NAME
**EQUIPMENT
SPECIFICATION**

SHEET SIZE
**ANSI B
11" X 17"**

SHEET NUMBER
PV-14



QuickMount® RD Structural Screw



TOP TIER SOLAR SOLUTIONS

1530 CENTER PARK DR #2911,
CHARLOTTE, NC 28217,
UNITED STATES

REVISIONS		
DESCRIPTION	DATE	REV
INITIAL DESIGN	10/25/2024	

ITEM NO	DESCRIPTION	QTY IN KIT
1	Self Drilling Screw, #14, Wood Tip	1
2	Washer, EPDM Backed	1

PART NUMBER	DESCRIPTION
RD-1430-01-M1	RD Structural Screw

1. Self Drilling Screw, #14, Wood Tip

Property	Value
Material	300 Series Stainless Steel
Finish	Clear

2. Washer, EPDM Backed

Property	Value
Material	300 Series Stainless Steel
Finish	Clear

© 2022 IronRidge, Inc. All rights reserved. Visit www.ir-patents.com for patent information.

QM-RD-1430-01-M1 Cut Sheet Rev 1.0

PROJECT NAME & ADDRESS

MICHAEL SPERICO
RESIDENCE

165 JARED DR,
FUQUAY VARINA, NC 27526

DRAWN BY
ESR

SHEET NAME
EQUIPMENT
SPECIFICATION

SHEET SIZE
ANSI B
11" X 17"

SHEET NUMBER
PV-15

ITEM NO.	PART NUMBER	DESCRIPTION	QTY
1	JB-1.2 BODY	POLYCARBONATE WITH UV INHIBITORS	1
2	JB-1.2 LID	POLYCARBONATE WITH UV INHIBITORS	1
3	#10 X 1-1/4" PHILLIPS PAN HEAD SCREW		6
4	#8 X 3/4" PHILLIPS PAN HEAD SCREW		6

SIZE B	DWG. NO. JB-1.2	REV
SCALE: 1:2	WEIGHT: 1.45 LBS	SHEET 1 OF 3

TORQUE SPECIFICATION:	15-20 LBS
CERTIFICATION:	UL 1741, NEMA 3R CSA C22.2 NO. 290
WEIGHT:	1.45 LBS

SIZE B	DWG. NO. JB-1.2	REV
SCALE: 1:2	WEIGHT: 1.45 LBS	SHEET 2 OF 3

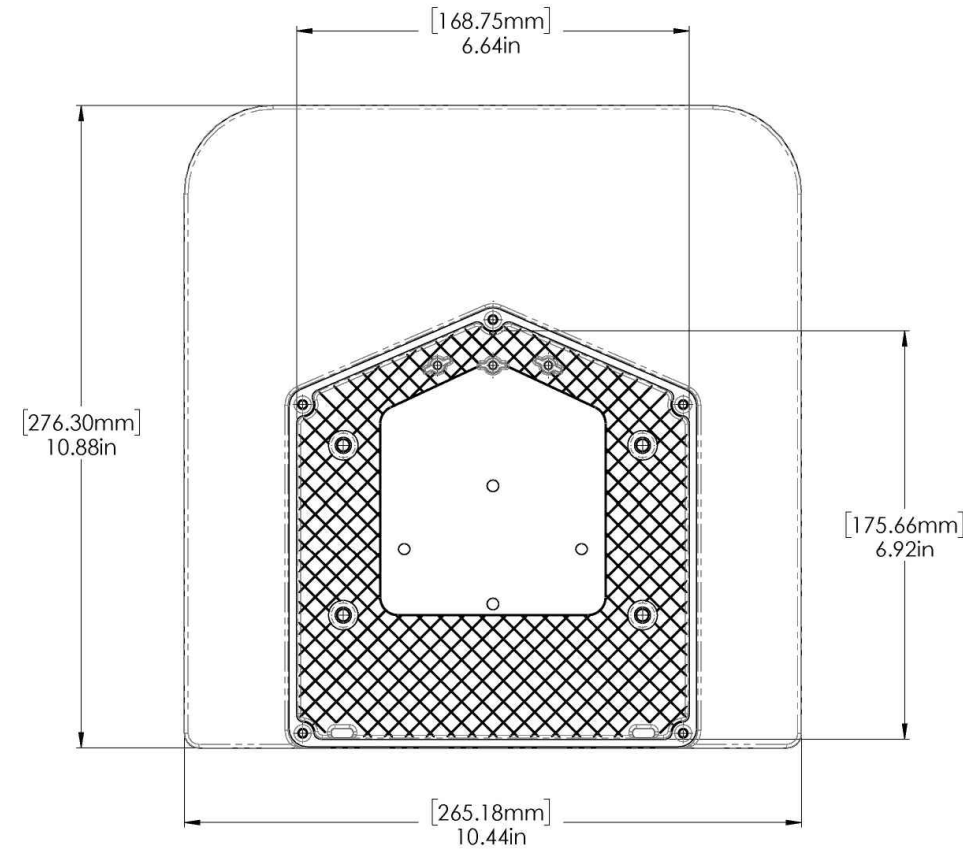
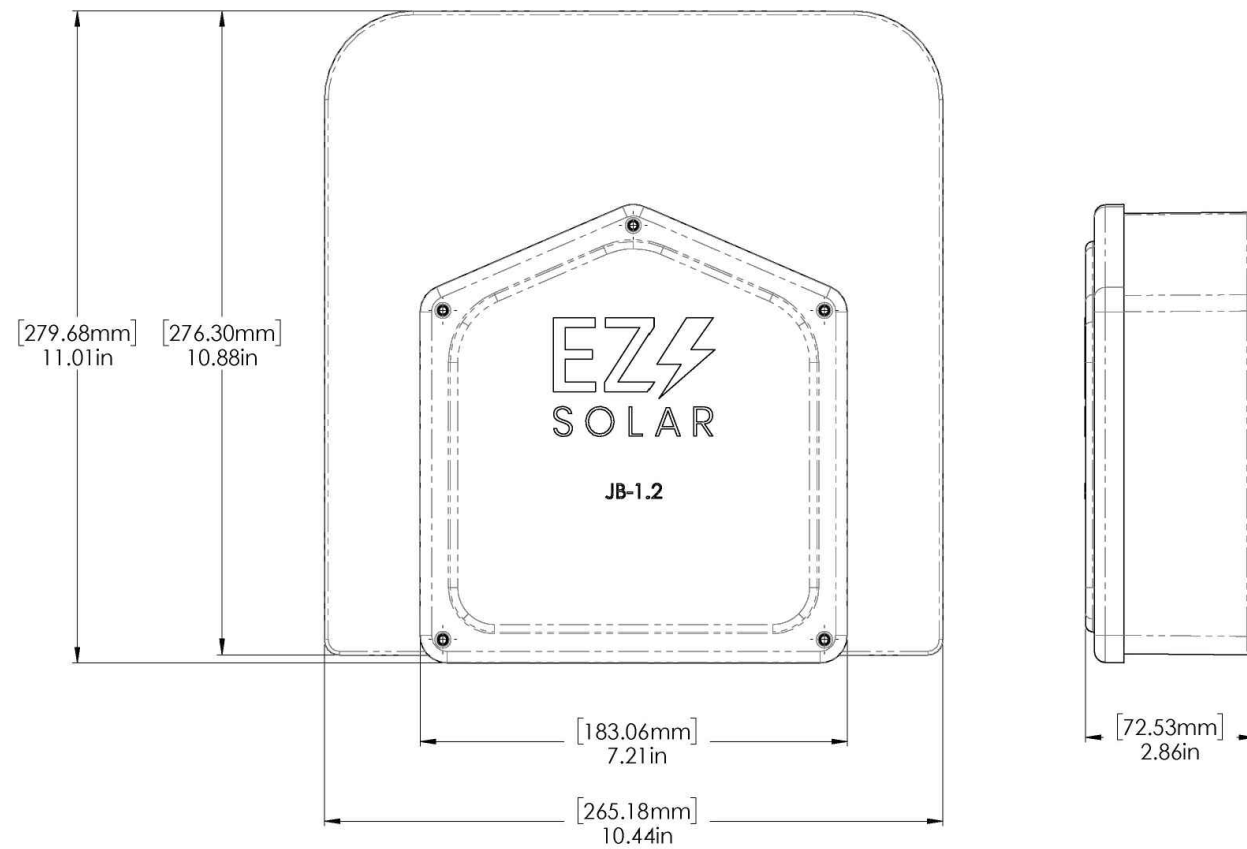

REVISIONS		
DESCRIPTION	DATE	REV
INITIAL DESIGN	10/25/2024	

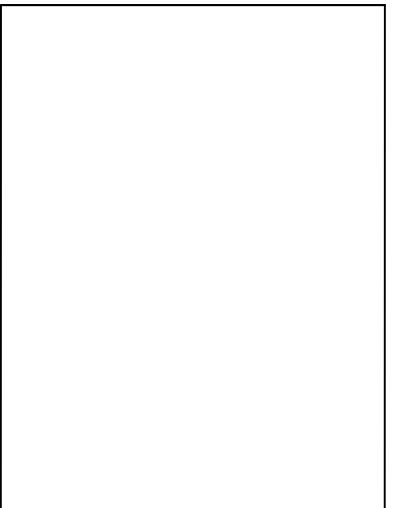

PROJECT NAME & ADDRESS

**MICHAEL SPERICO
RESIDENCE**

165 JARED DR,
FUQUAY VARINA, NC 27526

DRAWN BY
ESR

SHEET NAME
**EQUIPMENT
SPECIFICATION**

SHEET SIZE
**ANSI B
11" X 17"**

SHEET NUMBER
PV-16