



Freedom Forever
Planset Revision Letter

8/13/2024
REV #1

Attn. County of Harnett (NC):

The changes outlined in Revision Details have been applied to the plans corresponding to the following customer:

BRADLEY HOCEVAR
257 BEACON HL RD , LILLINGTON, NC 27546

Revision Details:

1. Layout revised to match install

All corresponding changes are notated on the plans by revision clouds.

Thank you for your time in reviewing these plans. Please reach out if you have any additional questions or concerns.

Construction Engineering
Freedom Forever
engineering@freedomforever.com

ROOF MOUNT PHOTOVOLTAIC SYSTEM

CODES:

THIS PROJECT COMPLIES WITH THE FOLLOWING:
 2018 NORTH CAROLINA BUILDING CODE
 2018 NORTH CAROLINA RESIDENTIAL CODE
 2018 NORTH CAROLINA PLUMBING CODE
 2018 NORTH CAROLINA MECHANICAL CODE
 2018 NORTH CAROLINA FUEL GAS CODE
 2017 NATIONAL ELECTRICAL CODE
 AS ADOPTED BY COUNTY OF HARNETT

CONSTRUCTION NOTES:

CONDUIT AND CONDUCTOR SPECIFICATIONS ARE BASED ON MINIMUM CODE REQUIREMENTS AND ARE NOT MEANT TO LIMIT UP-SIZING AS REQUIRED BY FIELD CONDITIONS.

ALL SOLAR ENERGY SYSTEM EQUIPMENT SHALL BE SCREENED TO THE MAXIMUM EXTENT POSSIBLE AND SHALL BE PAINTED A COLOR SIMILAR TO THE SURFACE UPON WHICH THEY ARE MOUNTED.

MODULES SHALL BE TESTED , LISTED AND IDENTIFIED WITH FIRE CLASSIFICATION IN ACCORDANCE WITH UL 2703. SMOKE AND CARBON MONOXIDE ALARMS ARE REQUIRED PER SECTION R314 AND 315 TO BE VERIFIED AND INSPECTED BY INSPECTOR IN THE FIELD.

DIG ALERT (811) TO BE CONTACTED AND COMPLIANCE WITH EXCAVATION SAFETY PRIOR TO ANY EXCAVATION TAKING PLACE

PHOTOVOLTAIC SYSTEM GROUND WILL BE TIED INTO EXISTING GROUND AT MAIN SERVICE FROM DC DISCONNECT/INVERTER AS PER 2017 NEC SEC 250.166(A).

SOLAR PHOTOVOLTAIC SYSTEM EQUIPMENT WILL BE INSTALLED IN ACCORDANCE WITH REQUIREMENTS OF ART. 690 OF THE 2017 NEC

THE MAIN SERVICE PANEL WILL BE EQUIPPED WITH A GROUND ROD OR UFER

UTILITY COMPANY WILL BE NOTIFIED PRIOR TO ACTIVATION OF THE SOLAR PV SYSTEM

SOLAREEDGE OPTIMIZERS ARE LISTED TO IEC 62109-1 (CLASS II SAFETY) AND UL 1741 STANDARDS

INSTALL CREW TO VERIFY ROOF STRUCTURE PRIOR TO COMMENCING WORK. EMT CONDUIT ATTACHED TO THE ROOF USING CONDUIT MOUNT.

VICINITY MAP:



THIS SYSTEM DESIGNED WITH:
 WIND SPEED: 130
 WIND EXPOSURE: B
 SNOW LOAD: 15

CLIENT:
 BRADLEY HOCEVAR
 257 BEACON HL RD, LILLINGTON, NC 27546
 AHJ: COUNTY OF HARNETT
 UTILITY: DUKE ENERGY
 METER: 1G8783
 APN: 130630 0096 63
 PHONE: (850) 381-5738
 EMAIL: BRADLEY.HOCEVAR.JR@GMAIL.COM

SYSTEM:
 SYSTEM SIZE (DC): 20 X 410 = 8.200 kW
 SYSTEM SIZE (AC): 6.000 kW @ 240V
 MODULES: 20 X HANWHA QCELL: Q.PEAK DUO BLK ML-G10+ 410
 OPTIMIZERS: 20 X SOLAREEDGE S440
 INVERTER: SOLAREEDGE SE6000H-USRGM [S11]

TABLE OF CONTENTS:

PV-1	PROJECT DETAILS
PV-2	SITE PLAN
PV-2A	ROOF PLAN WITH MODULES LAYOUT
PV-2B	ARRAY DETAILS
PV-3	MOUNTING DETAILS
PV-4	THREE LINE DIAGRAM
PV-5	CONDUCTOR CALCULATIONS
PV-6	EQUIPMENT & SERVICE LIST
PV-7	LABELS
PV-7A	SITE PLACARD
PV-8	OPTIMIZER CHART
PV-9	SAFETY PLAN
PV-10	SAFETY PLAN
APPENDIX	MANUFACTURER SPECIFICATION SHEETS













REVISIONS		
NO.	REVISED BY	DATE
1	A.M.	8/13/2024
-	-	-
-	-	-

FREEDOM FOREVER LLC
 415 INDUSTRIAL CT., GREER, SC 29651
 Tel: (800) 385-1075
GREG ALBRIGHT

CONTRACTOR LICENSE:
 ELECTRICAL CONTRACTOR U.34043

PROJECT DETAILS			
JOB NO:	DATE:	DESIGNED BY:	SHEET:
442757	8/13/2024	A.M.	PV-1

LEGEND:

-  CHIMNEY
-  PIPE VENT
-  ATTACHMENTS
-  MODULES
-  RAFTERS
-  RAIL
-  SETBACK
-  AC DISCONNECT
-  MSP
-  JUNCTION BOX
-  PRODUCTION METER
-  MICRO INVERTER
-  COMBINER PANEL

BEACON HL RD

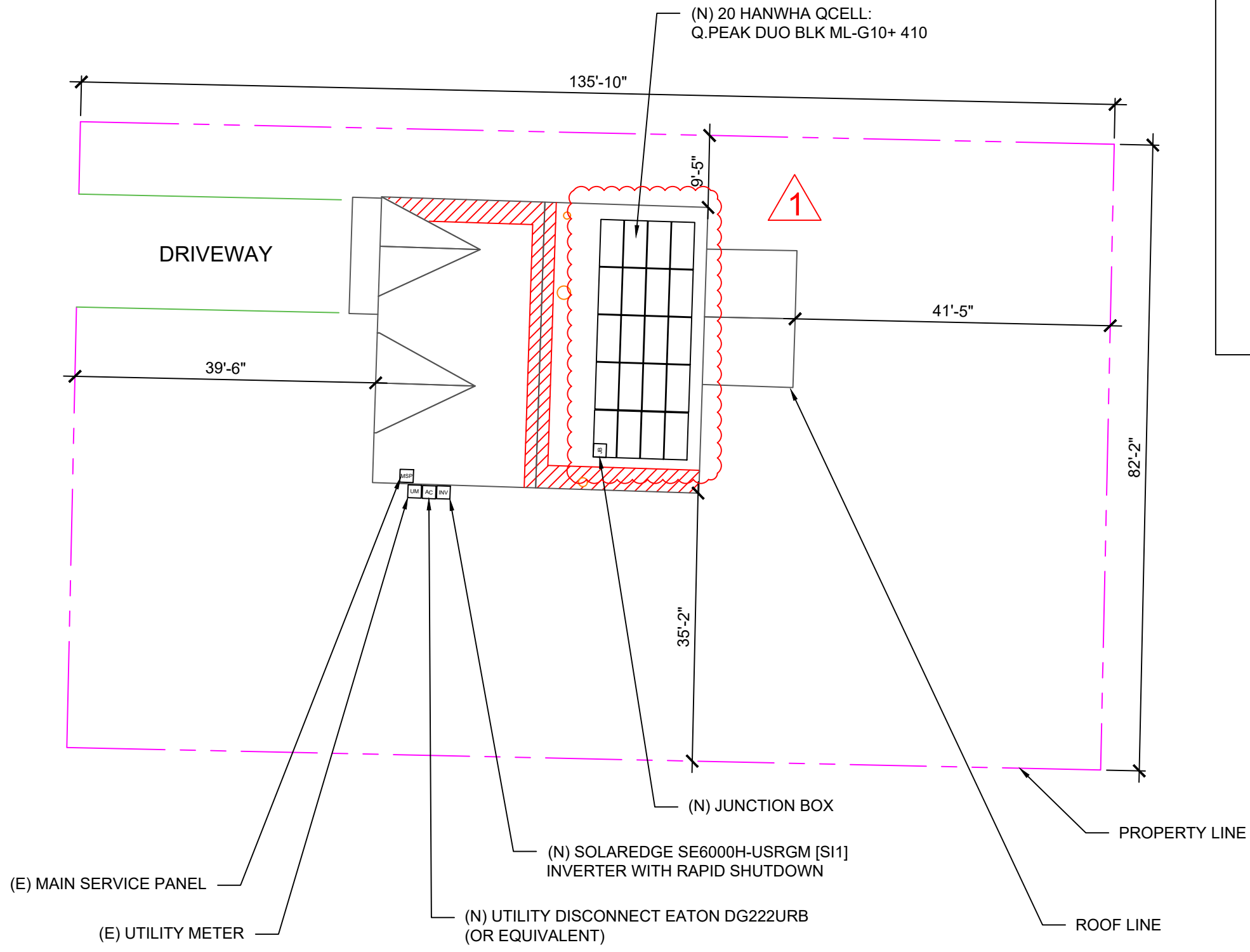

ROOF AREA: 2162 SQ FT

CLIENT:
 BRADLEY HOCEVAR
 257 BEACON HL RD, LILLINGTON, NC 27546
 AHJ: COUNTY OF HARNETT
 UTILITY: DUKE ENERGY
 METER: 1G8783
 APN: 130630 0096 63
 PHONE: (850) 381-5738
 EMAIL: BRADLEY.HOCEVAR.JR@GMAIL.COM

SYSTEM:
 SYSTEM SIZE (DC): 20 X 410 = 8.200 kW
 SYSTEM SIZE (AC): 6.000 kW @ 240V
 MODULES: 20 X HANWHA QCELL: Q.PEAK DUO BLK ML-G10+ 410
 OPTIMIZERS: 20 X SOLAREEDGE S440
 INVERTER: SOLAREEDGE SE6000H-USRGM [S11]

REVISIONS		
NO.	REVISED BY	DATE
1	A.M.	8/13/2024
-	-	-
-	-	-



FREEDOM FOREVER LLC
 415 INDUSTRIAL CT., GREER, SC 29651
 Tel: (800) 385-1075
GREG ALBRIGHT

CONTRACTOR LICENSE:
 ELECTRICAL CONTRACTOR U.34043

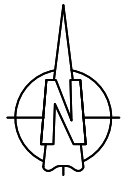













SITE PLAN
 SCALE: 1/16" = 1'-0"

1

SITE PLAN			
JOB NO:	DATE:	DESIGNED BY:	SHEET:
442757	8/13/2024	A.M.	PV-2

LEGEND:

-  CHIMNEY
-  PIPE VENT
-  ATTACHMENTS
-  MODULES
-  RAFTERS
-  RAIL
-  SETBACK
-  AC DISCONNECT
-  MSP
-  JUNCTION BOX
-  PRODUCTION METER
-  MICRO INVERTER
-  COMBINER PANEL

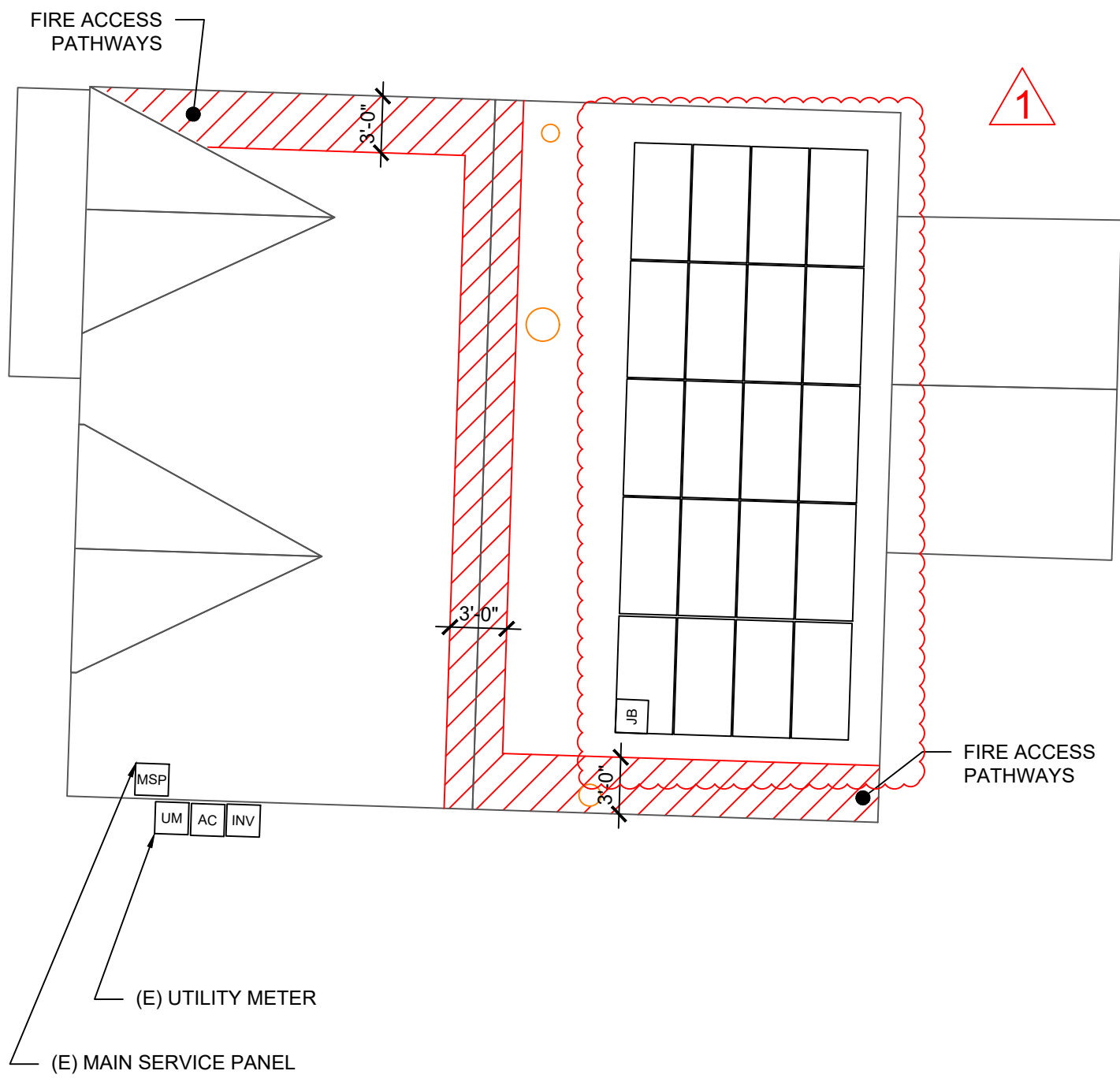

TOTAL ROOF AREA: 2162 SQ FT
 TOTAL ARRAY AREA: 422.71 SQ FT
 ARRAY COVERAGE: 19.55%
 SYSTEM DISTRIBUTED WEIGHT: 2.29 LBS
 ROCKIT SMART SLIDE POINT-LOAD: 23.1 LBS

ROOF AREA: 2162 SQ FT

CLIENT:
 BRADLEY HOCEVAR
 257 BEACON HL RD, LILLINGTON, NC 27546
 AHJ: COUNTY OF HARNETT
 UTILITY: DUKE ENERGY
 METER: 1G8783
 APN: 130630 0096 63
 PHONE: (850) 381-5738
 EMAIL: BRADLEY.HOCEVAR.JR@GMAIL.COM

SYSTEM:
 SYSTEM SIZE (DC): 20 X 410 = 8.200 kW
 SYSTEM SIZE (AC): 6.000 kW @ 240V
 MODULES: 20 X HANWHA QCELL: Q.PEAK DUO BLK ML-G10+ 410
 OPTIMIZERS: 20 X SOLAREEDGE S440
 INVERTER: SOLAREEDGE SE6000H-USRGM [S11]

REVISIONS		
NO.	REVISED BY	DATE
1	A.M.	8/13/2024
-	-	-
-	-	-



FREEDOM FOREVER LLC
 415 INDUSTRIAL CT., GREER, SC 29651
 Tel: (800) 385-1075
GREG ALBRIGHT

CONTRACTOR LICENSE:
 ELECTRICAL CONTRACTOR U.34043

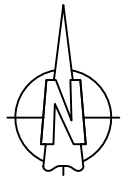

ROOF PLAN
 SCALE: 1/8" = 1'-0"

1

- NOTES:**
- EMT CONDUIT ATTACHED TO THE ROOF USING CONDUIT MOUNTS
 - ATTACHED CLAMPS AT 25% FROM THE EDGE AND 50% FROM THE CENTER OF THE MODULES
 - JUNCTION BOX IS MOUNTED TO THE RAIL.

ROOF PLAN WITH MODULES LAYOUT			
JOB NO: 442757	DATE: 8/13/2024	DESIGNED BY: A.M.	SHEET: PV-2A

ROOF DETAILS:

TOTAL ROOF AREA: 2162 SQ FT
 TOTAL ARRAY AREA: 422.71 SQFT
 ARRAY COVERAGE: 19.55%
 SYSTEM DISTRIBUTED WEIGHT: 2.29 LBS
 ROCKIT SMART SLIDE POINT-LOAD: 23.1 LBS

ROOF AREA STATEMENT						
ROOF	MODULE QUANTITY	ROOF PITCH	ARRAY PITCH	AZIMUTH	ROOF AREA	ARRAY AREA
ROOF 1	20	28	28	92	912 SQ FT	422.71 SQ FT
----	----	----	----	----	SQ FT	SQ FT
----	----	----	----	----	SQ FT	SQ FT
----	----	----	----	----	SQ FT	SQ FT
----	----	----	----	----	SQ FT	SQ FT
----	----	----	----	----	SQ FT	SQ FT
----	----	----	----	----	SQ FT	SQ FT
----	----	----	----	----	SQ FT	SQ FT
----	----	----	----	----	SQ FT	SQ FT
----	----	----	----	----	SQ FT	SQ FT

CLIENT:
 BRADLEY HOCEVAR
 257 BEACON HL RD, LILLINGTON, NC 27546
 AHJ: COUNTY OF HARNETT
 UTILITY: DUKE ENERGY
 METER: 1G8783
 APN: 130630 0096 63
 PHONE: (850) 381-5738
 EMAIL: BRADLEY.HOCEVAR.JR@GMAIL.COM

SYSTEM:
 SYSTEM SIZE (DC): 20 X 410 = 8.200 kW
 SYSTEM SIZE (AC): 6.000 kW @ 240V
 MODULES: 20 X HANWHA QCELL: Q.PEAK
 DUO BLK ML-G10+ 410
 OPTIMIZERS: 20 X SOLAREEDGE S440
 INVERTER: SOLAREEDGE SE6000H-USRGM [S11]

REVISIONS		
NO.	REVISED BY	DATE
1	A.M.	8/13/2024
-	-	-
-	-	-



FREEDOM FOREVER LLC
 415 INDUSTRIAL CT., GREER, SC 29651
 Tel: (800) 385-1075
GREG ALBRIGHT

CONTRACTOR LICENSE:
 ELECTRICAL CONTRACTOR U.34043

ARRAY DETAILS			
JOB NO:	DATE:	DESIGNED BY:	SHEET:
442757	8/13/2024	A.M.	PV-2B

BACKFEED BREAKER SIZING					
MAX. CONTINUOUS OUTPUT 25.00A @ 240V					
25.00	X	1.25	=	31.25AMPS	35A BREAKER - OK
SEE 705.12 OF 2017 NEC					
225	X	1.20	=	270	
270	-	200	=	70A ALLOWABLE BACKFEED	

PV SYSTEM
8.200 kW-DC
6.000 kW-AC

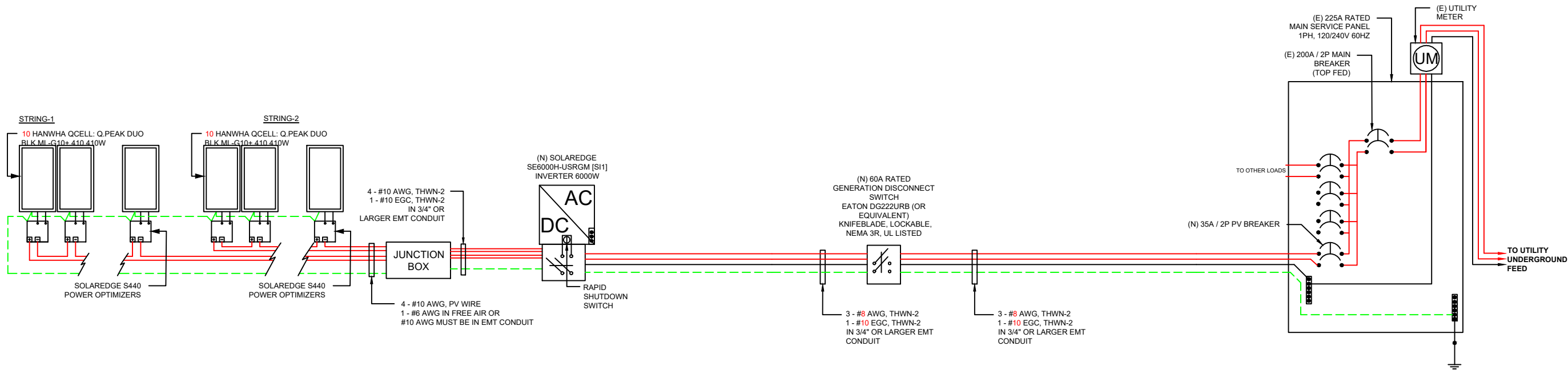

NOTE:
 CONDUIT AND CONDUCTORS SPECIFICATIONS ARE BASED ON MINIMUM CODE REQUIREMENTS AND ARE NOT MEANT TO LIMIT UP-SIZING AS REQUIRED BY FIELD CONDITIONS

CLIENT:
 BRADLEY HOCEVAR
 257 BEACON HL RD, LILLINGTON, NC 27546
 AHJ: COUNTY OF HARNETT
 UTILITY: DUKE ENERGY
 METER: 1G8783
 APN: 130630 0096 63
 PHONE: (850) 381-5738
 EMAIL: BRADLEY.HOCEVAR.JR@GMAIL.COM

SYSTEM:
 SYSTEM SIZE (DC): 20 X 410 = 8.200 kW
 SYSTEM SIZE (AC): 6.000 kW @ 240V
 MODULES: 20 X HANWHA QCELL: Q.PEAK DUO BLK ML-G10+ 410
 OPTIMIZERS: 20 X SOLAREEDGE S440
 INVERTER: SOLAREEDGE SE6000H-USRGM [SI1]

REVISIONS		
NO.	REVISED BY	DATE
1	A.M.	8/13/2024
-	-	-
-	-	-



FREEDOM FOREVER LLC
 415 INDUSTRIAL CT., GREER, SC 29651
 Tel: (800) 385-1075

GREG ALBRIGHT

Greg Albright

CONTRACTOR LICENSE:
 ELECTRICAL CONTRACTOR U.34043

THREE LINE DIAGRAM

JOB NO: 442757	DATE: 8/13/2024	DESIGNED BY: A.M.	SHEET: PV-4
-------------------	--------------------	----------------------	----------------

WARNING:
POWER SOURCE OUTPUT
CONNECTION
DO NOT RELOCATE THIS
OVERCURRENT DEVICE.

705.12(B)(2)(3)(b)

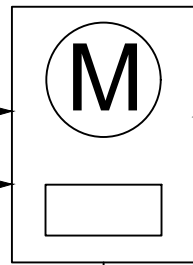

"WARNING"
DUAL POWER SOURCES
SECOND SOURCE IS PHOTOVOLTAIC SYSTEM
RATED AC OUTPUT CURRENT - 25.00 AMPS
AC NORMAL OPERATING VOLTAGE - 240 VOLTS

690.54

NOTES:

- NEC ARTICLES 690 AND 705 AND IRC SECTION R324 MARKINGS SHOWN HEREON.
- ALL MARKING SHALL CONSIST OF THE FOLLOWING:
 - UV RESISTANT SIGN MATERIAL WITH ENGRAVED OR MACHINE PRINTED LETTERS OR ELECTRO-PLATING.
 - RED BACKGROUND COLOR WHITE TEXT AND LINE WORK.
 - ARIAL FONT.
- ALL SIGNS SHALL BE SIZED APPROPRIATELY AND PLACED IN THE LOCATIONS SPECIFIED. SIGNAGE CANNOT BE HAND-WRITTEN.
- SIGNS SHALL BE ATTACHED TO THE SERVICE EQUIPMENT WITH POP-RIVETS OR SCREWS

**SOLAR PV SYSTEM EQUIPPED
WITH RAPID SHUTDOWN**

TURN RAPID
SHUTDOWN SWITCH TO
THE "OFF" POSITION TO
SHUT DOWN PV SYSTEM
AND REDUCE SHOCK
HAZARD IN THE ARRAY

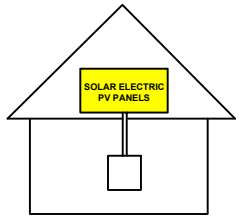

690.56(C)(1)(A)

PV METER

PM

AC

PV SYSTEM AC DISCONNECT
RATED AC OUTPUT CURRENT - 25.00 AMPS
AC NORMAL OPERATING VOLTAGE - 240 VOLTS

690.15, 690.54

**RAPID SHUTDOWN SWITCH FOR
SOLAR PV SYSTEM**

690.56(C)(3)

INVERTER

MAXIMUM VOLTAGE V
MAXIMUM CIRCUIT CURRENT A
MAX DC-DC CONVERTER
OUTPUT CURRENT A

"WARNING"
ELECTRICAL SHOCK HAZARD.
TERMINALS ON BOTH LINE AND LOAD SIDES
MAY BE ENERGIZED IN THE OPEN POSITION.

690.13 (B)

PV SYSTEM DC DISCONNECT
MAXIMUM VOLTAGE: 480V
MAXIMUM CIRCUIT CURRENT: 16.5A
MAX RATED OUTPUT CURRENT OF
THE CONTROLLER OR DC-TO-DC
CONVERTER: 15A

690.53

ARRAY

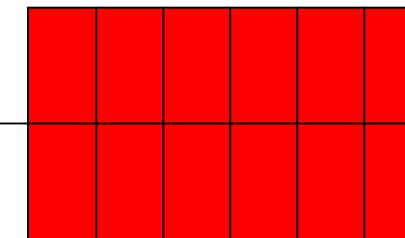

NEC 690.31(G)(3) & (4)

"WARNING"
PHOTOVOLTAIC POWER SOURCE

EVERY 10' ON CONDUIT AND ENCLOSURES

CLIENT:
BRADLEY HOCEVAR
257 BEACON HL RD, LILLINGTON, NC 27546
AHJ: COUNTY OF HARNETT
UTILITY: DUKE ENERGY
METER: 1G8783
APN: 130630 0096 63
PHONE: (850) 381-5738
EMAIL: BRADLEY.HOCEVAR.JR@GMAIL.COM

SYSTEM:
SYSTEM SIZE (DC): 20 X 410 = 8.200 kW
SYSTEM SIZE (AC): 6.000 kW @ 240V
MODULES: 20 X HANWHA QCELL: Q.PEAK
DUO BLK ML-G10+ 410
OPTIMIZERS: 20 X SOLAREEDGE S440
INVERTER: SOLAREEDGE SE6000H-USRGM
[S11]

REVISIONS		
NO.	REVISED BY	DATE
1	A.M.	8/13/2024
-	-	-
-	-	-



FREEDOM FOREVER LLC
415 INDUSTRIAL CT., GREER, SC 29651
Tel: (800) 385-1075

GREG ALBRIGHT

CONTRACTOR LICENSE:
ELECTRICAL CONTRACTOR U.34043

LABELS			
JOB NO:	DATE:	DESIGNED BY:	SHEET:
442757	8/13/2024	A.M.	PV-7

CAUTION:

POWER TO THIS BUILDING IS ALSO SUPPLIED FROM THE FOLLOWING SOURCES WITH DISCONNECTS AS SHOWN

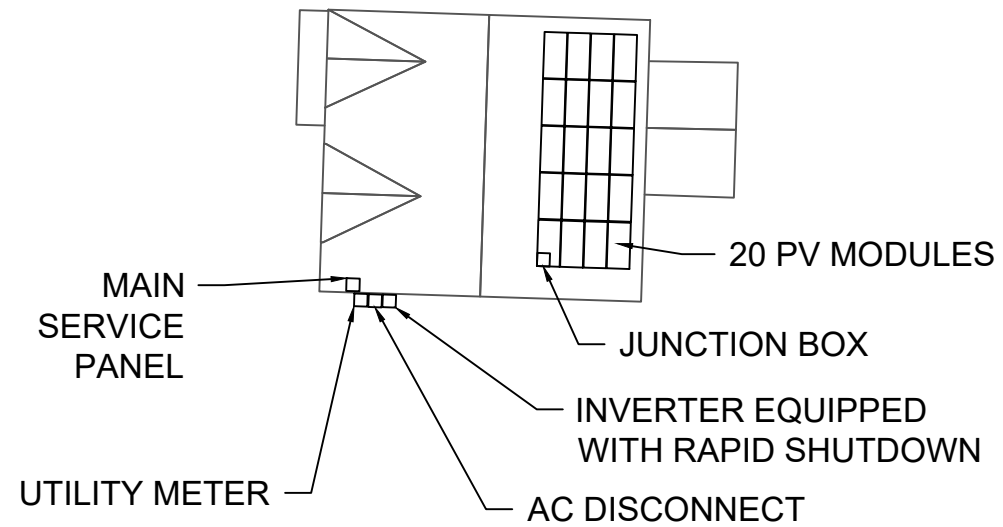

WARNING

TURN OFF PHOTOVOLTAIC AC DISCONNECT PRIOR TO WORKING INSIDE PANEL



CLIENT:
 BRADLEY HOCEVAR
 257 BEACON HL RD, LILLINGTON, NC 27546
 AHJ: COUNTY OF HARNETT
 UTILITY: DUKE ENERGY
 METER: 1G8783
 APN: 130630 0096 63
 PHONE: (850) 381-5738
 EMAIL: BRADLEY.HOCEVAR.JR@GMAIL.COM

SYSTEM:
 SYSTEM SIZE (DC): 20 X 410 = 8.200 kW
 SYSTEM SIZE (AC): 6.000 kW @ 240V
 MODULES: 20 X HANWHA QCELL: Q.PEAK DUO BLK ML-G10+ 410
 OPTIMIZERS: 20 X SOLAREEDGE S440
 INVERTER: SOLAREEDGE SE6000H-USRGM [S1]

REVISIONS		
NO.	REVISED BY	DATE
1	A.M.	8/13/2024
-	-	-
-	-	-



FREEDOM FOREVER LLC
 415 INDUSTRIAL CT., GREER, SC 29651
 Tel: (800) 385-1075

GREG ALBRIGHT

CONTRACTOR LICENSE:
 ELECTRICAL CONTRACTOR U.34043

SITE PLACARD

JOB NO:	DATE:	DESIGNED BY:	SHEET:
442757	8/13/2024	A.M.	PV-7A

NOTES:

1. NEC ARTICLES 690 AND 705 AND IRC SECTION R324 MARKINGS SHOWN HEREON.
2. ALL MARKING SHALL CONSIST OF THE FOLLOWING:
 - A. UV RESISTANT SIGN MATERIAL WITH ENGRAVED OR MACHINE PRINTED LETTERS OR ELECTRO-PLATING.
 - B. RED BACKGROUND COLOR WHITE TEXT AND LINE WORK.
 - C. AERIAL FONT.
3. ALL SIGNS SHALL BE SIZED APPROPRIATELY AND PLACED IN THE LOCATIONS SPECIFIED. SIGNAGE CANNOT BE HAND-WRITTEN.
4. SIGNS SHALL BE ATTACHED TO THE SERVICE EQUIPMENT WITH POP-RIVETS OR SCREWS.

1-20

21-40

41-60

SOLAREEDGE OPTIMIZER CHART

1

2

3

4

5

6

7

8

9

10

11

12

13

14

15

16

17

18

19

20

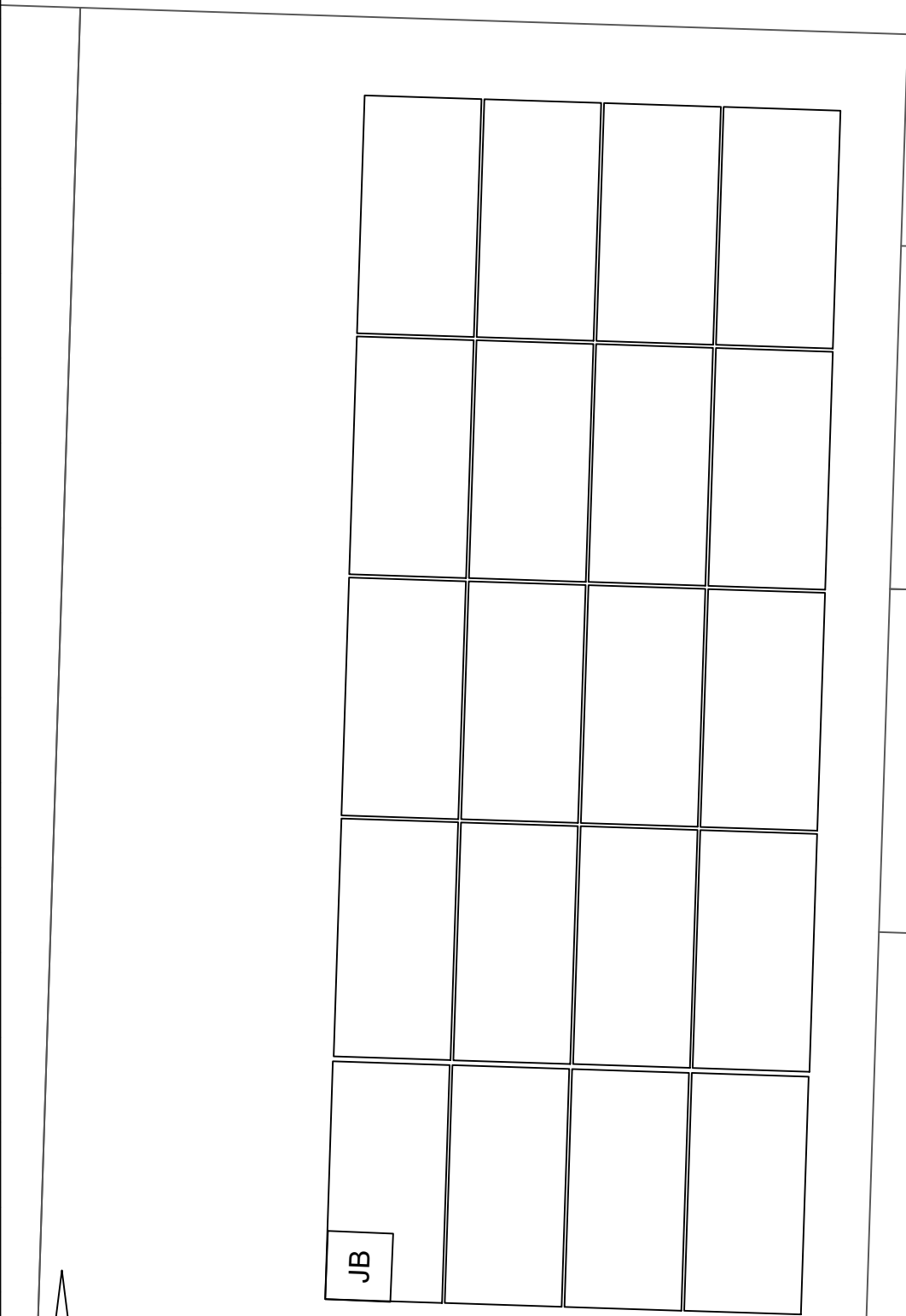

CLIENT:
 BRADLEY HOCEVAR
 257 BEACON HL RD, LILLINGTON, NC 27546
 AHJ: COUNTY OF HARNETT
 UTILITY: DUKE ENERGY
 METER: 1G8783
 APN: 130630 0096 63
 PHONE: (850) 381-5738
 EMAIL: BRADLEY.HOCEVAR.JR@GMAIL.COM

SYSTEM:
 SYSTEM SIZE (DC): 20 X 410 = 8.200 kW
 SYSTEM SIZE (AC): 6.000 kW @ 240V
 MODULES: 20 X HANWHA QCELL: Q.PEAK
 DUO BLK ML-G10+ 410
 OPTIMIZERS: 20 X SOLAREEDGE S440
 INVERTER: SOLAREEDGE SE6000H-USRGM [S1]

REVISIONS		
NO.	REVISED BY	DATE
1	A.M.	8/13/2024
-	-	-
-	-	-



FREEDOM FOREVER LLC
 415 INDUSTRIAL CT., GREER, SC 29651
 Tel: (800) 385-1075

GREG ALBRIGHT

Greg Albright

CONTRACTOR LICENSE:
 ELECTRICAL CONTRACTOR U.34043

OPTIMIZER CHART			
JOB NO:	DATE:	DESIGNED BY:	SHEET:
442757	8/13/2024	A.M.	PV-8

FOR INSTALLATION REFERENCE ONLY

SCAN QR CODE TO ACCESS REFERENCE LINK

FREEDOM REFERENCES



INSTALL HOTLINE

PV INSTALLATION REFERENCES



ENPHASE



SOLAREEDGE



TESLA

BATTERY INSTALLATION REFERENCES



Enphase Storage Systems



SOLAREEDGE Storage Systems



TESLA Storage Systems



NON-BACKUP Battery Systems



Misc. Quick Guide

powered by

Q.ANTUM DUO Z

Q.PEAK DUO ML-G10+

395-415

ENDURING HIGH PERFORMANCE



BREAKING THE 20% EFFICIENCY BARRIER
Q.ANTUM DUO Z Technology with zero gap cell layout boosts module efficiency up to 21.4%.



THE MOST THOROUGH TESTING PROGRAMME IN THE INDUSTRY
Q CELLS is the first solar module manufacturer to pass the most comprehensive quality programme in the industry: The new "Quality Controlled PV" of the independent certification institute TÜV Rheinland.



INNOVATIVE ALL-WEATHER TECHNOLOGY
Optimal yields, whatever the weather with excellent low-light and temperature behavior.



ENDURING HIGH PERFORMANCE
Long-term yield security with Anti LID Technology, Anti PID Technology¹, Hot-Spot Protect and Traceable Quality Tra.Q™.



EXTREME WEATHER RATING
High-tech aluminum alloy frame, certified for high snow (5400Pa) and wind loads (4000Pa).



A RELIABLE INVESTMENT
Inclusive 25-year product warranty and 25-year linear performance warranty².

¹ APT test conditions according to IEC/TS 62804-1:2015, method A (-1500V, 96h)
² See data sheet on rear for further information.

THE IDEAL SOLUTION FOR:



Rooftop arrays on residential buildings

Engineered in Germany



MECHANICAL SPECIFICATION

Format	74.0 in × 41.1 in × 1.26 in (including frame) (1879 mm × 1045 mm × 32 mm)
Weight	48.5 lbs (22.0 kg)
Front Cover	0.13 in (3.2 mm) thermally pre-stressed glass with anti-reflection technology
Back Cover	Composite film
Frame	Black anodized aluminum
Cell	6 × 22 monocrystalline Q.ANTUM solar half cells
Junction Box	2.09-3.98 in × 1.26-2.36 in × 0.59-0.71 in (53-101 mm × 32-60 mm × 15-18 mm), IP67, with bypass diodes
Cable	4 mm ² Solar cable; (+) ≥ 49.2 in (1250 mm), (-) ≥ 49.2 in (1250 mm)
Connector	Stäubli MC4; IP68

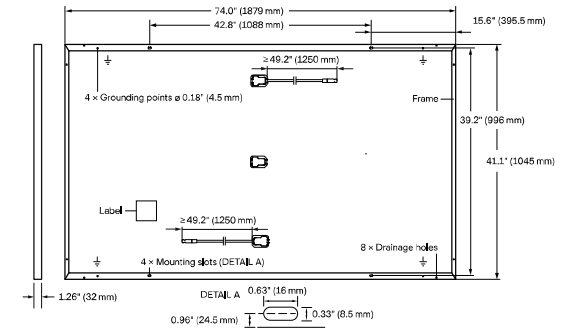

ELECTRICAL CHARACTERISTICS

POWER CLASS		395	400	405	410	415	
MINIMUM PERFORMANCE AT STANDARD TEST CONDITIONS, STC¹ (POWER TOLERANCE +5 W / -0 W)							
Minimum	Power at MPP ¹	P _{MPP} [W]	395	400	405	410	415
	Short Circuit Current ¹	I _{SC} [A]	11.13	11.16	11.19	11.22	11.26
	Open Circuit Voltage ¹	V _{OC} [V]	45.03	45.06	45.09	45.13	45.16
	Current at MPP	I _{MPP} [A]	10.58	10.64	10.70	10.76	10.82
	Voltage at MPP	V _{MPP} [V]	37.32	37.59	37.85	38.11	38.37
	Efficiency ¹	η [%]	≥20.1	≥20.4	≥20.6	≥20.9	≥21.1
MINIMUM PERFORMANCE AT NORMAL OPERATING CONDITIONS, NMOT²							
Minimum	Power at MPP	P _{MPP} [W]	296.4	300.1	303.9	307.6	311.4
	Short Circuit Current	I _{SC} [A]	8.97	8.99	9.02	9.04	9.07
	Open Circuit Voltage	V _{OC} [V]	42.46	42.49	42.52	42.56	42.59
	Current at MPP	I _{MPP} [A]	8.33	8.38	8.43	8.48	8.53
	Voltage at MPP	V _{MPP} [V]	35.59	35.82	36.04	36.27	36.49

¹ Measurement tolerances P_{MPP} ± 3%; I_{SC}, V_{OC} ± 5% at STC: 1000 W/m², 25 ± 2°C, AM 1.5 according to IEC 60904-3 • 2800 W/m², NMOT, spectrum AM 1.5

Q CELLS PERFORMANCE WARRANTY

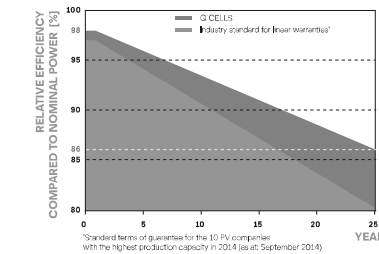

At least 98% of nominal power during first year. Thereafter max. 0.5% degradation per year. At least 93.5% of nominal power up to 10 years. At least 86% of nominal power up to 25 years.

All data within measurement tolerances. Full warranties in accordance with the warranty terms of the Q CELLS sales organisation of your respective country.

PERFORMANCE AT LOW IRRADIANCE

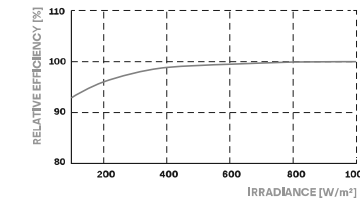

Typical module performance under low irradiance conditions in comparison to STC conditions (25°C, 1000 W/m²)

TEMPERATURE COEFFICIENTS

Temperature Coefficient of I _{SC}	α [%/K]	+0.04	Temperature Coefficient of V _{OC}	β [%/K]	-0.27
Temperature Coefficient of P _{MPP}	γ [%/K]	-0.34	Nominal Module Operating Temperature	NMOT [°F]	109 ± 5.4 (43 ± 3 °C)

PROPERTIES FOR SYSTEM DESIGN

Maximum System Voltage V _{sys}	[V]	1000 (IEC)/1000 (UL)	PV module classification	Class II
Maximum Series Fuse Rating	[A DC]	20	Fire Rating based on ANSI / UL 61730	TYPE 2
Max. Design Load, Push / Pull ³	[lbs/ft ²]	75 (3600 Pa) / 55 (2660 Pa)	Permitted Module Temperature on Continuous Duty	-40°F up to +185°F (-40°C up to +85°C)
Max. Test Load, Push / Pull ³	[lbs/ft ²]	113 (5400 Pa) / 84 (4000 Pa)		

³ See Installation Manual

QUALIFICATIONS AND CERTIFICATES

UL 61730, CE-compliant, Quality Controlled PV - TÜV Rheinland, IEC 61215:2016, IEC 61730:2016, U.S. Patent No. 9,893,215 (solar cells), QCPV Certification ongoing.



PACKAGING INFORMATION

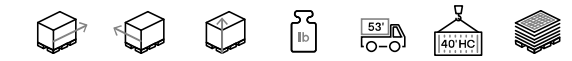

Horizontal packaging	76.4 in 1940 mm	43.3 in 1100 mm	48.0 in 1220 mm	1656 lbs 751 kg	24 pallets	24 pallets	32 modules
----------------------	--------------------	--------------------	--------------------	--------------------	------------	------------	------------

Note: Installation instructions must be followed. See the installation and operating manual or contact our technical service department for further information on approved installation and use of this product.

Hanwha Q CELLS America Inc.

400 Spectrum Center Drive, Suite 1400, Irvine, CA 92618, USA | TEL +1 949 748 59 96 | EMAIL inquiry@us.q-cells.com | WEB www.q-cells.us

SolarEdge Home Wave Inverter For North America

SE3800H-US / SE5000H-US / SE6000H-US /
SE7600H-US / SE10000H-US / SE11400H-US



INVERTERS

Optimized installation with HD-Wave technology

- Specifically designed to work with power optimizers
- Record-breaking 99% weighted efficiency
- Quick and easy inverter commissioning directly from a smartphone using SolarEdge SetApp
- Fixed voltage inverter for longer strings
- Integrated arc fault protection and rapid shutdown for NEC 2014-2023 per articles 690.11 and 690.12
- UL1741 SA certified, for CPUC Rule 21 grid compliance
- Small, lightweight, and easy to install both outdoors or indoors
- Built-in module-level monitoring
- Optional: Faster installations with built-in consumption metering (1% accuracy) and production revenue grade metering (0.5% accuracy, ANSI C12.20)

/ SolarEdge Home Wave Inverter For North America

SE3800H-US / SE5000H-US / SE6000H-US /
SE7600H-US / SE10000H-US / SE11400H-US

Applicable to inverters with part number	SEXXXXH-XXXXBXX4					SE11400H-XXXXBXX5	Units
	SE3800H-US	SE5000H-US	SE6000H-US	SE7600H-US	SE10000H-US	SE11400H-US	
OUTPUT							
Rated AC Power Output	3800 @ 240V 3300 @ 208V	5000	6000 @ 240V 5000 @ 208V	7600	10000	11400 @ 240V 10000 @ 208V	VA
Maximum AC Power Output	3800 @ 240V 3300 @ 208V	5000	6000 @ 240V 5000 @ 208V	7600	10000	11400 @ 240V 10000 @ 208V	VA
AC Output Voltage Min.-Nom.-Max. (211 - 240 - 264)	✓	✓	✓	✓	✓	✓	Vac
AC Output Voltage Min.-Nom.-Max. (183 - 208 - 229)	✓	-	✓	-	-	✓	Vac
AC Frequency (Nominal)	59.3 - 60 - 60.5 ⁽¹⁾						Hz
Maximum Continuous Output Current @240V	16	21	25	32	42	47.5	A
Maximum Continuous Output Current @208V	16	-	24	-	-	48.5	A
Power Factor	1, Adjustable - 0.85 to 0.85						
GFDI Threshold	1						A
Utility Monitoring, Islanding Protection, Country Configurable Thresholds	Yes						
INPUT							
Maximum DC Power @240V	5900	7750	9300	11800	15500	17650	W
Maximum DC Power @208V	5100	-	7750	-	-	15500	W
Transformer-less, Ungrounded	Yes						
Maximum Input Voltage	480						Vdc
Nominal DC Input Voltage	380						Vdc
Maximum Input Current @240V ⁽²⁾	10.5	13.5	16.5	20	27	30.5	Adc
Maximum Input Current @208V ⁽²⁾	9	-	13.5	-	-	27	Adc
Max. Input Short Circuit Current	45						Adc
Reverse-Polarity Protection	Yes						
Ground-Fault Isolation Detection	600k Sensitivity						
Maximum Inverter Efficiency	99.2						%
CEC Weighted Efficiency	99					99 @ 240V 98.5 @ 208V	%
Nighttime Power Consumption	< 2.5						W

(1) For other regional settings please contact SolarEdge support.

(2) A higher current source may be used; the inverter will limit its input current to the values stated.

/ SolarEdge Home Wave Inverter

For North America

SE3800H-US / SE5000H-US / SE6000H-US/

SE7600H-US / SE10000H-US / SE11400H-US

Applicable to inverters with part number	SEXXXXH-XXXXXBXX4					SE11400H-XXXXXBXX5	
	SE3800H-US	SE5000H-US	SE6000H-US	SE7600H-US	SE10000H-US	SE11400H-US	
ADDITIONAL FEATURES							
Supported Communication Interfaces	RS485, Ethernet, ZigBee (optional), wireless SolarEdge Home Network (optional) ⁽³⁾ , Wi-Fi (optional), Cellular (optional)						
Revenue Grade Metering, ANSI C12.20	Optional ⁽⁴⁾						
Consumption Metering							
Inverter Commissioning	With the SetApp mobile application using Built-in Wi-Fi Access Point for Local Connection						
Rapid Shutdown - NEC 2014-2023 per articles 690.11 and 690.12	Automatic Rapid Shutdown upon AC Grid Disconnect						
STANDARD COMPLIANCE							
Safety	UL1741, UL1741 SA, UL1741 SB, UL1699B, CSA C22.2, Canadian AFCI according to T.I.L. M-07						
Grid Connection Standards	IEEE1547-2018, Rule 21, Rule 14 (H), CSA C22.3 No. 9						
Emissions	FCC Part 15 Class B						
INSTALLATION SPECIFICATIONS							
AC Output Conduit Size / AWG Range	1" Maximum / 14 – 6 AWG			1" Maximum / 14 – 4 AWG			
DC Input Conduit Size / # of Strings / AWG Range	1" Maximum / 1 – 2 strings / 14 – 6 AWG			1" Maximum / 1 – 3 strings / 14 – 6 AWG			
Dimensions with Safety Switch (H x W x D)	17.7 x 14.6 x 6.8 / 450 x 370 x 174			21.06 x 14.6 x 7.3 / 535 x 370 x 185	21.06 x 14.6 x 8.2 / 535 x 370 x 208 ⁽⁵⁾		in / mm
Weight with Safety Switch	22 / 10	25.1 / 11.4	26.2 / 11.9	38.8 / 17.6	44.9 / 20.4 ⁽⁵⁾		lb / kg
Noise	< 25			< 50			dBA
Cooling	Natural Convection						
Operating Temperature Range	-40 to +140 / -40 to +60 ⁽⁶⁾						°F / °C
Protection Rating	NEMA 4X (Inverter with Safety Switch)						

(3) For more information, refer to the [SolarEdge Home Network](#) datasheet

(4) Inverter with Revenue Grade Production and Consumption Meter P/N: SExxxxH-US000BEI4. For consumption metering, current transformers should be ordered separately: SEACT0750-400NA-20 or SEACT0750-400NA-20. 20 units per box.

(5) SE11400H-USxxxBox5 is the updated PN, though SE11400H-USxxxBox4 will still be available. All specifications are similar for both models, **EXCLUDING** the weight and dimensions [HxWxD]. The weight and dimensions of SE11400H-USxxxBox4 are 17.6 [kg] and 21.06-14.6-7.3 / 535-370-185 [in/mm], accordingly.

(6) Full power up to at least 50°C / 122°F; for power de-rating information refer to the [Temperature De-rating Technical Note for North America](#).

How to Enable Consumption Monitoring

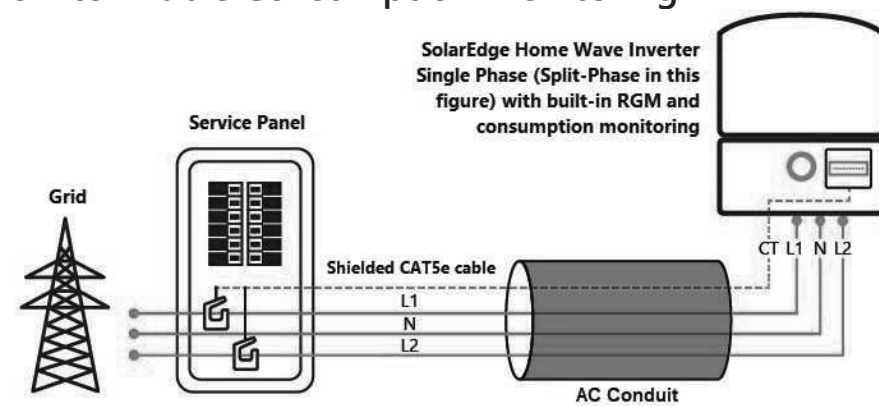

By simply wiring current transformers through the inverter's existing AC conduits and connecting them to the service panel, homeowners will gain full insight into their household energy usage helping them to avoid high electricity bills.

Power Optimizer For North America

S440, S500



POWER OPTIMIZER

PV power optimization at the module level

- Specifically designed to work with SolarEdge residential inverters
- Detects abnormal PV connector behavior, preventing potential safety issues*
- Module-level voltage shutdown for installer and firefighter safety
- Superior efficiency (99.5%)
- Mitigates all types of module mismatch loss, from manufacturing tolerance to partial shading
- Faster installations with simplified cable management and easy assembly using a single bolt
- Flexible system design for maximum space utilization
- Compatible with bifacial PV modules
- Meets NEC requirements for arc fault protection (AFCI) and Photovoltaic Rapid Shutdown System (PVRSS)

* Expected availability in 2022

solaredge.com



/ Power Optimizer For North America S440, S500

	S440	S500	Unit
INPUT			
Rated Input DC Power ⁽¹⁾	440	500	W
Absolute Maximum Input Voltage (Voc)	60		Vdc
MPPT Operating Range	8 - 60		Vdc
Maximum Short Circuit Current (Isc) of Connected PV Module	14.5	15	Adc
Maximum Efficiency	99.5		%
Weighted Efficiency	98.6		%
Ovenvoltage Category	II		
OUTPUT DURING OPERATION			
Maximum Output Current	15		Adc
Maximum Output Voltage	60		Vdc
OUTPUT DURING STANDBY (POWER OPTIMIZER DISCONNECTED FROM INVERTER OR INVERTER OFF)			
Safety Output Voltage per Power Optimizer	1+/-0.1		Vdc
STANDARD COMPLIANCE			
Photovoltaic Rapid Shutdown System	NEC 2014, 2017 & 2020		
EMC	FCC Part 15 Class B, IEC61000-6-2, IEC61000-6-3		
Safety	IEC62109-1 (class II safety), UL1741		
Material	UL94 V-0, UV Resistant		
RoHS	Yes		
Fire Safety	VDE-AR-E 2100-712:2013-05		
INSTALLATION SPECIFICATIONS			
Maximum Allowed System Voltage	1000		Vdc
Dimensions (W x L x H)	129 x 153 x 30 / 5.07 x 6.02 x 1.18		mm / in
Weight (including cables)	655 / 1.5		gr / lb
Input Connector	MC4 ⁽²⁾		
Input Wire Length	0.1 / 0.32		m / ft
Output Connector	MC4		
Output Wire Length	(+) 2.3, (-) 0.10 / (+) 7.54, (-) 0.32		m / ft
Operating Temperature Range ⁽³⁾	-40 to +85		°C
Protection Rating	IP68 / Type6B		
Relative Humidity	0 - 100		%

(1) Rated power of the module at STC will not exceed the power optimizer Rated Input DC Power. Modules with up to +5% power tolerance are allowed

(2) For other connector types please contact SolarEdge

(3) For ambient temperature above +70°C / +158°F power de-rating is applied. Refer to Power Optimizers Temperature De-Rating Technical Note for more details

PV System Design Using a SolarEdge Inverter	Single Phase HD-Wave	Three Phase for 208V grid	Three Phase for 277/480V grid	
Minimum String Length (Power Optimizers)	S440, S500	8	14	18
Maximum String Length (Power Optimizers)	25		50 ⁽⁴⁾	
Maximum Nominal Power per String	5700 (6000 with SE7600-US-SE11400-U)	6000	12750	W
Maximum Allowed Connected Power per String ⁽⁵⁾ (Permitted only when the difference in connected power between strings is 1,000W or less)	Refer to Footnote 5	One String 7200W Two strings or more 7800W	15,000W	
Parallel Strings of Different Lengths or Orientations	Y			

(4) A string with more than 30 optimizers does not meet NEC rapid shutdown requirements; safety voltage will be above the 30V requirement

(5) If the inverters rated AC power < maximum nominal power per string, then the maximum power per string will be able to reach up to the inverters maximum input DC power. Refer to: <https://www.solaredge.com/sites/default/files/se-power-optimizer-single-string-design-application-note.pdf>

(6) It is not allowed to mix S-series and P-series Power Optimizers in new installations

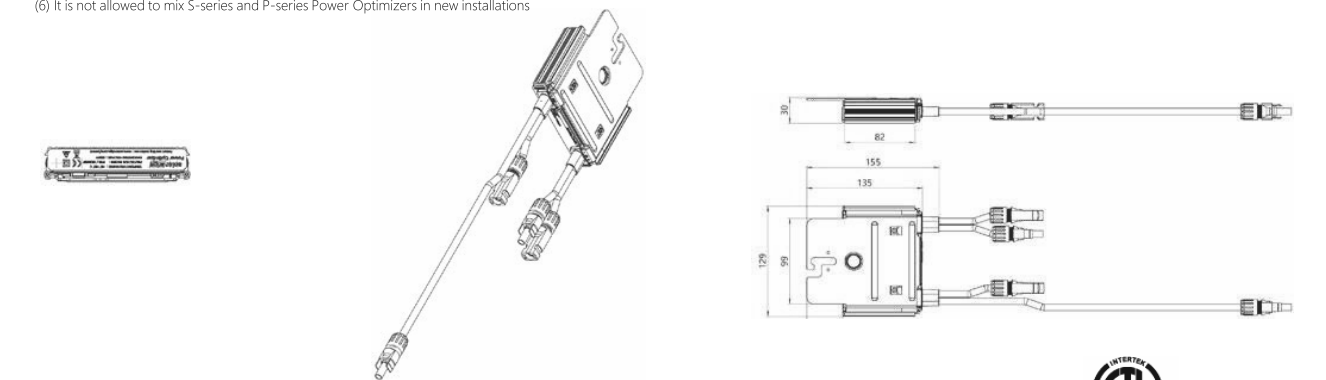

© SolarEdge Technologies, Inc. All rights reserved. SOLAREEDGE, the SolarEdge logo, OPTIMIZED BY SOLAREEDGE are trademarks or registered trademarks of SolarEdge Technologies, Inc. All other trademarks mentioned herein are trademarks of their respective owners. Date: February 8, 2022 DS-000018-NA. Subject to change without notice.



Product specifications

Eaton DG222URB

Catalog Number: DG222URB

Eaton General duty non-fusible safety switch, single-throw, 60 A, NEMA 3R, Rainproof, Painted galvanized steel, Two-pole, Two-wire, 240 V

General specifications

Product Name	Catalog Number
Eaton general duty non-fusible safety switch	DG222URB
	UPC
	782113144238
Product Length/Depth	Product Height
7.38 in	14.38 in
Product Width	Product Weight
8.69 in	9 lb
Warranty	Certifications
Eaton Selling Policy 25-000, one (1) year from the date of installation of the Product or eighteen (18) months from the date of shipment of the Product, whichever occurs first.	UL Listed
	Catalog Notes
	WARNING! Switch is not approved for service entrance unless a neutral kit is installed.



Product specifications

Product Category
General duty safety switch
Enclosure material
Painted galvanized steel
Type
Non-fusible, single-throw
Fuse configuration
Non-fusible
Number of wires
2
Enclosure
NEMA 3R
Voltage rating
240V
Amperage Rating
60A
Number Of Poles
Two-pole

Resources

Catalogs
Eaton's Volume 2—Commercial Distribution
Multimedia
Double Up on Safety
Switching Devices Flex Center
Specifications and datasheets
Eaton Specification Sheet - DG222URB
Warranty guides
Selling Policy 25-000 - Distribution and Control Products and Services



Eaton Corporation plc
Eaton House
30 Pembroke Road
Dublin 4, Ireland
Eaton.com
© 2023 Eaton. All Rights Reserved.

Eaton is a registered trademark.
All other trademarks are property of their respective owners.



Eaton.com/socialmedia

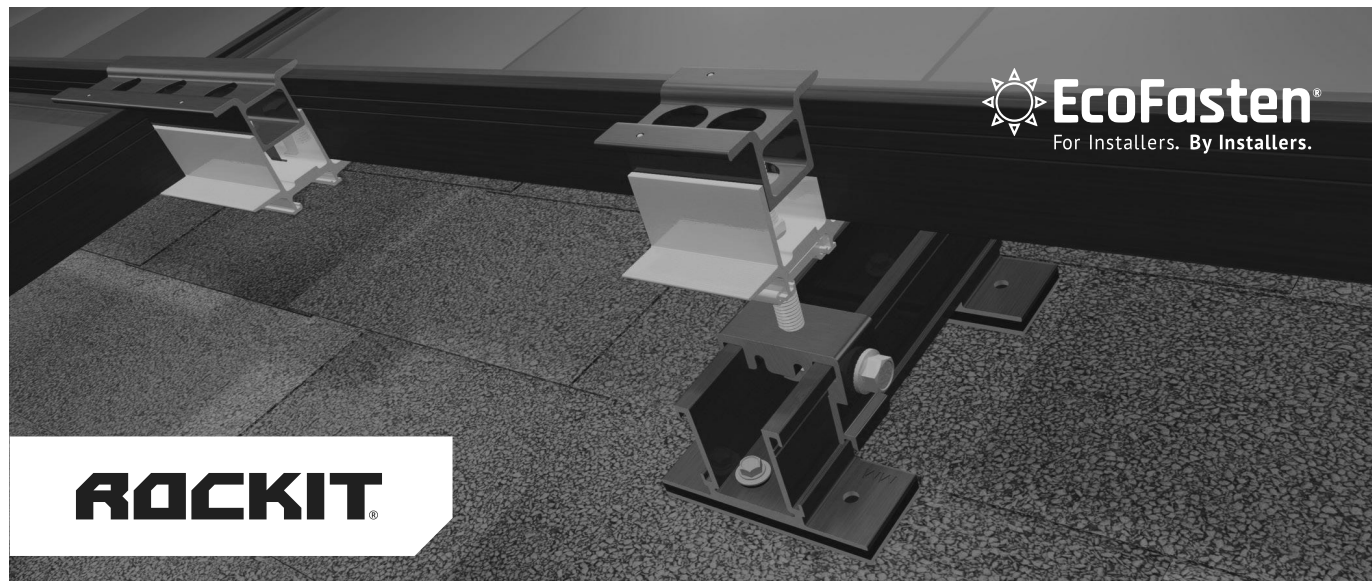

ROCKIT

INTRODUCING ROCKIT SMART SLIDE!

Introducing EcoFasten's patent pending RockIt Smart Slide, our simple solution for quickly installing the popular RockIt rail-less racking system to composition shingle roofs.

Features & Benefits

- Eliminates the need to pry up shingle courses and install a metal flashing
- Multiple opportunities to find the rafter
- No need for additional material when architectural shingles are not level
- Longer 6.75" slide avoids overlaps in shingle courses
- Integrated flashing utilizes UltraGrip Technology™ to create a watertight seal

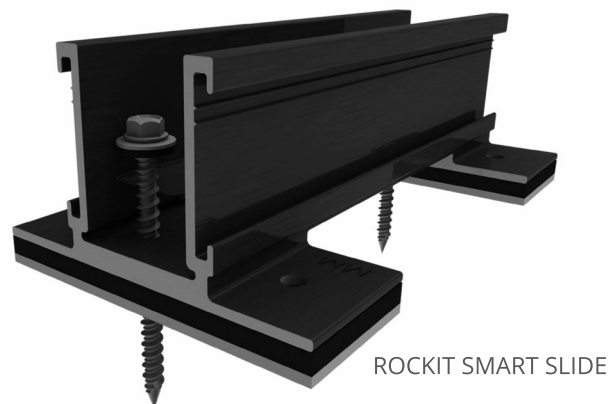

Required Components:

Part Number:	Description:
2011024	RI SMART SLIDE BLK 6.75"
2011025	RI SMART SCRW #12X3" W/BW

ROCKIT SMART SLIDE

Integrated UltraGrip Technology™

Pre-installed sealing pads are compatible with all composition shingle roofs. The compression achieved when fastened to the roof creates a super strong watertight seal. In most cases, the slide can be mounted to the deck without the need for sealant. A layer of flexible foam provides cushioning, which allows the waterproofing sealant to embed deep into the granules of the shingle as well as to flexibly conform over the steps found on architectural-style shingles.

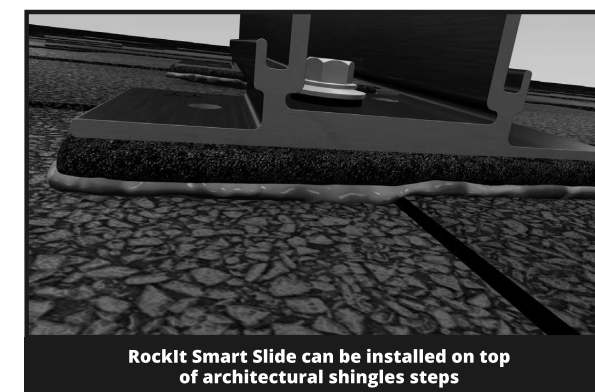
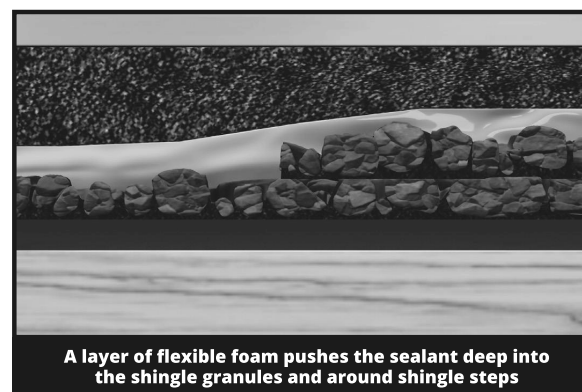

Testing & Documentation

- [UL441 Rain Report](#)
- [TAS 100 \(A\)-95 Wind and Wind Driven Rain Resistance](#)
- [Mechanical Load Test/Structural Capacity Certification](#)
- [Florida Product Approval](#)
- [RockIt Installation Manual](#)
- [RockIt CutSheets](#)



RI SMART SLIDE BLK 6.75"

PART NUMBER	DESCRIPTION
2011024	RI SMART SLIDE BLK 6.75"

ITEM NO.	DESCRIPTION
1	ROCKIT SMART SLIDE ASSEMBLY

1) ROCKIT FLASHLESS SLIDE ASSEMBLY

MATERIAL	ALUMINUM, EPDM, ADHESIVE, TREATED PAPER
FINISH	BLACK

Rev: CS-3

RI SMART SCREW #12X3" W/BW

PART NUMBER	DESCRIPTION
2011025	RI SMART SCREW #12X3" W/BW

ITEM NO.	DESCRIPTION
1	SELF TAPPING SCREW #12 WITH SEALING WASHER ASSEMBLY

MATERIAL	STAINLESS STEEL, EPDM RUBBER
FINISH	MILL, BLACK

Rev: CS-2



ROCKIT®

COMPLETE RAIL-LESS RACKING SYSTEM

The RockIt system is the industry's premier rail-less PV racking system for composition shingle, tile, and metal roofs. Designed in conjunction with the needs of installers, RockIt quickly & easily installs with a single tool. Featuring an easy-to-position alignment slide and a top-down leveling system, RockIt is logistically intelligent with no need to ship or transport long rails. Components are available in a black finish that complements both commercial and residential applications. Conforms to UL 2703.

FEATURES & BENEFITS

- Patented watertight technology
- Fully integrated bonding
- Top-down leveling system
- North-South adjustability
- Single tool install
- Florida Product Approved for composition shingle roofs

STREAMLINED INSTALLATION WITH MINIMAL ROOF PENETRATIONS



ROCKIT

ROCKIT COUPLING

The fast installing RockIt Coupling easily attaches to the module frame to bridge the gaps between modules.

SKIRT

The sleek black Skirt installs first and acts as an alignment guide for the entire array. The Skirt End Cap does double duty as a skirt coupling device and an aesthetically-pleasing finishing touch.

ROCKIT MOUNT

Featuring integrated bonding pins, the RockIt Mount connects to the Slide and can easily be positioned for fast installation. Features top-down leveling.

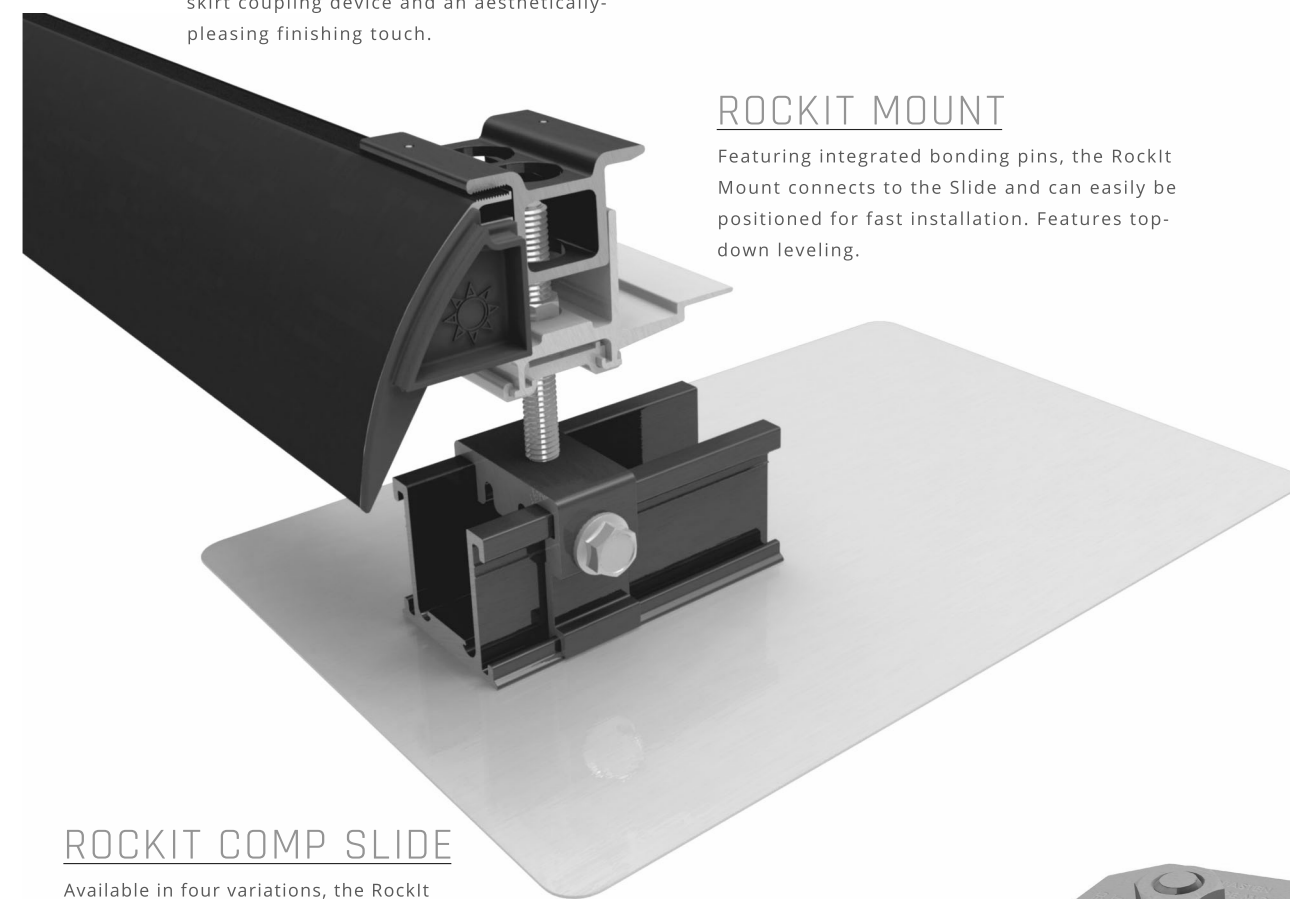

ROCKIT COMP SLIDE

Available in four variations, the RockIt Slide allows installation on composition shingle, tile, and metal roofs.

FRAME MLPE MOUNT

Attaches and fully bonds MLPE's (Module Level Power Electronics) to the module frame with a single bolt clip.

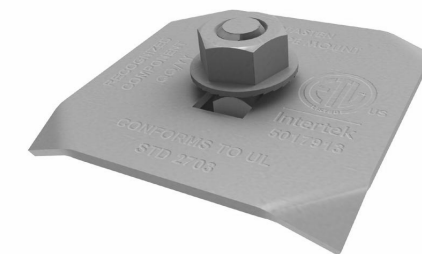

RI COMP SLIDE AL BLK

PART NUMBER	DESCRIPTION
2011013	RI COMP SLIDE AL BLK

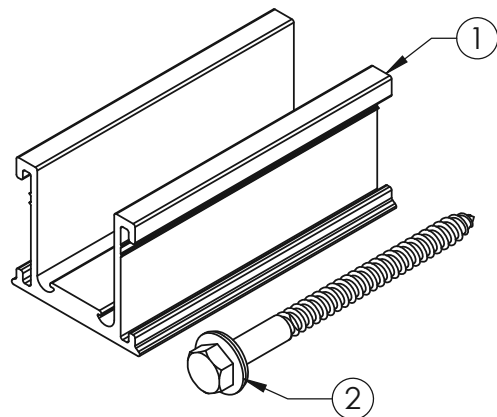

ITEM NO.	DESCRIPTION
1	ROCKIT V3 SLIDECOMP
2	LAG SCREW, 5/16-4", THREAD 3", EPDM BACKED WASHER

1) ROCKIT V3 SLIDECOMP

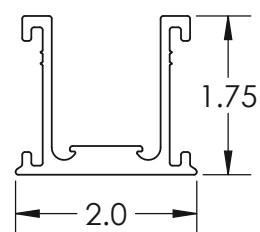
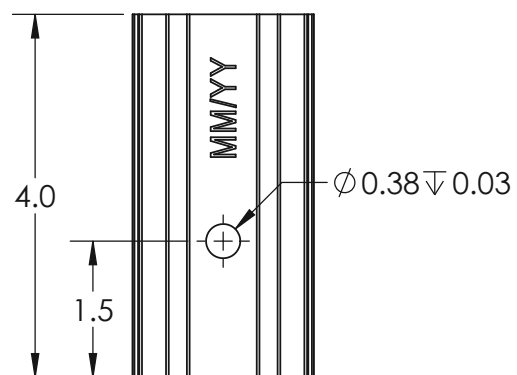

Material	Aluminum
Finish	Black

REV.- CS1

RI COMP SLIDE AL BLK

2) LAG SCREW, 5/16-4", THREAD 3", EPDM BACKED WASHER

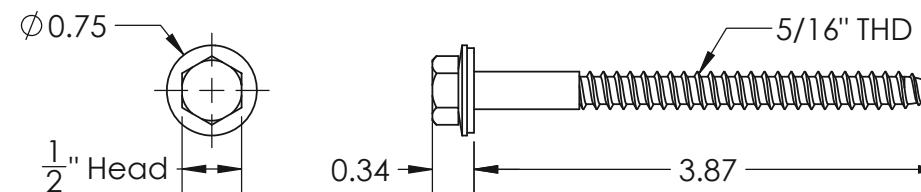

Material	Stainless Steel
Finish	Mill

REV.- CS1

GF-1 FLASHING GLV BLK 8X10"

PART NUMBER	DESCRIPTION
3012020	GF-1 FLASHING GLV BLK 8X10"

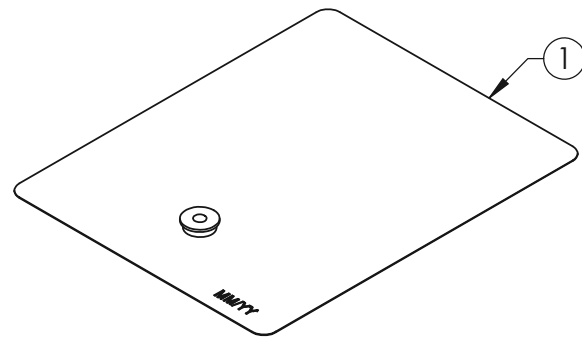

ITEM NO.	DESCRIPTION
1	GF1M-GAL-BLK-810 W/O WASHER ASSEMBLY

1) GF1M-GAL-BLK-810 W/O WASHER ASSEMBLY

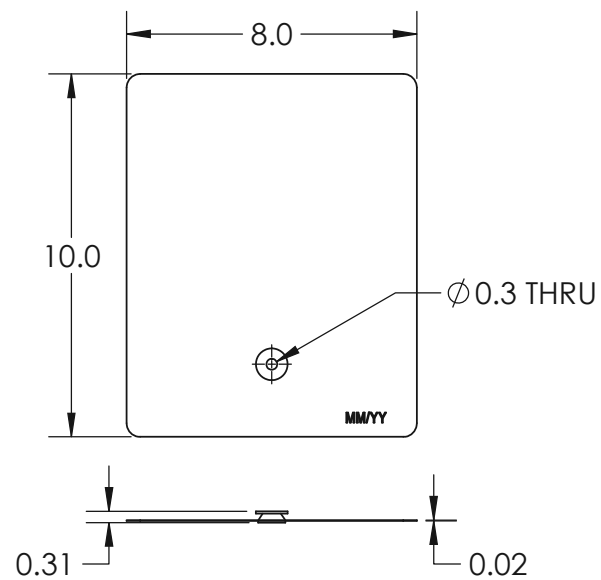

Material	Corrosion Resistant Steel
Finish	Black

REV.- CS1





ECOFASTEN SOLAR LLC
4141 W. VAN BUREN ST., SUITE 2
PHOENIX, AZ 85009

877-859-3947
INFO@ECOFASTENSOLAR.COM

April 8th, 2024

EcoFasten
4141 West Van Buren St.
Phoenix, AZ 85009

Attn.: EcoFasten Solar Engineering Department

Re: Report # 7.16-RockIt_CS-SS EcoFasten RockIt System, with Comp Slide or Smart Slide,
Certification for Gable and Hip roofs.

This letter certifies the loading criteria and design basis used for the structural analysis of the EcoFasten - RockIt System as shown in Report # 7.16-RockIt_CS-SS "Engineering Certification for the EcoFasten - RockIt System with Comp or Smart Slide for Gable and Hip Roofs". All information, data, and analysis therein are based on, and comply with, the following building codes and typical specifications. The Span Tables provided in the referenced report may be used when all assumptions listed therein are met.

Building Codes:

1. ASCE/SEI 7-16, Minimum Design Loads for Buildings and Other Structures, by American Society of Civil Engineers
2. 2021 International Building Code (IBC)
3. 2021 International Residential Code (IRC)
4. SEAOC (Structural Engineer Association of California) report PV2-2017 Wind Design for Solar Arrays
5. AC428, Acceptance Criteria for Modular Framing Systems Used to Support Photovoltaic (PV) Panels, November 1, 2012 by ICC-ES
6. Aluminum Design Manual 2020, by The Aluminum Association, Inc.
7. ANSI/AWC NDS-2018, National Design Specification for Wood Construction, by the American Wood Council

Please note our evaluation only applies to EcoFasten products and excludes the structural adequacy of the chosen roof attachments, PV modules, or underlying roof supporting members. It shall be the responsibility of the installer or system designer to verify the structural capacity and adequacy of the referenced system components with respect to the applied or resultant loads of the chosen array configuration.

Sincerely,



Matthew S Kuzila, P.E.

Sealed 04.08.2024
Expires 12.31.2024