

# PHOTOVOLTAIC ROOF MOUNT SYSTEM

18 MODULES-ROOF MOUNTED - 7.110 kW DC, 6.000 kW AC

88 JUDICIARY CT, CAMERON, NC 28326



**TOP TIER SOLAR SOLUTIONS**

1530 CENTER PARK DR #2911,  
CHARLOTTE, NC 28217,  
UNITED STATES

REVISIONS		
DESCRIPTION	DATE	REV
INITIAL DESIGN	05/06/2024	

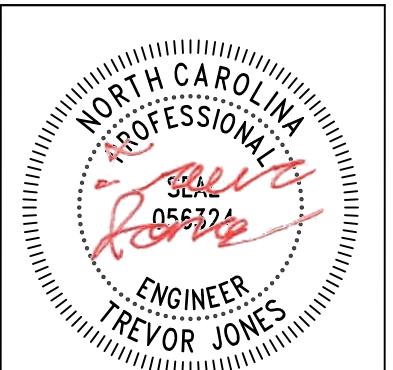

STRUCTURAL ONLY  
05/06/2024

PROJECT NAME & ADDRESS

**DANA GWYNN  
RESIDENCE**  
  
88 JUDICIARY CT,  
CAMERON, NC 28326

DRAWN BY  
**ESR**

SHEET NAME  
**COVER SHEET**

SHEET SIZE  
**ANSI B  
11" X 17"**

SHEET NUMBER  
**PV-1**

## PROJECT DATA

PROJECT ADDRESS: 88 JUDICIARY CT, CAMERON, NC 28326

OWNER: DANA GWYNN

DESIGNER: ESR

SCOPE: 7.110 kW DC ROOF MOUNT SOLAR PV SYSTEM WITH 18 JINKO SOLAR: JKM395M-72HBL-V 395W PV MODULES WITH 18 SOLAREEDGE: S440 POWER OPTIMIZERS AND 01 SOLAREEDGE: SE6000H-US (240V/6000W) INVERTER

AUTHORITIES HAVING JURISDICTION:  
BUILDING: HARNETT COUNTY  
ZONING: HARNETT COUNTY  
UTILITY: CENTRAL EMC

## SHEET INDEX

- PV-1 COVER SHEET
- PV-2 SITE PLAN
- PV-3 ROOF PLAN & MODULES
- PV-4 ELECTRICAL PLAN
- PV-5 STRUCTURAL DETAIL
- PV-6 ELECTRICAL LINE DIAGRAM
- PV-7 WIRING CALCULATIONS
- PV-8 LABELS
- PV-9+ EQUIPMENT SPECIFICATIONS

## SIGNATURE

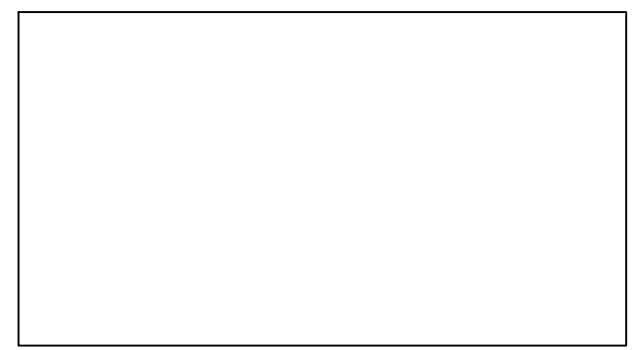

## GENERAL NOTES

1. ALL COMPONENTS ARE UL LISTED AND CEC CERTIFIED, WHERE WARRANTED.
2. THE SOLAR PV SYSTEM WILL BE INSTALLED IN ACCORDANCE WITH ARTICLE 690 OF THE NEC 2017.
3. THE UTILITY INTERCONNECTION APPLICATION MUST BE APPROVED AND PV SYSTEM INSPECTED PRIOR TO PARALLEL OPERATION.
4. ALL CONDUCTORS OF A CIRCUIT, INCLUDING THE EGC, MUST BE INSTALLED IN THE SAME RACEWAY, OR CABLE, OR OTHERWISE RUN WITH THE PV ARRAY CIRCUIT CONDUCTORS WHEN THEY LEAVE THE VICINITY OF THE PV ARRAY.
5. WHERE METALLIC CONDUIT CONTAINING DC CONDUCTORS IS USED INSIDE THE BUILDING, IT SHALL BE IDENTIFIED AS "CAUTION: SOLAR CIRCUIT" EVERY 10FT.
6. HEIGHT OF THE AC DISCONNECT SHALL NOT EXCEED 6'-7" PER NEC CODE 240.24.
7. A GROUNDING ELECTRODE SYSTEM IN ACCORDANCE WITH CEC 690.47 AND 250.50 THROUGH 60 AND 250-166 SHALL BE PROVIDED. PER NEC GROUNDING ELECTRODE SYSTEM OF EXISTING BUILDING MAY BE USED AND BONDED TO THE SERVICE ENTRANCE. IF EXISTING SYSTEM IS INACCESSIBLE OR INADEQUATE A SUPPLEMENTAL GROUNDING ELECTRODE WILL BE USED AT THE INVERTER LOCATION CONSISTING OF A UL LISTED 8 FT. GROUND ROD WITH ACORN CLAMP. GROUNDING ELECTRODE CONDUCTORS SHALL BE NO LESS THAN #8 AWG AND NO LARGER THAN #6 AWG COPPER AND BONDED TO THE EXISTING GROUNDING ELECTRODE TO PROVIDE FOR A COMPLETE SYSTEM.
8. PHOTOVOLTAIC MODULES ARE TO BE CONSIDERED NON-COMBUSTIBLE.
9. PHOTOVOLTAIC INSTALLATION WILL NOT OBSTRUCT ANY PLUMBING, MECHANICAL, OR BUILDING ROOF VENTS.
10. ALL WIRING MUST BE PROPERLY SUPPORTED BY DEVICES OR MECHANICAL MEANS DESIGNED AND LISTED FOR SUCH USE. WIRING MUST BE PERMANENTLY AND COMPLETELY HELD OFF THE ROOF SURFACE.
11. ALL SINAGE TO BE PLACED IN ACCORDANCE WITH THE LOCAL BUILDING CODE. IF EXPOSED TO SUNLIGHT, IT SHALL BE UV RESISTANT. ALL PLAQUES AND SINAGE WILL BE INSTALLED AS REQUIRED BY THE NEC AND AHJ.
12. INVERTER(S) USED IN UNGROUNDED SYSTEM SHALL BE UL 1741 LISTED.
13. THE INSTALLATION OF EQUIPMENT AND ALL ASSOCIATED WIRING AND INTERCONNECTION SHALL BE PERFORMED ONLY BY QUALIFIED PERSONS [NEC 690.4(C)]
14. ALL OUTDOOR EQUIPMENT SHALL BE NEMA 3R RATED (OR BETTER), INCLUDING ALL ROOF MOUNTED TRANSITION BOXES AND SWITCHES.
15. ALL EQUIPMENT SHALL BE PROPERLY GROUNDED AND BONDED IN ACCORDANCE WITH NEC ARTICLE 250.
16. SYSTEM GROUNDING SHALL BE IN ACCORDANCE WITH NEC 690.41.
17. PV SYSTEM CIRCUITS INSTALLED ON OR IN BUILDINGS SHALL INCLUDE A RAPID SHUTDOWN FUNCTION IN ACCORDANCE WITH NEC 690.12
18. DISCONNECTING MEANS SHALL BE LOCATED IN A VISIBLE, READILY ACCESSIBLE LOCATION WITHIN THE PV SYSTEM EQUIPMENT OR A MAXIMUM OF 10 FEET AWAY FROM THE SYSTEM [NEC 690.13(A)]
19. ALL WIRING METHODS SHALL BE IN ACCORDANCE WITH NEC 690.31
20. WORK CLEARANCES AROUND ELECTRICAL EQUIPMENT WILL BE MAINTAINED PER NEC 110.26(A)(1), 110.26(A)(2) AND 110.26(A)(3).
21. ROOFTOP MOUNTED PHOTOVOLTAIC PANELS AND MODULES SHALL BE TESTED, LISTED & IDENTIFIED IN ACCORDANCE WITH UL1703
22. ELECTRICAL CONTRACTOR TO PROVIDE CONDUIT EXPANSION JOINTS AND ANCHOR CONDUIT RUNS AS REQUIRED PER NEC.

## VICINITY MAP



## HOUSE PHOTO



## CODE REFERENCES

- 2018 NORTH CAROLINA BUILDING CODE
- 2018 NORTH CAROLINA RESIDENTIAL CODE
- 2018 NORTH CAROLINA FIRE CODE
- 2017 NATIONAL ELECTRICAL CODE

# PROJECT DESCRIPTION:

18 X JINKO SOLAR: JKM395M-72HBL-V 395W MONO MODULES  
 ROOF MOUNTED SOLAR PHOTOVOLTAIC MODULES  
 DC SYSTEM SIZE: 7.110 kW DC  
 AC SYSTEM SIZE: 6.000 kW AC

## EQUIPMENT SUMMARY

18 JINKO SOLAR: JKM395M-72HBL-V 395W MONO MODULES  
 18 SOLAREEDGE: S440 POWER OPTIMIZERS  
 01 SOLAREEDGE: SE6000H-US (240V/6000W) INVERTER

ROOF ARRAY AREA #1:- 389.88 SQ FT.

NOTE: VISIBLE, LOCKABLE, LABELED AC DISCONNECT  
 LOCATED WITHIN 10' OF UTILITY METER

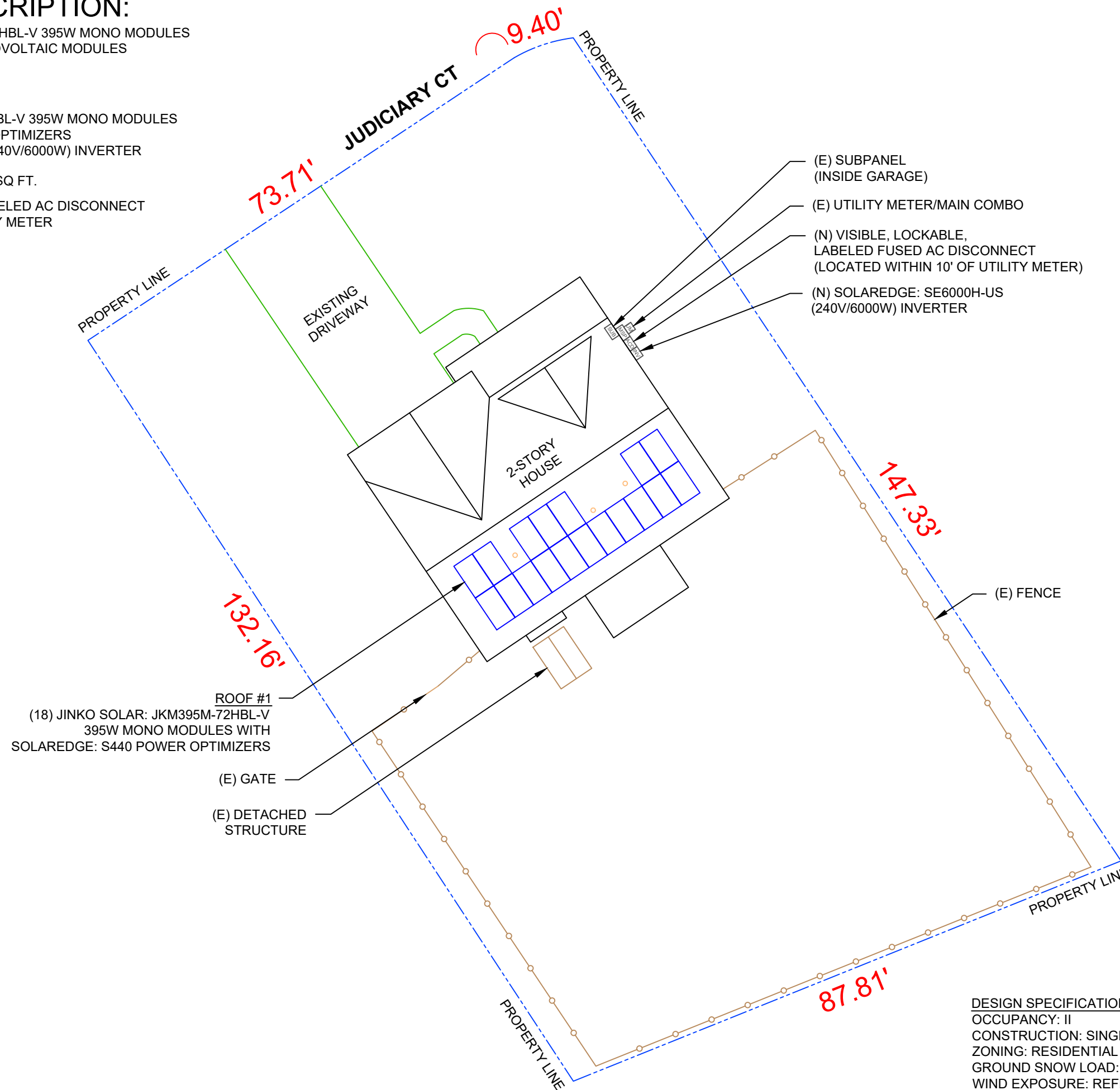
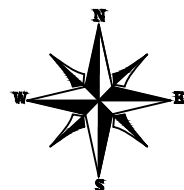

**DESIGN SPECIFICATION**  
 OCCUPANCY: II  
 CONSTRUCTION: SINGLE-FAMILY  
 ZONING: RESIDENTIAL  
 GROUND SNOW LOAD: REFER STRUCTURAL LETTER  
 WIND EXPOSURE: REFER STRUCTURAL LETTER  
 WIND SPEED: REFER STRUCTURAL LETTER



## TOP TIER SOLAR SOLUTIONS

1530 CENTER PARK DR #2911,  
 CHARLOTTE, NC 28217,  
 UNITED STATES

REVISIONS		
DESCRIPTION	DATE	REV
INITIAL DESIGN	05/06/2024	

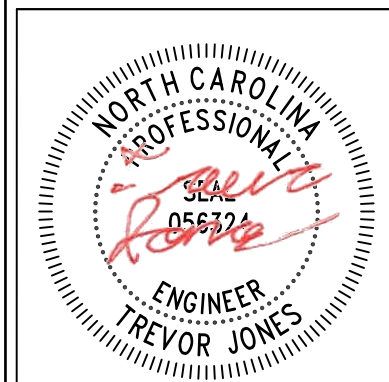

STRUCTURAL ONLY  
 05/06/2024

## PROJECT NAME & ADDRESS

**DANA GWYNN  
 RESIDENCE**  
 88 JUDICIARY CT,  
 CAMERON, NC 28326

## DRAWN BY

ESR

## SHEET NAME

SITE PLAN

## SHEET SIZE

ANSI B  
 11" X 17"

## SHEET NUMBER

PV-2

# 1 | SITE PLAN

PV-2 | SCALE: 1/16" = 1'-0"

**MODULE TYPE, DIMENSIONS & WEIGHT**

NUMBER OF MODULES = 18 MODULES  
 MODULE TYPE = JINKO SOLAR: JKM395M-72HBL-V 395W MONO MODULES  
 MODULE WEIGHT = 49.6 LBS / 22.5 kg.  
 MODULE DIMENSIONS = 79.06" x 39.45" = 21.66 SF

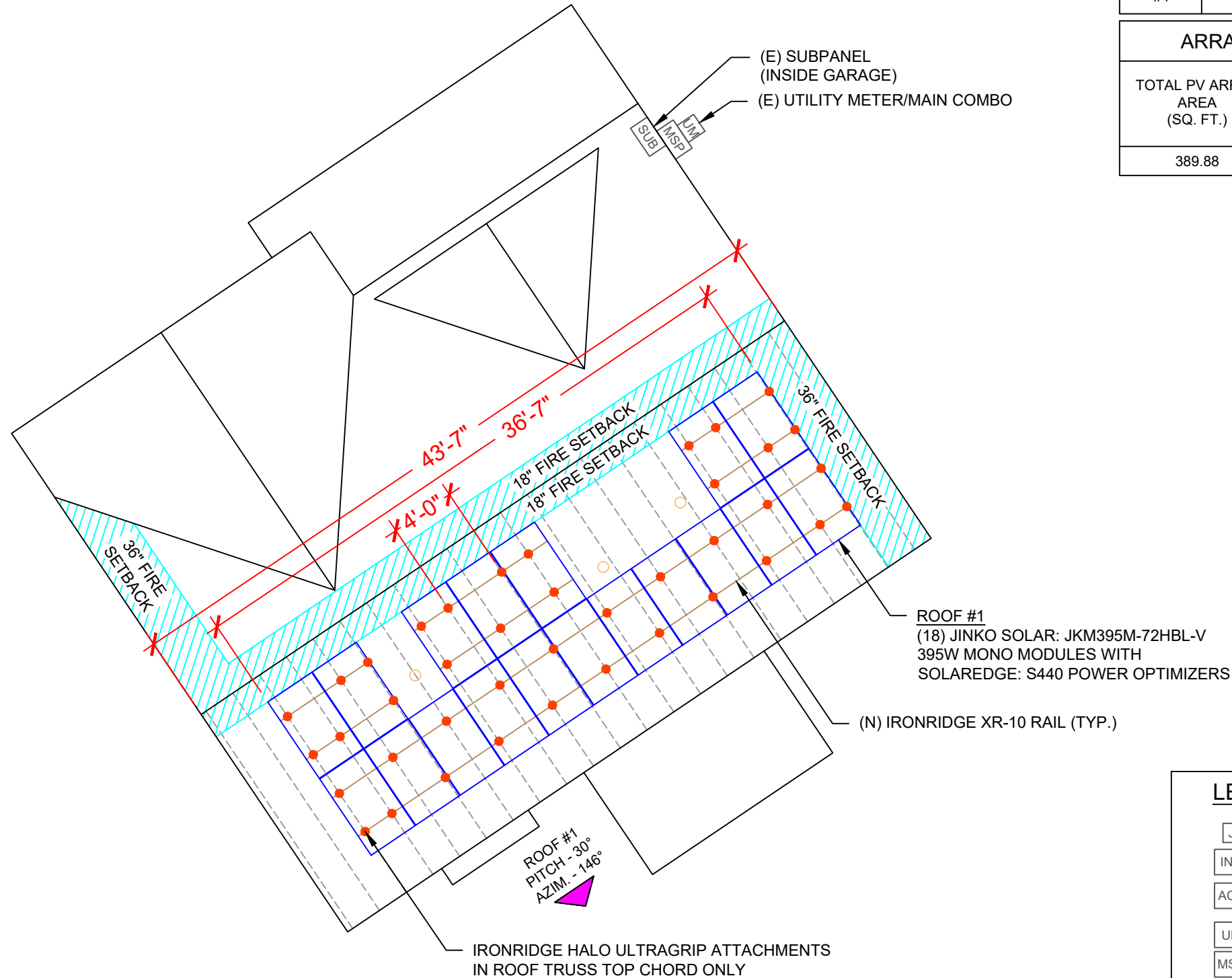
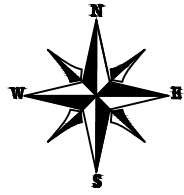

ROOF DESCRIPTION					
ROOF TYPE			ASPHALT SHINGLE		
ROOF LAYER			1 LAYER		
ROOF	# OF MODULES	ROOF PITCH	AZIMUTH	TRUSS SIZE	TRUSS SPACING
#1	18	30°	146°	2"X4"	24"

ARRAY AREA & ROOF AREA CALC'S		
TOTAL PV ARRAY AREA (SQ. FT.)	TOTAL ROOF AREA (Sq. Ft.)	ROOF AREA COVERED BY ARRAY (%)
389.88	1797.55	22



**TOP TIER SOLAR SOLUTIONS**  
 1530 CENTER PARK DR #2911,  
 CHARLOTTE, NC 28217,  
 UNITED STATES

REVISIONS		
DESCRIPTION	DATE	REV
INITIAL DESIGN	05/06/2024	

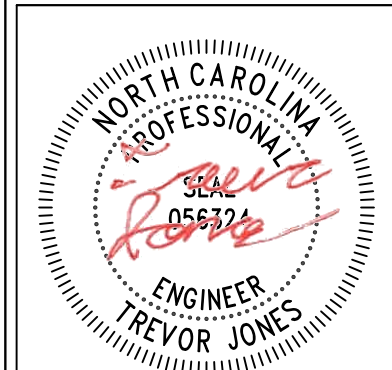

STRUCTURAL ONLY  
 05/06/2024

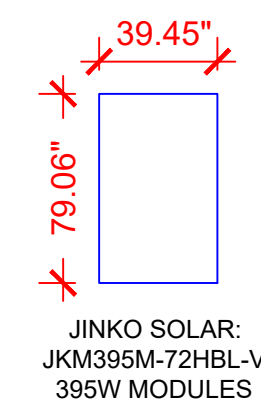

LEGEND	
[JB]	- JUNCTION BOX
[INV]	- INVERTER
[ACD]	- AC DISCONNECT
[UM]	- UTILITY METER
[MSP]	- MAIN SERVICE PANEL
[SUB]	- SUB PANEL
○	- VENT, ATTIC FAN (ROOF OBSTRUCTION)
●	- ROOF ATTACHMENT
---	- TRUSS
---	- CONDUIT

PROJECT NAME & ADDRESS

**DANA GWYNN RESIDENCE**  
 88 JUDICIARY CT,  
 CAMERON, NC 28326

DRAWN BY  
**ESR**

SHEET NAME  
**ROOF PLAN & MODULES**

SHEET SIZE  
**ANSI B  
 11" X 17"**

SHEET NUMBER  
**PV-3**

DC SYSTEM SIZE: 7.110 kW DC  
 AC SYSTEM SIZE: 6.000 kW AC  
 (18) JINKO SOLAR: JKM395M-72HBL-V 395W MONO MODULES  
 WITH (18) SOLAREEDGE: S440 POWER OPTIMIZERS  
 LOCATED UNDER EACH PANEL AND  
 01 SOLAREEDGE: SE6000H-US (240V/6000W) INVERTER

**STRING LEGENDS**  
 - - - - - STRING #1  
 - - - - - STRING #2

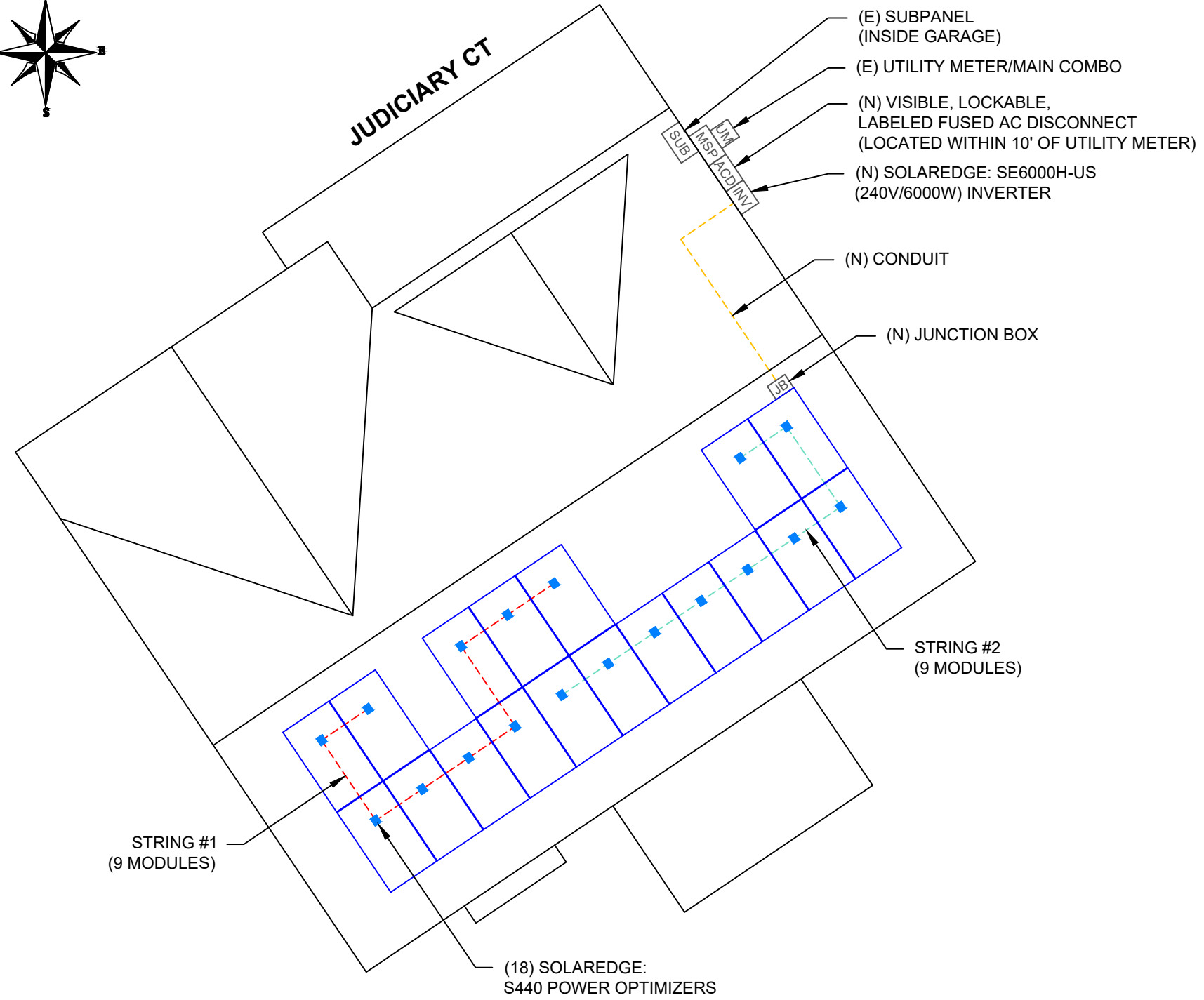
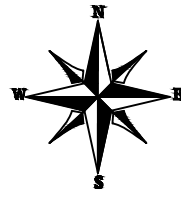

BILL OF MATERIALS	
EQUIPMENT DESCRIPTION	QTY
SOLAR PV MODULES: JINKO SOLAR: JKM395M-72HBL-V 395W MODULE	18
OPTIMIZERS: SOLAREEDGE: S440 POWER OPTIMIZERS	18
INVERTER: SOLAREEDGE: SE6000H-US (240V/6000W) INVERTER	01
JUNCTION BOX: JUNCTION BOX UL 1741, NEMA 3R CSA C22.2 NO.290	1
AC DISCONNECT: FUSED AC DISCONNECT, 60A FUSED, (2) 35A FUSES 240V NEMA 3R, UL LISTED	1
IRONRIDGE XR10 RAIL (RAIL 168" (14 FEET) CLEAR) (XR-10-168A)	12
BONDED SPLICE, XR10 (XR10-BOSS-01-M1)	4
UNIVERSAL MODULE CLAMP, CLEAR (UFO-CL-01-A1)	44
STOPPER SLEEVE, 40MM, MILL (UFO-STP-40MM-M1)	16
GROUNDING LUG (XR-LUG-03-A1)	4
IRONRIDGE HALO ULTRAGRIP ATTACHMENTS (QM-HUG-01-M1)	38
RD STRUCTURAL SCREW,3.0L (HW-RD1430-01-M1)	76
T-BOLT BONDING HARDWARE (BHW-TB-02-A1) (PRODUCT CODE 590-0116)	38
OPTIMIZER BONDING HARDWARE T-BOLT (BHW-MI-01-A1) (PRODUCT CODE 270-0152)	18

**TOP TIER**  
 SOLAR SOLUTIONS

**TOP TIER SOLAR SOLUTIONS**

1530 CENTER PARK DR #2911,  
 CHARLOTTE, NC 28217,  
 UNITED STATES

REVISIONS		
DESCRIPTION	DATE	REV
INITIAL DESIGN	05/06/2024	

PROJECT NAME & ADDRESS

**DANA GWYNN  
 RESIDENCE**

88 JUDICIARY CT,  
 CAMERON, NC 28326

**LEGEND**

- JB - JUNCTION BOX
- INV - INVERTER
- ACD - AC DISCONNECT
- UM - UTILITY METER
- MSP - MAIN SERVICE PANEL
- SUB - SUB PANEL
- VENT, ATTIC FAN (ROOF OBSTRUCTION)
- - ROOF ATTACHMENT
- - - - - TRUSS
- - - - - CONDUIT

DRAWN BY  
**ESR**

SHEET NAME  
**ELECTRICAL PLAN**

SHEET SIZE  
**ANSI B  
 11" X 17"**

SHEET NUMBER  
**PV-4**



**TOP TIER SOLAR SOLUTIONS**

1530 CENTER PARK DR #2911,  
CHARLOTTE, NC 28217,  
UNITED STATES

REVISIONS		
DESCRIPTION	DATE	REV
INITIAL DESIGN	05/06/2024	

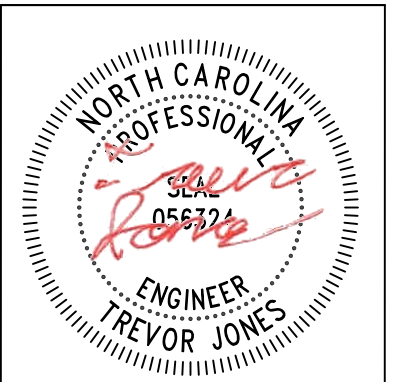

STRUCTURAL ONLY  
05/06/2024

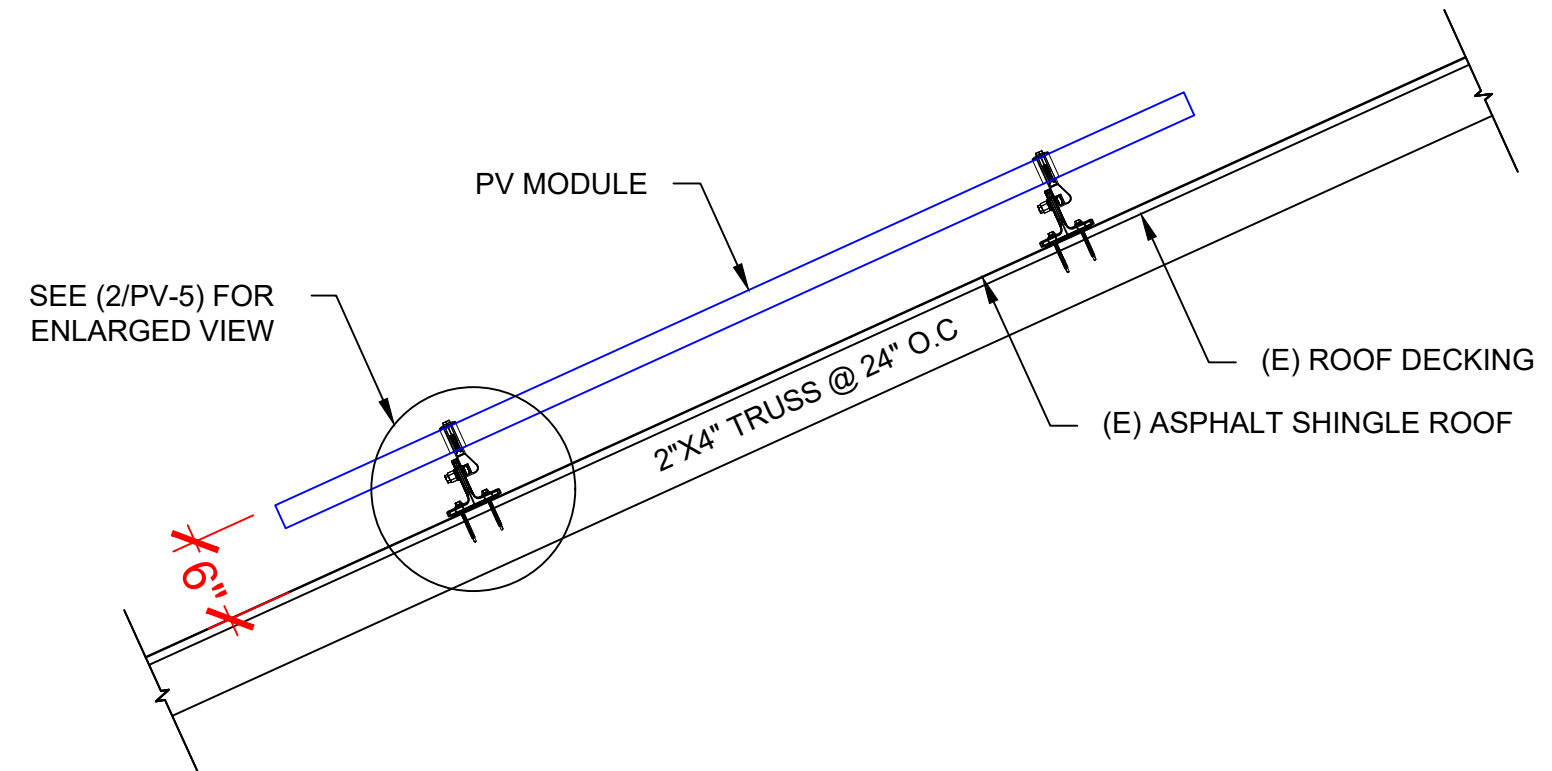

**1** | STRUCTURAL ATTACHMENT (Side view)  
PV-5 | SCALE: N.T.S

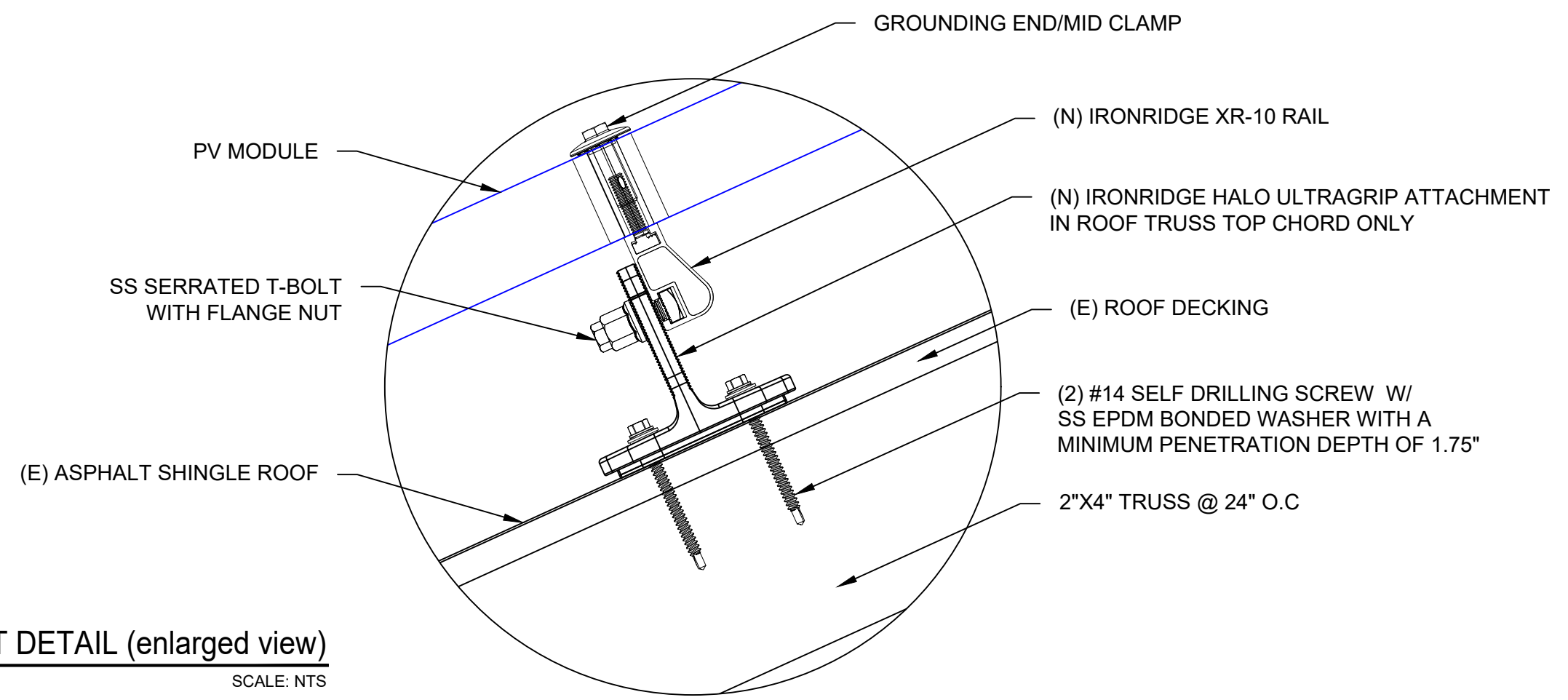

**2** | ATTACHMENT DETAIL (enlarged view)  
PV-5 | SCALE: NTS

PROJECT NAME & ADDRESS

DANA GWYNN  
RESIDENCE  
88 JUDICIARY CT,  
CAMERON, NC 28326

DRAWN BY  
ESR

SHEET NAME  
STRUCTURAL DETAIL

SHEET SIZE  
ANSI B  
11" X 17"

SHEET NUMBER  
PV-5

DC SYSTEM SIZE: 7.110 kW DC  
AC SYSTEM SIZE: 6.000 kW AC

(18) JINKO SOLAR: JKM395M-72HBL-V 395W MONO MODULES WITH (18) SOLAREEDGE: S440 POWER OPTIMIZERS LOCATED UNDER EACH PANEL (240V) AND (01) SOLAREEDGE: SE6000H-US (240V/6000W) INVERTER (02) STRINGS OF 9 MODULES ARE CONNECTED IN SERIES

**INTERCONNECTION NOTES:**

1. INTERCONNECTION SIZING, LIMITATIONS AND COMPLIANCE DETERMINED IN ACCORDANCE WITH [NEC 705.12], AND [NEC 690.59].
2. GROUND FAULT PROTECTION IN ACCORDANCE WITH [NEC 215.9], [NEC 230.95].
3. ALL EQUIPMENT TO BE RATED FOR BACKFEEDING.
4. PV BREAKER TO BE POSITIONED AT THE OPPOSITE END OF THE BUSBAR RELATIVE TO THE MAIN BREAKER.

**DISCONNECT NOTES:**

1. DISCONNECTING SWITCHES SHALL BE WIRED SUCH THAT WHEN THE SWITCH IS OPENED THE CONDUCTORS REMAINING LIVE ARE CONNECTED TO THE TERMINALS MARKED "LINE SIDE" (TYPICALLY THE UPPER TERMINALS)
2. AC DISCONNECT MUST BE ACCESSIBLE TO QUALIFIED UTILITY PERSONNEL, BE LOCKABLE, AND BE A VISIBLE-BREAK SWITCH
3. DISCONNECT MEANS AND THEIR LOCATION SHALL BE IN ACCORDANCE WITH [NEC 225.31] AND [NEC 225.32].

**GROUNDING & GENERAL NOTES:**

1. PV GROUNDING ELECTRODE SYSTEM NEEDS TO BE INSTALLED IN ACCORDANCE WITH [NEC 690.43]
2. PV INVERTER IS UNGROUNDED, TRANSFORMER-LESS TYPE.
3. DC GEC AND AC EGC TO REMAIN UNSPLICED, OR SPLICED TO EXISTING ELECTRODE
4. ANY EXISTING WIRING INVOLVED WITH PV SYSTEM CONNECTION THAT IS FOUND TO BE INADEQUATE PER CODE SHALL BE CORRECTED PRIOR TO FINAL INSPECTION.
5. JUNCTION BOX QUANTITIES, AND PLACEMENT SUBJECT TO CHANGE IN THE FIELD - JUNCTION BOX DEPICTED ON ELECTRICAL DIAGRAM REPRESENT WIRE TYPE TRANSITIONS.
6. AC DISCONNECT NOTED IN EQUIPMENT SCHEDULE OPTIONAL IF OTHER AC DISCONNECTING MEANS IS LOCATED WITHIN 10' OF SERVICE DISCONNECT.
7. RACEWAYS AND CABLES EXPOSED TO SUNLIGHT ON ROOFTOPS SHOULD BE INSTALLED MORE THAN 7/8" ABOVE THE ROOF USING CONDUIT SUPPORTS.

**RACKING NOTE:**

1. BOND EVERY OTHER RAIL WITH #6 BARE COPPER

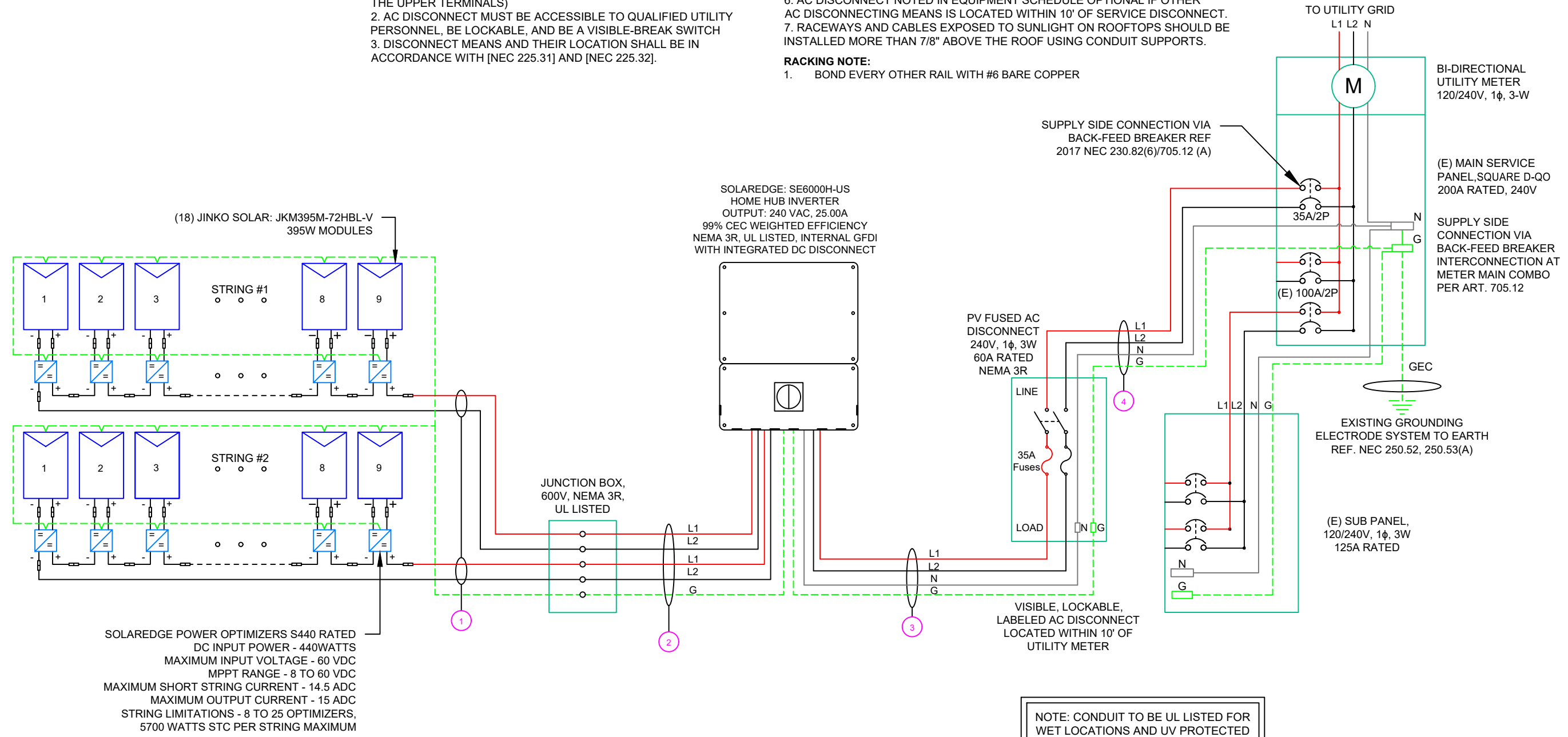

SOLAREEDGE POWER OPTIMIZERS S440 RATED  
DC INPUT POWER - 440WATTS  
MAXIMUM INPUT VOLTAGE - 60 VDC  
MPPT RANGE - 8 TO 60 VDC  
MAXIMUM SHORT STRING CURRENT - 14.5 ADC  
MAXIMUM OUTPUT CURRENT - 15 ADC  
STRING LIMITATIONS - 8 TO 25 OPTIMIZERS,  
5700 WATTS STC PER STRING MAXIMUM

SOLAREEDGE: SE6000H-US  
HOME HUB INVERTER  
OUTPUT: 240 VAC, 25.00A  
99% CEC WEIGHTED EFFICIENCY  
NEMA 3R, UL LISTED, INTERNAL GFDI  
WITH INTEGRATED DC DISCONNECT

NOTE: CONDUIT TO BE UL LISTED FOR WET LOCATIONS AND UV PROTECTED

QTY	CONDUCTOR INFORMATION	CONDUIT TYPE	CONDUIT SIZE
1 (4)	#10AWG - PV WIRE/USE-2	N/A	N/A
1 (1)	#6AWG - BARE COPPER IN FREE AIR		
2 (4)	#10AWG - CU, THWN-2	EMT OR LFMC IN ATTIC	3/4"
2 (1)	#10AWG - CU, THWN-2 GND		
3 (2)	#8AWG - CU, THWN-2		
3 (1)	#8AWG - CU, THWN-2 N	EMT, LFMC OR PVC	3/4"
3 (1)	#10AWG - CU, THWN-2 GND		
4 (2)	#8AWG - CU, THWN-2		
4 (1)	#8AWG - CU, THWN-2 N	EMT, LFMC OR PVC	3/4"
4 (1)	#10AWG - CU, THWN-2 GND		



**TOP TIER SOLAR SOLUTIONS**

1530 CENTER PARK DR #2911,  
CHARLOTTE, NC 28217,  
UNITED STATES

REVISIONS		
DESCRIPTION	DATE	REV
INITIAL DESIGN	05/06/2024	

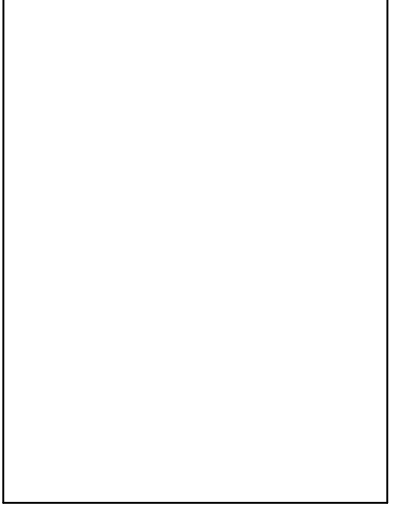

**PROJECT NAME & ADDRESS**

**DANA GWYNN  
RESIDENCE**  
  
88 JUDICIARY CT,  
CAMERON, NC 28326

DRAWN BY  
**ESR**

SHEET NAME  
**ELECTRICAL LINE DIAGRAM**

SHEET SIZE  
**ANSI B  
11" X 17"**

SHEET NUMBER  
**PV-6**

SOLAR MODULE SPECIFICATIONS	
MANUFACTURER / MODEL #	JINKO SOLAR: JKM395M-72HBL-V 395W MODULE
VMP	39.90V
IMP	9.90A
VOC	48.80V
ISC	10.54A
TEMP. COEFF. VOC	-0.29%/°C
MODULE DIMENSION	79.06"L x 39.45"W x 1.57"D (In Inch)

INVERTER SPECIFICATIONS	
MANUFACTURER / MODEL #	SOLAREEDGE: SE6000H-US (240V/6000W) INVERTER
NOMINAL AC POWER	6.000 kW
NOMINAL OUTPUT VOLTAGE	240 VAC
NOMINAL OUTPUT CURRENT	25.00A

AMBIENT TEMPERATURE SPECS	
AMBIENT TEMP (HIGH TEMP 2%)	38°
RECORD LOW TEMPERATURE	-11°
MODULE TEMPERATURE COEFFICIENT OF Voc	-0.29%/°C

PERCENT OF VALUES	NUMBER OF CURRENT CARRYING CONDUCTORS IN EMT
.80	4-6
.70	7-9
.50	10-20

DC FEEDER CALCULATIONS																					
CIRCUIT ORIGIN	CIRCUIT DESTINATION	VOLTAGE (V)	FULL LOAD AMPS "FLA" (A)	FLA*1.25 (A)	OCPD SIZE (A)	GROUND SIZE	CONDUCTOR SIZE	75°C AMPACITY (A)	AMPACITY CHECK #1	AMBIENT TEMP. (°C)	TOTAL CC CONDUCTORS IN RACEWAY	90°C AMPACITY (A)	DERATION FACTOR FOR AMBIENT TEMPERATURE NEC 310.15(B)(2)(a)	DERATION FACTOR FOR CONDUCTORS PER RACEWAY NEC 310.15(B)(3)(a)	90°C AMPACITY DERATED (A)	AMPACITY CHECK #2	FEEDER LENGTH (FEET)	CONDUCTOR RESISTANCE (OHM/KFT)	VOLTAGE DROP AT FLA (%)	CONDUIT SIZE	CONDUIT FILL (%)
STRING 1	JUNCTION BOX	380	15.00	18.75	20	BARE COPPER #6 AWG	CU #10 AWG	35	PASS	38	2	40	0.91	1	36.4	PASS	5	1.24	0.049	N/A	#N/A
STRING 2	JUNCTION BOX	380	15.00	18.75	20	BARE COPPER #6 AWG	CU #10 AWG	35	PASS	38	2	40	0.91	1	36.4	PASS	5	1.24	0.049	N/A	#N/A
JUNCTION BOX	INVERTER	380	15.00	18.75	20	CU #10 AWG	CU #10 AWG	35	PASS	38	4	40	0.91	0.8	29.12	PASS	35	1.24	0.343	3/4" EMT	19.79362

String 1 Voltage Drop	0.392
String 2 Voltage Drop	0.392

AC FEEDER CALCULATIONS																						
CIRCUIT ORIGIN	CIRCUIT DESTINATION	VOLTAGE (V)	FULL LOAD AMPS "FLA" (A)	FLA*1.25 (A)	OCPD SIZE (A)	NEUTRAL SIZE	GROUND SIZE	CONDUCTOR SIZE	75°C AMPACITY (A)	AMPACITY CHECK #1	AMBIENT TEMP. (°C)	TOTAL CC CONDUCTORS IN RACEWAY	90°C AMPACITY (A)	DERATION FACTOR FOR AMBIENT TEMPERATURE NEC 310.15(B)(2)(a)	DERATION FACTOR FOR CONDUCTORS PER RACEWAY NEC 310.15(B)(3)(a)	90°C AMPACITY DERATED (A)	AMPACITY CHECK #2	FEEDER LENGTH (FEET)	CONDUCTOR RESISTANCE (OHM/KFT)	VOLTAGE DROP AT FLA (%)	CONDUIT SIZE	CONDUIT FILL (%)
INVERTER	AC DISCONNECT	240	25	31.25	35	CU #8 AWG	CU #10 AWG	CU #8 AWG	50	PASS	38	2	55	0.91	1	50.05	PASS	5	0.778	0.081	3/4" EMT	24.5591
AC DISCONNECT	POI	240	25	31.25	35	CU #8 AWG	CU #10 AWG	CU #8 AWG	50	PASS	38	2	55	0.91	1	50.05	PASS	5	0.778	0.081	3/4" EMT	24.5591

CUMULATIVE VOLTAGE DROP	0.162
-------------------------	-------



TOP TIER SOLAR SOLUTIONS

1530 CENTER PARK DR #2911,  
CHARLOTTE, NC 28217,  
UNITED STATES

REVISIONS		
DESCRIPTION	DATE	REV
INITIAL DESIGN	05/06/2024	

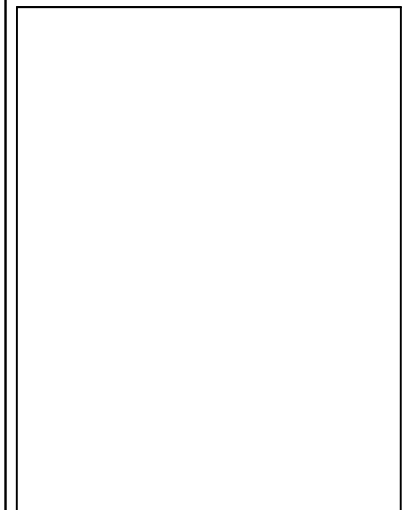

PROJECT NAME & ADDRESS

DANA GWYNN  
RESIDENCE  
88 JUDICIARY CT,  
CAMERON, NC 28326

DRAWN BY  
ESR

SHEET NAME  
WIRING CALCULATIONS

SHEET SIZE  
ANSI B  
11" X 17"

SHEET NUMBER  
PV-7

**ELECTRICAL NOTES**

- ALL EQUIPMENT TO BE LISTED BY UL OR OTHER NRTL, AND LABELED FOR ITS APPLICATION.
- ALL CONDUCTORS SHALL BE COPPER, RATED FOR 600 V AND 90 DEGREE C WET ENVIRONMENT.
- WIRING, CONDUIT, AND RACEWAYS MOUNTED ON ROOFTOPS SHALL BE ROUTED DIRECTLY TO, AND LOCATED AS CLOSE AS POSSIBLE TO THE NEAREST RIDGE, HIP, OR VALLEY.
- WORKING CLEARANCES AROUND ALL NEW AND EXISTING ELECTRICAL EQUIPMENT SHALL COMPLY WITH NEC 110.26.
- DRAWINGS INDICATE THE GENERAL ARRANGEMENT OF SYSTEMS. CONTRACTOR SHALL FURNISH ALL NECESSARY OUTLETS, SUPPORTS, FITTINGS AND ACCESSORIES TO FULFILL APPLICABLE CODES AND STANDARDS.
- WHERE SIZES OF JUNCTION BOX, RACEWAYS, AND CONDUITS ARE NOT SPECIFIED, THE CONTRACTOR SHALL SIZE THEM ACCORDINGLY.
- ALL WIRE TERMINATIONS SHALL BE APPROPRIATELY LABELED AND READILY VISIBLE.
- MODULE GROUNDING CLIPS TO BE INSTALLED BETWEEN MODULE FRAME AND MODULE SUPPORT RAIL, PER THE GROUNDING CLIP MANUFACTURER'S INSTRUCTION.
- MODULE SUPPORT RAIL TO BE BONDED TO CONTINUOUS COPPER G.E.C. VIA WEEB LUG OR ILSKO GBL-4DBT LAY-IN LUG.
- TEMPERATURE RATINGS OF ALL CONDUCTORS, TERMINATIONS, BREAKERS, OR OTHER DEVICES ASSOCIATED WITH THE SOLAR PV SYSTEM SHALL BE RATED FOR AT LEAST 75 DEGREE C.

## PHOTOVOLTAIC POWER SOURCE

EVERY 10' ON CONDUIT & ENCLOSURES

LABEL- 1:  
LABEL LOCATION:  
EMT/CONDUIT RACEWAY  
SOLADECK / JUNCTION BOX  
CODE REF: NEC 690.31 (D)(2)

## WARNING

### ELECTRIC SHOCK HAZARD

TERMINALS ON THE LINE AND LOAD SIDES MAY  
BE ENERGIZED IN THE OPEN POSITION

LABEL- 2:  
LABEL LOCATION:  
AC DISCONNECT  
CODE REF: NEC 690.13(B)

## WARNING

### DUAL POWER SUPPLY

SOURCE: UTILITY GRID AND  
PV SOLAR ELECTRIC SYSTEM

LABEL- 3:  
LABEL LOCATION:  
MAIN SERVICE PANEL  
CODE REF: NEC 705.12(C) & NEC 690.59

## SOLAR PV BREAKER:

BREAKER IS BACKFED  
DO NOT RELOCATE

LABEL-4:  
LABEL LOCATION:  
MAIN SERVICE PANEL  
CODE REF: NEC 705.12(C) & NEC 690.59

## WARNING

POWER SOURCE OUTPUT  
CONNECTION. DO NOT  
RELOCATE THIS  
OVERCURRENT DEVICE

LABEL- 5:  
LABEL LOCATION:  
MAIN SERVICE PANEL (ONLY IF SOLAR IS BACK-FED)  
SUBPANEL (ONLY IF SOLAR IS BACK-FED)  
CODE REF: NEC 705.12(B)(3)(2)

## SOLAR PV SYSTEM EQUIPPED WITH RAPID SHUTDOWN

TURN RAPID SHUTDOWN  
SWITCH TO THE  
"OFF" POSITION TO  
SHUT DOWN PV SYSTEM  
AND REDUCE  
SHOCK HAZARD  
IN THE ARRAY

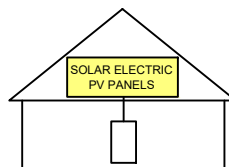

LABEL- 6:  
LABEL LOCATION:  
AC DISCONNECT  
CODE REF: [NEC 690.56(C)(1)(A)]

## RAPID SHUTDOWN SWITCH FOR SOLAR PV SYSTEM

LABEL- 7:  
LABEL LOCATION:  
AC DISCONNECT  
MAIN SERVICE PANEL (ONLY IF SOLAR IS BACK-FED)  
CODE REF: NEC 690.56(C)(2)

## DC DISCONNECT

LABEL- 8:  
LABEL LOCATION:  
INVERTER  
CODE REF: NEC 690.13(B)

## AC DISCONNECT PHOTOVOLTAIC SYSTEM POWER SOURCE

NOMINAL OPERATING AC VOLATGE **240 V**  
RATED AC OUTPUT CURRENT **25.00 A**

LABEL- 9:  
LABEL LOCATION:  
AC DISCONNECT  
CODE REF: NEC 690.54

MAXIMUM VOLTAGE **480 V**  
MAXIMUM CIRCUIT CURRENT **16.50 A**  
MAXIMUM RATED OUTPUT  
CURRENT OF THE CHARGE  
CONTROLLER OR DC-TO-DC  
CONVERTER (IF INSTALLED)

LABEL- 10:  
LABEL LOCATION:  
ON THE RIGHT SIDE OF THE INVERTER (PRE-EXISTING ON THE INVERTER)  
CODE REF: NEC 690.53

# TOP TIER

SOLAR SOLUTIONS

## TOP TIER SOLAR SOLUTIONS

1530 CENTER PARK DR #2911,  
CHARLOTTE, NC 28217,  
UNITED STATES

### REVISIONS

DESCRIPTION	DATE	REV
INITIAL DESIGN	05/06/2024	

### PROJECT NAME & ADDRESS

DANA GWYNN  
RESIDENCE  
88 JUDICIARY CT,  
CAMERON, NC 28326

### DRAWN BY

ESR

### SHEET NAME

LABELS

### SHEET SIZE

ANSI B  
11" X 17"

### SHEET NUMBER

PV-8



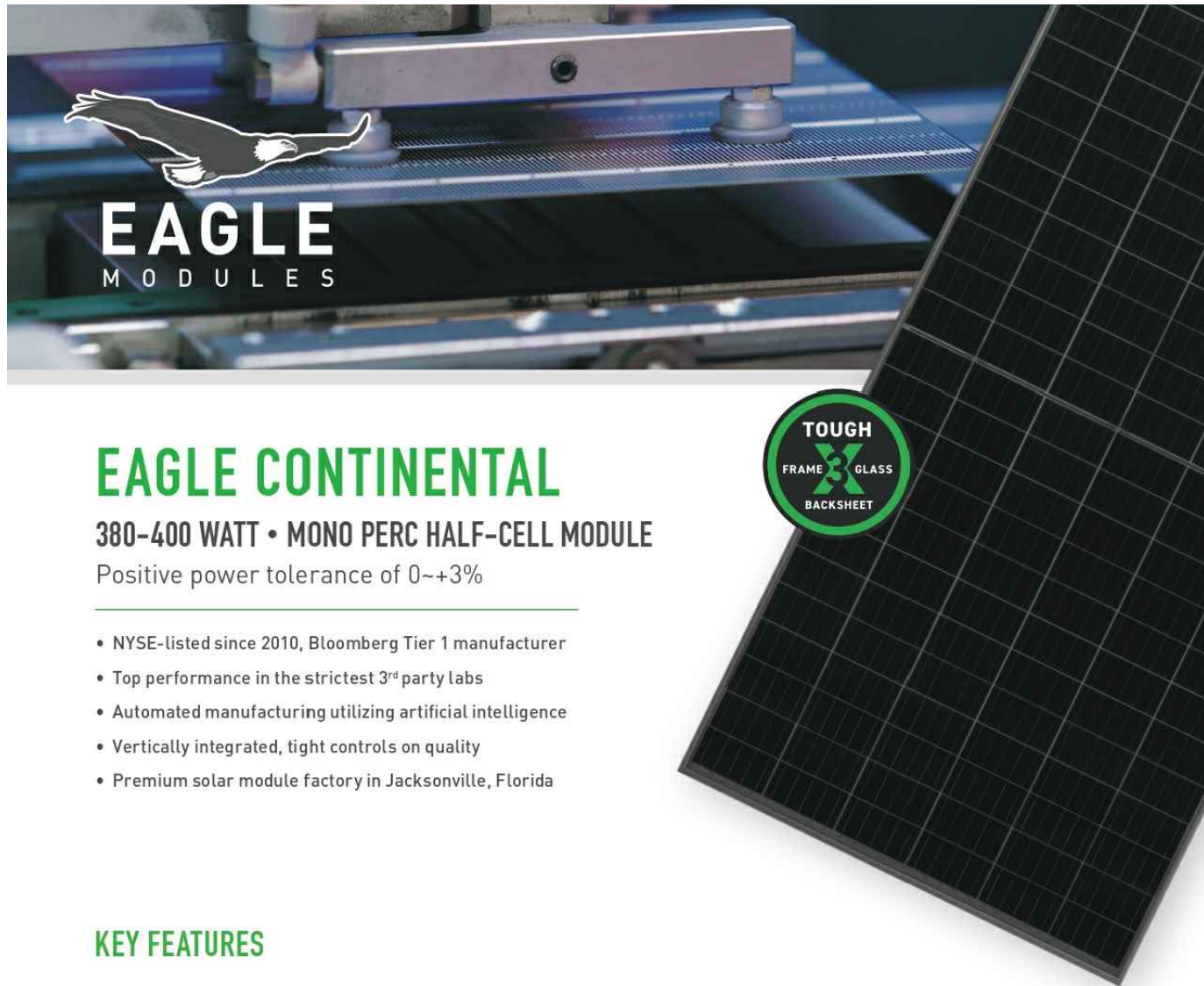

# EAGLE CONTINENTAL

380-400 WATT • MONO PERC HALF-CELL MODULE

Positive power tolerance of 0~+3%

- NYSE-listed since 2010, Bloomberg Tier 1 manufacturer
- Top performance in the strictest 3<sup>rd</sup> party labs
- Automated manufacturing utilizing artificial intelligence
- Vertically integrated, tight controls on quality
- Premium solar module factory in Jacksonville, Florida

## KEY FEATURES

- Superior Aesthetics**  
Black backsheet and black frame create ideal look for residential applications.
- Diamond Half-Cell Technology**  
World-record breaking efficient mono PERC half-cells deliver high power in a small footprint.
- Thick and Tough**  
Fire Type 1 rated module engineered with a thick frame, 3.2mm front side glass, and thick backsheet for added durability.
- Shade Tolerant**  
Twin array design allows continued performance even with shading by trees or debris.
- Protected Against All Environments**  
Certified to withstand humidity, heat, rain, marine environments, wind, hailstorms, and packed snow.
- Warranty**  
25-year product and 25-year linear power warranty.

ASSEMBLED IN THE  
**USA**  
From foreign components

- ISO9001:2008 Quality Standards
- ISO14001:2004 Environmental Standards
- IEC61215, IEC61730 certified
- ISO 45001 2018 Occupational Health & Safety Standards
- UL1703/61730 certified

BUILDING YOUR TRUST IN SOLAR. [WWW.JINKOSOLAR.US](http://WWW.JINKOSOLAR.US)



## ENGINEERING DRAWINGS

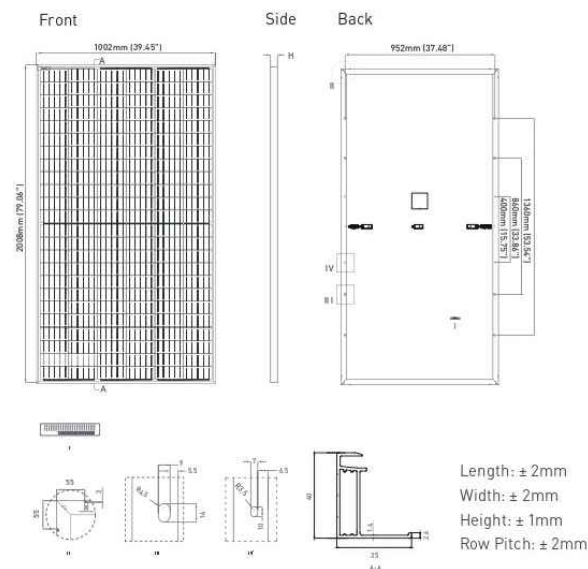

## ELECTRICAL PERFORMANCE & TEMPERATURE DEPENDENCE

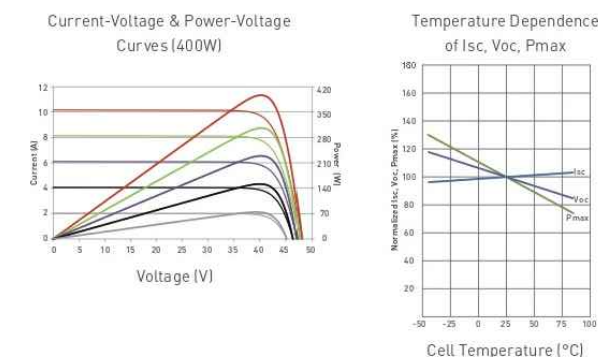

## ELECTRICAL CHARACTERISTICS

Module Type	JKM380M-72HBL-V		JKM385M-72HBL-V		JKM390M-72HBL-V		JKM395M-72HBL-V		JKM400M-72HBL-V	
	STC	NOCT	STC	NOCT	SCT	NOCT	STC	NOCT	STC	NOCT
Maximum Power (Pmax)	380Wp	280Wp	385Wp	283Wp	390Wp	287Wp	395Wp	291Wp	400Wp	294Wp
Maximum Power Voltage (Vmp)	39.10V	36.5V	39.37V	36.8V	39.64V	37.0V	39.90V	37.4V	40.16V	37.6V
Maximum Power Current (Imp)	9.72A	7.67A	9.78A	7.71A	9.84A	7.75A	9.90A	7.77A	9.96A	7.82A
Open-circuit Voltage (Voc)	48.2V	45.4V	48.4V	45.6V	48.6V	45.8V	48.8V	46.0V	49.1V	46.2V
Short-circuit Current (Isc)	10.30A	8.32A	10.38A	8.38A	10.46A	8.45A	10.54A	8.51A	10.61A	8.57A
Module Efficiency STC (%)	18.89%		19.13%		19.38%		19.63%		19.88%	

\*STC: ☀ Irradiance 1000W/m<sup>2</sup>    🌡 Cell Temperature 25°C  
 NOCT: ☀ Irradiance 800W/m<sup>2</sup>    🌡 Ambient Temperature 20°C

☁ AM = 1.5    🌪 Wind Speed 1m/s

\*Power measurement tolerance: ±3%

The company reserves the final right for explanation on any of the information presented hereby. JKM380-400M-72HBL-V-F1-US

BUILDING YOUR TRUST IN SOLAR. [WWW.JINKOSOLAR.US](http://WWW.JINKOSOLAR.US)



## MECHANICAL CHARACTERISTICS

Cells	Mono PERC Diamond Cell (158.75 x 158.75mm)
No. of Half Cells	144 (6 x 24)
Dimensions	2008 x 1002 x 40mm (79.06 x 39.45 x 1.57in)
Weight	22.5kg (49.6lbs)
Front Glass	3.2mm, Anti-Reflection Coating High Transmission, Low Iron, Tempered Glass
Frame	Anodized Aluminum Alloy
Junction Box	IP68 Rated
Output Cables	12 AWG, 1400mm (55.12in)
Connector	Staubli MC4 Series
Fire Type	Type 1
Pressure Rating	5400Pa (Snow) & 2400Pa (Wind)
Hailstone Test	50mm Hailstones at 35m/s

## TEMPERATURE CHARACTERISTICS

Temperature Coefficients of Pmax	-0.35%/°C
Temperature Coefficients of Voc	-0.29%/°C
Temperature Coefficients of Isc	0.048%/°C
Nominal Operating Cell Temperature (NOCT)	45±2°C

## MAXIMUM RATINGS

Operating Temperature (°C)	-40°C~+85°C
Maximum System Voltage	1500VDC (UL and IEC)
Maximum Series Fuse Rating	20A

## PACKAGING CONFIGURATION

(Two pallets = One stack)  
 27pcs/pallet, 54 pcs/stack, 594pcs/40'HQ Container

## WARRANTY

25-year product and 25-year linear power warranty  
 1<sup>st</sup> year degradation not to exceed 2.5%, each subsequent year not to exceed 0.6%, minimum power at year 25 is 83.1% or greater.

**TOP TIER**  
SOLAR SOLUTIONS

TOP TIER SOLAR SOLUTIONS

1530 CENTER PARK DR #2911,  
CHARLOTTE, NC 28217,  
UNITED STATES

REVISIONS		
DESCRIPTION	DATE	REV
INITIAL DESIGN	05/06/2024	

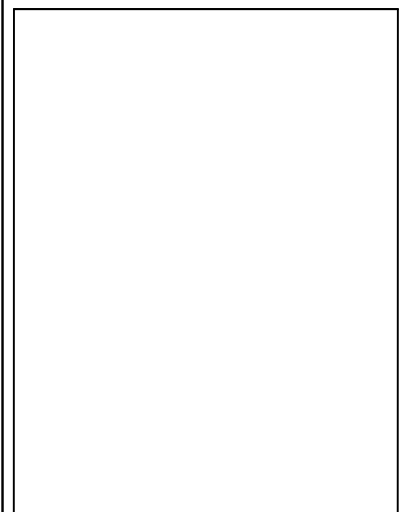

PROJECT NAME & ADDRESS

DANA GWYNN  
RESIDENCE

88 JUDICIARY CT,  
CAMERON, NC 28326

DRAWN BY  
ESR

SHEET NAME  
EQUIPMENT  
SPECIFICATION

SHEET SIZE  
ANSI B  
11" X 17"

SHEET NUMBER  
PV-9

# CERTIFICATE OF COMPLIANCE

**Certificate Number** E362479  
**Report Reference** E362479-20200410  
**Date** 2023-July-16

**Issued to:** JINKO SOLAR CO LTD  
 No.1, Yingbin Road, Economic Development Zone  
 Shangrao Jiangxi Sheng 334100 CN

**This is to certify that representative samples of** PHOTOVOLTAIC MODULES AND PANELS WITH SYSTEM VOLTAGE RATINGS OVER 600 VOLTS  
 See Addendum Page for Product Designation(s).  
 Have been evaluated by UL in accordance with the Standard(s) indicated on this Certificate.

**Standard(s) for Safety:** UL 61730-1 - Standard for Photovoltaic (PV) Module Safety Qualification - Part 1: Requirements for Construction, Edition 2, Issue Date 10/28/2022 and UL 61730-2, Photovoltaic (PV) Module Safety Qualification - Part 2: Requirements for Testing, Edition 2, Revision Date 04/25/2023 and CSA C22.2 No. 61730-1:19 December 2019, Photovoltaic (PV) module safety qualification — Part 1: Requirements for construction and CSA C22.2 No. 61730-2:19 December 2019, Photovoltaic (PV) module safety qualification — Part 2: Requirements for testing.

**Additional Information:** See the UL Online Certifications Directory at <https://iq.ulprospector.com> for additional information

This Certificate of Compliance indicates that representative samples of the product described in the certification report have met the requirements for UL certification. It does not provide authorization to apply the UL Mark. Only the Authorization Page that references the Follow-Up Services Procedure for ongoing surveillance provides authorization to apply the UL Mark.

Only those products bearing the UL Mark should be considered as being UL Certified and covered under UL's Follow-Up Services.

Look for the UL Certification Mark on the product.

*Deborah Jennings-Conner*  
 Deborah Jennings-Conner, VP Regulatory Services  
 UL LLC



Any information and documentation involving UL Mark services are provided on behalf of UL LLC (UL) or any authorized licensee of UL. For questions, please contact a local UL Customer Service Representative at <http://ul.com/about/locations/>

# CERTIFICATE OF COMPLIANCE

**Certificate Number** E362479  
**Report Reference** E362479-20200410  
**Date** 2023-July-16

JKM525N-72HL4-V, JKM530N-72HL4-V, JKM535N-72HL4-V, JKM540N-72HL4-V, JKM545N-72HL4-V, JKM550N-72HL4-V, JKM555N-72HL4-V, JKM560N-72HL4-V, JKM565N-72HL4-V, JKM570N-72HL4-V, JKM575N-72HL4-V.

JKM480N-66HL4-V, JKM485N-66HL4-V, JKM490N-66HL4-V, JKM495N-66HL4-V, JKM500N-66HL4-V, JKM505N-66HL4-V, JKM510N-66HL4-V, JKM515N-66HL4-V, JKM520N-66HL4-V, JKM525N-66HL4-V

JKM435N-60HL4-V, JKM440N-60HL4-V, JKM445N-60HL4-V, JKM450N-60HL4-V, JKM455N-60HL4-V, JKM460N-60HL4-V, JKM465N-60HL4-V, JKM470N-60HL4-V, JKM475N-60HL4-V, JKM480N-60HL4-V.

JKM395N-54HL4-V, JKM400N-54HL4-V, JKM405N-54HL4-V, JKM410N-54HL4-V, JKM415N-54HL4-V, JKM420N-54HL4-V, JKM425N-54HL4-V, JKM430N-54HL4-V.

JKM565M-78HL4-V, JKM570M-78HL4-V, JKM575M-78HL4-V, JKM580M-78HL4-V, JKM585M-78HL4-V, JKM590M-78HL4-V, JKM595M-78HL4-V, JKM600M-78HL4-V, JKM605M-78HL4-V

JKM370M-72HBL-V, JKM375M-72HBL-V, JKM380M-72HBL-V, JKM385M-72HBL-V, JKM390M-72HBL-V, JKM395M-72HBL-V, JKM400M-72HBL-V, JKM405M-72HBL-V, JKM410M-72HBL-V, JKM415M-72HBL-V, JKM420M-72HBL-V.

JKM330M-60HBL-V, JKM335M-60HBL-V, JKM340M-60HBL-V, JKM345M-60HBL-V, JKM350M-60HBL-V.

JKM515N-72HL4-B-V, JKM520N-72HL4-B-V, JKM525N-72HL4-B-V, JKM530N-72HL4-B-V, JKM535N-72HL4-B-V, JKM540N-72HL4-B-V, JKM545N-72HL4-B-V, JKM550N-72HL4-B-V, JKM555N-72HL4-B-V, JKM560N-72HL4-B-V, JKM565N-72HL4-B-V, JKM570N-72HL4-B-V.

JKM475N-66HL4-B-V, JKM480N-66HL4-B-V, JKM485N-66HL4-B-V, JKM490N-66HL4-B-V, JKM495N-66HL4-B-V, JKM500N-66HL4-B-V, JKM505N-66HL4-B-V, JKM510N-66HL4-B-V, JKM515N-66HL4-B-V, JKM520N-66HL4-B-V.

JKM430N-60HL4-B-V, JKM435N-60HL4-B-V, JKM440N-60HL4-B-V, JKM445N-60HL4-B-V, JKM450N-60HL4-B-V, JKM455N-60HL4-B-V, JKM460N-60HL4-B-V, JKM465N-60HL4-B-V, JKM470N-60HL4-B-V.

JKM385N-54HL4-B-V, JKM390N-54HL4-B-V, JKM395N-54HL4-B-V, JKM400N-54HL4-B-V, JKM405N-54HL4-B-V, JKM410N-54HL4-B-V, JKM415N-54HL4-B-V, JKM420N-54HL4-B-V, JKM425N-54HL4-B-V, JKM430N-54HL4-B-V, JKM435N-54HL4-B-V, JKM440N-54HL4-B-V.

JKM585N-78HL4R-V, JKM590N-78HL4R-V, JKM595N-78HL4R-V, JKM600N-78HL4R-V, JKM605N-78HL4R-V, JKM610N-78HL4R-V, JKM615N-78HL4R-V, JKM620N-78HL4R-V, JKM625N-78HL4R-V, JKM630N-78HL4R-V, JKM635N-78HL4R-V, JKM640N-78HL4R-V, JKM645N-78HL4R-V, JKM650N-78HL4R-V

*Deborah Jennings-Conner*  
 Deborah Jennings-Conner, VP Regulatory Services  
 UL LLC



Any information and documentation involving UL Mark services are provided on behalf of UL LLC (UL) or any authorized licensee of UL. For questions, please contact a local UL Customer Service Representative at <http://ul.com/about/locations/>

## TOP TIER

SOLAR SOLUTIONS

**TOP TIER SOLAR SOLUTIONS**

1530 CENTER PARK DR #2911,  
 CHARLOTTE, NC 28217,  
 UNITED STATES

REVISIONS		
DESCRIPTION	DATE	REV
INITIAL DESIGN	05/06/2024	

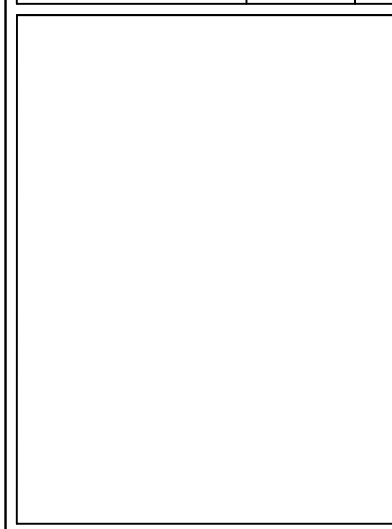

PROJECT NAME & ADDRESS

DANA GWYNN  
RESIDENCE

88 JUDICIARY CT,  
CAMERON, NC 28326

DRAWN BY  
**ESR**

SHEET NAME  
**EQUIPMENT  
SPECIFICATION**

SHEET SIZE  
**ANSI B  
11" X 17"**

SHEET NUMBER  
**PV-10**

# Power Optimizer For Residential Installations

S440 / S500 / S500B / S650B



POWER OPTIMIZER

## Enabling PV power optimization at the module level

- Specifically designed to work with SolarEdge residential inverters
- Mitigates all types of module mismatch loss, from manufacturing tolerance to partial shading
- Detects abnormal PV connector behavior, preventing potential safety issues\*
- Faster installations with simplified cable management and easy assembly using a single bolt
- Module-level voltage shutdown for installer and firefighter safety
- Flexible system design for maximum space utilization
- Superior efficiency (99.5%)
- Compatible with bifacial PV modules

\*Functionality subject to inverter model and firmware version

[solaredge.com](http://solaredge.com)



## Power Optimizer For Residential Installations

S440 / S500 / S500B / S650B

	S440	S500	S500B	S650B	UNIT
<b>INPUT</b>					
Rated Input DC Power <sup>(1)</sup>	440	500		650	W
Absolute Maximum Input Voltage (Voc)	60		125	85	Vdc
MPPT Operating Range	8 – 60		12.5 – 105	12.5 – 85	Vdc
Maximum Short Circuit Current (Isc) of Connected PV Module	14.5		15		Acd
Maximum Efficiency		99.5			%
Weighted Efficiency		98.6			%
Overvoltage Category		II			
<b>OUTPUT DURING OPERATION</b>					
Maximum Output Current		15			Acd
Maximum Output Voltage	60		80		Vdc
<b>OUTPUT DURING STANDBY (POWER OPTIMIZER DISCONNECTED FROM INVERTER OR INVERTER OFF)</b>					
Safety Output Voltage per Power Optimizer		1 ± 0.1			Vdc
<b>STANDARD COMPLIANCE<sup>(2)</sup></b>					
EMC	FCC Part 15 Class B, IEC61000-6-2, IEC61000-6-3, CISPR11, EN-55011				
Safety	IEC62109-1 (class II safety), UL1741				
Material	UL94 V-0, UV Resistant				
RoHS	Yes				
Fire Safety	VDE-AR-E 2100-712:2018-12				
<b>INSTALLATION SPECIFICATIONS</b>					
Maximum Allowed System Voltage		1000			Vdc
Dimensions (W x L x H)	129 x 155 x 30		129 x 165 x 45		mm
Weight	720		790		gr
Input Connector		MC4 <sup>(3)</sup>			
Input Wire Length		0.1			m
Output Connector		MC4			
Output Wire Length		(+) 2.3, (-) 0.10			m
Operating Temperature Range <sup>(4)</sup>		-40 to +85			°C
Protection Rating		IP68			
Relative Humidity		0 – 100			%

(1) Rated power of the module at STC will not exceed the Power Optimizer Rated Input DC Power. Modules with up to +5% power tolerance are allowed.

(2) For details about CE compliance, see Declaration of Conformity – CE.

(3) For other connector types please contact SolarEdge.

(4) Power de-rating is applied for ambient temperatures above +85°C for S440 and S500, and for ambient temperatures above +75°C for S500B. Refer to the Power Optimizers Temperature De-Rating Technical Note for details.

PV System Design Using a SolarEdge Inverter <sup>(5)</sup>	SolarEdge Home Wave Inverter Single Phase	SolarEdge Home Short String Inverter Three Phase	Three Phase for 230/400V Grid	Three Phase for 277/480V Grid	
Minimum String Length (Power Optimizers)	S440, S500: 8 S500B, S650B: 6	9	16	18	
Maximum String Length (Power Optimizers)	25	20	50	14	
Maximum Continuous Power per String	5700	5625	11250	12750	W
Maximum Allowed Connected Power per String (In multiple string designs, the maximum is permitted only when the difference in connected power between strings is 2,000W or less)	See <sup>(6)</sup>	See <sup>(6)</sup>	13500	15000	W
Parallel Strings of Different Lengths or Orientations			Yes		

(5) It is not allowed to mix S-series and P-series Power Optimizers in new installations in the same string.

(6) If the inverter's rated AC power < maximum nominal power per string, then the maximum power per string will be able to reach up to the inverter's maximum input DC power. Refer to Application Note: Single String Design Guidelines.

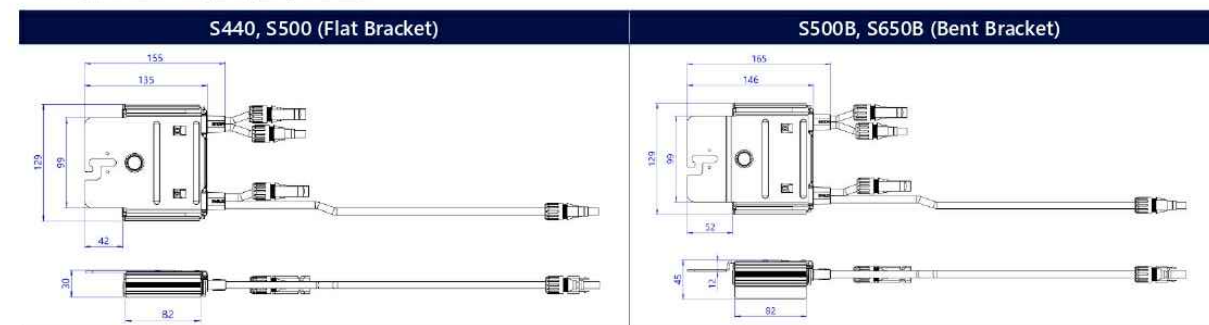

© SolarEdge Technologies, Ltd. All rights reserved. SOLAREEDGE, the SolarEdge logo, OPTIMIZED BY SOLAREEDGE are trademarks or registered trademarks of SolarEdge Technologies, Inc. All other trademarks mentioned herein are trademarks of their respective owners. Date: June 20, 2023 DS-000091-ENG. Subject to change without notice.

CE RoHS

**TOP TIER**  
SOLAR SOLUTIONS

TOP TIER SOLAR SOLUTIONS

1530 CENTER PARK DR #2911,  
CHARLOTTE, NC 28217,  
UNITED STATES

REVISIONS

DESCRIPTION	DATE	REV
INITIAL DESIGN	05/06/2024	

PROJECT NAME & ADDRESS

DANA GWYNN  
RESIDENCE

88 JUDICIARY CT,  
CAMERON, NC 28326

DRAWN BY

ESR

SHEET NAME  
EQUIPMENT  
SPECIFICATION

SHEET SIZE

ANSI B  
11" X 17"

SHEET NUMBER

PV-11

# SolarEdge Home Hub Inverter For North America

SE3800H-US / SE5700H-US / **SE6000H-US** / SE7600H-US /  
SE10000H-US / SE11400H-US<sup>(1)</sup>



HOME BACKUP

## Optimized battery storage with HD-Wave technology

- Record-breaking 99% weighted efficiency with 200% DC oversizing
- Small, lightweight, and easy to install
- Modular design, future ready with optional upgrades to:
  - DC-coupled storage for full or partial home backup
  - Built-in consumption monitoring
  - Direct connection to the SolarEdge Home EV Charger
- Multi-inverter, scalable storage solution, with enhanced battery power up to 10kW
- Integrated arc fault protection and rapid shutdown for NEC 2014 – 2023, per article 690.11 and 690.12
- Embedded revenue grade production data, ANSI C12.20 Class 0.5

## / SolarEdge Home Hub Inverter

For North America

SE3800H-US / SE5700H-US / **SE6000H-US** / SE7600H-US / SE10000H-US /  
SE11400H-US<sup>(1)</sup>

Applicable to inverters with part number	SEXXXXH-USMNBXXXX / SEXXXXH-USSNBXXXX						Units
	SE3800H-US	SE5700H-US	SE6000H-US	SE7600H-US	SE10000H-US	SE11400H-US	
<b>OUTPUT – AC ON GRID</b>							
Rated AC Power	3800 @ 240V 3300 @ 208V	5760 @ 240V 5000 @ 208V	6000 @ 240V 5000 @ 208V	7600	10000	11400 @ 240V 10000 @ 208V	W
Maximum AC Power Output	3800 @ 240V 3300 @ 208V	5760 @ 240V 5000 @ 208V	6000 @ 240V 5000 @ 208V	7600	10000	11400 @ 240V 10000 @ 208V	W
AC Output Voltage (Nominal)	208 / 240						Vac
AC Output Voltage (Range)	183 – 264						Vac
AC Frequency Range (min - nom - max)	59.3 – 60 – 60.5 <sup>(2)</sup>						Hz
Maximum Continuous Output Current @ 240V	16	24	25	32	42	47.5	A
Maximum Continuous Output Current @ 208V	16	24	24	-	-	48	A
GFDI Threshold	1						A
Total Harmonic Distortion (THD)	< 3						%
Power Factor	1, adjustable -0.85 to 0.85						
Utility Monitoring, Islanding Protection, Country Configurable Thresholds	Yes						
Charge Battery from AC (if allowed)	Yes						
Typical Nighttime Power Consumption	< 2.5						W
<b>OUTPUT – AC BACKUP<sup>(3)</sup></b>							
Rated AC Power in Backup Operation <sup>(4)</sup>	7600	5760	6000	7600 11400*	10000 11400*	11400	W
AC L-L Output Voltage Range in Backup	211 – 264						Vac
AC L-N Output Voltage Range in Backup	105 – 132						Vac
AC Frequency Range in Backup (min - nom - max)	55 – 60 – 65						Hz
Maximum Continuous Output Current in Backup Operation	32	24	25	32 47.5	42 47.5	47.5	A
GFDI	1						A
THD	< 5						%
<b>OUTPUT – SOLAREEDGE HOME EV CHARGER AC</b>							
Rated AC Power	9600						W
AC Output Voltage Range	211 – 264						Vac
On-Grid AC Frequency Range (min - nom - max)	59.3 – 60 – 60.5						Hz
Maximum Continuous Output Current @240V (grid, PV and battery)	40						Aac
<b>INPUT – DC (PV AND BATTERY)</b>							
Transformer-less, Ungrounded	Yes						
Max Input Voltage	480						Vdc
Nom DC Input Voltage	380						Vdc
Reverse-Polarity Protection	Yes						
Ground-Fault Isolation Detection	600kΩ Sensitivity						
<b>INPUT – DC (PV)</b>							
Maximum DC Power @ 240V	7600	11520	12000	15200	20000	22800	W
Maximum DC Power @ 208V	6600	10000	10000	-	-	20000	W
Maximum Input Current <sup>(5)</sup> @ 240V	20	16	16.5	20 30	30	30	Adc
Maximum Input Current <sup>(5)</sup> @ 208V	9	13.5	13.5	-	-	27	Adc
Max. Input Short Circuit Current	45						
Maximum Inverter Efficiency	99.2						%
CEC Weighted Efficiency	99						%
2-pole Disconnection	Yes						

\* Supported with PN SExxxxH-USMNBxxxx.

(1) These specifications apply to inverters with part numbers SExxxxH-USMNBxxxx or SExxxxH-USSNBxxxx and connection unit model number DCD-1PH-US-PxH-F-x.

(2) For other regional settings please contact SolarEdge support.

(3) Not designed for standalone applications and requires AC for commissioning. Backup functionality is only supported for 240V grid.

(4) Rated AC power in Backup Operation is valid for installations with multiple inverters. For a single backup inverter operation, rated AC power in Backup is 90% of the value stated.

(5) A higher current source may be used; the inverter will limit its input current to the values stated.

**TOP TIER**  
SOLAR SOLUTIONS

TOP TIER SOLAR SOLUTIONS

1530 CENTER PARK DR #2911,  
CHARLOTTE, NC 28217,  
UNITED STATES

REVISIONS		
DESCRIPTION	DATE	REV
INITIAL DESIGN	05/06/2024	

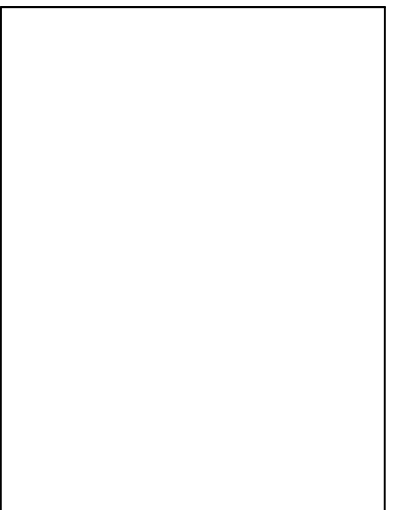

PROJECT NAME & ADDRESS

DANA GWYNN  
RESIDENCE  
88 JUDICIARY CT,  
CAMERON, NC 28326

DRAWN BY  
**ESR**

SHEET NAME  
**EQUIPMENT  
SPECIFICATION**

SHEET SIZE  
**ANSI B  
11" X 17"**

SHEET NUMBER  
**PV-12**

# / SolarEdge Home Hub Inverter

## For North America

SE3800H-US / SE5700H-US / **SE6000H-US** / SE7600H-US / SE10000H-US / SE11400H-US<sup>(1)</sup>

Applicable to inverters with part number	SEXXXXH-USMNBXXX / SEXXXXH-USSNBXXX						Units
	SE3800H-US	SE5700H-US	SE6000H-US	SE7600H-US	SE10000H-US	SE11400H-US	
<b>OUTPUT – DC (BATTERY)</b>							
Supported Battery Types	SolarEdge Home Battery, LG RESU Prime						
Number of Batteries per Inverter	Up to 3 SolarEdge Home Battery, up to 2 LG RESU Prime						
Continuous Power <sup>(6)</sup>	7600 @ 240V 3800 @ 208V	5760 @ 240V 5000 @ 208V	6000		11400	11400 @ 240V 10000 @ 208V	W
Peak Power <sup>(6)</sup>	7600 @ 240V 3800 @ 208V	5760 @ 240V 5000 @ 208V	6000		11400	11400 @ 240V 10000 @ 208V	W
Max Input Current	20	26.5					Adc
2-pole Disconnection	Up to inverter rated backup power						
<b>SMART ENERGY CAPABILITIES</b>							
Consumption Metering	Built-in <sup>(7)</sup>						
Backup & Battery Storage	With Backup Interface (purchased separately) for service up to 200A; up to 3 inverters						
EV Charging	Direct connection to SolarEdge Home EV Charger						
<b>ADDITIONAL FEATURES</b>							
Supported Communication Interfaces	RS485, Ethernet, Cellular <sup>(8,9)</sup> , Wi-Fi <sup>(9)</sup> , SolarEdge Home Network						
Revenue Grade Metering, ANSI C12.20	Built-in <sup>(7)</sup>						
Integrated AC, DC and Communication Connection Unit	Yes						
Inverter Commissioning	With the SetApp mobile application using built-in Wi-Fi Access Point for local connection						
DC Voltage Rapid Shutdown (PV and Battery)	Yes, according to NEC 2014 – 2023 per article 690.11 and 690.12						
<b>STANDARD COMPLIANCE</b>							
Safety	UL1741, UL1741 SA, UL1741 SB, UL1741 PCS, UL1699B, UL1998, UL9540, CSA 22.2						
Grid Connection Standards	IEEE1547-2018, Rule 21, Rule 14H, CSA C22.3 No. 9						
Emissions	FCC part 15 class B						
<b>INSTALLATION SPECIFICATIONS</b>							
AC Output and EV AC Output Conduit Size / AWG Range	1" maximum / 14-4 AWG						
DC Input (PV and Battery) Conduit Size / AWG Range	1" maximum / 14-6 AWG						
Dimensions with Connection Unit (H x W x D)	17.7 x 14.6 x 6.8 / 450 x 370 x 174		17.7 x 14.6 x 6.8 / 450 x 370 x 174**	21.06 x 14.6 x 7.3 / 535 x 370 x 185**		21.06 x 14.6 x 8.2 / 535 x 370 x 208***	in / mm
Weight with Connection Unit		30.8 / 14		30.8 / 14**	41.7 / 18.9**	44.9 / 20.3***	lb / kg
Noise	< 50						dba
Cooling	Natural Convection						
Operating Temperature Range	-40 to +140 / -40 to +60 <sup>(10)</sup>						°F / °C
Protection Rating	NEMA 4X						

\*\* Supported with PN SEXXXXH-USSNBXXX4 or SEXXXXH-USMNBXXX4.

\*\*\* Supported with PN SEXXXXH-USSNBXXX5 or SEXXXXH-USMNBXXX5.

(6) Discharge power is limited up to the inverter rated AC power for on-grid and backup applications, as well as up to the installed batteries' rating.

(7) For consumption metering current transformers should be ordered separately: SECT-SPL-225A-T-20 or SEACT0750-400NA-20 units per box. Revenue grade metering is only for production metering.

(8) Information concerning the Data Plan's terms & conditions is available in the following link: [SolarEdge Communication Plan Terms and Conditions](#).

(9) The part number SEXXXXH-USXNBXXX only supports the Wi-Fi communication interface, and the part number SEXXXXH-USXNBLLX only supports the cellular communication interface.

(10) Full power up to at least 50°C / 122°F; for power de-rating information refer to the [Temperature Derating Technical Note for North America](#).



TOP TIER SOLAR SOLUTIONS

1530 CENTER PARK DR #2911,  
CHARLOTTE, NC 28217,  
UNITED STATES

REVISIONS		
DESCRIPTION	DATE	REV
INITIAL DESIGN	05/06/2024	

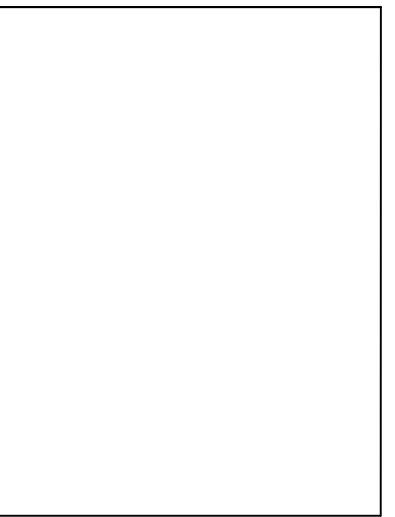

PROJECT NAME & ADDRESS

DANA GWYNN  
RESIDENCE

88 JUDICIARY CT,  
CAMERON, NC 28326

DRAWN BY

ESR

SHEET NAME  
EQUIPMENT  
SPECIFICATION

SHEET SIZE

ANSI B  
11" X 17"

SHEET NUMBER

PV-13



## XR Rail® Family

### Solar Is Not Always Sunny

Over their lifetime, solar panels experience countless extreme weather events. Not just the worst storms in years, but the worst storms in 40 years. High winds capable of ripping panels from a roof, and snowfalls weighing enough to buckle a panel frame.

XR Rails® are the structural backbone preventing these results. They resist uplift, protect against buckling and safely and efficiently transfer loads into the building structure. Their superior spanning capability requires fewer roof attachments, reducing the number of roof penetrations and the amount of installation time.

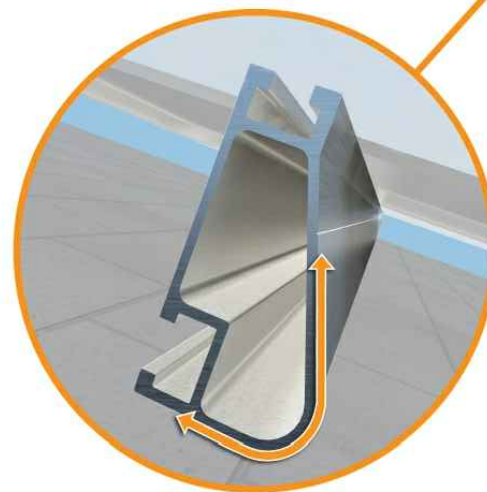
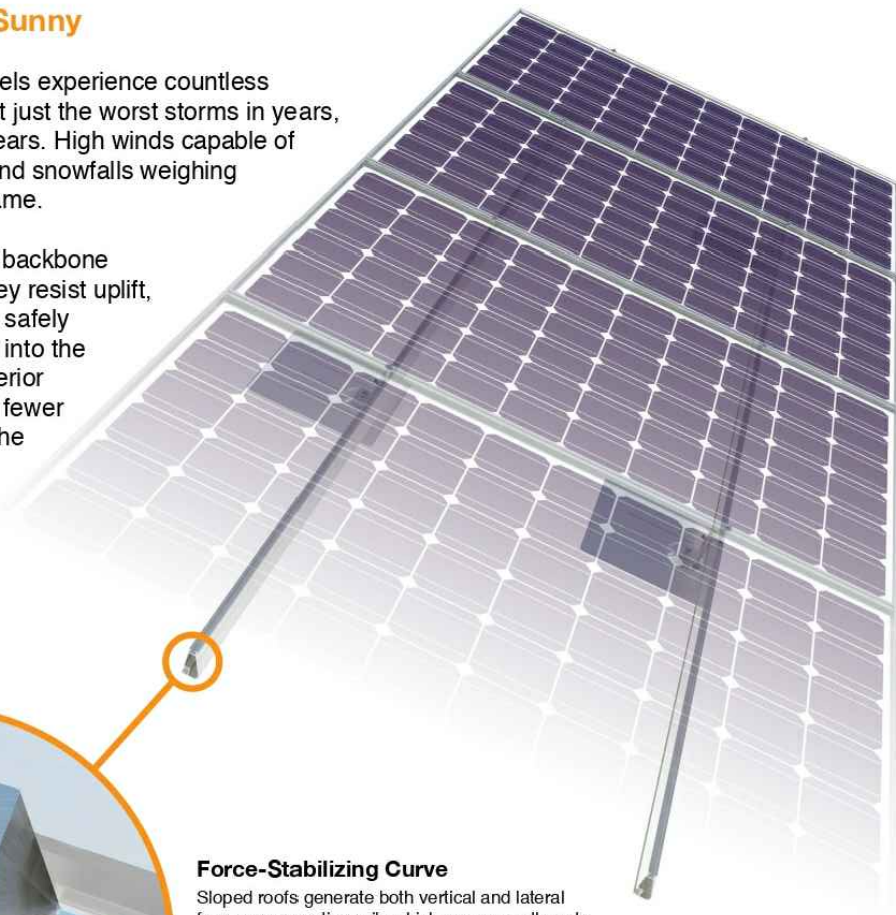

#### Force-Stabilizing Curve

Sloped roofs generate both vertical and lateral forces on mounting rails which can cause them to bend and twist. The curved shape of XR Rails® is specially designed to increase strength in both directions while resisting the twisting. This unique feature ensures greater security during extreme weather and a longer system lifetime.

#### Compatible with Flat & Pitched Roofs



XR Rails® are compatible with FlashFoot® and other pitched roof attachments.



IronRidge® offers a range of tilt leg options for flat roof mounting applications.

#### Corrosion-Resistant Materials

All XR Rails® are made of 6000-series aluminum alloy, then protected with an anodized finish. Anodizing prevents surface and structural corrosion, while also providing a more attractive appearance.



## XR Rail® Family

The XR Rail® Family offers the strength of a curved rail in three targeted sizes. Each size supports specific design loads, while minimizing material costs. Depending on your location, there is an XR Rail® to match.



#### XR10

XR10 is a sleek, low-profile mounting rail, designed for regions with light or no snow. It achieves spans up to 6 feet, while remaining light and economical.

- 6' spanning capability
- Moderate load capability
- Clear & black anodized finish
- Internal splices available



#### XR100

XR100 is a residential and commercial mounting rail. It supports a range of wind and snow conditions, while also maximizing spans up to 10 feet.

- 10' spanning capability
- Heavy load capability
- Clear & black anodized finish
- Internal splices available



#### XR1000

XR1000 is a heavyweight among solar mounting rails. It's built to handle extreme climates and spans up to 12 feet for commercial applications.

- 12' spanning capability
- Extreme load capability
- Clear anodized finish
- Internal splices available

### Rail Selection

The table below was prepared in compliance with applicable engineering codes and standards.\* Values are based on the following criteria: ASCE 7-16, Gable Roof Flush Mount, Roof Zones 1 & 2e, Exposure B, Roof Slope of 8 to 20 degrees and Mean Building Height of 30 ft. Visit IronRidge.com for detailed certification letters.

Load		Rail Span					
Snow (PSF)	Wind (MPH)	4'	5' 4"	6'	8'	10'	12'
None	90						
	120						
	140	XR10		XR100		XR1000	
	160						
20	90						
	120						
	140						
	160						
30	90						
	160						
40	90						
	160						
80	160						
	160						
120	160						
	160						

\*Table is meant to be a simplified span chart for conveying general rail capabilities. Use approved certification letters for actual design guidance.



### TOP TIER SOLAR SOLUTIONS

1530 CENTER PARK DR #2911,  
CHARLOTTE, NC 28217,  
UNITED STATES

REVISIONS		
DESCRIPTION	DATE	REV
INITIAL DESIGN	05/06/2024	

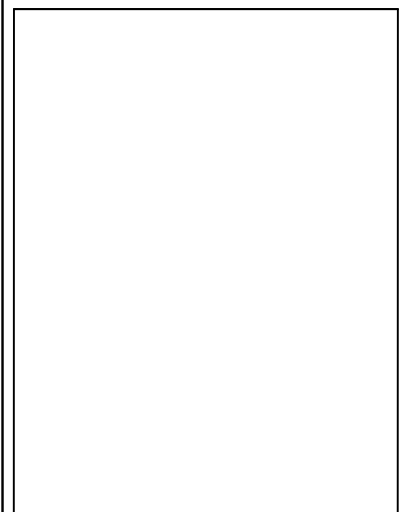

PROJECT NAME & ADDRESS	
DANA GWYNN RESIDENCE	88 JUDICIARY CT, CAMERON, NC 28326

DRAWN BY <b>ESR</b>
------------------------

SHEET NAME <b>EQUIPMENT SPECIFICATION</b>
--

SHEET SIZE <b>ANSI B 11" X 17"</b>
---

SHEET NUMBER <b>PV-14</b>
------------------------------



## UFO® Family of Components

### Simplified Grounding for Every Application

The UFO® family of components eliminates the need for separate grounding hardware by bonding solar modules directly to IronRidge® XR Rails®. All system types that feature the UFO® family—Flush Mount®, Tilt Mount® and Ground Mount®—are fully listed to the UL 2703 standard.

UFO® hardware forms secure electrical bonds with both the module and the rail, resulting in many parallel grounding paths throughout the system. This leads to safer and more reliable installations.

Only for installation and use with IronRidge products in accord with written instructions. See [IronRidge.com/UFO](http://IronRidge.com/UFO)

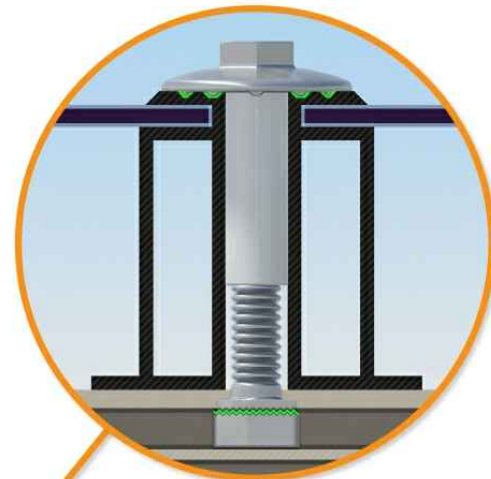

**Universal Fastening Object (UFO®)**  
The UFO® securely bonds solar modules to XR Rails®. It comes assembled and lubricated, and can fit a wide range of module heights.

### System Diagram

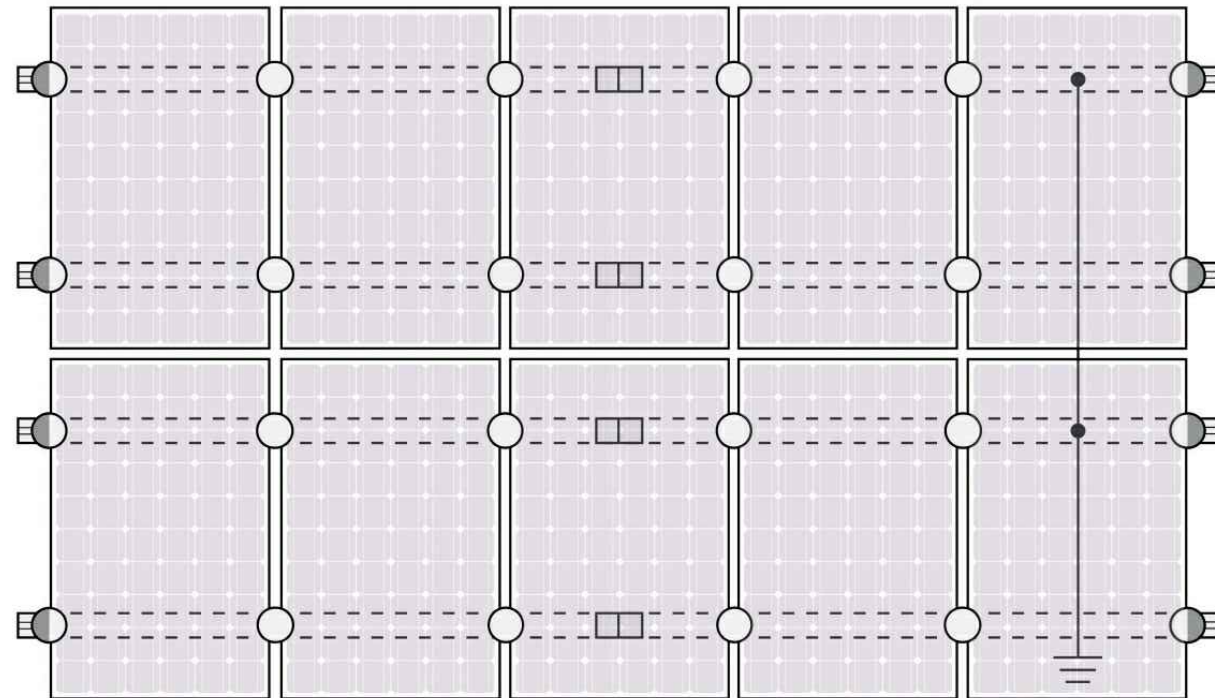

⚡ Approved Enphase microinverters can provide equipment grounding of IronRidge systems, eliminating the need for grounding lugs and field installed equipment ground conductors (EGC). A minimum of two microinverters mounted to the same rail and connected to the same Engage cable is required. Refer to installation manuals for additional details.

### UL Certification

The IronRidge® Flush Mount®, Tilt Mount®, and Ground Mount Systems have been listed to UL 2703 by Intertek Group plc.

UL 2703 is the standard for evaluating solar mounting systems. It ensures these devices will maintain strong electrical and mechanical connections over an extended period of time in extreme outdoor environments.

[Go to IronRidge.com/UFO](http://IronRidge.com/UFO)

Feature	Cross-System Compatibility		
	Flush Mount	Tilt Mount	Ground Mount
XR Rails®	✓	✓	XR100 & XR1000
UFO®/Stopper	✓	✓	✓
BOSS® Splice	✓	✓	N/A
Grounding Lugs	1 per Row	1 per Row	1 per Array
Microinverters & Power Optimizers	Compatible with most MLPE manufacturers. Refer to system installation manual.		
Fire Rating	Class A	Class A	N/A
Modules	Tested or Evaluated with over 400 Framed Modules. Refer to installation manuals for a detailed list.		



**Stopper Sleeve**  
The Stopper Sleeve snaps onto the UFO®, converting it into a bonded end clamp.



**BOSS® Splice**  
Bonded Structural Splice connects rails with built-in bonding teeth. No tools or hardware needed.



**Grounding Lug**  
A single Grounding Lug connects an entire row of PV modules to the grounding conductor.



**Bonded Attachments**  
The bonding bolt attaches and bonds the L-foot® to the rail. It is installed with the same socket as the rest of the system.



TOP TIER SOLAR SOLUTIONS  
1530 CENTER PARK DR #2911,  
CHARLOTTE, NC 28217,  
UNITED STATES

REVISIONS		
DESCRIPTION	DATE	REV
INITIAL DESIGN	05/06/2024	

PROJECT NAME & ADDRESS

DANA GWYNN  
RESIDENCE  
88 JUDICIARY CT,  
CAMERON, NC 28326

DRAWN BY  
ESR

SHEET NAME  
EQUIPMENT  
SPECIFICATION

SHEET SIZE  
ANSI B  
11" X 17"

SHEET NUMBER  
PV-15

Release Liner shown for reference

RD STRUCTURAL SCREW PN RD-1430-01-M1 SOLD SEPARATELY SHOWN FOR REFERENCE

ITEM NO	DESCRIPTION	QTY IN KIT
1	QM Halo UltraGrip(Mill or Black)	1

PART NUMBER	DESCRIPTION
QM-HUG-01-M1	Halo UltraGrip - Mill
QM-HUG-01-B1	Halo UltraGrip - Black

1. Halo UltraGrip

Dimensions: 3.35, .38, 3.83, 1.63, .40, .34, 2.99, 1.56,  $\phi .26$

Property	Value
Material	3000 Series Aluminium
Finish	Mill or Black

REVISIONS		
DESCRIPTION	DATE	REV
INITIAL DESIGN	05/06/2024	

--	--	--

PROJECT NAME & ADDRESS	
DANA GWYNN RESIDENCE	88 JUDICIARY CT, CAMERON, NC 28326

DRAWN BY ESR
-----------------

SHEET NAME EQUIPMENT SPECIFICATION
---------------------------------------

SHEET SIZE ANSI B 11" X 17"
-----------------------------------

SHEET NUMBER PV-16
-----------------------





# QuickMount® RD Structural Screw



**TOP TIER SOLAR SOLUTIONS**

1530 CENTER PARK DR #2911,  
CHARLOTTE, NC 28217,  
UNITED STATES

REVISIONS		
DESCRIPTION	DATE	REV
INITIAL DESIGN	05/06/2024	

ITEM NO	DESCRIPTION	QTY IN KIT
1	Self Drilling Screw, #14, Wood Tip	1
2	Washer, EPDM Backed	1

PART NUMBER	DESCRIPTION
RD-1430-01-M1	RD Structural Screw

1. Self Drilling Screw, #14, Wood Tip

Property	Value
Material	300 Series Stainless Steel
Finish	Clear

2. Washer, EPDM Backed

Property	Value
Material	300 Series Stainless Steel
Finish	Clear

PROJECT NAME & ADDRESS

**DANA GWYNN  
RESIDENCE**  
  
**88 JUDICIARY CT,  
CAMERON, NC 28326**

DRAWN BY  
**ESR**

SHEET NAME  
**EQUIPMENT  
SPECIFICATION**

SHEET SIZE  
**ANSI B  
11" X 17"**

SHEET NUMBER  
**PV-17**

ITEM NO.	PART NUMBER	DESCRIPTION	QTY
1	JB-1.2 BODY	POLYCARBONATE WITH UV INHIBITORS	1
2	JB-1.2 LID	POLYCARBONATE WITH UV INHIBITORS	1
3	#10 X 1-1/4" PHILLIPS PAN HEAD SCREW		6
4	#8 X 3/4" PHILLIPS PAN HEAD SCREW		6

SIZE	DWG. NO.	REV
<b>B</b>	JB-1.2	
SCALE: 1:2	WEIGHT: 1.45 LBS	SHEET 1 OF 3

TORQUE SPECIFICATION:	15-20 LBS
CERTIFICATION:	UL 1741, NEMA 3R CSA C22.2 NO. 290
WEIGHT:	1.45 LBS

SIZE	DWG. NO.	REV
<b>B</b>	JB-1.2	
SCALE: 1:2	WEIGHT: 1.45 LBS	SHEET 2 OF 3

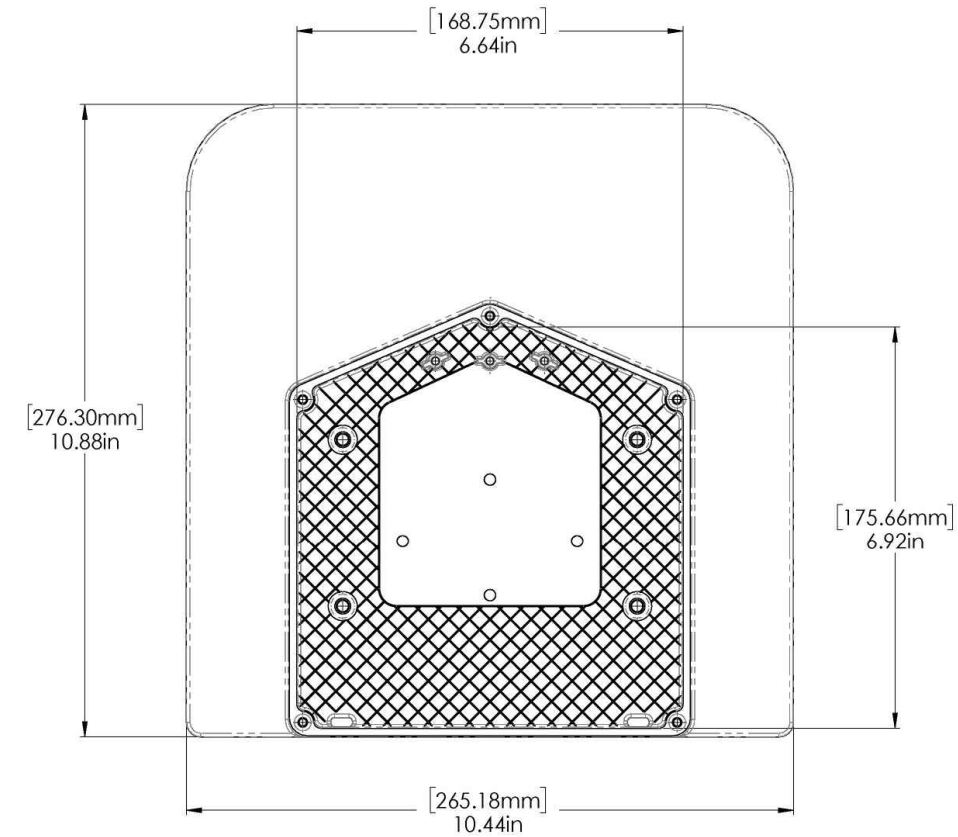
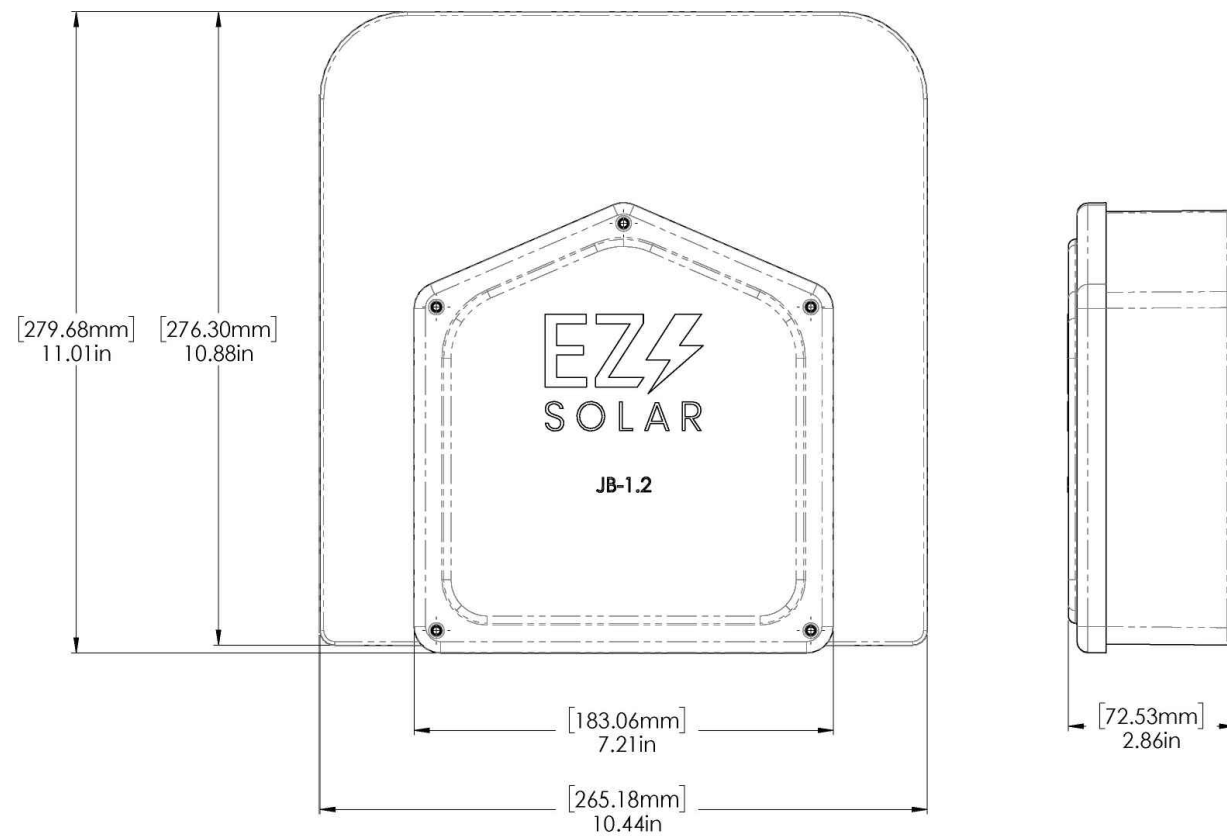

REVISIONS		
DESCRIPTION	DATE	REV
INITIAL DESIGN	05/06/2024	

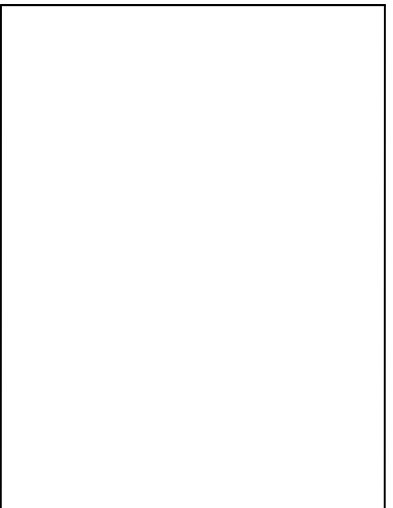

PROJECT NAME & ADDRESS

**DANA GWYNN  
RESIDENCE**

**88 JUDICIARY CT,  
CAMERON, NC 28326**

DRAWN BY  
**ESR**

SHEET NAME  
**EQUIPMENT  
SPECIFICATION**

SHEET SIZE  
**ANSI B  
11" X 17"**

SHEET NUMBER  
**PV-18**