

Project Details

| | | | |
|-------------------|--|----------------------|------------|
| Name | Jonathan Barrera | Date | 02/20/2024 |
| Location | 148 Clyde Dog Court, Lillington, NC 27546 | Total modules | 15 |
| Module | Jinko: JKM395M-72HBL-V (40mm) | Total watts | 5,925 |
| Dimensions | Dimensions: 79.06" x 39.45" x 1.57" (2008.0mm x 1002.0mm x 40.0mm) | Attachments | 21 |
| ASCE | 7-10 | Rails per row | 2 |



System Weight

| | |
|----------------------------|-----------|
| Total system weight | 812.5 lbs |
| Weight/attachment | 38.7 lbs |
| Racking weight | 68.5 lbs |
| Distributed weight | 2.5 psf |

Load Assumptions

| | |
|------------------------------------|---------|
| Wind exposure | B |
| Wind speed | 120 mph |
| Ground snow load | 10 psf |
| Attachment spacing portrait | 6.0' |

Roof Information

| | | | |
|-----------------------------|--------------|------------------------------|----------------------------------|
| Roof Material Family | Comp Shingle | Roof material | Comp Shingle |
| Risk category | II | Roof attachment | Halo UltraGrip (Rafter attached) |
| | | Staggered attachments | Yes |
| Attachment hardware | Square | | |
| Specific gravity | 0.42 | | |

Roof Plane A

| | | | | | |
|---------------|-------|--------------|------|-----------------------|-------|
| Height | 25 ft | Slope | 33 ° | Rafter spacing | 24 in |
|---------------|-------|--------------|------|-----------------------|-------|

Roof Plane A: Roof Section 1

| Details | | Weights |
|-----------------------------|--------------------------------|-----------------------------|
| Panels: 15 | Provided rail: 112' [8 x 168"] | Total weight: 812.5 lbs |
| Rail orientation: East-West | Attachments: 21 | Weight/attachment: 38.7 lbs |
| Panel orientation: Portrait | Splices: 4 | Total Area: 329.8 sq ft |
| Entry type: Graphical | Clamps: 34 | Distributed weight: 2.5 psf |

Diagram

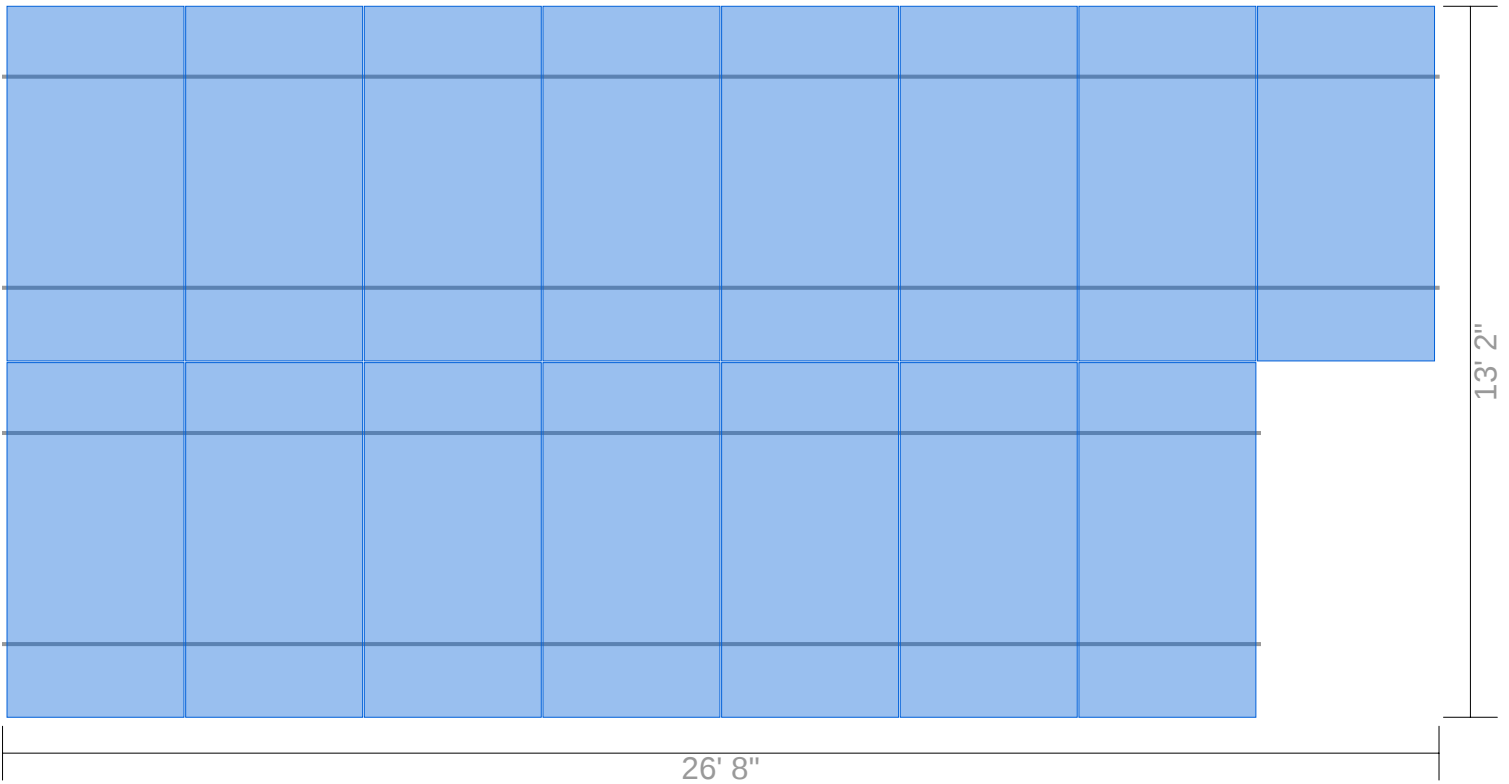

Segments

| Identifier | Columns | Row length | Rail length | Cantilever | Rail | Attachments | Splices | Clamps |
|------------|---------|------------|-------------|------------|----------------|-------------|---------|--------|
| A | 8 | 26' 8" | 26' 8" | 1' 4" | 56' [4 x 168"] | 11 | 2 | 18 |
| B | 7 | 23' 4" | 23' 4" | 2' 8" * | 56' [4 x 168"] | 9 | 2 | 16 |

Cantilever value does not take extra attachments into account

Cantilever violations Fixed with extra attachments

Span Details XR10 - Portrait

| Zone | Max span | Max cantilever |
|------|----------|----------------|
| 1 | 6' | 2' 5" |
| 2 | 6' | 2' 5" |
| 3 | 6' | 2' 5" |

Reaction Forces XR10 - Portrait

| Zone | Uplift (PSF) | Down (lbs) | Uplift (lbs) | Lateral Par (lbs) | Lateral Perp (lbs) |
|------|--------------|------------|--------------|-------------------|--------------------|
| 1 | 12.8 | 286 | 222 | 86 | 6 |
| 2 | 15.5 | 286 | 274 | 86 | 6 |
| 3 | 15.5 | 286 | 274 | 86 | 6 |

Attachment Span Details Halo UltraGrip (Rafter attached) - Portrait

| Zone | Max attachment span |
|------|---------------------|
| 1 | 6' |
| 2 | 6' |
| 3 | 6' |

***Optional - Attachment Span Details Halo UltraGrip (Deck attached) - Portrait**

| Zone | Max attachment span |
|------|---------------------|
| 1 | 4' 9" |
| 2 | 4' 2" |
| 3 | 4' 2" |

* Based on minimum 7/16" sheathing thickness

Side View (portrait)

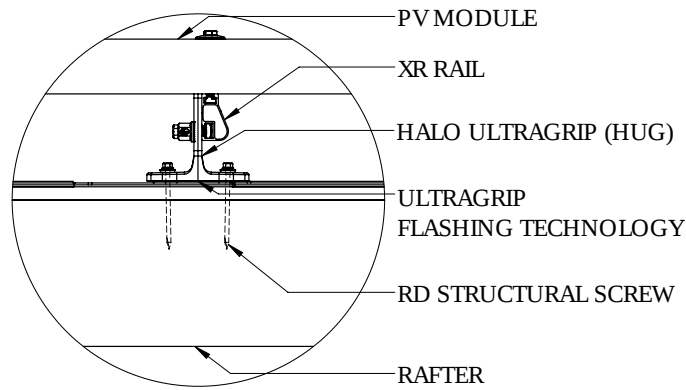
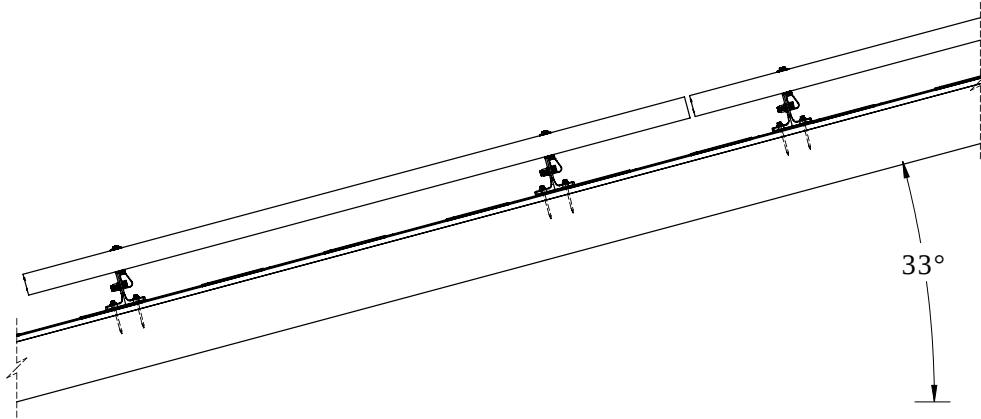

Front View (portrait)

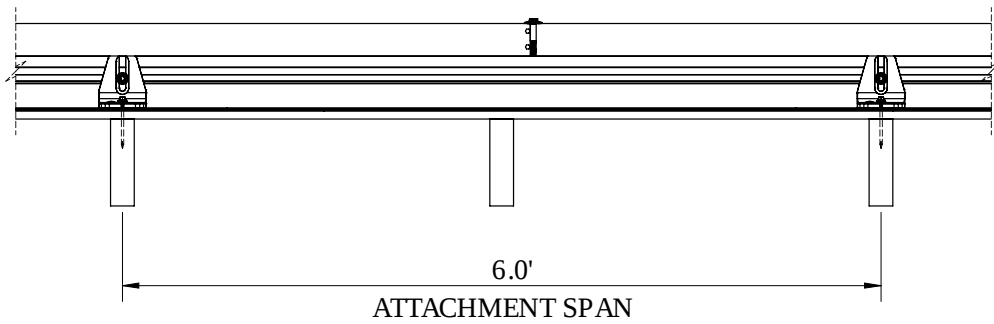

Front View (portrait)

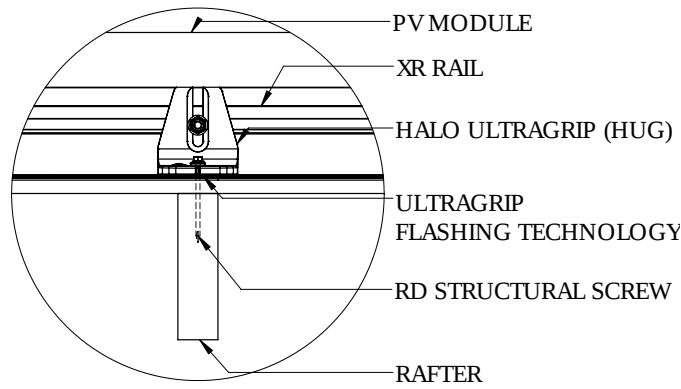

Splice Details

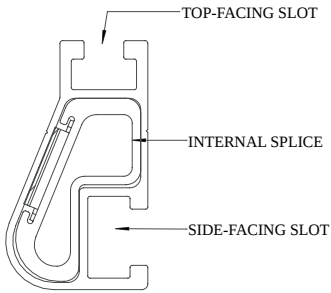

XR10

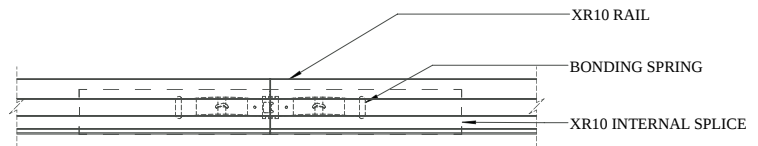

Splice Connection

Clamp Detail

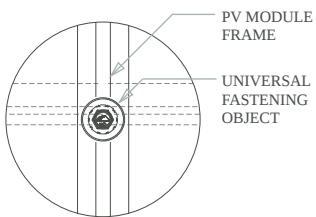

Mid Clamp, Plan

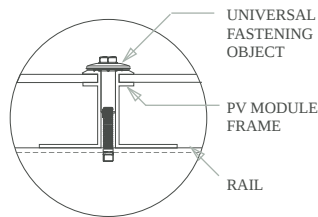

Mid Clamp, Front

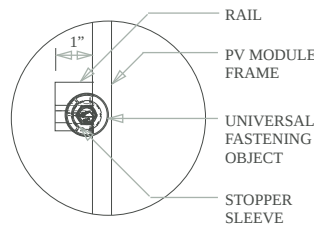

End Clamp, Plan

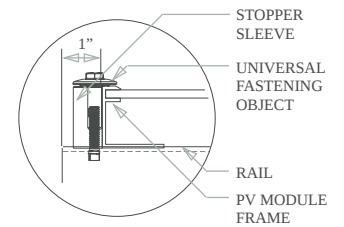

End Clamp, Front

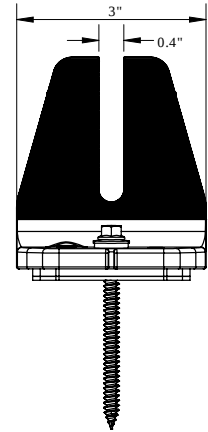
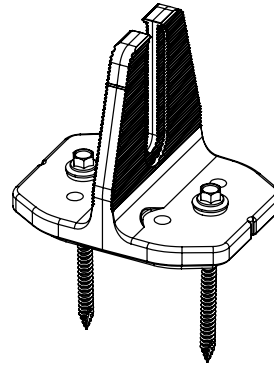
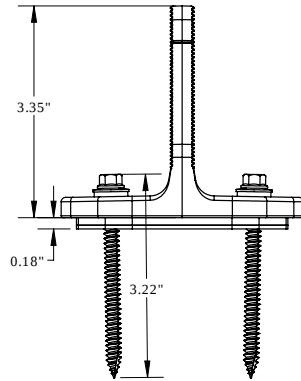
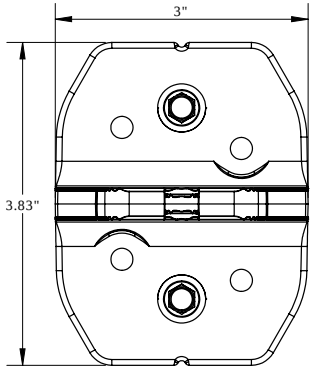

Plan View

Side View

Perspective View

Front View

Grounding Diagram

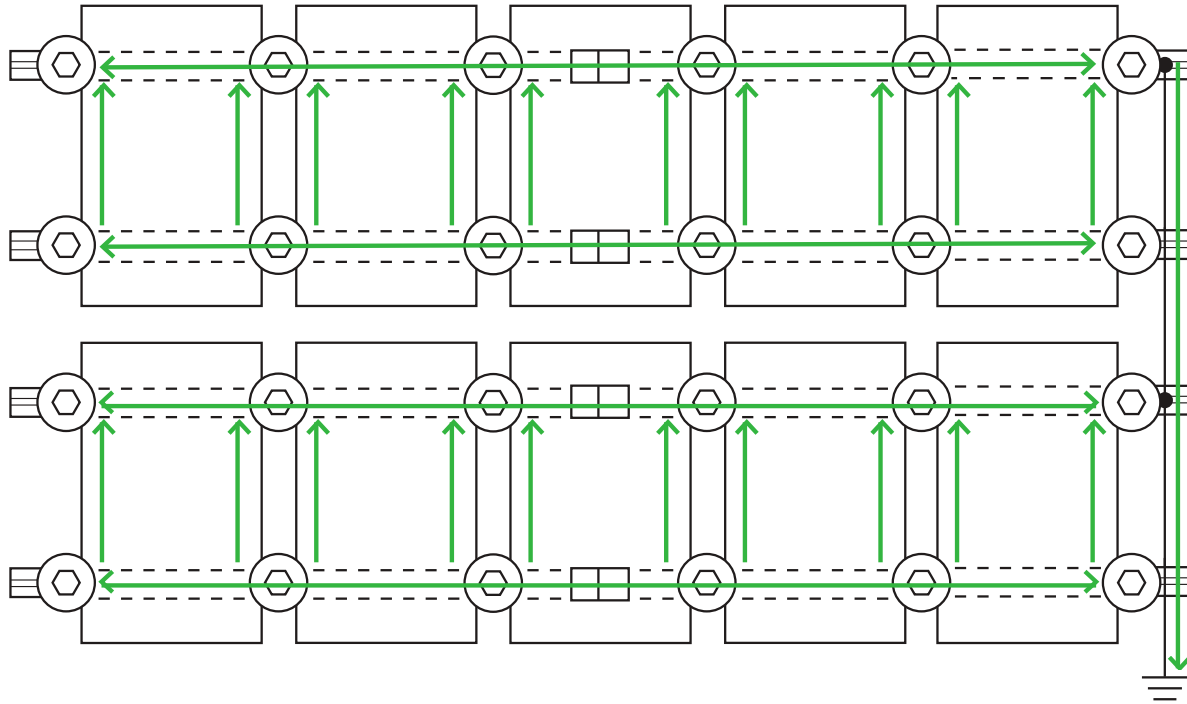

 UFO Clamp

 Fault Current Ground Path

 Grounding Lug *

 Min 10 AWG Copper Wire *

 Bonded Splice (Rail Connection)

* Grounding Lugs and Wire are not required in systems using Enphase microinverters.

Bill of Materials

| Part | Spares | Total Qty |
|--|---------------|------------------|
| Rails & Splices | | |
| XR-10-168A XR10, Rail 168" Clear | 0 | 8 |
| XR10-BOSS-01-M1 Bonded Splice, XR10 | 0 | 4 |
| Clamps & Grounding | | |
| UFO-CL-01-A1 Universal Module Clamp, Clear | 0 | 34 |
| UFO-STP-40MM-M1 Stopper Sleeve, 40MM, Mill | 0 | 8 |
| XR-LUG-03-A1 Grounding Lug, Low Profile | 0 | 2 |
| Attachments | | |
| QM-HUG-01-M1 Halo UltraGrip, Mill * Includes 1 additional part to address cantilever violations | 0 | 21 |
| HW-RD1430-01-M1 RD Structural Screw, 3.0L * Includes 1 additional part to address cantilever violations * Add desired additional screws by adjusting spares column. | 0 | 42 |
| BHW-SQ-02-A1 Square-Bolt Bonding Hardware * Includes 1 additional part to address cantilever violations | 0 | 21 |

ATTACHMENTS

PRE-INSTALLATION

- Verify module compatibility. See [Page 21](#) for info.

TOOLS REQUIRED

- | | |
|---------------------------------|-----------------------|
| □ Cordless Drill (non-impact) | □ 3/8" Socket |
| □ Impact Driver (for lag bolts) | □ 1/8" Drill Bit |
| □ Torque Wrench (0-250 in-lbs) | □ 1/4" Drill Bit |
| □ 7/16" Socket | □ T30 Bit |
| □ 1/2" Socket | □ Channel Lock Pliers |
| □ 9/16" Socket | □ #3 Phillips Bit |
| □ 7/32" Drill Bit | □ 3/16" Hex Bit |

BONDING HARDWARE TORQUE VALUES

Please refer to each attachment's individual section for full details on all torque values and instructions.

- 3/8" Bonding Hardware Nuts (7/16" Socket): 250 in-lbs
- All Tile Hook Carriage Bolts (7/16" Socket): 132 in-lbs
- Flat Roof Attachment Nuts (9/16" Socket): 250 in-lbs
- Lynx Set Screw (3/16" Hex Drive): 150 in-lbs
- Lynx Flange Nut (1/2" Socket): 150 in-lbs

➤ If using previous version of Integrated Grounding Mid Clamps, End Clamps, Expansion Joints and for a list of approved 3rd party components please refer to Alternate Components Addendum (Version 1.9)

ATTACHMENTS

COMPOSITION SHINGLE



FlashFoot2

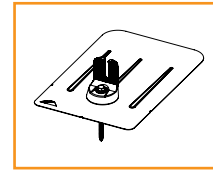

FlashVue

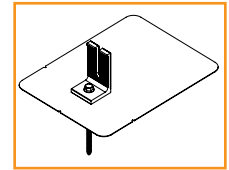

QM L-Mount

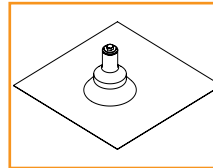

QM QBase

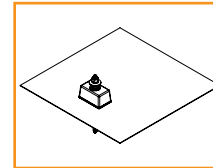

QM Classic Comp Mount

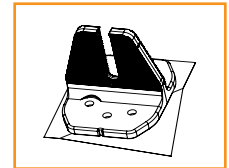

HUG (Halo UltraGrip)

TILE

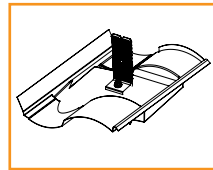

Knockout Tile

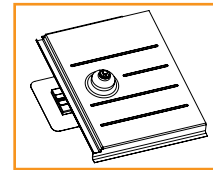

QM Tile Replacement

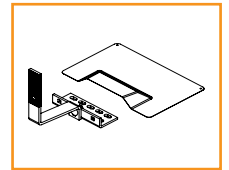

All Tile Hook and Flashing (optional)

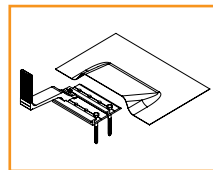

QM Quick Hook and Flashing (optional)

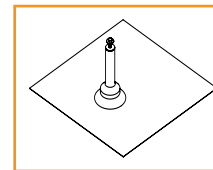

QM QBase Tile

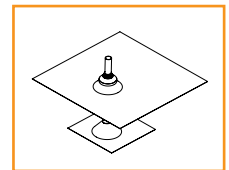

QM Tile Conduit Penetration

ADDITIONAL ROOF TYPES

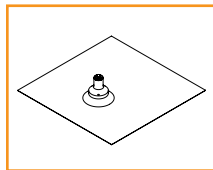

QM Qbase Shake - Slate - Metal Shingle

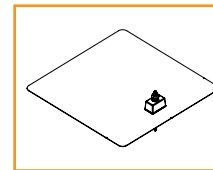

QM Classic Mount Shake

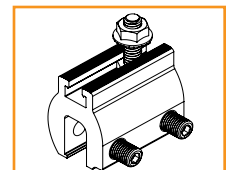

QM Lynx Metal Roof Attachment

LOW SLOPE ROOF

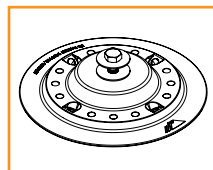

Flat Roof Attachment

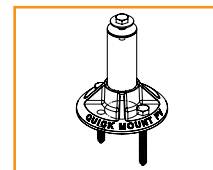

QM QBase Mount

COMPONENTS

PRE-INSTALLATION

- Verify module compatibility. See [Page 21](#) for info.

TOOLS REQUIRED

- Cordless Drill (non-impact)
- Impact Driver (for lag bolts)
- Torque Wrench (0-250 in-lbs)
- 7/16" Socket
- 1/2" Socket
- 9/16" Socket
- 7/32" Drill bit
- 1/8" Drill bit
- 1/4" Drill bit
- T30 Torx Bit
- Channel Lock Pliers
- #3 Phillips Bit
- Paddle Bit

BONDING HARDWARE TORQUE VALUES

Please refer to each attachment's individual section for full details on all torque values and instructions.

- Universal Fastening Object (7/16" Socket): 80 in-lbs
- Rail Grounding Lug Nut (7/16" Socket): 80 in-lbs
- Module Grounding Lug
 - Grounding Nut (7/16" Socket): 60 in-lbs
 - Grounding Lug Terminal Screws (7/16" Socket): 20 in-lbs
- Microinverter Kit Nuts (7/16" Socket): 80 in-lbs
- Frameless Module Kit Nuts (7/16" Socket): 80 in-lbs
- 3/8" Bonding Hardware Nuts (7/16" Socket): 250 in-lbs
- Contour Clamp (T-30 Torx Bit): 80 in-lbs

➤ Unless otherwise noted, all components have been evaluated for multiple use. They can be uninstalled and reinstalled in the same or new location.

COMPONENTS



XR Rail



Wire Clip

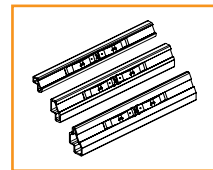

BOSS

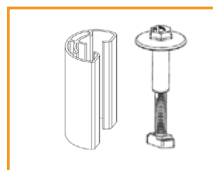

UFO and Stopper Sleeve (30-46MM)



CAMO

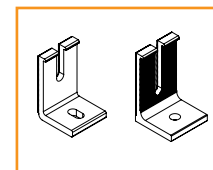

Ironridge L-Foot and QM L-Foot



End Cap

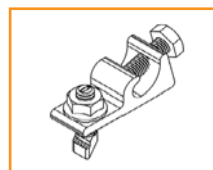

Rail Grounding Lug

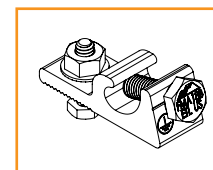

Module Grounding Lug

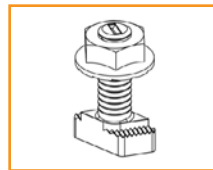

Microinverter Kit

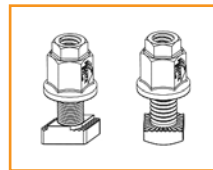

3/8" Bonding Hardware

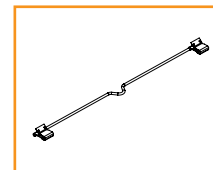

8" Bonding Jumper Single Use Only

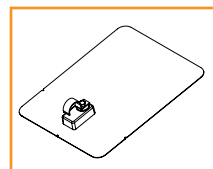

QM Classic Conduit Comp Mount

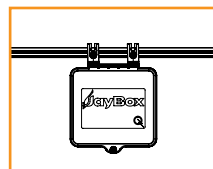

JAYBOX

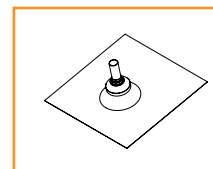

QM Composition Conduit Penetration

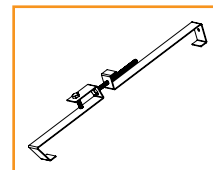

QM Tile Conduit Mount



Frameless End/Mid Clamp

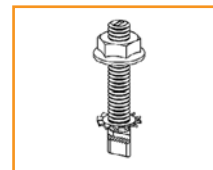

Frameless Module Kit

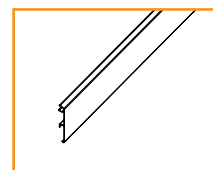

Contour Trim

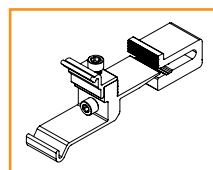

Contour Clamp

Rail: XR10 Flush Mount System Span Table (inches) - Portrait or Landscape Installation
 Max Module Length: 86", Max Module SF: 24.5 SF
 Exposure B

| Wind Speed (mph) | Roof Slope (deg.) | Ground Snow: 0 psf | | | 10 psf | | | 20 psf | | | 30 psf | | | 40 psf | | | 50 psf | | | 60 psf | | | 70 psf* | | | 80 psf* | | | 90 psf* | | | 100 psf* | | | 110 psf* | | | 120 psf* | | |
|------------------|-------------------|--------------------|--------|--------|--------|--------|--------|--------|--------|--------|--------|--------|--------|--------|--------|--------|--------|--------|--------|--------|--------|--------|---------|--------|--------|---------|--------|--------|---------|--------|--------|----------|--------|--------|----------|--------|--------|----------|--------|--------|
| | | Zone 1 | Zone 2 | Zone 3 | Zone 1 | Zone 2 | Zone 3 | Zone 1 | Zone 2 | Zone 3 | Zone 1 | Zone 2 | Zone 3 | Zone 1 | Zone 2 | Zone 3 | Zone 1 | Zone 2 | Zone 3 | Zone 1 | Zone 2 | Zone 3 | Zone 1 | Zone 2 | Zone 3 | Zone 1 | Zone 2 | Zone 3 | Zone 1 | Zone 2 | Zone 3 | Zone 1 | Zone 2 | Zone 3 | Zone 1 | Zone 2 | Zone 3 | Zone 1 | Zone 2 | Zone 3 |
| 110 mph | 8-27 | 81 | 72 | 58 | 72 | 72 | 58 | 58 | 58 | 57 | 57 | 57 | 52 | 52 | 52 | 48 | 48 | 48 | 43 | 43 | 43 | 40 | 40 | 40 | 38 | 38 | 38 | 36 | 36 | 36 | 34 | 34 | 34 | 33 | 33 | 33 | 32 | 32 | 32 | |
| | 28-45 | 79 | 79 | 79 | 69 | 69 | 69 | 58 | 58 | 58 | 58 | 58 | 53 | 53 | 53 | 50 | 50 | 50 | 48 | 48 | 48 | 44 | 44 | 44 | 41 | 41 | 41 | 39 | 39 | 39 | 37 | 37 | 37 | 36 | 36 | 36 | 34 | 34 | 34 | |
| 115 mph | 8-27 | 81 | 69 | 55 | 72 | 69 | 55 | 58 | 58 | 55 | 57 | 57 | 52 | 52 | 52 | 48 | 48 | 48 | 43 | 43 | 43 | 40 | 40 | 40 | 38 | 38 | 38 | 36 | 36 | 36 | 34 | 34 | 34 | 33 | 33 | 33 | 32 | 32 | 32 | |
| | 28-45 | 76 | 76 | 76 | 69 | 69 | 69 | 58 | 58 | 58 | 58 | 58 | 53 | 53 | 53 | 50 | 50 | 50 | 48 | 48 | 48 | 44 | 44 | 44 | 41 | 41 | 41 | 39 | 39 | 39 | 37 | 37 | 37 | 36 | 36 | 36 | 34 | 34 | 34 | |
| 120 mph | 8-27 | 81 | 66 | 53 | 72 | 66 | 53 | 58 | 58 | 53 | 57 | 57 | 53 | 52 | 52 | 52 | 48 | 48 | 48 | 43 | 43 | 43 | 40 | 40 | 40 | 38 | 38 | 38 | 36 | 36 | 36 | 34 | 34 | 34 | 33 | 33 | 33 | 32 | 32 | 32 |
| | 28-45 | 74 | 74 | 74 | 68 | 68 | 68 | 58 | 58 | 58 | 58 | 58 | 53 | 53 | 53 | 50 | 50 | 50 | 48 | 48 | 48 | 44 | 44 | 44 | 41 | 41 | 41 | 39 | 39 | 39 | 37 | 37 | 37 | 36 | 36 | 36 | 34 | 34 | 34 | |
| 130 mph | 8-27 | 81 | 61 | 49 | 72 | 61 | 49 | 58 | 58 | 49 | 57 | 57 | 49 | 52 | 52 | 49 | 48 | 48 | 48 | 43 | 43 | 43 | 40 | 40 | 40 | 38 | 38 | 38 | 36 | 36 | 36 | 34 | 34 | 34 | 33 | 33 | 33 | 32 | 32 | 32 |
| | 28-45 | 72 | 69 | 69 | 66 | 66 | 66 | 57 | 57 | 57 | 57 | 57 | 52 | 52 | 52 | 49 | 49 | 49 | 48 | 48 | 48 | 44 | 44 | 44 | 41 | 41 | 41 | 39 | 39 | 39 | 37 | 37 | 37 | 36 | 36 | 36 | 34 | 34 | 34 | |
| 140 mph | 8-27 | 77 | 56 | 45 | 72 | 56 | 45 | 58 | 56 | 45 | 57 | 56 | 45 | 52 | 52 | 45 | 48 | 48 | 45 | 43 | 43 | 43 | 40 | 40 | 40 | 38 | 38 | 38 | 36 | 36 | 36 | 34 | 34 | 34 | 33 | 33 | 33 | 32 | 32 | 32 |
| | 28-45 | 67 | 64 | 64 | 64 | 64 | 64 | 56 | 56 | 56 | 55 | 55 | 55 | 51 | 51 | 51 | 48 | 48 | 48 | 48 | 48 | 48 | 43 | 43 | 43 | 41 | 41 | 41 | 39 | 39 | 39 | 37 | 37 | 37 | 36 | 36 | 36 | 34 | 34 | 34 |
| 150 mph | 8-27 | 72 | 53 | 42 | 72 | 53 | 42 | 58 | 53 | 42 | 57 | 53 | 42 | 52 | 52 | 42 | 48 | 48 | 42 | 43 | 43 | 42 | 40 | 40 | 40 | 38 | 38 | 38 | 36 | 36 | 36 | 34 | 34 | 34 | 33 | 33 | 33 | 32 | 32 | 32 |
| | 28-45 | 64 | 60 | 60 | 64 | 60 | 60 | 54 | 54 | 54 | 54 | 54 | 50 | 50 | 50 | 48 | 48 | 48 | 45 | 45 | 45 | 43 | 43 | 43 | 41 | 41 | 41 | 39 | 39 | 39 | 37 | 37 | 37 | 36 | 36 | 36 | 34 | 34 | 34 | |
| 160 mph | 8-27 | 67 | 49 | 40 | 67 | 49 | 40 | 57 | 49 | 40 | 56 | 49 | 40 | 51 | 49 | 40 | 48 | 48 | 40 | 43 | 43 | 40 | 40 | 40 | 40 | 38 | 38 | 38 | 36 | 36 | 36 | 34 | 34 | 34 | 33 | 33 | 33 | 32 | 32 | 32 |
| | 28-45 | 60 | 57 | 57 | 59 | 57 | 57 | 53 | 53 | 53 | 52 | 52 | 52 | 49 | 49 | 49 | 48 | 48 | 48 | 44 | 44 | 44 | 42 | 42 | 42 | 40 | 40 | 40 | 39 | 39 | 39 | 37 | 37 | 37 | 36 | 36 | 36 | 34 | 34 | 34 |
| 170 mph | 8-27 | 64 | 48 | 38 | 64 | 48 | 38 | 56 | 48 | 38 | 55 | 48 | 38 | 50 | 48 | 38 | 48 | 48 | 38 | 43 | 43 | 38 | 40 | 40 | 38 | 38 | 38 | 36 | 36 | 36 | 34 | 34 | 34 | 33 | 33 | 33 | 32 | 32 | 32 | |
| | 28-45 | 57 | 54 | 54 | 57 | 54 | 54 | 51 | 51 | 51 | 51 | 51 | 48 | 48 | 48 | 45 | 45 | 45 | 43 | 43 | 43 | 41 | 41 | 41 | 40 | 40 | 40 | 38 | 38 | 38 | 37 | 37 | 37 | 36 | 36 | 36 | 34 | 34 | 34 | |
| 180 mph | 8-27 | 60 | 44 | 35 | 60 | 44 | 35 | 55 | 44 | 35 | 54 | 44 | 35 | 50 | 44 | 35 | 48 | 44 | 35 | 43 | 43 | 35 | 40 | 40 | 35 | 38 | 38 | 35 | 36 | 36 | 35 | 34 | 34 | 34 | 33 | 33 | 33 | 32 | 32 | 32 |
| | 28-45 | 55 | 51 | 51 | 55 | 51 | 51 | 50 | 50 | 50 | 49 | 49 | 49 | 48 | 48 | 48 | 44 | 44 | 44 | 42 | 42 | 42 | 40 | 40 | 40 | 39 | 39 | 39 | 38 | 38 | 38 | 36 | 36 | 36 | 35 | 35 | 35 | 34 | 34 | 34 |

= min 72" span
 = min 64" span
 = min 48" span
 * = Note: additional installation requirement for CAMO module clamp. See Note 12 on Page 3 for details.
 REV 03/05/2021
 = Shaded cells indicate conditions in which UFO Mid Clamp connection capacity is exceeded. See Note 10 on page 2 for details.