

STRING CALCULATION

String #	No of Modules	Estimated Power	Imax	Voc	Vmpp	Vrise (<= 2%)
1	12	4,920 W	18.15 AC	<30	240V AC	1.47+0.38 = 0.85
2	11	4,510 W	16.63 AC	<30	240V AC	1.35+0.35 = 1.70
3	11	4,510 W	16.63 AC	<30	240V AC	1.37+0.37 = 1.74
4	11	4,510 W	16.63 AC	<30	240V AC	1.30+0.34 = 1.64

NEC Code (2020) and UL Standard References

Rapid Shut Down	NEC 690.12 (A-D), UL1741	Grounding	NEC Article 250.30(A)
Disconnecting Means	NEC 690.13	Conduit Fill	NEC Table C.9, 310.15(B)(3)(a)
Feeder Sizing	NEC Table 310, 15(B)(16, 17)	Interconnection	NEC 705.12
Over current Protection	NEC 690.9		



5112 Departure Drive,
Raleigh NC 27616
O: 919.948.6474
E: info@8msolar.com

45 X SILFAB ELITE SIL-410 BG
410W
ENPHASE IQ8PLUS-72-2-US MICROINVERTERS
290VA
RAPID SHUTDOWN EQUIPPED

Service Side Work: Power Drop Required

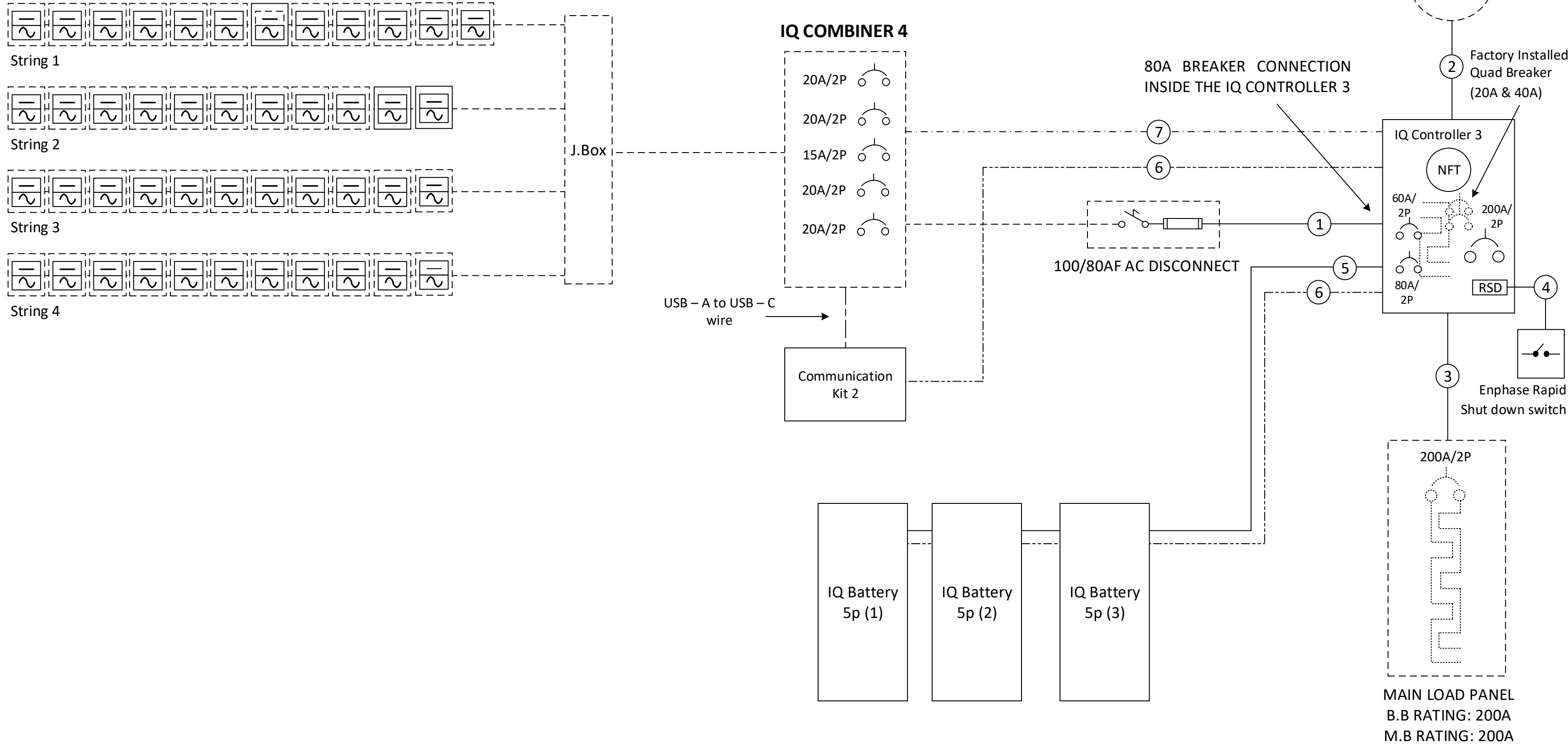

Customer Information:

Gerald Rhodes
2923 Highway 87 N
Sanford NC 27332

Customer Signature:

Sheet Name:

Electrical One Line Diagram

JOB NUMBER:

24-66-GR

Date:

02/20/2024

Revision:

A

Sheet Size:

ANSI C
17" X 22"

Sheet Number:

PV1

- System Size: 18,450W DC
- Battery Total Energy: 15.0 kWh
- (45) ENPHASE IQ8PLUS-72-2-US MICROINVERTERS
- Inverter Output: 1.21A max @ 240 VAC (each microinverter)
- 290 VA AC output max (each micro inverter)
- 13.05 kVA AC output max

- Grounding will be done via Pegasus grounding lugs and mid-clamps to ensure the rail and panels are continuously grounded.
- Rapid Shutdown is included in the Micro Inverters, refer to Micro Inverter attached datasheets.
- The load center / disconnect will be visible, lockable accessible to utility linesmen and will be properly labelled as per NEC requirements. It will be located on the exterior wall of the building, next to the utility meter.

Sr.No	#Wire	Conduit Size	Ground Wire	Amperage
1	3 x #4 THHN Cu	1" EMT	#8 Green Cu	80
2	3 x #3/0 THHN Cu	2" PVC		200
3	3 x #3/0 THHN Cu	2" PVC	#6 Green Cu	200
4	4 x #12 THHN Cu	3/4" EMT	#10 Green Cu	16
5	3 x #6 THHN Cu	3/4" EMT	#8 Green Cu	60
6	Enphase Control Cable (4 conductors)			
7	Lead Wire 18AWG, PVC Extruded			



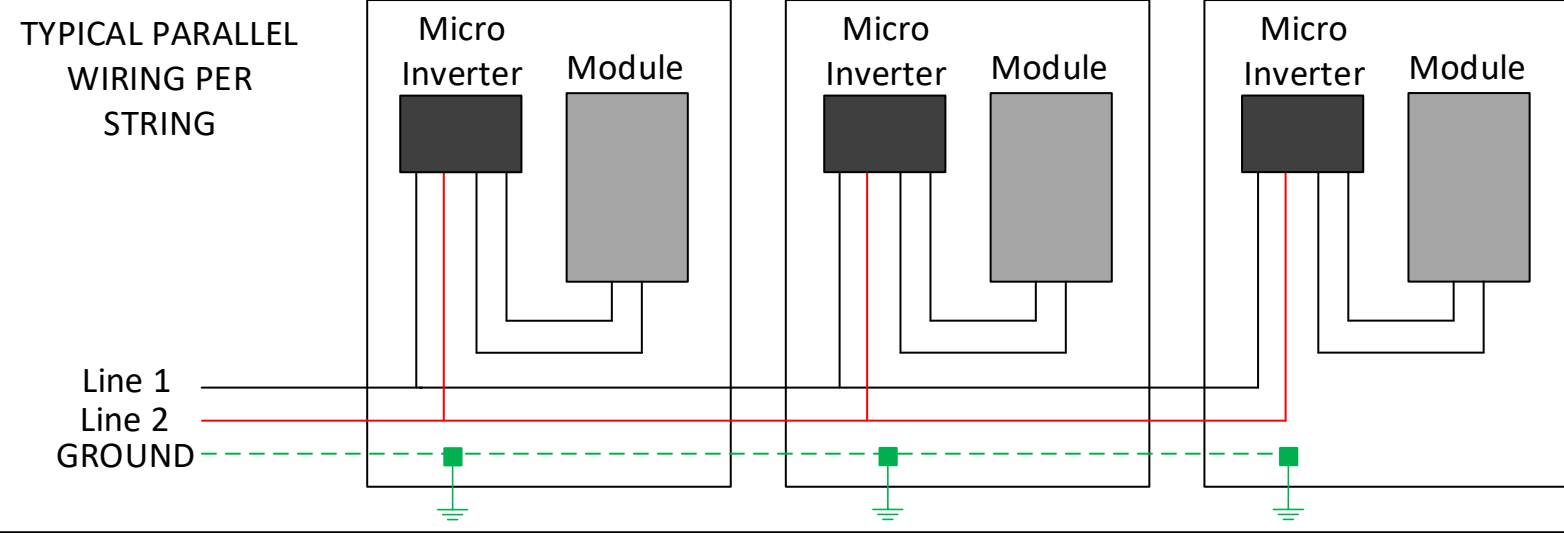

Line 1		Note: 15A breaker for IQ Gateway from IQ Combiner 4 will be removed and envoy will be wired to the 20Amp Quad breaker on IQ System Controller 3.
Line 2		
Neutral		Note: Ground and neutral should be bound in the IQ Controller 3.
Ground		Note: Loads more than 48A will be non-backed up by Enphase IQ 5P Batteries and will be managed manually.
CT Wire		

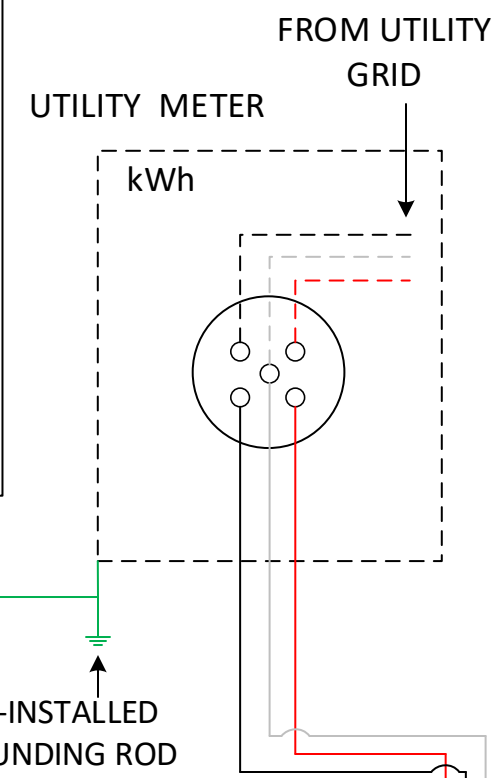

5112 Departure Drive,
Raleigh NC 27616
O: 919.948.6474
E: info@8msolar.com

Customer Information:

Gerald Rhodes

2923 Highway 87 N
Sanford NC 27332

Customer Signature:

Sheet Name:

Detailed Electrical Diagram

JOB NUMBER:

24-66-GR

Date:

02/20/2024

Revision:

A

Sheet Size:

ANSI C
17" X 22"

Sheet Number:

PV2

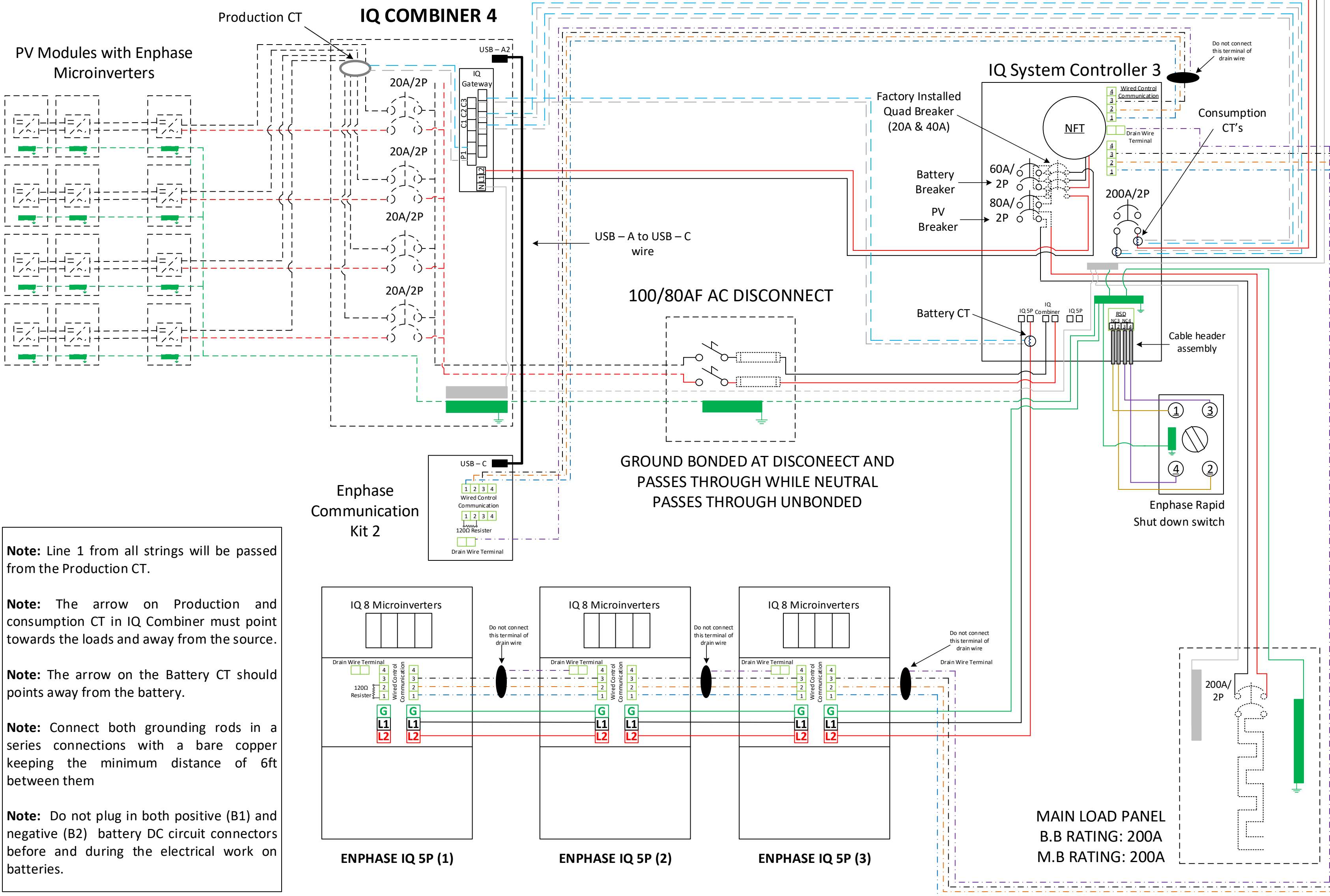

- Note:** Line 1 from all strings will be passed from the Production CT.
- Note:** The arrow on Production and consumption CT in IQ Combiner must point towards the loads and away from the source.
- Note:** The arrow on the Battery CT should point away from the battery.
- Note:** Connect both grounding rods in a series connections with a bare copper keeping the minimum distance of 6ft between them
- Note:** Do not plug in both positive (B1) and negative (B2) battery DC circuit connectors before and during the electrical work on batteries.

MAIN LOAD PANEL
B.B RATING: 200A
M.B RATING: 200A

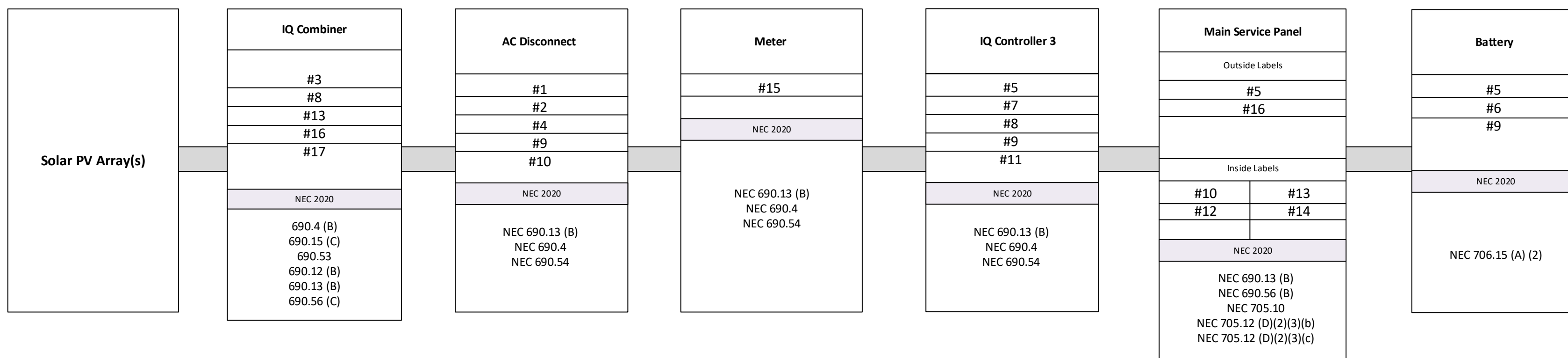

5112 Departure Drive,
Raleigh NC 27616
O: 919.948.6474
E: info@8msolar.com

LABELING AND WARNING SIGNS: NEC 2020

A. PURPOSE
PROVIDE EMERGENCY RESPONDERS WITH APPROPRIATE WARNING AND GUIDANCE WITH RESPECT TO ISOLATING THE SOLAR ELECTRIC SYSTEM. THIS CAN FACILITATE IDENTIFYING ENERGIZED ELECTRICAL LINES THAT CONNECT THE SOLAR PANELS TO THE INVERTER, AS SHOULD NOT BE CUT WHEN VENTING FOR SMOKE REMOVAL.

B. MAIN SERVICE DISCONNECT:

1. RESIDENTIAL BUILDINGS- THE MARKING MAY BE PLACED WITHIN THE MAIN SERVICE DISCONNECT. THE MARKING SHALL BE PLACED ON THE OUTSIDE COVER IF THE MAIN SERVICE DISCONNECT IS OPERABLE WITH THE SERVICE PANEL CLOSED.
2. COMMERCIAL BUILDINGS- THE MARKINGS SHALL BE PLACED ADJACENT TO THE MAIN SERVICE DISCONNECT CLEARLY VISIBLE FROM THE LOCATION WHERE THE LEVER IS OPERATED
3. MARKINGS, VERBIAGE, FORMAT AND TYPE OF MATERIAL
 - a. VERBIAGE: CAUTION; SOLAR ELECTRIC SYSTEM CONNECTED
 - b. FORMAT:
 - (1) WHITE LETTERING ON A RED BACKGROUND
 - (2) MINIMUM 3/8 INCH LETTER HEIGHT
 - (3) ALL LETTERS SHALL BE CAPITALIZED
 - (4) ARIAL OR SIMILAR FONT, NON-BOLD
 - c. MATERIAL:
 - (1) REFLECTIVE, WEATHER RESISTANT MATERIAL SUITABLE FOR THE ENVIRONMENT (USE UL-969) AS STANDARD FOR WEATHER RATING); DURABLE ADHESIVE MATERIALS MEET THIS REQUIREMENT.

C. MARKING REQUIREMENTS ON CONDUIT, RACEWAYS, ENCLOSURES, CABLE ASSEMBLIES, COMBINERS AND JUNCTION BOXES;

1. MARKING: PLACEMENT, VERBIAGE, FORMAT AND TYPE OF MATERIAL.
 - a. PLACEMENT: MARKINGS SHALL BE PLACED EVERY 10 (TEN) FEET ON ALL INTERIOR AND EXTERIOR DC CONDUITS, RACEWAYS, ENCLOSURES AND CABLE ASSEMBLIES, AT TURNS ABOVE AND/OR BELOW PENETRATIONS, ALL COMBINERS AND JUNCTION BOXES.
 - b. VERBIAGE: CAUTION SOLAR CIRCUIT
 - c. THE FORMAT AND TYPE OF MATERIAL SHALL ADHERE TO SECTION B-3.B & C ABOVE

D. INVERTERS ARE NOT REQUIRED TO HAVE CAUTION MARKINGS

<p>#1</p>	<p>#6</p>	<p>#12</p>
<p>#2</p>	<p>#7</p>	<p>#13</p>
<p>#3</p>	<p>#8</p>	<p>#14</p>
<p>#4</p>	<p>#9</p>	<p>#15</p>
<p>#5</p>	<p>#10</p>	<p>#16</p>
<p>#11</p>	<p>#17</p>	

Customer Information:
Gerald Rhodes
2923 Highway 87 N
Sanford NC 27332

Customer Signature:

Sheet Name:
PV Labels

JOB NUMBER:
24-66-GR

Date: 02/20/2024	Revision: A
----------------------------	-----------------------

Sheet Size: ANSI C 17" X 22"	Sheet Number: PV3
---	-----------------------------

PV Installation Professional
Ali Buttar
PVIP #031310-32

ROOF DESCRIPTION				MODULE DIMENSIONS	Rails and Splices : PSR-B84 (BLACK)	Roof Attachment : S5 SolarFoot
ROOF	PITCH	AZIMUTH	NO. OF MODULES		Rafter Spacing : 24 in	There is an exposed fastened 9" AG panel metal roof
A	22°	258°	45		Attachment Span: 4ft	The roof is located in 110mph wind zone

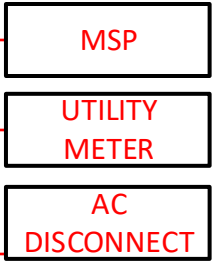

5112 Departure Drive,
Raleigh NC 27616
O: 919.948.6474
E: info@8msolar.com

Customer Information:

Gerald Rhodes
2923 Highway 87 N
Sanford NC 27332

Customer Signature:

Sheet Name:

Bill of Material

JOB NUMBER:

24-66-GR

Date:

02/20/2024

Revision:

A

Sheet Size:

ANSI C
17" X 22"

Sheet Number:

PV4

ELECTRICAL ITEMS

- 01 x COMMS-KIT-02: Enphase Communication Kit 2
- 01 x SC200D111C240US01: IQ System Controller 3
- 03 x IQBATTERY-5P-1P-NA: IQ Battery 5P
- 01 x CTRL-SC3-NA-01: Enphase Control Cable (70 ft.)

- 01 x X-IQ-NA-HD-125A: Hold down kit for Eaton circuit breaker with screws
- 01 x BRK-200A-2P-240V: Main Breaker, 2-Pole, 200Amps(Eaton CSR2200N)
- 01 x BRK-60A-2P-240V: Circuit Breaker, 2 pole, 60A (Eaton BR260)
- 01 x BRK-80A-2P-240V: Circuit Breaker, 2 pole, 80A (Eaton BR 280)

PV LABELS

Sr No	Code	Qty
01	03-302	01
02	02-316	02
03	03-390	01
04	03-306	01
05	8M-001	05
06	03-395	03
07	03-304	01
08	03-230	03
09	8M-002	05
10	8M-004	02
11	05-342	01
12	05-372	01
13	05-215	04
14	05-216	01
15	07-359	01
16	07-111	02
17	03-355	01
18	03-351	02

BILL OF MATERIAL
SCALE: 1/8" - 1'

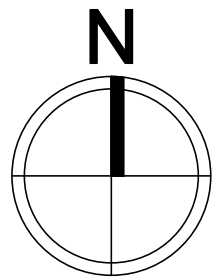

Ali Buttar
PVIP #031310-32



IQ Battery 5P

The IQ Battery 5P all-in-one AC-coupled system is powerful, reliable, simple, and safe. It has a total usable energy capacity of 5.0 kWh and includes six embedded grid-forming microinverters with a 3.84 kVA continuous power rating. It provides backup capability, and installers can quickly design the right system size to meet the customer needs.

Dimensions

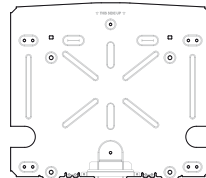
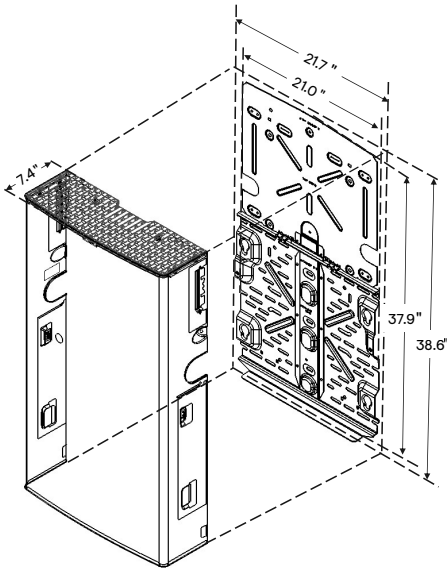

Top shield

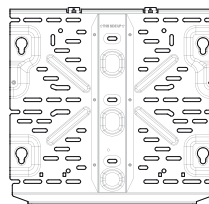

Bottom mounting bracket



15-year limited warranty



LISTED



UL 9540A Certified

Powerful

- Provides 3.84 kVA continuous and 7.68 kVA peak power
- Doubles the available power per kWh of prior generations of IQ Battery
- Includes six embedded IQ8D-BAT Microinverters

Reliable

- 15-year limited warranty
- Cools passively with no moving parts or fans
- Uses wired communication for fast and consistent connection
- Updates software and firmware remotely

Simple

- Fully integrated AC battery system
- Installs and commissions easily
- Supports Backup, Self-Consumption, and time-of-use (TOU) modes
- Offers homeowners remote monitoring and control from the Enphase App
- Field replaceable components

Safe

- Evaluated to UL 9540A for large scale fire testing and reduced separation distance as required in 2021 IRC R328.3.1, 2021 IFC 1207.1.5, and 2023 NFPA 855 15.3.1 and 9.1.5.¹
- Uses lithium iron phosphate (LFP) chemistry for maximum safety and longevity

¹Follow all installation instructions when installing Enphase ESS.

IQ Battery 5P

MODEL NUMBER	
IQBATTERY-5P-1P-NA	The IQ Battery 5P system with integrated IQ Microinverters and battery management system (BMS) with battery controller
WHAT'S IN THE BOX	
IQ Battery 5P unit	IQ Battery 5P unit (B05-T02-US00-1-3)
ID cover and conduit cover	IQ Battery 5P cover with two conduit covers for the left and right sides of the unit
Bottom mounting bracket and top shield	Bottom mounting bracket for mounting the battery on the wall. One top shield is required for UL9540A
M5 seismic screws	Two M5 seismic screws for securing the battery unit on the bottom mounting bracket
M4 grounding screws	Two M4 grounding screws for securing the top shield on the bottom mounting bracket
M5 ID cover grounding screws	Two M5 ID cover grounding screws for the EMI/EMC requirement
Cable ties	Six cable ties for securing field cables to the unit
Control (CTRL) connector	Spare CTRL connector without resistor for CTRL wiring
Control (CTRL) connector with resistor	Spare CTRL connector with resistor for CTRL wiring
Quick Install Guide (QIG)	QIG for IQ Battery unit installation instructions
OPTIONAL ACCESSORIES AND REPLACEMENT PARTS	
IQ8D-BAT-RMA	IQ8D-BAT Microinverter for field replacement
B05-T02-US00-1-3-RMA	IQ Battery 5P Battery unit for field replacement
B05-CX-0550-O	IQ Battery 5P cover for field replacement
B05-PI-0550-O	IQ Battery 5P pedestal mount
B05-CP-096-O	IQ Battery 5P conduit plates for field replacement. Includes one left-side and one right-side conduit plate
B05-WB-0543-O	IQ Battery 5P wall bracket for field replacement. Includes one bottom mounting bracket and one top shield
IQBATTERY-HNDL-5	IQ Battery 5P lifting handles. Includes one left-side and one right-side lifting handle
B05-ACFB-080-O	IQ Battery 5P AC filter board for field replacement
B05-BMSNA-0490-O	IQ Battery 5P BMS board for field replacement
B05-CANB-063-O	IQ Battery 5P control communication board for field replacement
B05-NICS-0524-O, B05-NUCS-0524-O	IQ Battery 5P control switch is preinstalled on the wiring cover for field replacement
OUTPUT [AC]	
	@ 240 VAC ²
Rated (continuous) output power	3.84 kVA
Peak output power	7.68 kVA (3 seconds), 6.14 kVA (10 seconds)
Nominal voltage/range	240/211–264 VAC
Nominal frequency/range	60/57–63 Hz
Rated output current (@240 VAC)	16 A
Peak output current (@240 VAC)	32 A (3 seconds), 25.6 A (10 seconds)
Load start capability	Up to 48 A LRA ³
Power factor (adjustable)	0.85 leading...0.85 lagging
Maximum units per 20 A branch circuit	One unit (single-phase)
Maximum conductor size supported	3 AWG
Overcurrent protection device (OCPD) for 3 AWG cable	80 A
Interconnection	Single-phase
AC round-trip efficiency ⁴	90%

²Supported in both grid-connected and backup/off-grid operation

³ Load start capability may vary

⁴ AC to the battery to AC at 50% power rating

IQ Battery 5P

BATTERY

Total capacity	5.0 kWh
Usable capacity	5.0 kWh
DC round-trip efficiency	96%
Nominal DC voltage	76.8 V
Maximum DC voltage	86.4 V
Ambient operating temperature range (charging)	-20°C to 50°C (-4°F to 122°F) non-condensing
Ambient operating temperature range (discharging)	-20°C to 55°C (-4°F to 131°F) non-condensing
Optimum operating temperature range	0°C to 30°C (32°F to 86°F)
Chemistry	Lithium iron phosphate (LFP)

MECHANICAL DATA

Dimensions (HxWxD)	980 mm x 550 mm x 188 mm (38.6 in x 21.7 in x 7.4 in)
Lifting weight	66.3 kg (146.1 lbs)
Total installed weight	78.9 kg (174 lbs)
Enclosure	Outdoor-NEMA 3R
IQ8D-BAT Microinverter enclosure	NEMA type 6
Cooling	Natural convection
Altitude	Up to 2,500 meters (8,202 feet)
Mounting	Wall-mount or pedestal-mount (sold separately)

FEATURES AND COMPLIANCE

Compatibility	Compatible with IQ and M Series Microinverters, IQ System Controller 3/3G, IQ Combiner 5/5C, and IQ Gateway for grid-tied and backup operation
Communication	Wired control communication
Services	Backup, Self-Consumption, TOU, and NEM integrity
Monitoring	Enphase Installer Platform and Enphase App monitoring options; API integration
Compliance	CA Rule 21 (UL 1741-SA), IEEE 1547:2018 (UL 1741-SB, 3rd Ed.) CAN/CSA C22.2 No. 107.1-16 UL 9540, UL 9540A, UN 38.3, UL 1998, UL 991, NEMA Type 3R, AC156 EMI: 47 CFR, Part 15, Class B, ICES 003 Cell module: UL 1973, UN 38.3 Inverters: UL 62109-1, IEC 62109-2

LIMITED WARRANTY

Limited warranty	>60% capacity, up to 15 years or 6,000 cycles ⁵
------------------	--

⁵ Whichever occurs first. Restrictions apply

Revision history

REVISION	DATE	DESCRIPTION
DSH-00010-2.0	July 2023	<ul style="list-style-type: none">• Added battery isometric view on the first page.• Editorial updates.
DSH-00010-1.0	May 2023	Initial release.



IQ System Controller 3/3G

The Enphase IQ System Controller 3/3G connects the home to grid power, the IQ Battery system, and solar PV. It provides microgrid interconnect device (MID) functionality by automatically detecting and seamlessly transitioning the home energy system from grid power to backup power in the event of a grid failure. It consolidates interconnection equipment into a single enclosure and streamlines grid-independent capabilities of PV and storage installations by providing a consistent, pre-wired solution for residential applications.



IQ Series Microinverters

The high-powered smart grid-ready IQ Series Microinverters (M Series, IQ6, IQ7, and IQ8 Series) dramatically simplify the installation process



IQ Combiner 5/5C

Consolidates PV interconnection equipment into a single enclosure and streamlines IQ Series Microinverters and IQ Gateway installation by providing a consistent, pre-wired solution for residential applications



IQ Battery 5P

Fully integrated AC battery system. Includes six field-replaceable IQ8D-BAT microinverters



IQ Load Controller

Helps prioritize essential appliances during a grid outage to optimize energy consumption and prolong battery life

Easy to Install

- Connects to service entrance¹ or main load center
- Includes neutral-forming transformer
- Mounts on single stud with centered brackets
- Provides conduit entry from bottom, left, or right
- Includes color-coded wires for ease of wiring System Shutdown Switch
- Integrates hold-down functionality to eliminate the need for hold-down kits and special breakers

Flexible

- Can be used for Sunlight Backup, Home Essentials Backup, or Full Energy Independence
- IQ System Controller 3 integrates with IQ Battery 5P
- IQ System Controller 3G integrates with select AC standby generators. See [Generator Integration Tech Brief](#) for a list of generators
- Provides a seamless transition to backup

Safe and Reliable

- System Shutdown Switch can be used to disconnect PV, battery, and generator systems
- It acts as a rapid shutdown initiator of grid-forming IQ8 PV Microinverters for safety of maintenance technicians/first responders
- 10-year limited warranty



10-year limited warranty



IQ System Controller 3/3G

DATASHEET

MODEL NUMBER	DESCRIPTION
SC200D11C240US01	IQ System Controller 3 streamlines grid-independent capabilities of PV and storage installations. Integrates hold-down capability. Supports up to 40 kWh (without PCS*) and 80 kWh (with PCS*) IQ Battery 5P. Does not support generator integration
SC200G11C240US01	IQ System Controller 3G streamlines grid-independent capabilities of PV and storage installations. Integrates hold-down capability. Supports up to 20 kWh (without PCS*) and 40 kWh (with PCS*) IQ Battery 5P. Supports generator integration
WHAT'S IN THE BOX	
IQ System Controller 3/3G	Includes neutral-forming transformer (NFT) and microgrid interconnect device (MID)
System Shutdown Switch	Includes pre-wired red, black, orange and purple 12 AWG wire (EP200G-NA-02-RSD)
Wall-mounting bracket	Screws provided in the accessories kit for mounting
4-pole circuit breaker	Pre installed Quad breaker (BRK-20A40A-4P-240V), 20 A-40 A, 10 kAIC, Eaton BQC220240 ²
Accessories Kit	IQ System Controller 3/3G literature kit, including labels, CTRL headers, screws, filler plates, and QIG (EP200G-LITKIT)
OPTIONAL ACCESSORIES AND REPLACEMENT PARTS	
CT-200-SPLIT	200 A split core current transformers for metering (accuracy: $\pm 2.5\%$) ³
CT-200-CLAMP	200 A clamp-type current transformers for metering (accuracy: $\pm 2.5\%$) ³
Circuit breakers (order separately, as needed) ⁴ : <ul style="list-style-type: none"> BRK-100A-2P-240V : Main breaker, 2-pole, 100A, 25kAIC, CSR2100N or CSR2100 BRK-125A-2P-240V: Main breaker, 2-pole, 125A, 25kAIC, CSR2125N BRK-150A-2P-240V: Main breaker, 2-pole, 150A, 25kAIC, CSR2150N BRK-175A-2P-240V: Main breaker, 2-pole, 175A, 25kAIC, CSR2175N BRK-200A-2P-240V: Main breaker, 2-pole, 200A, 25kAIC, CSR2200N 	Circuit breakers (order separately, as needed) ⁵ : <ul style="list-style-type: none"> BRK-20A-2P-240V-B: Circuit breaker, 2-pole, 20 A, 10 kAIC, BR220B/BR220 BRK-30A-2P-240V-B: Circuit breaker, 2-pole, 30 A, 10 kAIC, BR230 BRK-40A-2P-240V-B: Circuit breaker, 2-pole, 40 A, 10 kAIC, BR240B/BR240 BRK-60A-2P-240V: Circuit breaker, 2-pole, 60 A, 10 kAIC, BR260 BRK-80A-2P-240V: Circuit breaker, 2-pole, 80 A, 10 kAIC, BR280
EP200G-HNDL-R1	IQ System Controller 3/3G installation handle kit (order separately)
CTRL-SC3-NA-01	Control cable, 500 ft. spool (order separately)
ELECTRICAL SPECIFICATIONS	
Nominal voltage/Range (L-L)	240 V \sim $\pm 20\%$
Voltage measurement accuracy	$\pm 1\%$ V nominal (± 1.2 V L-N and ± 2.4 V L-L)
Auxiliary (dry) contact for load control, excess PV control, and generator two-wire control	24 V, 1 A
Nominal frequency/Range	60 Hz/56–63 Hz
Frequency measurement accuracy	± 0.1 Hz
Maximum continuous current rating	160 A
Maximum input overcurrent protection device	200 A
Maximum output overcurrent protection device	200 A
Maximum overcurrent protection device rating for generator circuit	80 A (IQ System Controller 3G only - SC200G11C240US01)
Maximum overcurrent protection device rating for storage circuit	2x 80 A (IQ System Controller 3 - SC200D11C240US01), 1x 80 A (IQ System Controller 3G - SC200G11C240US01)
Maximum overcurrent protection device rating for PV combiner unit	80 A
Internal busbar rating	200 A
Neutral-forming transformer (NFT)	<ul style="list-style-type: none"> Maximum continuous unbalance current: 30 A @ 120 V Peak rated power: 8,800 VA for 30 seconds Peak unbalanced current: 80 A @ 120 V for 2 seconds
<ul style="list-style-type: none"> Breaker rating (pre-installed): 40A between L1 and Neutral; 40A between L2 and Neutral Continuous rated power: 3,600 VA 	

(2) Factory installed quad breaker (Siemens or Eaton). NFT pre-wired to 40 A terminal of the quad breaker.

(3) Two unit of CT-200-SPLIT or CT-200-CLAMP to be bought separately for generator integration

(4) The IQ System Controller 3 is rated at 22 kAIC.

(5) Integrated hold down kit also support breakers (BR220/BR230/BR240) without predrilled hole.

(6) "-" indicates alternating current (AC) supply.

(*) Power Control System

MECHANICAL DATA		
Dimensions (WxHxD)	50 cm x 91.6 cm x 24.6 cm (19.7 in x 36 in x 9.7 in)	
Weight	39.4 kg (87 lbs)	
Ambient temperature range	-40°C to 50°C (-40°F to 122°F)	
Cooling	Natural convection, plus heat shield	
Enclosure environmental rating	Outdoor, NEMA type 3R, polycarbonate construction	
Maximum altitude	2,500 meters (8,200 feet)	
WIRE SIZES		
Connections (All lugs are rated to 90°C)	Main lugs and backup load lugs CSR breaker bottom wiring lugs AC combiner lugs, IQ Battery lugs, and generator lugs Neutral (large lugs)	Cu/Al: 6 AWG–300 kcmil Cu/Al: 2 AWG–300 kcmil 14 AWG–2 AWG Cu/Al: 6 AWG–300 kcmil
Neutral and ground bars	Large holes (5/16–24 UNF) Small holes (10–32 UNF)	14 AWG–1/0 AWG 14 AWG–6 AWG
COMPLIANCE		
Compliance (under progress)	UL 1741, UL 1741 SA, IEEE 1547:2018 (UL 1741-SB, 3rd Ed.), UL 1741 PCS CRD, UL1998, UL 869A, UL 675, UL 508 ⁷ , UL 50E ⁷ CSA 22.2 No. 107.1, 47 CFR Part 15 Class B, ICES 003, ICC ES AC156. The IQ System Controller 3/3G is approved for use as service equipment in the United States	
WARRANTY		
Limited warranty (restrictions apply)	Up to 10 years (EP200G-NA-02-RSD is warranted for 5 years)	
COMPATIBILITY		
IQ Battery 5P	IQBATTERY-5P-1P-NA	
Microinverters	IQ6, IQ7, IQ8, and M ⁸ Series Microinverters ⁹	
IQ Combiner 5/5C	X-IQ-AM1-240-5C, X-IQ-AM1-240-5	
Communications Kit 2	COMMS-KIT-02	

(7) Sections from these standards were used during the safety evaluation and included in the UL 1741 listing.

(8) M Series microinverters can only be supported in states that have not yet adopted IEEE 1547:2018.

(9) Enphase does not support mixing IQ8 Series Microinverters with other Series on the same IQ Gateway.

Figure 1A: Installing DER breakers for IQ8 System without generator

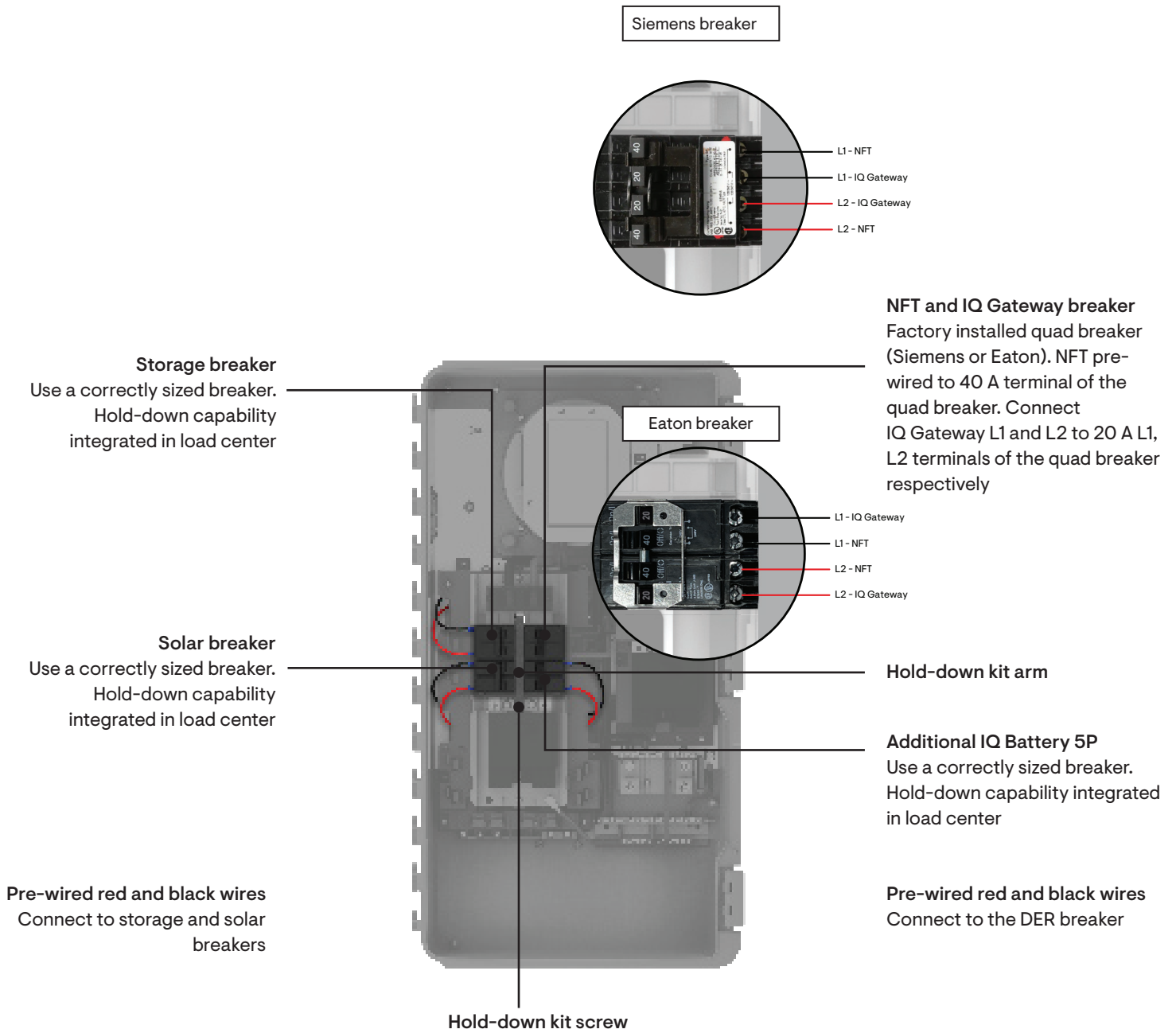

Figure 1B: Installing DER breakers for IQ8 System with generator

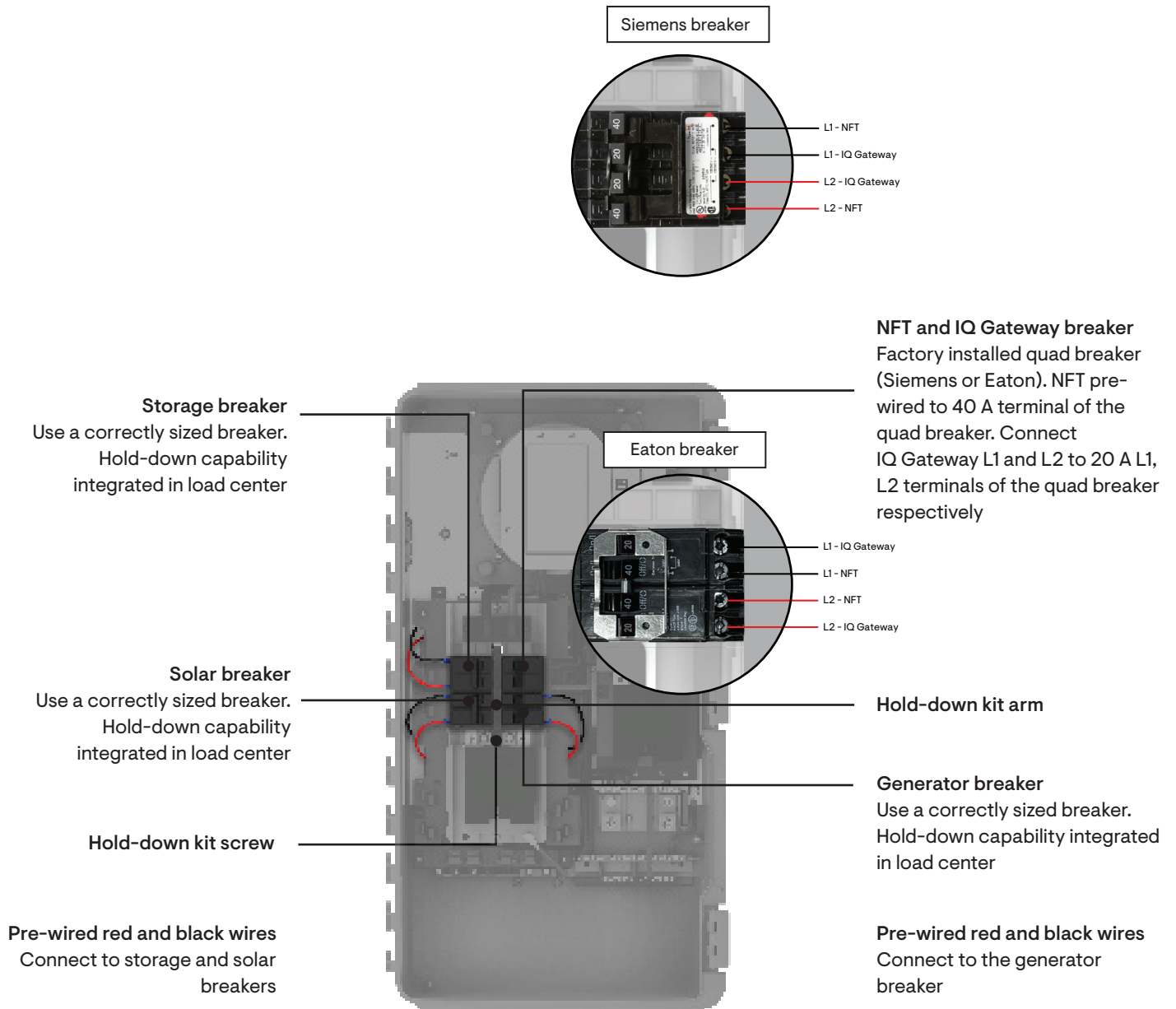
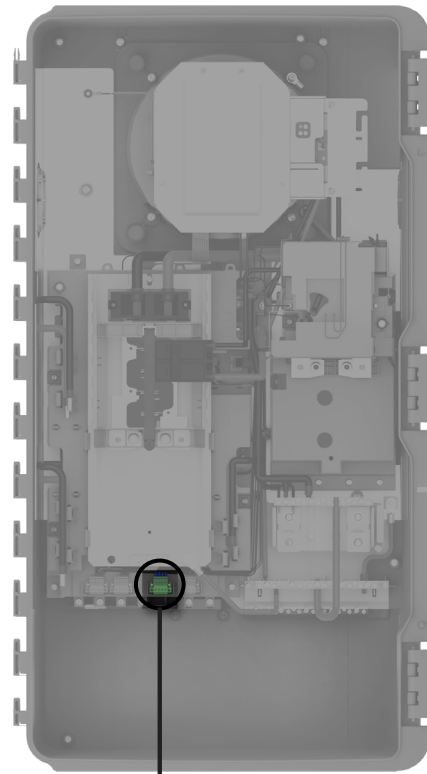
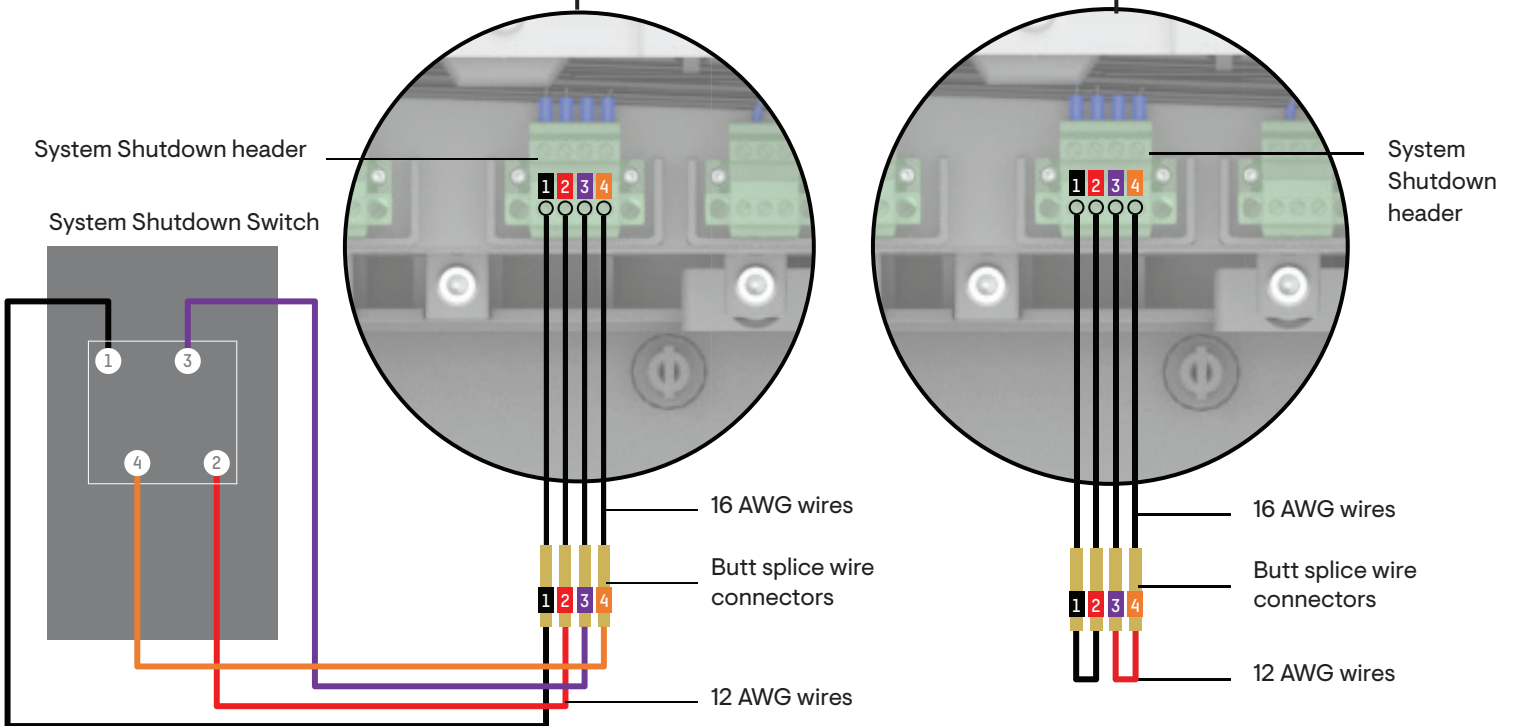

Figure 2: Wiring System Shutdown Switch



Wiring for systems with IQ8 Microinverters

Wiring for systems with non-IQ8 Microinverters



Revision history

REVISION	DATE	DESCRIPTION
DSH-00021-1.0	May 2023	Initial release



Enphase Communications Kit 2

The Communications Kit 2 enables communication between IQ Gateway, IQ Battery 5P, and IQ System Controller 3/3G. The Communications Kit 2 cannot be used with prior versions of the IQ Battery or the IQ System Controller. The Communications Kit 2 can be used to upgrade PV-only sites to grid-tied or grid-forming systems in the absence of an IQ Combiner 5/5C. It is not needed when an IQ Combiner 5/5C is used because the IQ Combiner 5/5C integrates the functionality of the Communications Kit 2.



IQ Series Microinverters
The high-powered smart grid-ready IQ Series Microinverters (IQ6, IQ7, and IQ8 Series) dramatically simplify the installation process.



IQ System Controller 3/3G
Provides microgrid interconnection device (MID) functionality by automatically detecting grid failures and seamlessly transitioning the home energy system from grid power to backup power.

Reliable

- 5-year limited warranty
- Uses wired control communication for fast and consistent communication

Safe

- Minimal voltage and easy to install

Backwards compatible

- Enables IQ Battery 5P and IQ System Controller 3/3G to be installed on sites with:
 - IQ Series Microinverters when using combiners or gateway versions older than IQ Combiner 5/5C*
 - M Series Microinverters when using an Envoy S Metered*

*See compatibility section in the following page



IQ Battery 5P
Powerful, fully-integrated AC battery with 5 kWh capacity. Includes six field-replaceable IQ8D-BAT Microinverters.



IQ Gateway or Envoy S Metered
Delivers solar production and energy consumption data to the Enphase Installer Portal for comprehensive, remote maintenance and management of Enphase systems.



5-year limited warranty

Communications Kit 2

MODEL NUMBER	
COMMS-KIT-02	The Communications Kit 2 enables wired control communication between IQ Gateway (or Envoy S Metered), IQ Battery 5P, and IQ System Controller 3/3G
WHAT'S IN THE BOX	
Control adapter (COMMS-KIT-02)	One control adapter pre-mounted in a NEMA 3R enclosure to enable wired communication for IQ Gateway (or Envoy S Metered)
Enclosure	One NEMA 3R-rated enclosure in which the components are pre-installed and protected
Ground terminal block	One ground terminal block for grounding the control cable shield
DIN rails	Two DIN rails pre-installed in the enclosure. One has the control adapter mounted, while the other can mount an IQ Gateway or an Envoy S Metered if needed
IQ Battery CT	One battery metering clamp CT, shipped with the box, accurate up to 2.5%
USB cable	One USB 2.0 Type-A to USB Type-C cable for connecting the control adapter to an IQ Gateway (or Envoy S Metered)
Power jumper	One power jumper to short the two terminals marked "L2" and "X" in the IQ Gateway power terminal block**
Accessories	One spare control header and zip ties for wire management
POWER REQUIREMENTS	
Supply voltage	5 V (should be powered using a USB Type-A port on the IQ Gateway or Envoy S Metered)
Current	500 mA
BLE transmit power	8 dBm
CONNECTIVITY	
USB	One USB Type-C port for power and communication with IQ Gateway or Envoy S Metered
Control	Two control headers for wiring control cables
Drain	One drain and one PE terminal
MECHANICAL DATA	
Enclosure dimensions (WxHxD)	368 mm x 371 mm x 183 mm (14.48 in x 14.6 in x 7.2 in)
Adapter dimensions (WxHxD)	152 mm x 69 mm x 25 mm (5.98 in x 2.71 in x 0.98 in)
Weight	3.265 kg (7.1 lbs)
Ambient temperature	-40°C to 45°C (-40°F to 113°F)
Altitude	Up to 2,600 meters (8,530 feet)
Humidity	85% RH
NEMA rating	The enclosure is rated for NEMA 3R and can be used for outdoor installation
FEATURES AND COMPLIANCE	
Communication	Wired control communication
Certifications	US/FCC ID: MCO-XBEE3 CAN/IC ID: 1846A-XBEE3
LIMITED WARRANTY	
Limited warranty	5-year limited warranty
COMPATIBILITY	
IQ System Controller	IQ System Controller 3/3G
IQ Battery	IQ Battery 5P
IQ Gateway/IQ Combiner	<ul style="list-style-type: none"> IQ Gateway Envoy S Metered IQ Combiner 3/3C/3-ES/3C-ES/4/4C
Microinverter and Gateway	IQ6, IQ7, and IQ8 Series Microinverters with an IQ Gateway or IQ Combiner 3/3C/3-ES/3C-ES/4/4C M Series Microinverter (M215 and M250) with Envoy S Metered

** For Envoy S Metered, the installer needs to use a wire or a 3-pin Wago nut to short the terminals marked "B" and "C" on the power terminal block.

Refer Communication Kit 2 QIG for details.

Revision history

REVISION	DATE	DESCRIPTION
DSH-00108-1.0	July 2023	Initial release

Rapid shutdown is built-in

The 2014 edition of the National Electrical Code (NEC 2014) added new rapid shutdown requirements for PV systems installed on buildings. Enphase Microinverters fully meet rapid shutdown requirements in the new code without the need to install any additional electrical equipment.

What's new in NEC 2014?

NEC 2014, Section 690.12 applies to PV conductors over 10 feet from the PV array and requires that the conductors power down to 30 volts and 240 volt-amperes within 10 seconds of rapid shutdown initiation.

String inverters require work arounds for rapid shutdown

Work around.

Specialized Rapid Shutdown electrical box installed on the roof within 10 feet of array.

Work around.

Shutoff switch that is easily accessible to first responders on the ground.

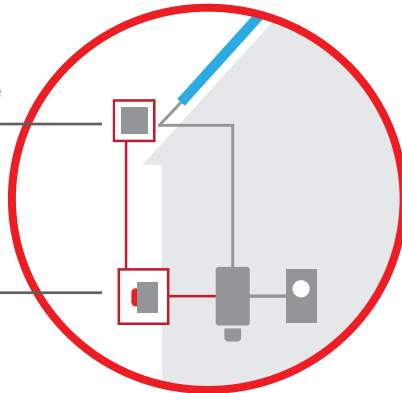

Residential String Inverter

Work around.

Extra conduit in installation.

Work around.

String inverter installed on roof, a hostile environment that string inverters are not built to live in.

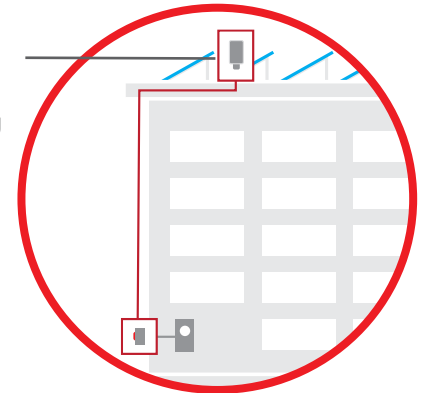

Commercial String Inverter

Enphase comes standard with rapid shutdown capability

All Enphase microinverters, even those that were previously installed, inherently meet rapid shutdown requirements, no additional equipment or workarounds needed

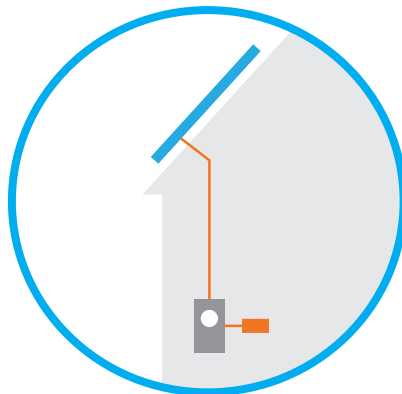

Residential Microinverter

Enphase microinverters can safely shut down automatically, leaving only low-voltage DC electricity isolated to the PV module

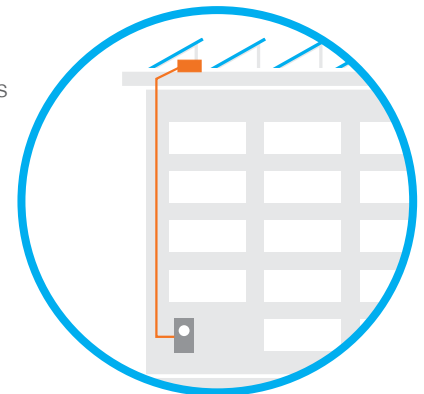

Commercial Microinverter

Enphase P/N: EP200G-NA-02-RSD

IMO P/N: SI16-PEL64R-2-ENP



Key Features

- Enclosed Solar Isolator
- 600VDC, 16A
- IP66 / NEMA 4X Protection Rating
- 2 Pole, 1 String
- Grey/Black Enclosure Cover & Handle



Technical Data for DC

Main Contacts	DC	Units	SI16 DC-PV1 (acc. to IEC 60947-3)	SI16 (acc. to UL508i)
Rated Thermal Current I_{the}		A	16	
Rated Insulation Voltage $UI^{(1)}$		V	1000	
Rated Insulation Voltage $UI^{(2)}$		V	1500	
Distance of Contacts (per pole)		mm	8	
Rated Operational Current I_s	300V	A	16	16
	350V	A	16	16
	400V	A	16	16
	500V	A	16	16
	600V	A	16	16
Rated Conditional Short Circuit Current		kA_{eff}	5	
Max. Fuse Size	gL (gG)	A	40	
Mechanical Life		Ops	10,000	
Rated Short-time Withstand Current (1s) I_{cw}		A	800	
Short Circuit Making Capacity I_{cw}		A	800	
Size of Terminal Screw			M4 Pz2	
Cable Cross Sections (solid or stranded)		mm / AWG	4 - 16 / 12-10	
Tightening Torque		Nm / lb.in	1.7 - 1.8 / 9 - 16	
Maximum Operation Ambient Temperature		°C	-40 to +45	
Maximum Storage Ambient Temperature		°C	-50 to +90	
Power Loss at I_{onmax}		(A) / W	(16) / 1	

Contact Resistance per pole 1.75mΩ

1) Suitable at overvoltage category I to III, pollution degree 3 (standard-industry): $U_{imp} = 8kV$.

2) Suitable at overvoltage category I to III, pollution degree 2 (min. IP55): $U_{imp} = 8kV$.

Dimensions (mm)

